

**DENSO**

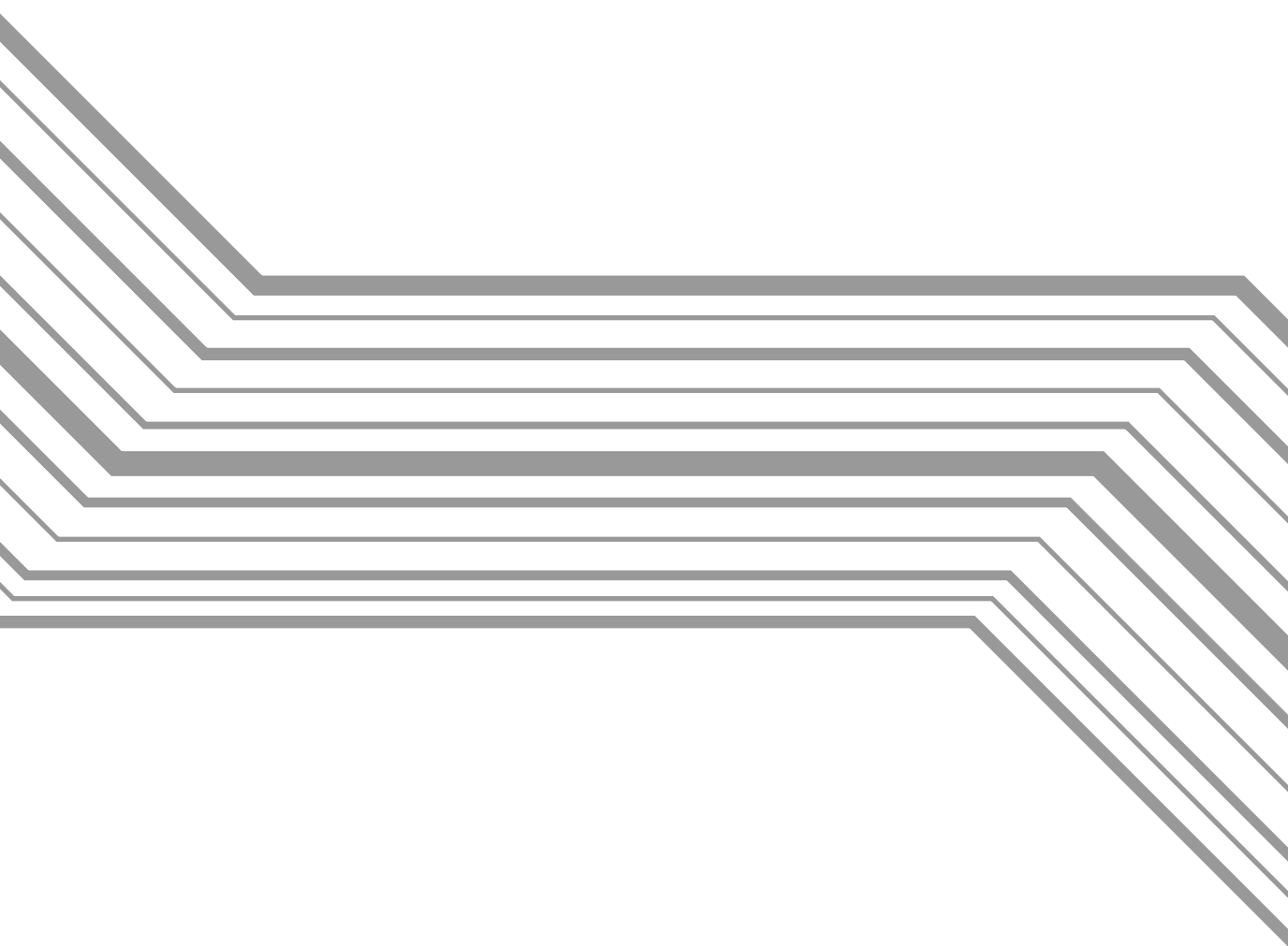

Bar Code Handy Terminal

**BHT-7500 / 7500S / 7500W**

**User's Manual**

Copyright © DENSO WAVE INCORPORATED, 2002

All rights reserved. No part of this publication may be reproduced in any form or by any means without permission in writing from the publisher.

Specifications are subject to change without prior notice.

All products and company names mentioned in this manual are trademarks or registered trademarks of their respective holders.

# Preface

Please READ through these operating instructions carefully. It will enable you to operate your BHT-7500/7500S/7500W correctly.

After you have finished reading the instructions, keep this manual handy for speedy reference.

# How this book is organized

This manual is made up of five chapters and appendices.

## **Chapter 1. Quick Guide**

Describes the basic operating method of the BHT and the related notes.

## **Chapter 2. Getting Started the BHT and System Mode**

Summarizes the BHT system configuration and describes the operation including preparation and System Mode (which is required for the efficient use of application programs).

## **Chapter 3. Communications Operations of BHT**

Describes the communications operations of the BHT—the spread-spectrum communication (for BHT-7500S/7500W only), IR communication, RS-232C interface specifications, basic communications specifications, and the communications protocols—for data transfer with the host computer or other devices.

## **Chapter 4. Error Messages**

Lists the error messages which will appear on the LCD if some error occurs in the BHT.

## **Chapter 5. Handling the CU-7000 (Option)**

Describes the handling procedure of the CU-7000, the interfacing with the host computer, and the charging of the rechargeable battery cartridge.

## **Appendix A: Specifications**

## **Appendix B: Communications Protocol Details**

## **Appendix C: A Typical Basic Operation**

## ■ Technical Terms Used in This Manual

### **Source Program and Object Program (User Program)**

Generally, a source program is translated into an object program by a compiler. This manual calls an object program a user program.

### **BHT-BASIC**

This manual expresses BHT-BASIC3.0 and BHT-BASIC3.5 as BHT-BASIC.

### **BHT/BHT-7500/BHT-7500S/BHT-7500W**

This manual expresses the BHT-7500/BHT-7500S/BHT-7500W as "BHT." If it is necessary to make a clear distinction between the BHT models, this manual uses the "BHT-7500S/7500W only" or "BHT-7500S only."

## ■ Related Publications

BHT-BASIC Programmer's Manual

Transfer Utility Guide

Ir-Transfer Utility C Guide

Ir-Transfer Utility E Guide

## ■ Screen Indication

The lettering in the screens in this manual is a little different from that in the actual screens. File names used are only for description purpose, so they will not appear if you have not set files having those names.

# SAFETY PRECAUTIONS

**Be sure to observe all these safety precautions.**

- Please READ through this manual carefully. It will enable you to use the BHT and CU correctly.
- Always keep this manual nearby for speedy reference.

Strict observance of these warning and caution indications are a MUST for preventing accidents which could result in bodily injury and substantial property damage. Make sure you fully understand all definitions of these terms and related symbols given below, before you proceed to the text itself.



## WARNING

Alerts you to those conditions which could cause serious bodily injury or death if the instructions are not followed correctly.



## CAUTION

Alerts you to those conditions which could cause minor bodily injury or substantial property damage if the instructions are not followed correctly.

## Meaning of Symbols



A triangle (  $\triangle$  ) with a picture inside alerts you to a warning of danger. Here you see the warning for electrical shock.



A diagonal line through a circle (  $\otimes$  ) alerts you to something you should not do; it may or may not have a picture inside. Here you see a screwdriver inside the circle, meaning that you should not disassemble.



A black circle (  $\bullet$  ) with a picture inside alerts you to something you MUST do. This example shows that you MUST unplug the power cord.

## WARNING

### Handling the battery cartridge

- Never disassemble or heat the battery cartridge, nor put it into fire or water; doing so could cause battery-rupture or leakage of battery fluid, resulting in a fire or bodily injury.



- Do not carry or store the battery cartridge together with metallic ball-point pens, necklaces, coins, hairpins, etc.

Doing so could short-circuit the terminal pins, causing the batteries to rupture or the battery fluid to leak, resulting in a fire or bodily injury.

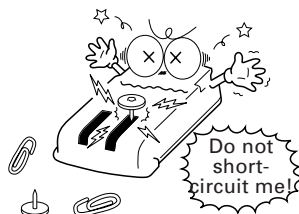

- Avoid dropping the battery cartridge or letting it undergo any shock or impact.

Doing so could cause the batteries to break, generate heat, rupture or burn.



- Only use the dedicated charger (CU-7001, C-700 or C-750) for charging the rechargeable battery cartridge.

Using a different type of charger could cause battery-rupture or leakage of battery fluid and result in a fire, bodily injury, or serious damage to property.

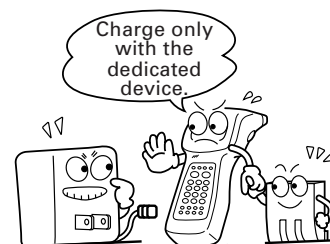

Undedicated

- Never charge the rechargeable battery cartridge where any inflammable gases may be emitted; doing so could cause fire.



### Handling the BHT

- The BHT uses a laser light for scanning bar codes. The intensity of the laser light might be too low to inflict bodily injury. However, do not look into the laser beam.

The BHT complies with Laser Safety Standard, Class II of 21 CFR Chapter 1, Subchapter J.

The BHT does not mount beam attenuator and laser radiation emission indicator required by this standard. Instead, the software-controlled Magic keys (see Section 2.2 "Components and Functions") function as them because the laser light is not enabled without the Magic keys pressed.

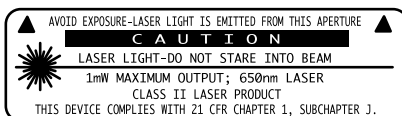

## **WARNING**

- Do not look into the laser beam source through the reading window or point the reading window towards the eyes.



The laser beam emitted through the reading window is harmful to the eyes.

- Use of controls or adjustments or performance of procedures other than those specified herein may result in hazardous radiation exposure.

### **Handling the CU**

- If smoke, abnormal odors or noises come from the CU, immediately unplug the AC adapter from the wall socket and contact your nearest dealer.



Failure to do so could cause fire or electrical shock.



- If foreign material or water gets into the CU, immediately unplug the AC adapter from the wall socket and contact your nearest dealer.



Failure to do so could cause fire or electrical shock.



- If you drop the CU so as to damage its housing, immediately unplug the AC adapter from the wall socket and contact your nearest dealer.



Failure to do so could cause fire or electrical shock.



- Never use the CU for charging anything other than the specified rechargeable battery cartridges.



Doing so could cause heat, battery-rupture, or fire.

- Never bring any metals into contact with the output terminals.



Doing so could produce a large current through the CU, resulting in heat or fire, as well as damage to the CU.

- Use the dedicated AC adapter only. Failure to do so could result in fire.



- Never use the CU on the line voltage other than the specified level. Doing so could cause the CU to break or burn.



- If the power cord of the AC adapter is damaged (e.g., exposed or broken lead wires), stop using it and contact your nearest dealer.



Failure to do so could result in a fire or electrical shock.



## CAUTION

### Basic handling tips

- Never put the BHT in places where there are excessively high temperatures, such as inside closed-up automobiles, or in places exposed to direct sunlight.

Doing so could affect the housing or parts, resulting in a fire.

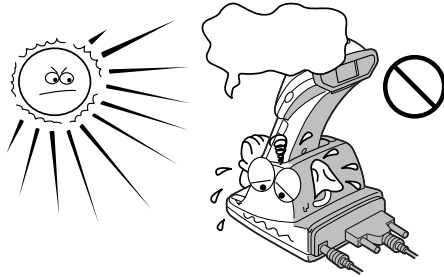

- Avoid using the BHT in extremely humid or dusty areas, or where there are drastic temperature changes.

Moisture or dust will get into the BHT, resulting in malfunction, fire or electrical shock.

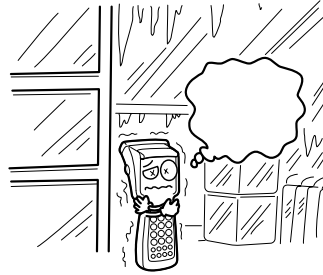
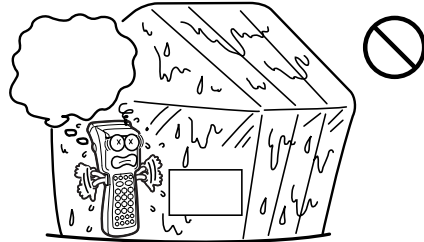

- Never disassemble or modify the BHT; doing so could result in an accident such as break or fire.



### Handling the rechargeable battery cartridge

- Never charge a wet or damp rechargeable battery cartridge.

Doing so could cause the batteries to break, generate heat, rupture, or burn.

### Handling the BHT

- If smoke, abnormal odors or noises come from the BHT, immediately turn off the power, pull out the battery cartridge, and contact your nearest dealer.

Failure to do so could cause smoke or fire.



- If foreign material or water gets into the BHT, immediately turn off the power, pull out the battery cartridge, and contact your nearest dealer.

Failure to do so could cause smoke or fire.



## CAUTION

- If you drop the BHT so as to damage its housing, immediately turn off the power, pull out the rechargeable battery cartridge or dry battery cartridge, and contact your nearest dealer.

Failure to do so could cause smoke or fire.



- For those machines using the dry battery cartridge, do not mistake the plus and minus marks when loading dry cells into the cartridge.

Failure to do so could cause battery-rupture or leakage of battery fluid, resulting in bodily injury, fire, or property damage.



- For those machines using the dry battery cartridge, do not use anything other than the specified type of batteries, nor use new and old batteries together.

Doing so could cause battery-rupture or leakage of battery fluid, resulting in bodily injury, fire, or property damage.



- Do not use batteries or power sources other than the specified ones; doing so could generate heat or cause malfunction.



- In environments where static electricity can build into significant charges (e.g., if you wipe off the resin plate with a dry cloth), do not operate the BHT. Doing so will result in malfunction or machine failure.



### Handling the CU

- If you will not be using the CU for a long time, be sure to unplug the AC adapter from the wall socket for safety.

Failure to do so could result in a fire.







- When caring for the CU, unplug the AC adapter from the wall socket for safety.

Failure to do so could result in an electrical shock.



 **CAUTION**

- Never cover or wrap up the CU or AC adapter in a cloth or blanket.  
Doing so could cause the unit to heat up inside, deforming its housing, resulting in a fire.  
Always use the CU and AC adapter in a well-ventilated area. 
- Do not place the CU anywhere where it may be subjected to oily smoke or steam, e.g., near a cooking range or humidifier.  
Doing so could result in a fire or electrical shock. 
- Keep the power cord away from any heating equipment.  
Failure to do so could melt the sheathing, resulting in a fire or electrical shock. 
- Do not insert or drop foreign materials such as metals or anything inflammable through the openings or vents into the CU.  
Doing so could result in a fire or electrical shock. 

■ DENSO WAVE INCORPORATED does not assume any product liability arising out of, or in connection with, the application or use of any product, circuit, or application described herein.

■ Intellectual Property Precaution

DENSO WAVE INCORPORATED ("DENSO WAVE") takes reasonable precautions to ensure its products do not infringe upon any patent or other intellectual property rights of other(s), but DENSO WAVE cannot be responsible for any patent or other intellectual property right infringement(s) or violation(s) which arise from (i) the use of DENSO WAVE's product(s) in connection or in combination with other component(s), product(s), data processing system(s) or equipment or software not supplied from DENSO WAVE; (ii) the use of DENSO WAVE's products in a manner for which the same were not intended nor designed; or (iii) any modification of DENSO WAVE's products by other(s) than DENSO WAVE.

## ■ Proper Care of the BHT and CU

Clean the housings, battery cartridge terminals, and CU-7001 charge terminals with a dry, soft cloth. Before cleaning, be sure to turn the BHT power off and unplug the AC adapter of the CU.

- Never use benzene, alcohol, or other organic solvents. The housing may be marred or the paint may come off.
- Never rub or strike the liquid crystal display (LCD) with anything hard. The LCD surface will be easily scratched or broken.
- When cleaning the keypad, do not scrub the surface too hard, and do not pull on the keys. Doing so may break the keys or cause the keypad to dislocate.
- If the BHT or CU becomes smudged, moisten a soft cloth with neutral detergent and wring it out thoroughly. Wipe the BHT or CU with the cloth and then go over it again with a dry cloth.



Dust or dirt accumulating on the clear plate of the bar-code reading window will affect reading performance. If you use the BHT in dusty areas, therefore, periodically check the clear plate of the bar-code reading window and clean it if dusty.

- To clean the plate, first blow the dust away with an air brush. Then wipe the plate with a cotton swab or the similar soft one gently.
- If sand or hard particles have accumulated, never rub the plate; doing so will scratch or damage it. Blow the particles away with an air brush or a soft brush.

# BHT-7500

## FCC Regulations

This Device complies with Part 15 of the FCC Rules and RSS-210 Rules.

Operation is subject to the following two conditions:

- (1) this device may not cause harmful interference, and
- (2) this device must accept any interference received, including interference that may cause undesired operation.

**NOTE:** This equipment has been tested and found to comply with the limits for a Class A digital device, pursuant to Part 15 of the FCC Rules. These limits are designed to provide reasonable protection against harmful interference when the equipment is operated in a commercial environment. This equipment generates, uses, and can radiate radio frequency energy and, if not installed and used in accordance with the instruction manual, may cause harmful interference to radio communications. Operation of this equipment in a residential area is likely to cause harmful interference in which case the user will be required to correct the interference at his own expense.

**FCC WARNING:** Changes or modifications not expressly approved by the party responsible for compliance could void the user's authority to operate the equipment.

## Labeling

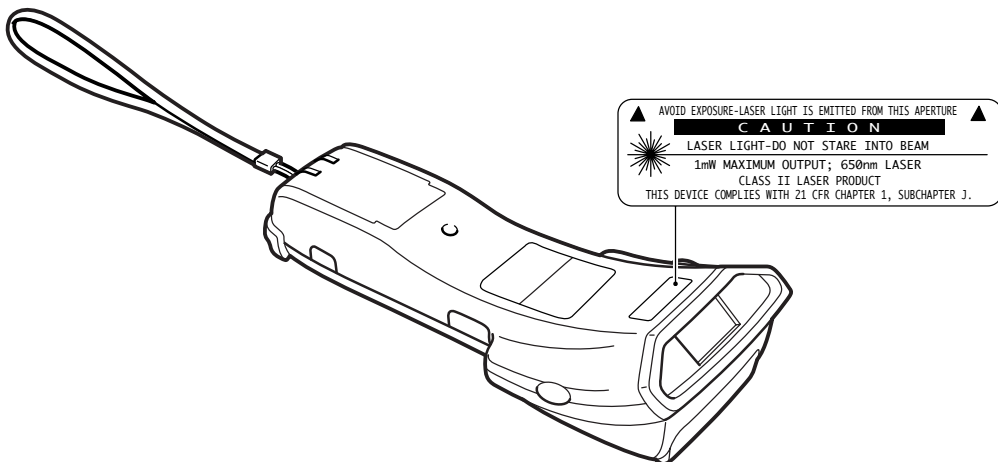

# BHT-7500S

## US and Canada Regulations

This device complies with Part 15 of the FCC Rules, Canadian ICES-003 and RSS-210 Rules.

Operation is subject to the following two conditions:

- (1) this device may not cause harmful interference, and
- (2) this device must accept any interference received, including interference that may cause undesired operation.

**NOTE:** This equipment has been tested and found to comply with the limits for a Class A digital device, pursuant to Part 15 of the FCC Rules. These limits are designed to provide reasonable protection against harmful interference when the equipment is operated in a commercial environment. This equipment generates, uses, and can radiate radio frequency energy and, if not installed and used in accordance with the instruction manual, may cause harmful interference to radio communications. Operation of this equipment in a residential area is likely to cause harmful interference in which case the user will be required to correct the interference at his own expense.

**NOTE:** This Class A digital apparatus complies with Canadian ICES-003.

Cet appareil numérique de la classe A est conforme à la norme NMB-003 du Canada.

**FCC WARNING:** Changes or modifications not expressly approved by the party responsible for compliance could void the user's authority to operate the equipment.

**CAUTION:** Radio Frequency Radiation Exposure

This device is approved for hand held use only and, to comply with applicable FCC radio frequency exposure regulations, must be used with a distance of at least 20 cm (7.9 inches) between the antenna and the body of any person at all times during use.

This transmitter and its antenna should not be placed next to other antennas or similar radiating structures.

**CAUTION:** To prevent radio interference to the licensed service, this device is intended to be operated indoors and away from windows to provide maximum shielding. Equipment (or its transmit antenna) that is installed outdoors is subject to licensing.

# BHT-7500S

## Labeling

For USA and Canada

FCC ID: PZWBHT-7500S  
THIS DEVICE COMPLIES WITH PART 15 OF THE FCC RULES. OPERATION IS SUBJECT TO THE FOLLOWING TWO CONDITIONS: (1) THIS DEVICE MAY NOT CAUSE HARMFUL INTERFERENCE, AND (2) THIS DEVICE MUST ACCEPT ANY INTERFERENCE RECEIVED, INCLUDING INTERFERENCE THAT MAY CAUSE UNDESIRABLE OPERATION. THIS DEVICE COMPLIES WITH RSS-210.  
CANADA: 15511032292A

For European Union



For Australia

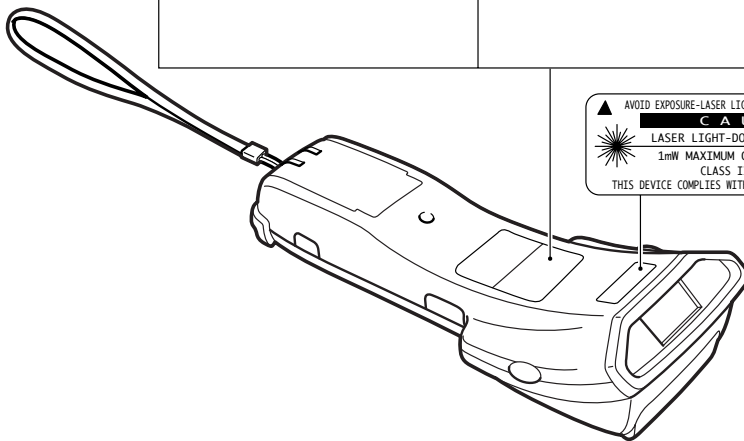

▲ AVOID EXPOSURE-LASER LIGHT IS EMITTED FROM THIS APERTURE ▲  
**CAUTION**  
LASER LIGHT-DO NOT STARE INTO BEAM  
1mW MAXIMUM OUTPUT; 650nm LASER  
CLASS II LASER PRODUCT  
THIS DEVICE COMPLIES WITH 21 CFR CHAPTER 1, SUBCHAPTER J.

On the BHT is a radio frequency radiation related label suited to the destination.

# BHT-7500W

## Declaration of Conformity (For European Union)

The radio frequency module that complies with the Directive 99/5/EC(R&TTE) is mounted on this device (BHT-7500W).

### DECLARATION OF CONFORMITY Directive 99/5/EC (R&TTE)

Manufacturer or

Authorized representative : **DENSO WAVE INCORPORATED**

Address : **1-1 Showa-cho, Kariya-shi, Aichi-ken, 448-8661, Japan**

We declare on our sole responsibility, that the following product :

- Kind of equipment : **Radio frequency module**
- Type-designation : **MI802B3**

is compliance with the essential requirement of §3 of the R&TTE.

- Health and safety requirements pursuant to §3(1)a :  
Applied Standard(s) or other means of providing conformity :  
**EN60950 : 2000**
- Protection requirements concerning EMC §3(1)b :  
Applied Standard(s) or other means of providing conformity :  
**EN301 489-17 : 2000**
- Measures for the effective use of the Radio frequency spectrum §3(2) :  
Applied Standard(s) or other means of providing conformity :  
**ETS300 328/A2 : 2001**

CE marking





# BHT-7500W

## Labeling

For European Union

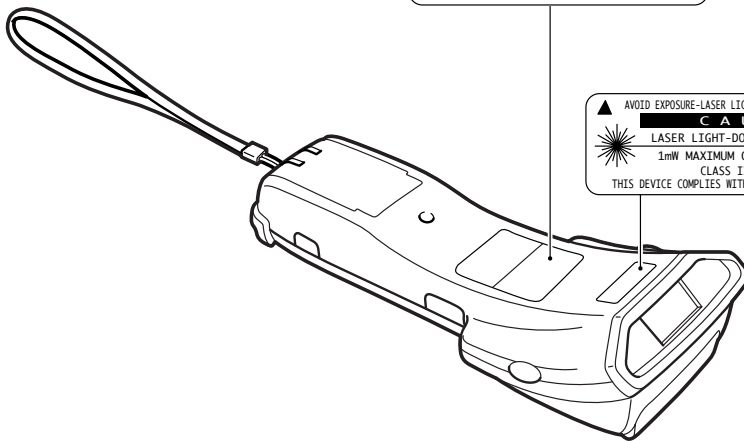

▲ AVOID EXPOSURE-LASER LIGHT IS EMITTED FROM THIS APERTURE ▲  
**CAUTION**  
LASER LIGHT-DO NOT STARE INTO BEAM  
1mW MAXIMUM OUTPUT; 650nm LASER  
CLASS II LASER PRODUCT  
THIS DEVICE COMPLIES WITH 21 CFR CHAPTER 1, SUBCHAPTER J.

On the BHT is a radio frequency radiation related label suited to the destination.

# Content Overviews

<b>Preface</b> .....	<b>i</b>
<b>How this book is organized</b> .....	<b>ii</b>
<b>SAFETY PRECAUTIONS</b> .....	<b>iv</b>
<b>Chapter 1 Quick Guide</b> .....	<b>1</b>
1.1 Reading Bar Codes .....	2
1.2 Setting and Using the Hand Strap .....	4
1.3 Setting the Backlight .....	5
1.4 Using the Keypad .....	6
1.5 Transferring Data .....	7
<b>Chapter 2 Getting Started the BHT and System Mode</b> .....	<b>9</b>
2.1 BHT System Configuration .....	10
2.2 Components and Functions .....	15
2.3 Preparation .....	17
2.3.1 Setting-up 1: Loading the Battery Cartridge .....	17
2.3.2 Setting-up 2: Setting the Calendar Clock .....	21
2.3.3 Adjusting the LCD Contrast & Beeper Volume and Switching the Beeper & Vibrator .....	24
2.3.4 Battery Voltage Display .....	26
2.3.5 Synchronization Display in Radio Communication (BHT-7500S/7500W only) .....	26
2.3.6 Battery Replacement Notes .....	27
2.3.7 BHT Turning-off Notes .....	29
2.4 Initializing the BHT System .....	33
2.5 Operating in System Mode .....	37
2.5.1 Starting System Mode .....	37
2.5.2 Operating in System Mode .....	42
2.5.3 Detailed Description of the Functions in System Mode .....	44
<b>Chapter 3 Communications Operations of the BHT</b> .....	<b>123</b>
3.1 Spread-Spectrum Communication (BHT-7500S/7500W only) .....	124
3.1.1 Notes for Wireless Operations .....	124
3.1.2 RF-Related Parameters .....	124
3.2 Infrared Communication .....	126

3.3	RS-232C Interface Specifications .....	127
3.4	Basic Communications Specifications and Parameters .....	129
3.4.1	Basic Communications Specifications .....	129
3.4.2	Communications Parameters .....	131
3.5	Communications Protocols .....	132
3.5.1	BHT-protocol .....	132
3.5.2	BHT-Ir Protocol .....	138
<b>Chapter 4</b>	<b>Error Messages .....</b>	<b>145</b>
4.1	System Errors .....	146
4.2	Errors in System Mode .....	151
<b>Chapter 5</b>	<b>Handling the CU-7000 (Option) .....</b>	<b>157</b>
5.1	Functions of the CU-7000 .....	158
5.2	Components and Functions .....	158
5.3	Applying Power to the CU-7000 .....	159
5.4	Communicating with the Host Computer .....	160
5.4.1	Setting the Transmission Speed of the CU-7000 .....	160
5.4.2	Interface Cable Connection .....	160
5.4.3	Interfacing with the Host Computer .....	161
5.5	Charging the Rechargeable Battery Cartridge (using the CU-7001) .....	162
5.6	RS-232C Interface Specifications .....	164
<b>Appendices</b>	<b>.....</b>	<b>167</b>
Appendix A.	Specifications .....	168
A.1	BHT-7500/7500S/7500W .....	168
A.2	CU-7000 .....	173
Appendix B.	Communications Protocol Details .....	175
B.1	BHT-protocol .....	175
B.2	BHT-Ir protocol .....	185
Appendix C.	A Typical Basic Operation .....	196
<b>Index</b>	<b>.....</b>	<b>197</b>

**Chapter 1. Quick Guide**



**Chapter 2. Getting Started the BHT  
and System Mode**



**Chapter 3. Communications Operations  
of the BHT**



**Chapter 4. Error Messages**



**Chapter 5. Handling the CU-7000 (Option)**



**Appendices**



# Chapter 1

## Quick Guide

This chapter describes the basic operating method of the BHT and the related notes.

1.1	Reading Bar Codes .....	2
1.2	Setting and Using the Hand Strap .....	4
1.3	Setting the Backlight .....	5
1.4	Using the Keypad .....	6
1.5	Transferring Data .....	7

# 1.1 Reading Bar Codes

Turn on the BHT power, bring the bar-code reading window to the bar code to be scanned, and press the trigger switch. The BHT emits a laser light to scan the bar code.

When the BHT has read the bar code successfully, the indicator LED will illuminate in green.

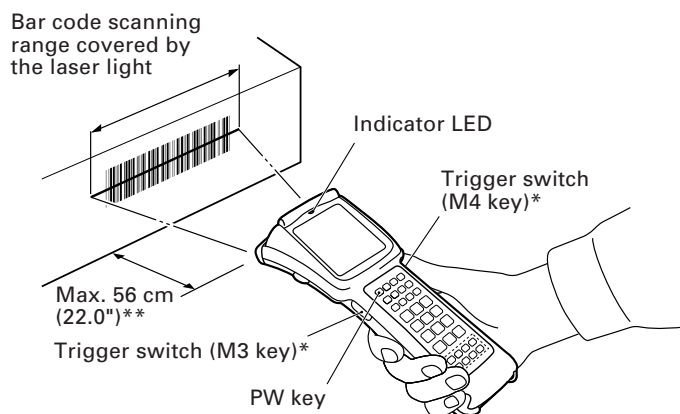

\* The trigger switch function is assigned to both of the M3 and M4 keys by default.

- If the BHT fails to read due to specular effects or other factors, change the scanning angle of the reading window or the distance from codes as shown at right, and try it again. (Specular effects occur when the reflection of the light from the bar code becomes excessively strong. This can easily happen when the reflecting surface is polished or covered with vinyl.)

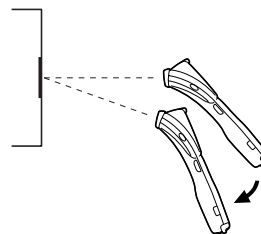

- Keep the BHT at a distance from a target bar code so that the bar code comes within approx. 90% of the laser scanning range (line length).
- The BHT can read bar codes at a maximum distance of 56 cm (22.0")\*\* from the bar-code reading window.

\*\*Under the following conditions:

- Ambient illuminance: 500 lx (Xenon lamp)
- Code 39
- Reflection intensity: 85% min. for white and 5% max. for black
- Minimum narrow bar width: 1.4 mm min. (55.1 mils min.)

- The bar code reading procedure may differ depending upon the application used, so follow the application's manual.

**NOTE**

- Before reading bar codes, clean those labels if stained.
- Avoid using the BHT in direct sunlight. The BHT might fail to read correctly.
- To read bar codes on curved surfaces, apply the BHT to the target bar code so that the code comes to the center of the scanning range indicated by the laser beam.
- When you pull the bar-code reading window away from bar codes, the actual scanning range will become narrower than the range covered by the laser beam.
- Do not use the BHT in the vicinity of personal or amateur radio equipment. The BHT may malfunction.
- Do not use the BHT near a magnetic body (e.g., equipment that generates a magnetic field). Doing so will deflect the optical axis of the laser light, resulting in scanning failure or machine failure.
- If the BHT has been stored in a hot (50°C to 60°C, 122°F to 140°F) and humid place, allow it to sit at room temperature and humidity for at least one day before use. Using the BHT with its inside being hot will fail to scan or result in a machine failure.

## 1.2 Setting and Using the Hand Strap

### ■ Setting the hand strap

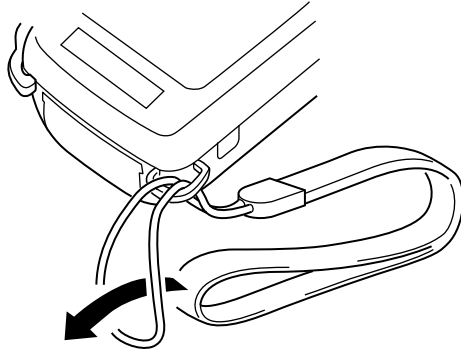

### ■ Using the hand strap

Put your hand through the hand strap and hold the BHT as shown below. This will prevent you from dropping the BHT accidentally.

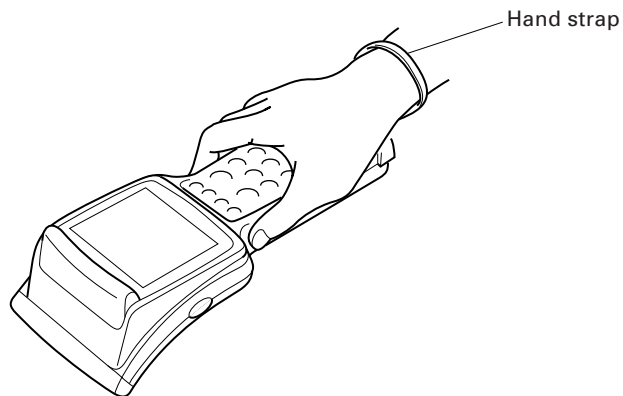



## 1.3 Setting the Backlight

Pressing the **[M1]** key while holding down **[SF]** (Shift) key activates or deactivates the backlight function.

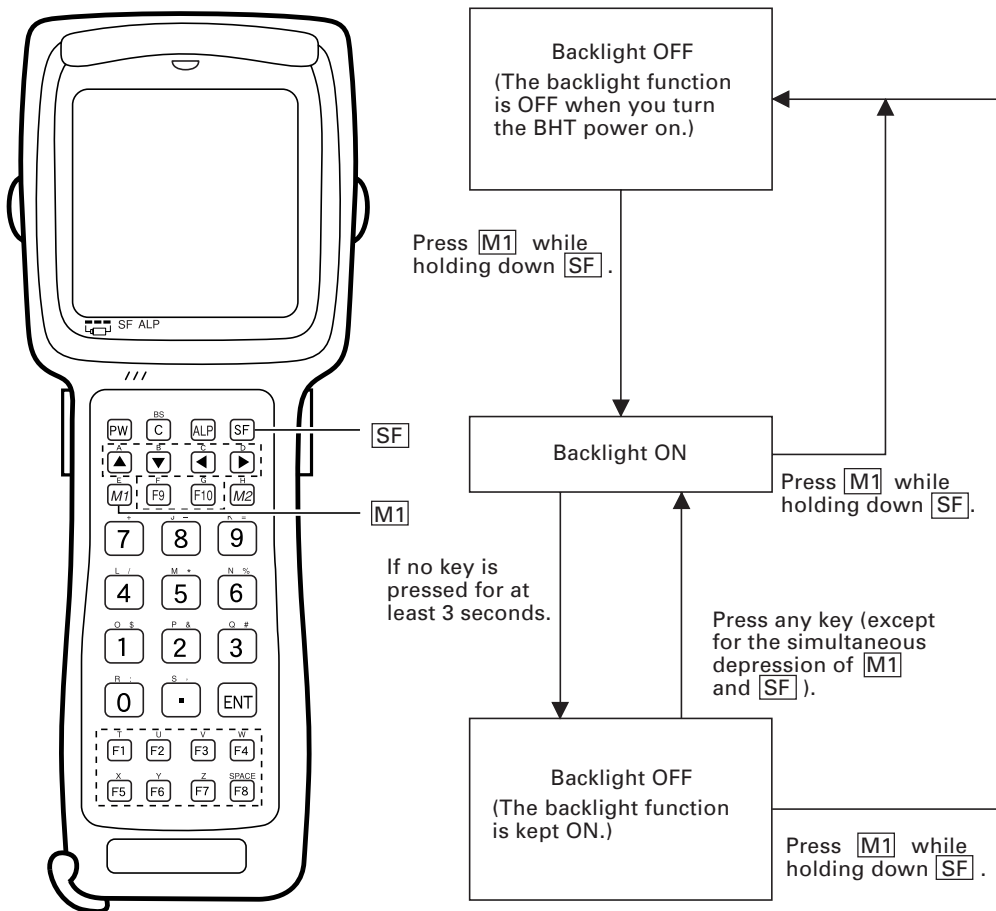

### NOTE

In user programs, you can select the key to be used for activating or deactivating the backlight function (instead of the initial setting: combination of **[SF]** and **[M1]**), as well as modifying the ON-duration of the backlight before the automatic turning-off.

# 1.4 Using the Keypad

## ■ Entering Numerical Data

To enter numerical data, e.g., the quantity of goods, use the ten numerical keys and the **ENT** key.

For example, to enter the number "120," press the **1**, **2** and **0** keys and then press the **ENT** key.

If you key in any wrong value, press the **C** key or **BS** key (**SF** + **C** keys) and then enter the correct one.

## ■ Selecting Tasks

If the LCD shows the selection items (xxx) prefixed by numerals (e.g., 1: xxx, 2: xxx), use the numerical keys to select a desired item and press the **ENT** key to execute.

If a YES/NO screen (e.g., 1: YES, 2: NO) appears, press the **1** key for YES response and **2** key for NO response.

## ■ Entering Alphabetic Characters

The BHT supports the alphabet entry function which allows you to enter alphabetic characters, space, and symbols from the keypad during execution of a user program. For the alphabet entry procedure, refer to the "BHT-BASIC Programmer's Manual."

## 1.5 Transferring Data

### ■ Using radio link (BHT-7500S/7500W only)

Using radio waves, the BHT-7500S/7500W may transfer data to an access point in a spread-spectrum communications system.

#### **NOTE**

If there are too many communications errors, first make sure that the BHT points directly at an access point because the 2.4-GHz band requires a more or less straight line path.

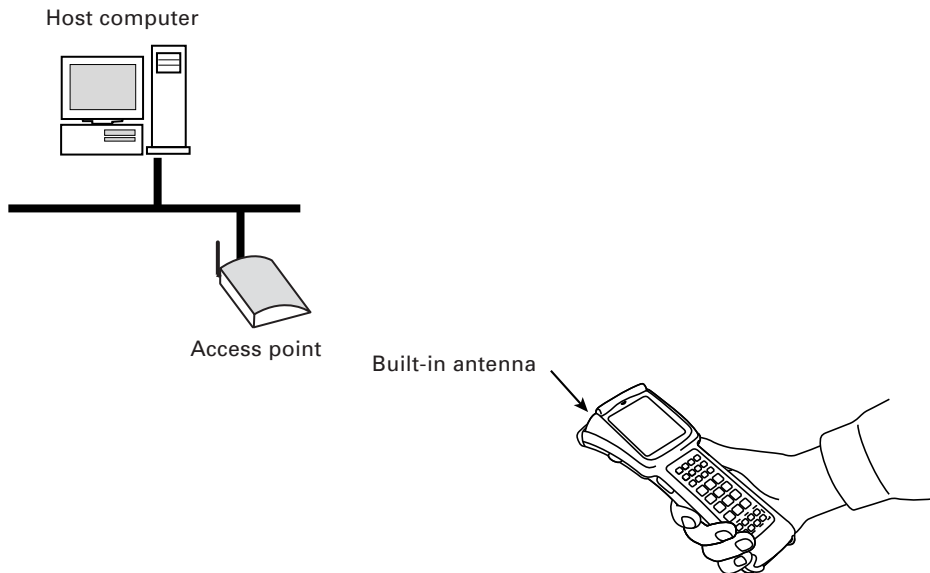

For data transfer using radio link, it is necessary to configure a wireless local area network (wireless LAN) connecting the BHT-7500S/7500W and access points.

## ■ Using infrared link

Using infrared rays, the BHT may transfer data directly to the host computer equipped with an IrDA interface port and other IrDA-compliant devices.

### **NOTE**

- Make sure that there is no obstruction in the light path between the BHT and any target stations. In infrared communication, you need to keep the BHT and any target stations within the effective infrared radiation range, usually 10 to 80 cm (3.94 to 31.50").
- Shield the IrDA interface from direct sunlight, intense overhead lighting (inverter-driven fluorescent lighting, in particular), and other potential sources of infrared radiation. Sources to watch out for include remote control units for television sets and the like.

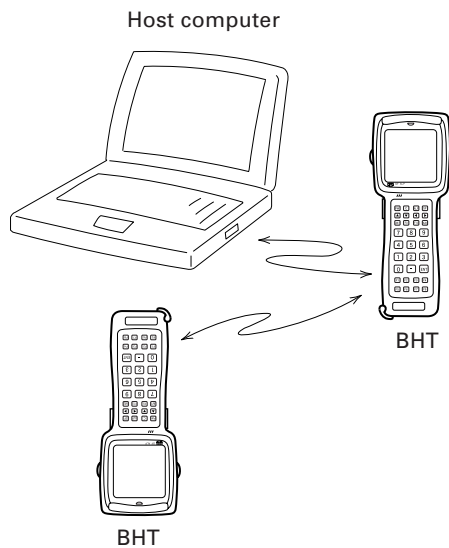

For a host computer having no IrDA interface port, use the optical communications unit CU-7000 (option) connected to the host via an RS-232C interface cable. Put the BHT in the CU-7000 as shown below.

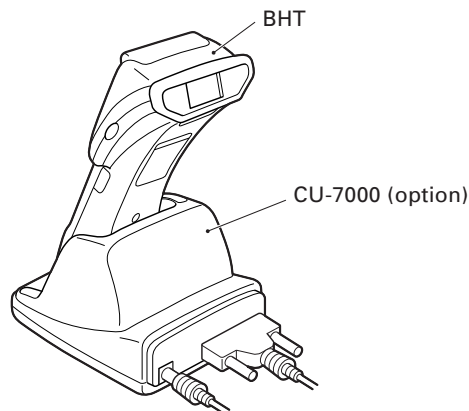

# Chapter 2

## Getting Started the BHT and System Mode

This chapter summarizes the BHT system configuration and describes the operation including preparation and System Mode (which is required for the efficient use of application programs).

2.1	BHT System Configuration .....	10
2.2	Components and Functions .....	15
2.3	Preparation .....	17
2.3.1	Setting-up 1: Loading the Battery Cartridge .....	17
2.3.2	Setting-up 2: Setting the Calendar Clock .....	21
2.3.3	Adjusting the LCD Contrast & Beeper Volume and Switching the Beeper & Vibrator .....	24
2.3.4	Battery Voltage Display .....	26
2.3.5	Synchronization Display in Radio Communication (BHT-7500S/7500W only) .....	26
2.3.6	Battery Replacement Notes .....	27
2.3.7	BHT Turning-off Notes .....	29
	[ 1 ] "Shutdown in progress" message .....	29
	[ 2 ] If the BHT is turned off abnormally .....	29
	[ 3 ] About "\$\$BRKLS.TSYS" .....	32
	[ 4 ] If invalid files are found .....	32
2.4	Initializing the BHT System .....	33
2.5	Operating in System Mode .....	37
2.5.1	Starting System Mode .....	37
2.5.2	Operating in System Mode .....	42
	[ 1 ] Calling up the desired set screen .....	42
	[ 2 ] Selecting a desired setting .....	43
2.5.3	Detailed Description of the Functions in System Mode .....	44
	[ 1 ] Program Execution .....	44
	[ 2 ] Downloading .....	46
	[ 3 ] Uploading .....	51
	[ 4 ] System Environment Setting .....	54
	[ 5 ] Testing .....	74
	[ 6 ] System Information .....	90
	[ 7 ] Downloading/Uploading by FTP (BHT-7500S/7500W only) .....	91
	[ 8 ] RF Menu <u>BHT-7500S</u> .....	96
	[ 8 ] RF Menu <u>BHT-7500W</u> .....	99
	[ 9 ] Deleting Files .....	109
	[ 10 ] Downloading/Uploading the BHT System Parameter File .....	111
	[ 11 ] Setting the Remote Wakeup .....	116
	[ 12 ] Setting the CPU Performance .....	117
	[ 13 ] Downloading/Uploading the System Message File .....	118

## 2.1 BHT System Configuration

The BHT barcode data collection system requires the following hardware as well as the BHT Bar Code Handy Terminal (which reads bar codes and accepts keypad entry), depending upon the intended system configuration.

- **Host computer:** Allows you to edit, manage and download programs and data, as well as downloading system programs.

For host computers having no IrDA interface ports, the optional CU-7000 optical communications unit and RS-232C interface cable are available.

- **CU-7000 (option):** Exchanges programs and data with the BHT via the IrDA interface and with the host computer via the RS-232C interface.
- **RS-232C interface cable (option):** Connects the CU-7000 and the host computer.

Direct cable connection between the BHT and host computer is also possible.

Optional software includes the BHT-BASIC Extension Library, BHT-BASIC Compiler, Ir-Transfer Utility C, Ir-Transfer Utility E, and Transfer Utility.

### System Configuration

#### IR communications system

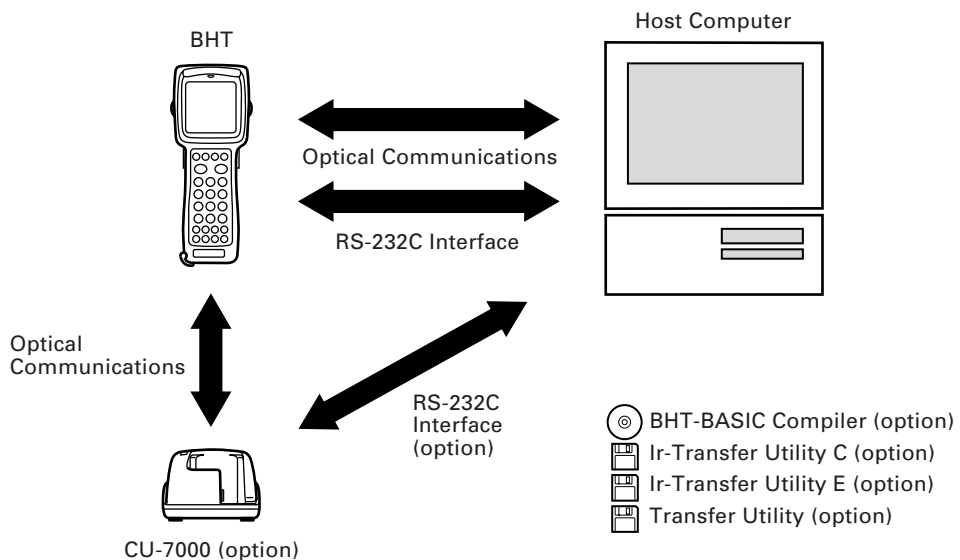

In addition, the BHT-7500S/7500W may operate in a radio communications system (spread-spectrum communication) by connecting with access points by a wireless local area network (wireless LAN).

- Access point: Wireless communications base unit for the BHT-7500S/7500W
- Ethernet port: Connects the access points and Ethernet

**Radio communications system (only BHT-7500S/7500W connectable)**

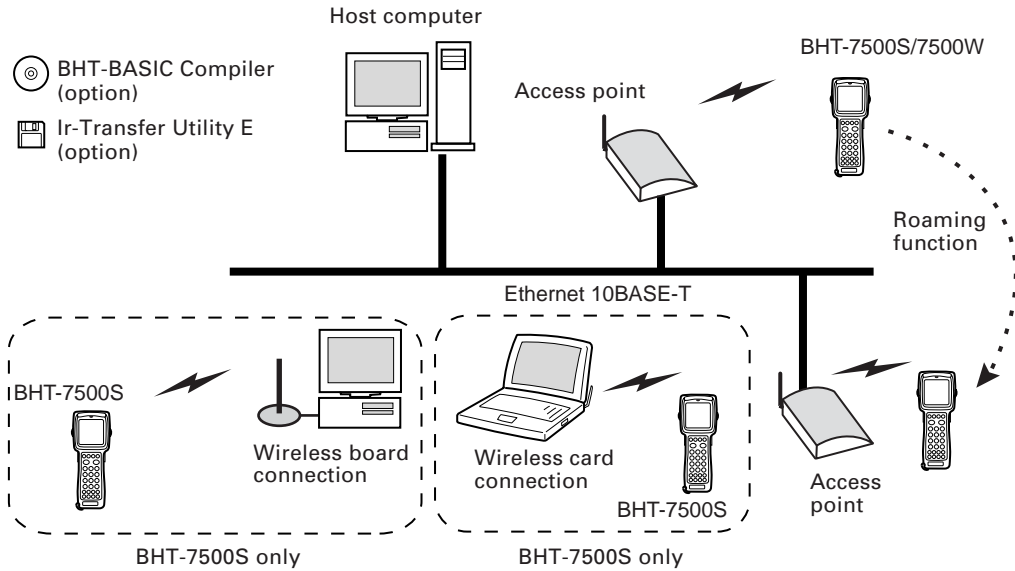

■ Host Computer

Models: PC/AT, PS/2

Optional application programs and OSes

OS	MS-DOS	Win3.1	Win95	Win98	WinNT3.5/4.0	Win2000 Professional
BHT-BASIC Compiler	BHT-BASIC3.0 (MS-DOS-based)	BHT-BASIC3.0 (Windows3.1-based)	BHT-BASIC3.5			
Ir-Transfer Utility C	MS-DOS-based	—	Win95-/NT-based			
Ir-Transfer Utility E	—	—	Win95-/NT-based	Win95-/NT-based*	Win95-/NT-based	Win95-/NT-based*
Transfer Utility	MS-DOS-based	Windows3.1-based	Win95-/NT-based			

\*This application does not activate any built-in port.

### ■ **CU-7000 and RS-232C Interface Cable (option)**

The CU-7000 is an IrDA-compliant communications unit which is required when your host computer is not equipped with an IrDA interface port. The CU-7000 exchanges data and programs with the BHT optically, and with the host computer via the RS-232C interface cable.

You may directly connect two BHTs with each other by using a commercially available metal cable having 3-pole mini stereo plugs (as a direct-connect interface cable). You also connect the BHT directly with the host computer or with the modem by using the direct-connect interface cable compatible with the target equipment. (NOTE: The direct-connect interface port of the BHT is not designed to stand frequent connecting/disconnecting. You are, therefore, recommended to use the CU-7000 where you expect to do a lot of connecting and disconnecting of the BHT to/from a host computer.)

### ■ **BHT-BASIC Compiler (option)**

This Compiler compiles a source program written in BHT-BASIC by an editor of the host computer running the MS-DOS, into the object program (user program) which can be used in the BHT. The compiled and linked program file is named "XXX.PD3." (XXX: File name you can set arbitrarily under the MS-DOS rules) You should download it to the BHT by using Ir-Transfer Utility C/Ir-Transfer Utility E/Transfer Utility.

### ■ **Ir-Transfer Utility C (option)**

Running on the host computer, this utility transfers files between the BHT and the host computer. For its file transfer control procedure, the utility uses the BHT-Ir protocol. (For the details about the BHT-Ir protocol, refer to Chapter 3, Subsection 3.5.2.)

To transfer files under any of the following conditions, use Ir-Transfer Utility C:

- At transmission speeds of 115200 or 57600 bps (This may be impossible depending upon the host computer type.)
- When the BHT is placed on the CU-7000
- Via the direct-connect interface of the BHT

### ■ **Ir-Transfer Utility E (option)**

Running on the host computer, this utility transfers files between the BHT and the host computer. For its file transfer control procedure, the utility uses the BHT-Ir protocol. (For the details about the BHT-Ir protocol, refer to Chapter 3, Subsection 3.5.2.)

To transfer files under any of the following conditions, use Ir-Transfer Utility E:

- Via an external IR transceiver
- Via an IR port integrated in a computer



## ■ Transfer Utility (option)

Running on the host computer, this utility transfers files between the BHT and the host computer. For its file transfer control procedure, the utility uses the BHT-protocol. (For the details about the BHT-protocol, refer to Chapter 3, Subsection 3.5.1.)

To transfer files under any of the following conditions, use Transfer Utility:

- When the BHT is placed on the CU-7000
- Via the direct-connect interface of the BHT

## Software Structure

System Programs and JIS Level 1 & Level 2 fonts are resident in the system area and user area, respectively.

To use extension programs and user programs, you should download the program files into the user area.

To use data files (e.g., goods master files) required for execution of user programs, you should download those data files before execution of user programs. Those files will be stored in the user area.

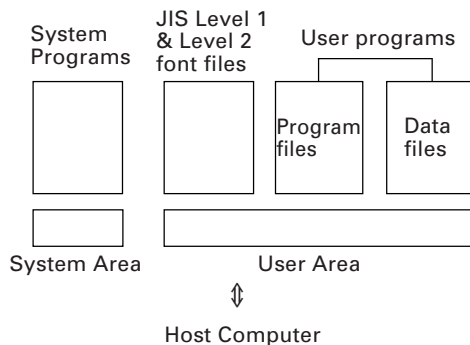

## ■ System Programs

The system programs include the following three sets of programs:

### Drivers

Drivers is a set of programs that directly controls the BHT hardware. It may be called up by the BHT-BASIC Interpreter or System Mode.

### BHT-BASIC Interpreter

The interpreter interprets and executes instructions in user programs written in BHT-BASIC.

## System Mode

System Mode is a system program exclusively designed for the effective use of user programs in the BHT. It sets up the execution environments for those programs; e.g., it prepares downloading/uploading conditions, sets the calendar clock, and tests the BHT components including the LCD, beeper, and keypad. Shown below is the System Mode menu (SYSTEM MENU).

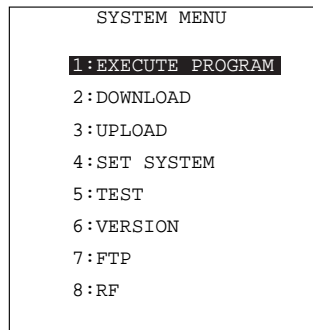

("7:FTP" and "8:RF" supported by the BHT-7500S/7500W only)

## ■ JIS Level 1 and Level 2 Font Files

These files contain font data required for displaying Kanji characters on the LCD.

The BHT can display the Kanji characters not only in the conventional standard-size font (16 dots wide by 16 dots high) but also in the small-size font (12 dots wide by 12 dots high) in application programs. It can also display the double-width Kanji characters of those 16-dot and 12-dot fonts in application programs.

### TIP

If you do not need to display Kanji characters, you may delete these JIS font files. After deletion, the memory area which was occupied by these files can be used as a user area. For the deleting procedure, refer to Section 2.4, "Initializing the BHT System" or Subsection 2.5.3, "[ 9 ] Deleting Files."

The names of the JIS font files are:

FNT16J1.FN3	(JIS Level 1 font, 16-dot)
FNT16J2.FN3	(JIS Level 2 font, 16-dot)
FNT12J1.FN3	(JIS Level 1 font, 12-dot)
FNT12J2.FN3	(JIS Level 2 font, 12-dot)

## ■ User Programs

You can develop application programs to meet individual job requirements by using the BHT-BASIC Compiler. To download those user programs to the BHT, use Ir-Transfer Utility C/Ir-Transfer Utility E/Transfer Utility.

## 2.2 Components and Functions

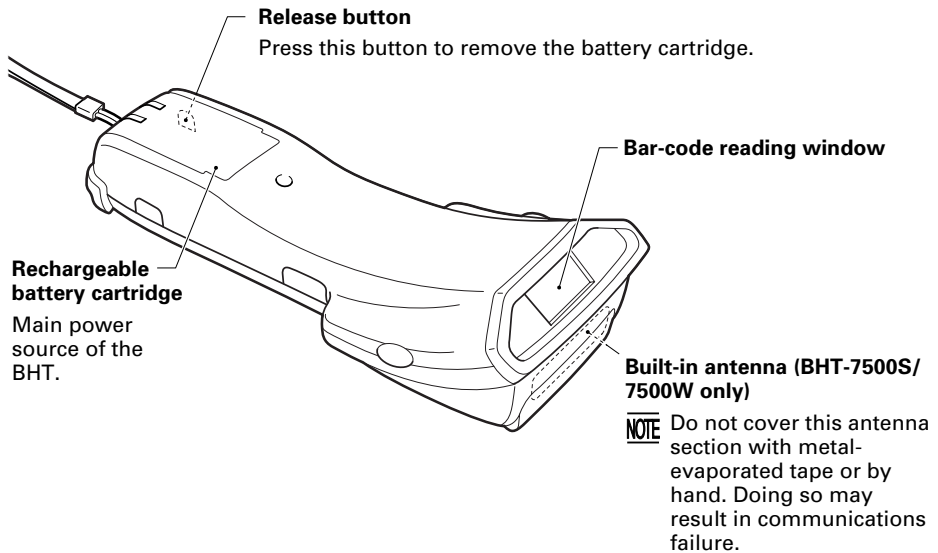
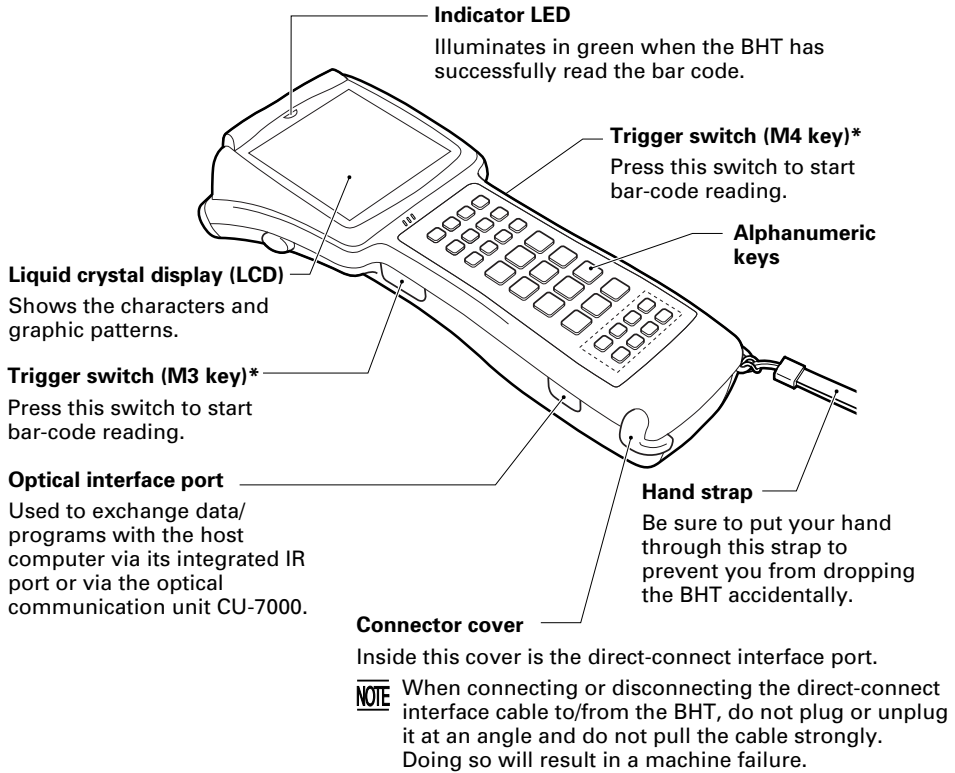

\* The trigger switch function is assigned to both of the M3 and M4 keys by default.

The functions of the keys may be set by user programs. Shown below is a set of sample functions.

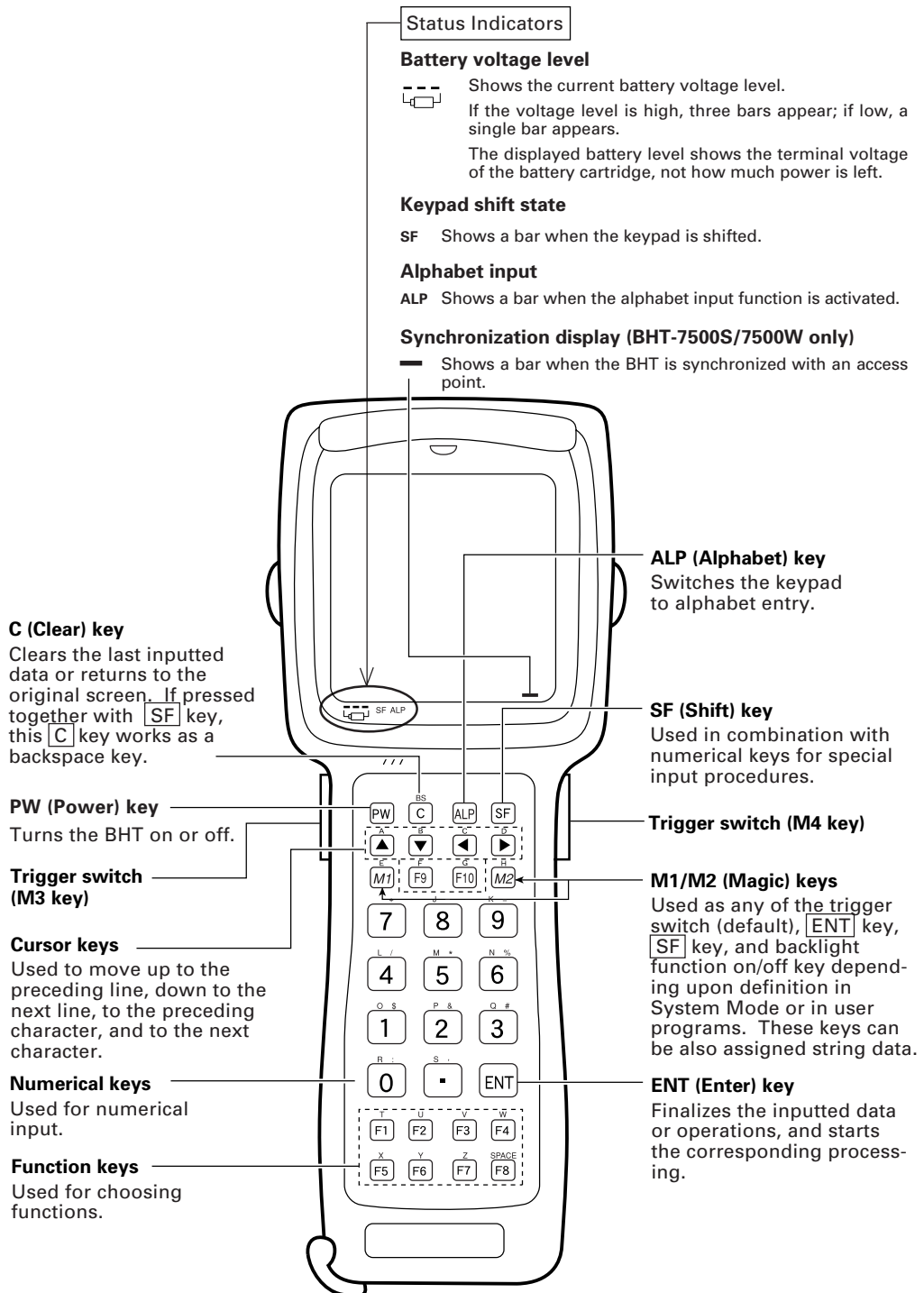

## 2.3 Preparation

### 2.3.1 Setting-up 1: Loading the Battery Cartridge

Before the first use of the BHT, be sure to load the battery cartridge as shown below. The battery cartridge is not loaded in the BHT when shipped from the factory.

- (1) Charge the rechargeable battery cartridge. (Refer to Section 5.5.)





To use the dry battery cartridge in the BHT, set two dry cells into the cartridge. (Refer to the "Dry Battery Cartridge User's Manual" that comes with the dry battery cartridge.)

**NOTE**

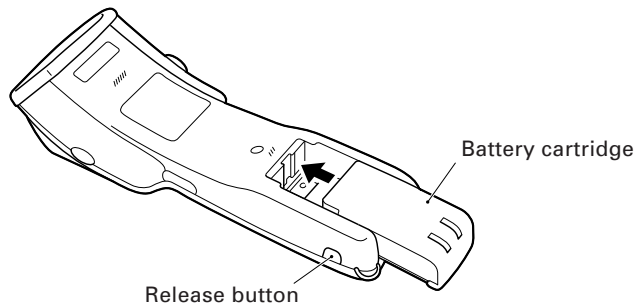
Use the dry battery cartridge as a spare of the rechargeable battery cartridge. The run time of the dry battery cartridge loaded with new dry cells is shorter than that of the fully-charged rechargeable battery cartridge. Some models cannot operate on a dry battery cartridge.

- (2) Turn the BHT upside down.
- (3) As shown below, slide the battery cartridge into the BHT until it clicks into place. (To remove it, press the release button after making sure that the BHT power is off.)



<p><b>⚠ WARNING</b></p>	<ul style="list-style-type: none"> <li>• Never disassemble or heat the battery cartridge, nor put it into fire or water; doing so could cause battery-rupture or leakage of battery fluid, resulting in a fire or bodily injury. </li> <li>• Do not carry or store the battery cartridge together with metallic ball-point pens, necklaces, coins, hairpins, etc.  <p>Doing so could short-circuit the terminal pins, causing the batteries to rupture or the battery fluid to leak, resulting in a fire or bodily injury.</p> </li> <li>• Avoid dropping the battery cartridge or letting it undergo any shock or impact.  <p>Doing so could cause the batteries to break, generate heat, rupture or burn.</p> </li> <li>• Never charge the rechargeable battery cartridge where any inflammable gases may be emitted; doing so could cause fire. </li> </ul>
<p><b>⚠ CAUTION</b></p>	<ul style="list-style-type: none"> <li>• Do not use batteries or power sources other than the specified ones; doing so could generate heat or cause malfunction. </li> </ul>

**NOTE**

- Never charge the dry battery cartridge.
- The BHT has an integrated backup power source which backs up the memory and calendar clock in the BHT when no battery cartridge is loaded or the voltage level of the battery cartridge drops below the specified level. The backup power source is automatically charged by the battery cartridge.

When you first load the battery cartridge after purchase or you load it after leaving the BHT unused for a long time, do not remove the battery cartridge for 10 minutes or more after that loading. This is for charging the memory backup source integrated in the BHT.

- Be sure to turn the BHT off before battery replacement. Replace the battery cartridge quickly. Load a charged battery cartridge within 3 minutes from the removal of the cartridge to avoid data loss.

After battery replacement, turn the BHT on and check its operation.

- If you leave the BHT with no battery cartridge loaded for a long time, the memory contents will no longer be backed up so that the message "Contact your administrator. Note the error number. (XXXX)" or "Set the current date and time." may appear on the LCD.

If you will not be using the BHT for a long time, follow the instructions given in Subsection 2.3.6, "Battery Replacement Notes."

- When disposing of the battery cartridge, cover the terminal pins with vinyl tape to prevent short-circuit.
- Avoid storing the rechargeable battery cartridge in a hot place. The battery capacity may be decreased.
- Do not touch the charge terminals of the rechargeable battery cartridge by hand or stain those terminals. Doing so could result in a charging failure.

### ■ Battery Voltage Level on the Status Indicator Line

The battery voltage level is always displayed on the status indicator line.

(For details, refer to Subsection 2.3.4 "Battery Voltage Display.")

## ■ Low Battery Indication

### Low battery indication—Level 1

If the battery output voltage drops below a specified lower level limit while the BHT is in operation, the BHT displays the following Level 1 message for approx. 2 seconds and beeps three times. After that, it will resume previous regular operation.

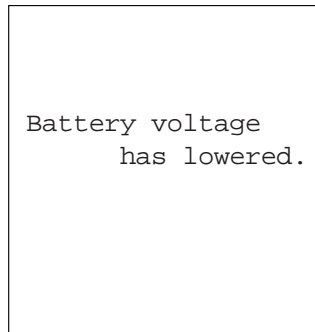

```
Battery voltage  
has lowered.
```

The service life of the battery cartridge will expire soon. If the BHT is driven by the rechargeable battery cartridge, recharge or replace it; if it is driven by the dry battery cartridge, replace the dry cells.

### Low battery indication—Level 2

If you continue to use the BHT without recharge or battery replacement after the Level 1 message appears, the BHT displays the following Level 2 message, beeps five times, and then turns itself off.

(When driven by the rechargeable battery cartridge)

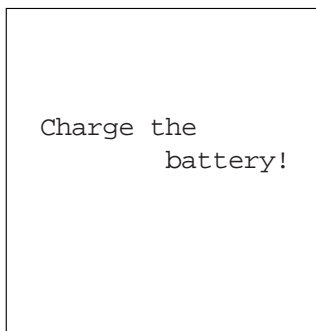

```
Charge the  
battery!
```

(When driven by the dry battery cartridge)

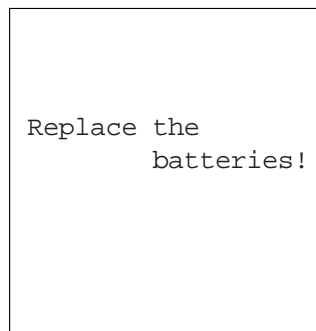

```
Replace the  
batteries!
```

If the BHT is driven by the rechargeable battery cartridge, recharge or replace it; if it is driven by the dry battery cartridge, replace the dry cells.

**NOTE**

- When replacing dry cells, always replace both of them with new alkaline manganese batteries (LR6).
- You may charge the rechargeable battery cartridge with the optional CU-7001 communication unit or optional C-700/C-750 charger. For the charging procedure using the CU-7001, refer to Chapter 5. For that using the C-700/C-750, refer to the "C-700 User's Manual"/"C-750 User's Manual."
- If the "Charge the battery!" or "Replace the batteries!" message appears after the BHT undergoes any shock or impact, turn the power off and on and then check the battery output level. The battery may not have run out.

**WARNING**

Only use the dedicated charger (CU-7001, C-700 or C-750) for charging the rechargeable battery cartridge.

Using a different type of charger could cause battery-rupture or leakage of battery fluid and result in a fire, bodily injury, or serious damage to property.

**CAUTION**

Never charge a wet or damp rechargeable battery cartridge.

Doing so could cause the batteries to break, generate heat, rupture or burn.





## 2.3.2 Setting-up 2: Setting the Calendar Clock

Turn the BHT on by pressing the **[PW]** key.

The following message will appear.

```
Set the current
date and time.

00/01/01 00:00
_ / /      :
```

In the following cases, the above message will appear. In such instances, it is necessary to set the date and time. (The indication "00/01/01 00:00" will differ depending upon the calendar clock state.)

- The BHT is first turned on from the time of purchase.
- The BHT is turned on after the memory backup power source is completely discharged.

### **NOTE**

It is recommended that you upload font files beforehand for such cases that you would mistakenly delete font files or a memory storage error would erase font files. (For the uploading procedure, refer to Subsection 2.5.3, [ 3 ].)

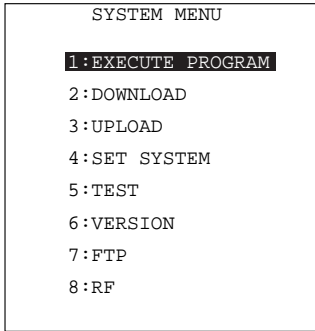

("7:FTP" and "8:RF" supported by the BHT-7500S/7500W only)

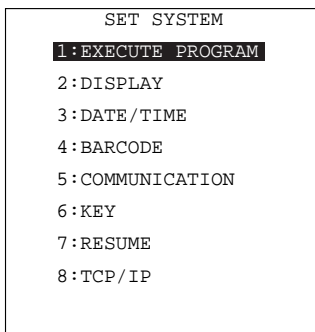

("8:TCP/IP" supported by the BHT-7500S/7500W only)

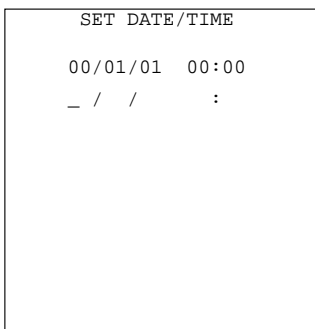

- (1) While holding down the **[SF]** and **[1]** keys, press the **[PW]** key to start System Mode. The SYSTEM MENU shown at left will appear.

- (2) Press the **[4]** key to select the "SET SYSTEM" on the SYSTEM MENU and then press the **[ENT]** key, and the screen shown at left will appear.

(To return to the immediately preceding screen during this setting procedure, press the **[C]** key.)

- (3) Press the **[3]** key on the SET SYSTEM screen to select the "DATE/TIME" and then press the **[ENT]** key, and the screen shown at left will appear.

- (4) Use the numerical keys to enter the year (only the last two digits), month, day, hour, and minute in this order. If the data is in one digit, add a 0 (zero) preceding the data.

#### **NOTE**

For the year, be sure to enter the last two digits of the year. For the hour, enter it in the 24-hour format.

If any of the year, month, day, hour, and minute is not entered, the **[ENT]** key will be deactivated.

If you make a wrong entry, press the **[BS]** key (**[SF]** + **[C]** keys) to delete it and then enter the correct data.

```
SET DATE/TIME
00/01/01 00:00
00/04/19 16:00_
```

[Example] To set 2000, April 19, at 4:00 p.m.

Press , , , , , , , , , and .

```
SET DATE/TIME
00/04/19 16:00
_ / / :
```

(5) Press the  key to register the above setting.

(6) Press the  key to return to the SET SYSTEM screen.

### 2.3.3 Adjusting the LCD Contrast & Beeper Volume and Switching the Beeper & Vibrator

While holding down the **M1** or **M4** key (trigger switch), press the **PW** key, and any of the following screens will appear on the LCD. This screen will disappear if no keys are pressed for five seconds.

When the beeper is selected (default)

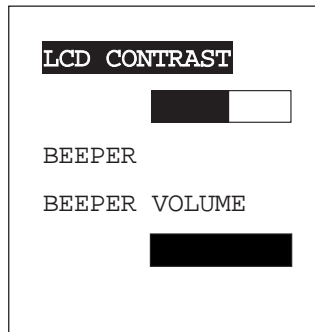

When the vibrator is selected

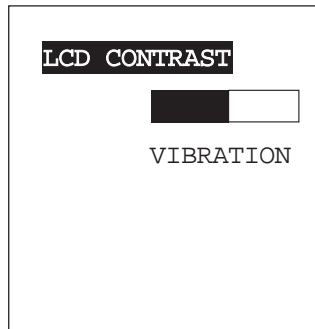

When both the beeper and vibrator are selected

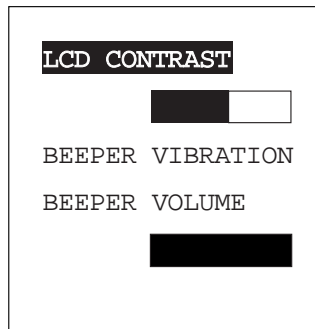

(The current selection is highlighted.)

### **Adjusting the LCD contrast**

You can adjust the LCD brightness to eight contrast levels.

- 1) Use the ▲ or ▼ keys to select the LCD CONTRAST line.
- 2) To decrease the contrast, press the ◀ key; to increase it, press the ▶ key.

### **Switching the beeper & vibrator**

You may choose any of three ways—beeping only, vibrating only, or beeping & vibrating as a confirmation of completion of bar-code reading.

- 1) Use the ▲ and ▼ keys to select the BEEPER VIBRATION line that will be highlighted in any one of the following three states:



- 2) Use the ◀ and ▶ keys to highlight the desired way(s).

### **Adjusting the beeper volume**

You can adjust the beeper volume to four levels from OFF to MAX.

- 1) Use the ▲ and ▼ keys to select the BEEPER VOLUME line.
- 2) To turn down the volume, press the ◀ key; to turn it up, press the ▶ key.

After making the above setting, press the ENT key or press no keys for five seconds, and the new setting will be fixed and the above screen will disappear.

## 2.3.4 Battery Voltage Display

The battery voltage level is always displayed on the status indicator line (bottom line).

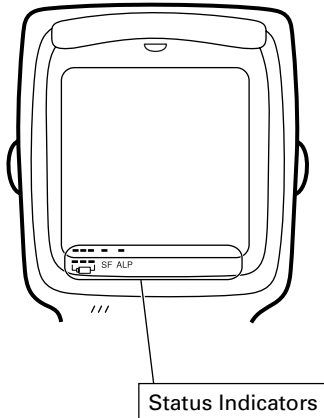

### Battery voltage level

 Shows the current battery voltage level.

If the voltage level is high, three bars appear; if low, a single bar appears.

### TIP

The displayed battery level shows the terminal voltage of the battery, not how much power is left.

The battery voltage level varies depending upon the operation of the BHT, so the displayed level also may vary.

## 2.3.5 Synchronization Display in Radio Communication (BHT-7500S/7500W only)

When the BHT is synchronized with an access point during radio communication (spread-spectrum communication), a bar appears on the LCD as shown below.

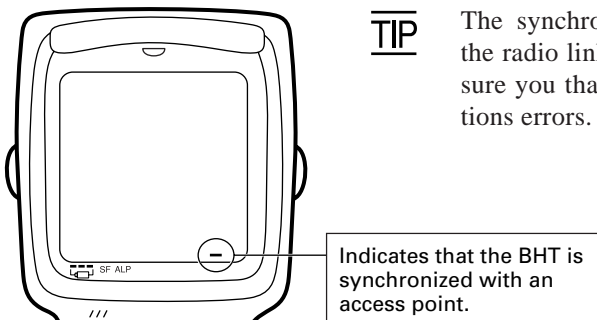

### TIP

The synchronization display indicates that the radio link is established but does not assure you that there will be few communications errors.

## 2.3.6 Battery Replacement Notes

### ■ When is battery replacement needed?

If the "Charge the battery!" or "Replace the batteries!" appears on the LCD, replace the rechargeable battery cartridge with a fully charged one or replace the dry cells with new ones, respectively.

If you leave the BHT without replacing the rechargeable battery cartridge or dry cells, the integrated calendar clock or data will no longer be backed up so that the calendar clock will stop or the message "Contact your administrator. Note the error number. (XXXX)" will appear on the LCD.

#### **NOTE**

Be sure to turn the BHT off before battery replacement.

Replace the battery cartridge quickly. Load a charged battery cartridge or new dry cells within 3 minutes after the removal to avoid data loss.

After battery replacement, turn the BHT on and check its operation.

### ■ If you will use the BHT more than one time per month:

Keep the battery cartridge loaded in the BHT.

### ■ If you will not be using the BHT for more than one month:

Remove the battery cartridge from the BHT and then store the BHT. To do so, be sure to follow the procedure given below.

- (1) When removing the battery cartridge:

Press the **[PW]** key for more than 3 seconds to turn the power off.

The following message will appear on the LCD and the BHT will start backing up data. After completion of the backup operation so that the message disappears, remove the battery cartridge.

(The backup operation may take several tens of seconds depending upon the volume of data to be backed up.)

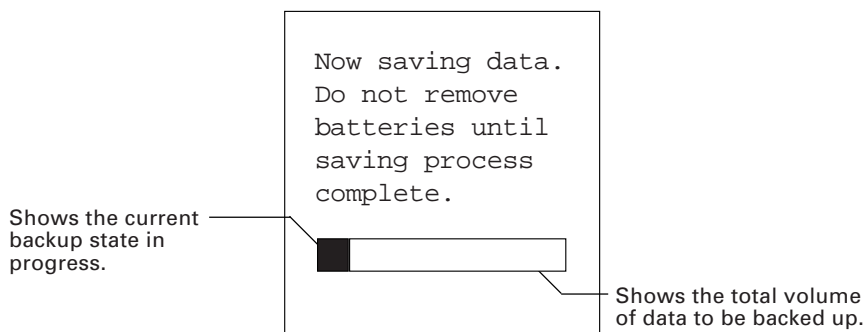

(2) When turning the BHT on after storage with no battery cartridge loaded:

Even after removal of the battery cartridge, the calendar clock will work with the backup power source for a while.

If the calendar clock backup has stopped, loading the battery cartridge and turning the BHT on will display the following message, prompting you to set the current date and time.

Set the calendar clock according to the procedure given in Subsection 2.3.2.

(The indication "00/01/01 00:00" will vary depending upon the calendar clock state.)

```
Set the current
date and time.

00/01/01 00:00
_ / /      :
```



## 2.3.7 BHT Turning-off Notes

### [ 1 ] "Shutdown in progress" message

When the BHT is turned off by pressing the **[PW]** key or by the auto power-off feature, it displays the following message and starts preparation for shutdown.

```
Shutdown
in progress.

Do not remove the
battery.
```

When the above message is displayed, do not remove the battery cartridge.

If you do so and leave the BHT without a battery cartridge loaded for one hour or more, then the error message "Contact your administrator. Note the error number. (2XXX)" may appear when you reload the battery cartridge and turn the BHT on.

### [ 2 ] If the BHT is turned off abnormally

If the BHT is turned off abnormally\* and is left without a battery cartridge loaded or with a discharged battery cartridge loaded, then unsaved data may be lost.

(\*"Normally turned off" refers to "turned off with the **[PW]** key or by the auto power-off feature.")

If the above problem has arisen, the following message will appear when you load a fully-charged battery cartridge (or a dry battery cartridge having new dry cells) and turn the BHT on.

```
Your terminal was
not shut down
properly the last
time it was used.

Unsaved data
was lost.

[Sf+2]
```

- (1) Press the **[2]** key while holding down the **[SF]** key. The screen will switch to the following:

```
Do you want to
run Scandisk?

1.Yes   2.No
```

- [ 1 ] YES: Run Scandisk and start the System.  
[ 2 ] NO: Turn the BHT off.

- (2) Choose either one with the numerical keys and press the **[ENT]** key.  
When Scandisk is in progress, the following message is displayed:

```
Scandisk is
checking your
drive for errors.
```

If Scandisk finds an invalid file(s), the following screen will appear. As long as an invalid file exists, that screen displays every time the BHT System is started up.

```
Scandisk found
invalid files.

Refer to the file
"$\$BRKLST.SYS" for
more information.
```

(3) Press the **ENT** key to start up the BHT System.

#### ■ Scandisk when the resume function is enabled

If Scandisk runs when the resume function is enabled, the screen given below may appear. The screen may also appear when the calendar clock built in the BHT stops, even without running Scandisk.

The BHT displays the screen for three seconds and then automatically runs the execution program from the beginning.

```
No resume info.
has been retained.
Program restarts
automatically.
```

### [ 3 ] About "\$\$BRKLST.SYS"

If Scandisk finds an invalid file(s), it will automatically create the "\$\$BRKLST.SYS" file. To check the contents of the file, upload the file in System Mode to the host computer. (Refer to Subsection 2.5.3, "[ 3 ] Uploading.")

#### Contents of the "\$\$BRKLST.SYS" file

Records (1) File name

- |                    |   |
|--------------------|---|
| (2) Error factor   | + (Broken since the BHT has not been turned off normally)<br>* (Broken due to any other causes) |
| (3) Broken records | e.g. 01000-01200 (Data in records numbered 1000 to 1200 is lost)                                |

(Example)

SAMPLE1.DAT + 01000-01050	} If more than one sequence of records is broken in a same file, they will be written into the subsequent records in the "\$\$BRKLST.SYS."
SAMPLE1.DAT + 01200-01250	
SAMPLE1.DAT + 01600-01650	
SAMPLE2.DAT * 00250-00275	
SAMPLE3.DAT * 00100-00150	
↑        ↑        ↑	
(1)      (2)      (3)	

### [ 4 ] If invalid files are found

Even invalid, files may be uploaded, so upload them to the host computer according to your needs.

After uploading,

- Delete those invalid files. (Refer to Subsection 2.5.3, "[ 9 ] Deleting Files.")  
or
- Download valid files having the same names as invalid files. (Refer to Subsection 2.5.3, "[ 2 ] Downloading.")

## 2.4 Initializing the BHT System

Initializing the system will lose program files and data files stored in the user area and the system settings will revert to the factory defaults.

**TIP** You may delete font files by selecting the whole user area to be initialized.

You need to initialize the system when:

- (1) you want to delete all of the program files and data files.
- (2) the following message appears.

Contact your  
administrator.  
Note the error  
number.  
(2XXX)

**NOTE** WEP KEYs defined in the BHT-7500W will not be initialized.

On the following pages is an initialization procedure.

## (1) Selecting the memory area to be initialized

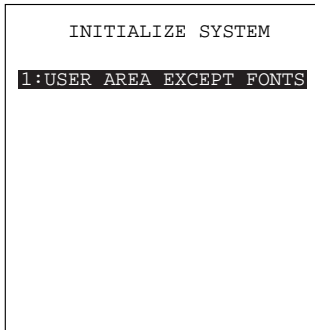

Press the **PW** key while holding down the **SF**, **M1** and **0** keys together.

The screen shown at left will appear.

To initialize the user area except for the font file area, press the **ENT** key. The screen switches to the SELECT MESSAGE display given in step (2).

To initialize the whole user area including the font file area, press the **2** key while holding down the **SF** key. The "2:WHOLE USER AREA" item will appear.

(Area selection screen)

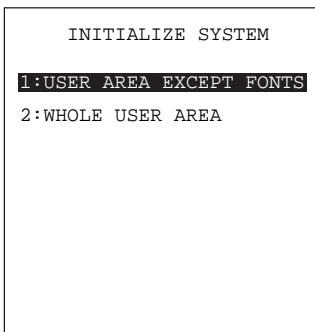

### 1 USER AREA EXCEPT FONTS:

Initializes the user area except for the font file area.

### 2 WHOLE USER AREA:

Initializes the whole user area including the font file area.

### TIP

If the message "Contact your administrator. Note the error number. (2XXX)" appears on the LCD, you need to select "2: WHOLE USER AREA" to initialize the whole user area.

Select an area to be initialized by using the numerical keys, then press the **ENT** key. The screen switches to the SELECT MESSAGE display given in step (2).

## (2) Selecting the English or Japanese message version

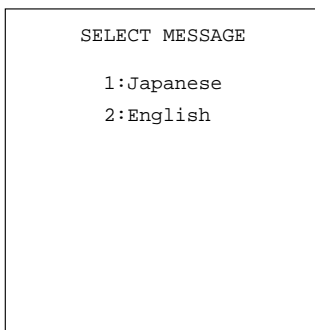

Preceding the execution of initialization, the message version selection screen will appear as shown at left.

1 Japanese : Switches the message version to Japanese.

2 English : Switches the message version to English.

Select a desired item by using the numerical keys, then press the **ENT** key.

(3) Confirming the memory area selected for initialization

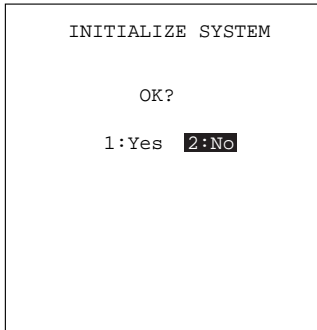

Selecting the "USER AREA EXCEPT FONTS" in step (1) above will call up the confirmation screen shown at left.

1 Yes : Starts initialization.

2 No : Cancels initialization and turns the power off.

Select a desired item by using the numerical keys, then press the **ENT** key.

Pressing the **C** key will switch the screen back to the area selection screen.

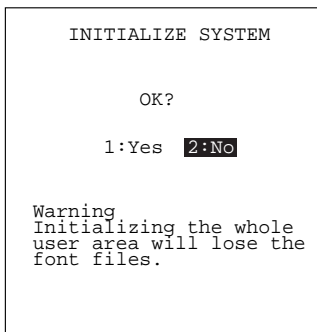

Selecting the "WHOLE USER AREA" in step (1) above will call up the screen shown at left.

1 Yes: Starts initialization.

2 No: Cancels initialization and turns the power off.

Select a desired item by using the numerical keys, then press the **ENT** key.

Pressing the **C** key will switch the screen back to the area selection screen.

(4) During initialization

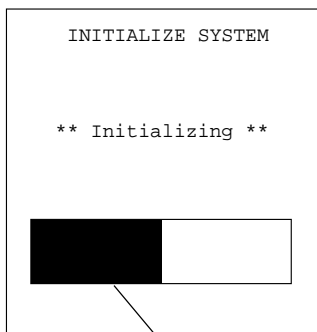

During initialization, the screen shown at left is displayed.

#### (5) Completion of initialization

```
INITIALIZE SYSTEM

** Completed **
```

Upon completion of the initialization, the BHT displays the screen shown at left for a second and turns itself off automatically.

#### **NOTE**

- Do not turn the BHT off until the above initialization completion screen appears. A too-early powering-off will interrupt initialization, requiring you to initialize the BHT again.
- If the message "Contact your administrator. Note the error number. (2XXX)" appears although the initialization has completed, initialize the BHT again.
- If you initialize the BHT after downloading user programs and data, all of those programs and data stored in the target memory area will be lost. Download them again if necessary.
- Initialization will reset the LCD contrast level (refer to Subsection 2.3.3), communications conditions and other settings to the factory defaults, so make your own setting if necessary. After initialization, be sure to set the calendar clock (refer to Subsection 2.3.2).



## 2.5 Operating in System Mode

System Mode is an operating software exclusively designed for the effective use of the BHT, which includes various functions as shown on the following pages.

### 2.5.1 Starting System Mode

To start up System Mode, turn the BHT power on while holding down the **SF** and **1** keys. This operation calls up the SYSTEM MENU on the LCD as shown below.

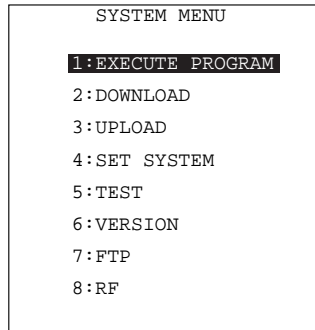

("7:FTP" and "8:RF" supported by the BHT-7500S/7500W only)

The function selected is highlighted (white-on-black) with the cursor. To select a desired item in System Mode, press the corresponding numerical key and then press the **ENT** key.

The keys below are so designed that the function of each key is consistent in every screen.

Numerical keys	Pressing a numerical key corresponding with a desired menu number selects the desired item displayed on the screen.
<b>ENT</b> key	Pressing this key registers the selected item and executes the corresponding function.
<b>▲</b> and <b>▼</b> keys	Pressing the <b>▲</b> or <b>▼</b> key moves the cursor up or down, respectively, to select a desired item.
<b>◀</b> and <b>▶</b> keys	Pressing the <b>◀</b> or <b>▶</b> key moves the cursor to the left or right, respectively, to select a desired setting.

The **C** key is inoperative on the SYSTEM MENU. On other screens, pressing the **C** key returns to the immediately preceding screen.

The power-on default is "EXECUTE PROGRAM" which is highlighted. Once any other item is selected, the selected item will become highlighted with the cursor when you turn back to the SYSTEM MENU.

## ■ Structure of System Mode

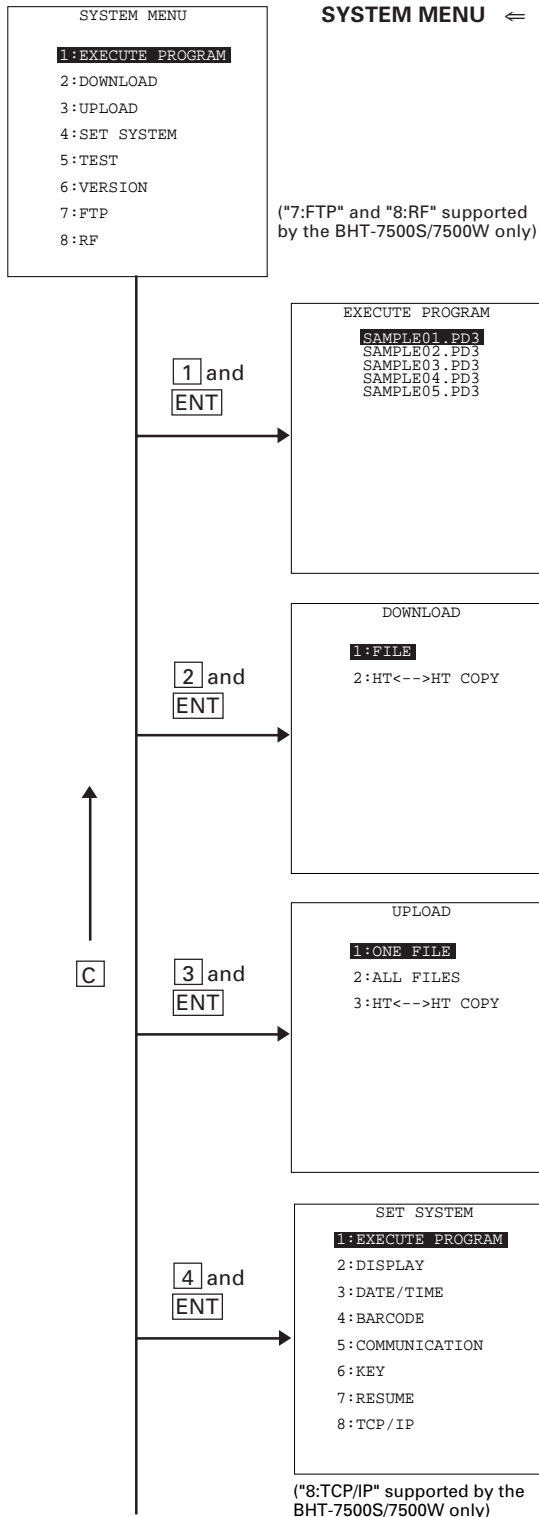

**SYSTEM MENU** ← Press the **PW** key while holding down the **SF** and **1** keys.

### Program Execution

Allows you to select a desired user program to be executed immediately. (Refer to Subsection 2.5.3, [ 1 ].)

### Downloading

Transfers user program files or data files from the host computer to the memory integrated in the BHT. Downloading between the BHTs is also possible. (Refer to Subsection 2.5.3, [ 2 ].)

### Uploading

Transfers user program files and data files stored in the memory of the BHT to the host computer. (Refer to Subsection 2.5.3, [ 3 ].)

### System Environment Settings

Sets a variety of environmental conditions—an execution program, message version (English or Japanese), calendar clock, special bar-code scanning parameters, interface port, communications parameters, shift-key & magic key functions, resume function, and TCP/IP and FTP settings (BHT-7500S/7500W only). (Refer to Subsection 2.5.3, [ 4 ].)

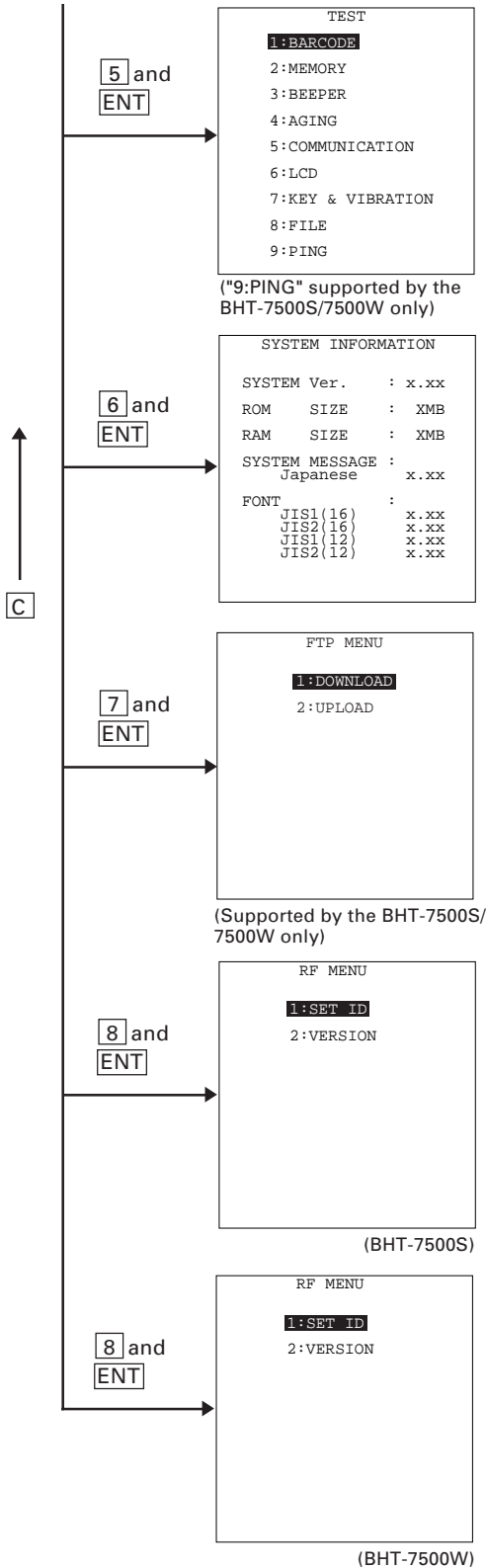

**Testing**

Used for the bar-code reading test, memory test, beeper test, aging test, communications test, LCD indication test, indicator LED test, key-entry test, vibrator test, file test, and execution of PING (BHT-7500S/7500W only).

(Refer to Subsection 2.5.3, [ 5 ].)

**System Information**

Shows the system program version, memory size, system message version, and JIS font type and version.

(Refer to Subsection 2.5.3, [ 6 ].)

**Downloading/Uploading by FTP (BHT-7500S/7500W only)**

Downloads or uploads files by FTP.

(Refer to Subsection 2.5.3, [ 7 ].)

**RF Menu (BHT-7500S only)**

Sets a network domain name and security ID for spread-spectrum wireless communication, and gets wireless module related information.

(Refer to Subsection 2.5.3, [ 8 ] BHT-7500S.)

**RF Menu (BHT-7500W only)**

Sets RF parameters for spread-spectrum wireless communication and gets wireless module related information.

(Refer to Subsection 2.5.3, [ 8 ] BHT-7500W.)

In addition to the functions given on the previous pages, System Mode has these five functions: Deleting files, Downloading/uploading the BHT system parameter file, Setting the remote wakeup parameters, Setting the CPU performance and Downloading/uploading the system message file.

To call up these functions, press the **0** , **3** , **4** , **5** or **6** key, respectively, while holding down the **SF** key when the SYSTEM MENU is displayed.

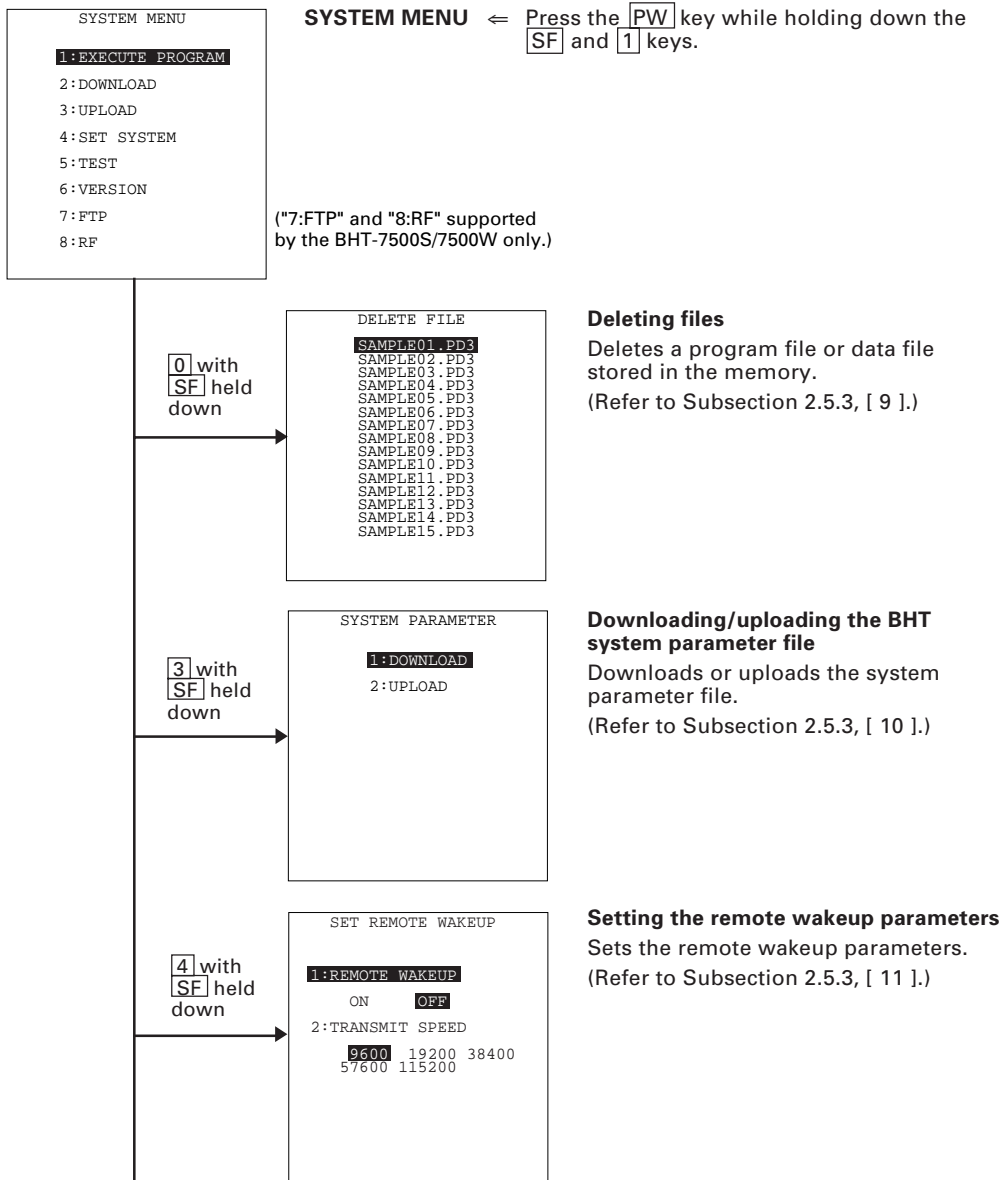

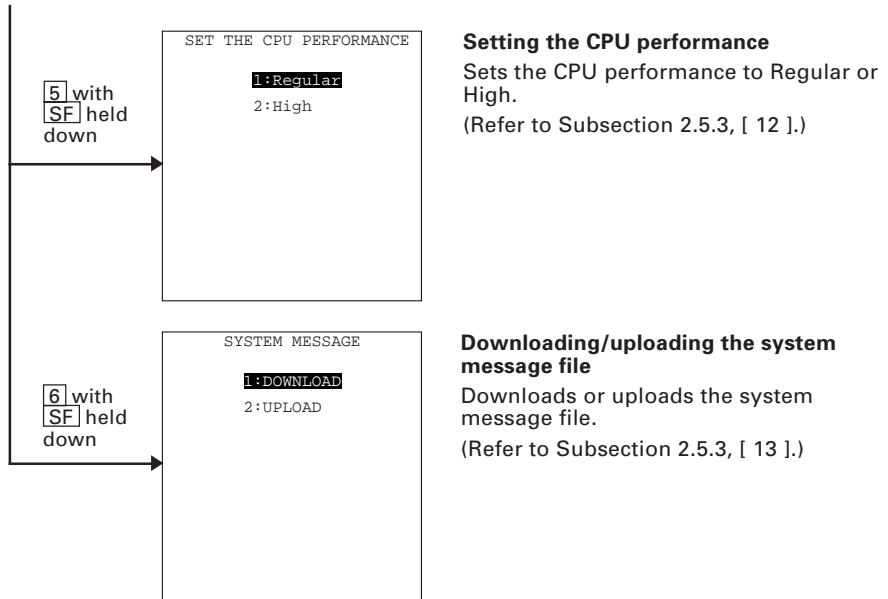

## 2.5.2 Operating in System Mode

Some functions in System Mode require several screens to be shifted, as shown in the example below.

### [ 1 ] Calling up the desired set screen

First, select a desired item on the current screen by using the numerical key or the cursor keys (▲ and ▼) so as to highlight the desired item.

Press the **ENT** key to establish the selected item and proceed to the subsequent screen.

To return to the preceding screen, press the **C** key.

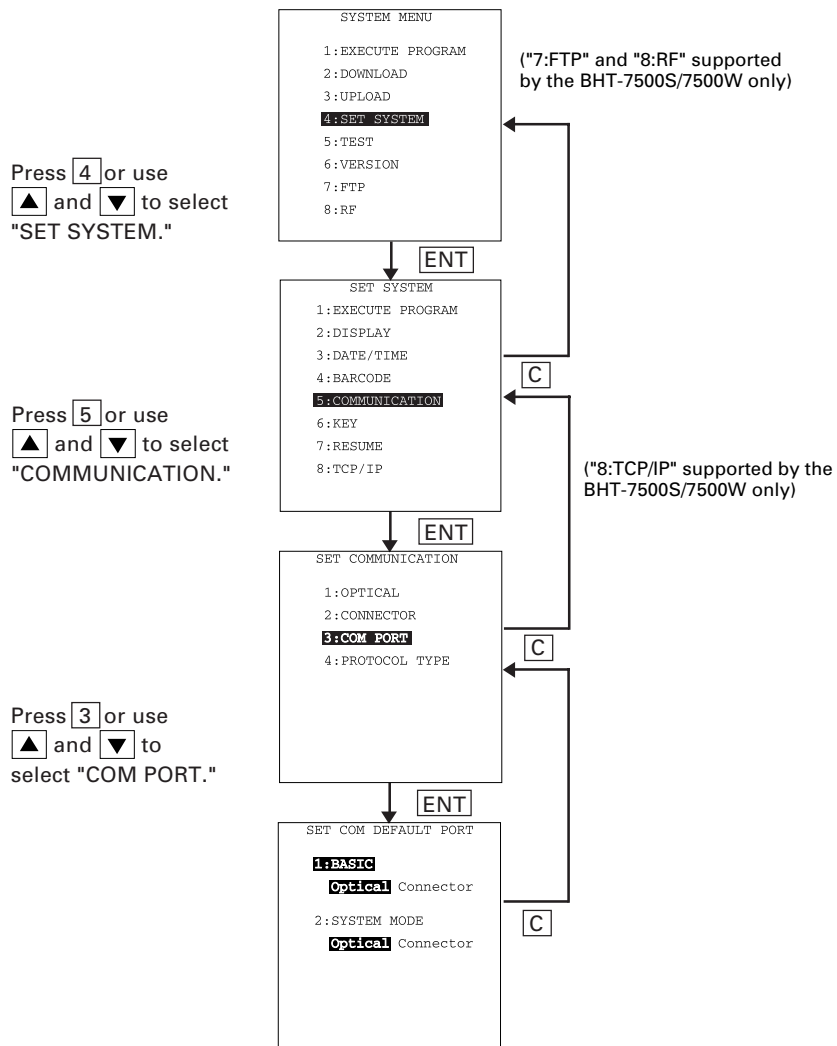

## [ 2 ] Selecting a desired setting

First, select a desired item on the current screen by using the numerical key or the cursor keys (**▲** and **▼**) so as to highlight the desired item.

Use the **◀** and **▶** keys to select a desired setting and then press the **ENT** key. The screen returns to the previous selection screen.

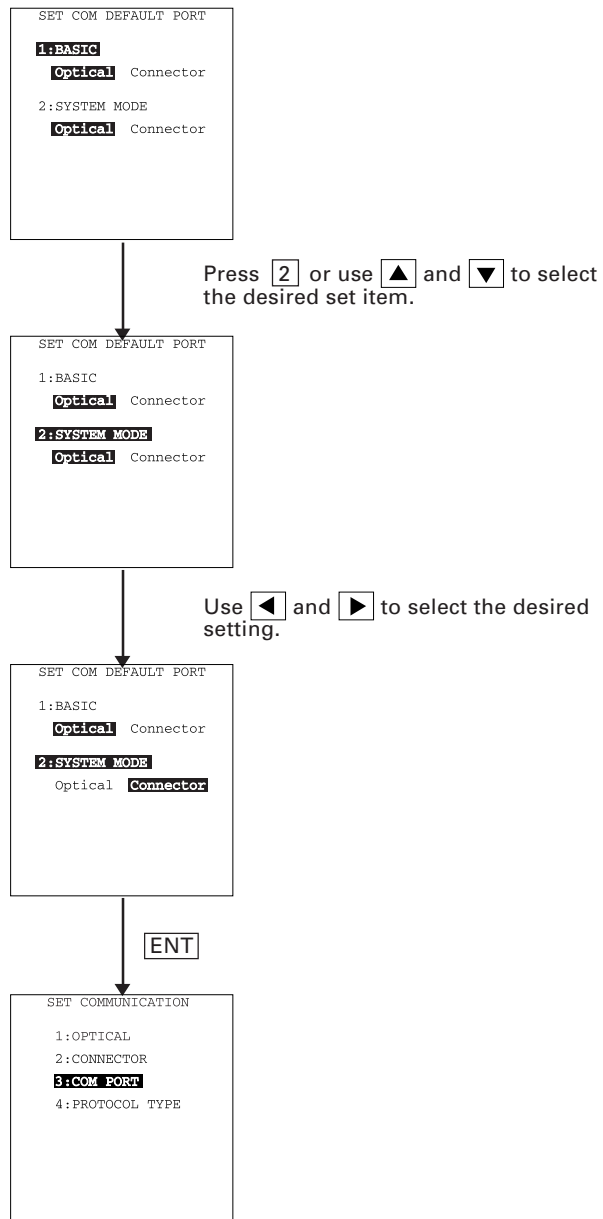

## 2.5.3 Detailed Description of the Functions in System Mode

### [ 1 ] Program Execution

```
EXECUTE PROGRAM
SAMPLE01.PD3
SAMPLE02.PD3
SAMPLE03.PD3
SAMPLE04.PD3
SAMPLE05.PD3
SAMPLE06.PD3
SAMPLE07.PD3
SAMPLE08.PD3
SAMPLE09.PD3
SAMPLE10.PD3
SAMPLE11.PD3
SAMPLE12.PD3
SAMPLE13.PD3
SAMPLE14.PD3
SAMPLE15.PD3
SAMPLE16.PD3
SAMPLE17.PD3
```

Selecting "1:EXECUTE PROGRAM" on the SYSTEM MENU calls up the screen shown at left.

If more than one program has been downloaded to the user area of the target memory, use the ▲ and ▼ keys to move the cursor to a target program, and then press the ENT key.

To return to the SYSTEM MENU, press the C key.

```
EXECUTE PROGRAM
SAMPLE01.PD3
SAMPLE02.PD3
SAMPLE03.PD3
SAMPLE04.PD3
SAMPLE05.PD3
SAMPLE06.PD3
SAMPLE07.PD3
SAMPLE08.PD3
SAMPLE09.PD3
SAMPLE10.PD3
SAMPLE11.PD3
SAMPLE12.PD3
SAMPLE13.PD3
SAMPLE14.PD3
SAMPLE15.PD3
SAMPLE16.PD3
SAMPLE17.PD3
```

If more than 17 programs have been downloaded, you may need to scroll the screen with the ▼ key.



```
EXECUTE PROGRAM
SAMPLE02.PD3
SAMPLE03.PD3
SAMPLE04.PD3
SAMPLE05.PD3
SAMPLE06.PD3
SAMPLE07.PD3
SAMPLE08.PD3
SAMPLE09.PD3
SAMPLE10.PD3
SAMPLE11.PD3
SAMPLE12.PD3
SAMPLE13.PD3
SAMPLE14.PD3
SAMPLE15.PD3
SAMPLE16.PD3
SAMPLE17.PD3
SAMPLE18.PD3
```





```
EXECUTE PROGRAM
SAMPLE05.PD3
SAMPLE06.PD3
SAMPLE07.PD3
SAMPLE08.PD3
SAMPLE09.PD3
SAMPLE10.PD3
SAMPLE11.PD3
SAMPLE12.PD3
SAMPLE13.PD3
SAMPLE14.PD3
SAMPLE15.PD3
SAMPLE16.PD3
SAMPLE17.PD3
SAMPLE18.PD3
SAMPLE19.PD3
SAMPLE20.PD3
SAMPLE21.PD3
```

In the example shown at left, 21 programs are downloaded.

```
EXECUTE PROGRAM
*****
* NO FILE EXISTS *
*****
```

If no program file is downloaded, the message shown at left will appear.

To return to the SYSTEM MENU, press the **C** key.

## [ 2 ] Downloading

### NOTE

If you download a file having the same name as one already used in the user area of the target memory in the BHT, the newly downloaded file replaces the old one.

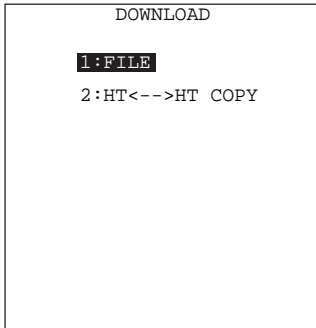

Selecting "2: DOWNLOAD" on the SYSTEM MENU calls up the screen shown at left.

**1** FILE : Downloads a user program file or data file to the user area of the BHT.

**2** HT<-->HT COPY : Downloads all of the files, system parameters, and calendar clock data stored in the connected BHT.

This function enables copying between the BHTs.

For the preparation to be made preceding the start of this function, refer to NOTE below.

Select a desired item by using the numerical keys or **▲** and **▼** keys, and the selected item becomes highlighted. Then press the **ENT** key.

To return to the SYSTEM MENU, press the **C** key.

### NOTE Preparation for Copying between the BHTs

Before downloading to the BHT from another BHT, make the following preparation:

- At each BHT, set the interface port. The default is an optical interface (Optical).

Interface setting procedure: Starting on the SYSTEM MENU, select "4:SET SYSTEM," "5:COMMUNICATION," and "3:COM PORT." On the SET COM DEFAULT PORT screen, select the optical interface (Optical) or direct-connect interface (Connector) of "2:SYSTEM MODE."

- When using the direct-connect interface, pull out the connector cover on each BHT to expose the direct-connect interface port. Connect the BHTs via those ports with the direct-connect interface cable (having 3-pole mini stereo plugs). For the details about the cable, refer to Chapter 3, Section 3.3.
- On the uploading BHT, run System Mode and select "3:UPLOAD" and "3:HT<-->HT COPY."



Data that can be copied from one BHT to another BHT

The copying function between BHTs copies the following set data:

---

LCD contrast level  
 Beeper volume  
 Switching between beeper and vibrator  
 Execution program to be run automatically when the BHT is turned on  
 Message version (English or Japanese)

---

Display font size  
 Date  
 Time  
 Setting of black-and-white inverted label reading function  
 Decode level

---

Minimum number of digits to be read for ITF  
 Minimum number of digits to be read for STF  
 Minimum number of digits to be read for Codabar (NW-7)  
 Interface port to be used in user programs  
 Interface port to be used in System Mode

---

Communications parameters for the optical interface  
 Communications parameters for the direct-connect interface  
 Communications protocol options for the optical interface  
 Communications protocol options for the direct-connect interface  
 Communications protocol type

---

Shift key function defined  
 M1 key function defined  
 M2 key function defined  
 M3 key function defined  
 M4 key function defined

---

Resume function  
 IP address of FTP server  
 User name of FTP server  
 Password of FTP server  
 Default directory for FTP server

---

FTP option, Line delimiters (CR/LF)  
 FTP option, Treatment of line delimiters  
 FTP option, Treatment of trailing spaces in data filelds  
 FTP option, Upload mode  
 FTP option, Verbose mode

---

IP address of host computer for ping  
 Data size of echo request  
 Echo request intervals  
 Timeout period for echo request  
 No. of echo requests to be sent

---

Echo request send timing  
 Setting of remote wakeup  
 Transmission speed for remote wakeup  
 CPU performance

---

Domain	BHT-7500S only
Security ID	BHT-7500S only

---

Service Set ID (SSID)	BHT-7500W only
Power save mode for wireless module	BHT-7500W only
Authentication system	BHT-7500W only
WEP (Wired Equivalent Privacy)	BHT-7500W only

---

## Download screens

```
DOWNLOAD FILE

** Waiting **
```



```
DOWNLOAD FILE

** Loading **
```



```
DOWNLOAD FILE

XXXXXXXXX.XXX
** Loading **

XXXXXX/YYYYY
```

```
DOWNLOAD FILE

XXXXXXXXX.XXX
** Completed **
```

With this screen displayed, the BHT waits for a file to be downloaded.

If you select "2:HT<-->HT" on the DOWNLOAD menu, the "HT<-->HT" will appear in the center of the 2nd line. If you select "1:FILE," nothing will appear on the 2nd line.

The screen at left shows that "1:FILE" has been selected.

Upon start of optional Ir-Transfer Utility C/Ir-Transfer Utility E/Transfer Utility or equivalent program (upon receipt of an ENQ code from the host computer), the BHT displays the screen shown at left. (Refer to the "Ir-Transfer Utility C Guide"/"Ir-Transfer Utility E Guide"/"Transfer Utility Guide.")

While the downloading operation is in progress, the screen shown at left is displayed indicating the file name and the number of received records/the total number of records.

To abort the downloading operation, press the **C** key. The screen will switch back to the DOWNLOAD menu.

Upon completion of downloading, the number of received records becomes equal to the total number of records and the beeper beeps once. Press the **C** key to return to the DOWNLOAD menu.

If the host computer downloads another new file (if the BHT receives an ENQ code) when this screen is displayed, the BHT starts receiving it.

(Refer to the "Ir-Transfer Utility C Guide"/"Ir-Transfer Utility E Guide"/"Transfer Utility Guide.")

If you have selected "2: HT<-->HT COPY" on the DOWNLOAD menu, a sequence of the above screens will be repeated by the number of files to be downloaded.

## If an error occurs during downloading

If some error occurs during downloading, the BHT beeps three times and shows one of the following screens with the prompt "Retry?":

To retry the download, press the **[1]** and **[ENT]** keys; to abort it, press the **[2]** and **[ENT]** keys.

```

DOWNLOAD FILE

Out of memory!!

Retry?
  1:Yes 2:No

```

### ■ Problem

The memory is insufficient for storing files to be downloaded.

### ■ Solution

Press the **[2]** key to return to the SYSTEM MENU, then delete unnecessary files in the memory or decrease the size of the file to be downloaded. (Refer to Subsection 2.5.3, [ 9 ] and [ 2 ].)

```

DOWNLOAD FILE

Too many files!!

Retry?
  1:Yes 2:No

```

### ■ Problem

The current download will exceed the maximum of 80 files in the memory.

### ■ Solution

Press the **[2]** key to return to the SYSTEM MENU. Delete unnecessary files in memory or decrease the number of files to be downloaded if you attempted to download more than one file. (Refer to Subsection 2.5.3, [ 9 ] and [ 2 ].)

```

DOWNLOAD FILE

XXXXXXXX.XXX
Communication error!!

Retry?
  1:Yes 2:No

```

### ■ Problem

Downloading has failed.

### ■ Solution

To retry downloading, press the **[1]** key.

To return to the SYSTEM MENU, press the **[2]** key. Check the interface port, communications parameters, and communications protocol type in the SET SYSTEM menu or perform the communications test in the TEST menu. (Refer to Subsection 2.5.3, [4.5] and [5.5].)

It is also necessary to check the communications parameters setup of the host computer.

```
DOWNLOAD FILE
XXXXXXXXX.XXX
Program file error!!

Retry?
  1:Yes 2:No
```

■ **Problem**

You attempted to download an invalid program file.

■ **Solution**

Check whether the program file you attempted to download is available to your BHT model. If it is not available, download the appropriate program.

## [ 3 ] Uploading

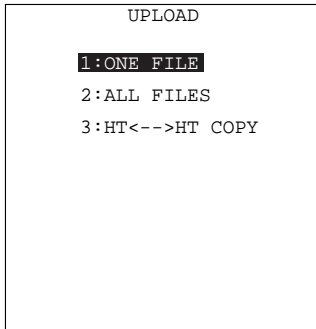

Selecting "3: UPLOAD" on the SYSTEM MENU calls up the screen shown at left.

- 1 ONE FILE : Uploads a user program file or data file stored in the memory.
- 2 ALL FILES : Uploads all user program files (object programs) and all data files stored in the memory.
- 3 HT<-->HT COPY : Uploads all of the files, system parameters, and calendar clock data stored in the BHT, to another BHT.

This function enables copying between the BHTs. At the receiving BHT, select "2: DOWNLOAD" and "2: HT<-->HT COPY" in System Mode.

For the preparation to be made preceding the start of this function, refer to NOTE given on page 46.

Select a desired item by using the numerical keys or and keys, and the selected item becomes highlighted. Then press the key.

To return to the SYSTEM MENU, press the key.

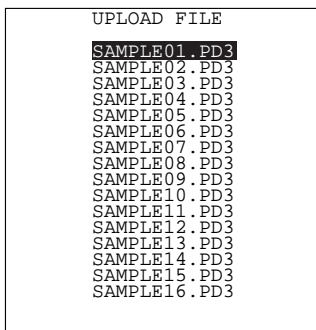

If you select "1:ONE FILE" on the UPLOAD menu, the file selection screen as shown at left will appear, listing all of the program files and data files stored in the memory. Select a file(s) you want to upload and press the key.

If you select "2:ALL FILES" or "3:HT<-->HT COPY" on the UPLOAD menu, the "ALL" or "HT<-->HT" will appear in the center of the 2nd line, respectively.

```
UPLOAD FILE
*****
* NO FILE EXISTS *
*****
```

If you select "1:ONE FILE" or "2:ALL FILES" on the UPLOAD menu when no files are stored in the memory, the message shown at left will appear.

Pressing the **C** key returns to the UPLOAD menu.

### Upload screens

```
UPLOAD FILE

** Waiting **
```

If you select "1:ONE FILE" and choose a file to be uploaded or if you select the "2:ALL FILES" or "3:HT<-->HT COPY" on the UPLOAD menu, then the screen shown at left will appear.

If you select "2:ALL FILES" or "3:HT<-->HT COPY," the "ALL" or "HT<-->HT" will appear in the center of the 2nd line, respectively.

Showing this screen, the BHT waits for a file(s) to be uploaded.



```
UPLOAD FILE

** Loading **
```

Upon start of optional Ir-Transfer Utility C/Ir-Transfer Utility E/Transfer Utility or equivalent program (upon receipt of an ACK code from the host computer), the BHT displays the screen shown at left.

(Refer to the "Ir-Transfer Utility C Guide"/"Ir-Transfer Utility E Guide"/"Transfer Utility Guide.")



```
UPLOAD FILE

SAMPLE01.PD3
** Loading **

XXXXX/YYYYY
```

While the uploading operation is in progress, the screen shown at left is displayed indicating the file name and the number of sent records/the total number of records.

To abort the uploading operation, press the **C** key. The screen will switch back to the UPLOAD menu.





```

UPLOAD FILE

SAMPLE01.PD3
** Completed **

```

Upon completion of uploading, the number of sent records becomes equal to the total number of records and the beeper beeps once. Press the **C** key to return to the UPLOAD menu.

If you have selected "2:ALL FILES" or "3:HT<-->HT COPY" on the UPLOAD menu, a sequence of the above screens will be repeated by the number of files to be uploaded.

### **If an error occurs during uploading**

If some error occurs during uploading, one of the following screens will appear and the beeper beeps three times.

To retry the uploading operation, press the **1** and **ENT** keys; to abort it, press the **2** and **ENT** keys.

```

UPLOAD FILE

XXXXXXXX.XXX
File error!!

Upload?
1:Yes 2:No

```

#### ■ Problem

The file you attempted to upload is damaged.

#### ■ Solution

To upload the damaged file as is, press the **1** key.

```

UPLOAD FILE

XXXXXXXX.XXX
Communication error!!

Retry?
1:Yes 2:No

```

#### ■ Problem

Uploading has failed.

#### ■ Solution

To retry uploading, press the **1** key.

To return to the SYSTEM MENU, press the **2** key. Check the interface port, communications parameters, and communications protocol type in the SET SYSTEM menu or perform the communications test in the TEST menu. (Refer to Subsection 2.5.3, [4.5] and [5.5].)

It is also necessary to check the communications parameters setup of the host computer.

## [ 4 ] System Environment Setting

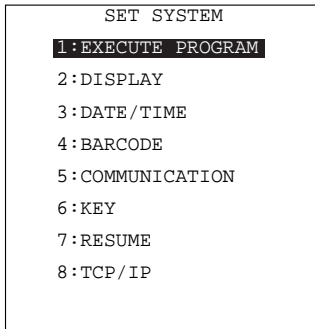

("8:TCP/IP" supported by the BHT-7500S/7500W only)

Selecting "4: SET SYSTEM" on the SYSTEM MENU calls up the screen shown at left.

**1** EXECUTE PROGRAM : Sets an execution program to be run when the power is turned on.

**2** DISPLAY : Sets the message version (English or Japanese).

**3** DATE/TIME : Sets the calendar clock (date and time).

**4** BARCODE : Sets the special barcode scanning parameters (the black-and-white inverted label reading and the decoding level) and the minimum number of digits to be read for bar codes (ITF, STF and Codabar).

**5** COMMUNICATION : Sets the communications environments (interface port and communications parameters).

**6** KEY : Defines the functions of the shift key and magic keys.

**7** RESUME : Sets the resume function.

**8** TCP/IP : Sets the TCP/IP and FTP.  
(BHT-7500S/7500W only)

Select a desired item by using the numerical keys or **▲** and **▼** keys, and the selected item becomes highlighted. Then press the **ENT** key.

Press the **C** key to return to the SYSTEM MENU.

## [4.1] Setting an execution program

```
SET EXECUTE PROGRAM
EASYPACK.PD3
SAMPLE1.PD3
SAMPLE2.PD3
SAMPLE3.PD3
SAMPLE4.PD3
```

Selecting "1: EXECUTE PROGRAM" on the SET SYSTEM menu calls up the screen shown at left.

Highlighted is the current setting.

Use the ▲ and ▼ keys to move the cursor to a desired execution program to be run when the power is applied, and then press the ENT key.

To return to the SET SYSTEM menu, press the C key.

```
SET EXECUTE PROGRAM
*****
* NO FILE EXISTS *
*****
```

If no program files are stored in the memories, the screen shown at left will appear.

To return to the SET SYSTEM menu, press the C key.

## [4.2] Setting the message version

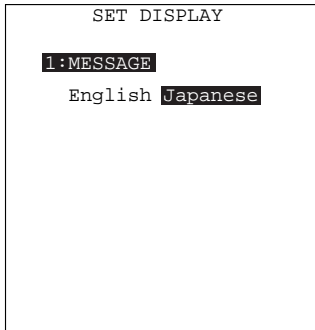

Selecting "2: DISPLAY" on the SET SYSTEM menu calls up the screen shown at left.

Highlighted is the current setting.

**1** MESSAGE: Switches the message version to English or Japanese for system error messages and indications on the LCD contrast, beeper volume, and beeper & vibrator switching screen. (The default is the message version that you selected in the initializing sequence.)

Select a desired setting by using the ◀ and ▶ keys.

Press the **ENT** key.

To return to the SET SYSTEM menu, press the **C** key.

### [4.3] Setting the calendar clock

```

SET DATE/TIME
00/01/01 00:00
_ / / :

```



```

SET DATE/TIME
00/01/01 00:00
00/04/19 16:00_

```



```

SET DATE/TIME
00/04/19 16:00
_ / / :

```

Selecting "3:DATE/TIME" on the SET SYSTEM menu calls up the screen shown at left.

Use the numerical keys to enter the year (only the last two digits), month, day, hour, and minute in this order, and then press the **ENT** key. If the data is in one digit, add a 0 (zero) preceding the data.

#### **NOTE**

For the year, be sure to enter the last two digits of the year. For the hour, enter it in the 24-hour format.

If any of the year, month, day, hour, and minute is not entered, the **ENT** key will be deactivated.

If you make a wrong entry, press the **BS** key (**SF** + **C** keys) to delete it and then enter the correct data.

To return to the SET SYSTEM menu, press the **C** key.

[Example] To set 2000, April 19, at 4:00 p.m.

Press **0**, **0**, **0**, **4**, **1**, **9**, **1**, **6**, **0**, and **0**.

Press the **ENT** key to register the above setting.

## [4.4] Setting the special bar-code scanning parameters

SET BARCODE	
1: INVERT	ON OFF
2: DECODE LEVEL	x
MINIMUM DIGITS	
3: ITF	xx
4: STF	xx
5: CODABAR	xx

Selecting "4: BARCODE" on the SET SYSTEM menu calls up the screen shown at left.

Highlighted is the current setting.

- 1 INVERT : Activates or deactivates the black-and-white inverted label reading function.
- 2 DECODE LEVEL : Sets the decode level.
- 3 ITF : Sets the minimum number of digits to be read for ITF.
- 4 STF : Sets the minimum number of digits to be read for STF.
- 5 CODABAR : Sets the minimum number of digits to be read for Codabar.

Select a desired item by using the numerical keys or  and  keys, and then select a desired setting by using the  and  keys.

To increase the decode level, press the  key; to decrease it, press the  key.

To increase the number of digits to be read for ITF, STF and Codabar, press the  key; to decrease it, press the  key.

Press the  key.

To return to the SET SYSTEM menu, press the  key.

### **Black-and-white inverted label reading function (INVERT)**

This function makes it possible to read white bars on a black background.

#### **NOTE**

Activating this function might increase the frequency of bar-code reading errors. This function can usually be set to OFF.

### **DECODE LEVEL**

You may set the decode level. Decreasing the level value increases the bar-code reading efficiency, but the BHT might misread low-quality bar codes (split or stained). To the contrary, increasing the level value decreases the bar-code reading efficiency, but it will diminish the possibility of misreading.

The setting range of the level value is from 1 to 9 and the default is 4.

**Minimum number of digits to be read for ITF, STF, or Codabar (MINIMUM DIGITS)**

You may set the minimum number of digits to be read for ITF, STF, and Codabar. Setting a small number of digits increases the frequency of digit-missing reading or misreading depending upon how to scan bar codes or the quality of bar codes. On the other hand, setting a large number will diminish the possibility of those errors.

The setting range is from 2 to 20 for ITF, from 1 to 20 for STF, and from 3 to 20 for Codabar. The default is 4 for ITF and Codabar, and 2 for STF.

## [4.5] Setting the communications environments

After the BHT is initialized, the interface port and communications parameters are set as listed in the default table below. Do not access them unless necessary.

Interface port	Optical (Optical interface port)
Communications protocol	BHT-protocol
Communications parameters for the optical interface port	Defaults
TRANSMIT SPEED	9600 bps
PROTOCOL (Protocol options)	SERIAL No.: ON (Adds serial numbers to data blocks.)
	H. PARITY: ON (Adds a horizontal parity.)
	LINKUP TIME: 30 seconds
	FIELD SPACE: Ignore

Listed below are the default communications parameters for the direct-connect interface.

Communications parameters for the direct-connect interface port	Defaults
TRANSMIT SPEED	19200 bps
PARITY BIT (Vertical parity)	None
DATA BIT (Character length)	8 bits
STOP BIT	1 bit
PROTOCOL (Protocol options)	SERIAL No.: ON (Adds serial numbers to data blocks.)
	H. PARITY: ON (Adds a horizontal parity.)
	LINKUP TIME: 30 seconds
	FIELD SPACE: Ignore



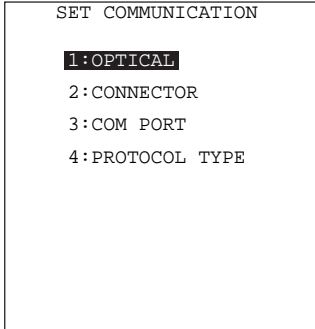

Selecting the "5: COMMUNICATION" on the SET SYSTEM menu calls up the screen shown at left.

- 1 OPTICAL: Switches to the communications parameters setting screen *for the optical interface*.
- 2 CONNECTOR: Switches to the communications parameters setting screen *for the direct-connect interface*.
- 3 COM PORT: Switches to the interface port setting screen.
- 4 PROTOCOL TYPE: Switches to the communications protocol type setting screen.

Select a desired screen by using the numerical keys or ▲ and ▼ keys, and then press the ENT key.

To return to the SET SYSTEM menu, press the C key.

#### **[4.5-1] Setting the communications parameters for the optical interface**

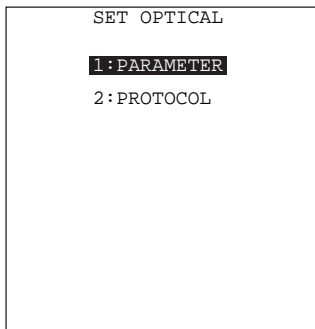

Selecting "1:OPTICAL" on the SET COMMUNICATION menu calls up the screen shown at left.

- 1 PARAMETER: Switches to the communications parameters setting screen.
- 2 PROTOCOL: Switches to the communications protocol option screen.

Select a desired screen by using the numerical keys or ▲ and ▼ keys, and then press the ENT key.

To return to the SET COMMUNICATION menu, press the C key.

### (1) Communications parameters setting screen

```
SET PARAMETER
< OPTICAL >
1: TRANSMIT SPEED:
  2400  9600  19200
 38400 57600 115200
```

Selecting "1:PARAMETER" on the SET OPTICAL screen calls up the screen shown at left.

Highlighted is the current setting.

Select the desired transmission speed by using the numerical keys or ◀ and ▶ keys, and then press the **ENT** key.

To return to the SET OPTICAL screen, press the **C** key.

### (2) Communications protocol option screen

```
SET PROTOCOL
< OPTICAL >
1: SERIAL No. : ON OFF
2: H. PARITY  : ON OFF
3: LINKUP TIME:
  None 30 60 90 120
4: FIELD SPACE:
  Ignore Data
```

Selecting "2: PROTOCOL" on the SET OPTICAL screen calls up the screen shown at left.

Highlighted is the current setting.

**1** SERIAL No.: Selects whether or not the system will add serial numbers to data blocks.

**2** H. PARITY: Selects whether or not the system will add a horizontal parity.

**3** LINKUP TIME: Selects the timeout length (in seconds) to be applied when a link is to be established.

**4** FIELD SPACE: Selects whether space codes in the tail of a data field will be ignored or handled as data.

Select a desired item by using the numerical keys or ▲ and ▼ keys. Then select a desired setting by using the ◀ and ▶ keys.

To return to the SET OPTICAL screen, press the **C** key.

#### **NOTE**

If the BHT-Ir protocol has been selected, the serial number and horizontal parity settings will be ignored.

**[4.5-2] Setting the communications parameters for the direct-connect interface**

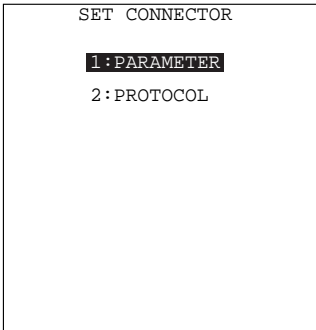

Selecting "2:CONNECTOR" on the SET COMMUNICATION menu calls up the screen shown at left.

- 1 PARAMETER: Switches to the communications parameters setting screen.
- 2 PROTOCOL: Switches to the communications protocol option screen.

Select a desired screen by using the numerical keys or **▲** and **▼** keys, and then press the **ENT** key.

To return to the SET COMMUNICATION menu, press the **C** key.

(1) Communications parameters setting screen

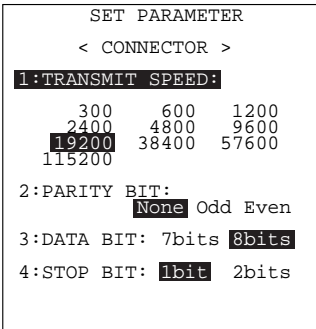

Selecting "1:PARAMETER" on the SET CONNECTOR screen calls up the screen shown at left.

Highlighted is the current setting.

- 1 TRANSMIT SPEED: Sets the transmission speed.
- 2 PARITY BIT: Sets the vertical parity: none, odd, or even.
- 3 DATA BIT: Sets the character length.
- 4 STOP BIT: Sets the stop bit length.

Select a desired item by using the numerical keys or **▲** and **▼** keys. Then select a desired setting by using the **◀** and **▶** keys.

To return to the SET CONNECTOR screen, press the **C** key.

**NOTE** If the BHT-Ir protocol has been selected, the parity bit, character length, and stop bit length settings will be ignored.

## (2) Communications protocol option screen

```
SET PROTOCOL
< CONNECTOR >
1:SERIAL No. : ON OFF
2:H.PARITY   : ON OFF
3:LINKUP TIME:
  None 30 60 90 120
4:FIELD SPACE:
  Ignore Data
```

Selecting "2:PROTOCOL" on the SET CONNECTOR screen calls up the screen shown at left.

Highlighted is the current setting.

- 1 SERIAL No.: Selects whether or not the system will add serial numbers to data blocks.
- 2 H. PARITY: Selects whether or not the system will add a horizontal parity.
- 3 LINKUP TIME: Selects the timeout length (in seconds) to be applied when a link is to be established.
- 4 FIELD SPACE: Selects whether space codes in the tail of a data field will be ignored or handled as data.

Select a desired item by using the numerical keys or  and  keys. Then select a desired setting by using the  and  keys.

To return to the SET CONNECTOR screen, press the  key.

### **NOTE**

If the BHT-Ir protocol has been selected, the serial number and horizontal parity settings will be ignored.



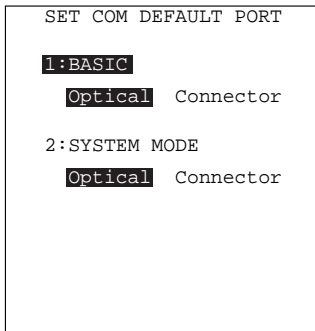

### [4.5-3] Setting the interface port



Selecting the "3:COM PORT" on the SET COMMUNICATION menu calls up the screen shown at left.

Highlighted is the current setting.

- 1 BASIC: Selects the optical or direct-connect interface port to be used *for user programs written in BHT-BASIC (OPEN "COM:").*
- 2 SYSTEM MODE: Selects the optical or direct-connect interface port to be used *for downloading or uploading files in System Mode.*

Select a desired item by using the numerical keys or  and  keys, and then select a desired setting by using the  and  keys.

To return to the SET COMMUNICATION menu, press the  key.

#### [4.5-4] Setting the communications protocol type

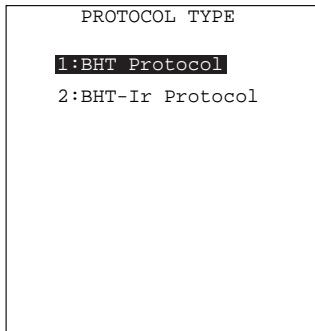

Selecting the "4:PROTOCOL TYPE" on the SET COMMUNICATION menu calls up the screen shown at left.

Highlighted is the current setting.

**1** BHT Protocol: Selects the BHT-protocol for downloading or uploading files in System Mode or for the execution of XFILE statement in BHT-BASIC.

This protocol should be selected for file transmission with Transfer Utility.

**2** BHT-Ir Protocol: Selects the BHT-Ir protocol for downloading or uploading files in System Mode or for the execution of XFILE statement in BHT-BASIC.

This protocol should be selected for file transmission with Ir-Transfer Utility C/Ir-Transfer Utility E.

Select a desired item by using the numerical keys or **▲** and **▼** keys, and then press the **ENT** key.

To return to the SET COMMUNICATION menu, press the **C** key.

```
SET ID
00001 >> _
```

Selecting the "2:BHT-Ir Protocol" on the PROTOCOL TYPE screen calls up the screen shown at left.

Enter the ID number of the BHT by using the numerical keys, and then press the **ENT** key. If you do not need to modify the current setting, press the **ENT** key only.

**NOTE**

An ID number should be five-digit decimal character string. The entry range is from 00001 to 65535. If the entry value is less than five digits, the **ENT** key will be deactivated.

```
SET ID
00001 >> 65535_
```

If you make a wrong entry, press the **BS** key (**SF** + **C** keys) to delete it and then enter the correct data.

To return to the SET COMMUNICATION menu, press the **C** key.

## [4.6] Defining the functions of the shift key and magic keys

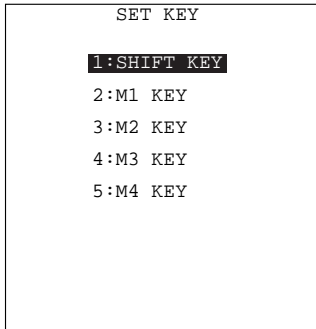

Selecting the "6:KEY" on the SET SYSTEM menu calls up the screen shown at left.

Highlighted is the current setting.

- 1 SHIFT KEY: Switches to the shift key definition screen.
- 2 M1 KEY: Switches to the M1 key definition screen.
- 3 M2 KEY: Switches to the M2 key definition screen.
- 4 M3 KEY: Switches to the M3 key (left-hand trigger switch) definition screen.
- 5 M4 KEY: Switches to the M4 key (right-hand trigger switch) definition screen.

Select a desired screen by using the numerical keys or **▲** and **▼** keys, and then press the **ENT** key.

To return to the SET SYSTEM menu, press the **C** key.

### Defining the function of the shift key

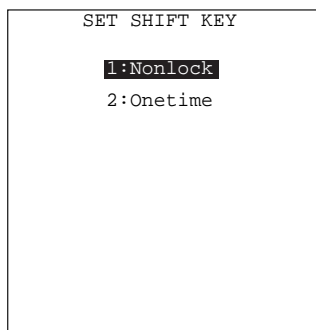

Selecting the "1:SHIFT KEY" on the SET KEY menu calls up the screen shown at left.

Highlighted is the current setting.

- 1 Nonlock: Shifts the keypad only when the **SF** key is held down.
- 2 Onetime: Shifts only one key pressed immediately after the **SF** key is pressed. (The following keys will not be shifted.)

Select a desired setting by using the numerical keys or **▲** and **▼** keys, and then press the **ENT** key. The screen returns to the SET KEY menu.



Defining the function of **M1**, **M2**, **M3** (left-hand trigger switch), or **M4** (right-hand trigger switch) key

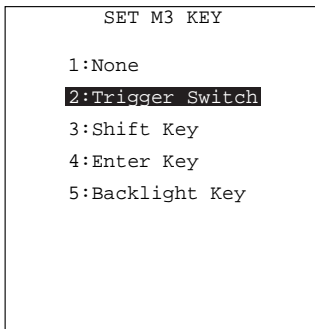

Selecting the "2:M1 KEY," "3:M2 KEY," "4:M3 KEY" or "5:M4 KEY" on the SET KEY menu calls up the screen as shown at left. (This example appears when the "4:M3 KEY" is selected.)

Highlighted is the current setting.

The **M1**, **M2**, **M3** or **M4** key can function as listed below.

- |          |                 |                                       |
|----------|-----------------|---------------------------------------|
| <b>1</b> | None:           | The key entry will be ignored.        |
| <b>2</b> | Trigger Switch: | As the trigger switch.                |
| <b>3</b> | Shift Key:      | As the <b>SF</b> key.                 |
| <b>4</b> | Enter Key:      | As the <b>ENT</b> key.                |
| <b>5</b> | Backlight Key:  | As the backlight function on/off key. |

Select a desired setting by using the numerical keys or **▲** and **▼** keys, and then press the **ENT** key. The screen returns to the SET KEY menu.

### **Magic keys**

The **M3** and **M4** keys are assigned the trigger switch function by default. You can make them function as the **SF** key, **ENT** key, or backlight function on/off key.

If you define the **M1** key as the backlight function on/off key, pressing the **M1** key activates or deactivates the backlight function.

In user programs, a string data can also be assigned to these magic keys.

#### **NOTE**

The backlight function on/off key can be assigned only to any one of **M1** through **M4** keys. The key defined more recently will act as the backlight function on/off key and one defined earlier will be ignored.

That is, if you define the **M1** and **M2** keys as the backlight function on/off key in this order, the **M2** key will work as the backlight function on/off key and the **M1** key's entry will be ignored.

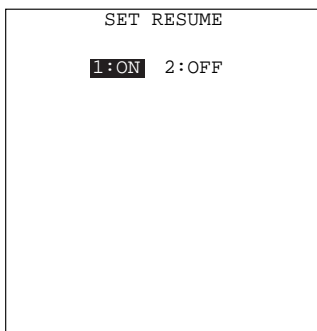

## [4.7] Setting the resume function



Selecting "7: RESUME" on the SET SYSTEM menu calls up the screen shown at left.

Highlighted is the current setting.

- 1 ON : Activates the resume function which resumes the current BHT status when the BHT power was turned off, when the BHT is switched on.
- 2 OFF : Deactivates the resume function.

Select a desired item by using the numerical keys or  and  keys, and then press the  key.

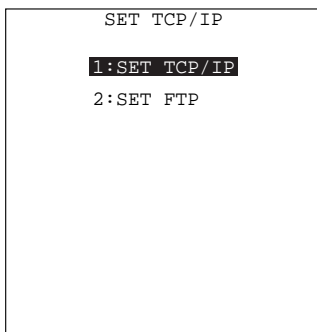

To return to the SET SYSTEM menu, press the  key.

## [4.8] Setting the TCP/IP and FTP (BHT-7500S/7500W only)



Selecting "8:TCP/IP" on the SET SYSTEM menu calls up the screen shown at left.

- 1 SET TCP/IP : Switches to the TCP/IP setting screen.
- 2 SET FTP : Switches to the FTP setting screen.

Select a desired item by using the numerical keys or  and  keys, and then press the  key.

To return to the SET SYSTEM menu, press the  key.

## [4.8-1] Setting the TCP/IP

```
SET ADDRESS
1:IP ADDRESS
  [XXX.XXX.XXX.XXX ]
2:SUBNET MASK
  [YYY.YYY.YYY.YYY ]
3:DEFAULT GATEWAY
  [ZZZ.ZZZ.ZZZ.ZZZ ]
```

Selecting "1:SET TCP/IP" on the SET TCP/IP menu calls up the screen shown at left where the current settings are displayed.

Select a desired item by using the numerical keys or **▲** and **▼** keys, and then press the **ENT** key. The entry box of the selected item becomes ready to accept entry and shows a cursor.

Enter the desired value by using the numerical keys and then press the **ENT** key.

In the entry mode, to delete a single character, press the **BS** key (**SF** + **C** keys). To delete the whole entry you made, press the **C** key.

To return to the SET TCP/IP menu, press the **C** key when any item is highlighted.

## [4.8-2] Setting the FTP

```
SET FTP
1:SERVER
2:OPTION
```

Selecting "2:SET FTP" on the SET TCP/IP menu calls up the screen shown at left.

- 1 SERVER : Switches to the FTP server connection environments screen.
- 2 OPTION : Switches to the data transfer parameters screen.

Select a desired item by using the numerical keys or **▲** and **▼** keys, and then press the **ENT** key.

To return to the SET TCP/IP menu, press the **C** key.

### (1) FTP server connection environments screen

```
SET SERVER
1:SERVER IP
[XXX.XXX.XXX.XXX ]
2:USER ID
[12345ABCDEabcde ]
3:PASSWORD
[*****]
4:DEFAULT DIR
[ ]
```

Selecting "1:SERVER" on the SET FTP menu calls up the screen shown at left where the current settings are displayed.

- 1 SERVER IP : Sets the IP address of an FTP server.
- 2 USER ID : Sets a user name.
- 3 PASSWORD : Sets a password.
- 4 DEFAULT DIR : Specifies an initial directory through which the FTP server will search for files for transfer first when the FTP client gets connected to the server.

Select a desired item by using the numerical keys or **▲** and **▼** keys, and then press the **ENT** key. The entry box of the selected item becomes ready to accept entry and shows a cursor.

Enter the desired value by using the numerical keys and period (.) key and then press the **ENT** key.

Pressing the **SF** key switches the entry mode between the numeric mode (without a guidance) and alphabet mode.

In the entry mode, to delete a single character, press the **BS** key (**SF** + **C** keys). To delete the whole entry you made, press the **C** key.

To return to the SET FTP menu, press the **C** key when any item is highlighted.

**(2) FTP options screen**

```

SET OPTION
1:CR/LF
  CR-LF LF CR None
2:CR/LF CODE PROPERTY
  Control code Data
3:FIELD SPACE
  Ignore Data
4:UPLOAD MODE
  Overwrite Append
5:VERBOSE MODE  ON OFF

```

Selecting "2:OPTION" on the SET FTP menu calls up the screen shown at left where the current settings are displayed.

**1** CR/LF : Specifies line delimiters that should match ones used in the server OS.

**2** CR/LF CODE PROPERTY :  
Selects whether line delimiters inside down-loaded data records will be treated as control codes (record delimiters) or data.

**3** FIELD SPACE : Selects whether space codes in the tail of a downloaded data field will be trimmed or handled as data.

**4** UPLOAD MODE : Selects whether uploaded files will be written over the existing files or appended to them.

**5** VERBOSE MODE : Selects whether reply codes & messages (given on page 94) sent by the FTP server will display on the FTP client or not.

If the VERBOSE MODE is set to OFF, no such replies will display but only the messages (given on page 93) issued by the BHT will appear. If it is set to ON, both will display.

Select a desired item by using the numerical keys or **▲** and **▼** keys. Then select a desired setting by using the **◀** and **▶** keys.

To return to the SET FTP menu, press the **C** key.

## [ 5 ] Testing

TEST	
1	BARCODE
2	MEMORY
3	BEEPER
4	AGING
5	COMMUNICATION
6	LCD
7	KEY & VIBRATION
8	FILE
9	PING

("9:PING" supported by the BHT-7500S/7500W only)

Selecting "5:TEST" on the SYSTEM MENU calls up the screen shown at left.

1 BARCODE : Selects the bar-code reading test.

2 MEMORY : Selects the RAM read/write test.

3 BEEPER : Selects the beeper scale test.

4 AGING : Selects the aging test.

5 COMMUNICATION : Selects the communications test.

6 LCD : Selects the LCD and indicator LED tests.

7 KEY & VIBRATION : Selects the key entry, beeper and vibrator tests.

8 FILE : Selects the file checksum test.

9 PING : Selects PING.  
(BHT-7500S/7500W only)

Select a desired setting by using the numerical keys or ▲ and ▼ keys, and then press the ENT key. The selected test will start.

Highlighted is the currently selected item.

To return to the SYSTEM MENU, press the C key.

### NOTE

If an error occurs in any of the above tests, contact your nearest dealer.

### [5.1] Bar-code reading test

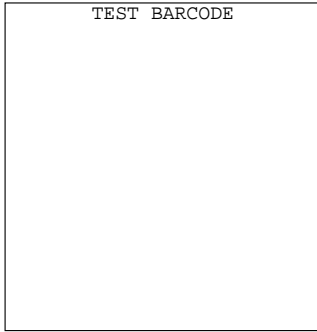

Selecting "1: BARCODE" on the TEST menu calls up the screen shown at left.

Actually read bar codes with the BHT and check the read data displayed on the LCD.

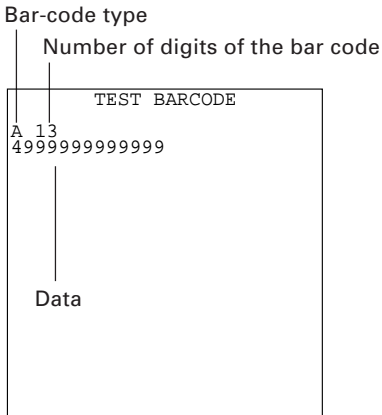

Upon completion of bar-code reading, the BHT beeps, turns on the indicator LED in green, and displays the read data together with the bar-code type and the number of data digits.

Up to 64-digit data can be shown and the excess will be discarded.

To return to the TEST menu, press the **[C]** key.

Listed below is a table showing the relationship between the bar-code types and the identifier letters to be displayed on the LCD.

Bar-code Type	ID Letters
EAN-13, UPC-A	A
EAN-8	B
UPC-E	C
Standard 2of5 (STF)	H
Interleaved 2of5 (ITF)*	I
Codabar	N
Code 39	M
Code 93	L
Code 128	K
EAN-128	W

\* The BHT can read only those ITF bar codes having 4 digits or more in length.

## [5.2] Memory test

```
TEST MEMORY

** Testing **
XXXXX/YYYYY
```

Selecting "2:MEMORY" on the TEST menu calls up the screen shown at left, and then starts writing and reading onto/from all areas of the RAM as well as checking the address.

XXXXX: Tested RAM capacity (in kilobytes)

YYYYY: Total RAM capacity (in kilobytes)

```
TEST MEMORY

** Test NG **
XXXXX/YYYYY
Address : ZZZZZZZZ
Write : AAAAAAAA
Read : BBBBBBBB
```

If any error is detected, the BHT beeps three times, shows the message as shown at left, and terminates the test.

Where,

ZZZZZZZZ: Address where an error has occurred.

AAAAAAA: Data to write.

BBBBBBBB: Data read out from the RAM.

To return to the TEST menu, press the  key.

```
TEST MEMORY

** Test OK **
YYYYY/YYYYY
```

Upon normal completion of the RAM test, the BHT beeps once, shows the message as shown at left, and returns to the TEST menu.

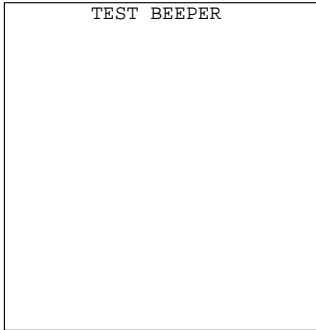

**[5.3] Beeper scale test**

Selecting "3:BEEPER" on the TEST menu calls up the screen shown at left and makes the beeper sound at three octaves listed below.

Upon completion of this test, the BHT automatically returns to the TEST menu.

To stop this test while in progress, turn the power off and on.

Scale	Frequency (Hz)			
	523	1046	2093	4186
do	523	1046	2093	4186
re	587	1174	2349	-
mi	659	1318	2637	-
fa	698	1396	2793	-
sol	783	1567	3135	-
la	880	1760	3520	-
ti	987	1975	3951	-

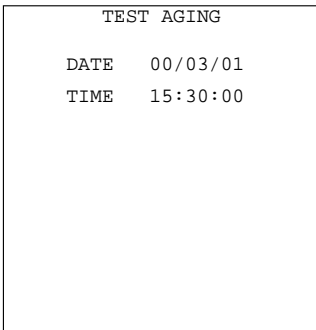
**[5.4] Aging test**

Selecting "4:AGING" on the TEST menu proceeds to the aging test while showing the current date and time on the LCD. (This test is intended for personnel which check the BHT in the factory.)

**NOTE**

Once this test is selected, the automatic powering-off function becomes disabled. Be sure to turn the power off or press the C key to return to the TEST menu.

## [5.5] Communications test

In System Mode, you may test the optical interface port and direct-connect interface port.

### ■ Preparation for the optical interface test

Arrange two BHTs, one as a master station and the other as a slave station (to be tested) with their IR ports facing each other as illustrated below. In this test, the slave BHT transmits data to the master BHT and receives the data sent back from the master BHT.

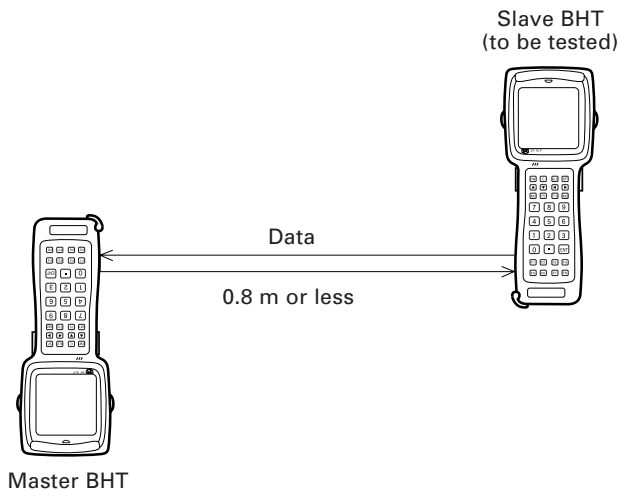

### ■ Preparation for the direct-connect interface test

Arrange the 3-pole mini stereo plug as illustrated below and connect it to the direct-connect interface port on the BHT.

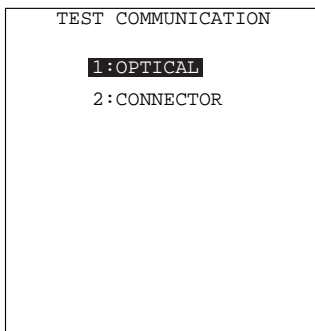
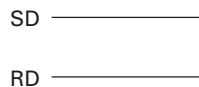

Selecting the "5:COMMUNICATION" on the TEST menu calls up the screen shown at left.

- 1 OPTICAL : Switches to the MASTER/SLAVE selection screen for the optical interface test.
- 2 CONNECTOR : Tests the direct-connect interface port.

Select a desired item by using the numerical keys or ▲ and ▼ keys, then press the ENT key.

## Testing the optical interface port

```

TEST COMMUNICATION
< OPTICAL >
1:SLAVE
2:MASTER
    
```

Selecting the "1:OPTICAL" on the TEST COMMUNICATION menu calls up the screen shown at left.

At the slave BHT to be tested, select the "1:SLAVE" and at the master BHT, select the "2:MASTER." Then press the **ENT** key on each BHT.

```

TEST COMMUNICATION
< OPTICAL >

** Testing **
    
```

During the test, the screen shown at left is displayed.

```

TEST COMMUNICATION
< OPTICAL >

** Test NG **
  (XX)
    
```

If any error occurs, the tested slave BHT beeps three times and shows the screen at left.

In parentheses are error codes which have the following meanings:

(X X)

- 1: The received data is different from the sent data.
- 2: A timeout has occurred during standby for data reception.

- 1: 2400 bps
- 2: 9600 bps
- 3: 115200 bps

Press the **C** key to return to the TEST COMMUNICATION menu.

The master BHT will automatically return to the TEST COMMUNICATION menu after 10 seconds from the occurrence of an error.

```
TEST COMMUNICATION
< OPTICAL >

** Test OK **
```

Upon normal completion of the test, the tested slave BHT beeps once and shows the screen at left.

Press the **[C]** key to return to the TEST COMMUNICATION menu.

The master BHT will automatically return to the TEST COMMUNICATION menu.

### Testing the direct-connect interface port

```
TEST COMMUNICATION
< CONNECTOR >

** Testing **
```

Selecting the "2:CONNECTOR" on the TEST COMMUNICATION menu displays the screen shown at left and then starts testing the direct-connect interface port.

```
TEST COMMUNICATION
< CONNECTOR >

** Test NG **
  (XX)
```

If any error occurs, the BHT beeps three times and shows the screen at left.

In parentheses are error codes which have the following meanings:

(X X)

1: The received data is different from the sent data.

2: A timeout has occurred during standby for data reception.

1: 300 bps

2: 115200 bps

Press the **[C]** key to return to the TEST COMMUNICATION menu.

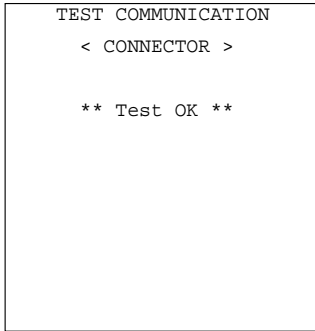

Upon normal completion of the test, the BHT beeps once and shows the screen at left.

Press the **C** key to return to the TEST COMMUNICATION menu.

### [5.6] LCD and indicator LED tests



**BS** key ↑ ↓ **ENT** key

Selecting "6:LCD" on the TEST menu calls up the test pattern shown at left on the LCD and turns on the indicator LED in green.

Each time the **ENT** key is pressed, the screen shifts to the next test pattern. To return to the previous screen, press the **BS** key (**SF**+ **C** keys).

To stop this test while in progress, press the **C** key.

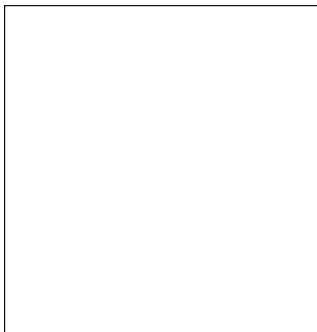

**BS** key ↑ ↓ **ENT** key

As shown at left, everything disappear and the indicator LED lights in red.

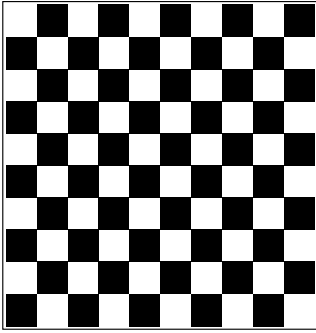

BS key ↑ ↓ ENT key

The checker pattern shown at left appears and the indicator LED goes off.

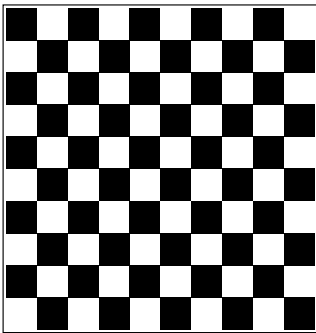

BS key ↑ ↓ ENT key

The checker pattern is reversed.

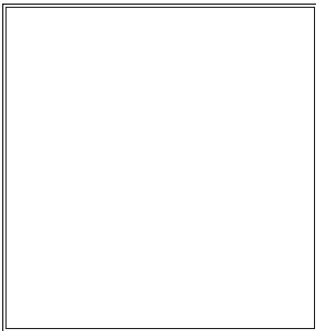

BS key ↑ ↓ ENT key

An outline with a width of one dot appears.

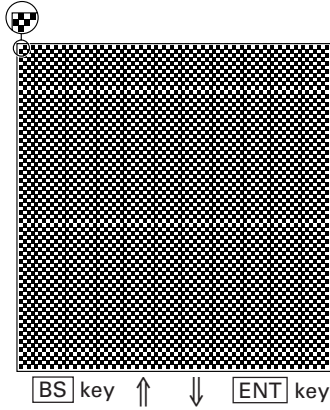

The fine checker pattern appears.

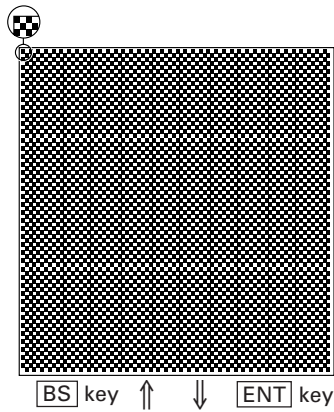

The fine checker pattern is reversed.

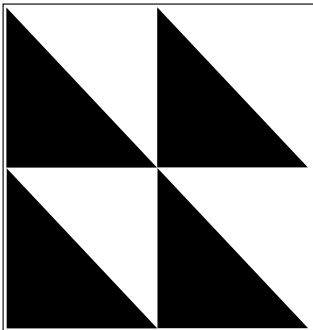

Four right-angled triangles appear.

Press the **ENT** key, and the BHT beeps once and returns to the TEST menu.

## [5.7] Key entry & beeper test

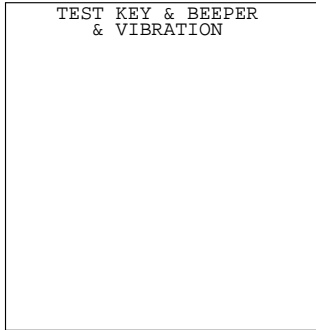

Selecting "7:KEY & VIBRATION" on the TEST menu calls up the screen shown at left and makes the BHT ready for entry from the keypad.

Pressing individual keys displays the identifier letters in the positions pre-assigned to those keys on the LCD as well as sounding the beeper or running the vibrator. (As long as the individual key is held down, the BHT continues beeping or vibrating.)

Pressing the same key again erases the displayed letter.

The table below shows the relationship between the keys, the identifier letters to be displayed on the LCD, and the frequencies (Hz) of the beeper.

Key	Letter	Beeper (Hz)	Key	Letter	Beeper (Hz)	Key	Letter	Beeper (Hz)
C	I	174	M3	T	(Note)	0	0	1567
ALP	J	195	M4	U	(Note)	.	.	1760
SF	K	220	7	7	659	ENT	=	1975
▲	L	246	8	8	698	F1	A	2093
▼	M	261	9	9	783	F2	B	2349
◀	N	293	4	4	880	F3	C	2637
▶	O	329	5	5	987	F4	D	2793
M1	P	349	6	6	1046	F5	E	3135
F9	Q	391	1	1	1174	F6	F	3520
F10	R	440	2	2	1318	F7	G	3951
M2	S	493	3	3	1396	F8	H	4186

(Note) Only when the **M3** (left-hand trigger switch) or **M4** key (right-hand trigger switch) is pressed, the vibrator works.

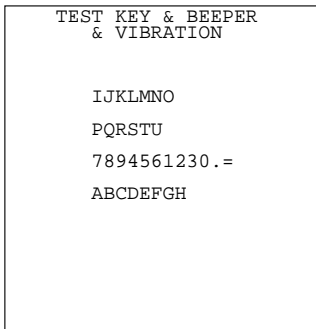

After all keys are pressed and displayed on the LCD, this test automatically ends and the screen returns to the TEST menu.

To stop this test, turn the power off.



**[5.8] File test**

```



TEST FILE
SAMPLE01.PD3
*SAMPLE02.PD3
SAMPLE03.PD3
SAMPLE04.PD3
+SAMPLE05.PD3
SAMPLE06.PD3
SAMPLE07.PD3
SAMPLE08.PD3
SAMPLE09.PD3
SAMPLE10.PD3
SAMPLE11.PD3
SAMPLE12.PD3
SAMPLE13.PD3
SAMPLE14.PD3

SIZE:XXXXX
FREE:YYYYY
    
```

Selecting "8:FILE" on the TEST menu calls up the screen shown at left.

If any of the files stored in the memory is defective, an asterisk (\*) or plus sign (+) will be prefixed to the defective file name(s). For details about the (\*) and (+), refer to Subsection 2.3.7, [ 3 ].

Selecting a file on this screen will show the file size and the test result.

To select a file, use the  and  keys to move the cursor to the desired file. If there are more than 14 files, the screen will scroll.

Highlighted is the currently selected file.

Press the  key to return to the TEST menu.

```

TEST FILE

SAMPLE01.PD3
00004096 bytes
OK

SIZE:XXXXX
FREE:YYYYY
    
```

The file name, file size, and test result (OK or NG) appear as shown at left.

```

TEST FILE

SAMPLE02.PD3
00004096 bytes
NG

SIZE:XXXXX
FREE:YYYYY
    
```

Press the  key to return to the file selection screen.

**NOTE**

If a defective file is found, delete it or overwrite it with the same name file.

Even defective, the file can be uploaded on the UPLOAD menu. It is, therefore, recommended that important files be uploaded before deleted.

## [5.9] Testing with PING (BHT-7500S/7500W only)

```
TEST PING
1:RUN PING
2:SET PING
```

Selecting "9:PING" on the TEST menu calls up the screen shown at left.

- 1 RUN PING : Runs PING.
- 2 SET PING : Switches to the PING parameter setting screen.

Select a desired item by using the numerical keys or **▲** and **▼** keys, and then press the **ENT** key.

To return to the TEST menu, press the **C** key.

### (1) PING screen

(No.-of-echo requests entry screen)

```
RUN PING
DESTINATION IP
XXX.XXX.XXX.XXX
DATA SIZE      XXXXXX
INTERVAL      XXXXXX
TIMEOUT       XXXXXX
SEND TYPE     TYPEn
COUNT       [XXXXX]
```

Selecting "1:RUN PING" on the TEST PING menu calls up the screen shown at left where the current settings are displayed.

The COUNT entry box enclosed with brackets is ready to accept data. If you want to modify the number of echo requests displayed, enter the desired value by using the numerical keys.

To delete a single character, press the **BS** key (**SF** + **C** keys). To delete the whole entry you made, press the **C** key.

Press the **ENT** key to start PING.



(PING running screen)

```
RUN PING
DESTINATION IP
XXX.XXX.XXX.XXX
DATA SIZE      XXXXXX
INTERVAL      XXXXXX
TIMEOUT       XXXXXX
SEND TYPE     TYPEn
COUNT       [XXXXX]

**** PING start ****
OK      : XXXXX [XXXXX]
NG      : XXXXX
TIMEOUT : XXXXX
**** PING end  ****
```

Once PING starts running, the message shown at left will appear.

To stop PING, press the **C** key.

The PING result may include the following:

- OK : Displays the number of echo replies.  
[XXXXX]: Echo reply time in milliseconds
- NG : Displays the number of errors found during execution of PING.
- TIMEOUT : Displays the number of timeouts (for echo replies) that took place during execution of PING.

**PING run-time messages (that will appear in the middle of the LCD)**

Message	Displays when:
Waiting	Setting up PING.
Opening TCP/IP	Opening devices.
Routing TCP/IP	Connecting to the TCP/IP communications pathway.
PING start	Starting PING.
Device error	Failed to open a device.
TCP/IP error	Failed to connect to the TCP/IP communications pathway.

**PING termination messages (that will appear in the bottom of the LCD)**

Message	Displays when:
PING end	PING has ended normally.
PING aborted	PING has aborted.
PING error	An error has occurred during running of PING.

**(2) PING parameters screen**

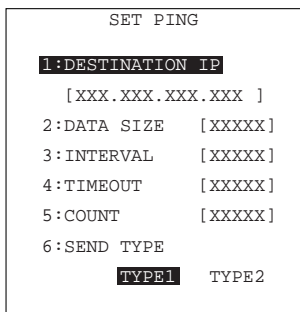

Selecting "2:SET PING" on the TEST PING menu calls up the screen shown at left where the current settings are displayed.

- 1 DESTINATION IP : Specifies the IP address of a host computer that you want to ping.
- 2 DATA SIZE : Specifies the data size of an echo request.
- 3 INTERVAL : Specifies the echo request intervals (in units of 100 ms).
- 4 TIMEOUT : Specifies the timeout period (in units of 100 ms) for an echo request.
- 5 COUNT : Specifies the number of echo requests to be sent.
- 6 SEND TYPE : Selects the echo request send timing TYPE 1 or TYPE 2 (described on page 89).

The entry range for each of "2:DATA SIZE" through "5:COUNT" items is listed on the next page.

Select a desired item by using the numerical keys or ▲ and ▼ keys.

If you select one of "1:DESTINATION IP" through "5:COUNT" items and press the **ENT** key, then the entry box of that item becomes ready to accept entry and a cursor appears. Enter the desired value by using the numerical keys and then press the **ENT** key.

In the entry mode, to delete a single character, press the **BS** key (**SF** + **C** keys). To delete the whole entry you made, press the **C** key.

If "6:SEND TYPE" is selected, use the **◀** and **▶** keys to choose the desired type.

To return to the TEST PING menu, press the **C** key when any item is highlighted.

Entry Range for DATA SIZE, INTERVAL, TIMEOUT, and COUNT

Item	Allowable entry range	Initial value
DATA SIZE	4 to 1472	56
INTERVAL	0 to 65535	10
TIMEOUT	0 to 65535	10
COUNT	0* to 65535	4

\* Specification of zero (0) will set the number of echo requests to be sent to "infinite," keeping sending echo requests (until PING is aborted).

If you specify a value out of the allowable entry range listed above, the nearest value within the range will automatically apply.

PING Echo Request Send Timing (SEND TYPE)

Two types of echo request send timings are available: TYPE 1 and TYPE 2.

■ TYPE 1

After sending an echo request, PING will wait for the period specified by INTERVAL and then send an echo request again. For TYPE 1, the relationship between the INTERVAL and TIMEOUT should be "INTERVAL ≥ TIMEOUT."

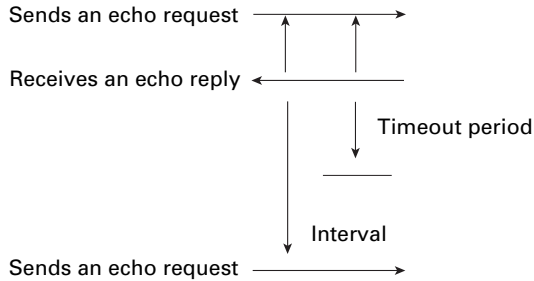

■ TYPE 2

After sending an echo request, PING will wait for an echo reply to be received or for timeout to occur. After that, PING will wait for the period specified by INTERVAL and then send an echo request again. For TYPE 2, no relationship between the INTERVAL and TIMEOUT is required.

If PING receives an echo reply:

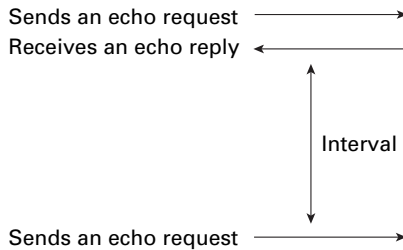

If timeout occurs:

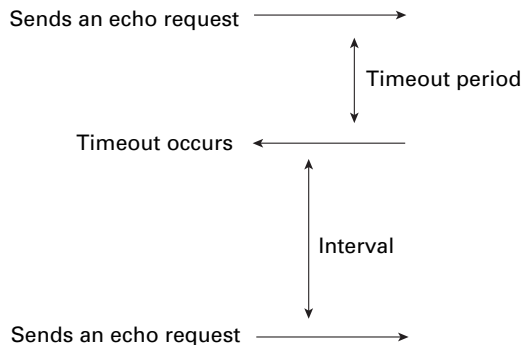

## [ 6 ] System Information

SYSTEM INFORMATION	
SYSTEM Ver.	: x.xx
ROM SIZE	: XMB
RAM SIZE	: XMB
SYSTEM MESSAGE :	
Japanese	x.xx
FONT :	
JIS1 (16)	x.xx
JIS2 (16)	x.xx
JIS1 (12)	x.xx
JIS2 (12)	x.xx

Selecting the "6:VERSION" on the SYSTEM MENU calls up the screen shown at left, displaying the system program version, ROM and RAM sizes, system message version, and JIS font types and their versions.

Press the  key to return to the SYSTEM MENU.

The following font types are displayed:

- JIS1 (16): JIS Level 1 font, 16-dot
- JIS2 (16): JIS Level 2 font, 16-dot
- JIS1 (12): JIS Level 1 font, 12-dot
- JIS2 (12): JIS Level 2 font, 12-dot

## [ 7 ] Downloading/Uploading by FTP (BHT-7500S/7500W only)



Selecting "7:FTP" on the SYSTEM MENU calls up the screen shown at left.

- 1 DOWNLOAD : Downloads a file by FTP.
- 2 UPLOAD : Uploads a file(s) by FTP.

Select a desired item by using the numerical keys or **▲** and **▼** keys, and then press the **ENT** key.

To return to the SET SYSTEM menu, press the **C** key.

### [7.1] Downloading by FTP

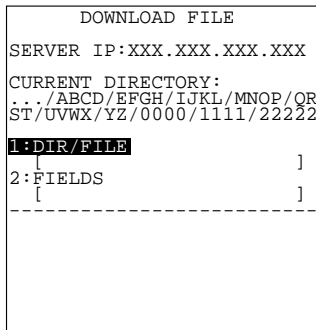

Selecting "1:DOWNLOAD" on the FTP MENU calls up the screen shown at left where the current settings are displayed.

- IP address of an FTP server you have specified
- Current directory reserved
- Entry box for a directory and/or file name
- Entry box for field information of a data file to be downloaded
- Status message

- 1 DIR/FILE : Specifies a directory and/or file name. (For details, refer to the next page.)
- 2 FIELDS : Specifies field information of a data file. (For details, refer to the next page.)

Select a desired item by using the numerical keys or **▲** and **▼** keys, and then press the **ENT** key. The entry box of the selected item becomes ready to accept entry and a cursor appears.

Enter the desired value by using the numerical keys and period (.) key and then press the **ENT** key.

Pressing the **SF** key switches the entry mode between the numeric mode (without a guidance) and alphabet mode.

In the entry mode, to delete a single character, press the **BS** key (**SF** + **C** keys). To delete the whole entry you made, press the **C** key.

To return to the FTP MENU, press the **C** key when any item is highlighted.

**DIR/FILE entry box:** The FTP client will interpret a character string entered into this box as a directory name *at first*, so it will send a Change Directory request to the FTP server. If the specified directory exists in the FTP server, the server will change a directory from the default to that specified one; if not, the FTP client will interpret the entered character string as a file name and send a Download request to the server.

**FIELDS entry box:** Only when downloading a data file, you need to enter field information into this box. Before starting downloading, enter field information by using numerical keys and period (.) key. Pressing the period (.) key will enter a comma (,). For downloading of program files, nothing is required to enter.

## [7.2] Uploading by FTP

```

UPLOAD FILE
SERVER IP:XXX.XXX.XXX.XXX
CURRENT DIRECTORY:
.../ABCD/EFGH/IJKL/MNOP/OR
ST/UVWX/YZ/0000/1111/2222
1:DIR/FILE
2:SELECT FILE
-----

```

Selecting "2:UPLOAD" on the FTP MENU calls up the screen shown at left if a file(s) exists. The current settings are displayed.

- ← IP address of an FTP server you have specified
- ← Current directory reserved
- ← Entry box for a directory and/or file name
- ← File name currently selected (Nothing displays at the initial state of the FTP client.)
- ← Status message

**1** DIR/FILE : Specifies a directory and/or file name. (For details, refer to the next page.)

**2** SELECT FILE : Selects a file to be uploaded. (For details, refer to the next page.)

Select a desired item by using the numerical keys or **▲** and **▼** keys, and then press the **ENT** key.

If you select "1:DIR/FILE," its entry box becomes ready to accept entry and shows a cursor.

Enter the desired value by using the numerical keys and period (.) key, and then press the **ENT** key.

Pressing the **SF** key switches the entry mode between the numeric mode (without a guidance) and alphabet mode.

In the entry mode, to delete a single character, press the **BS** key (**SF** + **C** keys). To delete the whole entry you made, press the **C** key.

To return to the FTP MENU, press the **C** key when any item is highlighted.



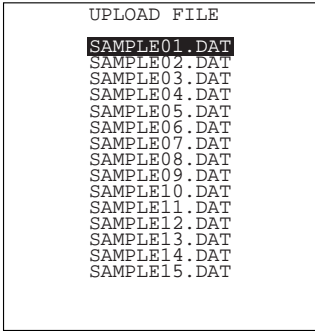

If you select "2:SELECT FILE," the screen shown at left will appear.

Choose a file to be uploaded by using the ▲ and ▼ keys, then press the ENT key. The screen returns to the previous one where the selected file displays in the SELECT FILE entry box.

**DIR/FILE entry box:** The FTP client will interpret a character string entered into this box as a directory name *at first*, so it will send a Change Directory request to the FTP server. If the specified directory exists in the FTP server, the server will change a directory from the default to that specified one; if not, the FTP client will interpret the entered character string as a file name and send an Upload request to the server.

If a file name specified here is different from that specified in the SELECT FILE entry box, then the FTP client will use the file name specified in this entry box for uploading.

If you enter no file name and press the ENT key, then the FTP client will use the file name specified in the SELECT FILE entry box for uploading.

**SELECT FILE entry box:** For uploading, you need to choose a file to be uploaded and display its name in this entry box. Without a file name in this entry box, uploading will result in an error.

If the attributes (e.g., PD3, FN3, EX3, and extensions of data files) of the selected file are different from those specified in the DIR/FILE entry box, then an error will result.

**If no file exists when uploading by FTP is selected**

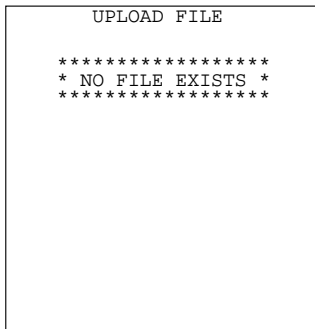

If no file exists in the BHT when you select uploading by FPT, the message shown at left will appear.

Press the C key to return to the FTP MENU.



## **Run-time messages in downloading/uploading by FTP**

When the BHT is uploading or downloading files by FTP, the following messages may appear in the bottom of the LCD:

Messages	Displays when:
Aborted.	Uploading or downloading is interrupted.
Connection error	The communications pathway is disconnected.
Device error	Failed to open a device.
Downloading	Downloading starts.
Download failed	Downloading has abnormally ended.
Download finished	Downloading has finished normally.
File broken!	In uploading, the specified file is broken.
File not found!	In downloading, no file is found.
File not selected	No file is selected.
File type mismatch!	In uploading, the attributes of the file selected in the SELECT FILE entry box are different from those in the DIR/FILE entry box.
FTP error	During execution of an FTP command, an error has occurred.
FTP opened	Connection is established by FTP.
Illegal text format!	The format of a received text is illegal.
Opening device	Opening a device.
Out of memory!	The memory is insufficient for storing files to be downloaded.
Out of range!	The specified parameter(s) is out of the allowable range.
Parameter error!	In downloading, the record length and/or field length specified in the FIELDS entry box exceed 255.
Program file error!	The received program file is illegal.
Routing TCP/IP	Connecting to the TCP/IP communications pathway.
Syntax error!	A syntax error has occurred.
TCP/IP error	Failed to connect to the TCP/IP communications pathway.
TCP socket error	During execution of an FTP command, an error has occurred in the TCP layer.
Too many files!	The current download will exceed the allowable number of files in the memory.
Uploading	Uploading starts.
Upload failed	Uploading has abnormally ended.
Upload finished	Uploading has finished normally.

## **Reply codes from the FTP server**

The messages that FTP servers send during and after FTP operations vary, but servers all use the same reply codes as listed below.

Reply codes	Description
110	Restart marker reply.
120	Service ready in nnn minutes.
125	Data connection already open; transfer starting.
150	File status okay; about to open data connection.
200	Command okay.
202	Command not implemented, superfluous at this site.
211	System status, or system help reply.
212	Directory status.
213	File status.
214	Help message. On how to use the server or the meaning of a particular non-standard command. This reply is useful only to the human user.
215	NAME system type. Where NAME is an official system name from the list in the Assigned Numbers document.
220	Service ready for new users.
221	Service closing control connection. Logged out if appropriate.
225	Data connection open; no transfer in progress.
226	Closing data connection. Requested file action successful (for example, file transfer or file abort).
227	Entering Passive Mode (h1, h2, h3, h4, p1, p2).
230	User logged in, proceed.
250	Requested file action okay, completed.
257	"PATHNAME" created.
331	User name okay, need password.
332	Need account for login.
350	Requested file action pending further information.
421	Service not available, closing control connection. This may be a reply to any command if the service knows it must shut down.
425	Can't open data connection.
426	Connection closed; transfer aborted.
450	Requested file action not taken. File unavailable (e.g., file busy).
451	Requested action aborted: local error in processing.
452	Requested action not taken. Insufficient storage space in system.
500	Syntax error, command unrecognized. This may include errors such as command line too long.
501	Syntax error in parameters or arguments.
502	Command not implemented.
503	Bad sequence of commands.
504	Command not implemented for that parameter.
530	Not logged in.
532	Need account for storing files.
550	Requested action not taken. File unavailable (e.g., file not found, no access).
551	Requested action aborted: page type unknown.
552	Requested file action aborted. Exceeded storage allocation (for current directory or dataset).
553	Requested action not taken. File name not allowed.

## [ 8 ] RF Menu BHT-7500S

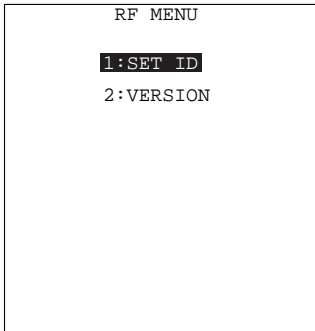

Selecting "8:RF" on the SYSTEM MENU calls up the screen shown at left.

- 1 SET ID : Switches to the ID entry screen.
- 2 VERSION : Switches to the RF version screen.

Select a desired item by using the numerical keys or **▲** and **▼** keys, and then press the **ENT** key.

To return to the SYSTEM MENU, press the **C** key.

### [8.1] ID entry screen

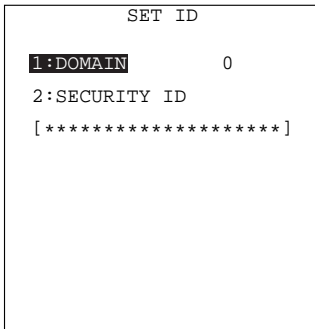

Selecting "1:SET ID" on the RF MENU calls up the screen shown at left.

The "1:DOMAIN" shows the current setting. The "2:SECURITY ID" shows 20 asterisks (\*) to observe secrecy.

- 1 DOMAIN : Sets a network domain name (any of 0 to 15).
- 2 SECURITY ID: Specifies a security ID (max. 20 characters).

Select a desired item by using the numerical keys or **▲** and **▼** keys, and then press the **ENT** key.

For a network domain name, use the **◀** and **▶** keys to select the desired value.

To enter a new security ID code, first press the **ENT** key to switch to the alphanumeric entry mode. A cursor will appear at the tail of the 20 asterisks. Then press the **C** key to clear all 20 asterisks and enter the desired code.

For details about the domains and security IDs, refer to Subsection 3.1.2.

**BHT-7500S**

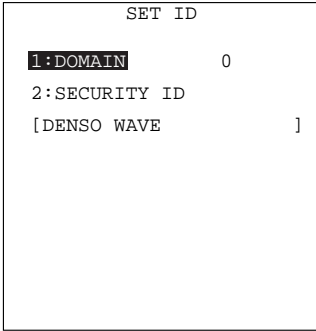

Shown at left is an entry sample screen where a security ID is DENSO WAVE.

After entry, press the **[ENT]** key. Instead of the "DENSO WAVE" entered, 20 asterisks will display.

Pressing the **[SF]** key switches the entry mode between the numeric mode (without a guidance) and alphabet mode.

In the entry mode, to delete a single character, press the **[BS]** key (**[SF]** + **[C]** keys). To delete the whole entry you made, press the **[C]** key.

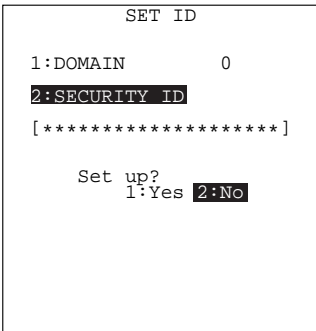

Pressing the **[C]** key when any item is highlighted will display the confirmation message as shown at left.

To save the new entry, choose "1:Yes" and press the **[ENT]** key. The "\*\*\* Now Setting \*\*\*" will appear and the screen will return to the RF MENU.

To cancel the new entry, choose "2:No" and press the **[ENT]** key. The newly entered value will be discarded and the screen will return to the RF MENU.

**NOTE**

When the "\*\*\* Now Setting \*\*\*" displays, the newly entered security ID will be written onto the EEPROM of the wireless module built in the BHT-7500S.

While this message is displayed, do not turn the BHT off. Writing halfway onto the EEPROM will not bring any assured settings.

Be sure to record your security ID. There is no way to read it out from the EEPROM of the wireless module.

As long as you do not set a new security ID, the previous setting will be retained.

When setting a security ID, pressing the **[ENT]** key without entering any character string will set a default value to the EEPROM of the wireless module.

**[8.2] RF version screen**

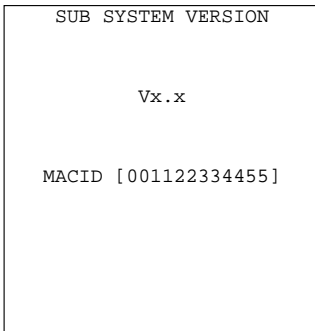

Selecting "2:VERSION" on the RF MENU displays the "\*\*\* Loading \*\*\*" while the system is getting information about the wireless module. After that, the screen shown at left will appear.

Vx.x      Firmware version of the wireless module

MACID    MACID of the wireless module

To return to the RF MENU, press the **C** key.

**If an error occurs for wireless-module parameters or information:**

If some error occurs when the system is saving wireless-module parameters or getting wireless-module information, one of the following screens will appear.

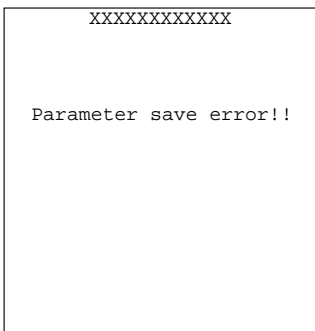

**■ Problem**

The system has failed to save parameters into the wireless module.

XXXXXXXXXXXXX:      Title of a menu where the error occurs.

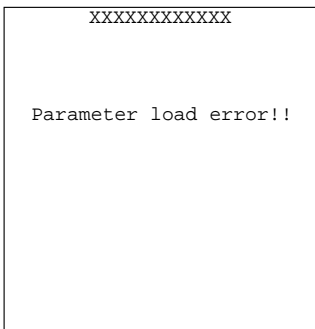

**■ Problem**

The system has failed to read setting from the wireless module.

XXXXXXXXXXXXX:      Title of a menu where the error occurs.

## [ 8 ] RF Menu BHT-7500W

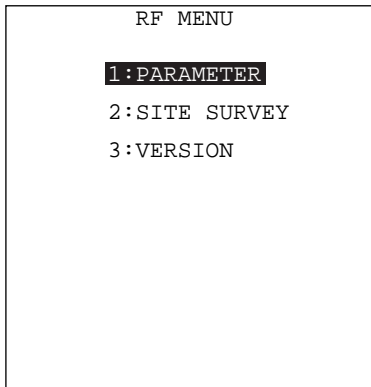

Selecting the "8:RF" on the SYSTEM MENU calls up the screen shown at left.

- 1 PARAMETER Switches to the RF parameter menu.
- 2 SITE SURVEY Switches to the site survey menu.
- 3 VERSION Switches to the RF version screen.

Select a desired item by using the numerical keys or ▲ and ▼ keys, and then press the ENT key.

To return to the SYSTEM MENU, press the C key.

### [8.1] RF parameter menu

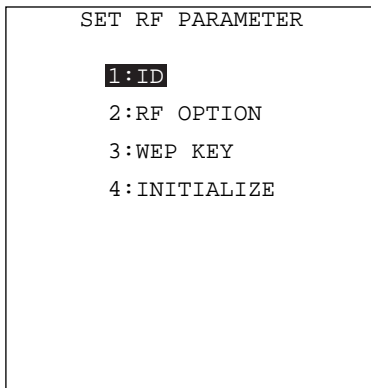

Selecting the "1:PARAMETER" on the RF MENU calls up the screen shown at left.

- 1 ID Switches to the ID entry screen.
- 2 RF OPTION Switches to the RF option screen.
- 3 WEP KEY Switches to the WEP key definition screen.
- 4 INITIALIZE Switches to the RF parameter initialization screen.

Select a desired item by using the numerical keys or ▲ and ▼ keys, and then press the ENT key.

To return to the RF MENU, press the C key.

## [8.1.1] ID entry screen

```

SET ID
1:CLIENT NAME
[
2:SSID
[tsunami
]
]

```

Selecting the "1:ID" on the RF parameter menu displays the "\*\*\* Now Loading \*\*\*." After that, the screen shown at left will appear where the current settings are displayed.

**1** CLIENT NAME Sets a client name that is the BHT name to be used on the network.

**2** SSID Sets a service set ID to be used on the RF communications network.

Select a desired item by using the numerical keys or **▲** and **▼** keys, and then press the **ENT** key. The screen enters the alphanumeric entry mode in which a cursor appears.

Make the desired settings with the numerical keys and period (.) key. To switch the entry mode between the numeric mode (without guidance) and alphabet mode, press the **SF** key. After completion of settings, press the **ENT** key.

In the entry mode, to delete a single character, press the **BS** key (**SF** + **C** keys). To delete the whole entry you made, press the **C** key.

For details about the client name and service set ID, refer to Subsection 3.1.2.

```

SET ID
1:CLIENT NAME
[
2:SSID
[tsunami
]
]

Set up?
1:Yes 2:No

```

Pressing the **ENT** or **C** key when any item is highlighted will display the confirmation message as shown at left.

To save the new entry, choose "1:Yes" and press the **ENT** key. The "\*\*\* Now Setting \*\*\*" will appear and the screen will return to the RF parameter menu.

To cancel the new entry, choose "2:No" and press the **ENT** key. The newly entered data will be discarded and the screen will return to the RF parameter menu.

**NOTE**

When the "\*\*\* Now Setting \*\*\*" is displayed, the new entry will be written onto the EEPROM of the wireless module built in the BHT-7500W.

While this message is displayed, do not turn the BHT off. Writing halfway onto the EEPROM will not bring any assured settings.

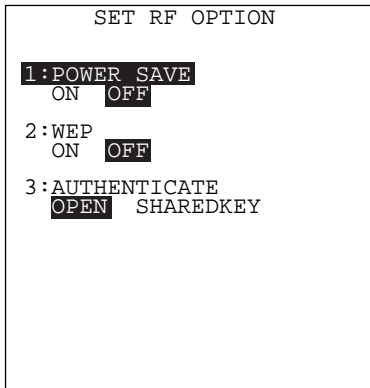

**BHT-7500W****[8.1.2] RF option screen**

Selecting the "2:RF OPTION" on the RF parameter menu displays the "\*\*\* Now Loading \*\*\*." After that, the screen shown at left will appear where the current settings are displayed.

- 1 POWER SAVE Places the wireless module in the energy saving mode.
- 2 WEP Enables or disables the WEP (Wired Equivalent Privacy).
- 3 AUTHENTICATE Sets the authentication system when the WEP is enabled.

Select a desired item by using the numerical keys or **▲** and **▼** keys. Then select a desired setting by using the **◀** and **▶** keys.

For details about the RF parameters, refer to Sub-section 3.1.2.

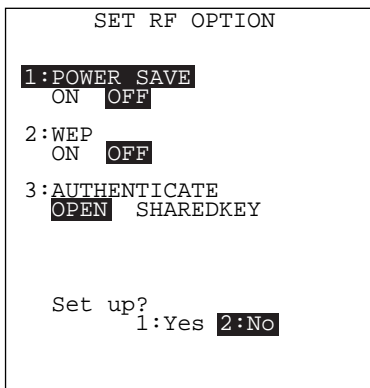

Pressing the **ENT** or **C** key will display the confirmation message as shown at left.

To save the new entry, choose "1:Yes" and press the **ENT** key. The "\*\*\* Now Setting \*\*\*" will appear and the screen will return to the RF parameter menu.

To cancel the new entry, choose "2:No" and press the **ENT** key. The newly entered data will be discarded and the screen will return to the RF parameter menu.

**NOTE**

When the "\*\*\* Now Setting \*\*\*" is displayed, the new entry will be written onto the EEPROM of the wireless module built in the BHT-7500W.

While this message is displayed, do not turn the BHT off. Writing halfway onto the EEPROM will not bring any assured settings.

**[8.1.3] WEP key definition screen**

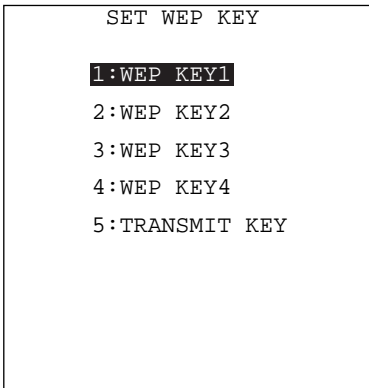

Selecting the "3:WEP KEY" on the RF parameter menu displays the screen shown at left.

- 1 WEP KEY1 Switches to the WEP KEY 1 screen.
- 2 WEP KEY2 Switches to the WEP KEY 2 screen.
- 3 WEP KEY3 Switches to the WEP KEY 3 screen.
- 4 WEP KEY4 Switches to the WEP KEY 4 screen.
- 5 TRANSMIT KEY Switches to the TRANSMIT KEY screen.

Select a desired item by using the numerical keys or  and  keys, and then press the  key.

To return to the RF parameter menu, press the  key.

**BHT-7500W****Defining WEP KEY 1**

```

SET WEP KEY1

1:KEY SIZE
 40 128
2:KEY
 [*****]

```

Selecting the "1:WEP KEY1" on the WEP KEY definition screen displays the "\*\*\* Now Loading \*\*\*." After that, the screen shown at left will appear.

The "1:KEY SIZE" shows the current setting. The "2:KEY" shows asterisks (\*) of the key size to observe secrecy.

Select a desired item by using the numerical keys or **▲** and **▼** keys.

To select the desired key size, use the Use the **◀** and **▶** keys.

To enter the desired WEP key, select the "2:KEY" and then press the **ENT** key. The screen enters the alphanumeric entry mode in which a cursor appears.

You may overwrite the current key with the desired key, but may not edit or delete it.

For details about the WEP key, refer to Subsection 3.1.2.

**NOTE** If no asterisk (\*) appears for the "2:KEY," it means that the BHT-7500W has no WEP key preset. When no WEP key can be defined, the "40" is highlighted for the "1:KEY SIZE."

```

SET WEP KEY1

1:KEY SIZE
 40 128
2:KEY
 [ABCDE12345]

```

Shown at left is an WEP definition screen being halfway through entry. In this example, the WEP key is defined as "ABCDE12345."

An WEP should be a 10- or 26-digit hexadecimal (with 0 through 9 and A through F).

If the key size is 40 or 128, the WEP key should be 10 or 26 digits, respectively.

To switch the entry mode between the numeric mode (without guidance) and alphabet mode, press the **SF** key. After completion of settings, press the **ENT** key.

In the entry mode, to delete a single character, press the **BS** key (**SF** + **C** keys). To delete the whole entry you made, press the **C** key.

```

SET WEP KEYx
1:KEY SIZE
 40 128
2:KEY
 [ABCDE12345 ]

Set up?
 1:Yes 2:No

```

After making any change of settings, press the **C** key with any item highlighted. The confirmation screen will appear as shown at left.

To save the new entry, choose "1:Yes" and press the **ENT** key. The "\*\*\* Now Setting \*\*\*" will appear and the screen will return to the WEP KEY definition screen.

To cancel the new entry, choose "2:No" and press the **ENT** key. The newly entered data will be discarded and the screen will return to the WEP KEY definition screen.

If you make no change, pressing the **C** key with any item highlighted will return to the WEP key definition screen.

**NOTE**

When the "\*\*\* Now Setting \*\*\*" is displayed, the new entry will be written onto the EEPROM of the wireless module built in the BHT-7500W.

While this message is displayed, do not turn the BHT off. Writing halfway onto the EEPROM will not bring any assured settings.

Be sure to record new entry you make. There is no way to read it out from the EEPROM of the wireless module.

As long as you do not set a new WEP key, the previous setting will be retained.

To enable the encryption with an WEP key, you need to set the "2:WEP" ON and choose the SHAREDKEY in the "3:AUTHENTICATE" on the RF option screen.

```

SET WEP KEYx
1:KEY SIZE
 40 128
2:KEY
 [ABCDE123 ]

Set error !

```

If any wrong WEP key is entered (e.g., the entered key is not correct in length or it contains invalid characters other than 0 through 9 and A through F), then the error message will appear as shown at left when you press "1:Yes" to save the new entry.

Enter the correct WEP key.

**Defining WEP KEY 2 through 4**

You may set WEP KEY 2 through 4 the same way as for WEP KEY1.

**BHT-7500W****Setting TRANSMIT KEY**

```

SET TRANSMIT KEY
1:TRANSMIT KEY
  KEY1 KEY2
  KEY3 KEY4

```

Selecting the "5:TRANSMIT KEY" on the WEP KEY definition screen displays the "\*\*\* Now Loading \*\*\*." After that, the screen shown at left will appear.

Select a desired item by using the numerical keys or  and  keys.

For details about the TRANSMIT KEY, refer to Sub-section 3.1.2.

```

SET TRANSMIT KEY
1:TRANSMIT KEY
  KEY1 KEY2
  KEY3 KEY4

Set up?
  1:Yes 2:No

```

Pressing the  key will display the confirmation screen as shown at left.

To save the new entry, choose "1:Yes" and press the  key. The "\*\*\* Now Setting \*\*\*" will appear and the screen will return to the WEP KEY definition screen.

To cancel the new entry, choose "2:No" and press the  key. The newly entered data will be discarded and the screen will return to the WEP KEY definition screen.

**NOTE**

When the "\*\*\* Now Setting \*\*\*" is displayed, the new entry will be written onto the EEPROM of the wireless module built in the BHT-7500W.

While this message is displayed, do not turn the BHT off. Writing halfway onto the EEPROM will not bring any assured settings.

**[8.1.4] RF parameter initialization screen**

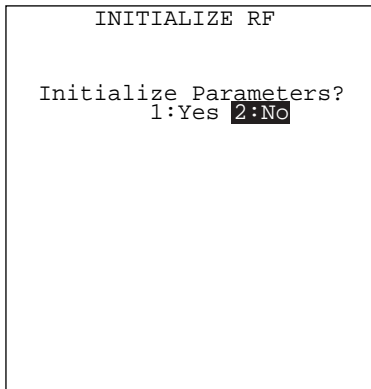

Selecting the "4:INITIALIZE" on the RF parameter menu calls up the screen shown at left.

To initialize the RF parameters, choose "1:Yes" and press the **ENT** key. Initialization will start with the "\*\*\* Initializing \*\*\*" displayed. After completion of initialization, the screen returns to the RF parameter menu.

To cancel initialization, choose "2:No" and press the **ENT** key. The screen will return to the RF parameter menu.

**NOTE**

When the "\*\*\* Initializing \*\*\*" is displayed, the initialized data will be written onto the EEPROM of the wireless module built in the BHT-7500W.

While this message is displayed, do not turn the BHT off. Writing halfway onto the EEPROM will not bring any assured settings.

**NOTE**

Initialization will not initialize WEP keys.

**[8.2] SITE SURVEY menu**

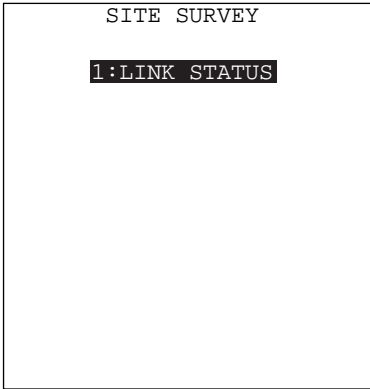

Selecting the "2:SITE SURVEY" on the RF MENU calls up the screen shown at left.

**1** LINK STATUS Switches to the link status screen.

Press the **ENT** key.

To return to the RF MENU, press the **C** key.

**[8.2.1] Link status screen**

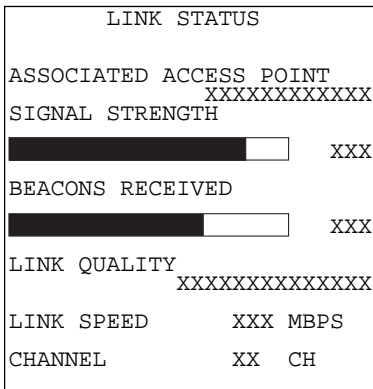

Selecting the "1:LINK STATUS" on the SITE SURVEY menu calls up the screen as shown at left. The current communications link status appears in real-time.

**ASSOCIATED ACCESS POINT**

Displays the MAC address assigned to the wireless interface of the associated access point.

**SIGNAL STRENGTH**

Displays the signal intensity of receive packets.

**BEACONS RECEIVED**

Displays the progress bar that shows the percentage of received beacon packets relative to those to be received.

Beacon: Synchronous signals transmitted periodically from the access point

**LINK QUALITY**

Displays the comprehensive link operation level with the access point.

If the following shows:	Communications state
EXCELLENT	Excellent communications link ↕
GOOD	
FAIR	
POOR	Poor communications link
NOT ASSOCIATED	Not associated with an access point

**LINK SPEED**

Displays the current transmission speed.

**CHANNEL**

Displays the current communications channel.

To return to the SITE SURVEY menu, press the **C** key.

**[8.3] RF version screen**

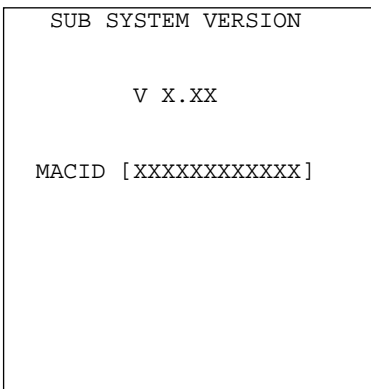

Selecting the "3:VERSION" on the RF MENU displays the "\*\*\* Now Loading \*\*\*" while the system is getting information about the wireless module. After that, the screen shown at left will appear.

V X.XX      Firmware version of the wireless module.

MACID      MACID of the wireless module.

To return to the RF MENU, press the **C** key.



## [ 9 ] Deleting Files

You may delete a program file or data file stored in the memory.

### File deletion menu

```

DELETE FILE
SAMPLE01.PD3
SAMPLE02.PD3
SAMPLE03.PD3
SAMPLE04.PD3
SAMPLE05.PD3
SAMPLE06.PD3
SAMPLE07.PD3
SAMPLE08.PD3
SAMPLE09.PD3
SAMPLE10.PD3
SAMPLE11.PD3
SAMPLE12.PD3
SAMPLE13.PD3
SAMPLE14.PD3
SAMPLE15.PD3
    
```

Pressing the **0** key while holding down the **SF** key on the SYSTEM MENU calls up the screen shown at left.

Use the **▲** and **▼** keys to move the cursor to the file to be deleted, then press the **ENT** key.

Press the **C** key to return to the SYSTEM MENU.

```

DELETE FILE
*****
* NO FILE EXISTS *
*****
    
```

If no file is resident in the memory, the message shown at left appears.

Press the **C** key to return to the SYSTEM MENU.

### Deletion confirmation screen

```

DELETE FILE

SAMPLE01.PD3

Delete? 1:Yes 2:No
    
```

Selecting a file to be deleted and then pressing the **ENT** key calls up the confirmation screen shown at left.

**1** Yes : Deletes the selected file.

**2** No : Cancels deletion and returns to the previous file deletion menu.

Select a desired item by using the numerical keys, then press the **ENT** key.

### Deletion completion screen

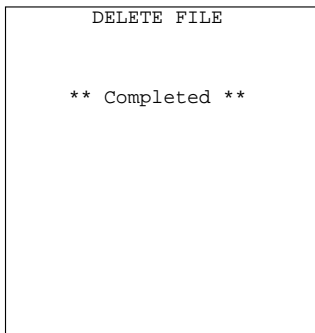

Upon completion of deletion, the screen shown at left appears.

Press the **C** key to return to the file deletion menu.

## [ 10 ] Downloading/Uploading the BHT System Parameter File

SYSTEM PARAMETER transfer menu

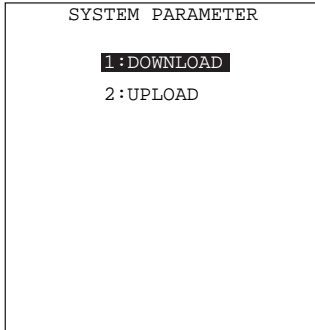

Pressing the **[3]** key while holding down the **[SF]** key on the SYSTEM MENU calls up the screen shown at left.

**[1] DOWNLOAD:** Downloads the BHT system parameter file to the user area of the BHT.

**[2] UPLOAD:** Uploads the BHT system parameter file stored in the BHT.

Select a desired item by using the numerical keys or **[▲]** and **[▼]** keys, then press the **[ENT]** key.

Press the **[C]** key to return to the SYSTEM MENU.

The BHT system parameters that will be downloaded in this menu are listed in Subsection 2.5.3, "[ 2 ] Downloading."

### [10.1] Downloading the BHT system parameter file

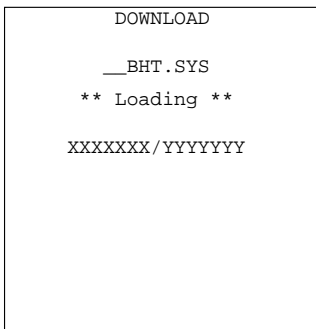
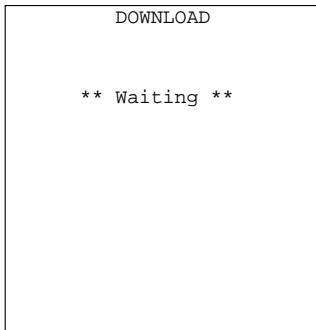

Selecting "1:DOWNLOAD" on the SYSTEM PARAMETER transfer menu calls up the screen shown at left. With this screen displayed, the BHT waits for the BHT system parameter file to be downloaded.

While the downloading operation is in progress, the screen shown at left is displayed indicating the file name and the number of received records/the total number of records.

To abort the downloading operation, press the **[C]** key. The screen will switch back to the SYSTEM PARAMETER transfer menu.

```
DOWNLOAD
  __BHT.SYS
** Completed **
```

Upon completion of downloading, the BHT displays the screen shown at left and beeps once.

Press the **C** key to return to the SYSTEM PARAMETER transfer menu.

### **If an error occurs during downloading**

If some error occurs during downloading, the BHT beeps three times and shows one of the following screens with the prompt "Retry?":

To retry the download, press the **1** and **ENT** keys; to abort it, press the **2** and **ENT** keys.

To return to the SYSTEM PARAMETER transfer menu, press the **C** key.

```
DOWNLOAD
Out of memory!!
Retry? 1:Yes 2:No
```

#### ■ **Problem**

The memory is insufficient for storing the BHT system parameter file to be downloaded.

#### ■ **Solution**

Press the **2** key to return to the SYSTEM MENU, then delete unnecessary files in the memory. (Refer to Subsection 2.5.3, [ 9 ].)

```
DOWNLOAD
File mismatch!!
Retry? 1:Yes 2:No
```

#### ■ **Problem**

You attempted to download a file other than the BHT system parameter file.

#### ■ **Solution**

Check whether the file you attempted to download is a BHT system parameter file.

```
DOWNLOAD FILE

Too many files!!

Retry? 1:Yes 2:No
```

■ **Problem**

The current download will exceed the maximum of 80 files in the memory.

■ **Solution**

Press the **2** key to return to the SYSTEM MENU, then delete unnecessary files in the memory. (Refer to Subsection 2.5.3, [ 9 ].)

```
DOWNLOAD

__BHT.SYS
Communication error!!

Retry? 1:Yes 2:No
```

■ **Problem**

Downloading has failed.

■ **Solution**

To retry downloading, press the **1** key.

To return to the SYSTEM MENU, press the **2** key. Check the interface port, communications parameters, and communications protocol type in the SET SYSTEM menu or perform the communications test in the TEST menu. (Refer to Subsection 2.5.3, [4.5] and [5.5].)

It is also necessary to check the communications parameters setup of the host computer.

## [10.2] Uploading the BHT system parameter file

```
UPLOAD
** Waiting **
```



```
UPLOAD
__BHT.SYS
** Loading **
XXXXXXXX/YYYYYYY
```



```
UPLOAD
__BHT.SYS
** Completed **
```

Selecting "2:UPLOAD" on the SYSTEM PARAMETER transfer menu calls up the screen shown at left. With this screen displayed, the BHT waits for the BHT system parameter file to be uploaded.

While the uploading operation is in progress, the screen shown at left is displayed indicating the file name and the number of sent records/the total number of records.

To abort the uploading operation, press the **C** key. The screen will switch back to the SYSTEM PARAMETER transfer menu.

Upon completion of uploading, the BHT displays the screen shown at left and beeps once.

Press the **C** key to return to the SYSTEM PARAMETER transfer menu.

## If an error occurs during uploading

If some error occurs during uploading, one of the following screens will appear and the beeper beeps three times.

To retry the uploading operation, press the **1** and **ENT** keys; to abort it, press the **2** and **ENT** keys.

Press the **C** key to return to the SYSTEM PARAMETER transfer menu.

```

UPLOAD

Out of memory!!
  
```

### ■ Problem

The memory is insufficient for setting up the BHT system parameter file to be uploaded.

### ■ Solution

Press the **C** key to return to the SYSTEM MENU, then delete unnecessary files in the memory. (Refer to Subsection 2.5.3, [ 9 ].)

```

UPLOAD

Too many files!!
  
```

### ■ Problem

The memory has already contained 80 files, so the BHT system parameter file cannot be set up.

### ■ Solution

Press the **C** key to return to the SYSTEM MENU, then delete unnecessary files in the memory. (Refer to Subsection 2.5.3, [ 9 ].)

```

UPLOAD

__BHT.SYS
Communication error!!

Retry?
  1:Yes 2:No
  
```

### ■ Problem

Uploading has failed.

### ■ Solution

To retry uploading, press the **1** key.

To return to the SYSTEM MENU, press the **2** key. Check the interface port, communications parameters, and communications protocol type in the SET SYSTEM menu or perform the communications test in the TEST menu. (Refer to Subsection 2.5.3, [4.5] and [5.5].)

It is also necessary to check the communications parameters setup of the host computer.

## [ 11 ] Setting the Remote Wakeup

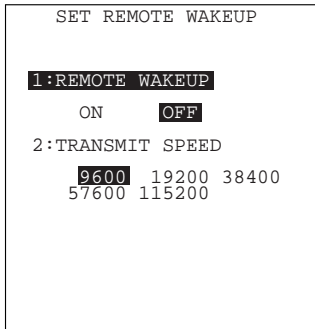

Pressing the **4** key while holding down the **SF** key on the SYSTEM MENU calls up the screen shown at left.

- 1** REMOTE WAKEUP: Activates or deactivates the remote wakeup function.
- 2** TRANSMIT SPEED: Sets the transmission speed for the remote wakeup.

Select a desired item by using the numerical keys or **▲** and **▼** keys. Then select a desired setting by using the **◀** and **▶** keys.

To return to the SYSTEM MENU, press the **C** key.



## [ 12 ] Setting the CPU Performance

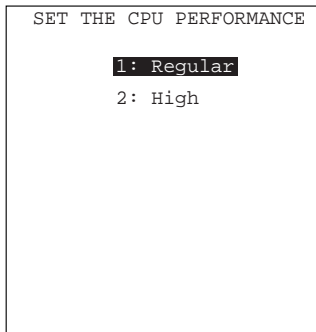

Pressing the **[5]** key while holding down the **[SF]** key on the SYSTEM MENU calls up the screen shown at left.

**[1]** Regular: Operates the CPU at normal clock speeds.

**[2]** High: Operates the CPU at higher clock speeds.

Select a desired item by using the numerical keys or **[▲]** and **[▼]** keys. Then select a desired setting by using the **[◀]** and **[▶]** keys.

To return to the SYSTEM MENU, press the **[C]** key.

**NOTE** Increasing the CPU clock speed will increase the power consumption.

## [ 13 ] Downloading/Uploading the System Message File

SYSTEM MESSAGE transfer menu

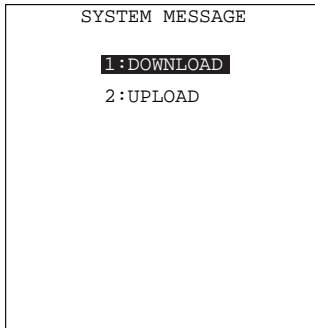

Pressing the **[6]** key while holding down the **[SF]** key on the SYSTEM MENU calls up the screen shown at left.

**[1]** DOWNLOAD: Downloads the system message file to the user area of the BHT.

**[2]** UPLOAD: Uploads the system message file stored in the BHT.

Select a desired item by using the numerical keys or **[▲]** and **[▼]** keys, then press the **[ENT]** key.

Press the **[C]** key to return to the SYSTEM MENU.

### [13.1] Downloading the system message file



Selecting "1:DOWNLOAD" on the SYSTEM MESSAGE transfer menu calls up the screen shown at left. With this screen displayed, the BHT waits for the system message file to be downloaded.

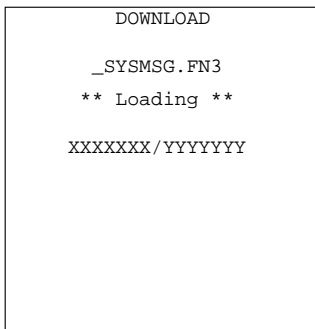

While the downloading operation is in progress, the screen shown at left is displayed indicating the file name and the number of received records/the total number of records.

To abort the downloading operation, press the **[C]** key. The screen will switch back to the SYSTEM MESSAGE transfer menu.



```

DOWNLOAD

  _SYSMSG.FN3
** Completed **
    
```

Upon completion of downloading, the BHT displays the screen shown at left and beeps once.

Press the **[C]** key to return to the SYSTEM MESSAGE transfer menu.

**NOTE**

When the BHT downloads the system message file, it creates a temporary file named "\_SYSMSG.FN3" in the user area. If the user area is insufficient for creating the temporary file, therefore, an error will result.

The created temporary file will be automatically deleted after completion of downloading.

**If an error occurs during downloading**

If some error occurs during downloading, the BHT beeps three times and shows one of the following screens with the prompt "Retry?":

To retry the download, press the **[1]** and **[ENT]** keys; to abort it, press the **[2]** and **[ENT]** keys.

To return to the SYSTEM MESSAGE transfer menu, press the **[C]** key.

```

DOWNLOAD

Out of memory!!

Retry? 1:Yes 2:No
    
```

**■ Problem**

The memory is insufficient for storing the system message file to be downloaded.

**■ Solution**

Press the **[2]** key to return to the SYSTEM MENU, then delete unnecessary files in the memory. (Refer to Subsection 2.5.3, [ 9 ].)

```

DOWNLOAD

File mismatch!!

Retry? 1:Yes 2:No
    
```

**■ Problem**

You attempted to download a file other than the system message file.

**■ Solution**

Check whether the file you attempted to download is a system message file.

```
DOWNLOAD FILE

Too many files!!

Retry? 1:Yes 2:No
```

### ■ Problem

The current download will exceed the maximum of 80 files in the memory.

### ■ Solution

Press the 2 key to return to the SYSTEM MENU, then delete unnecessary files in the memory. (Refer to Subsection 2.5.3, [ 9 ].)

```
DOWNLOAD

_SYSMSG.FN3
Communication error!!

Retry? 1:Yes 2:No
```

### ■ Problem

Downloading has failed.

### ■ Solution

To retry downloading, press the 1 key.

To return to the SYSTEM MENU, press the 2 key. Check the interface port, communications parameters, and communications protocol type in the SET SYSTEM menu or perform the communications test in the TEST menu. (Refer to Subsection 2.5.3, [4.5] and [5.5].)

## [13.2] Uploading the system message file

```

UPLOAD

** Waiting **

```



```

UPLOAD

_SYSMSG.FN3
** Loading **

XXXXXXX/YYYYYYY

```



```

UPLOAD

_SYSMSG.FN3
** Completed **

```

Selecting "2:UPLOAD" on the SYSTEM MESSAGE transfer menu calls up the screen shown at left. With this screen displayed, the BHT waits for the system message file to be uploaded.

While the uploading operation is in progress, the screen shown at left is displayed indicating the file name and the number of sent records/the total number of records.

To abort the uploading operation, press the **C** key. The screen will switch back to the SYSTEM MESSAGE transfer menu.

Upon completion of uploading, the BHT displays the screen shown at left and beeps once.

Press the **C** key to return to the SYSTEM MESSAGE transfer menu.

### **NOTE**

When the BHT uploads the system message file, it creates a temporary file named "\_SYSMSG.FN3" in the user area. If the user area is insufficient for creating the temporary file, therefore, an error will result.

The created temporary file will be automatically deleted after completion of uploading.

## If an error occurs during uploading

If some error occurs during uploading, one of the following screens will appear and the beeper beeps three times.

To retry the uploading operation, press the **[1]** and **[ENT]** keys; to abort it, press the **[2]** and **[ENT]** keys.

Press the **[C]** key to return to the SYSTEM MESSAGE transfer menu.

```
UPLOAD

Out of memory!!
```

### ■ Problem

The memory is insufficient for setting up the system message file.

### ■ Solution

Press the **[C]** key to return to the SYSTEM MENU, then delete unnecessary files in the memory. (Refer to Subsection 2.5.3, [ 9 ].)

```
UPLOAD

Too many files!!
```

### ■ Problem

The memory has already contained 80 files, so the BHT system message file cannot be set up.

### ■ Solution

Press the **[C]** key to return to the SYSTEM MENU, then delete unnecessary files in the memory. (Refer to Subsection 2.5.3, [ 9 ].)

```
UPLOAD

 _SYSMSG.FN3
Communication error!!

Retry? 1:Yes 2:No
```

### ■ Problem

Uploading has failed.

### ■ Solution

To retry uploading, press the **[1]** key.

To return to the SYSTEM MENU, press the **[2]** key. Check the interface port, communications parameters, and communications protocol type in the SET SYSTEM menu or perform the communications test in the TEST menu. (Refer to Subsection 2.5.3, [4.5] and [5.5].)

It is also necessary to check the communications parameters setup of the host computer.

# Chapter 3

## Communications Operations of the BHT

This chapter describes the communications operations of the BHT-7500/7500S/7500W—the spread-spectrum communication (for BHT-7500S/7500W only), IR communication, RS-232C interface specifications, the basic communications specifications, and the communications protocols—for data transfer with the host computer or other devices.

3.1	Spread-Spectrum Communication (BHT-7500S/7500W only) .....	124
3.1.1	Notes for Wireless Operations .....	124
3.1.2	RF-Related Parameters .....	124
3.2	Infrared Communication .....	126
3.3	RS-232C Interface Specifications .....	127
[ 1 ]	Interface Connector and Pin Assignment .....	127
[ 2 ]	Interface Cable Connection .....	128
3.4	Basic Communications Specifications and Parameters .....	129
3.4.1	Basic Communications Specifications .....	129
3.4.2	Communications Parameters .....	131
3.5	Communications Protocols .....	132
3.5.1	BHT-protocol .....	132
[ 1 ]	Overview .....	132
[ 2 ]	Control Characters .....	133
[ 3 ]	Basic Format of Transmission Messages .....	135
[ 4 ]	Text Format .....	136
3.5.2	BHT-Ir Protocol .....	138
[ 1 ]	Overview .....	138
[ 2 ]	Control Characters .....	139
[ 3 ]	Basic Format of Transmission Messages .....	141
[ 4 ]	Text Format .....	142

# 3.1 Spread-Spectrum Communication (BHT-7500S/7500W only)

## 3.1.1 Notes for Wireless Operations

- If there are too many communications errors, first make sure that the BHT points directly at an access point because the 2.4-GHz band requires a more or less straight line path. Note also that the low-power radio waves have trouble passing through human bodies and other obstacles along that path.
- The radio link will not operate properly in the vicinity of microwave ovens, industrial heaters, high-frequency medical equipment, and other sources of radio waves in the 2.4-GHz band.
- Electromagnetic noise from personal computers, refrigerators, and other home appliances can also interfere with link operation.
- Environmental factors that can also interfere with link operation include large metallic objects, metallic dust, or metallic walls in the vicinity of the path and vibration at either end.

### **NOTE**

To System Designers:

- Before developing the application, make sure that the intended environment is free of the interference factors above and thus actually capable of supporting link operation.
- Assume that there will be communications failures requiring robust retry capabilities in the software.

## 3.1.2 RF-Related Parameters

Programs written in BHT-BASIC control wireless communication with commands between the BHT terminals and access points which are connected each other by a wireless LAN.

### **BHT-7500S**

For the setting procedure of RF-related parameters, refer to Subsection 2.5.3, "[ 8 ] RF Menu BHT-7500S."

### ■ **Domains**

It is necessary to group a wireless LAN into domains and assign them with unique domain names. A domain name should be included in the IDs of access points.

You may roam between access points during wireless communication if those access points are within wireless networks having a same domain name.

For the setting procedure of domain names, refer to Subsection 2.5.3, [ 8 ] RF Menu.



### ■ Security IDs

For assuring higher security, set security IDs to the BHTs. Those IDs should match those of the access points.

Usually, use a same security ID for a company or a department (or section).

For the setting procedure of security IDs, refer to Subsection 2.5.3, [ 8 ] RF Menu.

### **BHT-7500W**

For the setting procedure of RF-related parameters, refer to Subsection 2.5.3, "[ 8 ] RF Menu BHT-7500W."

### ■ Client Name

This is a BHT name to be used on the network.

### ■ Service Set ID (SSID)

SSID is an ID to be used on the communications network. The BHT is able to communicate with devices having the same SSID. The SSID of the BHT should be the same as that of the access point you want to use.

### ■ POWER SAVE

You may place the wireless module built in the BHT in the energy saving mode. If this mode is set to "OFF," the service period of the BHT may be shortened. If it is set to ON, the BHT may take more time to wake up for link operation or send response messages.

### ■ WEP (Wired Equivalent Privacy)

When WEP is ON, messages to be sent/received over the wireless LAN will be encrypted. The WEP KEY uses 40-bit (10-digit hexadecimal) or 128-bit (26-digit hexadecimal) encryption word.

The BHT is able to definitely communicate with the access points having the same WEP KEY.

### ■ WEP KEY

You can set four types of encryption keys (WEP KEY1 through WEP KEY4). If you enable WEP, choose any one of WEP KEY1 through WEP KEY4 as TRANSMIT KEY.

### ■ AUTHENTICATE

This may set up the authentication system to be applied when WEP is enabled. You can use either one of the two KEYS—OPEN and SHARED KEY to disable and enable the authentication, respectively. If WEP is disabled, choose OPEN so that communication is no longer possible. If WEP is enabled, choose SHARED KEY to enable wireless communications.

### ■ TRANSMIT KEY

You need to use the TRANSMIT KEY in order to choose and activate any one of the WEP KEY1 through WEP KEY4 already defined.

## 3.2 Infrared Communication

The BHT has an integrated infrared (IR) communications device which enables wireless transfer of programs and data between the BHT and the host computer and between the BHTs, instead of the conventional wire transfer.

The IR communications device features the following:

- Wireless communications
- Small and lightweight design
- High transmission speed
- Freedom from the codes/regulations and licenses which differ from country to country, unlike radio devices

The BHT may communicate with other IrDA-compliant equipment just by aligning their IR ports with each other. The effective IR range and IR port angle may differ depending upon the target equipment, so observe the instructions given in manuals furnished with such equipment.

### **NOTE**

If IR transfer fails, bring the BHT closer to the target station or change the IR port angle, and try again.

The BHT's IR communications device is IrDA-compliant. IrDA stands for Infrared Data Association, which has defined hardware (IrDA Serial Infrared Physical Layer Link) and communications protocols for IR communications.

The BHT's physical layer complies with the IrDA1.0, with a maximum transfer distance of 0.8 m and maximum transmission rate of 115.2 kbits per second.

The BHT adopts the exclusive BHT-Ir protocol which allows you to develop user programs for IR communications in BHT-BASIC, as can be done with conventional wire communications.

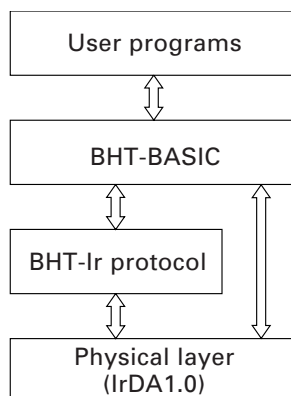

## 3.3 RS-232C Interface Specifications

### [ 1 ] Interface Connector and Pin Assignment

The BHT has a direct-connect interface port which is connectable to the 3-pole mini stereo plug ( $\phi 2.5$  mm or 0.1") and supports a subset of the RS-232C interface as shown below.

Using a direct-connect interface cable having the mini stereo plugs makes it possible to connect the BHT to a host computer (or another BHT) directly without any routing through the CU-7000.

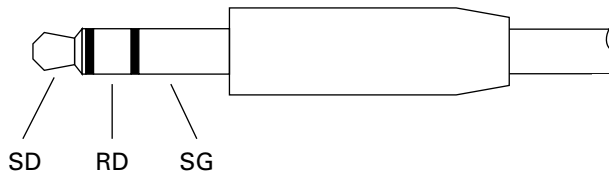

3-pole Mini Stereo Plug ( $\phi 2.5$  mm or 0.1")

The poles of the plug are assigned as listed below.

Signal Name	Function	Signal Input/Output	
		BHT	External device
SD	Send data		→
RD	Receive data	←	
SG	Signal ground		

The input/output voltage threshold for the logical valued signal is listed below.

Logical Value	Input Voltage Threshold	Output Voltage Threshold
	(RD)	(SD)
0	3V min.	5V min.
1	-3V max.	-5V max.

#### **NOTE**

- The direct-connect interface port is not designed to stand frequent connecting/disconnecting. Do not plug and unplug basically more than one time a day; otherwise, the service life of the plug will shorten. To connect the BHT to a host computer having no IR port (or another BHT) frequently, use the CU-7000.
- Allow the specified signals only to enter the direct-connect interface port. Entry of other signals will result in a failure or malfunction of the BHT.

## [ 2 ] Interface Cable Connection

Connect the BHT directly to a host computer, a modem, or a printer with a direct-connect interface cable as illustrated below.

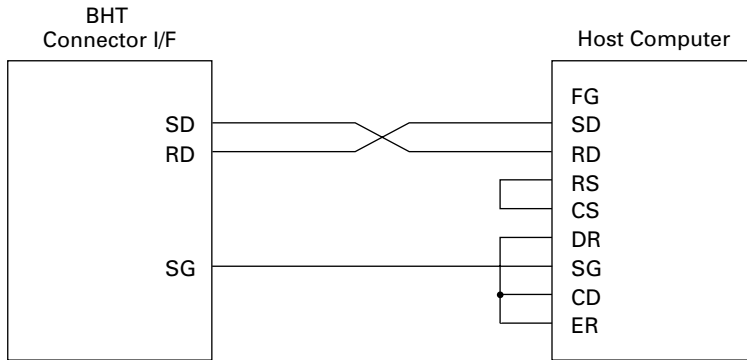

**Cable Connection between BHT and Host Computer**

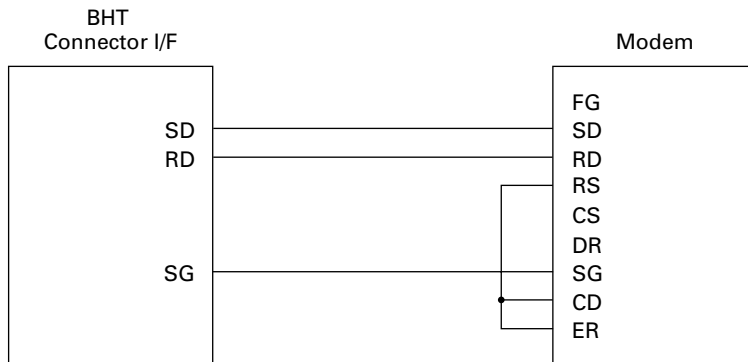

**Cable Connection between BHT and Modem**

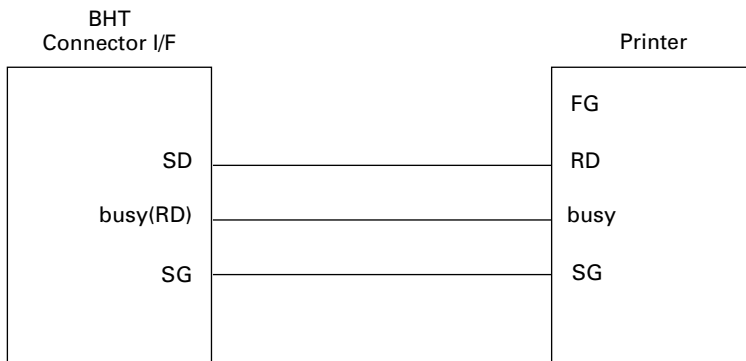

**Cable Connection between BHT and Printer**

## 3.4 Basic Communications Specifications and Parameters

### 3.4.1 Basic Communications Specifications

Listed below are the communications specifications when the BHT exchanges data with a host computer through the CU-7000 (optical interface) or direct-connect interface cable.

	Optical Interface	Direct-connect Interface
Synchronization	Start-stop	
Transmission Speed	2400, 9600, 19200, 38400, 57600, or 115200 bps	300, 600, 1200, 2400, 4800, 9600, 19200, 38400, 57600, or 115200 bps
Transmission Code	JIS 8-bit codes	JIS 7- or 8-bit codes
Transmission Bit Order	LSB (Least significant bit) first	
Vertical Parity	None	Even, odd, or none

#### ■ Synchronization

For accurate data transaction, it is very important to synchronize the transmission between the sender and receiver. To do this, it is required to previously define the bit order and position, the character length, and the beginning and end of the character to be transmitted.

The start-stop synchronization is an asynchronous system which synchronizes each character as a unit; that is, it externally adds start and stop bits to the leading and trailing bit positions of the character to be transmitted, respectively. A clock starts counting on receiving the start bit and it falls into a non-communication state on receiving the stop bit. The number of the stop bits is selectable (1 or 2 bits).

#### ■ Transmission Speed

Maximum number of bits to be transmitted per second. Expressed in bps (bits per second).

#### ■ Optical Interface Communications Range

The optical interface's maximum effective range is 80 cm (31.5 in.) with the IR beam within a 10° angle of divergence.

#### ■ Switching Time between Sending and Receiving on Optical Interface

The optical interface should satisfy the following requirements in switching between sending and receiving:

- (1) Within 10 ms from completion of sending, the optical interface should become ready to receive.
- (2) After 10 ms or more from completion of receiving, the optical interface should start sending.

## ■ Transmission Code and Bit Order

All characters should be coded to 7- or 8-bit code for data transmission. The standard data exchange code of the BHT is JIS 7- or 8-bit code. The transmission bit order is LSB (Least significant bit) first.

What follows is an example for transmitting character A (41h, 01000001b) coded to JIS 8-level code with an even parity and a single bit each for start and stop bits.

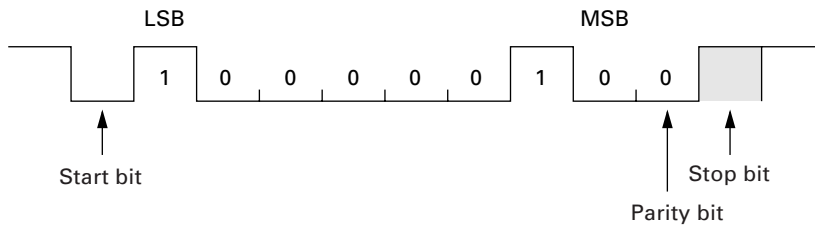

## ■ Vertical Parity

A vertical parity bit is a redundancy bit which is added to every character to be transmitted in order to check that data has been transmitted accurately. The parity bit should be set to "1" or "0" depending upon the parity parameter setting, to make the number of set bits in the character even or odd. The receiver counts the number of set bits in the transmitted character code to make sure that it has the selected number (even or odd) of set bits.

The vertical parity bit is positioned immediately following the MSB (Most significant bit) as shown below.

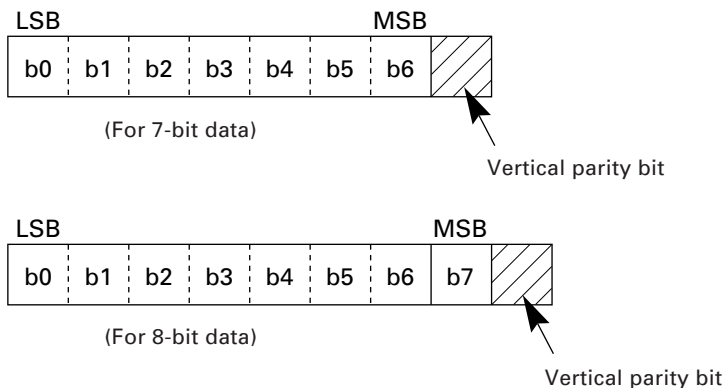

## 3.4.2 Communications Parameters

In System Mode and user programs written in BHT-BASIC, you may set the communications parameters listed below.

Communications Port	Optical interface	Direct-connect interface
Transmission Speed	2400, 9600, 19200, 38400, 57600, or 115200 bps	300, 600, 1200, 2400, 4800, 9600, 19200, 38400, 57600, or 115200 bps
Character Length	8 bits	7 or 8 bits
Vertical Parity	None	Odd, even, or none
Stop Bit Length	1 bit	1 or 2 bits

### In System Mode

Refer to Chapter 2, Subsection 2.5.3, [4.5], "Setting the communications environments."

### In BHT-BASIC

To set the transmission speed, character length, vertical parity, and stop bit length (To set the transmission speed only for the optical interface), use the `OPEN "COM: "` statement in BHT-BASIC.

- `OPEN "COM: ... "` Opens the interface port selected in System Mode.
- `OPEN "COM1: ... "` Opens the optical interface port for data transmission, irrespective of the setting in System Mode.
- `OPEN "COM2: ... "` Opens the direct-connect interface port for data transmission, irrespective of the setting in System Mode.

Note that it is impossible to open both the optical interface port and the direct-connect interface port concurrently.

Through the interface port opened by the `OPEN "COM: "` statement, the `XFILE` statement transmits a designated file.

## 3.5 Communications Protocols

The BHT supports both the BHT-protocol and the BHT-Ir protocol for file transmission.

### 3.5.1 BHT-protocol

#### [ 1 ] Overview

The BHT-protocol is the communications procedure used to transmit files between the BHT and a host (or between the BHTs). It adopts the response method using ACK/NAK codes.

The BHT-protocol is composed of a defined set of the control character sequences including the following three phases:

**Phase 1: Establishment of data link**

The sending station confirms that the receiving station is ready to receive data.

**Phase 2: Data transmission**

The sending station transmits data to the target receiving station.

**Phase 3: Release of data link**

The sending station confirms whether or not all of the transmitted data has been correctly received by the receiving station. If yes, the sending station terminates the data transmission and releases the data link.

For details about the transmission control sequences and horizontal parity checking, refer to Appendix B, B.1, "BHT-protocol."



## [ 2 ] Control Characters

The control characters are classified into two groups: transmission control characters and text control characters.

### (1) Transmission control characters

The transmission control characters listed below are used to compose transmission control sequences in phases 1 through 3.

Symbol	Value	Meaning	Function
EOT	04h	End Of Transmission	Releases a data link (Phase 3). Requests abort of transmission (Phase 2).
ENQ	05h	Enquiry	Requests establishment of a data link (Phase 1). Prompts the receiver to respond to the sent text (Phase 2).
ACK	06h	Acknowledge	Acknowledgment response to ENQ (Phase 1). Acknowledgment response to text (Phase 2). Acknowledgment response to EOT (Phase 3).
NAK	15h	Negative Acknowledge	Negative acknowledgment response to ENQ (Phase 1). Negative acknowledgment response to text (Phase 2).

### ■ Transparency

The BHT uses the non-transparent mode which handles the control characters and codes (e.g., STX, ETX, and SOH) as starting or ending markers and does not allow them to be transmitted as normal data in the transmission texts.

## (2) Text control characters

The text control characters are used to format transmission texts. In the BHT-protocol, they include the following headers and a terminator.

Symbol	Value	Meaning	Function
SOH	01h	Start Of Heading	Indicates the start of heading text (Phase 2).
STX	02h	Start of Text	Indicates the start of data text (Phase 2).
ETX	03h	End of Text	Indicates the end of data text (Phase 2).

You may designate values of headers and a terminator with the protocol functions in BHT-BASIC. If you designate none of them in a user program, the BHT may apply those as listed above. Refer to the "BHT-BASIC Programmer's Manual."

### [ 3 ] Basic Format of Transmission Messages

Basically, the BHT transmits data as units of a file. First, it transmits a heading text which includes the attribute information of a file (e.g., file name and the number of data texts) to be transmitted. Following the heading text, it transmits the data text in the file. A heading text and data text comprise a text.

In actual text transmission, the text is divided into several blocks, then a header and terminator are added to each block. If the serial number management or error checking by BCC (Block Check Character) is required, the serial number or BCC is also added to each block, respectively. This procedure forms a transmission block. A set of transmission blocks makes up one transmission message.

Shown below is an example of a transmission message formed with the BHT-protocol.

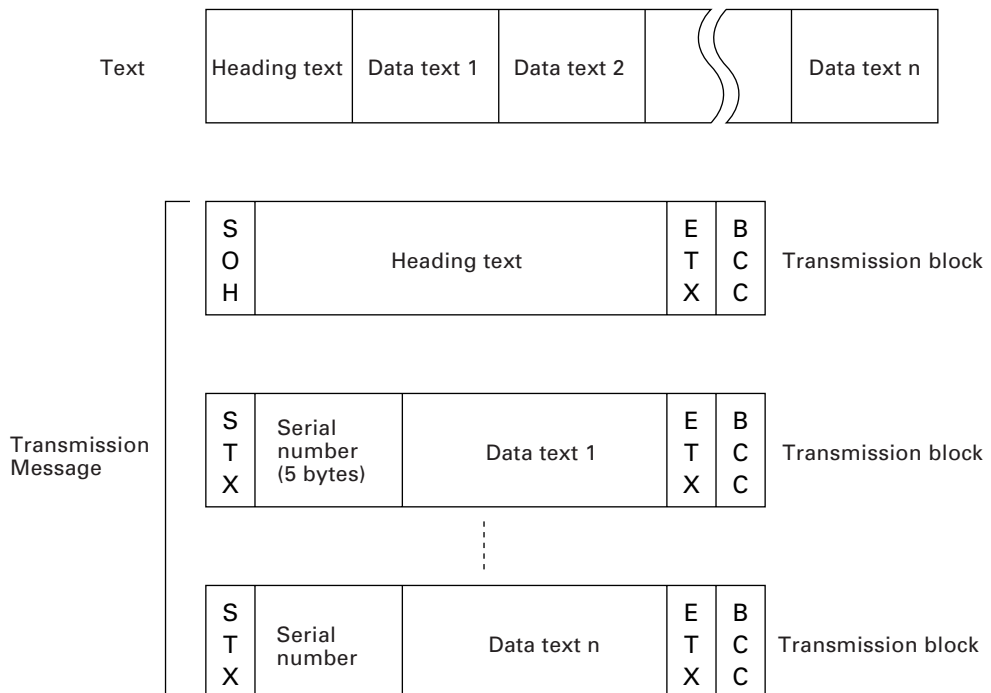

In the above figure, SOH, STX, and ETX are text control characters as described in [ 2 ] Control Characters, (2). A serial number is expressed by a five-digit decimal number, starting from 00001 to 32767, and identifies transmitted data texts. For the BCC, refer to Appendix B, B.1, "BHT-protocol," [ 3 ].

## [ 4 ] Text Format

Text should be formatted according to the standard of the BHT-protocol before transmission. Shown below are two types of the standard text formats for program files and data files.

### ■ Program Text Format

#### (1) Heading text

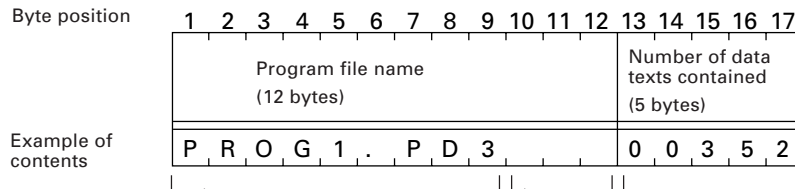

The program file name should be a maximum of 12 characters in length and it consists of FILE NAME and .EXTENSION. The FILE NAME should be 1 to 8 characters. The EXTENSION should be .PD3 (.FN3 and .EX3 may be available for future functional expansion).

If the program file name is less than 12 characters in length, the lower blank bytes will be filled with space characters.

The number of data texts should be 0 to 32767. If it is less than 5 digits, the upper blank bytes will be filled with zeros (0).

#### (2) Data text

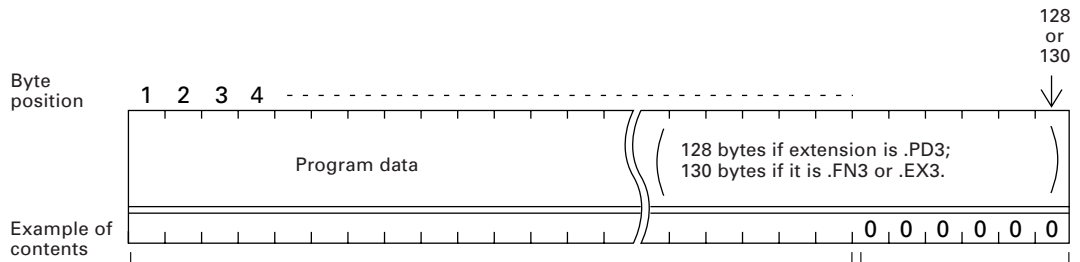

Object file (compiled from a source program file having one of the extensions .PD3, .FN3, and .EX3.)

If a program data field is less than the maximum digits in length, the lower blank bytes will be filled with zeros (0).

## ■ Data Text Format

### (1) Heading text

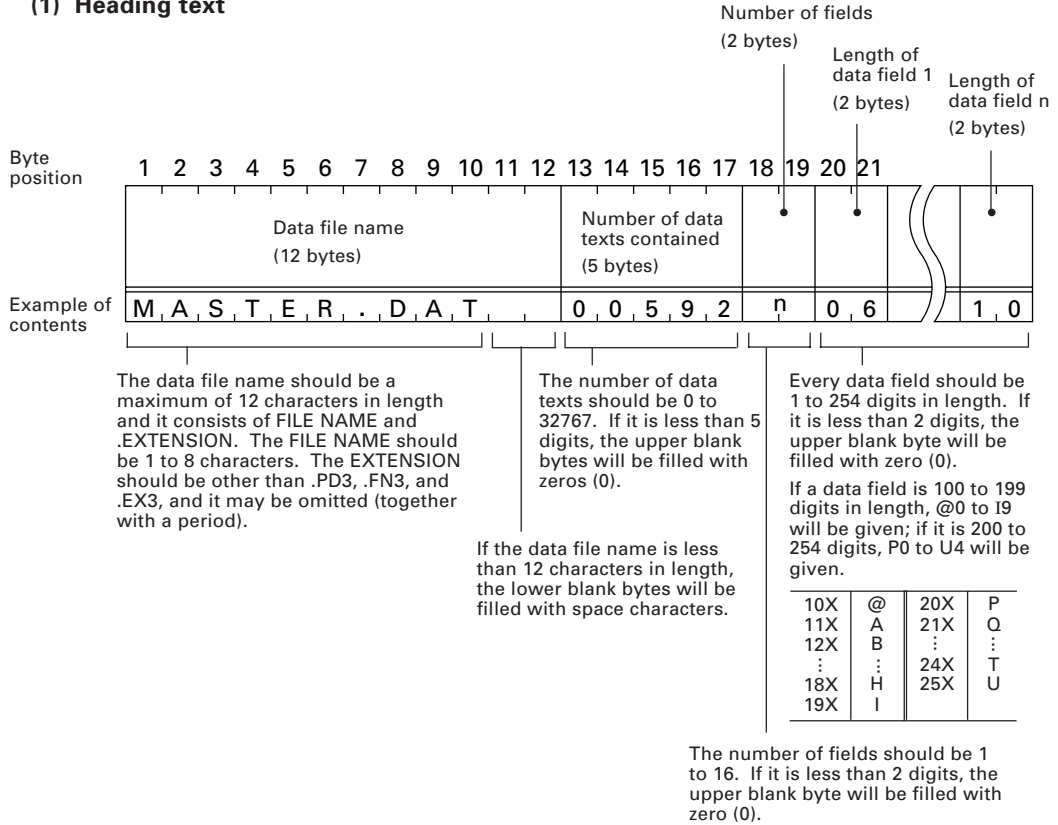

### NOTE

To transfer a data file containing a data field(s) of 100 digits or more, use the Win32 API-based Transfer Utility. The MS-DOS-based Transfer Utility does not support transmission of data fields exceeding 99 digits.

### (2) Data text

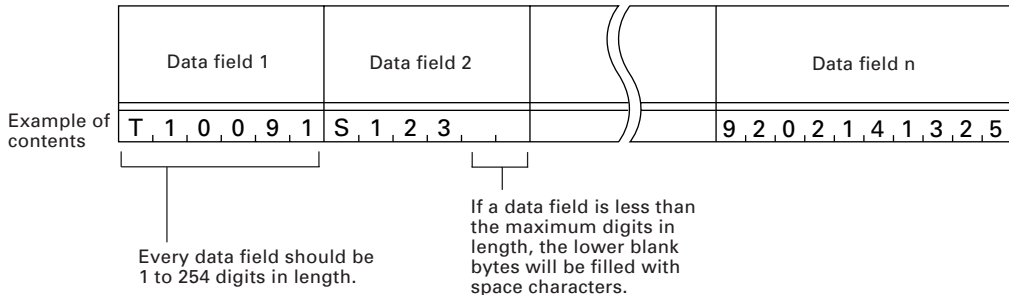

### NOTE

The total length of all data fields plus the number of the character count bytes (= the number of the fields) should be 255 bytes or less.

When you transfer five 50-digit (50-byte) fields, for example, the total length of all data fields is 250 (50 x 5) bytes and the number of the character count bytes is 5. Accordingly, the total is 255, so you can transfer the file.

## 3.5.2 BHT-Ir Protocol

### [ 1 ] Overview

The BHT-Ir protocol is the communications procedure for the serial infrared link, which is used to transmit files between the BHT and a host (or between the BHTs). It adopts the response method using ACK/NAK codes. The BHT-Ir protocol can be used also for communications through the direct-connect interface.

The BHT-Ir protocol is composed of a defined set of the control character sequences including the following three phases:

**Phase 1: Establishment of data link**

The sending station confirms that the receiving station is ready to receive data.

**Phase 2: Data transmission**

The sending station transmits data to the target receiving station.

**Phase 3: Release of data link**

The sending station confirms whether or not all of the transmitted data has been correctly received by the receiving station. If yes, the sending station terminates the data transmission and releases the data link.

For details about the transmission control sequences and CRC, refer to Appendix B, B.2, "BHT-Ir protocol."

## [ 2 ] Control Characters

The control characters are classified into two groups: transmission control characters and text control characters.

### (1) Transmission control characters

The transmission control characters listed below are used to compose transmission control sequences in phases 1 through 3.

Symbol	Value	Meaning	Function
DLE EOT	1004h	End Of Transmission	Releases a data link (Phase 3). Requests abort of transmission (Phase 2).
DLE ENQ	1005h	Enquiry	Requests establishment of a data link (Phase 1). Prompts the receiver to respond to the sent text (Phase 2).
DLE ACK	1006h	Acknowledge	Acknowledgment response to DLE ENQ (Phase 1). Acknowledgment response to text (Phase 2). Acknowledgment response to DLE EOT (Phase 3).
DLE NAK	1015h	Negative Acknowledge	Negative acknowledgment response to DLE ENQ (Phase 1). Negative acknowledgment response to text (Phase 2).
WACK	103Bh	Wait for Acknowledge	Requests suspension of data reception during erasure of the flash memory.

### ■ Transparency

The BHT uses the transparent mode which allows the control characters and codes (e.g., STX, ETX, SOH, and DLE) to be transmitted as normal data in the transmission texts.

To transmit a DLE as normal data, type DLE DLE per DLE.

## (2) Text control characters

The text control characters are used to format transmission texts. In the BHT-Ir protocol, they include the following headers and a terminator.

Symbol	Value	Meaning	Function
DLE SOH	1001h	Start Of Heading	Indicates the start of heading text (Phase 2).
DLE STX	1002h	Start of Text	Indicates the start of data text (Phase 2).
DLE ETX	1003h	End of Text	Indicates the end of data text (Phase 2).

In the BHT-Ir protocol, you cannot change the values of the headers and terminator with the protocol functions in BHT-BASIC.



### [ 3 ] Basic Format of Transmission Messages

Basically, the BHT transmits data as units of a file. First, it transmits a heading text which includes the attribute information of a file (e.g., file name and the number of data texts) to be transmitted. Following the heading text, it transmits the data text in the file. A heading text and data text comprise a text.

In actual text transmission, the text is divided into several blocks, then a header, terminator, serial number, receiver station's ID, and CRC-16 (Cyclic Redundancy Check) are added to each block. This procedure forms a transmission block. A set of transmission blocks makes up one transmission message.

Shown below is an example of a transmission message formed with the BHT-Ir protocol.

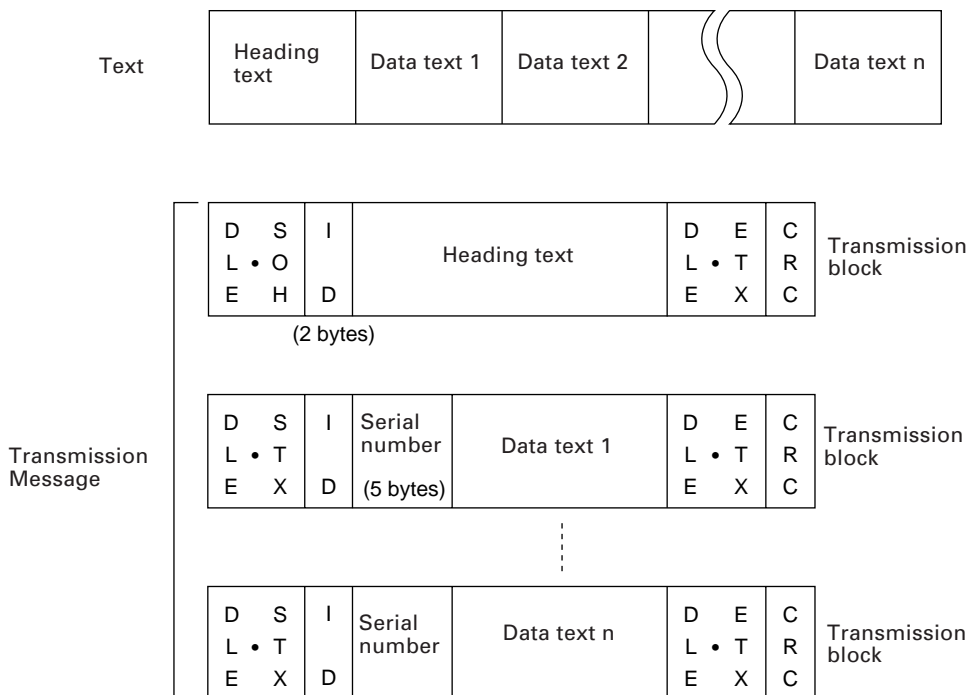

In the above figure, DLE SOH, DLE STX and DLE ETX are text control characters as described in [ 2 ] Control Characters, (2). An ID denotes the ID number of the receiver station, expressed by two bytes. A serial number is expressed by a five-digit decimal number, starting from 00001 to 32767, and identifies data texts. For the CRC-16, refer to Appendix B, B.2, "BHT-Ir protocol, " [ 3 ].

**TIP** You can use the control characters for expressing IDs, serial numbers, or text data.

## [ 4 ] Text Format

Text should be formatted according to the standard of the BHT-Ir protocol before transmission. Shown below are two types of the standard text formats for program files and data files.

### ■ Program Text Format

#### (1) Heading text

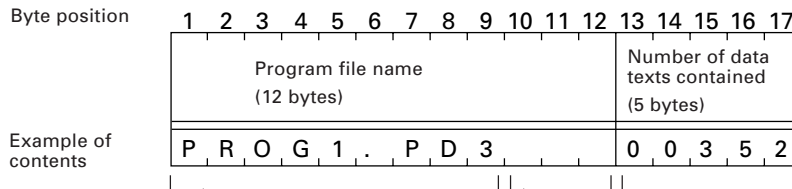

The program file name should be a maximum of 12 characters in length and it consists of FILE NAME and .EXTENSION. The FILE NAME should be 1 to 8 characters. The EXTENSION should be .PD3 (.EX3 and .FN3 may be available for future functional expansion).

If the program file name is less than 12 characters in length, the lower blank bytes will be filled with space characters.

The number of data texts should be 0 to 32767. If it is less than 5 digits, the upper blank bytes will be filled with zeros (0).

#### (2) Data text

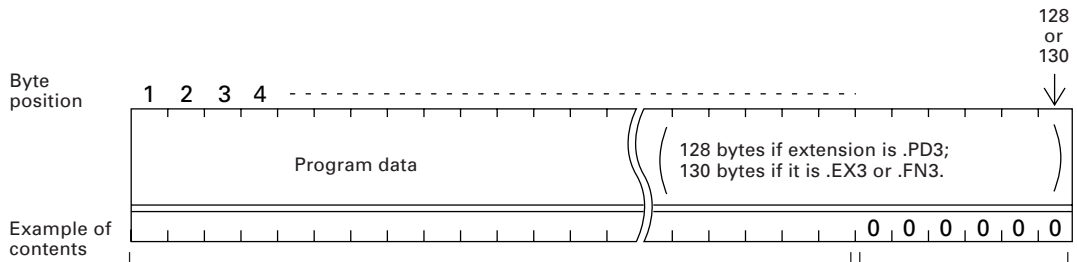

Object file (compiled from a source program file having one of the extensions .PD3, .EX3, and .FN3.)

If a program data field is less than the maximum digits in length, the lower blank bytes will be filled with zeros (0).

■ Data Text Format

(1) Heading text

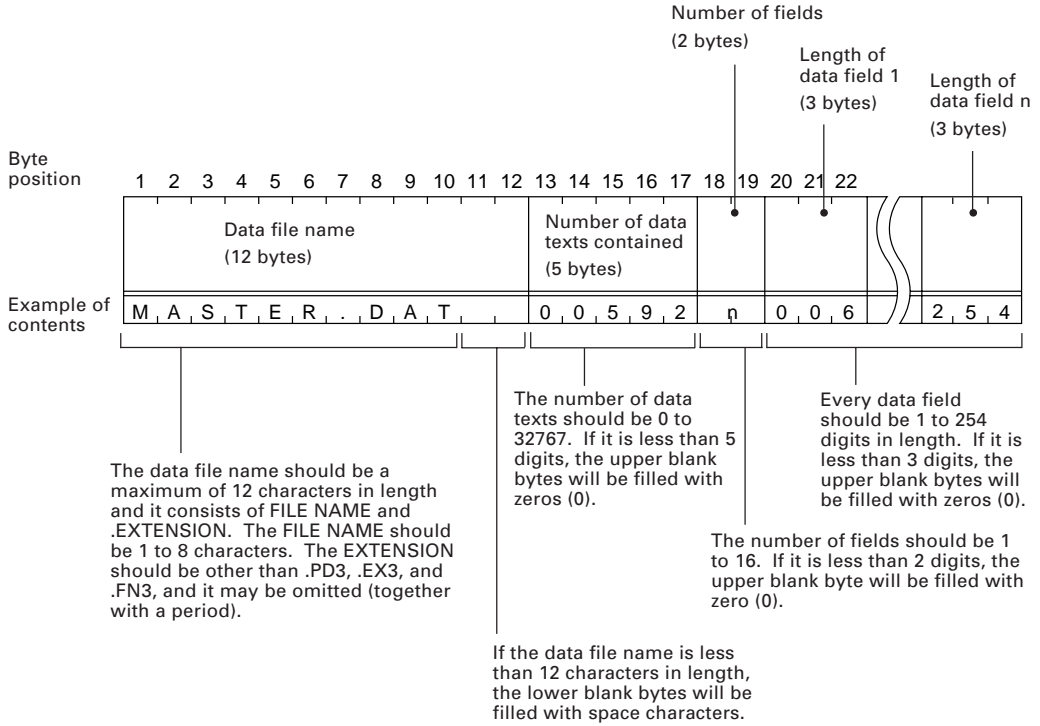

(2) Data text

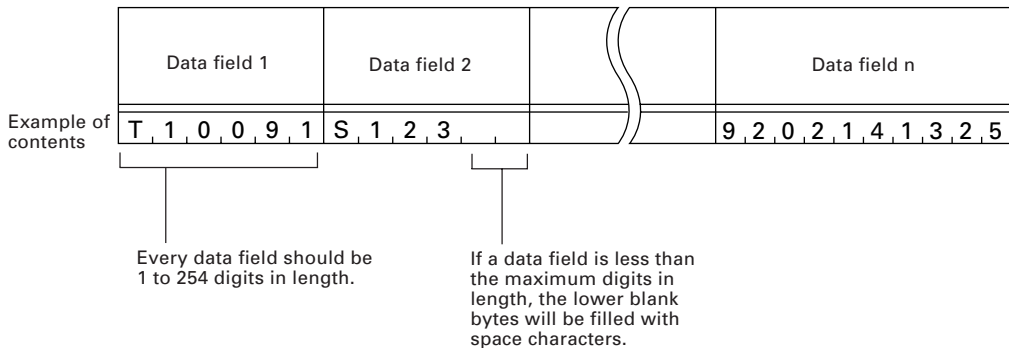

**NOTE**

The total length of all data fields plus the number of the character count bytes (= the number of the fields) should be 255 bytes or less.

When you transfer five 50-digit (50-byte) fields, for example, the total length of all data fields is 250 (50 x 5) bytes and the number of the character bytes is 5. Accordingly, the total is 255, so you can transfer the file.



This chapter lists the error messages which will appear on the LCD if some error occurs in the BHT-7500/7500S/7500W.

4.1	System Errors .....	146
4.2	Errors in System Mode .....	151

# Chapter 4

## Error Messages

# 4.1 System Errors

If some error occurs when the power is turned on or during program execution, one of the following error messages will appear on the LCD.

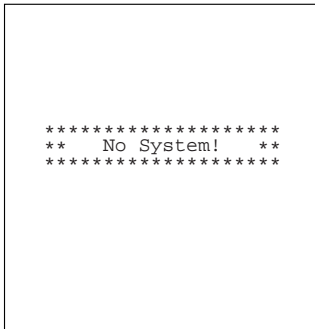

## System Program error

### ■ Problem

A System Program error has occurred.

**NOTE** If this error occurs, the BHT beeps five times (for 0.1 second per beep) and then turns itself off.

### ■ Solution

Contact your nearest dealer.

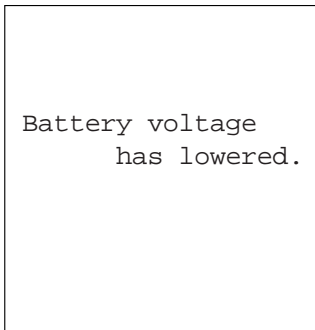

## Low battery indication—Level 1

### ■ Problem

When the power is turned on or off or during execution of program (System Mode or application), the battery output level has dropped below a specified lower level limit.

**NOTE** If low battery is detected, the BHT displays this message for approx. 2 seconds and beeps three times (for 0.1 second per beep). After that, it will resume previous regular operation.

### ■ Solution

The service life of the battery cartridge will expire soon, requiring replacement or recharge.

If the BHT is loaded with the rechargeable battery cartridge, replace or charge it. (For the charging procedure, refer to Chapter 5, Section 5.5.)

If the BHT is loaded with the dry battery cartridge, replace the dry cells.

(When the rechargeable battery cartridge is loaded)

```
Charge the
battery!
```

(When the dry battery cartridge is loaded)

```
Replace the
batteries!
```

```
Set the current
date and time.

00/01/01 00:00
_ / /      :
```

## Low battery indication—Level 2

### ■ Problem

When the power is turned on or off or during execution of program (System Mode or application), the battery output level has lowered to the extent that the BHT can no longer operate.

**NOTE** If lower battery is detected, the BHT beeps five times (for 0.1 second per beep) and then turns itself off. Depending upon the battery level, the beeper may not sound five times.

### ■ Solution

If the BHT is loaded with the rechargeable battery cartridge, replace or charge it. (For the charging procedure, refer to Chapter 5, Section 5.5.)

If the BHT is loaded with the dry battery cartridge, replace the dry cells.

## Calendar clock stopped

### ■ Problem

The calendar clock integrated in the BHT has stopped because:

- The battery cartridge had been removed for a long time,
- The rechargeable battery cartridge had not been recharged for a long time, or
- The dry cells in the dry battery cartridge had not been replaced.

**NOTE** The indication of 00/01/01 00:00 will change depending upon the calendar clock state.

### ■ Solution

Set the calendar clock (refer to Chapter 2, Subsection 2.3.2).

```
Your terminal was
not shut down
properly the last
time it was used.

Unsaved data
was lost.

[SF+2]
```

**Abnormally turned off last**

**■ Problem**

After turned off abnormally\*, the BHT had been left with no battery cartridge loaded or with a discharged battery cartridge loaded, so unsaved data was lost.

(\*"Normally turned off" refers to turned-off with the **PW** key or by the auto power-off feature.)

**■ Solution**

Refer to Subsection 2.3.7 "BHT Turning-off Notes."

```
Reload the battery
to restart!

XXXXXXXXX 01
```

**System Program malfunction**

**■ Problem**

During execution of System Program, the System Program has attempted to write onto the write-protected area of the memory.

(xxxxxxx: Error address)

**NOTE** If this error occurs, the BHT beeps five times (for 0.1 second per beep).

**■ Solution**

Unload and reload the battery cartridge, then turn on the power.

```
Reload the battery
to restart!

tskid:XXXXXXX
ercd :XXXXXXX
addr :XXXXXXX 02
```

**■ Problem**

During execution of System Program, the System Program has received an invalid command code.

(xxxxxxx: Error address)

**NOTE** If this error occurs, the BHT beeps five times (for 0.1 second per beep).

**■ Solution**

Unload and reload the battery cartridge, then turn on the power.



No execution  
program selected.  
Contact your  
administrator.

### **Execution program not selected**

#### ■ Problem

No user program has been selected as an execution program to be run when the power is turned on.

**NOTE** If this error occurs, the BHT beeps five times (for 0.1 second per beep) and then turns itself off.

#### ■ Solution

Run System Mode and select an execution program in the SET SYSTEM menu. (For the selecting procedure, refer to Chapter 2, Subsection 2.5.3, [4.1].)

No resume info.  
has been retained.  
Program restarts  
automatically.

### **Resume data lost**

#### ■ Problem

No resume data has been retained since the BHT was not normally turned off and then left with no battery cartridge loaded or with a discharged battery cartridge loaded even if the resume function had been set to ON.

**NOTE** The BHT displays this error message for 3 seconds and automatically runs the execution program from the point of start-up.

Your settings in  
System Mode  
have been lost.

Will reset  
to defaults.

### **Error in System Mode settings**

#### ■ Problem

Your settings made in System Mode contain an error.

**NOTE**

- If this error occurs, the System Mode settings revert to the factory defaults.
- The BHT displays this error message for three seconds and then displays the "No execution program selected..." message.

#### ■ Solution

Make your settings in System Mode again.

```

System down error!

type:XXXXXXXX R0 :XXXXXXXX
ercd:XXXXXXXX R1 :XXXXXXXX
inf1:XXXXXXXX R2 :XXXXXXXX
inf2:XXXXXXXX R3 :XXXXXXXX
SR :XXXXXXXX R4 :XXXXXXXX
PC :XXXXXXXX R5 :XXXXXXXX
PR :XXXXXXXX R6 :XXXXXXXX
R7 :XXXXXXXX
R8 :XXXXXXXX
R9 :XXXXXXXX
R10:XXXXXXXX
R11:XXXXXXXX
R12:XXXXXXXX
R13:XXXXXXXX
R14:XXXXXXXX
R15:XXXXXXXX

```

## System down error

### ■ Problem

An error has occurred during execution of System Program.

**NOTE** If this error occurs, the BHT beeps five times (for 0.1 second per beep).

### ■ Solution

Unload and reload the battery cartridge, then turn on the power.

If this error occurs frequently, make a note of the message and codes on the LCD and contact your nearest dealer.

```

Contact your
  administrator.
Note the error
  number.
(XXXX)

```

## System administrator to be called

### ■ Problem

Any of the following errors has occurred:

- (1) Hardware error
  - Calendar clock error: (1010)
  - Flash memory error: (1020)
- (2) Memory storage error (2XXX)
- (3) Execution program error (3010)
- (4) RF system error (4110)

(XXXX: Error code)

**TIP** If any of the above errors occurs, the BHT beeps five times (for 0.1 second per beep) and then turns itself off.

### ■ Solution

Turn on the power again.

If error (1) or (4) above occurs frequently, contact your nearest dealer.

If error (2) occurs frequently, initialize the BHT System (the whole user area including the font file area).

If error (3) occurs frequently, delete the execution program file that causes this error or download the original execution program file to overwrite the current one.

## 4.2 Errors in System Mode

If some error occurs during operation in System Mode, one of the following error messages will appear on the LCD.

```
EXECUTE PROGRAM

*****
* NO FILE EXISTS *
*****
```

### When selecting a program file or data file

#### ■ Problem

You attempted to execute a user program in the EXECUTE PROGRAM menu, but no user program files had been stored in the memory.

#### ■ Solution

Press the  key to return to the SYSTEM MENU screen, then download user programs. (Refer to Chapter 2, Subsection 2.5.3, [ 2 ].)

```
SET EXECUTE PROGRAM

*****
* NO FILE EXISTS *
*****
```

#### ■ Problem

In the SET SYSTEM menu, you attempted to select a user program file as an execution program to be run when the power is applied, but no user program files had been stored in the memory.

#### ■ Solution

Press the  key to return to the SYSTEM MENU screen, then download user programs. (Refer to Chapter 2, Subsection 2.5.3, [ 2 ].)

```
UPLOAD FILE

*****
* NO FILE EXISTS *
*****
```

#### ■ Problem

You attempted to select "ONE FILE" or "ALL FILES" for uploading in the UPLOAD menu or the FTP MENU, but no data files had been stored in the memory.

#### ■ Solution

Press the  key to return to the SYSTEM MENU screen.

```
DELETE FILE

*****
* NO FILE EXISTS *
*****
```

### ■ Problem

You have deleted all of the files stored in the memory in the DELETE FILE menu.

### ■ Solution

Press the **C** key to return to the SYSTEM MENU screen.

## During downloading of a program file, data file, BHT system parameter file, or system message file

```
DOWNLOAD FILE

Out of memory!!

Retry?
  1:Yes 2:No
```

### ■ Problem

The memory is insufficient for storing files to be downloaded.

### ■ Solution

Press the **2** key to return to the SYSTEM MENU, then delete unnecessary files in the memory or decrease the size of the file to be downloaded. (Refer to Chapter 2, Subsection 2.5.3, [ 9 ], [ 2 ], [ 10 ], and [ 13 ].)

```
DOWNLOAD

File mismatch!!
Retry?
  1:Yes 2:No
```

### ■ Problem

In the DOWNLOAD menu, you attempted to download the BHT system parameter file or system message file. In the SYSTEM PARAMETER transfer menu, you attempted to download a file other than the BHT system parameter file. Or in the SYSTEM MESSAGE transfer menu, you attempted to download a file other than the system message file.

### ■ Solution

Check the file you attempted to download and then download the file in the appropriate menu (DOWNLOAD menu, SYSTEM PARAMETER transfer menu, or SYSTEM MESSAGE transfer menu).

```

DOWNLOAD FILE

Too many files!!

Retry? 1:Yes 2:No

```

### ■ Problem

The current download will exceed the maximum of 80 files in the memory.

### ■ Solution

Press the **2** key to return to the SYSTEM MENU, then delete unnecessary files in the memory (or decrease the number of files to be downloaded if you attempted to download more than one file in the DOWNLOAD menu.)

(Refer to Chapter 2, Subsection 2.5.3, [ 9 ], [ 2 ], [ 10 ], and [ 13 ].)

```

DOWNLOAD FILE

XXXXXXXX.XXX
Communication error!!

Retry? 1:Yes 2:No

```

### ■ Problem

Downloading has failed.

### ■ Solution

To retry downloading, press the **1** key.

To return to the SYSTEM MENU, press the **2** key. Check the interface port, communications parameters, and communications protocol type in the SET SYSTEM menu or perform the communications test in the TEST menu. (Refer to Chapter 2, Subsection 2.5.3, [4.5] and [5.5].)

It is also necessary to check the communications parameters setup of the host computer.

```

DOWNLOAD FILE

XXXXXXXX.XXX
Program file error!!

Retry? 1:Yes 2:No

```

### ■ Problem

You attempted to download an invalid program file.

### ■ Solution

Check whether the program file you attempted to download is available to your BHT model. If it is not available, download the appropriate program.

## During uploading of a program file, data file, BHT system parameter file, or system message file

```
UPLOAD FILE
XXXXXXXXX.XXX
File error!!
Upload?
  1:Yes 2:No
```

### ■ Problem

The file you attempted to upload is damaged.

### ■ Solution

To upload the damaged file as is, press the 1 key.

```
UPLOAD
Out of memory!!
```

### ■ Problem

The memory is insufficient for setting up the BHT system parameter file or system message file to be uploaded.

### ■ Solution

Press the C key to return to the SYSTEM MENU and delete unnecessary files. (Refer to Chapter 2, Subsection 2.5.3, [ 9 ].)

```
UPLOAD
Too many files!!
```

### ■ Problem

The memory has already contained 80 files, so the BHT system parameter file or system message file cannot be set up.

### ■ Solution

Press the C key to return to the SYSTEM MENU and delete unnecessary files. (Refer to Chapter 2, Subsection 2.5.3, [ 9 ].)

```
UPLOAD FILE
XXXXXXXXX.XXX
Communication error!!

Retry? 1:Yes 2:No
```

■ **Problem**

Uploading has failed.

■ **Solution**

To retry uploading, press the 1 key.

To return to the SYSTEM MENU, press the 2 key. Check the interface port, communications parameters, and communications protocol type in the SET SYSTEM menu or perform the communications test in the TEST menu. (Refer to Chapter 2, Subsection 2.5.3, [4.5] and [5.5].)

It is also necessary to check the communications parameters setup of the host computer.





This chapter describes the handling procedure of the CU-7000, the interfacing with the host computer, and the charging of the rechargeable battery cartridge.

5.1	Functions of the CU-7000 .....	158
5.2	Components and Functions .....	158
5.3	Applying Power to the CU-7000 .....	159
5.4	Communicating with the Host Computer .....	160
5.4.1	Setting the Transmission Speed of the CU-7000 .....	160
5.4.2	Interface Cable Connection .....	160
5.4.3	Interfacing with the Host Computer .....	161
5.5	Charging the Rechargeable Battery Cartridge (using the CU-7001) .....	162
5.6	RS-232C Interface Specifications .....	164
	[ 1 ] Interface Connector and Pin Assignment .....	164
	[ 2 ] Interface Cable Connection .....	165

## Chapter 5

### Handling the CU-7000 (Option)

# 5.1 Functions of the CU-7000

The optical communications unit CU-7000 is available in two models: CU-7001 and CU-7002. The CU-7001 has both of functions (1) and (2) given below, the CU-7002 has only function (1).

(1) Data exchange function

The CU-7001/CU-7002 exchanges data and programs between the BHT and the host computer. It interfaces with the BHT via the optical interface and with the host computer via the RS-232C interface.

(2) Battery cartridge charging function

The CU-7001 charges the rechargeable battery cartridge loaded in the BHT.

# 5.2 Components and Functions

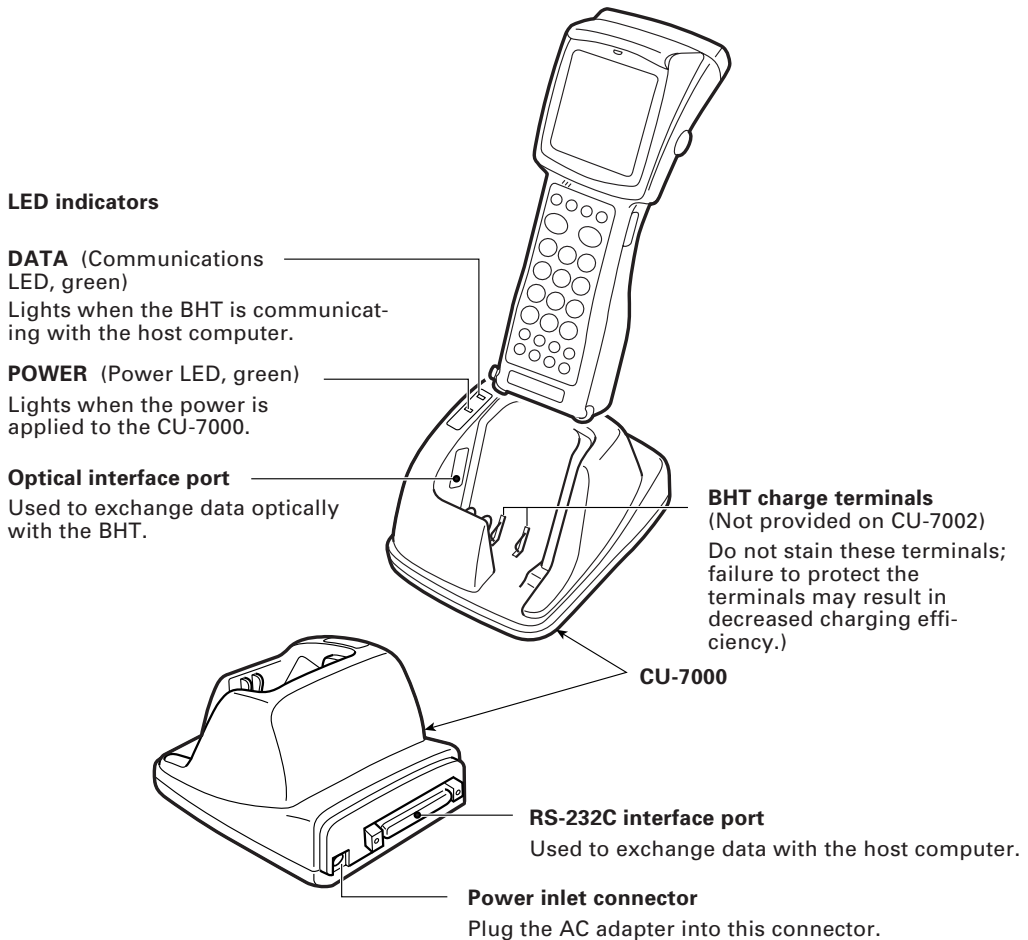







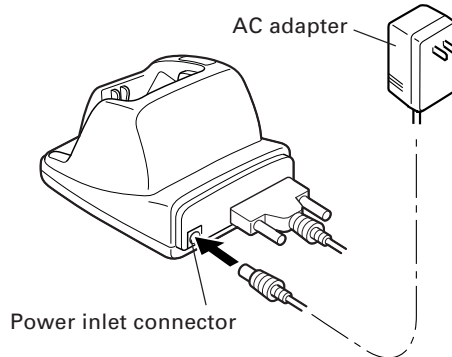



## 5.3 Applying Power to the CU-7000

Apply power to the CU-7000 by connecting it to the wall socket via the dedicated AC adapter according to the steps given below.

Connect the outlet plug of the AC adapter to the power inlet connector of the CU-7000, then plug the other end of the AC adapter into the wall socket.



<p><b>⚠ WARNING</b></p>	<ul style="list-style-type: none"> <li>• If smoke, abnormal odors or noises come from the CU, immediately unplug the AC adapter from the wall socket and contact your nearest dealer. Failure to do so could cause fire or electrical shock. </li> <li>• If foreign material or water gets into the CU, immediately unplug the AC adapter from the wall socket and contact your nearest dealer. Failure to do so could cause fire or electrical shock. </li> <li>• If you drop the CU so as to damage its housing, immediately unplug the AC adapter from the wall socket and contact your nearest dealer. Failure to do so could cause fire or electrical shock. </li> <li>• Use the dedicated AC adapter only. Failure to do so could result in a fire. </li> <li>• Never use the CU on the line voltage other than the specified level. Doing so could cause the CU to break or burn. </li> <li>• If the power cord of the AC adapter is damaged (e.g., exposed or broken lead wires), stop using it and contact your nearest dealer. Failure to do so could result in a fire or electrical shock. </li> </ul>
-------------------------	--

<p><b>⚠ CAUTION</b></p>	<ul style="list-style-type: none"> <li>• If you are not using the CU for a long time, be sure to unplug the AC adapter from the wall socket for safety. Failure to do so could result in a fire. </li> <li>• When caring for the CU, unplug the AC adapter from the wall socket for safety. Failure to do so could result in an electrical shock. </li> <li>• Never cover or wrap up the CU or AC adapter in a cloth or blanket. Doing so could cause the unit to heat up inside, deforming its housing, resulting in a fire. Always use the CU and AC adapter in a well-ventilated area. </li> <li>• Keep the power cord away from any heating equipment. Failure to do so could melt the sheathing, resulting in a fire or electrical shock. </li> </ul>
-------------------------	--

# 5.4 Communicating with the Host Computer

## 5.4.1 Setting the Transmission Speed of the CU-7000

Set the transmission speed of the CU-7000 to the same value as that of the BHT and the host computer, by using the DIP switch provided on the bottom of the CU-7000.

- (1) Turn the CU-7000 upside down.
- (2) Remove the protection sheet of the DIP switch from the CU-7000.
- (3) Set the selectors of the DIP switch as shown below.

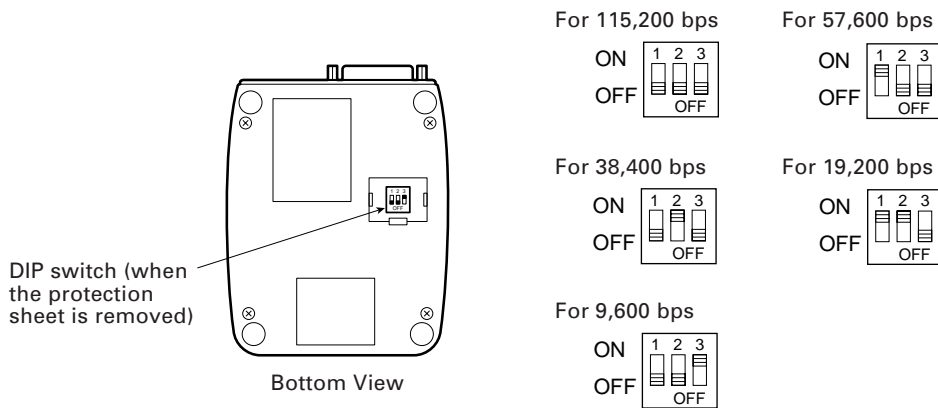

- (4) Reinstall the protection sheet.

### **NOTE**

Do not set the DIP switch to any configurations other than one of the five shown above.

## 5.4.2 Interface Cable Connection

- (1) Unplug the AC adapter of the CU-7000 from the wall socket.
- (2) Make sure that the host computer is turned off.
- (3) Connect the 25-pin plug (Dsub-25P) of the interface cable to the RS-232C interface port of the CU-7000.

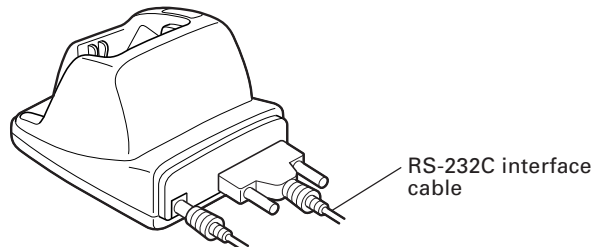

- (4) Connect the other end of the interface cable to the RS-232C port of the host computer.

### 5.4.3 Interfacing with the Host Computer

This section describes how to start communication with the host computer in System Mode. The same may apply when you use a user program.

- (1) Turn the host computer on.
- (2) Plug the AC adapter of the CU-7000 into the wall socket.
- (3) Make sure that the BHT is turned off, then set it on the CU-7000.

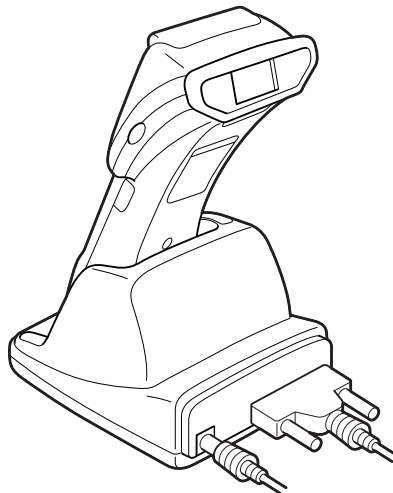

- (4) Turn the BHT power on and run System Mode. Set the communications environments (communications protocol, interface port, communications parameters, and protocol options).

Regarding the communications protocol: When using Ir-Transfer Utility C/Ir-Transfer Utility E on the host computer, select the BHT-Ir protocol; when using Transfer Utility, select the BHT-protocol.

Regarding the interface port: Select the optical interface port.

- (5) On the host computer, initiate a communications program (e.g., Ir-Transfer Utility C/Ir-Transfer Utility E/Transfer Utility, or equivalent).
- (6) To transfer data stored in the BHT to the host computer, select "3: UPLOAD" on the SYSTEM MENU in System Mode. To transfer data from the host computer to the BHT, select "2: DOWNLOAD." (For details, refer to Chapter 2, Section 2.5.)

The BHT and the host computer will start communications with each other via the CU-7000. The DATA LED will come on upon start of communications. After completion of communications, the LED will go off.

- (7) Unplug the AC adapter of the CU-7000 from the wall socket.

## 5.5 Charging the Rechargeable Battery Cartridge (using the CU-7001)

You may charge a rechargeable battery cartridge loaded in the BHT.

### **NOTE**

Service Life of Rechargeable Battery Cartridge:

Lithium-ion batteries used in the rechargeable battery cartridge will gradually deteriorate during the repeated cycles of charging and discharging due to its properties, even under normal use. When the battery service period becomes shortened due to its deterioration even if it has been charged for the specified hours, replace the battery cartridge with a new one. Generally, it is necessary to replace the battery cartridge after it has undergone approx. 300 cycles of charging and discharging operation.

- (1) Plug the AC adapter of the CU-7001 into the wall socket.

The POWER LED on the CU-7001 lights in green.

- (2) Place the BHT loaded with a battery cartridge onto the CU-7001.

The BHT turns on the indicator LED in red and starts charging. The charging time is approx. 4 hours.

Upon completion of charging, the indicator LED turns green.

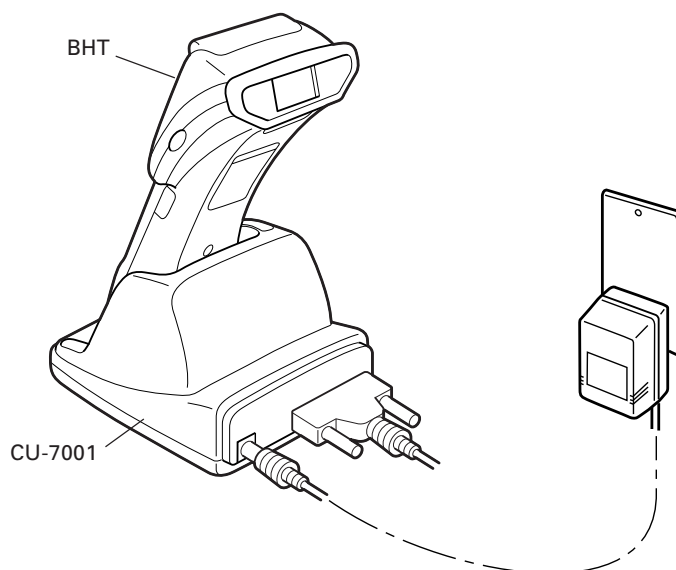





- (3) Take the BHT off the CU-7001.

### **TIP**

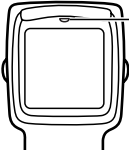
The charging time is approx. 4 hours if the "Charge the battery!" message is displayed on the BHT. The battery cartridge not discharged so much will be fully recharged in shorter time.

## ■ Charging Operation and LED Indication

Operator's Action	CU-7001 Status	Indicator LED on the BHT
	On standby	 OFF
↓	↓	
Place the BHT on the CU-7001.	Normal charging	 ON (in red)
↓	↓	
After approx. 4 hours	Charging completed	 ON (in green)
↓	↓	
Remove the BHT.	On standby	 OFF

# 5.6 RS-232C Interface Specifications

## [ 1 ] Interface Connector and Pin Assignment

The CU-7000 has an RS-232C interface port (Dsub-25S).

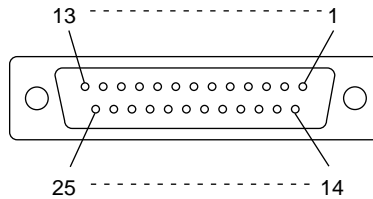

RS-232C interface port (Dsub-25S) on the CU-7000

Pin No.	Signal	Functions	Signal Input/Output	
			CU-7000	External device
1	FG	Frame ground	—	—
2	SD	Send data	→	→
3	RD	Receive data	←	←
4	RS	Request to send	—	—
5	CS	Ready to send	—	—
6	DR	Data set ready	—	—
7	SG	Signal ground	—	—
8	CD	Carrier detect	—	—
20	ER	Data terminal equipment ready	—	—

The input/output voltage threshold for the logical valued signal is listed below.

Logical Value	Input Voltage Threshold	Output Voltage Threshold
0	3V min.	5V min.
1	-3V max.	-5V max.



## [ 2 ] Interface Cable Connection

As illustrated below, connect the CU-7000 (on which the BHT is put) to a host computer with a cross-mode cable. To connect it to a modem, use a straight-mode cable.

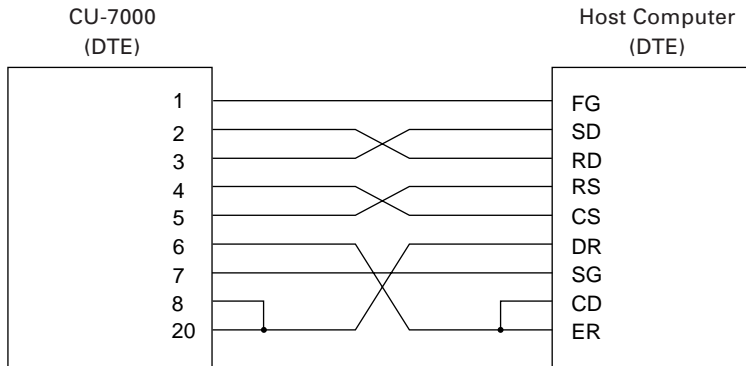

**Cable Connection between CU-7000 and Host Computer**

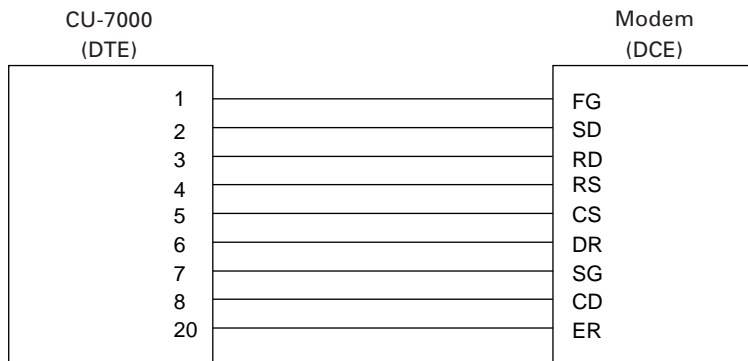

**Cable Connection between CU-7000 and Modem**

### **DTE and DCE**

In the RS-232C interface specifications, the DTEs (Data Terminal Equipment) shall be generally connected with each other by a cross-mode cable; the DTE and DCE (Data Circuit-terminating Equipment) shall be connected with each other by a straight-mode cable.

The DTE is one piece of equipment connected at both ends of a communications line as a sender or receiver of data (such as CU-7000 on which the BHT is put and a host computer).

The DCE is one piece of equipment connected to the intermediate point between the DTE and the communications line. It terminates communications lines and exchanges information between those lines without any change in contents (such as modem).



Appendix A. Specifications .....	168
A.1 BHT-7500/7500S/7500W .....	168
[ 1 ] Product Specifications .....	168
[ 2 ] Bar Code Specifications .....	170
[ 3 ] Interface Specifications .....	172
A.2 CU-7000 .....	173
[ 1 ] Product Specifications .....	173
[ 2 ] Charging Requirements (CU-7001) .....	173
[ 3 ] Interface Specifications .....	174
Appendix B. Communications Protocol Details .....	175
B.1 BHT-protocol .....	175
[ 1 ] Transmission Control Sequences .....	175
[ 2 ] Aborting Data Transmission .....	183
[ 3 ] BCC for Horizontal Parity Checking .....	184
B.2 BHT-Ir protocol .....	185
[ 1 ] Transmission Control Sequences .....	185
[ 2 ] Aborting Data Transmission .....	194
[ 3 ] CRC .....	195
[ 4 ] ID .....	195
Appendix C. A Typical Basic Operation .....	196

# Appendices

# Appendix A. Specifications

## A.1 BHT-7500/7500S/7500W

### [ 1 ] Product Specifications

<b>Power Source</b>	Main power	<ul style="list-style-type: none"> <li>• Rechargeable lithium-ion battery cartridge (3.6 VDC)</li> <li>or</li> <li>• Dry battery cartridge (two alkaline manganese batteries LR6s)</li> </ul>
<b>Dimensions</b> (W) x (L) x (H)		75 x 203 x 50 mm (3.0 x 8.0 x 2.0 inches)
<b>Weight</b>	BHT-7500	Approx. 290 g (Approx. 10.2 oz.) including battery cartridge
	BHT-7500S/7500W	Approx. 300g (Approx. 10.6 oz.) including battery cartridge
<b>Operating Ambient Temperature</b>	BHT-7500	-5°C to 50°C (23°F to 122°F)
	BHT-7500S/7500W	0°C to 50°C (32°F to 122°F)
<b>Operating Humidity</b>		20% to 80% (with no dew condensation)
<b>Ambient Illuminance</b>		500 to 3000 lx. (Depth of field: 80 mm, PCS value: 0.9 min., Reflection intensity: 85% min. for white and 5% max. for black, Narrow bar width: 0.127 mm min.)  20 to 8000 lx. (Depth of field: 430 mm, ITF: 1.0 magnification, PCS value: 0.9 min., Reflection intensity: 85% min. for white and 5% max. for black)
<b>Controller</b>		CPU: 32-bit RISC RAM: 1MB (BHT-7500) 512KB (BHT-7500S/7500W) Flash ROM: 8MB
<b>Keypad</b>		Magic keys: 4 (incl. 2 trigger switches) Function keys: 10 Numerical keys and others: 20

**Display**

Type: Dot-matrix, FSTN liquid crystal display (LCD) with backlight

Formation: Character display  
 160 dots wide by 159 dots high

Status display  
 160 dots wide by 1 dot high

Screen mode	Font size		Chars x Lines	Dots (W x H)
Single-byte ANK* mode	Standard-size		26 x 20	6 x 8
	Small-size		26 x 26	6 x 6
Two-byte Kanji mode	16-dot font	Full-width	10 x 10	16 x 16
		Half-width	20 x 10	8 x 16
	16-dot font (Double-width)	Full-width	5 x 10	32 x 16
		Half-width	10 x 10	16 x 16
	12-dot font	Full-width	13 x 13	12 x 12
		Half-width	26 x 13	6 x 12
12-dot font (Double-width)	Full-width	6 x 13	24 x 12	
	Half-width	13 x 13	12 x 12	

\*ANK: Alphanumerics and Katakana

**Calendar Clock**

Year, month, day, hour, minute, and second

- Year Two digits (with auto-correction on February 29 for year 1901 to 2099)

**Indicator LED**

Colors: Red and green

## [ 2 ] Bar Code Specifications

### (1) Available Bar Code Types

Bar code type	Bar dimensions	Readable magnification
Universal product codes		
EAN-13	0.26 to 0.66 mm (10.24 to 25.98 mils)	0.8 to 2.0
EAN-8		
UPC-A		
UPC-E		
EAN-13 with supplemental codes		
EAN-8 with supplemental codes		
UPC-A with supplemental codes		
UPC-E with supplemental codes 2-digit add-on 5-digit add-on		
Interleaved 2of5 (ITF)	0.125 mm min. (4.92 mils min.) [ PCS value $\geq$ 0.9 Reflection intensity difference between white and black bars $\geq$ 0.8 ]	
Standard 2of5 (STF)		
Codabar (NW-7)		
Code 39		
Code 93	0.15 mm min. (5.91 mils min.) [ PCS value $\geq$ 0.9 Reflection intensity difference between white and black bars $\geq$ 0.8 ]	
Code 128		
EAN-128		

All of the above values are under the following conditions:

- Ambient illuminance: 500 to 3000 lx
- Light source: Xenon lamp

### (2) Optical Properties Required for Bar Code Labels

White bars:	Reflection intensity	45% min.
Black bars:	Reflection intensity	25% max.
	PCS value	0.45 min.

### (3) Bar Code Label Size

Recommended width: 10 mm min. (0.39 inch min.)

Length:	Depth of field (Distance from bar codes to the bar-code reading window)	Length of labels (including margins)
	80 mm (3.15 inches)	80 mm max. (3.15 inches max.) (Minimum narrow bar width: 0.127 mm min.)* <sup>1</sup>
	560 mm (22.05 inches)	520 mm max. (20.47 inches max.) (Minimum narrow bar width: 1.4 mm min.)* <sup>6</sup>

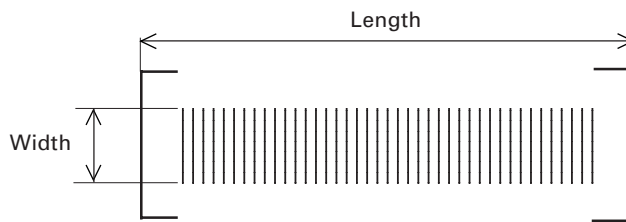

### (4) Thickness of Bars and Depth of Field

Minimum narrow bar width	Depth of field
0.127 mm (5.00 mils)	40 to 80 mm (1.57 to 3.15 inches)* <sup>1</sup>
0.19 mm (7.48 mils)	30 to 160 mm (1.18 to 6.30 inches)* <sup>2</sup>
0.33 mm (12.99 mils)	30 to 230 mm (1.18 to 9.06 inches)* <sup>3</sup>
0.51 mm (20.08 mils)	0 to 330 mm (0 to 13.00 inches)* <sup>4</sup>
1.0 mm (39.37 mils)	0 to 430 mm (0 to 16.93 inches)* <sup>5</sup>
1.4 mm (55.12 mils)	0 to 560 mm (0 to 22.05 inches)* <sup>6</sup>

\*<sup>1</sup> Under the following conditions:  
 - Ambient illuminance: 500 lx. (Xenon lamp)  
 - Code 39, 8-digit  
 Narrow bar : Wide bar = 1 : 2.2  
 - Reflection intensity of white bars: 85% min.  
 Reflection intensity of black bars: 5% max.

\*<sup>2</sup> Under the following conditions:  
 - Ambient illuminance: 500 lx. (Xenon lamp)  
 - Code 39, 6-digit  
 Narrow bar : Wide bar = 1 : 2.2  
 - Reflection intensity of white bars: 85% min.  
 Reflection intensity of black bars: 5% max.

\*<sup>3</sup> Under the following conditions:  
 - Ambient illuminance: 500 lx. (Xenon lamp)  
 - EAN-13, 1.0 magnification  
 - Reflection intensity of white bars: 85% min.  
 Reflection intensity of black bars: 5% max.

\*<sup>4</sup> Under the following conditions:  
 - Ambient illuminance: 500 lx. (Xenon lamp)  
 - Code 39, 3-digit  
 Narrow bar : Wide bar = 1 : 2.2  
 - Reflection intensity of white bars: 85% min.  
 Reflection intensity of black bars: 5% max.

\*<sup>5</sup> Under the following conditions:  
 - Ambient illuminance: 500 lx. (Xenon lamp)  
 - ITF conforming to the UPC Shipping Container Code  
 - Reflection intensity of white bars: 85% min.  
 Reflection intensity of black bars: 5% max.

\*<sup>6</sup> Under the following conditions:  
 - Ambient illuminance: 500 lx. (Xenon lamp)  
 - Code 39, 2-digit  
 Narrow bar : Wide bar = 1 : 2.2  
 - Reflection intensity of white bars: 85% min.  
 Reflection intensity of black bars: 5% max.

## [ 3 ] Interface Specifications

### Optical Interface

Synchronization: Start-stop  
 Input signals: RD  
 Output signals: SD  
 Transmission speed: 115,200 bps max.

### Direct-connect Interface

Synchronization: Start-stop  
 Transmission speed: 115,200 bps max.  
 Signal level: Conforms to the RS-232C interface  
 Pin assignment: As shown below.

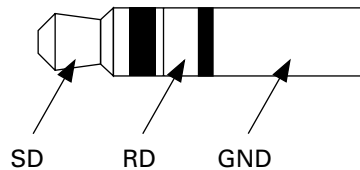

Pin No.	Signal	Functions	Signal Input/Output	
			BHT	External device
1	SG (GND)	Ground for signals	—	
2	SD	Send data	→	
3	RD	Receive data	←	

### Radio Interface (BHT-7500S only)

Frequency: 2.4 GHz band  
 Transmission speed: 1.6/0.8 Mbps  
 Modulation: Spread Spectrum (Frequency Hopping)  
 Hopping channels: 15  
 Certificate: FCC Part 15 in USA,  
 ETSI ETS300 328 and CE EMC-EEC in Europe

### Radio Interface (BHT-7500W only)

Frequency: 2.4 GHz baud  
 Transmission speed: 11/5.5/2/1 Mbps  
 Modulation: Spread Spectrum (Direct Sequence)  
 Channels: 13 (ETSI) ?? 14 ??  
 Certificate: ETSI ETS300 328 and CE EMC-EEC in Europe



## A.2 CU-7000

### [ 1 ] Product Specifications

#### Power Source

- Europe	230 VAC, 16 VA
- U.S.	120 VAC, 13 VA
- Australia	10 to 18 VDC, 450 mA (on 12 VDC)

#### Power Consumption

2 W

#### Dimensions

(W) x (L) x (H)

112 x 148 x 84 mm  
(4.41 x 5.83 x 3.31 inches)

#### Weight

CU-7001: Approx. 230 g (Approx. 8.11 oz.)  
CU-7002: Approx. 200 g (Approx. 7.06 oz.)

#### Operating Ambient Temperature

0°C to 40°C (32°F to 104°F)

#### Operating Humidity

20% to 80% (with no dew condensation)

### [ 2 ] Charging Requirements (CU-7001)

**Charge current:** Approx. 600 mA

**Charge time:** Approx. 4 hours

### [ 3 ] Interface Specifications

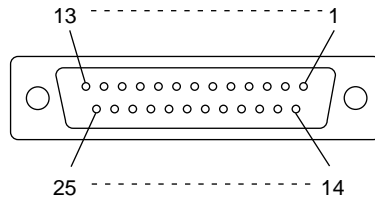

RS-232C Interface Port (Dsub-25S) on the CU-7000

Pin No.	Signal	Functions	Signal Input/Output	
			CU-7000	External device
1	FG	Frame ground	—	—
2	SD	Send data	→	—
3	RD	Receive data	←	—
4	RS	Request to send	—	—
5	CS	Ready to send	—	—
6	DR	Data set ready	—	—
7	SG	Signal ground	—	—
8	CD	Carrier detect	—	—
20	ER	Data terminal equipment ready	—	—

**NOTE** Shown below is a diagram of the internal connection in the CU-7000.

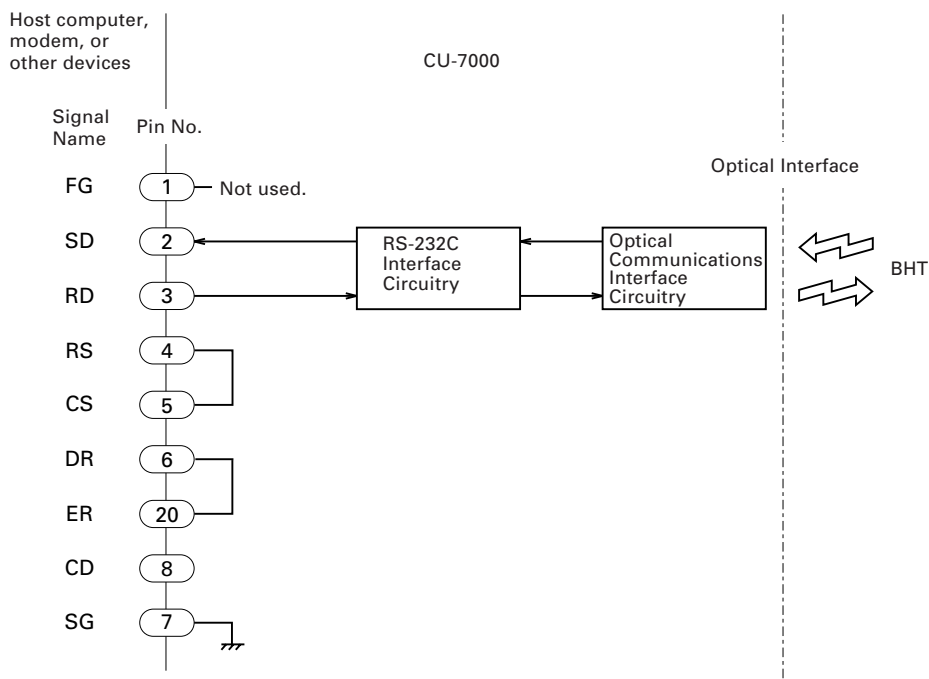

# Appendix B. Communications Protocol Details

## B.1 BHT-protocol

### [ 1 ] Transmission Control Sequences

Shown below is a typical message transmission sequence supported by the BHT-protocol. This sequence example does not include transmission errors or negative responses.

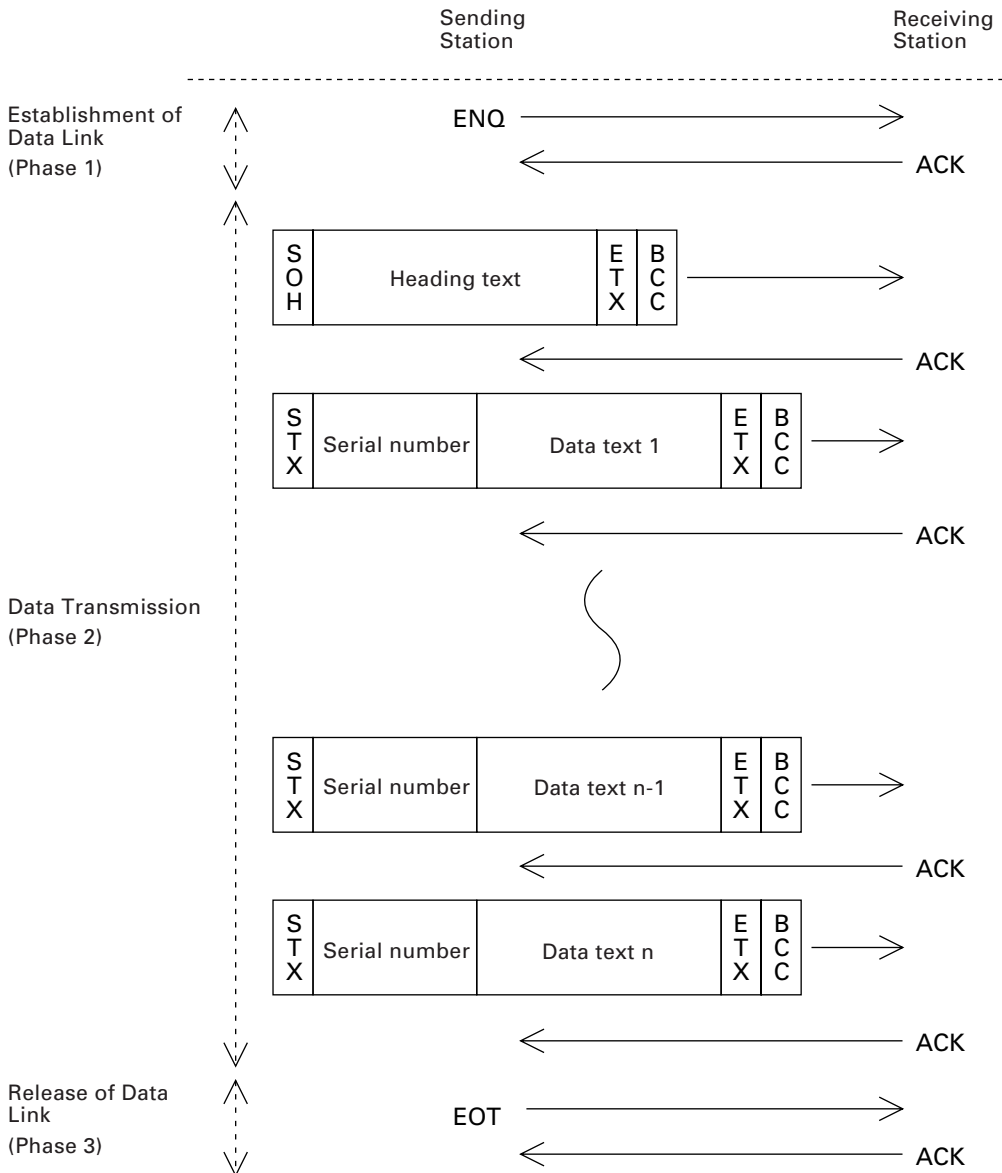

Data transmission may accidentally involve various types of errors. The BHT-protocol is designed to recover from those errors as frequently as possible.

What follows is the BHT-protocol for phases 1 through 3.

### **Phase 1: Establishment of Data Link**

#### **■ Normal phase 1**

The sending station transmits an ENQ to the receiving station. Upon receipt of an ACK from the receiving station, the sending station shifts to phase 2.

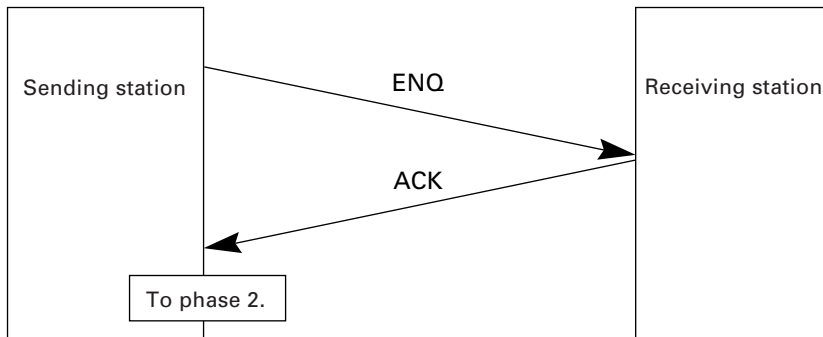

#### **■ Phase 1 with iterated ENQ transmission due to no response or invalid response**

If the sending station receives no response or any invalid response from the receiving station in response to an ENQ sent, it iterates sending of an ENQ at three-second intervals up to 10 times.

If the sending station receives an ACK before sending an ENQ ten times, it shifts to phase 2.

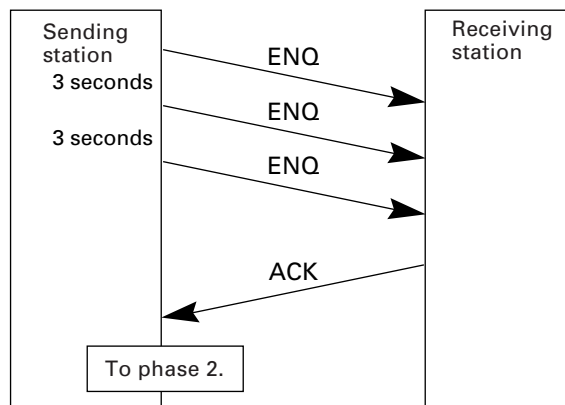

#### **TIP**

You may modify the number of ENQ iterations for the sending station. The default is 10 times at three-second intervals. For details, refer to the SET PROTOCOL screen in System Mode (pp. 62 and 64) and the XFILE statement given in "BHT-BASIC Programmer's Manual."

### ■ Abnormal termination of phase 1 (Abort of phase 1)

If the sending station receives no ACK from the receiving station after sending an ENQ 10 times in succession, it sends an EOT to the receiving station after three seconds from the 10th ENQ to terminate the message transmission abnormally.

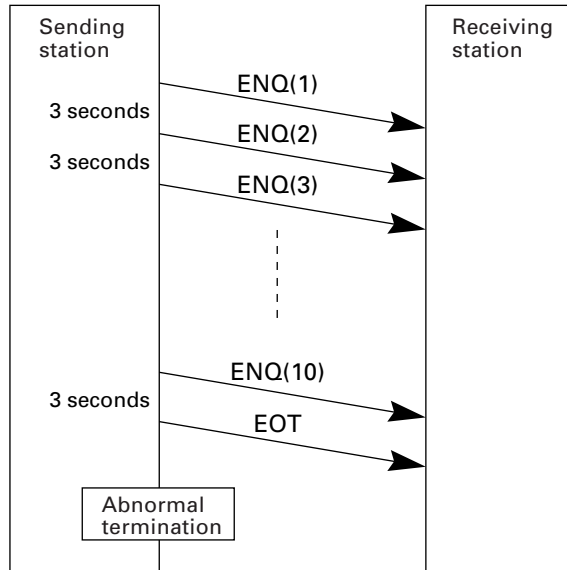

#### TIP

The receiving station's default timeout is 30 seconds. You may modify the timeout length on the SET PROTOCOL screen in System Mode (pp. 62 and 64) or by using the XFILE statement (refer to the "BHT-BASIC Programmer's Manual").

## Phase 2: Data Transmission

### ■ Normal phase 2

The sending station first sends a transmission block containing the heading text. Each time the sending station receives an ACK from the receiving station, it sends a transmission block containing the data texts as shown below. Upon receipt of an ACK in response to the last transmission block (data text n), the sending station shifts to phase 3.

If a transmission message contains no data text, the sending station transmits the heading text only.

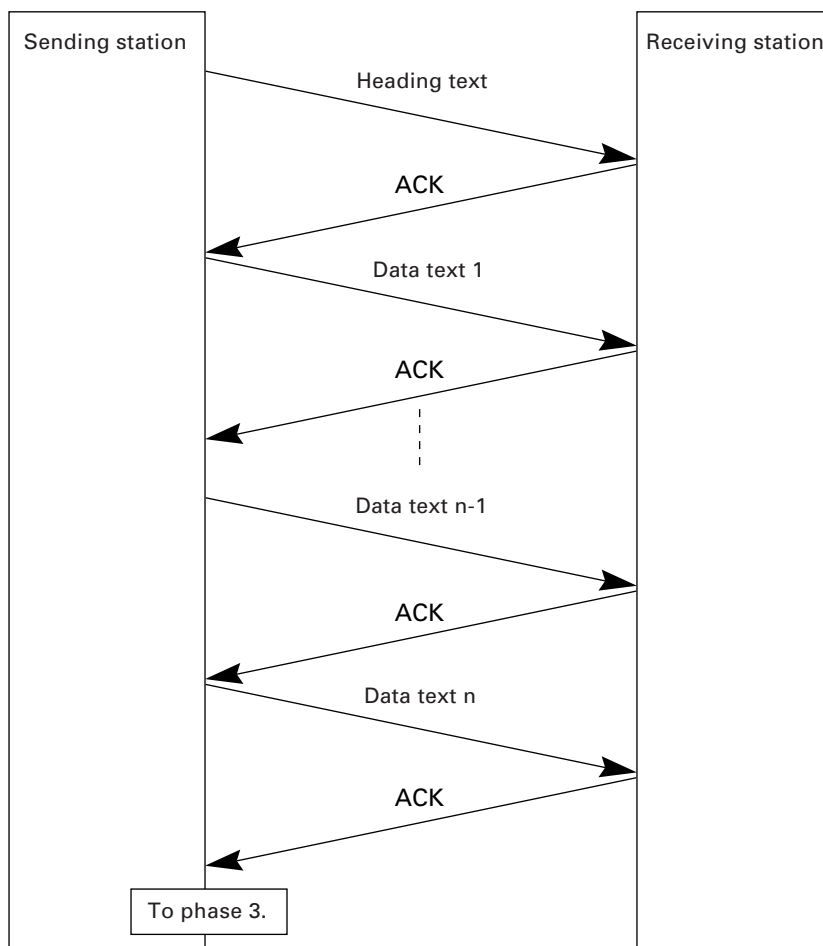

■ Phase 2 with NAK

If the sending station receives a NAK from the receiving station in response to a transmission block containing text data  $m$ , it sends that transmission block again immediately as shown below.

If the sending station receives an ACK before receiving a NAK 10 times in succession, it continues the subsequent message transmission.

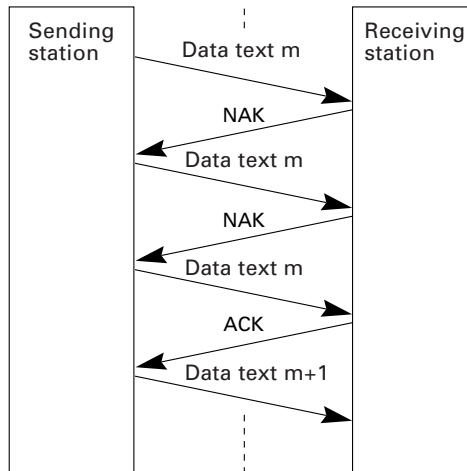

If the sending station receives a NAK 10 times in succession or it fails to send a same transmission block, it shifts to phase 3 to terminate the message transmission abnormally. Even if phase 3 terminates normally, the transmission results in an abnormal end.

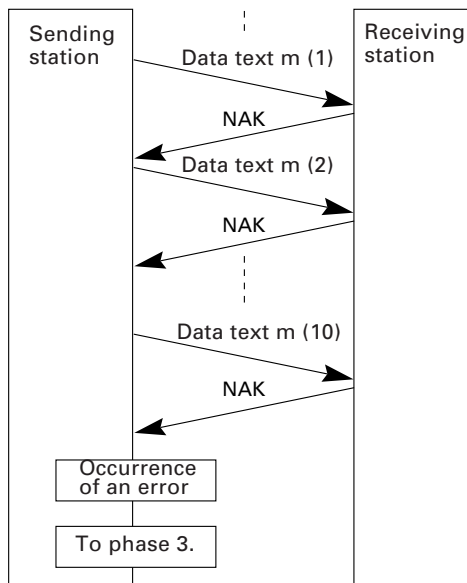

### ■ Phase 2 with EOT

If the sending station receives an EOT anytime during phase 2, it shifts to phase 3 to terminate the message transmission abnormally. Even if phase 3 terminates normally, the transmission results in an abnormal end.

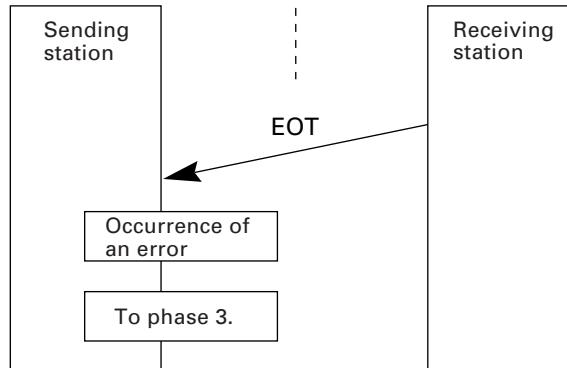

### ■ Phase 2 with iterated ENQ transmission due to no response or invalid response

If the sending station receives no response or any invalid response from the receiving station in response to a transmission block sent, it iterates sending of an ENQ at three-second intervals up to nine times.

If the sending station receives an ACK before sending an ENQ nine times, it continues the subsequent message transmission.

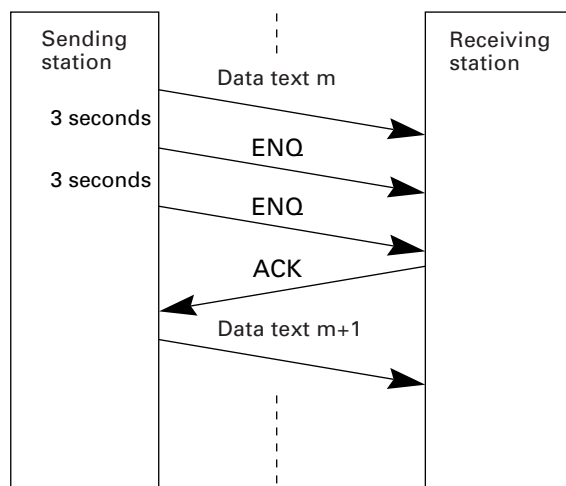



■ **Abnormal termination of phase 2 (Abort of phase 2)**

If the sending station receives no ACK from the receiving station after sending an ENQ nine times in succession, it sends an EOT to the receiving station after 3 seconds from the 9th ENQ to terminate this transmission sequence abnormally.

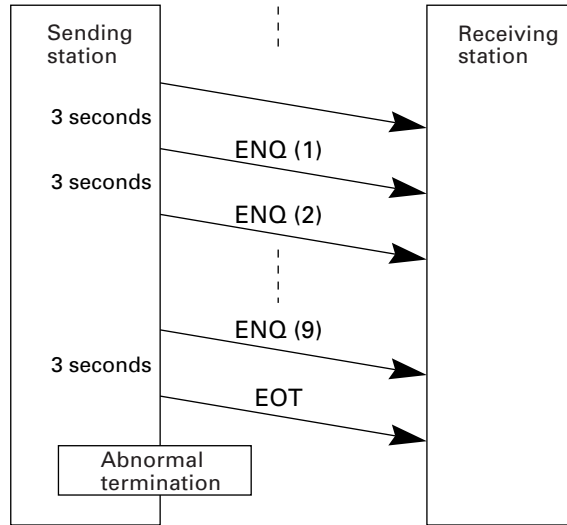

**Phase 3: Release of Data Link**

■ **Normal phase 3**

The sending station transmits an EOT to the receiving station. Upon receipt of an ACK from the receiving station, the sending station terminates the message transmission normally and releases the data link.

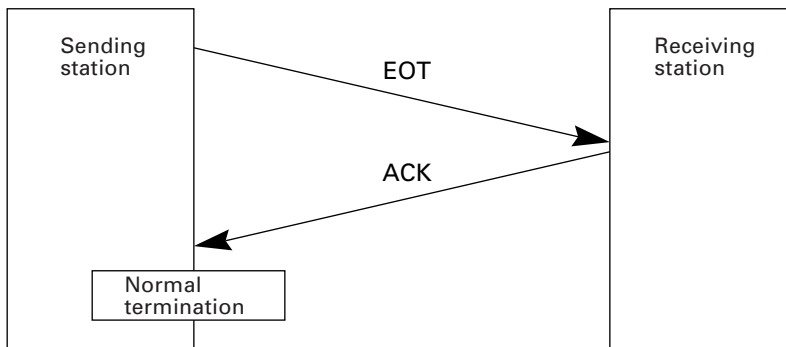

### ■ Phase 3 with iterated EOT transmission due to no response or invalid response

If the sending station receives no response or any invalid response from the receiving station in response to an EOT sent, it iterates sending of an EOT at three-second intervals up to ten times.

If the sending station receives an ACK before sending an EOT ten times, it terminates the message transmission normally and releases the data link.

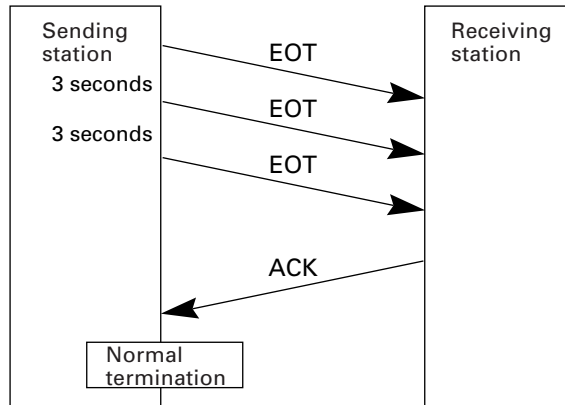

### ■ Abnormal termination of phase 3

If the sending station receives no ACK from the receiving station within three seconds from the 10th EOT, it terminates the message transmission abnormally and releases the data link.

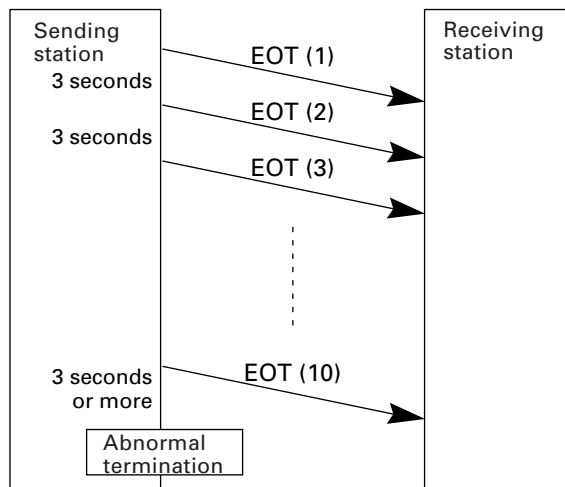

## [ 2 ] Aborting Data Transmission

Pressing the  C key aborts data transmission.

If the  C key is pressed during downloading, the BHT transmits an EOT and aborts the file transmission.

If it is pressed during uploading, the BHT transmits the current transmission block followed by EOT and then aborts the file transmission.

### [ 3 ] BCC for Horizontal Parity Checking

To check whether data has been transmitted accurately, the BHT supports horizontal parity checking for every transmission block.

In horizontal parity checking, a horizontal parity byte so called BCC (Block Check Character) is suffixed to an ETX of every transmission block.

In the BHT-protocol, every parity bit of BCC is set so that all set bits at the same bit level (including a parity bit) in the characters contained in the transmission block have an even number by binary addition, excluding SOH, STX, and functions SOH\$ and STX\$.

(For details about SOH\$ and STX\$ which are protocol functions unique to BHT-BASIC, refer to the "BHT-BASIC Programmer's Manual.")

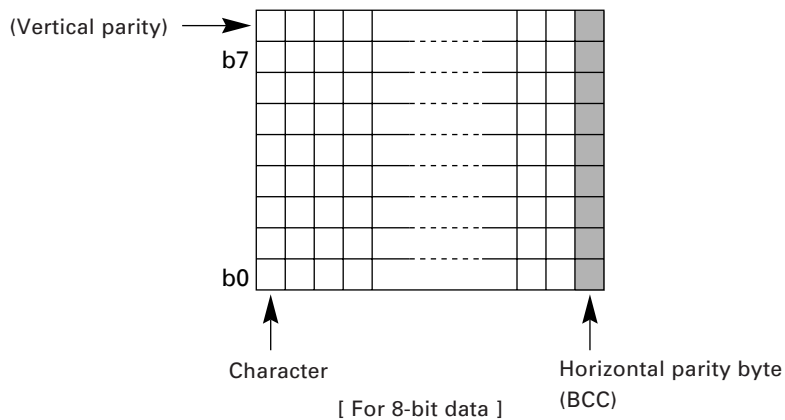

Shown below is a data text block indicating the bits to be added for horizontal parity checking.

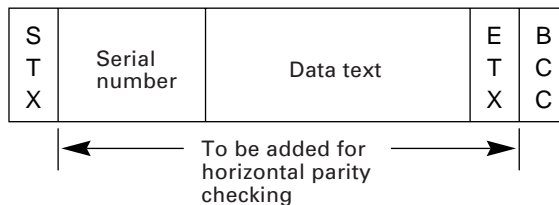

## B.2 BHT-Ir protocol

### [ 1 ] Transmission Control Sequences

Shown below is a typical message transmission sequence supported by the BHT-Ir protocol. This sequence example does not include transmission errors or negative responses.

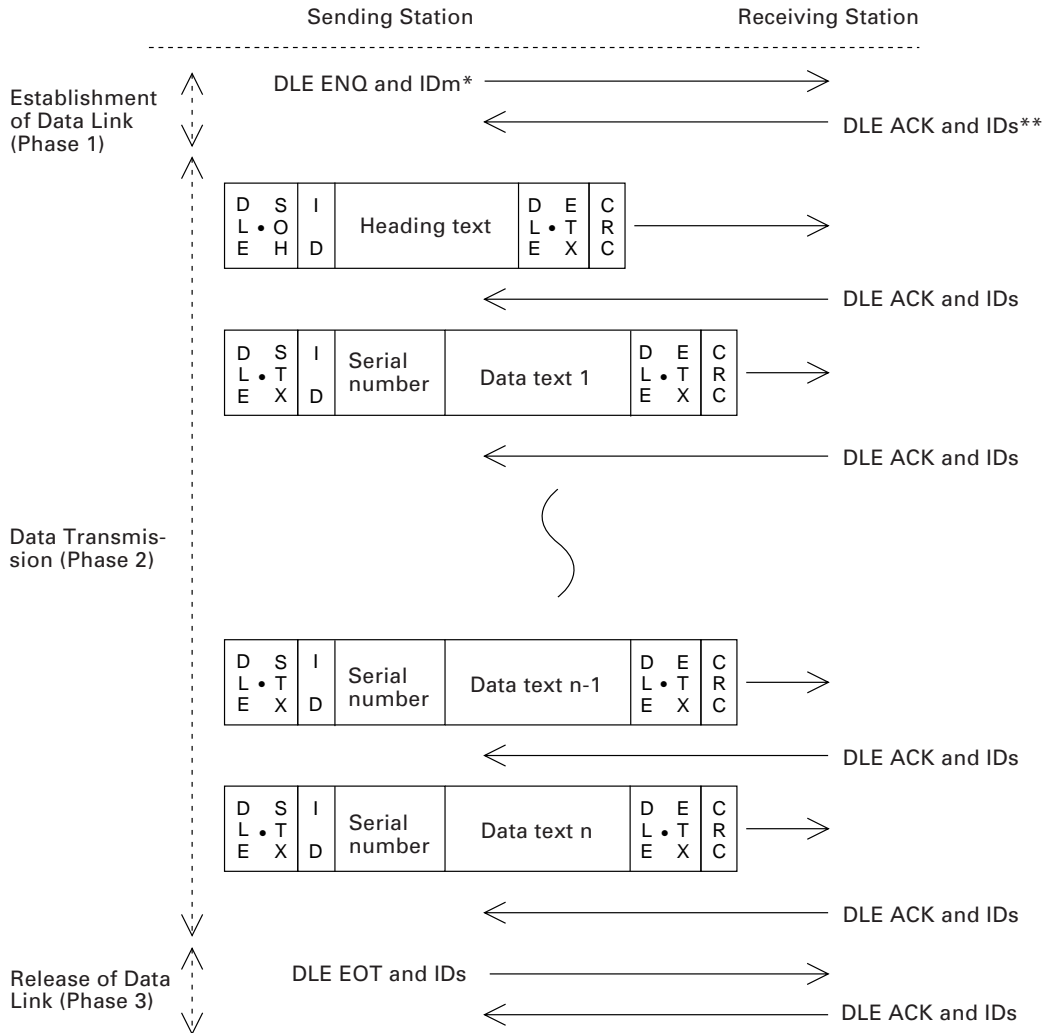

\*IDm: ID of sending station

\*\*IDs: ID of receiving station

Data transmission may accidentally involve various types of errors. The BHT-Ir protocol is designed to recover from those errors as frequently as possible.

What follows is the BHT-Ir protocol for phases 1 through 3.

### **Phase 1: Establishment of Data Link**

#### **■ Normal phase 1**

The sending station transmits a sequence of DLE ENQ and IDm (sending station's ID) to the receiving station. Upon receipt of a sequence of DLE ACK and IDr (receiving station's ID) from the receiving station, the sending station shifts to phase 2.

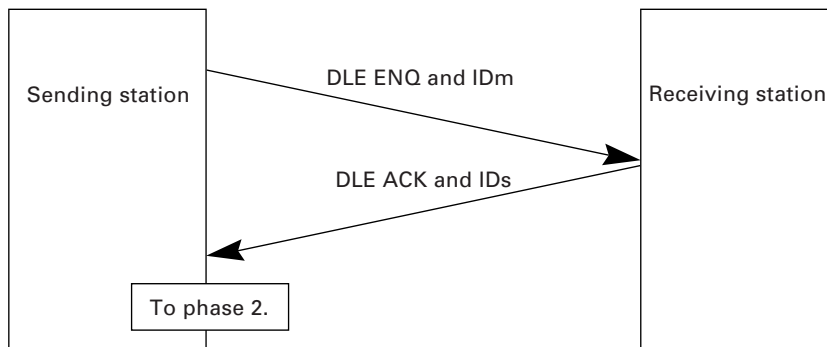

#### **■ Phase 1 with iterated transmission of DLE ENQ and IDm due to no response or invalid response**

If the sending station receives no response or any invalid response from the receiving station in response to the sent sequence of DLE ENQ and IDm, it iterates sending of the sequence at 0.5-second intervals up to 60 times.

If the sending station receives a sequence of DLE ACK and IDr before sending the sequence of DLE ENQ and IDm 60 times, it shifts to phase 2.

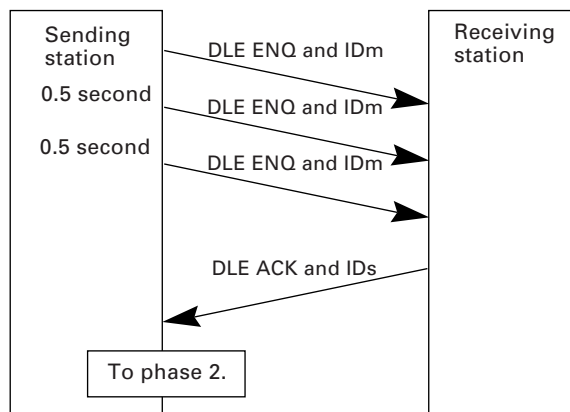

**TIP**

You may modify the number of iterations of a sequence of DLE ENQ and IDm for the sending station. The default is 60 times at 0.5-second intervals. For details, refer to the SET PROTOCOL screen in System Mode (pp. 62 and 64) and the XFILE statement given in "BHT-BASIC Programmer's Manual."

### ■ Abnormal termination of phase 1 (Abort of phase 1)

If the sending station receives no sequence of DLE ACK and ID's from the receiving station after sending a sequence of DLE ENQ and ID's 60 times in succession, it sends a sequence of DLE EOT and ID's to the receiving station after 0.5 second from the 60th sequence of DLE ENQ and ID's, then aborts the message transmission abnormally.

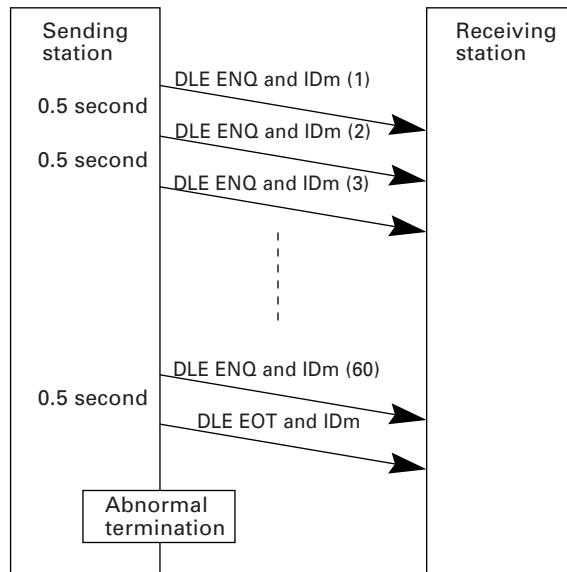

### TIP

The receiving station's default timeout is 30 seconds. You may modify the timeout length on the SET PROTOCOL screen in System Mode (pp. 62 and 64) or by using the XFILE statement (refer to the "BHT-BASIC Programmer's Manual").

## Phase 2: Data Transmission

### ■ Normal phase 2

The sending station first sends a transmission block containing the heading text. Each time the sending station receives a sequence of DLE ACK and IDs from the receiving station, it sends a transmission block containing the data texts as shown below. Upon receipt of a sequence of DLE ACK and IDs in response to the last transmission block (data text n), the sending station shifts to phase 3.

If a transmission message contains no data text, the sending station transmits the heading text only.

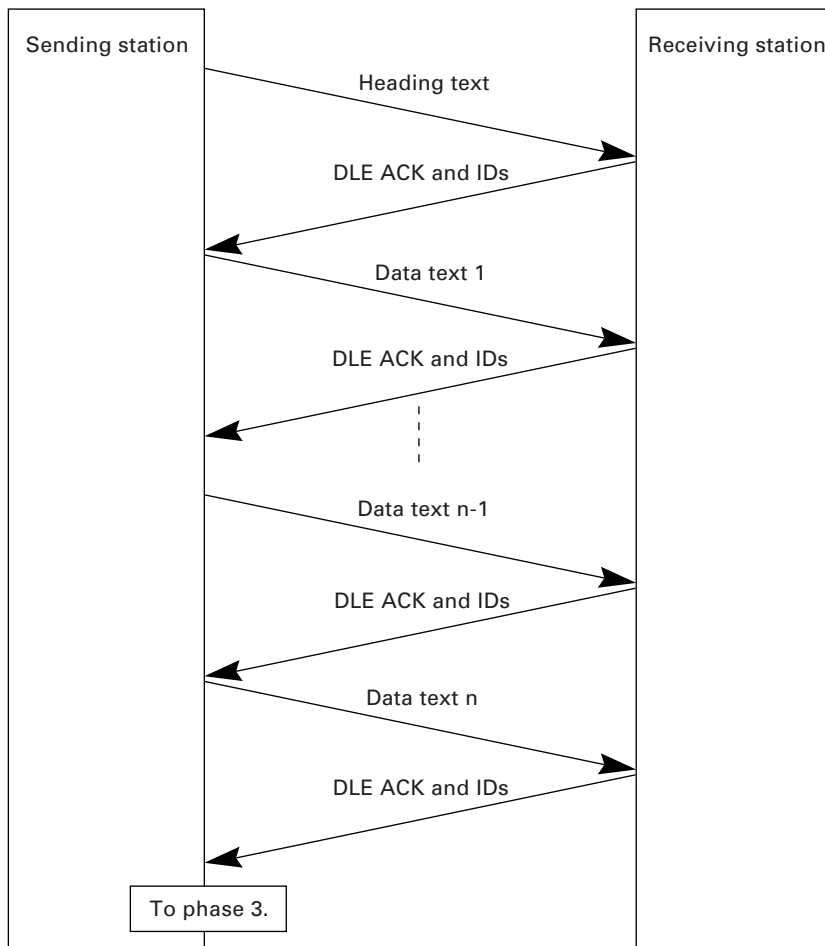



■ **Phase 2 with suspension of data reception for erasure of the flash memory**

If the receiving BHT requires the flash memory to be erased for receiving downloaded files, it sends a sequence of WACK and IDs to the sending station to suspend the data transmission.

Upon receipt of the sequence of WACK and IDs, the sending station stops the data transmission until any response comes from the receiving station for one minute. If no response comes within one minute, the sending station sends a sequence of DLE EOT and IDs and then aborts the current transmission.

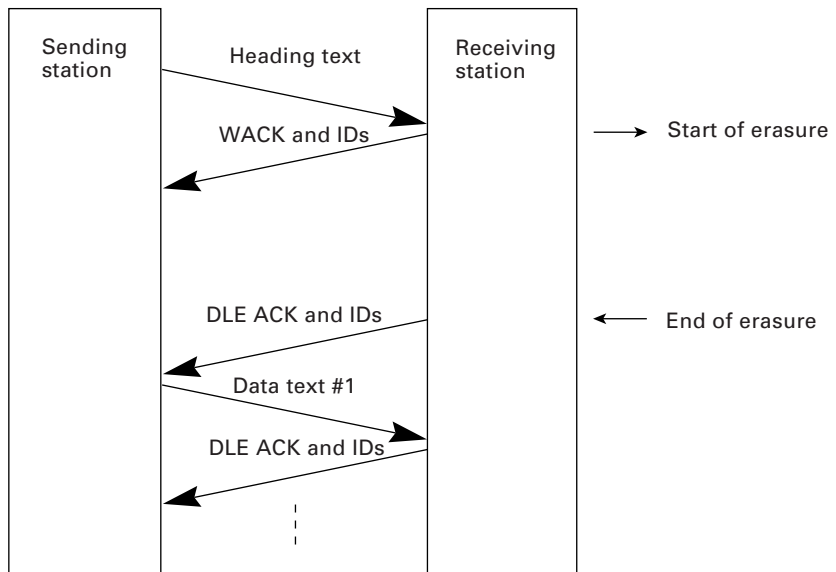

### ■ Phase 2 with a sequence of DLE NAK and IDs

If the sending station receives a sequence of DLE NAK and IDs from the receiving station in response to a transmission block containing text data  $m$ , it sends that transmission block again immediately as shown below.

If the sending station receives a sequence of DLE ACK and IDs before receiving the sequence of DLE NAK and IDs 10 times in succession, it continues the subsequent message transmission.

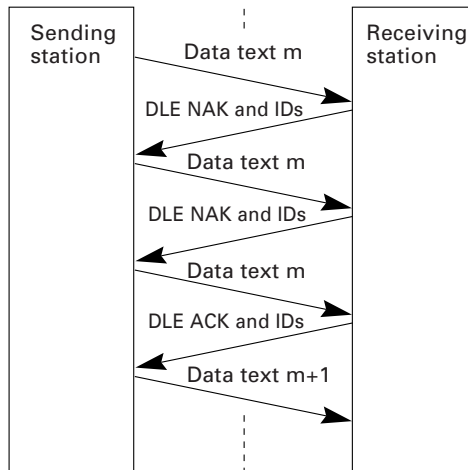

If the sending station receives a sequence of DLE NAK and IDs 10 times in succession or it fails to send a same transmission block, it shifts to phase 3 to terminate the message transmission abnormally. Even if phase 3 terminates normally, the transmission results in an abnormal end.

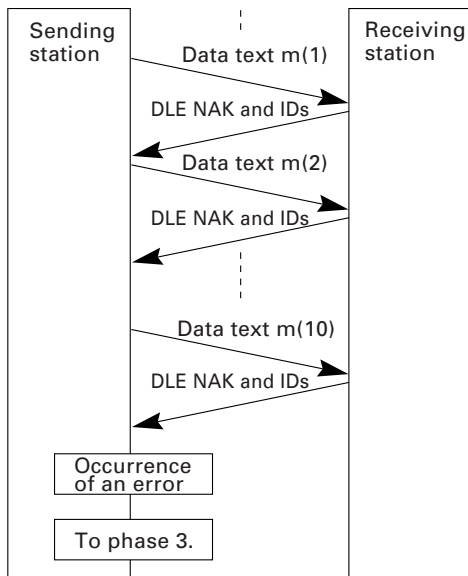

■ **Phase 2 with a sequence of DLE EOT and IDs**

If the sending station receives a sequence of DLE EOT and IDs anytime during phase 2, it shifts to phase 3 to terminate the message transmission abnormally. Even if phase 3 terminates normally, the transmission results in an abnormal end.

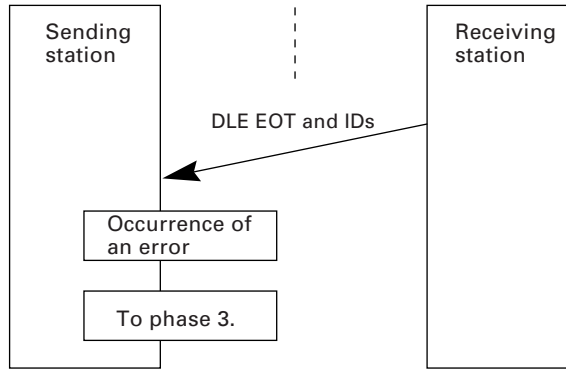

■ **Phase 2 with iterated transmission of DLE ENQ and IDs due to no response or invalid response**

If the sending station receives no response or any invalid response from the receiving station in response to a transmission block sent, it iterates sending of a sequence of DLE ENQ and IDs at 0.5-second intervals up to 59 times.

If the sending station receives a sequence of DLE ACK and IDs before sending the sequence of DLE ENQ and IDs 59 times, it continues the subsequent message transmission.

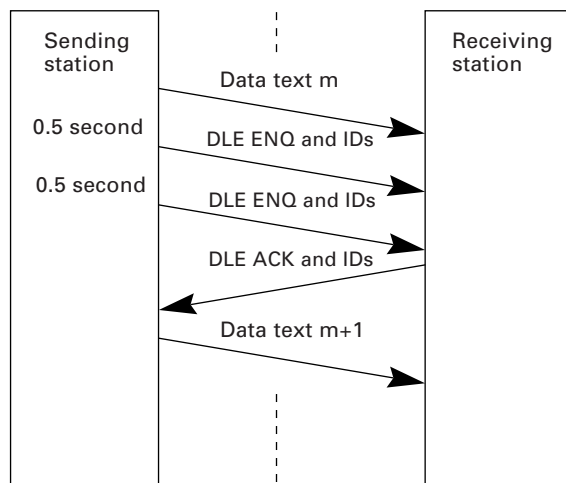

### ■ Abnormal termination of phase 2 (Abort of phase 2)

If the sending station receives no sequence of DLE ACK and IDs from the receiving station after sending a sequence of DLE ENQ and IDs 59 times in succession, it sends a sequence of DLE EOT and IDs to the receiving station after 0.5 second from the 59th sequence of DLE ENQ and IDs and then aborts this transmission abnormally.

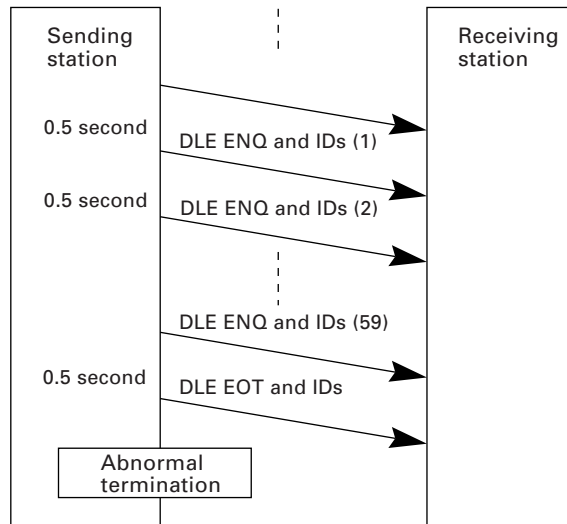

### Phase 3: Release of Data Link

#### ■ Normal phase 3

The sending station transmits a sequence of DLE EOT and IDs to the receiving station. Upon receipt of a sequence of DLE ACK and IDs from the receiving station, the sending station terminates the message transmission normally and releases the data link.

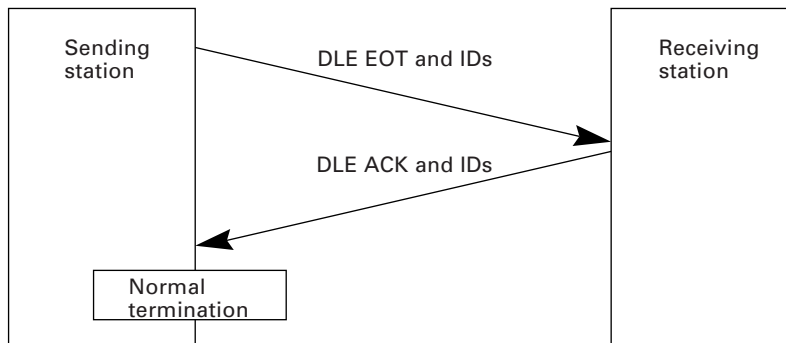

■ **Phase 3 with iterated transmission of DLE EOT and IDs due to no response or invalid response**

If the sending station receives no response or any invalid response from the receiving station in response to the sent sequence of DLE EOT and IDs, it iterates sending of the sequence at 0.5-second intervals up to 60 times.

If the sending station receives a sequence of DLE ACK and IDs before sending the sequence of DLE EOT and IDs 60 times, it terminates the message transmission normally and releases the data link.

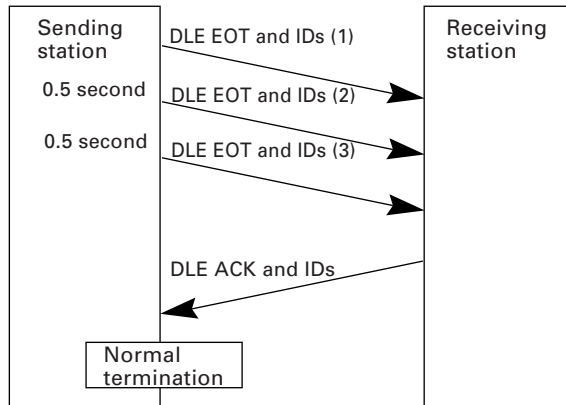

■ **Abnormal termination of phase 3**

If the sending station receives no sequence of DLE ACK and IDs from the receiving station within 0.5 second from the 60th sequence of DLE EOT and IDs, it aborts the message transmission abnormally and releases the data link.

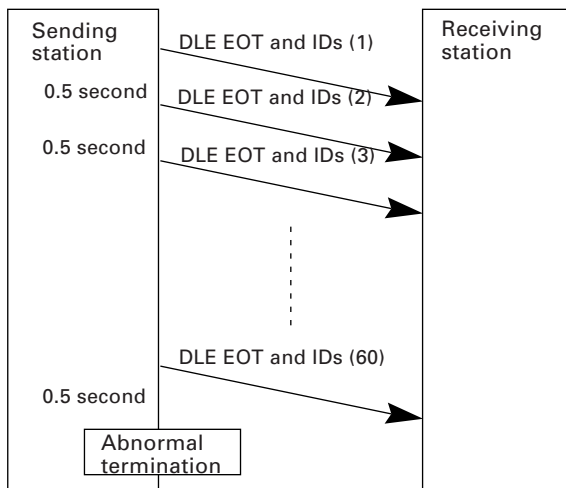

### ■ Phase 3 with timeout at the receiving station

If the receiving station receives no subsequent text or normal sequence of DLE EOT and IDs within 30 seconds after sending a sequence of DLE ACK and IDs, it sends a sequence of DLE EOT and IDs and aborts the transmission abnormally.

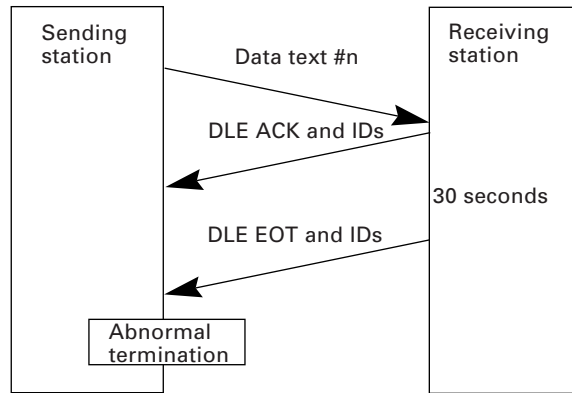

## [ 2 ] Aborting Data Transmission

Pressing the **C** key aborts data transmission.

If the **C** key is pressed during downloading, the BHT transmits a sequence of DLE EOT and IDs and aborts the file transmission.

If it is pressed during uploading, the BHT transmits the current transmission block followed by a sequence of DLE EOT and IDs and then aborts the file transmission.

### [ 3 ] CRC

To check whether data has been transmitted accurately, the BHT-Ir protocol supports CRC (Cyclic Redundancy Check) which employs the CRC-16 generating system. In CRC, a CRC character is suffixed to a sequence of DLE ETX of every transmission block.

#### Operands for CRC-16

The CRC generates CRC-16 from all bytes of a transmission block excluding DLE SOH or DLE STX characters (which are at the head of a transmission block), DLE character of DLE ETX and DLE character of DLE DLE in the text.

#### CRC operation

The CRC system generates CRC-16 as follows: It multiplies the polynomial formed by aligning all of the bits starting from the LSB of the first byte to the MSB of the last byte in a transmission block in descending order, by  $X^{16}$ . Next, divide the polynomial by the generative polynomial  $X^{16} + X^{15} + X^2 + 1$ . The remainder is the value of CRC-16.

Shown below is a data text transmission block and operands for CRC-16 generation.

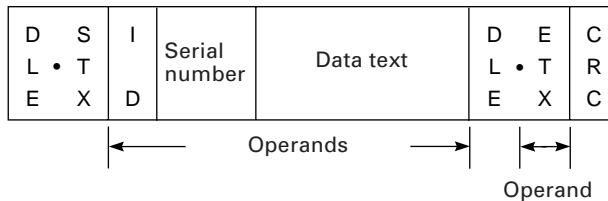

### [ 4 ] ID

ID is a 2-digit hexadecimal and designated in 0000h through FFFFh in (2 bytes). 0000h is assigned to the host computer. Any of 0001h through FFFFh is assigned to the BHT as follows.

- The system sets an ID when the BHT is initialized.
- You may set an arbitrary ID in System Mode or by using the OUT statement in BHT-BASIC.

# Appendix C.

## A Typical Basic Operation

What follows is a typical basic operation which helps you instruct the hands-on user in practical bar-code reading operation.

Application type: Inventory

Operation: Power ON → Read the bar code on stock (A). → Key in the quantity.  
 Read the bar code on stock (B). → Key in the quantity.  
 ⋮  
 Repeat the above operation.

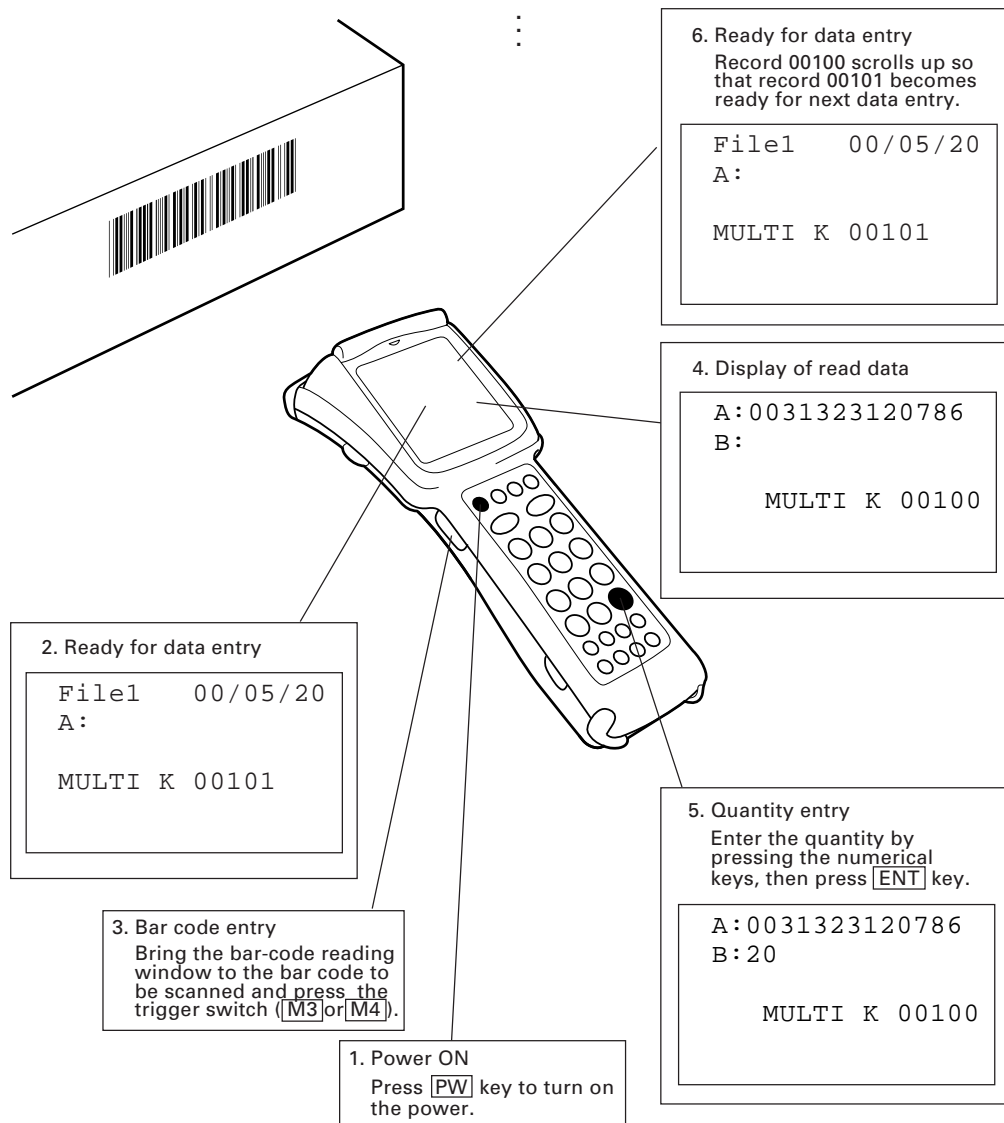



# **Bar Code Handy Terminal BHT-7500/7500S/7500W**

---

## **User's Manual**

First Edition, JUNE 2002

DENSO WAVE INCORPORATED

---

The purpose of this manual is to provide accurate information in the handling and operating of the BHT-7500/7500S/7500W. Please feel free to send your comments regarding any errors or omissions you may have found, or any suggestions you may have for generally improving the manual.

In no event will DENSO WAVE be liable for any direct or indirect damages resulting from the application of the information in this manual.

## Free Manuals Download Website

<http://myh66.com>

<http://usermanuals.us>

<http://www.somanuals.com>

<http://www.4manuals.cc>

<http://www.manual-lib.com>

<http://www.404manual.com>

<http://www.luxmanual.com>

<http://aubethermostatmanual.com>

Golf course search by state

<http://golfingnear.com>

Email search by domain

<http://emailbydomain.com>

Auto manuals search

<http://auto.somanuals.com>

TV manuals search

<http://tv.somanuals.com>