



America's Largest Chain Of Barbecue Stores

GAS LOG VENTED DECORATIVE APPLIANCE OWNER'S OPERATION AND INSTALLATION MANUAL

ANSI Z21.84



O-TL REPORT # 114-L-31-4

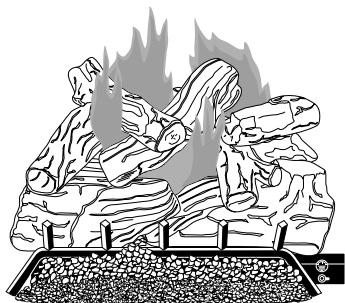

BVSR18, BVSR24, BVDR18, BVDR24, BVDR30

For Use with Log Sets:

American Pepper Log Models BAP18 and BAP24

Ponderosa Pine Log Models BOP18 and BOP24

Mossy Maple BMM18, BMM24 (Shown) and BMM30

Texas Mesquite Log Models BTM18, BTM24 and BTM30

⚠ WARNING: If the information in this manual is not followed exactly, a fire or explosion may result causing property damage, personal injury or loss of life.

- Do not store or use gasoline or other flammable vapors and liquids in the vicinity of this or any other appliance.
- **WHAT TO DO IF YOU SMELL GAS**
 - Do not try to light any appliance.
 - Do not touch any electrical switch; do not use any phone in your building.
 - Immediately call your gas supplier from a neighbor's phone. Follow the gas supplier's instructions.
 - If you cannot reach your gas supplier, call the fire department.
- Installation and service must be performed by a qualified installer, service agency or the gas supplier.

INSTALLER: Leave this manual with the appliance.
CONSUMER: Retain this manual for future reference.

For more information, visit www.desatech.com

TABLE OF CONTENTS

Safety	2	Inspecting Burners	15
Product Identification	4	Cleaning and Maintenance	15
Local Codes	4	Troubleshooting	16
Unpacking	4	Replacement Parts	19
Optional Product Features	4	Accessories	19
Installation	5	Parts	20
Operation	13	Warranty	Back Cover

SAFETY

⚠ WARNING: Improper installation, adjustment, alteration, service or maintenance can cause injury or property damage. Refer to this manual for correct installation and operational procedures. For assistance or additional information consult a qualified installer, service agency or the gas supplier.

⚠ WARNING: This appliance is for installation only in a solid-fuel burning masonry or UL127 factory-built fireplace, constructed of noncombustible material and connected to a working flue. (See page 5 for minimum flue opening.)

⚠ WARNING: This is a gas-fired appliance. It uses air (oxygen) from the room in which it is installed. Provisions for adequate combustion and ventilation air must be provided. Refer to the *National Fuel Gas Codes, ANSI Z233.1/NFPA 54, Air for Combustion and Ventilation*.

This appliance may be installed in an aftermarket,* permanently located, manufactured (mobile) home, where not prohibited by local codes.

* Aftermarket: Completion of sale, not for purpose of resale, from the manufacturer.

⚠ WARNING: This product contains and/or generates chemicals known to the State of California to cause cancer or birth defects or other reproductive harm.

⚠ WARNING: Keep flue open when operating unit.

IMPORTANT: Read this owner's manual carefully and completely before trying to assemble, operate or service this log set. Improper use of this log set can cause serious injury or death from burns, fire, explosion, electrical shock and carbon monoxide poisoning.

⚠ DANGER: Carbon monoxide poisoning may lead to death!

Carbon Monoxide Poisoning: Early signs of carbon monoxide poisoning resemble the flu, with headaches, dizziness or nausea. If you have these signs, the log set may not be working properly. **Get fresh air at once!** Have log set serviced. Some people are more affected by carbon monoxide than others. These include pregnant women, people with heart or lung disease or anemia, those under the influence of alcohol and those at high altitudes.

Natural Gas: Natural gas is odorless. An odor-making agent is added to the gas. The odor helps you detect a gas leak. However, the odor added to the gas can fade. Gas may be present even though no odor exists.

Make certain you read and understand all warnings. Keep this manual for reference. It is your guide to safe and proper operation of this log set.

SAFETY

Continued

 **WARNING: Any change to this log set or its controls can be dangerous.**

1. This appliance, as supplied, is only for use with the type of gas indicated on the rating plate. This appliance is convertible for use with propane/LP, using the GA9050A-1 or GA9150A pilot kit.
2. If you smell gas
 - shut off gas supply
 - do not try to light any appliance
 - do not touch any electrical switch; do not use any phone in your building
 - immediately call your gas supplier from a neighbor's phone. Follow the gas supplier's instructions
 - if you cannot reach your gas supplier, call the fire department
3. Never install the log set
 - in a recreational vehicle
 - where curtains, furniture, clothing or other flammable objects are less than 42" from the front, top or sides of the log set
 - in high traffic areas
 - in windy or drafty areas
4. Before installing in a solid fuel burning fireplace, the chimney flue and firebox must be cleaned of soot, creosote, ashes and loose paint by a qualified chimney cleaner. Creosote will ignite if highly heated. Inspect chimney flue and firebox for damage. If damaged, repair flue before operating heater.
5. You must operate this log set with a fireplace screen in place. Make sure fireplace screen is closed before running log set.
6. This log set is designed to be smokeless. If logs ever appear to smoke, turn off appliance and call a qualified service person.
Note: During initial operation, slight smoking could occur due to log curing and the burning of manufacturing residues. You may wish to add more ventilation by opening a window.
7. To reduce the creation of soot, follow the instructions in Cleaning and Maintenance, page 11.
8. Do not allow fans to blow directly into the fireplace. Avoid any drafts that alter burner flame patterns. Ceiling fans can create drafts that alter burner flame patterns. Altered burner patterns can increase sooting.
9. Do not use a blower insert, heat exchanger insert or other accessory not approved for use with this log set.
10. This installation and provisions for combustion and ventilation air must conform to the *National Fuel Gas Code, ANSI Z233.1/NFPA 54, Air for Combustion and Ventilation*.
11. Do not run log set
 - where flammable liquids or vapors are used or stored
 - under dusty conditions
12. Do not burn solid fuel in the fireplace after installing the log set. Do not use this log set to cook food or burn paper or other objects.
13. Log set becomes very hot when in use. Keep children and adults away from hot surface to avoid burns or clothing ignition. Log set will remain hot for a time after shutdown. Allow surface to cool before touching.
14. Carefully supervise young children when they are in the room with log set.
15. Do not use appliance if any part has been exposed to or under water. Immediately call a qualified service technician to inspect the room appliance and to replace any part of the control system (if using GA9050A-1 or GA9150A) and any gas control which has been under water.
16. To help prevent breakage, new logs must be broken-in (see Curing Logs, page 13).
17. Turn log set off and let cool before servicing, installing or repairing. Only a qualified service person should install, service or repair log set.
18. Provide adequate clearances around air openings.
19. Control knob may be hot when turning unit off. A 6" extension rod is available to make the knob more easily accessible and reduce temperature of control knob (see Accessories on page 19).

PRODUCT IDENTIFICATION

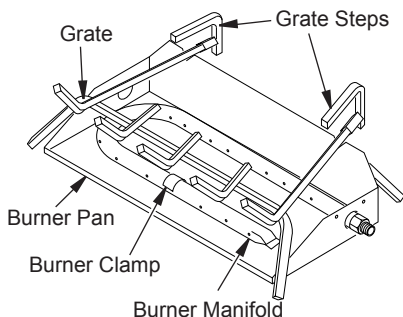

Hearth Kit Model _____

Serial Number _____

Log Set Model _____

Figure 1 - Product Identification (BVDR24 Shown)

LOCAL CODES

Install and use log set with care. Follow all local codes. In the absence of local codes, use the latest edition of *The National Fuel Gas Code ANSI Z223.1/NFPA 54**.

*Available from:

American National Standards Institute, Inc.
1430 Broadway
New York, NY 10018

National Fire Protection Association, Inc.
Batterymarch Park
Quincy, MA 02269

UNPACKING

CAUTION: Do not remove the data plates from the burner pan. The data plates contain important warranty and safety information.

1. Remove logs, hearth kit, pan materials and hardware from carton.
2. Remove all protective packaging applied to logs and base for shipment.
3. Check heater for any shipping damage. If heater is damaged call DESA Heating, LLC at 1-866-672-6040 for replacement parts before returning to dealer.

OPTIONAL PRODUCT FEATURES

ON/OFF SAFETY VALVE/PILOT KIT AND PROPANE/LP CONVERSION

An optional valve/safety pilot kit with a piezo ignitor is available for this appliance. This system requires no matches, batteries or other sources to light. You must use this optional system for LP conversion. See [Accessories](#), page 19.

REMOTE CONTROL READY (MILLIVOLT) SAFETY VALVE/PILOT KIT

An optional millivolt valve/safety pilot kit with a piezo ignitor is available for this appliance. This system requires no matches, batteries or other sources to light. This system may be connected to a wall switch or hand-held wireless remote control. See [Accessories](#), page 19.

REMOTE CONTROL ACCESSORIES

There is an optional hand-held ON/OFF remote control that can be purchased separately for this log set. You must use the millivolt valve/safety pilot kit to use remote accessories with this appliance. See [Accessories](#), page 19.

A wall switch is also available for this appliance. You must use the millivolt valve/safety pilot kit to use the wall switch with this appliance. See [Accessories](#), page 19.

INSTALLATION

⚠ WARNING: The Massachusetts State Board requires all installations be performed by a Licensed Plumber or Gas Fitter. Massachusetts state code requires all vent dampers be welded open or removed.

⚠ CAUTION: Do not remove the data plates attached to the burner pan. The data plates contain important warranty and safety information.

⚠ WARNING: Before installing in a solid fuel burning fireplace, the chimney flue and firebox must be cleaned of soot, creosote, ashes and loose paint by a qualified chimney cleaner. Creosote will ignite if highly heated. A dirty chimney flue may create and distribute soot within the house. Inspect chimney flue for damage.

NOTICE: Installation, service, and repair of this appliance must be performed by a qualified installer, service agency, company or gas supplier experienced with this type of gas appliance. Only factory authorized components listed in these instructions may be used in accordance with the manufacturer's instructions and all codes and requirements of the authority having jurisdiction. Any modifications to this kit, or use of unauthorized components or accessory items will void the manufacturer's warranty, and may result in a hazardous condition.

FLUE OPENING SPECIFICATIONS

Note: This vented appliance must be installed only in a solid-fuel burning fireplace with a working flue and constructed of noncombustible material.

The charts in Figure 2, page 6, indicate technical information regarding the installation of your gas log set. Please make sure that all of the specifications shown are applicable before installation is attempted.

The fireplace must include a working flue and venting system with minimum openings

INSTALLATION

Continued

MODEL	DESCRIPTION	Btu/Hr Input Natural Gas	Btu/Hr Input Propane/LP Gas	Minimum Vent Opening
BVSR18	18" Single Burner	50,000	40,000	8" dia.
BVSR24	24" Single Burner	60,000	50,000	8" dia.
BVDR18	18" Dual Burner	55,000	45,000	8" dia.
BVDR24	24" Dual Burner	65,000	55,000	8" dia.
BVDR30	30" Dual Burner	70,000	60,000	8" dia.

MINIMUM FIREBOX SIZES				
MODEL	FRONT WIDTH*	BACK WIDTH**	DEPTH	HEIGHT
18SR/DR	28"	16"	14"	18"
24SR/DR	29 3/4"	17"	15 1/2"	18"
30DR	36"	27"	18"	18"

* Add 6" if safety valve/pilot is used.

**At depth indicated.

LOG SIZE	BURNER ORIFICE			
	Natural		Propane/LP	
	In.	Num.	In.	Num.
18SR/DR	0.120	31	0.073	49
24SR/DR	0.129	30	0.086	44

	FUEL INLET PRESSURE SPECIFICATIONS (W.C.)	
	Min.	Max.
NG	5.5"	10.5"
LP	11"	13"

Figure 2 - Technical Information Charts

CHECK GAS TYPE

Use only natural gas. If your gas supply is not natural gas, you must install ON/OFF Safety Valve/Pilot Kit (see *Accessories*, page 19). Call dealer where you bought your log set.

If the fireplace does not have a gas supply shutoff valve, one must be installed.

VENTING SPECIFICATIONS FOR INSTALLATION

Fireplace chimney flue and vent must be drafting properly. To check vent for proper drafting: Light a tightly rolled newspaper on one end and place at inside front edge of fireplace. Observe smoke and be sure vent is properly drawing it up the chimney. If smoke spills out into room, extinguish flame and remove any obstruction until proper venting is achieved.

Chimney flue damper must be fixed open to provide a minimum of 64 sq. in. of free air opening during operation of this log set. A multipurpose damper clamp is provided to fix the damper in position.

INSTALLING DAMPER CLAMP

Secure damper stop clamp provided to leading edge of damper as shown in Figure 3. If for any reason this clamp doesn't work on your fireplace, another suitable clamp or permanent stop must be installed, or damper blade must be cut or removed.

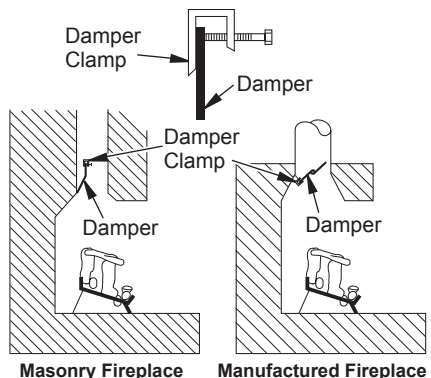

Figure 3 - Attaching Damper Clamp

INSTALLATION

Continued

CONNECTING TO GAS SUPPLY

⚠ WARNING: A qualified service person must connect log set to gas supply. Follow all local codes.

Installation Items Needed

Before installing log set, make sure you have the items listed below.

- piping (check local codes)
- sealant (resistant to propane/LP gas)
- equipment shutoff valve
- test gauge connection
- adjustable (crescent) wrench or pliers
- sediment trap
- tee joint
- pipe wrench

⚠ CAUTION: Use only new, black iron or steel pipe. Internally-tinned copper tubing may be used in certain areas. Check your local codes. Use pipe of 1/2" diameter or greater to allow proper gas volume to log set. If pipe is too small, undue loss of volume will occur.

Installation must include an equipment shutoff valve, union, and a plugged 1/8" NPT tap. Locate NPT tap within reach for test gauge hook up. NPT tap must be upstream from log set (see Figure 4).

IMPORTANT: Install equipment shutoff valve in an accessible location. The equipment shutoff valve is for turning on or shutting off gas to appliance.

Apply pipe joint sealant lightly to male NPT threads. This will prevent excess sealant from going into pipe. Excess sealant in pipe could result in a clogged burner injector.

⚠ WARNING: Use pipe joint sealant that is resistant to liquid petroleum (LP) gas.

We recommend that you install a sediment trap in the supply line as shown in Figure 4. Locate sediment trap where it is within reach for cleaning. Install in piping system between fuel supply and heater. Locate sediment trap where trapped matter is not likely to freeze. A sediment trap traps moisture and contaminants. This keeps them from going into log set controls. If sediment trap is not installed or is installed wrong, log set may not run properly.

Approved Flexible Gas Hose (if allowed by local codes)

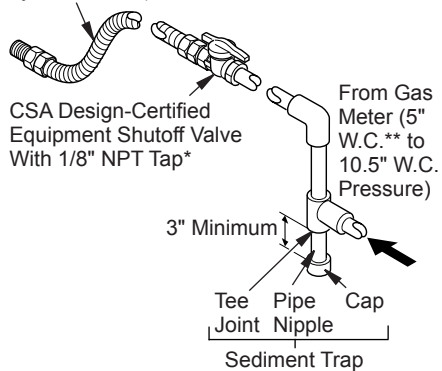

Figure 4 - Gas Connection

* Purchase the optional CSA design-certified equipment shutoff valve from your dealer.

** Minimum inlet pressure for purpose of input adjustment.

INSTALLATION

Continued

CHECKING GAS CONNECTIONS

WARNING: Test all gas piping and connections, internal and external to unit, for leaks after installing or servicing. Correct all leaks at once.

WARNING: Never use an open flame to check for a leak. Apply a noncorrosive leak detection fluid to all joints. Bubbles forming show a leak. Correct all leaks at once.

PRESSURE TESTING GAS SUPPLY PIPING SYSTEM

Test Pressures In Excess Of 1/2 PSIG (3.5 kPa)

1. Disconnect log set and its individual equipment shutoff valve from gas supply piping system.
2. Cap off open end of gas pipe where equipment shutoff valve was connected.
3. Pressurize supply piping system by either using compressed air or opening main gas valve located on or near gas meter.
4. Check all joints of gas supply piping system. Apply a noncorrosive leak detection fluid to all joints. Bubbles forming show a leak.
5. Correct all leaks at once.
6. Reconnect log set and equipment shutoff valve to gas supply. Check reconnected fittings for leaks.

Test Pressures Equal To or Less Than 1/2 PSIG (3.5 kPa)

1. Close equipment shutoff valve (see Figure 5).
2. Pressurize supply piping system by either using compressed air or opening main gas valve located on or near gas meter.
3. Check all joints from gas meter to equipment shutoff valve (see Figure 6). Apply a noncorrosive leak detection fluid to all joints. Bubbles forming show a leak.
4. Correct all leaks at once.

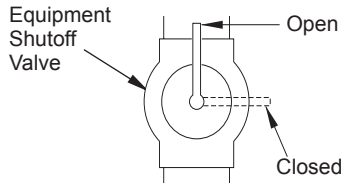

Figure 5 - Equipment Shutoff Valve

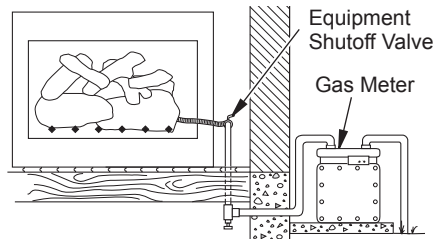

Figure 6 - Checking Gas Joints

HEARTH KIT ASSEMBLY AND INSTALLATION

Kit Assembly

Note: The following instructions apply to both standard single bar burners, as well as dual flame "U" style burners. Be sure all pipe threaded connections are tight, and have thread compound to prevent leaks.

1. Determine which side the gas line will be coming into the fireplace.
2. Using a hammer and screw driver, remove knock-out plug from the side of the pan that corresponds to the gas line (see Figure 7).
3. Unscrew burner inlet fitting from burner manifold (see Figure 8, page 9).
4. Place burner manifold in pan with threaded opening facing open knock-out plug.

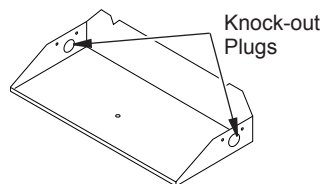

Figure 7 - Knock-Out Plug Locations

INSTALLATION

Continued

- Using thread sealant (resistant to the action of propane/LP gas) on larger end of fitting, screw the burner inlet fitting through hole and into burner manifold. Tighten using a wrench. If using propane/LP gas, see [Propane/LP Gas Conversion](#), page 10.
- Using burner clamp, screw, and nut provided, assemble clamp to pan ("U" style burners only). This will hold the burner manifold in place.
- If using optional GA9050A-1 kit, go to [Optional GA9050A-1 On/Off Safety Valve/Pilot Kit Assembly](#) for installation instructions. If using optional GA9150A kit, follow instructions included with kit for installation and operation.

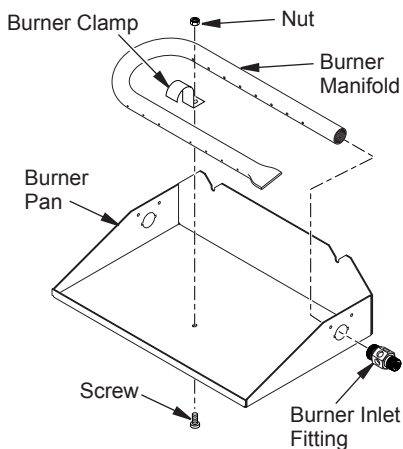

Figure 8 - Installing Burner

Installation and Gas Connection

- Place burner pan assembly in center of fireplace floor. Make sure inlet end of pan faces gas supply.
- Thread gas supply fitting to fireplace gas supply pipe. Use thread sealant.
- Install adapter fitting onto burner inlet fitting using thread sealant on male threads of burner inlet fitting (see Figure 6). Adjust to most convenient position.
- Install gas connector tube to gas supply fitting. Carefully shape tube to attach to adapter fitting. Be careful not to cause kinks in tube.

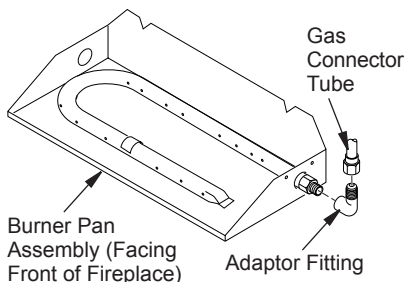

Figure 9 - Installing Burner

OPTIONAL GA9050A-1 ON/OFF SAFETY VALVE/PILOT KIT ASSEMBLY

For additional convenience and safety, or for propane/LP conversion, an optional ON/OFF safety valve/pilot kit is available. See [Accessories](#), page 19.

WARNING: You must use a ON/OFF safety valve/pilot kit for propane/LP conversion.

Natural Gas Installation

- Thread the gas control valve onto the burner inlet fitting (see Figure 10). Use thread sealant on the male threads of the burner inlet fitting. Hold the burner inlet fitting with a wrench to prevent overtightening the connection to the burner. Make sure the control rod is facing the front (see Figure 10).

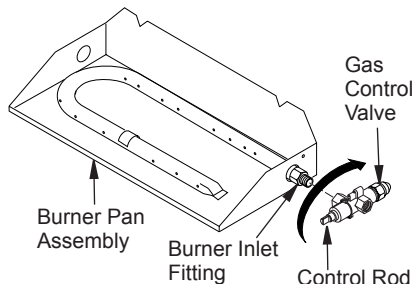

Figure 10 - Installing Gas Control Valve

INSTALLATION

Continued

2. Attach the pilot gas line to the pilot outlet of the gas control valve and tighten. Connect the thermocouple to the rear of the gas control valve. See Figure 11. Do not overtighten. If using propane/LP gas, see [Changing Pilot Orifice](#), page 11.
3. Install the inlet fitting into the inlet opening of the gas control valve (see Figure 12). Use thread sealant on the male pipe threads.
4. Place the burner pan assembly in the center of the fireplace floor. Make sure the front of pan faces forward.
5. Thread the gas supply fitting to the fireplace gas supply pipe. Adjust to most convenient position.
6. Install the gas connector tube to the gas supply fitting. Carefully shape tube to attach to adapter fitting. Be careful not to cause kinks in tube.
7. Test for leaks following instructions under [Testing Burner for Leaks](#), page 12.
8. Retighten and adjust the location of the gas control as necessary. The gas control should be level, with the control rod to the front.
9. Attach cover to burner pan using screws provided.
10. Install thermocouple, pilot, and ignitor onto valve cover as shown in Figure 13. Use the provided screws.
11. Push the control rod extension onto the "D" shaped control rod through the center hole in the cover.
12. Install the control position decal and control knob making sure to align the marks with the correct stop positions of the gas control. Pilot position will allow the knob to push in about 1/2". Align the decals in the pilot position.

Note: Pilot valve adjustment screw may need to be opened. See [Inspecting Burners](#), page 15 for instructions.

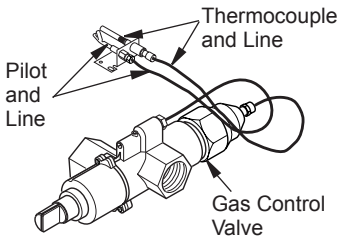

Figure 11 - Gas Control Valve with Thermocouple and Pilot

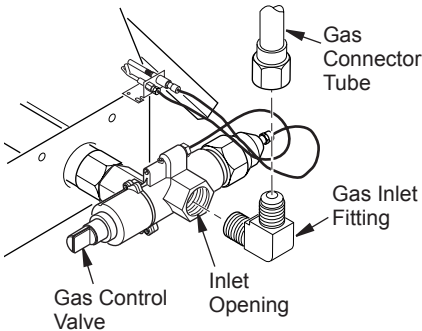

Figure 12 - Installing Inlet Fitting and Gas Connector Tube

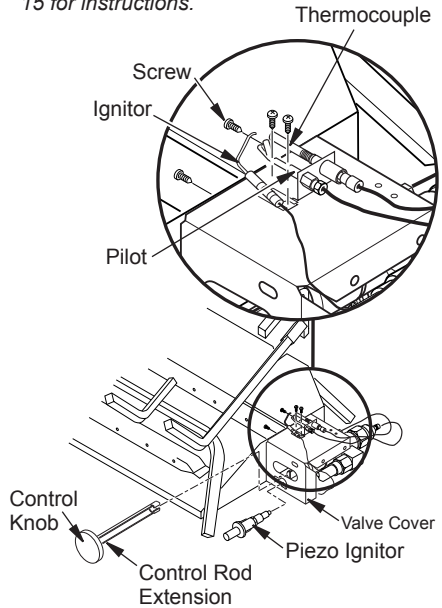

Figure 13 - Installing Cover, Control Knob and Piezo Ignitor

Propane/LP Gas Conversion

To convert to propane/LP gas, the burner inlet fitting and pilot orifice must be replaced. The propane/LP burner inlet fitting is supplied with orifice installed for a 24" log set. If you have an 18" or 30" log set, you must change this orifice also. See Figure 1, page 4 for product identification.

INSTALLATION

Continued

Burner Inlet Fitting

1. Remove burner inlet fitting from burner pan assembly. DO NOT remove orifice from this fitting. The propane/LP burner inlet fitting is included in the hardware kit (see Figure 14).
2. Be sure to use correct orifice for your appliance. The hardware kit included with this appliance contains two orifices with a cone-like shape. If you have an 18" set, orifice for burner inlet fitting is red; for a 30" set, it is black. If you have a 24" log set, orifice is already installed inside fitting.
3. For an 18" or 30" set, use a 10 mm socket or nut driver to remove orifice from propane/LP burner inlet fitting. Choose correct orifice for your log set size and install in place of orifice you just removed.
4. Using thread sealant (resistant to action of propane/LP gas) on larger end of fitting, screw burner inlet fitting through hole and into burner manifold, see Figure 15. Tighten using a wrench.
5. Follow steps 1 through 12 under Natural Gas Installation, page 9.

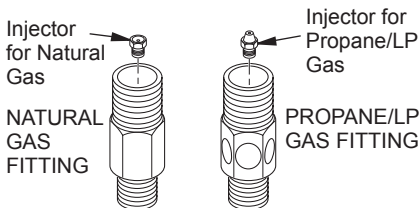

Figure 14 - Burner Inlet Fittings with Injectors

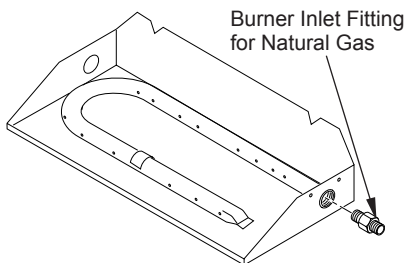

Figure 15 - Remove Burner Inlet Fitting

Changing Pilot Orifice

The pilot is provided with a natural gas orifice installed. For propane/LP gas you must remove it and replace it with a propane/LP orifice. The hardware kit contains a propane/LP orifice with a red stripe for converting the pilot.

1. Gently loosen and remove the pilot line connection from the bracket (see Figure 16).
2. Replace the injector with the propane/LP pilot injector with the red stripe (see Figure 16).
3. Replace and tighten the pilot line to the bracket.
4. Continue with step 3 under Natural Gas Installation, page 10.

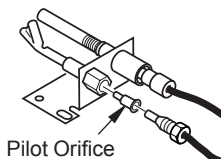

Figure 16 - Installing Propane/LP Pilot Orifice

Pilot Flow Adjustment

After installation is complete and the unit has been ignited, it may be necessary to adjust the pilot. Use a small flat-head screwdriver to turn the flow adjustment screw on the manual control valve (see Figure 17). Turn the screw counterclockwise to allow more gas to flow or clockwise to restrict gas flow. Be careful to limit the turns to 2 1/2 from the fully closed position. Further turning can result in gas leaking at the adjustment screw and the pilot flame size will diminish. The proper pilot flow will result in a strong blue flame between 1/2" and 1" long.

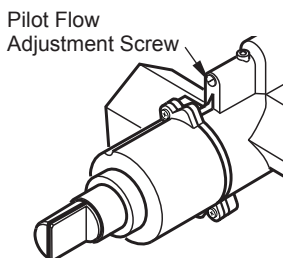

Figure 17 - Pilot Flow Adjustment Screw

INSTALLATION

Continued

TESTING BURNER FOR LEAKS

1. Generously apply noncorrosive leak detection fluid to all connections.

⚠ WARNING: Never check for gas leaks with open flame.

2. Light the burner with the shutoff valve no more than half open and holding a match slightly in front of the pan (see *Lighting Instructions*, page 13).
3. Inspect all connections for bubbles, raw gas odor, or flame from any area other than the burner (leaks). If leaks are detected, shut off the gas valve immediately. Tighten, or reassemble the loose connection(s) using pipe joint compound until burner system is leak free.
4. When the burner is tested and leak free, observe the individual tongues of flame on the burner.

Note: The burner design includes more ports on the outside of the bar. Make sure that all ports are clear and producing flame evenly across the burner. If any ports appear blocked, clear them by removing the burner manifold and reaming the ports with a modified paper clip or other suitable tool.

5. When finished testing, turn the gas shut-off valve OFF to extinguish all flames.

ADDING PAN MATERIAL

1. Open the bag of ash bed material (vermiculite) and spread it evenly across the burner pan to the top. You may overflow the front and sides of the pan to cover the entire pan and connecting hardware. Do not cover GA9050A-1 or GA9150A valve.
2. Open the glowing embers and evenly cover the ash bed material (vermiculite) in the burner pan.

INSTALLING GRATE AND LOGS

1. Place the grate over the burner pan where the two outer horizontal supports on the grate fit into the two pan positioning notches in the rear vertical edge of the pan.
2. Slide the two rear log grate steps over the two outer horizontal supports on the grate as shown in Figure 18.

3. Place the back log onto the grate steps (see Figure 19).
4. Place the front log(s) onto grate and slide forward against the front bars of grate (see Figure 19).
5. Place the smaller top logs onto the bottom logs (see Figure 20, page 13). Leave as much open space between logs as possible to minimize flame impingement and sooting.

Note: Logs may chip if they are handled roughly or if hit together while being placed.

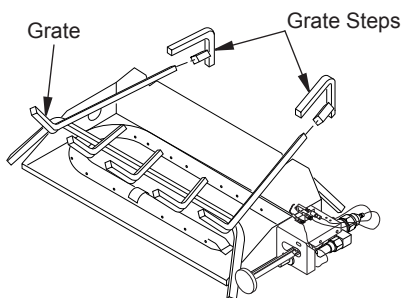
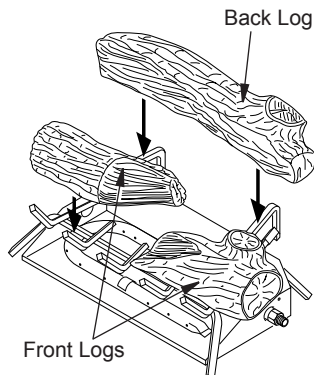

Figure 18 - Installing Grate (Pan Material Not Shown)



**Mossy Maple
Logs Shown**

Figure 19 - Installing Front and Back Logs (Number and Style of Logs May Vary)

INSTALLATION

Continued

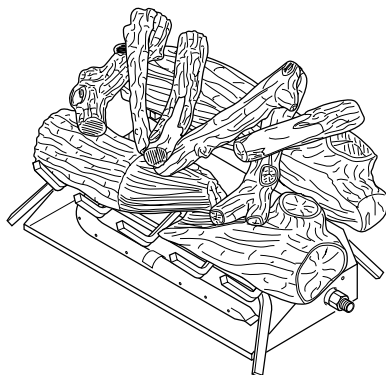

Figure 20 - Placement of Top Logs
(Mossy Maple Logs Shown)

OPERATION

**FOR YOUR SAFETY
READ BEFORE LIGHTING**

WARNING: Keep flue open when operating unit.

WARNING: If you do not follow these instructions exactly, a fire or explosion may result causing property damage, personal injury or loss of life.

BEFORE LIGHTING smell all around the appliance area for gas. Be sure to smell next to the floor because some gas is heavier than air and will settle on the floor.

WHAT TO DO IF YOU SMELL GAS

- Do not try to light any appliance.
- Do not touch any electric switch; do not use any phone in your building.
- Immediately call your gas supplier from a neighbor's phone. Follow the gas supplier's instructions.
- If you cannot reach your gas supplier, call the fire department.

**LIGHTING
INSTRUCTIONS**

1. STOP! Read safety information, above.
2. Turn the gas shutoff valve clockwise ↻ to OFF.
3. Wait five (5) minutes to clear out any gas. If you then smell gas STOP! Follow the safety information column 1. If you don't smell gas, go on to next step.
4. Light a match and lay it on top of pan material about 2" from end of supply side of pan
5. Slowly turn gas shutoff valve counterclockwise ↻ to ON the position until burner ignites. If burner doesn't ignite within 10 seconds with match burning, turn shutoff valve clockwise ↻ to OFF and repeat steps 1 through 4 again.

**GAS SHUTOFF
VALVE OPERATION**

Flame Adjustment

Adjust the flame ON/OFF by turning the gas shutoff valve counterclockwise ↻ to open or clockwise ↻ to close, as necessary.

Shutting Off Appliance

Turn gas shutoff valve clockwise ↻ to the OFF position.

OPERATION

Continued

CURING LOGS

During the 2-3 hour appliance break-in period, you may detect an odor from appliance as various paints and compounds used in manufacturing of this log set cure. This is a normal and temporary situation that is not cause for alarm. However, you may want to provide extra ventilation to the room during this time.

To ensure proper curing of the logs:

- Ignite a 2" flame and maintain it for 1 hour.
- Burn logs in consecutive 1 hour periods raising flame an additional 2" to full flame height for a total of three hours.

OPERATING INSTRUCTIONS FOR GA9050A-1

Note: Operation instructions for GA9150A Remote Ready Valve/Pilot Kit will be included with the kit.

1. STOP! Read the safety information, page 13.
2. Make sure equipment shutoff valve is fully open.
3. Press in and turn control knob clockwise to the OFF position.
4. Wait five (5) minutes to clear out any gas. Then smell for gas around log set and near floor. If you smell gas, STOP! Refer to the *National Fuel Gas Codes, ANSI Z233.1/NFPA 54, Air for Combustion and Ventilation*. If you don't smell gas, go to the next step.
5. Turn control knob counterclockwise to the PILOT position and press in (see Figure 21). Keep control knob pressed in for five (5) seconds.

Note: You may be running this log set for the first time after hooking up to gas supply. If so, the control knob may need to be pressed in for 30 seconds or more. This will allow air to bleed from the gas system.

- If control knob does not pop up when released, contact a qualified service person or gas supplier for repairs.

6. With control knob pressed in, push down and release ignitor button. This will light pilot. The pilot is attached to the rear of the front burner. If needed, keep pressing ignitor button until pilot lights.

Note: If pilot does not stay lit, contact a qualified service person or gas supplier for repairs. Until repairs are made, light pilot with match

7. Keep control knob pressed in for 30 seconds after lighting pilot. After 30 seconds, release control knob.
Note: If pilot goes out, repeat steps 3 through 7.
8. Turn control knob counterclockwise to the ON position. Burner should light. If burner does not light, call a qualified service person.
9. To leave pilot lit and shut off burners only, turn control knob clockwise to the PILOT position.

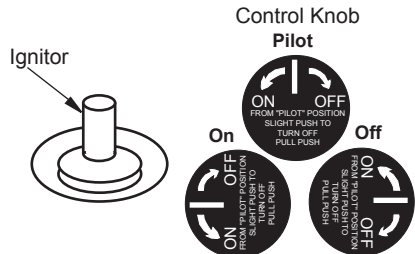

Figure 21 - Ignitor and Control Knob

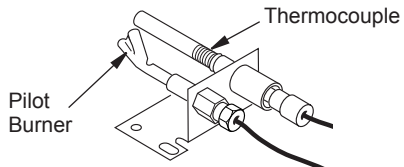

Figure 22 - Thermocouple and Pilot

TO TURN OFF GAS TO APPLIANCE

1. Turn control knob clockwise to the PILOT position.
2. Press in and turn control knob clockwise to the OFF position.
3. Close equipment shutoff valve (see Figure 5, page 8).

INSPECTING BURNERS

Check pilot flame pattern and burner flame patterns often.

PILOT ASSEMBLY

The pilot assembly is factory preset for proper flame height. Alterations may have occurred during shipping and handling. The pilot is located on back right hand side of burner.

The thermocouple should be fully enveloped in flame. Flame should not be lifting off thermocouple element.

If your pilot assembly does not meet these requirements:

- Access pilot adjustment screw through slot in valve cover. Turn adjustment screw clockwise to decrease or counterclockwise to increase flame to proper size (see Figure 17, page 11). Do not remove adjustment screw.
- see [Troubleshooting](#), page 16

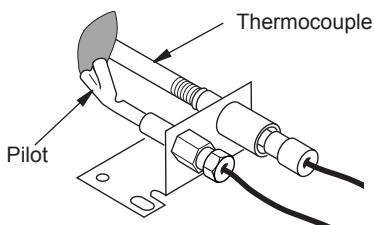

Figure 23 - Correct Pilot Flame Pattern

BURNER FLAME PATTERN

Burner flames will be steady; not lifting or floating. Flames should go up through the middle of log set. Flames should not "spill" to edges of pan or sides of log set.

Figure 24 shows a typical flame pattern. If burner flame pattern differs from that described:

- turn appliance off (see [To Turn Off Gas to Appliance](#), page 14)
- see [Troubleshooting](#), page 16

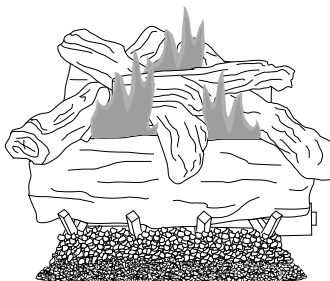

Figure 24 - Typical Flame Pattern

CLEANING AND MAINTENANCE

- Keep area around log set clean and clear of debris.
- Occasionally, you may use a soft bristle brush to clean logs.
- Periodically inspect air mixer and burner tube for foreign matter blocking air inlet and flame holes.
- Once every year a qualified agency or certified chimney sweep should examine and clean venting system of fireplace.

TROUBLESHOOTING



WARNING: Turn off log set and let cool before servicing. Only a qualified service person should service and repair log set.

Note: All troubleshooting items are listed in order of operation.

OBSERVED PROBLEM	POSSIBLE CAUSE	REMEDY
<p>Log set is smoking/sooting excessively <i>(Note: It is natural and unavoidable for vented gas log sets to produce moderate levels of carbon (soot) where flames contact the logs. This is especially true with propane/LP gas.)</i></p>	<ol style="list-style-type: none"> 1. Poor fuel quality 2. Fireplace venting system not drafting properly 3. Excessive flame impingement or blockage 4. Improper fuel/air mixture 5. Excessive gas supply/pressure 	<ol style="list-style-type: none"> 1. Contact local natural or propane/LP gas company 2. Adjust damper wide open and/or have fireplace and venting professionally cleaned and checked 3. Separate the logs to allow more flame passage 4. Remove any foreign items from the flame pattern and/or check for proper orifice sizing 5. Preheat flue in very cold weather
<p>Burner is excessively noisy <i>(Note: The movement and combustion of gas will create low, unavoidable levels of noise.)</i></p>	<ol style="list-style-type: none"> 1. Passage of air/gas across irregular surfaces 	<ol style="list-style-type: none"> 1. Relieve any tight bends or kinks in gas supply line
<p>Burner flame is too low or too high</p>	<ol style="list-style-type: none"> 1. Incorrect gas supply or pressure 2. Blocked burner orifice or burner manifold ports 3. Improper burner orifice size 	<ol style="list-style-type: none"> 1. Check for proper gas supply pressure 2. Free burner orifice and manifold ports of any burrs, paint, or other blockage 3. Verify proper burner orifice sizing (see Figure 2, page 6)
<p>When ignitor button is pressed, there is no spark at pilot (GA9050A-1 Only)</p>	<ol style="list-style-type: none"> 1. Ignitor electrode not connected to ignitor cable 2. Ignitor cable pinched or wet 3. Bad ground on piezo ignitor 4. Broken ignitor cable 5. Bad piezo ignitor 6. Ignitor electrode broken 7. Ignitor electrode positioned wrong 	<ol style="list-style-type: none"> 1. Reconnect ignitor cable 2. Free ignitor cable if pinched by any metal or tubing. Keep ignitor cable dry 3. Scrape away paint on bracket for better contact with ground on piezo ignitor 4. Replace ignitor cable 5. Replace piezo ignitor 6. Replace electrode 7. Reposition electrode

TROUBLESHOOTING

Continued

OBSERVED PROBLEM	POSSIBLE CAUSE	REMEDY
When ignitor button is pressed, there is spark at pilot but no ignition (GA9050A-1 Only)	<ol style="list-style-type: none"> 1. Gas supply turned off or equipment shutoff valve closed 2. Control knob not in PILOT position 3. Control knob not pressed in while in PILOT position 4. Air in gas lines when installed 5. Pilot adjustment screw closed 6. Pilot is clogged 7. Low gas pressure 	<ol style="list-style-type: none"> 1. Turn on gas supply or open equipment shutoff valve 2. Turn control knob to PILOT position 3. Press in control knob while in PILOT position 4. Continue holding down control knob. Repeat igniting operation until air is removed 5. Adjust pilot flame for approximately 2" blue flame 6. Clean pilot (see Cleaning and Maintenance, page 15) or replace pilot assembly 7. Replace gas control
Pilot lights but flame goes out when control knob is released (GA9050A-1 Only)	<ol style="list-style-type: none"> 1. Control knob not fully pressed in 2. Control knob not pressed in long enough 3. Equipment shutoff valve not fully open 4. Pilot flame not touching thermocouple, which allows thermocouple to cool, causing pilot flame to go out. This problem could be caused by one or both of the following: A) Low gas pressure B) Dirty or partially clogged pilot 5. Thermocouple connection loose at control valve 6. Thermocouple damaged 7. Control valve damaged 	<ol style="list-style-type: none"> 1. Press in control knob fully 2. After pilot lights, keep control knob pressed in 30 seconds 3. Fully open equipment shutoff valve 4. A) Contact local natural gas company B) Clean pilot (see Cleaning and Maintenance, page 15) or replace pilot assembly 5. Hand tighten until snug, then tighten 1/4 turn more 6. Replace thermocouple 7. Replace control valve
Burner does not light after pilot is lit (GA9050A-1 Only)	<ol style="list-style-type: none"> 1. Burner orifice clogged 2. Inlet gas pressure is too low 3. Burner orifice diameter is too small 4. Thermocouple leads disconnected or improperly connected 	<ol style="list-style-type: none"> 1. Clean burner orifice 2. Contact local natural or propane/LP gas company 3. Replace burner orifice 4. Reconnect leads
Delayed ignition burner (GA9050A-1 Only)	<ol style="list-style-type: none"> 1. Pilot flame needs adjusting 2. Wrong pilot orifice 	<ol style="list-style-type: none"> 1. Adjust pilot flame for approximately 2" blue flame 2. Replace pilot orifice set

TROUBLESHOOTING

Continued



WARNING: If you smell gas

- Shut off gas supply.
- Do not try to light any appliance.
- Do not touch any electrical switch; do not use any phone in your building.
- Immediately call your gas supplier from a neighbor's phone. Follow the gas supplier's instructions.
- If you cannot reach your gas supplier, call the fire department.

IMPORTANT: Operating log set where impurities in air exist may create odors. Cleaning supplies, paint, paint remover, cigarette smoke, cements and glues, new carpet or textiles, etc., create fumes. These fumes may mix with combustion air and create odors. These odors will disappear over time.

OBSERVED PROBLEM	POSSIBLE CAUSE	REMEDY
Log set produces a clicking/ticking noise just after burner is lit or shut off	1. Metal expanding while heating or contracting while cooling	1. This is normal with most log sets. If noise is excessive, contact qualified service person
Log set produces unwanted odors	1. Log set burning vapors from paint, hair spray, glues, cleaners, chemicals, new carpet, etc. (See <i>IMPORTANT</i> statement above) 2. Gas leak. See Warning statement at top of page	1. Open flue to maximum. Stop using odor causing products while log set is running 2. Locate and correct all leaks (see <u>Checking Gas Connections</u> , page 8)
Gas odor even when control knob is in OFF position	1. Gas leak. See Warning statement at top of page 2. Control valve defective	1. Locate and correct all leaks (see <u>Checking Gas Connections</u> , page 8) 2. Replace control valve
Gas odor during combustion	1. Gas leak. See Warning statement at top of page	1. Locate and correct all leaks (see <u>Checking Gas Connections</u> , page 8)

REPLACEMENT PARTS

Note: Use only original replacement parts. This will protect your warranty coverage for parts replaced under warranty.

PARTS UNDER WARRANTY

Contact authorized dealers of this product. If they can't supply original replacement part(s), call DESA Heating, LLC at 1-866-672-6040. When calling DESA Heating, LLC, have ready:

- your name
- your address
- model and serial numbers of your heater
- how heater was malfunctioning

Usually, we will ask you to return the part to the factory.

PARTS NOT UNDER WARRANTY

Contact authorized dealers of this product. If they can't supply original replacement part(s), call DESA Heating, LLC at 1-866-672-6040 for referral information. A list of authorized dealers can be found by visiting www.desatech.com. When calling DESA Heating, LLC, have ready:

- model and serial numbers of your heater
- the replacement part number

ACCESSORIES

Purchase these log set accessories from your local dealer. If they can not supply these accessories, call DESA Heating Products at 1-866-672-6040 for referral information. You can also write to the address listed on the back page of this manual.

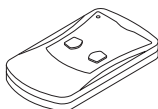

RECEIVER AND HAND-HELD REMOTE CONTROL KIT - HRC100 SERIES

For all models. Allows the gas log set to be turned on and off by using a hand-held remote control. Valve/Pilot Kit GA9150A must be used with this remote.

ON/OFF SAFETY VALVE/PILOT KIT GA9050A-1

OPINE CONES - GA9650A

For all models. Use for additional decoration only.

ASH BED MATERIAL (VERMICULITE) GA9750A

For all models.

GLOWING EMBERS - GA9950A

For all models. Use for firebox decoration only.

SILICA SAND - GA9850A

For all models. Use for firebox decoration only.

LAVA ROCK - GA6067A

For all models. Use for firebox decoration only.

DECORATIVE ASH BED CONTROL COVER - CDABKA

For all models. An attractive way to cover control knob and piezo ignitor.

PARTS

BURNER MODELS BVSR18, BVSR24, BVDR18, BVDR24 AND BVDR30

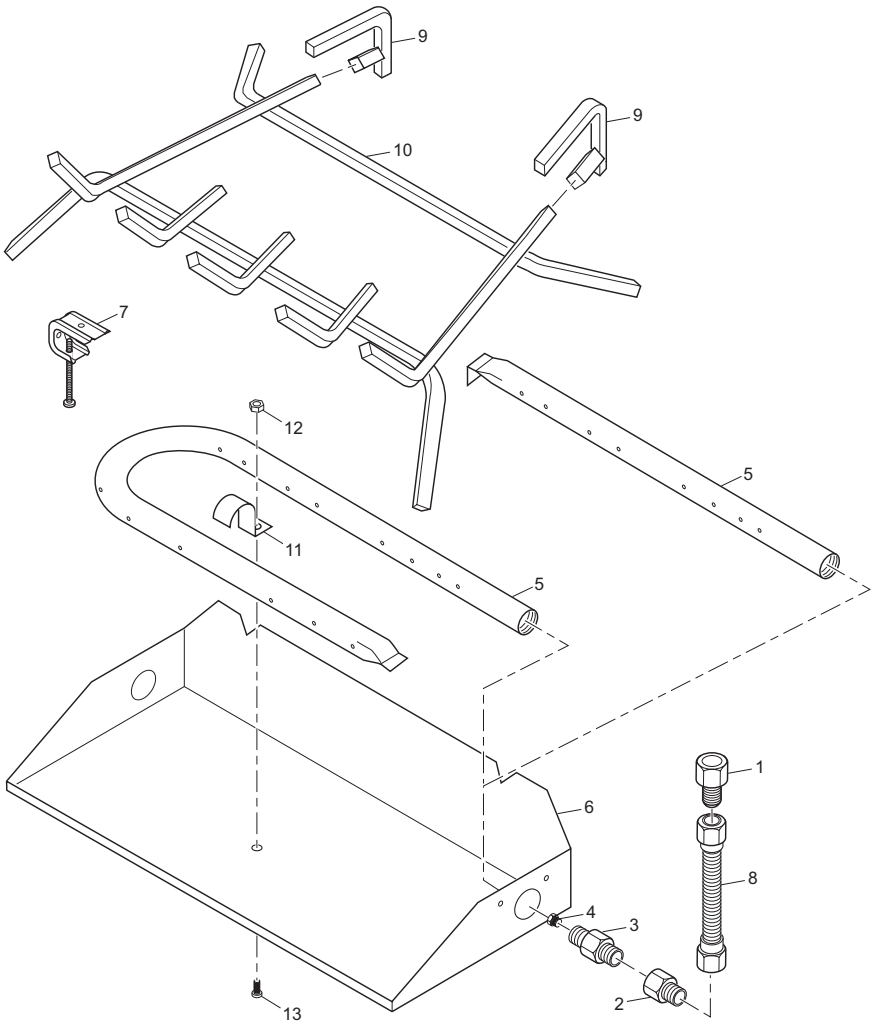

PARTS

This list contains replaceable parts used in your log set. When ordering parts, follow the instructions listed under Replacement Parts on page 19 of this manual.

KEY NO.	PART NO.	DESCRIPTION	BVSR18	BVSR24	BVDR18	BVDR24	BVDR30	QTY.
1	901056-01	Brass 3/8 FLR x 1/2 FPT Adapter	•	•	•	•	•	1
2	901059-01	Brass 3/8 FLR x 3/8 FPT Adapter	•	•	•	•	•	1
3	901066-01	Brass Air Mixer - Natural Gas	•	•	•	•	•	1
4	901064-02	Natural Gas Injector	•	•	•	•	•	1
	901064-03	Natural Gas Injector		•		•		1
	901064-04	Natural Gas Injector					•	1
5	901208-01	Burner Manifold	•		•			1
	901208-02	Burner Manifold		•		•		1
	901209-03	Burner Manifold					•	1
6	901136-01	Burner Pan	•					1
	901136-02	Burner Pan		•				1
	901137-01	Burner Pan			•			1
	901137-02	Burner Pan				•		1
	901137-03	Burner Pan					•	1
7	901242-01	Damper Clamp - Std. Assembly	•	•	•	•	•	1
8	101628-01	Gas Line - 10" Flex	•	•	•	•	•	1
9	901430-01	Grate Steps	•	•				2
	901431-01	Grate Steps			•	•	•	2
10	901243-01	Log Grate	•					1
	901243-02	Log Grate		•				1
	901246-01	Log Grate			•			1
	901246-02	Log Grate				•		1
	901246-03	Log Grate					•	1
11	901681-01	Burner Strap			•	•	•	1
12	901078-01	Nut #8/32			•	•	•	1
13	901076-01	Screw #8/32 x 3/8			•	•	•	1
PARTS AVAILABLE — NOT SHOWN								
	901156-01	0.4# Bag Embers	•	•	•	•	•	1
	901155-01	1.00# Bag Ash Bed Material (Vermiculite)	•	•	•	•	•	1

PARTS

This list contains replaceable parts used in your log set. When ordering parts, follow the instructions listed under Replacement Parts on page 19 of this manual.

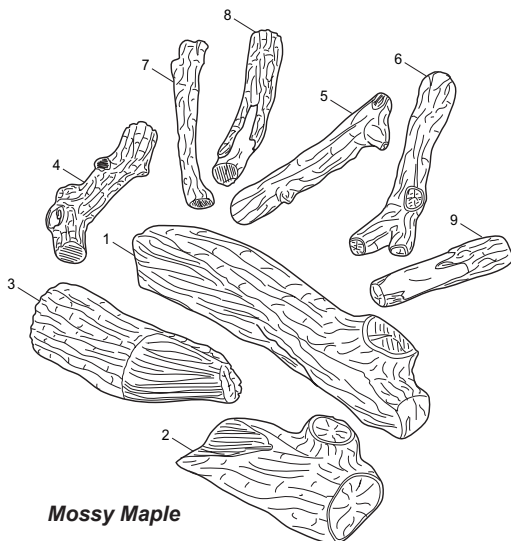

Mossy Maple

KEY NO.	PART NO.	DESCRIPTION				QTY.
			BMM18	BMM24	BMM30	
1	901111-01	Bottom Rear Log CS-15	•			1
	901111-02	Bottom Rear Log CS-20		•		1
	901111-03	Bottom Rear Log CS-27			•	1
2	901711-01	Bottom Front Log VCBQ-13	•			1
	901711-02	Bottom Front Log VCBQ-14		•	•	1
3	901710-01	Bottom Front Log VCBQ-11	•			1
	901710-02	Bottom Front Log VCBQ-12		•		1
	901710-03	Bottom Front Log VCBQ-16			•	1
4	901115-01	Top Log VR-11			•	1
5	901119-01	Top Log VS-12	•	•	•	1
6	901121-01	Top Log VCR-12		•	•	1
7	901120-01	Top Log VCR-11	•	•	•	1
8	901101-01	Top Log CHR-13	•	•	•	1
9	901118-01	Top Log VCR-9	•	•	•	1

PARTS

This list contains replaceable parts used in your log set. When ordering parts, follow the instructions listed under Replacement Parts on page 19 of this manual.

AMERICAN PEPPER LOG MODELS BAP18 AND BAP24

PONDEROSA PINE LOG MODELS BOP18 AND BOP24

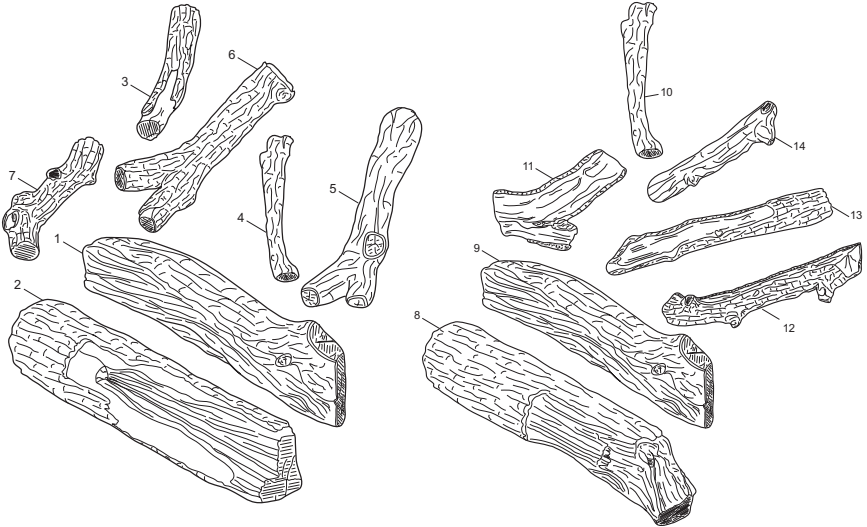

KEY NO.	PART NO.	DESCRIPTION	BAP18	BAP24	BOP18	BOP24	QTY.
1	901111-01	Bottom Front Log CS-15	•				1
	901111-02	Bottom Front Log CS-20		•			1
2	901713-01	Bottom Rear Log BPP-18	•				1
	901713-02	Bottom Rear Log BPP-24		•			1
3	901101-01	Top Log CHR-13	•	•			1
4	901120-01	Top Log VCR-11		•	•		1
5	901121-01	Top Log VCR-12	•	•			1
6	901103-01	Top Log CHR-13Y	•	•			1
7	901115-01	Top Log VR-11		•			1
8	901713-01	Bottom Front Log BPP-18			•		1
	901713-02	Bottom Front Log BPP-24				•	1
9	901111-01	Bottom Rear Log CS-15			•		1
	901111-02	Bottom Rear Log CS-20				•	1
10	901120-01	Top Log VCR-11			•	•	1
11	901128-01	Top Log FS-12Y			•	•	1
12	901127-01	Top Log FS-16			•	•	1
13	901125-01	Top Log FS-17			•	•	1
14	901119-01	Top Log VS-12				•	1

PARTS

This list contains replaceable parts used in your log set. When ordering parts, follow the instructions listed under Replacement Parts on page 19 of this manual.

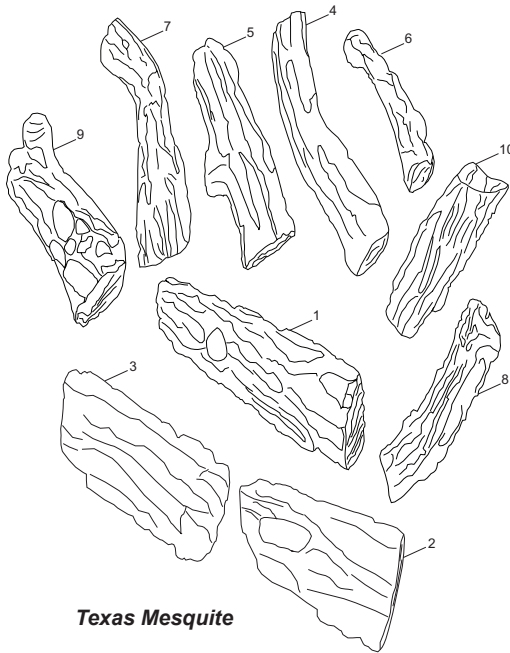

Texas Mesquite

KEY NO.	PART NO.	DESCRIPTION	BTM18	BTM24	BTM30	QTY.
1	110300-01	Back Log	•			1
	110303-01	Back Log		•		1
	124205-01	Back Log BFL-27			•	1
2	110299-01	Front Right Log	•			1
	110302-01	Front Right Log		•		1
	124204-01	Front Right Log BFL-30R			•	1
3	110298-01	Front Left Log	•			1
	110301-01	Front Left Log		•		1
	124203-01	Front Left Log BFL-30L			•	1
4	901090-01	Top Split Log CS-16	•	•	•	1
5	901119-01	Top Log VS-12	•	•	•	1
6	901120-01	Top Log VCR-11	•	•	•	1
7	901129-01	Top Log FR-12L	•	•	•	1
8	901476-01	Top Split Log CS-13Y	•	•	•	1
9	901844-01	Top Log FP-10Y	•	•	•	1
10	901845-01	Top Log FP-10S	•	•	•	1

WARRANTY

KEEP THIS WARRANTY

Model (located on product or identification tag) _____

Serial No. (located on product or identification tag) _____

Date Purchased _____

Keep receipt for warranty verification.

DESA HEATING, LLC LIMITED WARRANTIES

New Products

Standard Warranty: DESA Heating, LLC warrants this new product and any parts thereof to be free from defects in material and workmanship for a period of one (1) year from the date of first purchase from an authorized dealer provided the product has been installed, maintained and operated in accordance with DESA Heating, LLC's warnings and instructions.

For products purchased for commercial, industrial or rental usage, this warranty is limited to 90 days from the date of first purchase.

Factory Reconditioned Products

Limited Warranty: DESA Heating, LLC warrants factory reconditioned products and any parts thereof to be free from defects in material and workmanship for 30 days from the date of first purchase from an authorized dealer provided the product has been installed, maintained and operated in accordance with DESA Heating, LLC's warnings and instructions.

Terms Common to All Warranties

The following terms apply to all of the above warranties:

Always specify model number and serial number when contacting the manufacturer. To make a claim under this warranty the bill of sale or other proof of purchase must be presented.

This warranty is extended only to the original retail purchaser when purchased from an authorized dealer, and only when installed by a qualified installer in accordance with all local codes and instructions furnished with this product.

This warranty covers the cost of part(s) required to restore this product to proper operating condition and an allowance for labor when provided by a DESA Heating, LLC Authorized Service Center or a provider approved by DESA Heating, LLC. Warranty parts must be obtained through authorized dealers of this product and/or DESA Heating, LLC who will provide original factory replacement parts. Failure to use original factory replacement parts voids this warranty.

Travel, handling, transportation, diagnostic, material, labor and incidental costs associated with warranty repairs, unless expressly covered by this warranty, are not reimbursable under this warranty and are the responsibility of the owner.

Excluded from this warranty are products or parts that fail or become damaged due to misuse, accidents, improper installation, lack of proper maintenance, tampering, or alteration(s).

This is DESA Heating, LLC's exclusive warranty, and to the full extent allowed by law; this express warranty excludes any and all other warranties, express or implied, written or verbal and limits the duration of any and all implied warranties, including warranties of merchantability and fitness for a particular purpose to one (1) year on new products and 30 days on factory reconditioned products from the date of first purchase. DESA Heating, LLC makes no other warranties regarding this product.

DESA Heating, LLC's liability is limited to the purchase price of the product, and DESA Heating, LLC shall not be liable for any other damages whatsoever under any circumstances including indirect, incidental, or consequential damages.

Some states do not allow limitations on how long an implied warranty lasts or the exclusion or limitation of incidental or consequential damages, so the above limitation or exclusion may not apply to you.

This warranty gives you specific legal rights, and you may also have other rights which vary from state to state.

For information about this warranty contact:



901746 01

NOT A UPC



DESA Heating, LLC
2701 Industrial Drive
Bowling Green, KY 42101
www.desatech.com
1-866-672-6040

901746-01
Rev. E
08/08

Free Manuals Download Website

<http://myh66.com>

<http://usermanuals.us>

<http://www.somanuals.com>

<http://www.4manuals.cc>

<http://www.manual-lib.com>

<http://www.404manual.com>

<http://www.luxmanual.com>

<http://aubethermostatmanual.com>

Golf course search by state

<http://golfingnear.com>

Email search by domain

<http://emailbydomain.com>

Auto manuals search

<http://auto.somanuals.com>

TV manuals search

<http://tv.somanuals.com>