

GLO-WARM

BLUE FLAME VENT-FREE NATURAL GAS HEATER OWNER'S OPERATION AND INSTALLATION MANUAL

FA-10BA, FAS-10BB, and FA-60BA

10,000 and 6,000 Btu/Hr
Thermostat and
Non-Thermostat Models

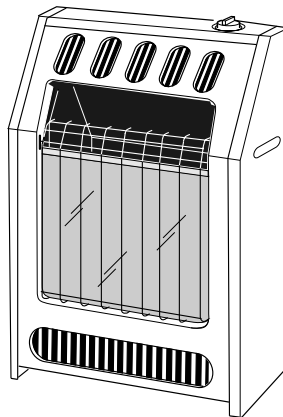

WARNING: If the information in this manual is not followed exactly, a fire or explosion may result causing property damage, personal injury, or loss of life.

- Do not store or use gasoline or other flammable vapors and liquids in the vicinity of this or any other appliance.
- **WHAT TO DO IF YOU SMELL GAS**
 - Do not try to light any appliance.
 - Do not touch any electrical switch; do not use any phone in your building.
 - Immediately call your gas supplier from a neighbor's phone. Follow the gas supplier's instructions.
 - If you cannot reach your gas supplier, call the fire department.
- Installation and service must be performed by a qualified installer, service agency, or the gas supplier.

WARNING: Improper installation, adjustment, alteration, service, or maintenance can cause injury or property damage. Refer to this manual for correct installation and operational procedures. For assistance or additional information consult a qualified installer, service agency, or the gas supplier.

WARNING: This is an unvented gas-fired heater. It uses air (oxygen) from the room in which it is installed. Provisions for adequate combustion and ventilation air must be provided. Refer to *Air For Combustion and Ventilation* on page 4 of this manual.

This appliance may be installed in an aftermarket*, permanently located, manufactured (mobile) home, where not prohibited by local codes.

This appliance is only for use with the type of gas indicated on the rating plate. This appliance is not convertible for use with other gases.

*Aftermarket: Completion of sale, not for purpose of resale, from the manufacturer

Save this manual for future reference.

GLO-WARM

NATURAL GAS HEATER

SAFETY INFORMATION

WARNINGS

IMPORTANT: Read this owner's manual carefully and completely before trying to assemble, operate, or service this heater. Improper use of this heater can cause serious injury or death from burns, fire, explosion, and carbon monoxide poisoning.

 DANGER: Carbon monoxide poisoning may lead to death!

Carbon Monoxide Poisoning: Early signs of carbon monoxide poisoning resemble the flu, with headaches, dizziness, and/or nausea. If you have these signs, the heater may not be working properly. **Get fresh air at once!** Have heater serviced. Some people are more affected by carbon monoxide than others. These include pregnant women, people with heart or lung disease or anemia, those under the influence of alcohol, and those at high altitudes.

Natural Gas: Natural gas is odorless. An odor-making agent is added to natural gas. The odor helps you detect a natural gas leak. However, the odor added to natural gas can fade. Natural gas may be present even though no odor exists.

Make certain you read and understand all warnings. Keep this manual for reference. It is your guide to safe and proper operation of this heater.

 WARNING: Any change to this heater or its controls can be dangerous.

 WARNING: Do not use any accessory not approved for use with this heater.

Due to high temperatures, the appliance should be located out of traffic and away from furniture and draperies.

Do not place clothing or other flammable material on or near the appliance. Never place any objects on the heater.

Surface of heater becomes very hot when running heater. Keep children and adults away from hot surface to avoid burns or clothing ignition. Heater will remain hot for a time after shut-down. Allow surface to cool before touching.

Carefully supervise young children when they are in the same room with heater.

Make sure grill guard is in place before running heater.

Keep the appliance area clear and free from combustible materials, gasoline, and other flammable vapors and liquids.

1. This appliance is only for use with the type of gas indicated on the rating plate. This appliance is not convertible for use with other gases.
2. If you smell gas
 - shut off gas supply
 - do not try to light any appliance
 - do not touch any electrical switch; do not use any phone in your building
 - immediately call your gas supplier from a neighbor's phone. Follow the gas supplier's instructions
 - if you cannot reach your gas supplier, call the fire department
3. This heater needs fresh, outside air ventilation to run properly. This heater has an Oxygen Depletion Sensing (ODS) safety shutoff system. The ODS shuts down the heater if not enough fresh air is available. See *Fresh Air for Combustion and Ventilation*, pages 4 through 6.
4. Keep all air openings in the front and bottom of heater clear and free of debris. This will insure enough air for proper combustion.

5. If heater shuts off, do not relight until you provide fresh, outside air. If heater keeps shutting off, have it serviced.
6. Do not run heater
 - where flammable liquids or vapors are used or stored
 - under dusty conditions
7. Before using furniture polish, wax, carpet cleaner, or similar products, turn heater off. If heated, the vapors from these products may create a white powder residue within burner box or on adjacent walls or furniture.
8. Do not use heater if any part has been under water. Immediately call a qualified service technician to inspect the room heater and to replace any part of the control system and any gas control which has been under water.
9. Turn off heater and let cool before servicing. Only a qualified service person should service and repair heater.
10. Operating heater above elevations of 4,500 feet could cause pilot outage.
11. Do not install models FA-10BA and FAS-10BB in a bathroom.

OWNER'S MANUAL

PRODUCT IDENTIFICATION

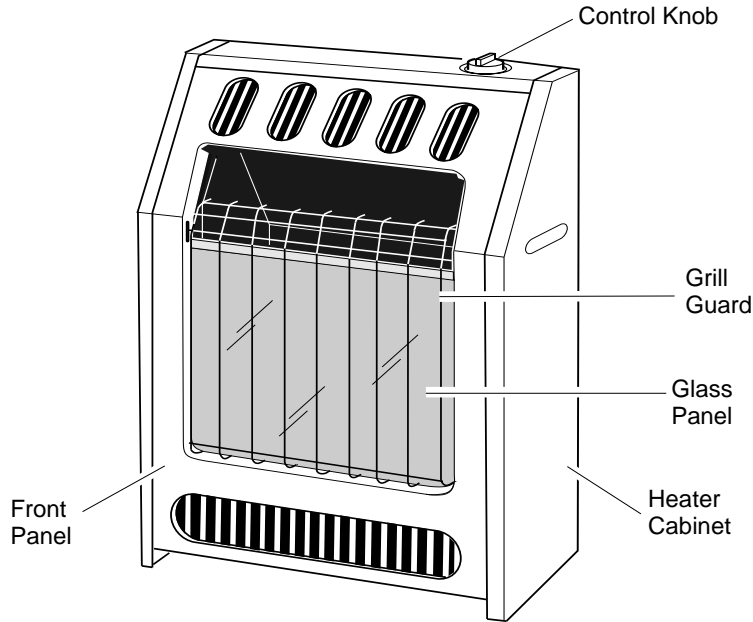

Figure 1 - Vent-Free Natural Gas Heater (Model FA-10BA Shown)

PRODUCT FEATURES

SAFETY DEVICE

This heater has a pilot with an Oxygen Depletion Sensing (ODS) safety shutoff system. The ODS/pilot is a required feature for vent-free room heaters. The ODS/pilot shuts off the heater if there is not enough fresh air.

PIEZO IGNITION SYSTEM

This heater has a piezo ignitor. This system requires no matches, batteries, or other sources to light heater.

THERMOSTATIC HEAT CONTROL ON THERMOSTAT MODEL FAS-10BB

This heater has a control valve with a thermostat sensing bulb. This results in the greatest heater comfort and may result in lower gas bills.

LOCAL CODES

Install and use heater with care. Follow all local codes. In the absence of local codes, use the latest edition of *The National Fuel Gas Code ANS Z223.1*, also known as NFPA 54*.

*Available from:

American National Standards Institute, Inc.
1430 Broadway
New York, NY 10018

National Fire Protection Association, Inc.
Batterymarch Park
Quincy, MA 02269

UNPACKING

1. Remove heater from carton.
2. Remove all protective packaging applied to heater for shipment.
3. Check heater for any shipping damage. If heater is damaged, promptly inform dealer where you bought heater.

GLO-WARM

NATURAL GAS HEATER

FRESH AIR FOR COMBUSTION AND VENTILATION

⚠ WARNING: This heater shall not be installed in a confined space or unusually tight construction unless provisions are provided for adequate combustion and ventilation air. Read the following instructions to insure proper fresh air for this and other fuel-burning appliances in your home.

Today's homes are built more energy efficient than ever. New materials, increased insulation, and new construction methods help reduce heat loss in homes. Home owners weather strip and caulk around windows and doors to keep the cold air out and the warm air in. During heating months, home owners want their homes as airtight as possible.

While it is good to make your home energy efficient, your home needs to breathe. Fresh air must enter your home. All fuel-burning appliances need fresh air for proper combustion and ventilation.

Exhaust fans, fireplaces, clothes dryers, and fuel burning appliances draw air from the house to operate. You must provide adequate fresh air for these appliances. This will insure proper venting of vented fuel-burning appliances.

PROVIDING ADEQUATE VENTILATION

The following are excerpts from *National Fuel Gas Code. NFPA 54/ANS Z223.1, Section 5.3, Air for Combustion and Ventilation.*

All spaces in homes fall into one of the three following ventilation classifications:

1. Unusually Tight Construction
2. Unconfined Space
3. Confined Space

The information on pages 4 through 6 will help you classify your space and provide adequate ventilation.

Unusually Tight Construction

The air that leaks around doors and windows may provide enough fresh air for combustion and ventilation. However, in buildings of unusually tight construction, you must provide additional fresh air.

Unusually tight construction is defined as construction where:

- a. walls and ceilings exposed to the outside atmosphere have a continuous water vapor retarder with a rating of one perm (6×10^{-11} kg per pa-sec- m^2) or less with openings gasketed or sealed ***and***
- b. weather stripping has been added on openable windows and doors ***and***
- c. caulking or sealants are applied to areas such as joints around window and door frames, between sole plates and floors, between wall-ceiling joints, between wall panels, at penetrations for plumbing, electrical, and gas lines, and at other openings.

If your home meets all of the three criteria above, you must provide additional fresh air. See *Ventilation Air From Outdoors*, page 6.

If your home does not meet all of the three criteria above, proceed *Determining Fresh-Air Flow for Heater Location*, page 5.

Confined and Unconfined Space

The National Fuel Gas Code, ANS Z223.1 defines a confined space as a space whose volume is less than 50 cubic feet per 1,000 Btu per hour (4.8 m³ per kw) of the aggregate input rating of all appliances installed in that space and an unconfined space as a space whose volume is not less than 50 cubic feet per 1,000 Btu per hour (4.8 m³ per kw) of the aggregate input rating of all appliances installed in that space. Rooms communicating directly with the space in which the appliances are installed*, through openings not furnished with doors, are considered a part of the unconfined space.

This heater shall not be installed in a confined space or unusually tight construction unless provisions are provided for adequate combustion and ventilation air.

* Adjoining rooms are communicating only if there are doorless passageways or ventilation grills between them.

FRESH AIR FOR COMBUSTION AND VENTILATION

Continued

DETERMINING FRESH-AIR FLOW FOR HEATER LOCATION

Determining if You Have a Confined or Unconfined Space

Use this worksheet to determine if you have a confined or unconfined space.

Space: Includes the room in which you will install heater plus any adjoining rooms with doorless passageways or ventilation grills between the rooms.

1. Determine the volume of the space (length x width x height).

Length x Width x Height = _____ cu. ft. (volume of space)

Example: Space size 20 ft. (length) x 16 ft. (width) x 8 ft. (ceiling height) = 2560 cu. ft. (volume of space)

If additional ventilation to adjoining room is supplied with grills or openings, add the volume of these rooms to the total volume of the space.

2. Divide the space volume by 50 cubic feet to determine the maximum Btu/Hr the space can support.

_____ (volume of space) ÷ 50 cu. ft. = (Maximum Btu/Hr the space can support)

Example: 2560 cu. ft. (volume of space) ÷ 50 cu. ft. = 51.2 or 51,200 (maximum Btu/Hr the space can support)

3. Add the Btu/Hr of all fuel burning appliances in the space.

Vent-free heater _____ Btu/Hr

Gas water heater* _____ Btu/Hr

Gas furnace _____ Btu/Hr

Vented gas heater _____ Btu/Hr

Gas fireplace logs _____ Btu/Hr

Other gas appliances* + _____ Btu/Hr

Total = _____ Btu/Hr

Example:

Gas water heater 44,000 Btu/Hr

Vent-free heater + 10,000 Btu/Hr

Total = 54,000 Btu/Hr

* Do not include direct-vent gas appliances. Direct-vent draws combustion air from the outdoors and vents to the outdoors.

4. Compare the maximum Btu/Hr the space can support with the actual amount of Btu/Hr used.

_____ Btu/Hr (maximum the space can support)

_____ Btu/Hr (actual amount of Btu/Hr used)

Example: 51,200 Btu/Hr (maximum the space can support)

54,000 Btu/Hr (actual amount of Btu/Hr used)

The space in the above example is a confined space because the actual Btu/Hr used is more than the maximum Btu/Hr the space can support. You must provide additional fresh air. Your options are as follows:

- A. Rework worksheet, adding the space of an adjoining room. If the extra space provides an unconfined space, remove door to adjoining room or add ventilation grills between rooms. See *Ventilation Air From Inside Building*, page 6.
- B. Vent room directly to the outdoors. See *Ventilation Air From Outdoors*, page 6.
- C. Install a lower Btu/Hr heater, if lower Btu/Hr size makes room unconfined.

If the actual Btu/Hr used is less than the maximum Btu/Hr the space can support, the space is an unconfined space. You will need no additional fresh air ventilation.

⚠ WARNING: If the area in which the heater may be operated is smaller than that defined as an unconfined space or if the building is of unusually tight construction, provide adequate combustion and ventilation air by one of the methods described in the *National Fuel Gas Code, ANS Z223.1, Section 5.3* or applicable local codes.

Continued

GLO-WARM

NATURAL GAS HEATER

FRESH AIR FOR COMBUSTION AND VENTILATION

Continued

VENTILATION AIR

Ventilation Air From Inside Building

This fresh air would come from an adjoining unconfined space. When ventilating to an adjoining unconfined space, you must provide two permanent openings: one within 12" of the ceiling and one within 12" of the floor on the wall connecting the two spaces (see options 1 and 2, Figure 2). You can also remove door into adjoining room (see option 3, Figure 2). Follow the *National Fuel Gas Code NFPA 54/ANS Z223.1, Section 5.3, Air for Combustion and Ventilation* for required size of ventilation grills or ducts.

⚠ WARNING: Rework worksheet, adding the space of the adjoining unconfined space. The combined spaces must have enough fresh air to supply all appliances in both spaces.

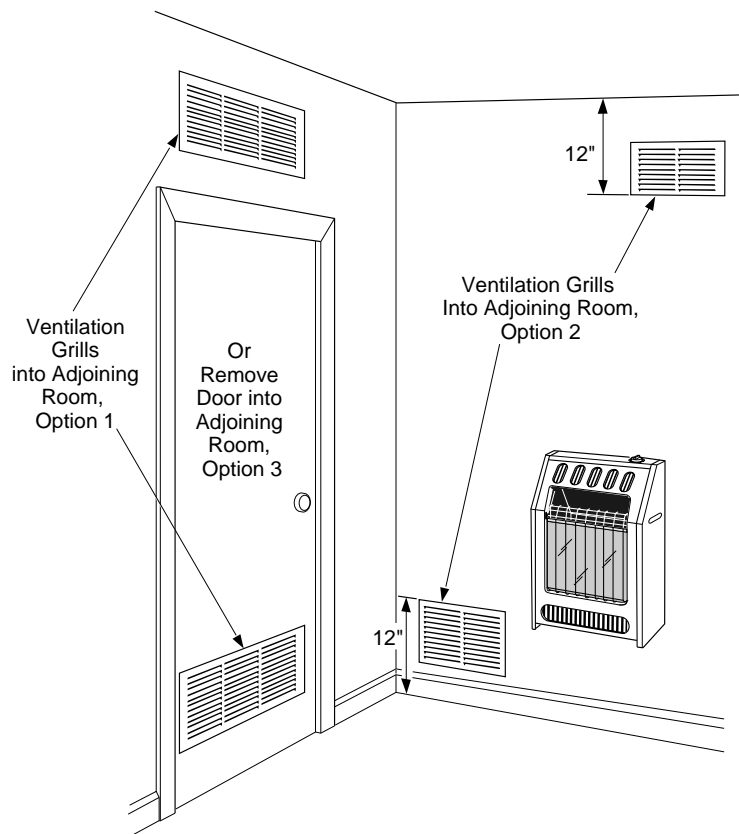

Figure 2 - Ventilation Air from Inside Building

Ventilation Air From Outdoors

Provide extra fresh air by using ventilation grills or ducts. You must provide two permanent openings: one within 12" of the ceiling and one within 12" of the floor. Connect these items directly to the outdoors or spaces open to the outdoors. These spaces include attics and crawl spaces. Follow the *National Fuel Gas Code NFPA 54/ANS Z223.1, Section 5.3, Air for Combustion and Ventilation* for required size of ventilation grills or ducts.

IMPORTANT: Do not provide openings for inlet or outlet air into attic if attic has a thermostat-controlled power vent. Heated air entering the attic will activate the power vent.

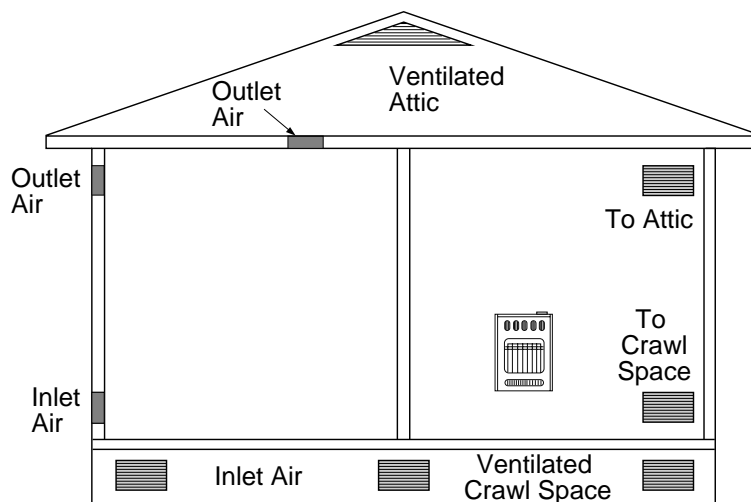

Figure 3 - Ventilation Air from Outdoors

OWNER'S MANUAL

INSTALLATION

NOTICE: This heater is intended for use as supplemental heat. Use this heater along with your primary heating system. Do not install this heater as your primary heat source. If you have a central heating system, you may run system's circulating blower while using heater. This will help circulate the heat throughout the house. In the event of a power outage, you can use this heater as your primary heating source.

WARNING: A qualified service person must install heater. Follow all local codes.

CHECK GAS TYPE

Use only natural gas. If your gas supply is not natural, do not install heater. Call dealer where you bought heater for proper type heater.

INSTALLATION ITEMS

Before installing heater, make sure you have the items listed below:

- piping (check local codes)
- sealant (resistant to propane/LP gas)
- equipment shutoff valve *
- ground joint union
- test gauge connection *
- sediment trap
- tee joint
- pipe wrench

* An CSA/AGA design-certified equipment shutoff valve with 1/8" NPT tap is an acceptable alternative to test gauge connection. The optional CSA/AGA design-certified equipment shutoff valve can be purchased from your dealer. See *Accessory*, page 18.

LOCATING HEATER

This heater is designed to be mounted on a wall.

WARNING: Maintain the minimum clearances shown in Figure 4. If you can, provide greater clearances from floor, ceiling, and joining wall.

WARNING: Never install the heater

- in a bathroom (Models FA-10BA and FAS-10BB only. FA-60BA is allowed in bathroom. Check local codes.)
- in a recreational vehicle
- where curtains, furniture, clothing, or other flammable objects are less than 36 inches from the front, top, or sides of the heater
- as a fireplace insert
- in high traffic areas
- in windy or drafty areas

CAUTION: This heater creates warm air currents. These currents move heat to wall surfaces next to heater. Installing heater next to vinyl or cloth wall coverings or operating heater where impurities (such as tobacco smoke, aromatic candles, cleaning fluids, oil or kerosene lamps, etc.) in the air exist, may discolor walls.

IMPORTANT: Vent-free heaters add moisture to the air. Although this is beneficial, installing heater in rooms without enough ventilation air may cause mildew to form from too much moisture. See *Fresh Air for Combustion and Ventilation*, pages 4 through 6.

CAUTION: If you install the heater in a home garage

- heater pilot and burner must be at least 18 inches above floor
- locate heater where moving vehicle will not hit it

For convenience and efficiency, install heater

- where there is easy access for operation, inspection, and service
- in coldest part of room

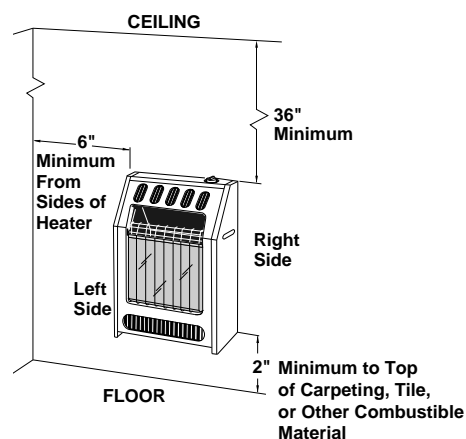

Figure 4 - Mounting Clearances As Viewed From Front of Heater

INSTALLING HEATER TO WALL

Mounting Bracket

The mounting bracket is located on back panel of heater. It has been taped there for shipping. Remove mounting bracket from back panel.

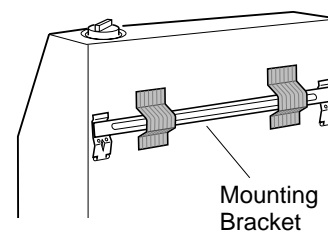

Figure 5 - Mounting Bracket

INSTALLING THERMOSTAT SENSING BULB - For T-Stat Models Only

Remove clip and bulb from shipping location. Place clip and bulb into operation location (see Figure 6)

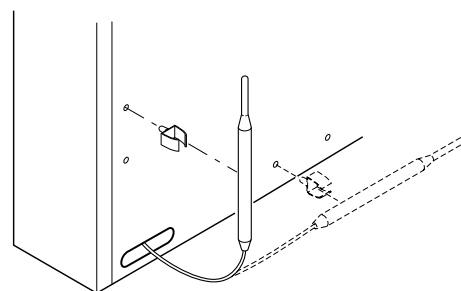

Figure 6 - Moving Thermostat Sensing Bulb

GLO-WARM

NATURAL GAS HEATER

INSTALLATION

Continued

Removing Front Panel Of Heater

1. Remove two screws near bottom corners of front panel.
2. Lift straight up on grill guard until it stops. Grill guard will slide up about 1/4".
3. Pull bottom of front panel forward, then down.
4. Remove cardboard packing from grill and glass.

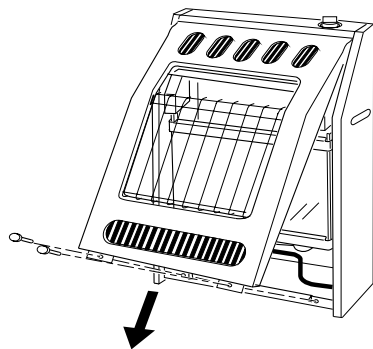

Figure 7 - Removing Front Panel Of Heater

Methods For Attaching Mounting Bracket To Wall

Only use last hole on each end of mounting bracket to attach bracket to wall. Attach mounting bracket to wall in one of two ways:

1. Attaching to wall stud
2. Attaching to wall anchor

Attaching To Wall Stud: This method provides the strongest hold. Insert mounting screws through mounting bracket and into wall studs.

Attaching To Wall Anchor: This method allows you to attach mounting bracket to hollow walls (wall areas between studs) or to solid walls (concrete or masonry).

Decide which method better suits your needs. Either method will provide a secure hold for the mounting bracket.

Marking Screw Locations

1. Tape mounting bracket to wall where heater will be located. Make sure mounting bracket is level.

WARNING: Maintain minimum clearances shown in Figure 8. If you can, provide greater clearances from floor and joining wall.

2. Mark screw locations on wall (see Figure 8).

Note: Only mark last hole on each end of mounting bracket. Insert mounting screws through these holes only.

3. Remove tape and mounting bracket from wall.

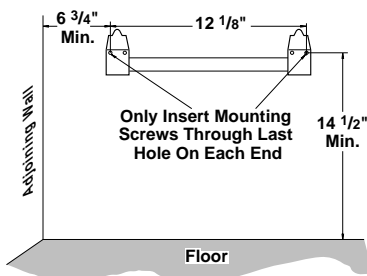

Figure 8 - Mounting Bracket Clearances

Attaching Mounting Bracket To Wall

Note: Wall anchors, mounting screws, and spacers are in hardware package. The hardware package is provided with heater.

Attaching To Wall Stud Method

For attaching mounting bracket to wall studs

1. Drill holes at marked locations using 9/64" drill bit.
2. Place mounting bracket onto wall. Line up last hole on each end of bracket with holes drilled in wall.
3. Insert mounting screws through bracket and into wall studs.
4. Tighten screws until mounting bracket is firmly fastened to wall studs.

Attaching To Wall Anchor Method

For attaching mounting bracket to hollow walls (wall areas between studs) or solid walls (concrete or masonry)

1. Drill holes at marked locations using 5/16" drill bit. For solid walls (concrete or masonry), drill at least 1" deep.
2. Fold wall anchor as shown in Figure 9.
3. Insert wall anchor (wings first) into hole. Tap anchor flush to wall.

4. For thin walls (1/2" or less), insert red key into wall anchor. Push red key to "pop" open anchor wings. **IMPORTANT:** Do not hammer key! For thick walls (over 1/2" thick) or solid walls, do not pop open wings.
5. Place mounting bracket onto wall. Line up last hole on each end of bracket with wall anchors.
6. Insert mounting screws through bracket and into wall anchors.
7. Tighten screws until mounting bracket is firmly fastened to wall.

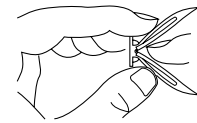

Figure 9 - Folding Anchor

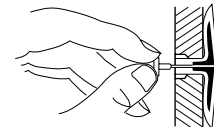

Figure 10 - Popping Open Anchor Wings For Thin Walls

Placing Heater On Mounting Bracket

1. Locate two horizontal slots on back panel of heater.
2. Place heater onto mounting bracket. Slide horizontal slots onto stand-out tabs on mounting bracket (see Figure 11).

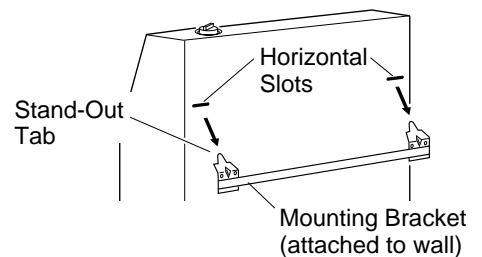

Figure 11 - Mounting Heater Onto Mounting Bracket

Installing Bottom Mounting Screws

1. Locate bottom mounting hole. This hole is near bottom on back panel of heater (see Figure 12, page 9).
2. Mark screw location on wall.
3. Remove heater from mounting bracket.

GLO-WARM

NATURAL GAS HEATER

INSTALLATION

Continued

CHECKING GAS CONNECTIONS

⚠ WARNING: Test all gas piping and connections for leaks after installation or servicing. Correct all leaks at once.

⚠ WARNING: Never use an open flame to check for a leak. Apply a mixture of liquid soap and water to all joints. Bubbles forming show a leak. Correct all leaks at once.

Pressure Testing Gas Supply Piping System

Test Pressures In Excess Of 1/2 PSIG (3.5 kPa)

1. Disconnect appliance with its appliance main gas valve (control valve) and equipment shutoff valve from gas supply piping system. Pressures in excess of 1/2 psig will damage heater regulator.
2. Cap off open end of gas pipe where equipment shutoff valve was connected.
3. Pressurize supply piping system by either using compressed air or opening main gas valve located on or near gas meter.
4. Check all joints of gas supply piping system. Apply mixture of liquid soap and water to gas joints. Bubbles forming show a leak.
5. Correct all leaks at once.
6. Reconnect heater and equipment shutoff valve to gas supply. Check reconnected fittings for leaks.

Test Pressures Equal To or Less Than 1/2 PSIG (3.5 kPa)

1. Close equipment shutoff valve (see Figure 14).
2. Pressurize supply piping system by either using compressed air or opening main gas valve located on or near gas meter.
3. Check all joints from gas meter to equipment shutoff valve (see Figure 15). Apply mixture of liquid soap and water to gas joints. Bubbles forming show a leak.
4. Correct all leaks at once.

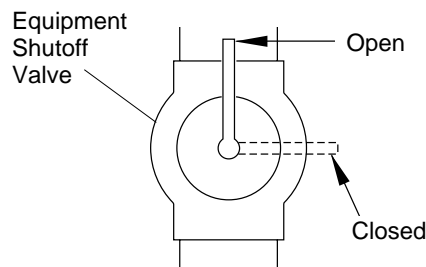

Figure 14 - Equipment Shutoff Valve

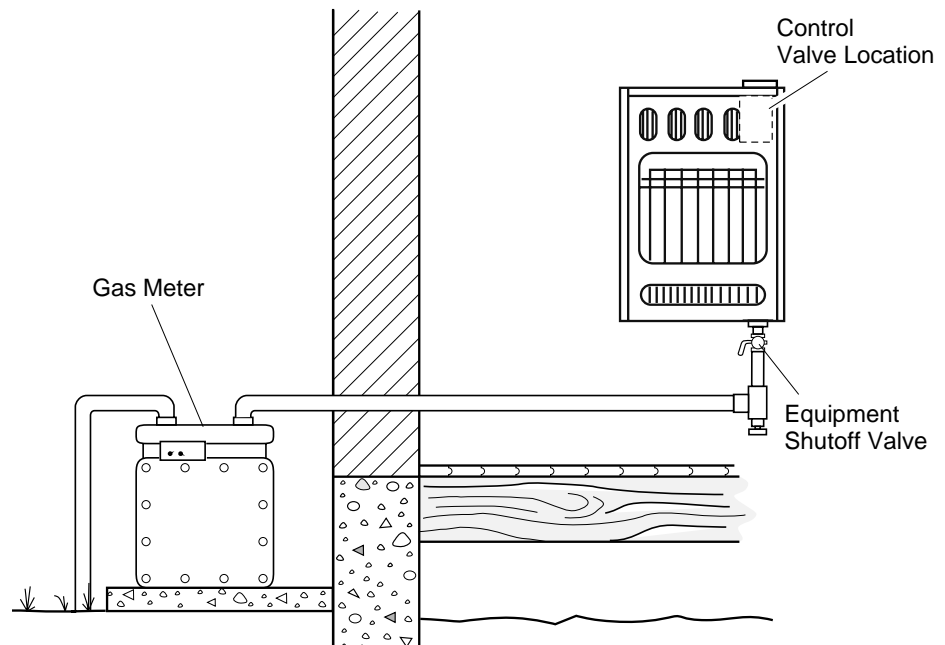

Figure 15 - Checking Gas Joints

Pressure Testing Heater Gas Connections

1. Open equipment shutoff valve (see Figure 14).
2. Open main gas valve located on or near gas meter.
3. Make sure control knob of heater is in the OFF position.
4. Check all joints from equipment shutoff valve to control valve (see Figure 15). Apply mixture of liquid soap and water to gas joints. Bubbles forming show a leak.
5. Correct all leaks at once.
6. Light heater (see *Operating Heater*, page 11 for non-thermostat models or pages 12 and 13 for thermostat model). Check all other internal joints for leaks.
7. Turn off heater (see *To Turn Off Gas To Appliance*, page 11 for non-thermostat models or page 12 for thermostat model).
8. Replace front panel.

OPERATING HEATER

NON-THERMOSTAT MODELS FB-10BA AND FB-60BA

FOR YOUR SAFETY READ BEFORE LIGHTING



⚠ WARNING: If you do not follow these instructions exactly, a fire or explosion may result causing property damage, personal injury or loss of life.

- This appliance has a pilot which must be lighted by hand. When lighting the pilot, follow these instructions exactly.
- BEFORE LIGHTING** smell all around the appliance area for gas. Be sure to smell next to the floor because some gas is heavier than air and will settle on the floor.

WHAT TO DO IF YOU SMELL GAS

- Do not try to light any appliance.
 - Do not touch any electric switch; do not use any phone in your building.
 - Immediately call your gas supplier from a neighbor's phone. Follow the gas supplier's instructions.
 - If you cannot reach your gas supplier, call the fire department.
- Use only your hand to push in or turn the gas control knob. Never use tools. If the knob will not push in or turn by hand, don't try to repair it, call a qualified service technician or gas supplier. Force or attempted repair may result in a fire or explosion.
 - Do not use this appliance if any part has been under water. Immediately call a qualified service technician to inspect the appliance and to replace any part of the control system and any gas control which has been under water.

LIGHTING INSTRUCTIONS

- STOP!** Read the safety information in column 1.
- Make sure equipment shutoff valve is fully open.
- Press in and turn control knob clockwise  to the OFF position (see Figure 16).
- Wait five (5) minutes to clear out any gas. Then smell for gas, including near the floor. If you smell gas, **STOP!** Follow "B" in the safety information, column 1. If you don't smell gas, go to the next step.
- Press in control knob and turn counterclockwise  to the PILOT/IGN position. Keep control knob pressed in for five (5) seconds.

Note: You may be running this heater for the first time after hooking up to gas supply. If so, the control knob may need to be pressed in for 30 seconds. This will allow air to bleed from the gas system.

- If control knob does not pop up when released, contact a qualified service person or gas supplier for repairs.
- Release downward pressure on control knob and turn clockwise  to OFF.
 - Press in control knob and turn back to PILOT/IGN. This will cause the piezo ignitor to spark and light the pilot gas. If needed, repeat steps 5 through 7 until pilot lights.

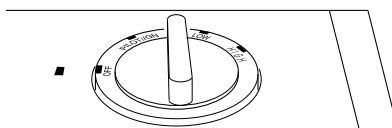

Figure 16 - Control Knob In The OFF Position (FB-10BA Shown)

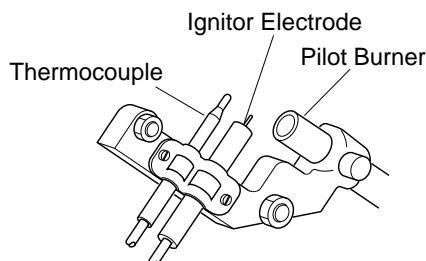



Figure 17 - Pilot

Note: If pilot does not stay lit, refer to *Troubleshooting*, pages 14 through 16. Also contact a qualified service person or gas supplier for repairs. Until repairs are made, light pilot with match. To light pilot with match, see *Manual Lighting Procedure*.

- Keep control knob pressed in for 30 seconds after lighting pilot. After 30 seconds, release control knob. **Note:** If pilot goes out, repeat steps 3 through 7.
- To light burner, slightly press in control knob and turn counterclockwise . Release downward pressure on control knob while turning.



Model FB-10BA: Set control knob to desired heating position. **Note:** Both HIGH and LOW are locked positions. You must press in control knob before turning it from these positions.

Model FB-60BA: When pilot is lit, turn control knob to ON.

⚠ CAUTION: Do not try to adjust heating levels by using the equipment shutoff valve.

TO TURN OFF GAS TO APPLIANCE

Shutting Off Heater

- Turn control knob clockwise  to the PILOT/IGN position.
- Press in control knob and turn clockwise  to the OFF position.

Shutting Off Burner Only (pilot stays lit)

Turn control knob clockwise  to the PILOT/IGN position.

MANUAL LIGHTING PROCEDURE

- Remove front panel (see Figure 7, page 8).
- Follow steps 1 through 5 under *Lighting Instructions*.
- With control knob pressed in, strike match. Hold match to pilot until pilot lights.
- Keep control knob pressed in for 30 seconds after pilot is lit. After 30 seconds, release control knob. Now follow step 9, above.
- Replace front panel. *Continued*

GLO-WARM

NATURAL GAS HEATER

OPERATING HEATER

Continued

THERMOSTAT MODEL FBS-10BB

FOR YOUR SAFETY READ BEFORE LIGHTING



WARNING: If you do not follow these instructions exactly, a fire or explosion may result causing property damage, personal injury or loss of life.

- A. This appliance has a pilot which must be lighted by hand. When lighting the pilot, follow these instructions exactly.
- B. **BEFORE LIGHTING** smell all around the appliance area for gas. Be sure to smell next to the floor because some gas is heavier than air and will settle on the floor.



WHAT TO DO IF YOU SMELL GAS

- Do not try to light any appliance.
 - Do not touch any electric switch; do not use any phone in your building.
 - Immediately call your gas supplier from a neighbor's phone. Follow the gas supplier's instructions.
 - If you cannot reach your gas supplier, call the fire department.
- C. Use only your hand to push in or turn the gas control knob. Never use tools. If the knob will not push in or turn by hand, don't try to repair it, call a qualified service technician or gas supplier. Force or attempted repair may result in a fire or explosion.
 - D. Do not use this appliance if any part has been under water. Immediately call a qualified service technician to inspect the appliance and to replace any part of the control system and any gas control which has been under water.

LIGHTING INSTRUCTIONS

1. STOP! Read the safety information, column 1.
2. Make sure equipment shutoff valve is fully open.
3. Push in control knob slightly and turn clockwise  to the OFF position (see Figure 18). Be sure that the temperature setting knob is set at the line between level 1 and level 7.
4. Wait five minutes to clear out any gas. Then smell for gas, including near the floor. If you smell gas, STOP! Follow "B" in the safety information in column 1. If you don't smell gas, go to the next step.
5. Push in and turn control knob counterclockwise  to PILOT position. Press in control knob for five (5) seconds.

Note: You may be running this heater for the first time after hooking up to gas supply. If so, you may need to press in control knob for 30 seconds. This will allow air to bleed from the gas system.

6. Release downward pressure on control knob and turn clockwise  to OFF position.
7. Press in control knob and turn counterclockwise  past IGN to PILOT (see Figure 18). This will cause the piezo ignitor to spark and light the pilot gas. Keep control knob depressed for 10 seconds before releasing. If needed, repeat steps 5 through 7 until pilot lights.

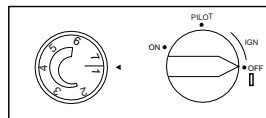

Figure 18 - Dual Control for Thermostat Model FBS-10BB

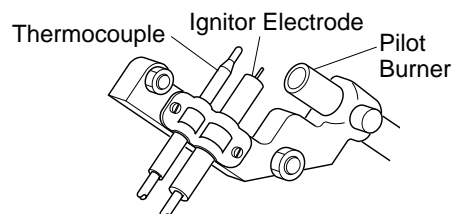



Figure 19 - Pilot

Note: If pilot does not stay lit, refer to *Troubleshooting*, pages 14 through 16. Also contact a qualified service person or gas supplier for repairs. Until repairs are made, light pilot with match. To light pilot with match, see *Manual Lighting Procedure*, page 13.

8. When pilot is lit, turn the ignition knob to ON position (see Figure 18).
9. To select desired heating level, turn the temperature setting knob counterclockwise  between 1 and 7 (see Figure 18).

TO TURN OFF GAS TO APPLIANCE

Shutting Off Heater

1. Turn control knob clockwise  to the OFF position.
2. Turn off all electric power to the appliance if service is to be performed.

Shutting Off Burner Only (pilot stays lit)

Turn control knob clockwise  to the PILOT position.

THERMOSTAT CONTROL OPERATION

The thermostatic control used on this model differs from standard thermostats. Standard thermostats simply turn on and off the burner. The thermostat used on this heater senses the room temperature. At times the room may exceed the set temperature. If so, the burner will shut off. The burner will cycle back on when room temperature drops below the set temperature. The control knob can be set to any comfort level between 1 and 7.

Note: The thermostat sensing bulb measures the temperature of air near the heater cabinet. This may not always agree with room temperature (depending on housing construction, installation location, room size, open air temperatures, etc.) Frequent use of your heater will let you determine your own comfort levels.

OPERATING HEATER

Continued

MANUAL LIGHTING PROCEDURE

1. Follow steps 1 through 5 under *Lighting Instructions*, page 12.
2. With control knob pressed in, strike match. Hold match to pilot until pilot lights.
3. Keep control knob pressed in for 30 seconds after lighting pilot. After 30 seconds, release control knob. Follow steps 8 and 9 under *Lighting Instructions*, page 12.

INSPECTING BURNER

Check pilot flame pattern and burner flame pattern often.

PILOT FLAME PATTERN

Figure 20 shows a correct pilot flame pattern. Figure 21 shows an incorrect pilot flame pattern. The incorrect pilot flame is not touching the thermocouple. This will cause the thermocouple to cool. When the thermocouple cools, the heater will shut down.

If pilot flame pattern is incorrect, as shown in Figure 21

- turn heater off (see *To Turn Off Gas to Appliance*, page 11 for non-thermostat models or page 12 for thermostat model)
- see *Troubleshooting*, pages 14 through 16

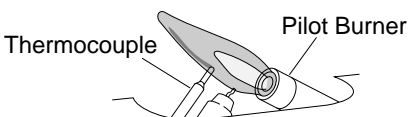

Figure 20 - Correct Pilot Flame Pattern

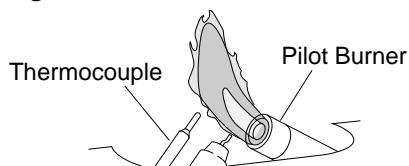

Figure 21 - Incorrect Pilot Flame Pattern

BURNER FLAME PATTERN

Figure 22 shows a correct burner flame pattern. Figure 23 shows an incorrect burner flame pattern. The incorrect burner flame pattern shows yellow tipping of the flame. It also shows the flame higher than 1/2 the glass panel height.

WARNING: If yellow tipping occurs, your heater could produce increased levels of carbon monoxide. If burner flame pattern shows yellow tipping, follow instructions below.

NOTICE: Do not mistake orange flames with yellow tipping. Dust or other fine particles enter the heater and burn causing brief patches of orange flame.

If burner flame pattern is incorrect, as shown in Figure 23

- turn heater off (see *To Turn Off Gas to Appliance*, page 11 for non-thermostat models or page 12 for thermostat model)
- see *Troubleshooting*, pages 14 through 16

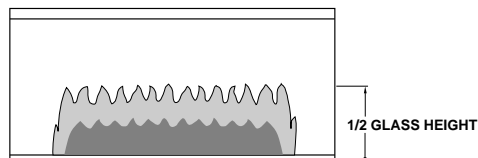

Models FA-10BA and FAS-10BB (Model FA-60BA will be lower due to lower input rating)

Figure 22 - Correct Burner Flame Pattern

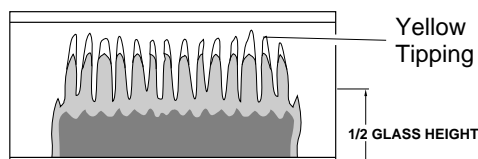

Figure 23 - Incorrect Burner Flame Pattern

CLEANING AND MAINTENANCE

WARNING: Turn off heater and let cool before cleaning.

CAUTION: You must keep control areas, burner, and circulating air passageways of heater clean. Inspect these areas of heater before each use. Have heater inspected yearly by a qualified service person. Heater may need more frequent cleaning due to excessive lint from carpeting, bedding material, pet hair, etc.

ODS/PILOT AND BURNER

- Use a vacuum cleaner, pressurized air, or small, soft bristled brush to clean.

CLEANING BURNER PILOT AIR INLET HOLE

We recommend that you clean the unit every 2,500 hours of operation or every three months.

We also recommend that you keep the burner tube and pilot assembly clean and free of dust and dirt. To clean these parts we recommend using compressed air no greater than 30 PSI. Your local computer store, hardware store, or home center may carry compressed air in a can. You can use a vacuum cleaner in the blow position. If using compressed air in a can, please follow the directions on the can. If you don't follow directions on the can, you could damage the pilot assembly.

1. Shut off the unit, including the pilot. Allow the unit to cool for at least thirty minutes.
2. Inspect burner, pilot for dust and dirt.
3. Blow air through the ports/slots and holes in the burner.

Clean the pilot assembly also. A yellow tip on the pilot flame indicates dust and dirt in the pilot assembly. There is a small pilot air inlet hole about two inches from where the pilot flame comes out of the pilot assembly (see Figure 24). With the unit off, lightly blow air through the air inlet hole. You may blow through a drinking straw if compressed air is not available.

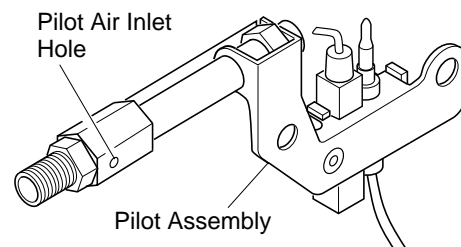

Figure 24 - Pilot Inlet Air Hole

CABINET

Air Passageways

- Use a vacuum cleaner or pressurized air to clean.

Exterior

- Use a soft cloth dampened with a mild soap and water mixture. Wipe the cabinet to remove dust.

GLO-WARM

NATURAL GAS HEATER

TROUBLESHOOTING

Note: For additional help, visit DESA International's technical service web site at www.desatech.com.

⚠ WARNING: Turn off heater and let cool before servicing. Only a qualified service person should service and repair heater.

⚠ CAUTION: Never use a wire, needle, or similar object to clean ODS/pilot. This can damage ODS/pilot unit.

Note: All troubleshooting items are listed in order of operation.

OBSERVED PROBLEM	POSSIBLE CAUSE	REMEDY
When ignitor button is pressed, there is no spark at ODS/pilot	<ol style="list-style-type: none">1. Ignitor electrode positioned wrong2. Ignitor electrode broken3. Ignitor electrode not connected to ignitor cable4. Ignitor cable pinched or wet5. Broken ignitor cable6. Bad Piezo ignitor	<ol style="list-style-type: none">1. Replace ignitor2. Replace ignitor3. Reconnect ignitor cable4. Free ignitor cable if pinched by any metal or tubing. Keep ignitor cable dry5. Replace ignitor cable6. Replace control valve (ignitor is part of control valve)
When ignitor button is pressed, there is spark at ODS/pilot but no ignition	<ol style="list-style-type: none">1. Gas supply turned off or equipment shutoff valve closed2. Control knob not in PILOT position3. Control knob not pressed in while in PILOT position4. Air in gas lines when installed5. ODS/pilot is clogged6. Gas regulator setting is not correct	<ol style="list-style-type: none">1. Turn on gas supply or open equipment shutoff valve2. Turn control knob to PILOT position3. Press in control knob while in PILOT position4. Continue holding down control knob. Repeat igniting operation until air is removed5. Clean ODS/pilot (see <i>Cleaning and Maintenance</i>, page 13) or replace ODS/pilot assembly6. Replace gas regulator
ODS/pilot lights but flame goes out when control knob is released	<ol style="list-style-type: none">1. Control knob not fully pressed in2. Control knob not pressed in long enough3. Equipment shutoff valve not fully open4. Thermocouple connection loose at control valve5. Pilot flame not touching thermocouple, which allows thermocouple to cool, causing pilot flame to go out. This problem could be caused by one or both of the following:<ol style="list-style-type: none">A) Low gas pressureB) Dirty or partially clogged ODS/pilot6. Thermocouple damaged7. Control valve damaged	<ol style="list-style-type: none">1. Press in control knob fully2. After ODS/pilot lights, keep control knob pressed in 30 seconds3. Fully open equipment shutoff valve4. Hand tighten until snug, then tighten 1/4 turn more5. A) Contact local natural gas company B) Clean ODS/pilot (see <i>Cleaning and Maintenance</i>, page 13) or replace ODS/pilot assembly6. Replace thermocouple7. Replace control valve

OWNER'S MANUAL

TROUBLESHOOTING

Continued

OBSERVED PROBLEM	POSSIBLE CAUSE	REMEDY
Burner does not light after ODS/pilot is lit	<ol style="list-style-type: none">1. Burner orifice is clogged2. Burner orifice diameter is too small3. Inlet gas pressure is too low	<ol style="list-style-type: none">1. Clean burner orifice (see <i>Cleaning and Maintenance</i>, page 13) or replace burner orifice2. Replace burner orifice3. Contact local natural gas company
Delayed ignition of burner	<ol style="list-style-type: none">1. Manifold pressure is too low2. Burner orifice is clogged	<ol style="list-style-type: none">1. Contact local natural gas company2. Clean burner orifice (see <i>Cleaning and Maintenance</i>, page 13) or replace burner orifice
Burner backfiring during combustion	<ol style="list-style-type: none">1. Burner orifice is clogged or damaged2. Burner damaged3. Gas regulator defective	<ol style="list-style-type: none">1. Clean burner orifice (see <i>Cleaning and Maintenance</i>, page 13) or replace burner orifice2. Replace burner3. Replace gas regulator
Yellow flame during burner combustion	<ol style="list-style-type: none">1. Not enough air2. Inlet gas pressure is too low3. Gas regulator defective	<ol style="list-style-type: none">1. Check burner for dirt and debris. If found, clean burner (see <i>Cleaning and Maintenance</i>, page 13)2. Contact local natural gas company3. Replace gas regulator
Slight smoke or odor during initial operation	<ol style="list-style-type: none">1. Residues from manufacturing processes	<ol style="list-style-type: none">1. Problem will stop after a few hours of operation
Heater produces a whistling noise when burner is lit	<ol style="list-style-type: none">1. Turning control knob to HIGH position when burner is cold2. Air in gas line3. Air passageways on heater blocked4. Dirty or partially clogged burner orifice	<ol style="list-style-type: none">1. Turn control knob to LOW position and let warm up for a minute2. Operate burner until air is removed from line. Have gas checked by local natural gas company3. Observe minimum installation clearances (see Figure 4, page 7)4. Clean burner (see <i>Cleaning and Maintenance</i>, page 13) or replace burner orifice
Heater produces a clicking/ticking noise just after burner is lit or shut off	<ol style="list-style-type: none">1. Metal expanding while heating or contracting while cooling	<ol style="list-style-type: none">1. This is common with most heaters. If noise is excessive, contact qualified service person
White powder residue forming within the burner box or on adjacent walls or furniture	<ol style="list-style-type: none">1. When heated, vapors from furniture polish, wax, carpet cleaners, etc. turn into white powder residue	<ol style="list-style-type: none">1. Turn heater off when using furniture polish, wax, carpet cleaners, or similar products

GLO-WARM

NATURAL GAS HEATER

TROUBLESHOOTING

Continued

- ⚠ WARNING:** If you smell gas
- Shut off gas supply.
 - Do not try to light any appliance.
 - Do not touch any electrical switch; do not use any phone in your building.
 - Immediately call your gas supplier from a neighbor's phone. Follow the gas supplier's instructions.
 - If you cannot reach your gas supplier, call the fire department.

IMPORTANT: Operating heater where impurities in air exist may create odors. Cleaning supplies, paint, paint remover, cigarette smoke, cements and glues, new carpet or textiles, etc., create fumes. These fumes may mix with combustion air and create odors.

OBSERVED PROBLEM	POSSIBLE CAUSE	REMEDY
Heater produces unwanted odors	<ol style="list-style-type: none">1. Heater burning vapors from paint, hair spray, glues, etc. (See <i>IMPORTANT</i> statement above)2. Gas leak. See Warning statement at top of page	<ol style="list-style-type: none">1. Ventilate room. Stop using odor-causing products while heater is running2. Locate and correct all leaks (see <i>Checking Gas Connections</i>, page 10)
Heater shuts off in use (ODS operates)	<ol style="list-style-type: none">1. Not enough fresh air is available2. Low line pressure3. ODS/pilot is partially clogged	<ol style="list-style-type: none">1. Open window and/or door for ventilation2. Contact local natural gas company3. Clean ODS/pilot (see <i>Cleaning and Maintenance</i>, page 13)
Gas odor even when control knob is in OFF position	<ol style="list-style-type: none">1. Gas leak. See Warning statement at top of page2. Control valve defective	<ol style="list-style-type: none">1. Locate and correct all leaks (see <i>Checking Gas Connections</i>, page 10)2. Replace control valve
Gas odor during combustion	<ol style="list-style-type: none">1. Foreign matter between control valve and burner2. Gas leak. See Warning statement at top of page	<ol style="list-style-type: none">1. Take apart gas tubing and remove foreign matter2. Locate and correct all leaks (see <i>Checking Gas Connections</i>, page 10)
Moisture/condensation noticed on windows	<ol style="list-style-type: none">1. Not enough combustion/ventilation air	<ol style="list-style-type: none">1. Refer to <i>Fresh Air for Combustion and Ventilation</i> requirements (page 4)

OWNER'S MANUAL

SPECIFICATIONS

	FA-10BA	FA-60BA	FAS-10BB
Btu (Variable)	6,000/10,000	6,000	10,000
Type Gas	Natural Only	Natural Only	Natural Only
Ignition	Piezo	Piezo	Piezo
Pressure Regulator Setting	3" W.C.	3" W.C.	3" W.C.
Inlet Gas Pressure (inches of water)			
Maximum	10.5"	10.5"	10.5"
Minimum	4"	4"	4"
Dimensions, Inches (H x W x D)			
Heater	18 x 14 x 5	18 x 14 x 5	18 x 14 x 5
Carton	21 x 16 x 7	21 x 16 x 7	21 x 16 x 7
Weight (pounds)			
Heater	12.9	12.9	13.3
Shipping	15	15	15.4

TECHNICAL SERVICE

You may have further questions about installation, operation, or troubleshooting. If so, contact DESA International's Technical Service Department at 1-800-323-5190.

You can also visit DESA International's technical service web site at www.desatech.com.

SERVICE HINTS

When Gas Pressure is Too Low

- pilot will not stay lit
- burner will have delayed ignition
- heater will not produce specified heat

When Gas Quality is Bad

- pilot will not stay lit
- burner will produce flames and soot
- heater will backfire when lit

You may feel your gas pressure is too low or gas quality is bad. If so, contact your local natural gas supplier.

SERVICE PUBLICATIONS

You can purchase a service manual from the address listed on the back page of this manual. Send a check for \$5.00 payable to DESA International.

GLO-WARM

NATURAL GAS HEATER

ACCESSORY

Purchase this heater accessory from your local dealer. If they cannot supply this accessory, either contact your nearest Parts Central (see page 19) or call DESA International's Parts Department at 1-800-972-7879 for referral information. You can also write to the address listed on the back page of this manual.

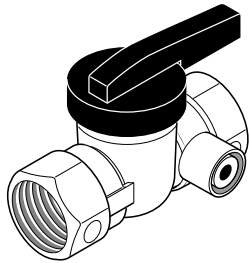

EQUIPMENT SHUTOFF VALVE - GA5010

Equipment shutoff valve with 1/8" NPT tap.

REPLACEMENT PARTS

Note: Use only original replacement parts. This will protect your warranty coverage for parts replaced under warranty.

PARTS UNDER WARRANTY

Contact authorized dealer from whom you purchased this product. If they cannot supply original replacement part(s), either contact your nearest Parts Central or call DESA International's Technical Service Department at 1-800-323-5190 for referral information.

When contacting your dealer or DESA International, have ready:

- your name
- your address
- model and serial numbers of your heater
- how heater was malfunctioning
- type of gas used (propane/LP or natural gas)
- purchase date

Usually, we will ask you to return the defective part to the factory.

PARTS NOT UNDER WARRANTY

Contact authorized dealers of this product. If they cannot supply original replacement part(s), either contact your nearest Parts Central or call DESA International's Parts Department at 1-800-972-7879 for referral information.

When calling DESA International, have ready:

- model number of your heater
- the replacement part number

OWNER'S MANUAL

PARTS CENTRALS

These Parts Centrals are privately owned businesses. They have agreed to support our customer's needs by providing original replacement parts and accessories.

Baltimore Electric

1348 Dixwell Avenue
Hamden, CT 06514-0322
1-800-397-7553
203-248-7553
Parts Department

Portable Heater Parts

342 N. County Rd. 400 East
Valparaiso, IN 46383-9704
All States
219-462-7441
1-800-362-6951
sales@portableheaterparts.com
techservice@portableheaterparts.com

FBD

1349 Adams Street
Bowling Green, KY 42103-3414
270-846-1199
1-800-654-8534
Fax: 1-800-846-0090
franktalk@aol.com

Master Parts Dist.

1251 Mound Ave NW
Grand Rapids, MI 49504-2672
616-791-0505
1-800-446-1446
Fax: 616-791-8270
www.nbmc.com

Washer Equipment Co.

1715 Main Street
Kansas City, MO 64108-2195
KS, MO, AR
816-842-3911
www.washerparts.com

East Coast Energy Products

707 Broadway
W. Long Branch, NJ 07764-1542
732-870-8809
1-800-755-8809
www.njplaza.com/ecep

Tarantin Tank Co.

P.O. Box 6129
Freehold, NJ 07728-6129
908-780-9340
1-800-922-0724
www.tarantin.com

Heater & Fireplace Store

58 Halbe Lane
Cape May Court, NJ 08210-1110
609-390-9774
Parts Department

Dayton Hardware

P.O. Box 275
North Dayton Station
Dayton, OH 45404-0275
All States
937-258-3721
OH 1-800-762-3426

Halco Enterprises

208 Carter Drive, Unit 21
West Chester, PA 19382-4500
610-430-7717
1-800-368-0803
www.halcoenterprises.com

LA Porte's Parts & Service

2444 N. 5th Street
Hartsville, SC 29550-7704
803-332-0191
Parts Department

Cans Unlimited, Inc.

P.O. Box 645
Taylor, SC 29687-0013
All States
803-879-3009
1-800-845-5301
cuissales@aol.com

GLO-WARM

NATURAL GAS HEATER

ILLUSTRATED PARTS LIST

FA-10BA

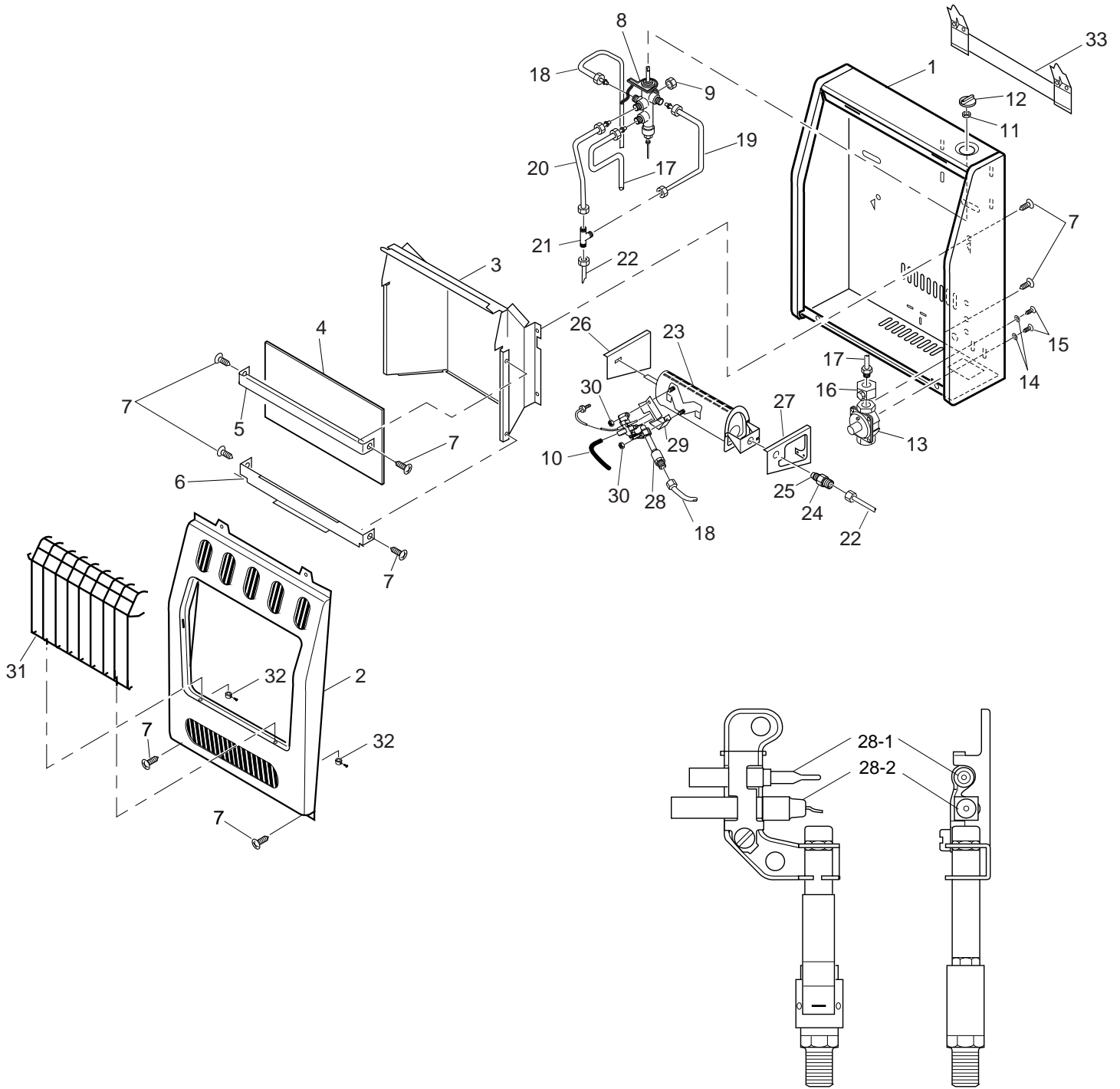

ODS Pilot Assembly

OWNER'S MANUAL

PARTS LIST

This list contains replaceable parts used in your heater. When ordering parts, follow the instructions listed under *Replacement Parts* on page 18 of this manual.

FA-10BA

KEY NO.	PART NO. FA-10BA	DESCRIPTION	QTY.
1	L98409-05	Cabinet Assembly	1
2	L98006-03	Front Panel Assembly	1
3	L98410-08	Reflector Unit	1
4	L98501-03	Glass	1
5	L98502-03	Upper Glass Retainer	1
6	L98807-03	Lower Glass Retainer	1
7	L98817-01	Self Tapping Screw	12
8	L98034-01	Control Valve	1
9	L98035-01	7/16" Brass Cap	1
10	L98411-01	Ignitor Line	1
11	L98054-01	Control Valve Fixed Nut	1
12	L98061-02	Control Knob	1
13	L98029-03	Pressure Regulator	1
14	L98801-01	Washer	2
15	L98806-01	Self Tapping Screw	2
16	L98915-02	Pressure Tap Assembly	1
17	L98115-04	Main Inlet Tube Assembly	1
18	L98123-10	ODS Line Assembly	1
19	L98127-02	Lower Gas Outlet Tube Assembly	1
20	L98128-02	Medium Gas Outlet Tube Assembly	1
21	L99516-01	Leveled "T" Connector	1
22	L98126-04	Burner Inlet Tube Assembly	1
23	L98506-03	Burner	1
24	L98507-02	Burner Connector	1
25	L98508-05	Injector	1
26	L98504-02	Left Burner Support Bracket	1
27	L98505-02	Right Burner Support Bracket	1
28	L98071-05	ODS/Pilot Assembly	1
28-1	098514-01	Thermocouple	1
28-2	L98071-07	Ignitor Electrode	1
29	L98515-01	ODS Lower Deflector	1
30	L98514-01	Nut	2
31	L98010-08	Grill	1
32	L98011-01	Grill Fastener	2
33	L98085-02	Mounting Bracket	1
PARTS AVAILABLE - NOT SHOWN			
	100642-01	Assembly, Hardware	1
	104892-14	AGA Label	1
	L98098-01	Gas Instruction Decal	1
	L98100-01	Inside Warning Label	1

GLO-WARM

NATURAL GAS HEATER

ILLUSTRATED PARTS LIST

FA-60BA

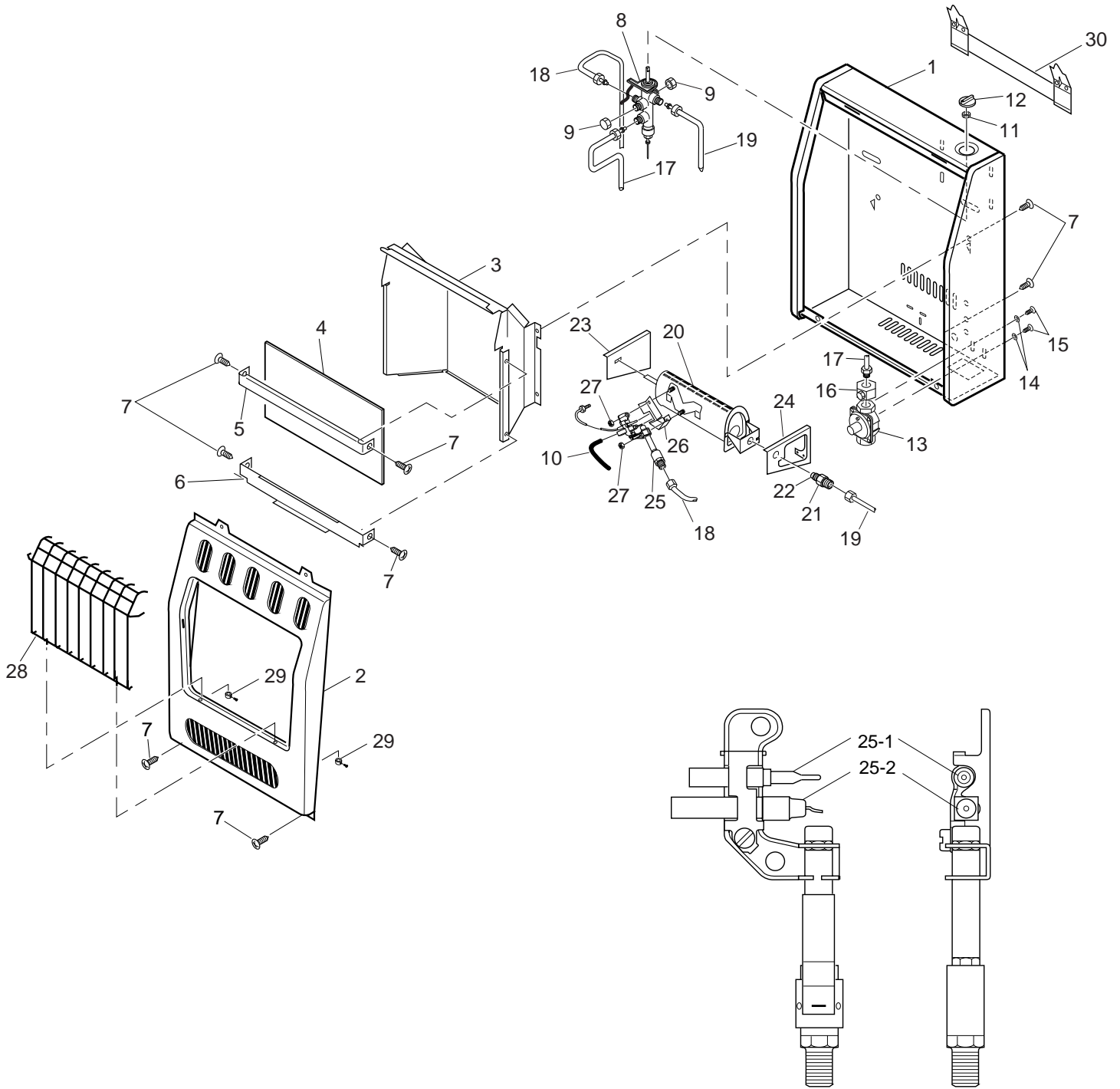

ODS Pilot Assembly

OWNER'S MANUAL

PARTS LIST

This list contains replaceable parts used in your heater. When ordering parts, follow the instructions listed under *Replacement Parts* on page 18 of this manual.

FA-60BA

KEY NO.	PART NO. FA-60BA	DESCRIPTION	QTY.
1	L98409-05	Cabinet Assembly	1
2	L98006-03	Front Panel Assembly	1
3	L98410-08	Reflector Unit	1
4	L98501-03	Glass	1
5	L98502-03	Upper Glass Retainer	1
6	L98807-03	Lower Glass Retainer	1
7	L98817-01	Self Tapping Screw	12
8	L98034-01	Control Valve	1
9	L98035-01	7/16" Brass Cap	2
10	L98411-01	Ignitor Line	1
11	L98054-01	Control Valve Fixed Nut	1
12	L98061-04	Control Knob	1
13	L98029-03	Pressure Regulator	1
14	L98801-01	Washer	2
15	L98806-01	Self Tapping Screw	2
16	L98915-02	Pressure Tap Assembly	1
17	L98115-04	Main Inlet Tube Assembly	1
18	L98123-10	ODS Line Assembly	1
19	L98126-05	Burner Inlet Tube Assembly	1
20	L98506-03	Burner	1
21	L98507-02	Burner Connector	1
22	L98508-11	Injector	1
23	L98504-02	Left Burner Support Bracket	1
24	L98505-02	Right Burner Support Bracket	1
25	L98071-05	ODS/Pilot Assembly	1
25-1	098514-01	Thermocouple	1
25-2	L98071-07	Ignitor Electrode	1
26	L98515-01	ODS Lower Deflector	1
27	L98514-01	Nut	2
28	L98010-08	Grill	1
29	L98011-01	Grill Fastener	2
30	L98085-02	Mounting Bracket	1
PARTS AVAILABLE - NOT SHOWN			
	100642-01	Assembly, Hardware	1
	104892-12	AGA Label	1
	L98098-01	Gas Instruction Decal	1
	L98100-01	Inside Warning Label	1

GLO-WARM

NATURAL GAS HEATER

ILLUSTRATED PARTS LIST

FAS-10BB

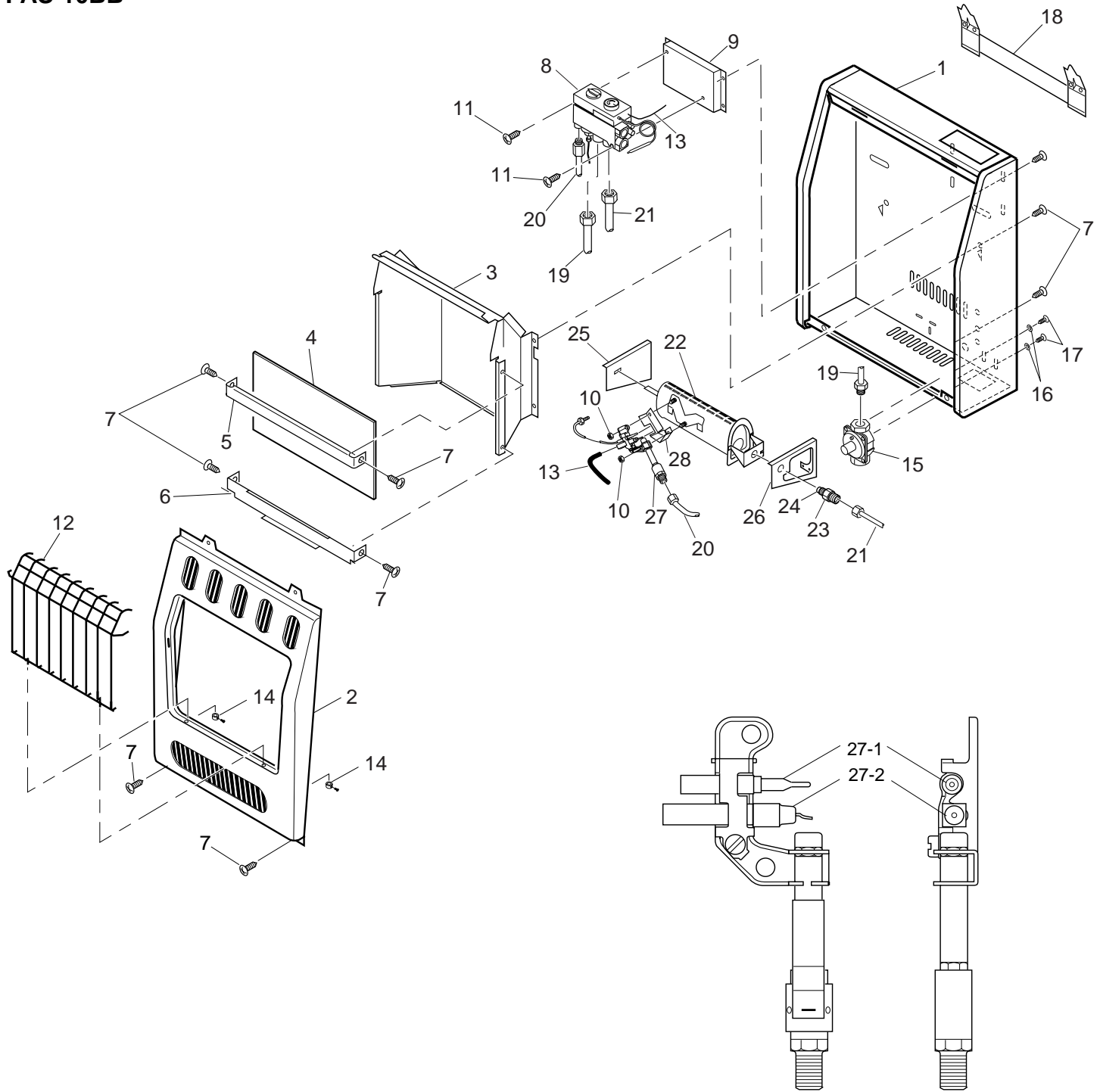

ODS Pilot Assembly

OWNER'S MANUAL

PARTS LIST

This list contains replaceable parts used in your heater. When ordering parts, follow the instructions listed under *Replacement Parts* on page 18 of this manual.

FAS-10BB

KEY NO.	PART NO. FAS-10BA	DESCRIPTION	QTY.
1	L98409-06	Cabinet Assembly	1
2	L98006-03	Front Panel Assembly	1
3	L98410-08	Reflector Unit	1
4	L98501-03	Glass	1
5	L98502-03	Upper Glass Retainer	1
6	L98807-03	Lower Glass Retainer	1
7	L98817-01	Self Tapping Screw	12
8	L98135-03	Thermostat Valve Assembly	1
9	L99066-03	Thermostat Valve Base/Bracket	1
10	L98514-01	Nut	2
11	L98084-01	Screws	2
12	L98010-08	Grill	1
13	L98411-01	Ignitor Line	1
14	L98011-01	Grill Fastener	2
15	L99029-07	Pressure Regulator	1
16	L98801-01	Washer	2
17	L98806-01	Self Tapping Screw	2
18	L98085-02	Mounting Bracket	1
19	L98115-07	Main Inlet Tube Assembly	1
20	L98123-11	ODS Line Assembly	1
21	L98126-07	Burner Inlet Tube Assembly	1
22	L98506-03	Burner	1
23	L98507-01	Burner Connector	1
24	L98508-05	Injector	1
25	L98504-02	Left Burner Support Bracket	1
26	L98505-02	Right Burner Support Bracket	1
27	L98071-03	ODS/Pilot Assembly	1
27-1	098514-01	Thermocouple	1
27-2	L98071-07	Ignitor Electrode	1
28	L98515-01	ODS Lower Deflector	1
PARTS AVAILABLE - NOT SHOWN			
	100642-01	Assembly, Hardware	1
	104892-16	AGA Label	1
	L98100-01	Inside Warning Label	1
	L98080-02	Thermostat Sensing Bulb Clip	2

WARRANTY INFORMATION

KEEP THIS WARRANTY

Model _____
Serial No. _____
Date Purchased _____

Always specify model and serial numbers when communicating with the factory.

We reserve the right to amend these specifications at any time without notice. The only warranty applicable is our standard written warranty. We make no other warranty, expressed or implied.

LIMITED WARRANTY GLO-WARM VENT-FREE RESIDENTIAL GAS HEATERS

DESA International warrants this product to be free from defects in materials and components for two (2) years from the date of first purchase, provided that the product has been properly installed, operated and maintained in accordance with all applicable instructions. To make a claim under this warranty the Bill of Sale or cancelled check must be presented.

This warranty is extended only to the original retail purchaser. This warranty covers only the cost of part(s) required to restore this heater to proper operating condition. Warranty part(s) MUST be obtained through authorized dealers of this product and/or DESA International who will provide original factory replacement parts. Failure to use original factory replacement parts voids this warranty. The heater MUST be installed by a qualified installer in accordance with all local codes and instructions furnished with the unit.

This warranty does not apply to parts that are not in original condition because of normal wear and tear, or parts that fail or become damaged as a result of misuse, accidents, lack of proper maintenance or defects caused by improper installation. Travel, diagnostic cost, labor, transportation and any and all such other costs related to repairing a defective heater will be the responsibility of the owner.

TO THE FULL EXTENT ALLOWED BY THE LAW OF THE JURISDICTION THAT GOVERNS THE SALE OF THE PRODUCT; THIS EXPRESS WARRANTY EXCLUDES ANY AND ALL OTHER EXPRESSED WARRANTIES AND LIMITS THE DURATION OF ANY AND ALL IMPLIED WARRANTIES, INCLUDING WARRANTIES OF MERCHANTABILITY AND FITNESS FOR A PARTICULAR PURPOSE TO TWO (2) YEARS FROM THE DATE OF FIRST PURCHASE; AND DESA INTERNATIONAL'S LIABILITY IS HEREBY LIMITED TO THE PURCHASE PRICE OF THE PRODUCT AND DESA INTERNATIONAL SHALL NOT BE LIABLE FOR ANY OTHER DAMAGES WHATSOEVER INCLUDING INDIRECT, INCIDENTAL OR CONSEQUENTIAL DAMAGES.

Some states do not allow a limitation on how long an implied warranty lasts or an exclusion or limitation of incidental or consequential damages, so the above limitation on implied warranties, or exclusion or limitation on damages may not apply to you.

This warranty gives you specific legal rights, and you may also have other rights that vary from state to state.

For information about this warranty write:

DESA
INTERNATIONAL
2701 Industrial Drive
P.O. Box 90004
Bowling Green, KY 42102-9004
www.desatech.com



105564 01

NOT A UPC

105564-01
L98106-02
REV. C
02/00

Free Manuals Download Website

<http://myh66.com>

<http://usermanuals.us>

<http://www.somanuals.com>

<http://www.4manuals.cc>

<http://www.manual-lib.com>

<http://www.404manual.com>

<http://www.luxmanual.com>

<http://aubethermostatmanual.com>

Golf course search by state

<http://golfingnear.com>

Email search by domain

<http://emailbydomain.com>

Auto manuals search

<http://auto.somanuals.com>

TV manuals search

<http://tv.somanuals.com>