

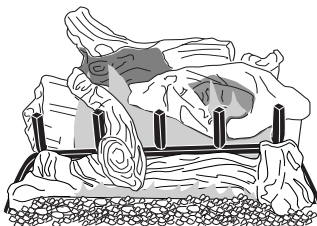

UNVENTED (VENT-FREE) GAS LOG HEATER OWNER'S OPERATION AND INSTALLATION MANUAL



MODELS VF-18N-MHD, VF-18P-MHD, VF-24N-MHD AND VF-24P-MHD

WARNING: If the information in this manual is not followed exactly, a fire or explosion may result causing property damage, personal injury or loss of life.

- Do not store or use gasoline or other flammable vapors and liquids in the vicinity of this or any other appliance.
- **WHAT TO DO IF YOU SMELL GAS**
 - Do not try to light any appliance.
 - Do not touch any electrical switch; do not use any phone in your building.
 - Immediately call your gas supplier from a neighbor's phone. Follow the gas supplier's instructions.
 - If you cannot reach your gas supplier, call the fire department.
- Installation and service must be performed by a qualified installer, service agency or the gas supplier.

INSTALLER: Leave this manual with the appliance.
CONSUMER: Retain this manual for future reference.

WARNING: Improper installation, adjustment, alteration, service or maintenance can cause injury or property damage. Refer to this manual for correct installation and operational procedures. For assistance or additional information consult a qualified installer, service agency or the gas supplier.

WARNING: This appliance is for installation only in a solid-fuel burning masonry or UL127 factory-built fireplace or in a listed ventless firebox enclosure. It is design-certified for these installations in accordance with ANSI Z21.11.2. Exception: Do not install this appliance in a factory-built fireplace that includes instructions stating it has not been tested or should not be used with unvented gas logs.

WARNING: This is an unvented gas-fired heater. It uses air (oxygen) from the room in which it is installed. Provisions for adequate combustion and ventilation air must be provided. Refer to *Air for Combustion and Ventilation* section on page 5 of this manual.

This appliance may be installed in an aftermarket,* permanently located, manufactured (mobile) home, where not prohibited by local codes.

This appliance is only for use with the type of gas indicated on the rating plate. This appliance is not convertible for use with other gases.

* Aftermarket: Completion of sale, not for purpose of resale, from the manufacturer

TABLE OF CONTENTS

Safety Information	3	Cleaning and Maintenance.....	19
Product Identification	4	Troubleshooting	21
Local Codes.....	5	Wiring Diagram	24
Unpacking.....	5	Replacement Parts	25
Product Features	5	Service Hints	25
Air For Combustion and Ventilation	5	Technical Service.....	25
Installation	8	Accessories	25
Operating Heater	15	Illustrated Parts Breakdown and Parts List.....	26
Inspecting Burners	18	Warranty Information	Back Cover

SAFETY INFORMATION

⚠ WARNING: This product contains and/or generates chemicals known to the State of California to cause cancer or birth defects or other reproductive harm.

IMPORTANT: Read this owner's manual carefully and completely before trying to assemble, operate or service this heater. Improper use of this heater can cause serious injury or death from burns, fire, explosion, electrical shock and carbon monoxide poisoning.

⚠ DANGER: Carbon monoxide poisoning may lead to death!

Carbon Monoxide Poisoning: Early signs of carbon monoxide poisoning resemble the flu, with headaches, dizziness or nausea. If you have these signs, the heater may not be working properly. **Get fresh air at once!** Have heater serviced. Some people are more affected by carbon monoxide than others. These include pregnant women, people with heart or lung disease or anemia, those under the influence of alcohol and those at high altitudes.

Natural and Propane/LP Gas: Natural and propane/LP gases are odorless. An odor-making agent is added to these gases. The odor helps you detect a gas leak. However, the odor added to the gas can fade. Gas may be present even though no odor exists.

Make certain you read and understand all warnings. Keep this manual for reference. It is your guide to safe and proper operation of this heater.

⚠ WARNING: Any change to this heater or its controls can be dangerous.

⚠ WARNING: Do not use a blower insert, heat exchanger insert or other accessory not approved for use with this heater.

⚠ WARNING: Do not allow fans to blow directly into the heater. Avoid any drafts that alter burner flame patterns. Ceiling fans can create drafts that alter burner flame patterns. Altered burner patterns can cause sooting.

⚠ WARNING: Do not place log scraps or lava rocks on burner.

Due to high temperatures, the appliance should be located out of traffic and away from furniture and draperies.

Do not place clothing or other flammable material on or near the appliance. Never place any objects on the heater.

Heater base assembly becomes very hot when running heater. Keep children and adults away from hot surface to avoid burns or clothing ignition. Heater will remain hot for a time after shutdown. Allow surface to cool before touching.

Carefully supervise young children when they are in the room with heater.

You must operate this heater with a fireplace screen in place. Make sure fireplace screen is closed before running heater.

Keep the appliance area clear and free from combustible materials, gasoline and other flammable vapors and liquids.

SAFETY INFORMATION

Continued

1. This appliance is only for use with the type of gas indicated on the rating plate. This appliance is not convertible for use with other gases.
2. Do not place propane/LP supply tank(s) inside any structure. Locate propane/LP supply tank(s) outdoors (propane/LP units only).
3. If you smell gas
 - shut off gas supply
 - do not try to light any appliance
 - do not touch any electrical switch; do not use any phone in your building
 - immediately call your gas supplier from a neighbor's phone. Follow the gas supplier's instructions
 - if you cannot reach your gas supplier, call the fire department
4. This heater shall not be installed in a bedroom or bathroom.
5. Before installing in a solid fuel burning fireplace, the chimney flue and firebox must be cleaned of soot, creosote, ashes and loose paint by a qualified chimney cleaner. Creosote will ignite if highly heated. Inspect chimney flue for damage. If damaged, repair flue before operating heater.
6. Do not burn solid-fuel in a masonry or UL127 factory-built fireplace in which a vent-free room heater is installed.
7. If fireplace has glass doors, never operate this heater with glass doors closed. If you operate heater with doors closed, heat buildup inside fireplace will cause glass to burst. Make sure there are no obstructions across openings of fireplace.
8. To prevent the creation of soot, follow the instructions in *Cleaning and Maintenance*, page 19.
9. Before using furniture polish, wax, carpet cleaner or similar products, turn heater off. If heated, the vapors from these products may create a white powder residue within burner box or on adjacent walls or furniture.
10. This heater needs fresh, outside air ventilation to run properly. This heater has an oxygen depletion sensing (ODS) pilot light safety system. The ODS shuts down the heater if not enough fresh air is available. See *Air for Combustion and Ventilation*, page 5. If heater keeps shutting off, see *Troubleshooting*, page 21.
11. Do not run heater
 - where flammable liquids or vapors are used or stored
 - under dusty conditions
12. Do not use this heater to cook food or burn paper or other objects.
13. Do not use heater if any part has been exposed to or under water. Immediately call a qualified service technician to inspect the room heater and to replace any part of the control system and any gas control which has been under water.
14. Do not operate heater if any log is broken. Do not operate heater if a log is chipped (dime-sized or larger).
15. Turn heater off and let cool before servicing or repairing. Only a qualified service person should install, service or repair heater.
16. This heater does not need to be connected to any external electrical source.
17. To prevent performance problems, do not use propane/LP fuel tank of less than 100 lb. capacity (propane/LP units only).
18. Operating heater above elevations of 4,500 feet could cause pilot outage.
19. Provide adequate clearances around air openings.

State of Massachusetts: The installation must be made by a licensed plumber or gas fitter in the Commonwealth of Massachusetts.

Sellers of unvented propane or natural gas-fired supplemental room heaters shall provide to each purchaser a copy of 527 CMR 30 upon sale of the unit.

Vent-free gas products are prohibited for bedroom and bathroom installation in the Commonwealth of Massachusetts.

PRODUCT IDENTIFICATION

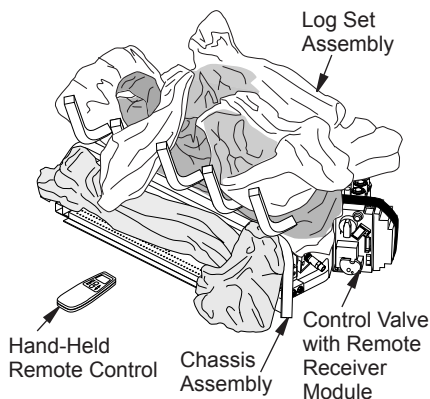

Figure 1 - Product Identification

LOCAL CODES

Install and use heater with care. Follow all local codes. In the absence of local codes, use the latest edition of *The National Fuel Gas Code ANSI Z223.1/NFPA 54**.

*Available from:

American National Standards Institute, Inc.
1430 Broadway
New York, NY 10018

National Fire Protection Association, Inc.
Batterymarch Park
Quincy, MA 02269

UNPACKING

CAUTION: Do not remove the data plates from the grate assembly. The data plates contain important warranty and safety information.

1. Remove log set assembly from carton.
Note: Do not pick up assembly by logs. This could damage heater. Always handle assembly by grate.
2. Remove all protective packaging applied to log set for shipment.
3. Check all items for any shipping damage. If damaged, promptly inform dealer where you bought heater.

PRODUCT FEATURES

OPERATION

This heater is clean burning. It requires no outside venting. There is no heat loss out a vent or up a chimney. Heat is generated by realistic flames and glowing ceramic logs/coins. This heater is designed for vent-free operation with flue damper closed. It has been tested and approved to ANSI Z21.11.2 standard for unvented heaters. State and local codes in some areas prohibit the use of vent-free heaters.

SAFETY PILOT

This heater has a pilot with an Oxygen Depletion Sensing (ODS) safety shutoff system. The ODS/pilot is a required feature for vent-free room heaters. The ODS/pilot shuts off the heater if there is not enough fresh air.

REMOTE IGNITION AND CONTROL

This gas log set has a battery powered electronic remote ignition and control. This system requires no matches or other source to light log set.

AIR FOR COMBUSTION AND VENTILATION

WARNING: This heater shall not be installed in a confined space or unusually tight construction unless provisions are provided for adequate combustion and ventilation air. Read the following instructions to insure proper fresh air for this and other fuel-burning appliances in your home.

Today's homes are built more energy efficient than ever. New materials, increased insulation and new construction methods help reduce heat loss in homes. Home owners weather strip and caulk around windows and doors to keep the cold air out and the warm air in. During heating months, home owners want their homes as airtight as possible.

While it is good to make your home energy efficient, your home needs to breathe. Fresh air must enter your home. All fuel-burning appliances need fresh air for proper combustion and ventilation.

Exhaust fans, fireplaces, clothes dryers and fuel burning appliances draw air from the house to operate. You must provide adequate fresh air for these appliances. This will insure proper venting of vented fuel-burning appliances.

PROVIDING ADEQUATE VENTILATION

The following are excerpts from *National Fuel Gas Code, ANSI Z223.1/NFPA 54, Section 5.3, Air for Combustion and Ventilation*.

All spaces in homes fall into one of the three following ventilation classifications:

1. Unusually Tight Construction
2. Unconfined Space
3. Confined Space

The information on pages 5 through 7 will help you classify your space and provide adequate ventilation.

Unusually Tight Construction

The air that leaks around doors and windows may provide enough fresh air for combustion and ventilation. However, in buildings of unusually tight construction, you must provide additional fresh air.

AIR FOR COMBUSTION AND VENTILATION

Continued

Unusually tight construction is defined as construction where:

- walls and ceilings exposed to the outside atmosphere have a continuous water vapor retarder with a rating of one perm (6×10^{-11} kg per pa-sec-m²) or less with openings gasketed or sealed and
- weather stripping has been added on openable windows and doors and
- caulking or sealants are applied to areas such as joints around window and door frames, between sole plates and floors, between wall-ceiling joints, between wall panels, at penetrations for plumbing, electrical and gas lines and at other openings.

If your home meets all of the three criteria above, you must provide additional fresh air. See *Ventilation Air From Outdoors*, page 7. If your home does not meet all of the three criteria above, proceed to *Determining Fresh-Air Flow For Heater Location*.

Confined and Unconfined Space

The *National Fuel Gas Code, ANSI Z223.1/NFPA 54* defines a confined space as a space whose volume is less than 50 cubic feet per 1,000 Btu per hour (4.8 m³ per kw) of the aggregate input rating of all appliances installed in that space and an unconfined space as a space whose volume is not less than 50 cubic feet per 1,000 Btu per hour (4.8 m³ per kw) of the aggregate input rating of all appliances installed in that space. Rooms communicating directly with the space in which the appliances are installed*, through openings not furnished with doors, are considered a part of the unconfined space.

* Adjoining rooms are communicating only if there are doorless passageways or ventilation grills between them.

DETERMINING FRESH-AIR FLOW FOR HEATER LOCATION

Determining if You Have a Confined or Unconfined Space

Use this work sheet to determine if you have a confined or unconfined space.

Space: Includes the room in which you will install heater plus any adjoining rooms with doorless passageways or ventilation grills between the rooms.

- Determine the volume of the space (length x width x height).

Length x Width x Height = _____ cu. ft. (volume of space)

Example: Space size 20 ft. (length) x 16 ft. (width) x 8 ft. (ceiling height) = 2,560 cu. ft. (volume of space)

If additional ventilation to adjoining room is supplied with grills or openings, add the volume of these rooms to the total volume of the space.

- Multiply the space volume by 20 to determine the maximum Btu/Hr the space can support.

_____ (volume of space) x 20 = (Maximum Btu/Hr the space can support)

Example: 2,560 cu. ft. (volume of space) x 20 = 51,200 (maximum Btu/Hr the space can support)

- Add the Btu/Hr of all fuel burning appliances in the space.

Vent-free fireplace	_____ Btu/Hr
Gas water heater*	_____ Btu/Hr
Gas furnace	_____ Btu/Hr
Vented gas heater	_____ Btu/Hr
Gas fireplace logs	_____ Btu/Hr
Other gas appliances*	+ _____ Btu/Hr
Total	= _____ Btu/Hr

* Do not include direct-vent gas appliances. Direct-vent draws combustion air from the outdoors and vents to the outdoors.

Example:

Gas water heater	_____ Btu/Hr
Vent-free fireplace	+ _____ Btu/Hr
Total	= _____ Btu/Hr

- Compare the maximum Btu/Hr the space can support with the actual amount of Btu/Hr used.

_____ Btu/Hr (maximum the space can support)
 _____ Btu/Hr (actual amount of Btu/Hr used)

Example: 51,200 Btu/Hr (maximum the space can support)

73,000 Btu/Hr (actual amount of Btu/Hr used)

The space in the example is a confined space because the actual Btu/Hr used is more than the maximum Btu/Hr the space can support. You must provide additional fresh air. Your options are as follows:

- Rework worksheet, adding the space of an adjoining room. If the extra space provides an unconfined space, remove door to adjoining room or add ventilation grills between rooms. See *Ventilation Air From Inside Building*, page 7.
- Vent room directly to the outdoors. See *Ventilation Air From Outdoors*, page 7.
- Install a lower Btu/Hr fireplace, if lower Btu/Hr size makes room unconfined.

AIR FOR COMBUSTION AND VENTILATION

Continued

If the actual Btu/Hr used is less than the maximum Btu/Hr the space can support, the space is an unconfined space. You will need no additional fresh air ventilation.

⚠ WARNING: If the area in which the heater may be operated is smaller than that defined as an unconfined space or if the building is of unusually tight construction, provide adequate combustion and ventilation air by one of the methods described in the *National Fuel Gas Code, ANSI Z223.1/NFPA 54 Section 5.3* or applicable local codes.

VENTILATION AIR

Ventilation Air From Inside Building

This fresh air would come from an adjoining unconfined space. When ventilating to an adjoining unconfined space, you must provide two permanent openings: one within 12" of the ceiling and one within 12" of the floor on the wall connecting the two spaces (see options 1 and 2, Figure 2). You can also remove door into adjoining room (see option 3, Figure 2). Follow the *National Fuel Gas Code, ANSI Z223.1/NFPA 54, Section 5.3, Air for Combustion and Ventilation* for required size of ventilation grills or ducts.

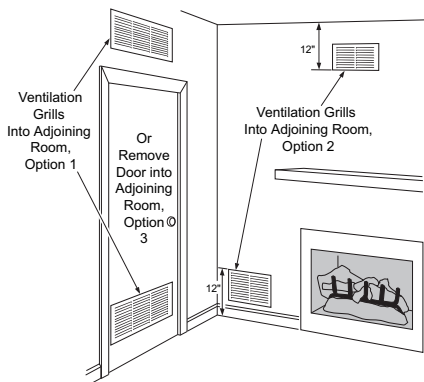

Figure 2 - Ventilation Air from Inside Building

Ventilation Air From Outdoors

Provide extra fresh air by using ventilation grills or ducts. You must provide two permanent openings: one within 12" of the ceiling and one within 12" of the floor. Connect these items directly to the outdoors or spaces open to the outdoors. These spaces include attics and crawl spaces. Follow the *National Fuel Gas Code, ANSI Z223.1/NFPA 54, Section 5.3, Air for Combustion and Ventilation* for required size of ventilation grills or ducts.

IMPORTANT: Do not provide openings for inlet or outlet air into attic if attic has a thermostatically controlled power vent. Heated air entering the attic will activate the power vent.

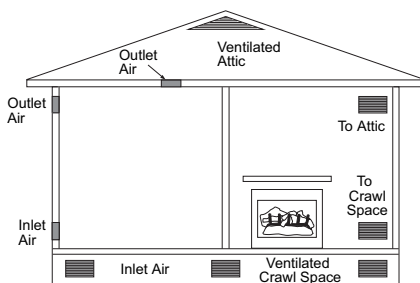

Figure 3 - Ventilation Air from Outdoors

INSTALLATION

NOTICE: This heater is intended for use as supplemental heat. Use this heater along with your primary heating system. Do not install this heater as your primary heat source. If you have a central heating system, you may run system's circulating blower while using heater. This will help circulate the heat throughout the house. In the event of a power outage, you can use this heater as your primary heat source.

WARNING: A qualified service person must install heater. Follow all local codes.

WARNING: Before installing in a solid fuel burning fireplace, the chimney flue and firebox must be cleaned of soot, creosote, ashes and loose paint by a qualified chimney cleaner. Creosote will ignite if highly heated. A dirty chimney flue may create and distribute soot within the house. Inspect chimney and firebox flue for damage. If damaged, repair flue and firebox before operating heater.

WARNING: Seal any fresh air vents or ash clean-out doors located on floor or wall of fireplace. If not, drafting may cause pilot outage or sooting. Use a heat-resistant sealant. Do not seal chimney flue damper.

WARNING: Never install the heater

- in a bedroom or bathroom
- in a recreational vehicle
- where curtains, furniture, clothing or other flammable objects are less than 42" from the front, top or sides of the heater
- in high traffic areas
- in windy or drafty areas

CAUTION: This heater creates warm air currents. These currents move heat to wall surfaces next to heater. Installing heater next to vinyl or cloth wall coverings or operating heater where impurities (such as, but not limited to, tobacco smoke, aromatic candles, cleaning fluids, oil or kerosene lamps, etc.) in the air exist, may discolor walls or cause odors.

WARNING: Antenna and ignition cable must maintain a spacing of 3/4". Failure to keep them separated will result in damage to the receiver. See *Wiring Diagram* on page 24.

IMPORTANT: Vent-free heaters add moisture to the air. Although this is beneficial, installing heater in rooms without enough ventilation air may cause mildew to form from too much moisture. See *Air for Combustion and Ventilation*, page 5.

CHECK GAS TYPE

Use the correct gas type (natural or propane/LP) for your unit. If your gas supply is not correct, do not install heater. Call dealer where you bought heater for proper type heater.

WARNING: This appliance is equipped for (natural or propane/LP) gas. Field conversion is not permitted.

INSTALLATION

Continued

INSTALLATION AND CLEARANCES FOR VENT-FREE OPERATION

WARNING: Maintain the minimum clearances. If you can, provide greater clearances from floor, ceiling and adjoining wall.

MINIMUM FIREPLACE CLEARANCE TO COMBUSTIBLE MATERIALS	
Log Size	18" or 24"
Side Wall	16"
Ceiling	42"
Floor	5"

LOG SIZING REQUIREMENTS				
Minimum Firebox Size				
Log Size	Height	Depth	Front Width	Rear* Width
18"	20"	14"	35"	22 1/2"
24"	20"	14"	35"	22 1/2"

*Measured at 14" depth

Carefully follow the instructions below. This will ensure safe installation into a masonry, UL127-listed manufactured fireplace or listed vent-free firebox enclosure.

Minimum Clearances For Side Combustible Material, Side Wall and Ceiling

A. Clearances from the side of the fireplace cabinet to any combustible material and wall should follow diagram in Figure 4.

Example: The face of a mantel, bookshelf, etc. is made of combustible material and protrudes 3 1/2" from the wall. This combustible material must be 4" from the side of the fireplace cabinet (see Figure 4).

Note: When installing your gas logs into a manufactured firebox, follow firebox manufacturer's instructions for minimum clearances to combustible materials.

B. Clearances from the top of the fireplace opening to the ceiling should not be less than 42".

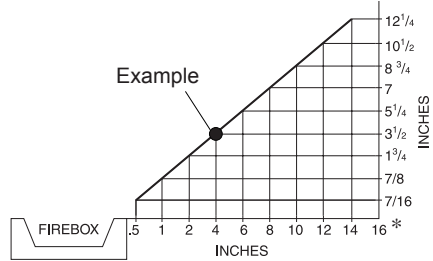

*Minimum 16" from Side Wall

Figure 4 - Minimum Clearance for Combustible to Wall

Minimum Noncombustible Material Clearances If Not Using Mantel

Note: If using a mantel, proceed to *If Using Mantel*. If not using a mantel, follow the information below.

You must have noncombustible material(s) above fireplace opening. Noncombustible materials (such as slate, marble, tile, etc.) must be at least 1/2" thick. With sheet metal, you must have noncombustible material behind it. Noncombustible material must extend at least 8" up (for all models). If noncombustible material is less than 12", you must install the fireplace hood accessory (24" models only). See Figure 5, page 10, for minimum clearances.

If Using Mantel

You must have noncombustible material(s) above the fireplace opening. Noncombustible materials (such as slate, marble, tile, etc.) must be at least 1/2" thick. With sheet metal, you must have noncombustible material behind it. Noncombustible material must extend at least 8" up (for all models). If noncombustible material is less than 12", you must install the fireplace hood accessory. Even if noncombustible material is more than 12", you may need the hood accessory to deflect heat away from your mantel shelf. See Figures 5, 6 and 7, page 10, for minimum clearances.

INSTALLATION

Continued

Noncombustible Material Distance (A)	Requirements for Safe Installation
12" or more	Noncombustible material OK
Between 8" and 12"	Install fire place hood accessory (see <i>Accessories</i> , page 25).
Less than 8	Noncombustible material must be extended to at least 8". See <i>Between 8" and 12"</i> , above. If you cannot extend material, you must operate heater with flue damper open.

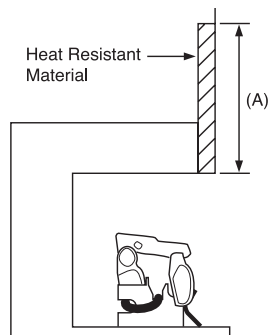

Figure 5 - Heat Resistant Material (Slate, Marble, Tile, etc.) Above Fireplace

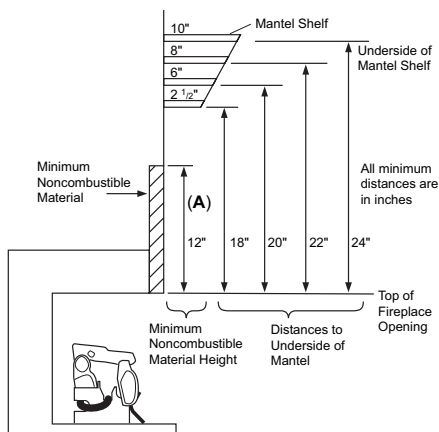

Figure 6 - Minimum Mantel Clearances Without Using Hood

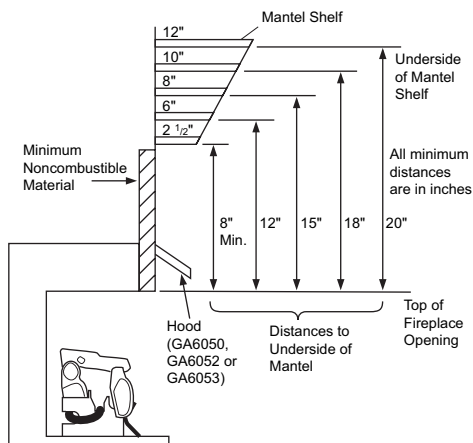

Figure 7 - Minimum Mantel Clearances When Using Hood

INSTALLATION

Continued

MANTEL CLEARANCES

In addition to meeting noncombustible material clearances, you must also meet required clearances between fireplace openings and mantel shelf on each side of the fireplace. If you do not meet the clearances listed below, you will need a hood.

Determining Minimum Mantel Clearance

If you meet minimum clearance between mantel shelf and top of fireplace opening, a hood is not required (see Figure 6, page 10).

Determining Minimum Mantel Clearance When using a Hood

If minimum clearances in Figure 6, page 10 are not met, you must have a hood. When using a hood there are still certain minimum mantel clearances required. Follow minimum clearances shown in Figure 7, page 10 when using hood.

NOTICE: Surface temperatures of adjacent walls and mantels become hot during operation. Walls and mantels above the firebox may become hot to the touch. If installed properly, these temperatures meet the requirement of the national product standard. Follow all minimum clearances shown in this manual.

NOTICE: If your installation does not meet the minimum clearances shown, you must do one of the following:

- operate the logs only with the flue damper open
- raise the mantel to an acceptable height
- remove the mantel

FLOOR CLEARANCES

- If installing appliance on the floor level, you must maintain the minimum distance of 14" to combustibles (see Figure 8).
- If combustible materials are less than 14" to the fireplace, you must install appliance at least 5" above the combustible flooring (see Figure 9).

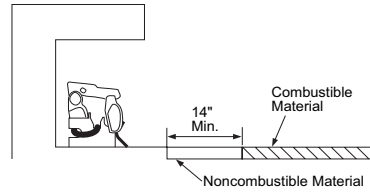

Figure 8 - Minimum Fireplace Clearances If Installed at Floor Level

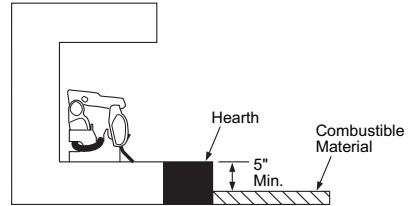

Figure 9 - Minimum Fireplace Clearances Above Combustible Flooring

INSTALLING HEATER ASSEMBLY

CAUTION: Do not remove the data plates attached to the heater base assembly. The data plates contain important warranty and safety information.

WARNING: If installing in a sunken fireplace, special care is needed. You must raise the fireplace floor to allow access to heater control panel. This will insure adequate air flow and guard against sooting and controls being damaged. Raise fireplace floor with noncombustible material. Make sure material is secure.

CAUTION: Do not pick up heater assembly by the logs. This could damage heater. Only handle base assembly by grates.

IMPORTANT: Make sure the heater burner is level. If heater is not level, heater will not work properly.

IMPORTANT: Remote receiver module is attached to the valve by a velcro strap. This module needs to remain where installed. If removed and wires cross, this can cause the remote to fail.

INSTALLATION

Continued

Installation Items Needed

- control cover kit (provided with heater)
 - approved flexible gas hose (if allowed by local codes)
 - sealant (resistant to propane/LP gas, not provided)
1. Apply pipe joint sealant lightly to male threads of gas fitting (not provided). Connect approved flexible gas hose to inlet side of gas control (see Figure 10). **IMPORTANT:** Hold gas fitting with wrench when connecting flexible gas hose.
 2. Position heater assembly in fireplace.
 3. Connect to gas supply. See *Connecting to Gas Supply*.

Flexible Gas Hose
(if allowed by local codes)

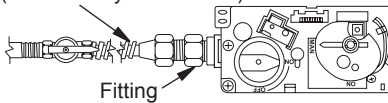

Figure 10 - Attaching Flexible Gas Hose to Regulator

CONNECTING TO GAS SUPPLY

WARNING: This appliance requires a 1/2" NPT (National Pipe Thread) inlet connection to the shutoff valve.

WARNING: A qualified service person must connect heater to gas supply. Follow all local codes.

CAUTION: Never connect propane/LP fireplace directly to the propane/LP supply. This heater requires an external regulator (not supplied). Install the external regulator between the heater and propane/LP supply.

WARNING: Never connect natural gas fireplace to private (non-utility) gas wells. This gas is commonly known as wellhead gas.

Installation Items Needed

Before installing heater, make sure you have the items listed below.

- external regulator (for propane/LP units only, supplied by installer)
- piping (check local codes)
- sealant (resistant to propane/LP gas)
- equipment shutoff valve *
- test gauge connection *
- sediment trap
- tee joint
- pipe wrench
- approved flexible gas line with gas connector (if allowed by local codes)

* A CSA design-certified equipment shutoff valve with 1/8" NPT tap is an acceptable alternative to test gauge connection. Purchase the optional CSA design-certified equipment shutoff valve from your dealer. See *Accessories*, page 25.

For propane/LP units, the installer must supply an external regulator. The external regulator will reduce incoming gas pressure. You must reduce incoming gas pressure to between 11 and 14 inches of water. If you do not reduce incoming gas pressure, heater regulator damage could occur. Install external regulator with the vent pointing down as shown in Figure 11. Pointing the vent down protects it from freezing rain or sleet.

CAUTION: Use only new, black iron or steel pipe. Internally-tinned copper tubing may be used in certain areas. Check your local codes. Use pipe of 1/2" diameter or greater to allow proper gas volume to heater. If pipe is too small, undue loss of volume will occur.

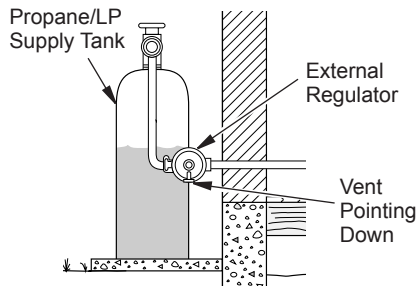

Figure 11 - External Regulator With Vent Pointing Down

INSTALLATION

Continued

Installation must include an equipment shutoff valve, union and plugged 1/8" NPT tap. Locate NPT tap within reach for test gauge hook up. NPT tap must be upstream from heater (see Figure 12).

IMPORTANT: Install equipment shutoff valve in an accessible location. The equipment shutoff valve is for turning on or shutting off the gas to the appliance.

Check your building codes for any special requirements for locating equipment shutoff valve to fireplaces.

Apply pipe joint sealant lightly to male NPT threads. This will prevent excess sealant from going into pipe. Excess sealant in pipe could result in clogged heater valves.

WARNING: Use pipe joint sealant that is resistant to liquid petroleum (LP) gas.

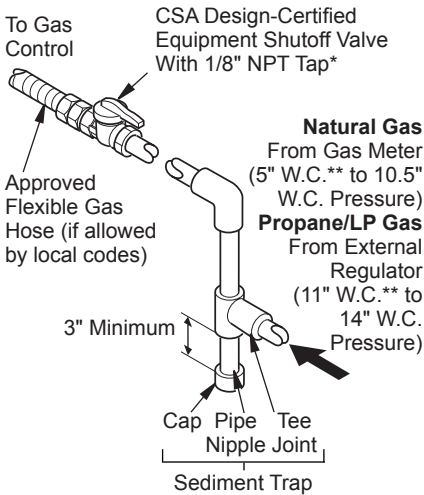

Figure 12 - Gas Connection

* Purchase the optional CSA design-certified equipment shutoff valve from your dealer. See *Accessories*, page 25.

** Minimum inlet pressure for purpose of input adjustment.

We recommend that you install a sediment trap in supply line as shown in Figure 12. Locate sediment trap where it is within reach for cleaning. Install in piping system between fuel supply and heater. Locate sediment trap where trapped matter is not likely to freeze. A sediment trap traps moisture and contaminants. This keeps them from going into heater controls. If sediment trap is not installed or is installed wrong, heater may not run properly.

CAUTION: Avoid damage to gas control. Hold gas control with wrench when connecting it to gas piping and/or fittings.

CHECKING GAS CONNECTIONS

WARNING: Test all gas piping and connections, internal and external to unit, for leaks after installing or servicing. Correct all leaks at once.

WARNING: Never use an open flame to check for a leak. Apply a noncorrosive leak detection fluid to all joints. Bubbles forming show a leak. Correct all leaks at once.

CAUTION: Make sure external regulator has been installed between propane/LP supply and heater. See guidelines under *Connecting to Gas Supply*, page 12.

PRESSURE TESTING GAS SUPPLY PIPING SYSTEM

Test Pressures In Excess Of 1/2 PSIG (3.5 kPa)

1. Disconnect appliance with its appliance main gas valve (control valve) and equipment shutoff valve from gas supply piping system. Pressures in excess of 1/2 psig will damage heater regulator.
2. Cap off open end of gas pipe where equipment shutoff valve was connected.
3. Pressurize supply piping system by either opening propane/LP supply tank valve for propane/LP gas or opening main gas valve located on or near gas meter for natural gas or using compressed air.

INSTALLATION

Continued

4. Check all joints of gas supply piping system. Apply noncorrosive leak detection fluid to all joints. Bubbles forming show a leak.
5. Correct all leaks at once.
6. Reconnect heater and equipment shutoff valve to gas supply. Check reconnected fittings for leaks.

Test Pressures Equal To or Less Than 1/2 PSIG (3.5 kPa)

1. Close equipment shutoff valve (see Figure 13).
2. Pressurize supply piping system by either opening propane/LP supply tank valve for propane/LP gas or opening main gas valve located on or near gas meter for natural gas or using compressed air.
3. Check all joints from gas meter to equipment shutoff valve for natural gas or propane/LP supply to equipment shutoff valve for propane/LP (see Figure 14 or 15). Apply noncorrosive leak detection fluid to all joints. Bubbles forming show a leak.
4. Correct all leaks at once.

PRESSURE TESTING HEATER GAS CONNECTIONS

1. Open equipment shutoff valve (see Figure 13).
2. Open main gas valve located on or near gas meter for natural gas or open propane/LP supply tank valve.
3. Make sure control knob of heater is in the OFF position.

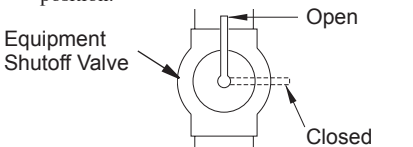

Figure 13 - Equipment Shutoff Valve

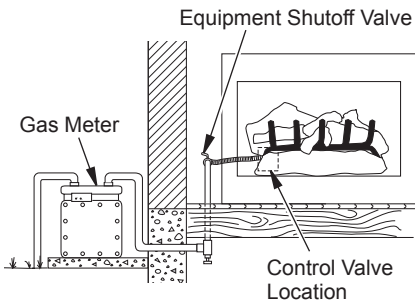

Figure 14 - Checking Gas Joints for Natural Gas

4. Check all joints from equipment shutoff valve to control valve (see Figure 14 or 15). Apply noncorrosive leak detection fluid to all joints. Bubbles forming show a leak.
5. Correct all leaks at once.
6. Light heater (see *Operating Heater*, page 15). Check all other internal joints for leaks.
7. Turn off heater (see *To Turn Off Gas to Appliance*, page 18).

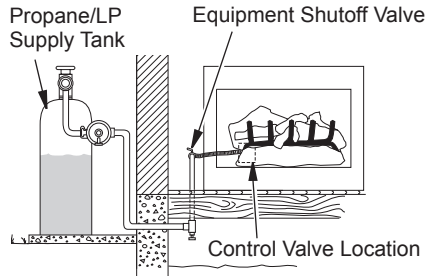

Figure 15 - Checking Gas Joints for Propane/LP Gas

ADDING EMBERS, LAVA ROCK AND DECORATIVE LOGS

The effect of glowing embers is created by placing ember material on the front burner.

1. Make sure the heater is OFF and has cooled if it has been running.
2. Gently remove embers from the bag using gloves or tweezers (recommended to prevent skin irritation). Separate the pieces.
3. Place ember pieces, one at a time, over ports on flat burner (see Figure 16). **Do NOT place ember material anywhere else on the unit.** Use only ember material supplied with unit (12 one inch square pieces). Excessive ember material may produce carbon monoxide or soot.

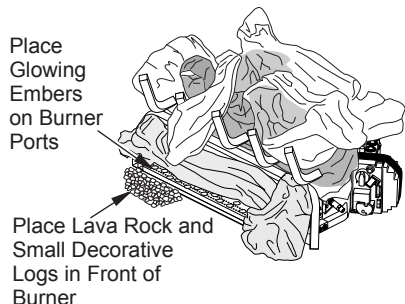

Figure 16 - Placement of Embers and Lava Rock

INSTALLATION

Continued

4. Add lava rock and small decorative logs around base of heater if desired. You may place lava rock and log pieces up to flat burner. **DO NOT place rock or logs on front burner or on logs.** Placing any material on unit other than ember material on front burner may result in production of carbon monoxide or soot.

OPERATING HEATER

**FOR YOUR SAFETY
READ BEFORE LIGHTING**

⚠ WARNING: If you do not follow these instructions exactly, a fire or explosion may result causing property damage, personal injury or loss of life.

- A. This appliance has a pilot which must be lighted by hand. When lighting the pilot, follow these instructions exactly.
- B. **BEFORE LIGHTING** smell all around the appliance area for gas. Be sure to smell next to the floor because some gas is heavier than air and will settle on the floor.

WHAT TO DO IF YOU SMELL GAS

- Do not try to light any appliance.
 - Do not touch any electric switch; do not use any phone in your building.
 - Immediately call your gas supplier from a neighbor's phone. Follow the gas supplier's instructions.
 - If you cannot reach your gas supplier, call the fire department.
- C. Use only your hand to push in or turn the gas control knob. Never use tools. If the knob will not push in or turn by hand, don't try to repair it, call a qualified service technician or gas supplier. Force or attempted repair may result in a fire or explosion.
 - D. Do not use this appliance if any part has been under water. Immediately call a qualified service technician to inspect the appliance and to replace any part of the control system and any gas control which has been under water.

REMOTE LIGHTING INSTRUCTIONS

⚠ WARNING:

- If fireplace has glass doors, never operate this heater with glass doors closed. If you operate heater with doors closed, heat buildup inside fireplace will cause glass to burst. Make sure there are no obstructions across openings of fireplace.
- You must operate this heater with a fireplace screen in place. Make sure fireplace screen is closed before running heater.

NOTICE: During initial operation of new heater, burning logs will give off a paper-burning smell. Orange flame will also be present. Open damper or window to vent smell. This will only last a few hours.





⚠ CAUTION: A mild gas flash within 10 seconds is normal during shutdown of this heater. Remain clear of the hearth area for the entire shutdown process to avoid possible injury.

1. **STOP!** Read the safety information in column 1.
2. Make sure equipment shutoff valve is fully open.
3. Turn motor knob clockwise  to the OFF position.
4. Wait five (5) minutes to clear out any gas. Then smell for gas, including near the floor. If you smell gas, **STOP!** Follow "B" in the safety information, column 1. If you don't smell gas, go to the next step.
5. Make sure ON/OFF switch is in "-" (ON) position.

⚠ WARNING: Burner will come on automatically within one minute after pilot burner is lighted.

OPERATING HEATER

Continued

- Press the buttons  and  at the same time. A short acoustic signal confirms the start sequence has begun.
Further short acoustic signals (0.2 sec., 1 Hz) indicate the ignition process until it is completed and main gas flows. If pilot is already lit, motor will turn on (max. flame height) while buttons are pressed down. If pilot does not light, see *Troubleshooting*, page 21.
- Press  to turn on main burner and increase flame height. Press  to decrease flame height and shut off main burner.
- Short tapping of either button allows incremental change in flame height.
- Press OFF button to switch off main gas and pilot gas.

FUNCTIONS OF REMOTE CONTROL

Battery

- After the charged battery has been correctly installed, the remote hand set is ready for operations.
- Remove the battery if the remote handset will not be used more than one year.

Changing The Code

The control is radio frequency operated. A code (chosen from among 4,000 available codes) is preset for all valves, but can be changed if required (15 additional codes available). Change DIP switch position. (The DIP switch is located inside the hand held control at the top of the battery compartment.) Then press the receiver's reset button on the bottom of the receiver module until you hear a second (longer) signal. When pressing the  button on the remote handset in the following 20 sec., the receiver learns the new code.

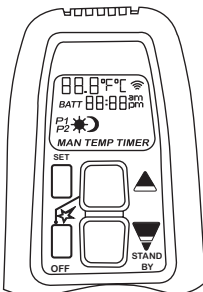



Figure 17 - Control Panel for Hand-Held Remote





Shut-off Procedure

To save battery power; press  to turn main gas to pilot gas. Press OFF button to shut off the device including pilot flame. The device can be shut off with ON/OFF switch, thus disabling the remote hand set.

Setting The Display (°C/24h and °F /12h)

Press and hold OFF and  until display changes from °F (and 12 hour clock) to °C (and 24 hour clock) or vice versa.







Setting The Time

- After connecting the battery or by simultaneously pressing  and  the display will start to flash. You are in the set mode.
- From SET mode press  to set the hour and  to set the minute.
- Wait or press OFF to return to the manual mode.

Battery Replacement

Remote handset battery needs to be changed when LED is dim. Battery life expectancy is 2 to 3 years. Replacement is recommended at the beginning of heating season. Battery needs to be changed when acoustic error message appears during ignition (see *Identifying Error Signals from Receiver* on page 24).

Changing Mode of Operation

- Press the SET button quickly to change the mode of operation in the following order:
MAN,  TEMP,  TEMP, TIMER.
- Manual flame height adjustment (**MAN** appears on display): Press  to turn on the fire (main burner) or to increase flame height. Press  to decrease flame or to go down to pilot only. The receiver acknowledges the transmission with an acoustic signal.
- The day time temperature mode ( **TEMP** appears on display): The sensor in the transmitter measures room temperature. The controller compares the room temperature with set temperature and sends a signal to the receiver to turn the gas valve motor up or down, to adjust the flame height accordingly.
- The nighttime setback temperature ( **TEMP** appears on display): The sensor in the transmitter measures the temperature and adjusts it according to the nighttime setback temperature. There is a bigger temperature differential during this cycle.

OPERATING HEATER

Continued

- **Timer:** The timer mode (**TIMER**) operates much like the temperature mode above. The timer setting allows you to set specific times for on and off. (There are 2 burner on and 2 burner off cycles every 24 hours.) If the reading for the nighttime temp. is "---", the motor will turn off the valve to standby pilot position and wait for the next burner on cycle. This display shows the setting temperature every 30 seconds.

Setting the Temperature

- Select the desired mode of operation (day or night) by pressing the **SET** button briefly.
- Hold the **SET** button until the display flashes.
- Set the temperature with the ▲ or ▼ (40°F is the minimum temperature).
- Wait or press **OFF** to go to temperature control mode.
- If temperature control in moon times should be off (lower battery consumption), decrease the night temperature until "---" appears on display.

Set Timer

- Switch to timer mode by pressing the **SET** button briefly.
- Press the **SET** button until **P1** ⚡ flashes.
- Set the hours with ▲ and minutes with ▼.
- Press **SET** briefly for the next burner cycle time.
- If all 4 times are set, pressing the **OFF** button or waiting will complete the programming.

Shutting Off Heater

Press **OFF** button on remote control to switch off main gas and pilot gas.

Shutting Off Burner Only (pilot stays lit)

Press ▼ to decrease the flame height and shut off main burner.

MANUAL LIGHTING PROCEDURE

⚠ WARNING: Manual lighting must be performed by a qualified service person.

The system has a "MANUAL OVERRIDE" feature that allows you to light with a match.

Lighting with a Match

1. **STOP!** Read the safety information on page 15.
2. Make sure equipment shutoff valve is fully open.
3. Turn motor-knob clockwise to ↷ to **OFF** position.
4. Wait (5) minutes to clear any gas and then smell for gas around heater and near floor. If you smell gas, **STOP!** follow "B" on page 15. If you do not smell gas, go to the next step.
5. Make sure **ON/OFF** switch is in "-" (**ON**) position.
6. **MAN**-knob (valve) in **MAN** position, a metallic core is visible. (see Figure 18).
7. Push and hold down metal core fully by using a non-sharp object such as a pen. This lets the pilot gas flow.
8. Light pilot burner with a match, (see Figure 19).
9. Continue holding down metal core for about 10 seconds. Pilot should stay lit after releasing metal core. If not, repeat step 1 thru 4.
10. Turn **MAN**-knob to **ON** position. This lets main gas flow.
11. Turn **Motor**-knob to adjust flame. Knob has a slipping clutch that allows manual flame height adjustment as well as adjustment to pilot gas.

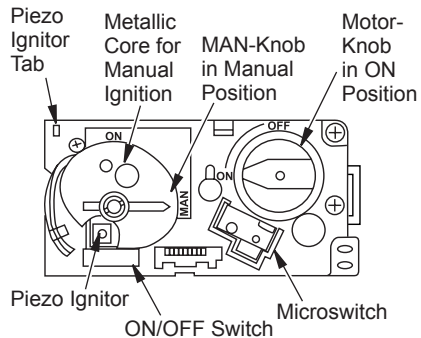

Figure 18 - Control Valve

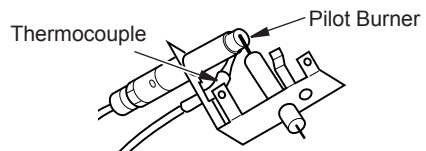



Figure 19 - Pilot

OPERATING HEATER

Continued

Lighting with Piezo Ignitor

1. Disconnect ignitor cable from receiver and connect to Piezo Ignitor Tab (see Figure 18, page 17 and *Wiring Diagram* on page 24).
2. **STOP!** Read safety information on page 15,
3. Make sure equipment shutoff valve is fully open.
4. Turn Motor-knob clockwise  to the OFF position.
5. Wait (5) minutes to clear any gas and then smell for gas around heater and near floor. If you smell gas, STOP! follow "B" on page 14.
6. ON/OFF switch in "—" ON position.
7. MAN-knob on valve is in MAN position (see Figure 18, page 17), When in MAN position you can see a metallic core.
8. Push and hold down metal core fully with a pen while the pilot gas flows.
9. Press and release piezo ignitor button until pilot lights.
10. Continue holding down metal core for about 10 seconds and then release the metal core. Pilot should stay lit. If not, repeat steps one through 4, page 17.
11. Turn MAN-Knob to ON position - main gas flows.
12. Turn Motor-knob to adjust flame. Knob has a slipping clutch that allows manual flame height adjustment.

TO TURN GAS OFF TO APPLIANCE

Shutting Off Heater

Press OFF button on remote control to switch off main gas and pilot gas or manually turn Motor-Knob clockwise  to the "O" OFF position.

Shutting Off Burner Only (pilot stays lit)

Press to decrease the flame height and shut off main burner.

INSPECTING BURNERS

Check pilot flame pattern and burner flame patterns often.

PILOT FLAME PATTERN

Figure 20 shows a correct pilot flame pattern. Figure 21 shows an incorrect pilot flame pattern. The incorrect pilot flame is not touching the thermocouple. When the thermocouple cools, the heater will shut down.

If pilot flame pattern is incorrect, as shown in Figure 21

- turn heater off (see *To Turn Off Gas to Appliance*, above or page 17)
- see *Troubleshooting*, page 20

Note: The pilot flame on natural gas units will have a slight curve, but flame should be blue and have no yellow or orange color.

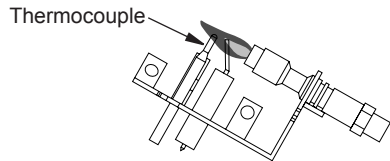

**Figure 20 - Correct Pilot Flame Pattern
(Natural Gas Pilot Shown)**

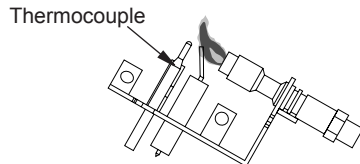

**Figure 21 - Incorrect Pilot Flame Pattern
(Natural Gas Pilot Shown)**

INSPECTING BURNERS

Continued

BURNER FLAME PATTERN

Figure 22 shows correct burner flame pattern.

NOTICE: Do not mistake orange flames with yellow tipping. Dirt or other fine particles are burned by heater, causing brief patches of orange flame.

If burner flame pattern is incorrect, as shown in Figure 23

- turn appliance off (see *To Turn Off Gas to Appliance* on page 18)
- see *Troubleshooting*, page 21

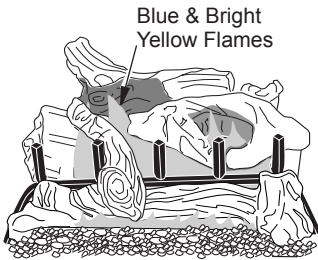

Figure 22 - Correct Burner Flame Pattern

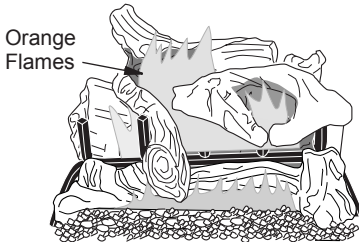

Figure 23 - Incorrect Burner Flame Pattern

CLEANING AND MAINTENANCE

WARNING: Turn off heater and let cool before cleaning.

CAUTION: You must keep control areas, burner and circulating air passageways of heater clean. Inspect these areas of heater before each use. Have heater inspected yearly by a qualified service person. Heater may need more frequent cleaning due to excessive lint from carpeting, bedding material, pet hair, etc.

WARNING: Failure to keep the primary air opening(s) of the burner(s) clean may result in sooting and property damage.

BURNER INJECTOR HOLDER AIR INLET HOLE

The primary air inlet holes allow the proper amount of air to mix with the gas. This provides a clean burning flame. Keep these holes clear of dust, dirt, lint and pet hair. Clean these air inlet holes prior to each heating season. Blocked air holes will create soot. We recommend that you clean the unit every three months during operation and have heater inspected yearly by a qualified service person.

We also recommend that you keep the burner tube clean and free of dust and dirt. We recommend using compressed air no greater than 30 PSI. Your local computer store, hardware store or home center may carry compressed air in a can. You can use a vacuum cleaner in the blow position. If using compressed air in a can, please follow the directions on the can. If you don't follow directions on the can, you could damage the pilot assembly.

Before cleaning, shut off the unit, including the pilot. Allow the unit to cool for at least thirty minutes. You will need to remove the front log to access the front burner.

CLEANING AND MAINTENANCE

Continued

1. Remove two screws from back of unit that attach main log assembly to base assembly (see Figure 24).
2. Remove screws from left and right side of front log assembly to remove from base assembly (see Figure 24).
3. Inspect burner and primary air inlet holes on injector holder of each burner for dust and dirt (see Figures 24 and 25).
4. Blow air through the ports/slots and holes in the burner.

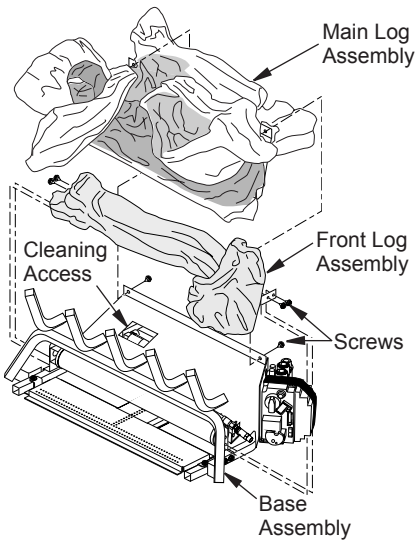

Figure 24 - Removing Front Log to Clean Front Burner

5. Check the injector holder located at the end of the burner tube again. Remove any large particles of dust, dirt, lint or pet hair with a soft cloth or vacuum cleaner nozzle.
6. Blow air into the primary air holes on the injector holder.
7. In case any large clumps of dust have now been pushed into the burner repeat steps 5 and 6.

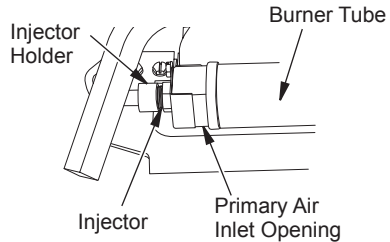





Figure 25 - Injector Holder on Front Burner Tube

TROUBLESHOOTING

⚠ WARNING: Turn off heater and let cool before servicing. Only a qualified service person should service and repair heater.

⚠ CAUTION: Never use a wire, needle or similar object to clean ODS/pilot. This can damage ODS/pilot unit.

Note: All troubleshooting items are listed in order of operation.

OBSERVED PROBLEM	POSSIBLE CAUSE	REMEDY
When  and  are pressed at the same time, there is no spark at ODS/pilot	<ol style="list-style-type: none"> 1. Switch in OFF position (module gives long steady beep) 2. Ignitor electrode not connected to ignitor cable 3. Ignitor cable pinched or wet 4. Broken ignitor cable 5. Bad piezo ignitor 6. Ignitor electrode positioned wrong or broken 7. Bad module 	<ol style="list-style-type: none"> 1. Push switch on valve to "-" position 2. Reconnect ignitor cable 3. Free ignitor cable if pinched by any metal or tubing. Keep ignitor cable dry 4. Replace ignitor cable 5. Replace piezo ignitor 6. Replace pilot assembly 7. Replace module
When  and  are pressed, there is spark at ODS/pilot but no ignition	<ol style="list-style-type: none"> 1. Gas supply turned off or equipment shutoff valve closed 2. Control knob not in PILOT position 3. Control knob not pressed in while in PILOT position 4. Air in gas lines when installed 5. Depleted gas supply (propane/LP only) 6. ODS/pilot is clogged 7. Gas regulator setting is not correct 8. Bad module 	<ol style="list-style-type: none"> 1. Turn on gas supply or open equipment shutoff valve 2. Turn control knob to PILOT position 3. Press in control knob while in PILOT position 4. Continue holding down control knob. Repeat igniting operation until air is removed 5. Contact local propane/LP gas company 6. Clean ODS/pilot (see <i>Cleaning and Maintenance</i>, page 19) or replace ODS/pilot assembly 7. Replace gas regulator 8. Replace module
Burner does not light after pilot is lit	<ol style="list-style-type: none"> 1. Inlet gas pressure is too low 2. Wire disconnected from gas control 3. Burner orifice(s) clogged 5. Bad module 	<ol style="list-style-type: none"> 1. Contact local natural or propane/LP gas company 2. Reconnect leads (see <i>Wiring Diagram</i>, page 24) 3. Clean burner (see <i>Cleaning and Maintenance</i>, page 19) or replace burner orifice(s) 5. Replace module
Delayed ignition burner	<ol style="list-style-type: none"> 1. Manifold pressure is too low 2. Burner orifice(s) clogged 	<ol style="list-style-type: none"> 1. Contact local natural or propane/LP gas company 2. Clean burner (see <i>Cleaning and Maintenance</i>, page 19) or replace burner orifice

TROUBLESHOOTING

Continued

OBSERVED PROBLEM	POSSIBLE CAUSE	REMEDY
Burner backfiring during combustion	<ol style="list-style-type: none">1. Burner orifice is clogged or damaged2. Damaged burner3. Gas regulator defective	<ol style="list-style-type: none">1. Clean burner (see <i>Cleaning and Maintenance</i>, page 19) or replace burner orifice2. Replace damaged burner3. Replace gas regulator
Orange flame in burner during burner combustion	<ol style="list-style-type: none">1. Not enough air2. Gas regulator defective	<ol style="list-style-type: none">1. Check burner for dirt and debris. If found, clean burner (see <i>Cleaning and Maintenance</i>, page 19)2. Replace gas control
Slight smoke or odor during initial operation (first hour)	<ol style="list-style-type: none">1. Residues from manufacturing processes and logs curing	<ol style="list-style-type: none">1. Problem will stop after a few hours of operation
Heater produces a whistling noise when burner is lit	<ol style="list-style-type: none">1. Turning control knob to HI position when burner is cold2. Air in gas line3. Air passageways on heater blocked4. Dirty or partially clogged burner orifice(s)	<ol style="list-style-type: none">1. Turn control knob to LO position and let warm up for a minute2. Operate burner until air is removed from line. Have gas line checked by local natural or propane/LP gas company3. Observe minimum installation clearances (see page 9)4. Clean burner (see <i>Cleaning and Maintenance</i>, page 19) or replace burner orifice
White powder residue forming within burner box or on adjacent walls or furniture	<ol style="list-style-type: none">1. When heated, vapors from furniture polish, wax, carpet cleaners, etc. may turn into white powder residue	<ol style="list-style-type: none">1. Turn heater off when using furniture polish, wax, carpet cleaners or similar products
Moisture/condensation noticed on windows	<ol style="list-style-type: none">1. Not enough combustion/ventilation air	<ol style="list-style-type: none">1. Refer to <i>Air for Combustion and Ventilation</i> requirements (page 5)

TROUBLESHOOTING

Continued



WARNING: If you smell gas

- Shut off gas supply.
- Do not try to light any appliance.
- Do not touch any electrical switch; do not use any phone in your building.
- Immediately call your gas supplier from a neighbor's phone. Follow the gas supplier's instructions.
- If you cannot reach your gas supplier, call the fire department.

IMPORTANT: Operating heater where impurities in air exist may create odors. Cleaning supplies, paint, paint remover, cigarette smoke, cements and glues, new carpet or textiles, etc., create fumes. These fumes may mix with combustion air and create odors. These odors will disappear over time.

OBSERVED PROBLEM	POSSIBLE CAUSE	REMEDY
Remote does not function	<ol style="list-style-type: none">1. Battery is not installed. Battery power is low2. Bad module	<ol style="list-style-type: none">1. Replace 9-volt batteries in receiver and remote control2. Replace module
Heater produces a clicking/ticking noise just after burner is lit or shut off	<ol style="list-style-type: none">1. Metal expanding while heating or contracting while cooling	<ol style="list-style-type: none">1. This is common with most heaters. If noise is excessive, contact qualified service person
Heater produces unwanted odors	<ol style="list-style-type: none">1. Heater burning vapors from paint, hair spray, glues, cleaners, chemicals, new carpet, etc. (See <i>IMPORTANT</i> statement above)2. Low fuel supply (propane/LP only)3. Gas leak. See Warning statement at top of page	<ol style="list-style-type: none">1. Open window to ventilate room. Stop using odor causing products while heater is running2. Refill supply tank (propane/LP only)3. Locate and correct all leaks (see <i>Checking Gas Connections</i>, page 13)
Heater shuts off in use (ODS operates)	<ol style="list-style-type: none">1. Not enough fresh air is available2. Low line pressure3. ODS/pilot is partially clogged4. Thermostat on remote is satisfied	<ol style="list-style-type: none">1. Open window and/or door for ventilation2. Contact local natural or propane/LP gas company3. Clean ODS/pilot (see <i>Cleaning and Maintenance</i>, page 19)4. Adjust temperature
Gas odor even when control knob is in OFF position	<ol style="list-style-type: none">1. Gas leak. See Warning statement at top of page2. Control valve or gas control defective	<ol style="list-style-type: none">1. Locate and correct all leaks (see <i>Checking Gas Connections</i>, page 13)2. Replace control valve or gas control
Gas odor during combustion	<ol style="list-style-type: none">1. Foreign matter between control valve and burner2. Gas leak. See Warning statement at top of page	<ol style="list-style-type: none">1. Take apart gas tubing and remove foreign matter2. Locate and correct all leaks (see <i>Checking Gas Connections</i>, page 13)

TROUBLESHOOTING

Continued

IDENTIFYING ERROR SIGNALS FROM RECEIVER

OBSERVED PROBLEM	POSSIBLE CAUSE	REMEDY
Long signals (0.8 second tone, 0.2 second break) during ignition	Battery nearly down. (When signal appears the first time approximately 10 ignitions left)	Replace battery
5 second continuous tone	Cable is not connected, ON/OFF switch is in OFF position	Connect cables
5 short signals (8.2 second tone, 0.2 second break)	Ignition not successful, possible air in supplyline	Switch to ON. Repeat procedure

WIRING DIAGRAM

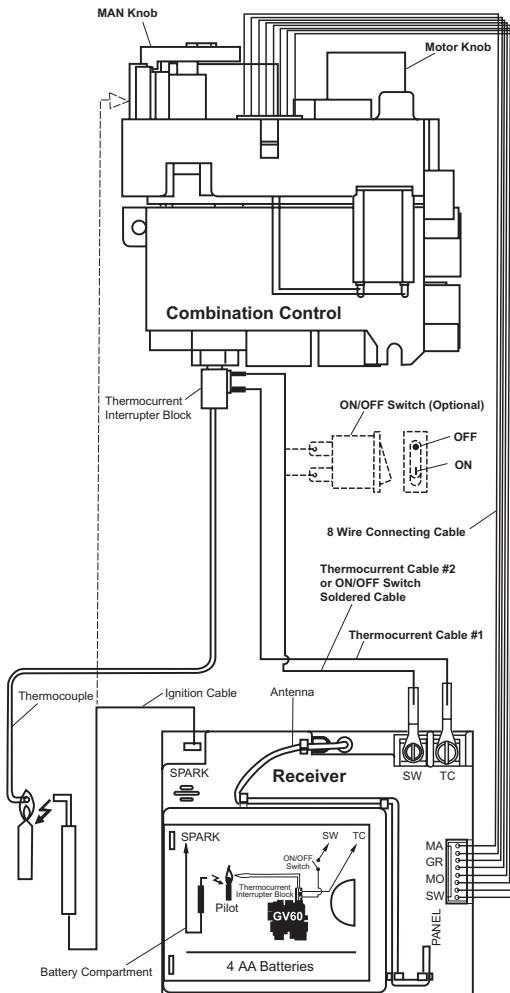

REPLACEMENT PARTS

Note: Use only original replacement parts. This will protect your warranty coverage for parts replaced under warranty.

PARTS UNDER WARRANTY

Contact authorized dealers of this product. If they can't supply original replacement part(s), call DESA's Technical Service Department at 1-866-672-6040.

When calling DESA, have ready

- your name
- your address
- model and serial numbers of your appliance
- how appliance was malfunctioning
- type of gas used (propane/LP or natural gas)
- purchase date

Usually, we will ask you to return the part to the factory.

PARTS NOT UNDER WARRANTY

Contact authorized dealers of this product. If they can't supply original replacement part(s), call DESA at 1-866-672-6040 for referral information.

When calling DESA, have ready

- model number of your appliance
- the replacement part number

SERVICE HINTS

When Gas Pressure Is Too Low

- pilot will not stay lit
- burners will have delayed ignition
- heater will not produce specified heat
- propane/LP gas supply may be low

You may feel your gas pressure is too low. If so, contact your local propane/LP or natural gas supplier.

TECHNICAL SERVICE

You may have further questions about installation, operation, or troubleshooting. If so, contact DESA's Technical Service Department at 1-866-672-6040. When calling please have your model and serial numbers of your appliance ready.

You can also visit DESA's technical services web site at www.desatech.com.

ACCESSORIES

Purchase these heater accessories from your local dealer. If they can not supply these accessories, call DESA at 1-866-672-6040 for referral information. You can also write to the address listed on the back page of this manual.

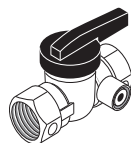

EQUIPMENT SHUTOFF VALVE GA5010

For all models. Equipment shutoff valve with 1/8" NPT tap. Fits 1/2" NPT pipe.

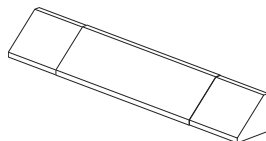

FIREPLACE HOOD

Black - GA6050

Brass - GA6052

Antique Brass - GA6053

For all models. Helps deflect heat away from mantel or wall above fireplace. Fits openings 28" to 48" wide.

LAVA ROCK - GA6060

(Not Shown)

For all models. Order when additional rock is desired. (1.8 lb. bag)

CLEANING KIT - GCK

(Not Shown)

For all models. Your vent-free gas appliance requires regular cleaning and maintenance to prevent performance problems. This kit gives you the tools and instructions to make it easy to clean all critical areas of your appliance.

INFORMATION VIDEO - 108917-01

For all models. A care and maintenance video is available by calling 1-866-672-6040. You may also email your request to productsupport@desaint.com.

ILLUSTRATED PARTS BREAKDOWN

MODELS VF-18N-MHD, VF-18P-MHD, VF-24N-MHD AND VF-24P-MHD

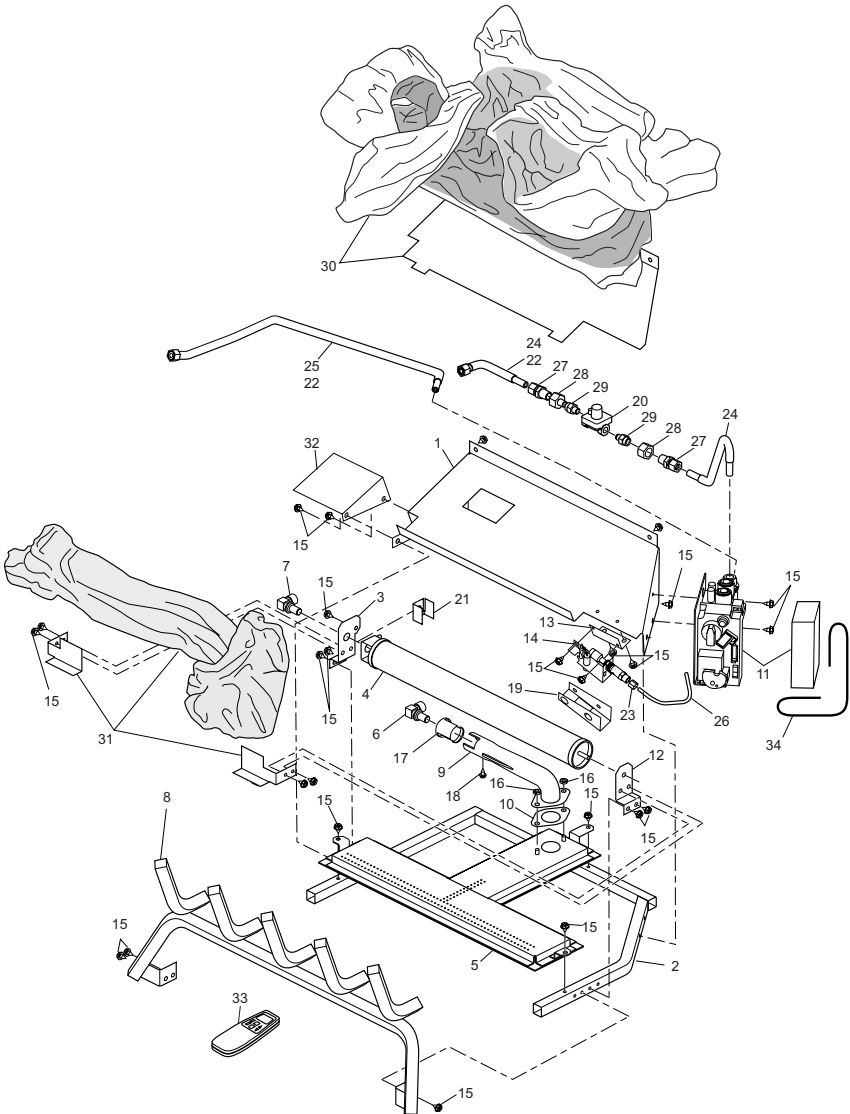

PARTS LIST

This list contains replaceable parts used in your heater. When ordering parts, follow the instructions listed under *Replacement Parts* on page 25 of this manual.

KEY		PART NUMBER				DESCRIPTION	QTY.
NO.	VF-18N-MHD	VF-18P-MHD	VF-24N-MHD	VF-24P-MHD			
1	116950-01	116950-01	116805-01	116805-01	Base	1	
2	116853-02	116853-02	116853-01	116853-01	Base Support	1	
3	116943-02	116943-01	116810-01	116810-02	Left Burner Bracket	1	
4	116951-01	116951-01	116806-01	116806-01	Rear Burner	1	
5	116952-01	116952-01	116811-01	116811-01	Pan Burner	1	
6	111819-07	111819-11	111819-06	111819-10	Front Orifice	1	
7	111819-18	111819-19	111819-16	111819-17	Rear Orifice	1	
8	116955-01	116955-01	116815-01	116815-01	Grate	1	
9	14391	14391	14391	14391	Venturi Tube	1	
10	14527	14527	14527	14527	Burner Gasket	1	
11	116807-01	116807-02	116807-01	116807-02	Valve Assembly	1	
12	116943-02	116943-02	116816-01	116816-01	Right Burner Bracket	1	
13	116854-01	116854-01	116854-01	116854-01	Pilot Bracket	1	
14	104285-01	104286-01	104285-01	104286-01	ODS Pilot	1	
15	M11084-26	M11084-26	M11084-26	M11084-26	Screw, HWH AB 10-16 x 0.38	27	
16	11209	11209	11209	11209	Hex Nut	2	
17	112829-01	112829-01	112829-01	112829-01	Air Shutter	1	
18	M11084-38	M11084-38	M11084-38	M11084-38	Screw, HWH AB 8-18 x 0.38	1	
19	117004-01	—	117004-01	117004-01	Pilot Shield	1	
20	099918-03	099918-02	099918-03	099918-02	Burner Regulator	1	
21	116957-01	111803-03	116957-01	—	Air Shutter	1	
22	111824-01	111824-01	111824-01	111824-01	Nut/Sleeve, 3/8"	2	
23	111828-01	111828-01	111828-01	111828-01	Nut/Sleeve, 3/16"	1	
24	111817-05	111817-05	111817-05	111817-05	3/8" Flextube - 7"	2	
25	111817-04	111817-04	—	—	3/8" Flextube - 21"	1	
	—	—	111817-09	111817-09	3/8" Flextube - 26"	1	
26	111817-03	111817-03	111817-03	111817-03	3/16" Flextube	1	
27	14396	14396	14396	14396	Male Adapter Fitting	2	
28	117029-01	117029-01	117029-01	117029-01	Female Adapter Fitting	2	
29	117030-01	117030-01	117030-01	117030-01	Compression Adapter, Female	2	
30	117992-02	117992-02	117026-03	117026-03	Rear Log Kit	1	
31	117992-01	117992-01	117026-02	117026-02	Front Log Kit	1	
32	117495-01	117495-01	117495-01	117495-01	Caution Decal Bracket	1	
33	116673-02	116673-02	116673-02	116673-02	Hand-Held Remote Control	1	
34	117307-01	117307-01	117307-01	117307-01	Velcro Strap	1	
PARTS AVAILABLE — NOT SHOWN							
	100563-01	100563-01	100563-01	100563-01	Warning Plate	1	
	112796-01	112796-01	112796-01	112796-01	Lighting Instructions Plate	1	
	100639-03	100639-03	100639-03	100639-03	Caution Decal	1	
	111288-02	111288-02	111288-02	111288-02	Gas Line Flex with Shut Off	1	
	117071-01	117071-01	117071-01	117071-01	Control Cover Kit	1	
	117501-01	117501-01	117501-01	117501-01	5 Piece Scrap Log Kit	1	
	GA6060	GA6060	GA6060	GA6060	Lava Rock	1	
	117685-02	117685-02	117685-01	117685-01	Ember Material	1	

** Not a field replaceable part

WARRANTY INFORMATION

KEEP THIS WARRANTY

Model _____
Serial No. _____
Date Purchased _____

Always specify model and serial numbers when communicating with the factory.

We reserve the right to amend these specifications at any time without notice. The only warranty applicable is our standard written warranty. We make no other warranty, expressed or implied.

LIMITED WARRANTY

VENT-FREE GAS LOG HEATERS

DESA warrants this product to be free from defects in materials and components for four (4) years from the date of first purchase, provided that the product has been properly installed, operated and maintained in accordance with all applicable instructions. To make a claim under this warranty the Bill of Sale or cancelled check must be presented.

This warranty is extended only to the original retail purchaser. This warranty covers the cost of part(s) required to restore this heater to proper operating condition and an allowance for labor when provided by a DESA Authorized Service Center. Warranty part(s) MUST be obtained through authorized dealers of this product and/or DESA who will provide original factory replacement parts. Failure to use original factory replacement parts voids this warranty. The heater MUST be installed by a qualified installer in accordance with all local codes and instructions furnished with the unit.

This warranty does not apply to parts that are not in original condition because of normal wear and tear or parts that fail or become damaged as a result of misuse, accidents, lack of proper maintenance or defects caused by improper installation. Travel, diagnostic cost, labor, transportation and any and all such other costs related to repairing a defective heater will be the responsibility of the owner.

TO THE FULL EXTENT ALLOWED BY THE LAW OF THE JURISDICTION THAT GOVERNS THE SALE OF THE PRODUCT; THIS EXPRESS WARRANTY EXCLUDES ANY AND ALL OTHER EXPRESSED WARRANTIES AND LIMITS THE DURATION OF ANY AND ALL IMPLIED WARRANTIES, INCLUDING WARRANTIES OF MERCHANTABILITY AND FITNESS FOR A PARTICULAR PURPOSE TO FOUR (4) YEARS ON ALL COMPONENTS FROM THE DATE OF FIRST PURCHASE; AND DESA'S LIABILITY IS HEREBY LIMITED TO THE PURCHASE PRICE OF THE PRODUCT AND DESA SHALL NOT BE LIABLE FOR ANY OTHER DAMAGES WHATSOEVER INCLUDING INDIRECT, INCIDENTAL OR CONSEQUENTIAL DAMAGES.

Some states do not allow a limitation on how long an implied warranty lasts or an exclusion or limitation of incidental or consequential damages, so the above limitation on implied warranties or exclusion or limitation on damages may not apply to you.

This warranty gives you specific legal rights and you may also have other rights that vary from state to state.

For information about this warranty write:



2701 Industrial Drive
P.O. Box 90004
Bowling Green, KY 42102-9004
www.desatech.com



116986 01

NOT A UPC

116986-01
Rev. B
10/05

Free Manuals Download Website

<http://myh66.com>

<http://usermanuals.us>

<http://www.somanuals.com>

<http://www.4manuals.cc>

<http://www.manual-lib.com>

<http://www.404manual.com>

<http://www.luxmanual.com>

<http://aubethermostatmanual.com>

Golf course search by state

<http://golfingnear.com>

Email search by domain

<http://emailbydomain.com>

Auto manuals search

<http://auto.somanuals.com>

TV manuals search

<http://tv.somanuals.com>