

## Purchaser's Reference Information

IT IS IMPERATIVE THAT YOU FILL IN THE FOLLOWING INFORMATION AND REFER TO IT SHOULD THE NEED FOR SERVICE ARISE.

Product Name: Diamondback 500Ub Upright or 500Sr Recumbent

Serial Number: E \_\_\_\_\_

**To Activate Warranty:**

1. REGISTER YOUR WARRANTY AT [www.diamondbackfitness.com](http://www.diamondbackfitness.com) OR
2. COMPLETELY FILL OUT THE ATTACHED WARRANTY CARD (SEE BACK COVER) AND RETURN TO DIAMONDBACK WITHIN 15 DAYS OF THE DATE OF PURCHASE. FAILURE TO COMPLY WITH THE WARRANTY ACTIVATION PROCEDURE MAY VOID THE MANUFACTURER'S WARRANTY.

Serial Number Location

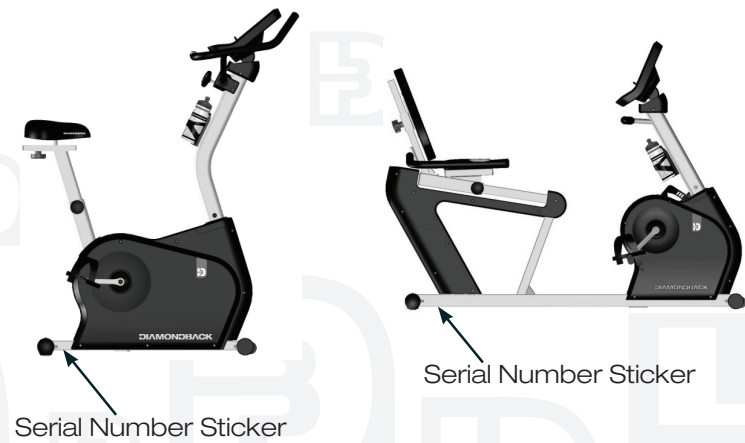

Dealer Name: \_\_\_\_\_

Dealer Address: \_\_\_\_\_

Dealer Telephone Number: (\_\_\_\_) \_\_\_\_\_

Dealer Contact Name: \_\_\_\_\_

Date Purchased: \_\_\_\_\_

**Shipping Materials:**

Diamondback recommends that you retain the original packing materials (box and packing items) for future shipping needs.

## Table of Contents

Purchaser's Reference Information .....	2
Introduction .....	4
Safety Instructions and Warnings .....	5
500Ub Upright Assembly Drawing .....	6
500Ub Upright Assembly Instructions .....	7
500Sr Recumbent Assembly Drawing .....	9
500Sr Recumbent Assembly Instructions.....	10
Workout Guidelines .....	12
Maximum Heart Rate & Training Zone.....	13
Quantity & Quality .....	13
Pulse Hand Grips .....	15
<b>Console</b>	
Glossary of Terms .....	15
Default Values .....	15
Operating Tips .....	15
Console Layout .....	17
Displays .....	18
Function Keys .....	19
Features .....	20
<b>Workout Programs</b>	
Warm Up .....	21
Cool Down .....	21
Workout Summary .....	22
Quick Start .....	23
<b>Classic Programs</b>	
Manual .....	24
Random .....	25
Interval .....	27
Hill Climb .....	28
Custom Trainer .....	30
<b>HR Interactive Program</b>	
Target HR .....	32
Maintenance .....	34
Domestic Warranty Information .....	35
Warranty Card .....	39

## Introduction

Congratulations on the purchase of your new cardio equipment from Diamondback. You have made a smart choice. You are about to experience one of the most effective and technically advanced methods of cardiovascular exercise available today.

Diamondback Fitness was founded as a brand extension of the legendary 30-year Diamondback bicycle division. The evolution of bicycles to home gyms for cross-training purposes and to stay fit in inclement weather was a natural. Diamondback Fitness, known for delivering feature-packed, high-value equipment, has grown to a full line of cardio equipment including treadmills, ellipticals and stepper, as well as bikes, including innovative step-thru recumbents.

You can count on your Diamondback equipment to provide years of pleasure and improvement in your fitness level. The solid construction and techno-savvy electronics are guaranteed to provide you with the ultimate workout experience.

For more information or questions regarding your equipment, please go to our website at [www.diamondbackfitness.com](http://www.diamondbackfitness.com). Or contact us:

Diamondback Fitness  
c/o Raleigh America, Inc.  
6004 S. 190th Street, Suite 101  
Kent, WA 98032  
Ph: 800.776.7642

## Safety Instructions and Warnings

The 500 model units are built for optimum safety and are designed to meet or exceed all domestic and international standards. However, certain precautions need to be followed when operating any exercise equipment. **BE SURE TO READ THE ENTIRE OWNER'S MANUAL BEFORE OPERATING YOUR 500 MODEL UNIT.**

### **CAUTION - FOR SAFE OPERATION**

1. Before beginning any exercise program on the 500 model unit it is important to consult with your physician if you have any of the following: History of heart disease, high blood pressure, diabetes, chronic respiratory diseases, elevated cholesterol, if you smoke cigarettes, experience any other chronic diseases, or physical complaints.
2. If over the age of 35 or overweight, consult with your physician before beginning any exercise program.
3. Pregnant women should consult with their physician before beginning an exercise program.
4. If you experience dizziness, nausea, chest pains or other abnormal symptoms during exercise, stop the exercise session immediately. Consult your physician before continuing your exercise.
5. Drink fluids if you exercise for twenty or more minutes on any 500 model unit.

### **WARNING - TO REDUCE RISK OF INJURY TO YOURSELF OR OTHERS**

1. To ensure proper functioning of your 500 model unit, do not install attachments or accessories not provided or recommended by Diamondback.
2. Always wear proper clothing and shoes when exercising on any 500 model unit.
3. User weight is not to exceed 275 pounds / 125 kilograms.
4. Keep children away from 500 model unit. Hands and feet may get caught in the pedals or other moving parts which could result in serious injury.
5. Place the 500 model unit in an area that will meet minimum clearance requirements: Front, Back & sides: 2 feet/60cm
6. Keep 500 model units away from walls to allow proper ventilation. Air should be able to circulate freely around the units. Keep all air openings free of dirt and dust. Never insert anything into openings.
7. The 500 model units are intended for indoor use in home environment. They are not intended for outdoor use.
8. Place your 500 model unit on a solid, level surface when in use.
9. Make sure all knobs for adjustments are fastened securely before getting on the unit and after making an adjustment (i.e. Seat post, saddle, seat assembly and handlebars).
10. Use the handlebars when getting on and off your 500 model unit.
11. Never operate the unit if it is damaged or broken. Contact your local authorized Diamondback Fitness dealer for service. Make sure all components are fastened securely (i.e. Seat post, saddle, seat assembly handlebars, and pedals) at all times.

## 500Ub Upright Assembly Drawing

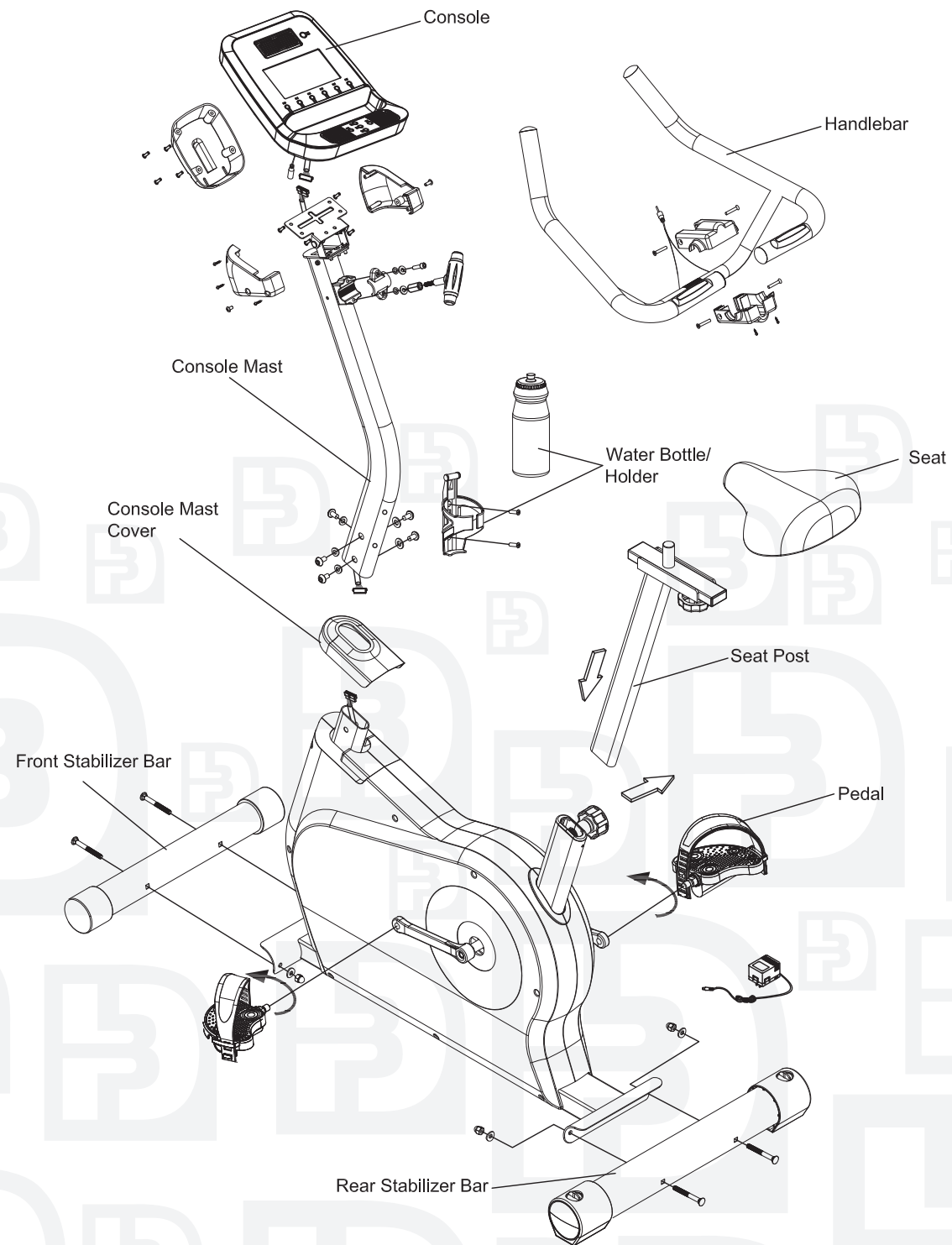

6

## 500Ub Upright Assembly Instructions

## Step 1: Stabilizer Bars Assembly

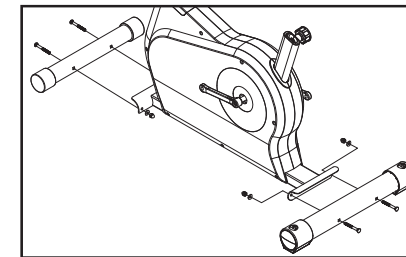

1. Place rear stabilizer bar under rear main frame body and align screw holes.
2. Insert two M8 x 75mm bolts into the stabilizer bar all the way through and into the holes on the frame
3. Secure rear stabilizer bar using an M8 nut and a curved washer on each bolt.
4. Repeat steps 1 - 3 to attach front stabilizer bar.

## Step 2: Pedal Assembly

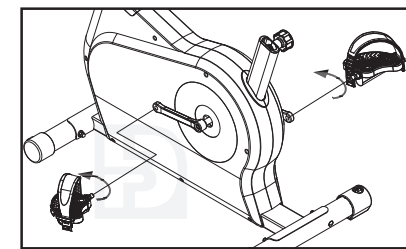

1. Use a 15mm open-end wrench to firmly affix the pedals to the cranks.
2. The left and right pedals are different and are denoted as right or left (R or L) on the top & bottom of each pedal.  
NOTE: Left pedal threads counterclockwise.
3. Retighten cranks after approximately 10 hours of use.

## Step 3: Seat Post and Saddle assembly

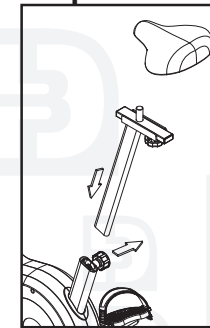

1. Loosen the seat pin by turning it counter-clockwise 1-2 turns. Install seat post by sliding it into seat post receptor, pulling the seat pin out until a suitable hole is found.
2. Assemble saddle onto seat post.
3. Tighten the affixing nut and washer using a 17mm open-end wrench.  
SADDLE ANGLE ADJUSTMENT HINT: Hold the rear of saddle in the optimum comfort position and tighten the nut at the same time

## Step 4: Console Mast Assembly

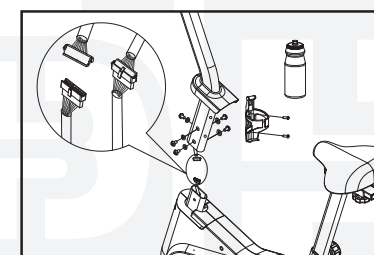

1. Remove console mast plastic cover from the unit's body by un-snapping it.
2. Install console mast plastic cover onto console mast.
3. Connect the main wire harness in the main frame to the main wire harness in the bottom of the console mast, taking care to install correctly. (See plug alignment marks)
4. Install the console mast by sliding it into the console mast receptor while gently pulling the wiring harness. This will keep the slack out of the harness so the wires will not get pinched and short out. Insert and tighten three M8 x 16mm bolts, one flat washer on each side and a curve washer on the front using a 6mm Allen wrench. Be sure not to pinch wire harness while tightening these three screws and make sure that the two top holes are light up with the holes on the receptor.
5. Snap console mast plastic cover into top of sidecase.
6. Insert and tighten two M8 x 16mm bolts and flat washers onto the two holes above the console mast

7

## 500Ub Upright Assembly Instructions (Continued)

cover using a 6mm Allen wrench.

- Place the bottle holder on the console mast. Insert and tighten the two M5 x 12mm screws using a Phillips screwdriver.
- Snap the water bottle into the bottle holder.

### Step 5: Handlebar Assembly

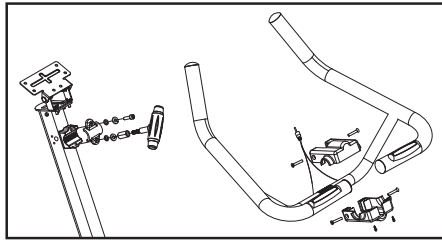

- Insert the hand pulse harness through the opening on the left side of the console mast and out the top of the console mast.
- Set the handlebar in place and secure it using a clamp, an M7 x P1.0 x 30mm bolt with a spring washer and flat washer on top hole of the clamp and a T-shape Knob with a bushing, a flat washer and spring washer on bottom hole of the clamp. As the bolt and T-shape knob are tightened leave the same gap on top and bottom.
- Install the handlebar top and bottom covers by attaching them to each other from the opening in the bottom of the bottom cover using two M3 x 14mm Screws and one M5 x 25mm on each side of each cover.

### Step 6: Console Assembly

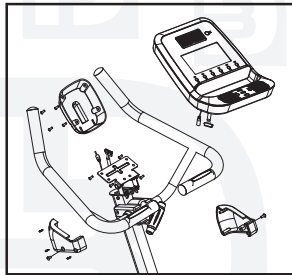

- Insert the ends of the main wiring harness and hand pulse wiring harness, through the opening of the rear console cover.
- Connect both plugs, from the main wiring harness and hand pulse wiring harness, to the plug receptors on the backside of the console taking care to install correctly (see plug alignment marks).  
WIRING HARNESS INSTALLATION HINT: Any excess wiring must be carefully inserted ("stored") back into the console mast before installing the console onto the console mounting plate.
- Attach the console to the console mounting plate with the four M5 x 10mm screws on the top and bottom holes of the mounting plate using a Phillips screwdriver.
- Attach the rear console cover to the back of the console using four M5 x 10mm screws using a Phillips screwdriver.
- Attach the right console plastic mount hood to console mast using one M5 x 14mm bolt and Phillips screwdriver. The cover should sit above the plastic handlebar covers and below the mounting bracket for the console.
- Attach the left console plastic mount hood to console mast using one M5 x 14mm bolt then to the right cover using three M3 x 14mm screws and a Phillips screwdriver.

### Step 7: Transformer Assembly

- Plug transformer into plug receptor located on the rear of the unit
  - Plug the transformer into power outlet.
- NOTE: Be sure to use the right transformer for your power outlet, 110V or 220V.

## 500Sr Recumbent Assembly Drawing

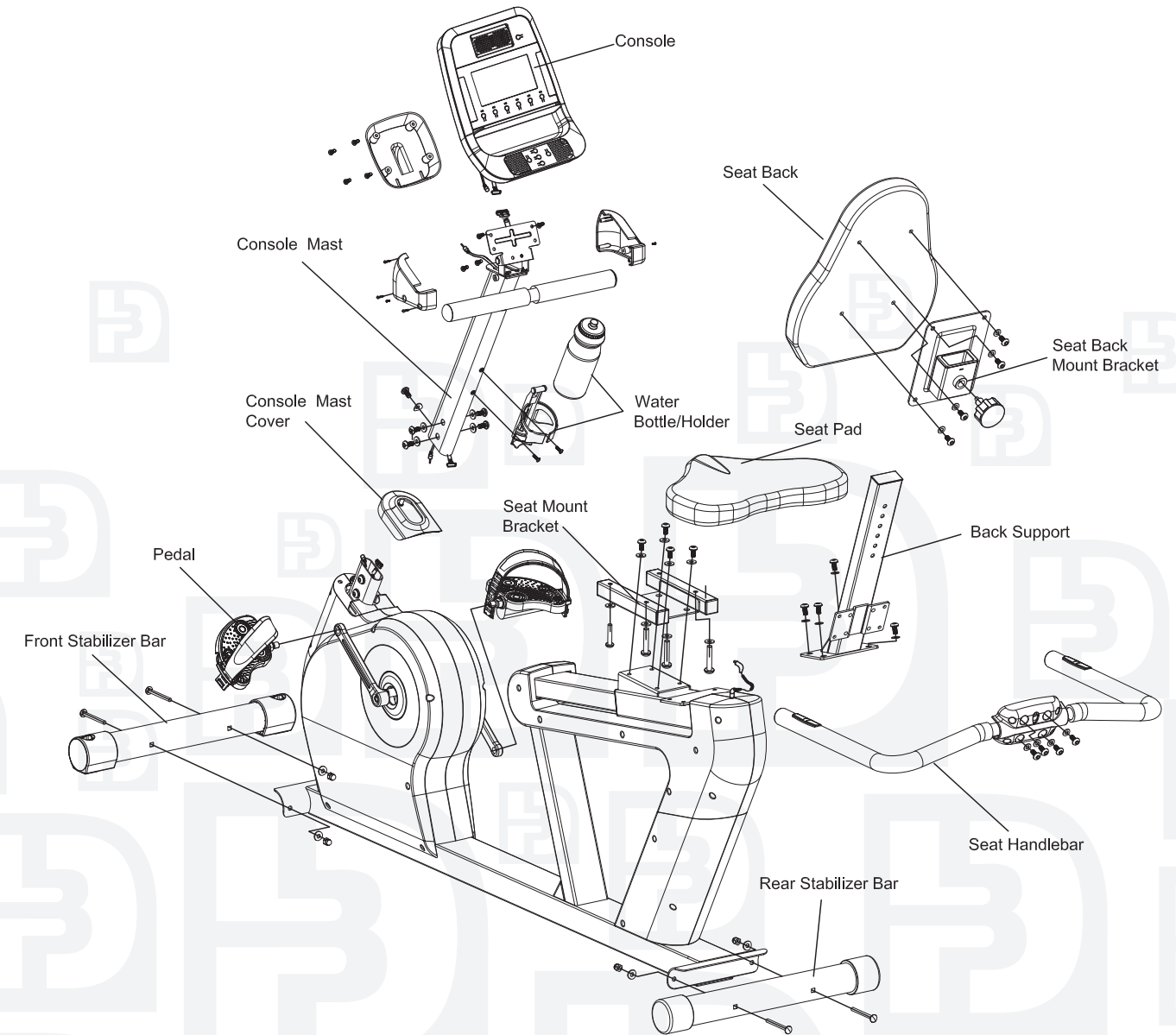

## 500Sr Recumbent Assembly Instructions

### Step 1: Stabilizer Bars

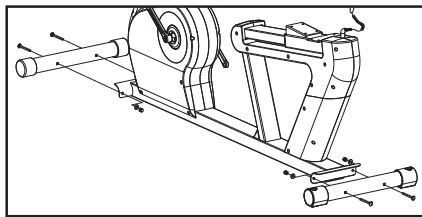

1. Place rear stabilizer bar under rear main frame body and align screw holes.
2. Insert two M8 x 75mm bolts into the stabilizer bar all the way through and into the holes on the frame
3. Secure the stabilizer bar using an M8 nut and a curved washer on each bolt.
4. Repeat steps 1 – 3 to attach front stabilizer.

### Step 2: Seat Assembly

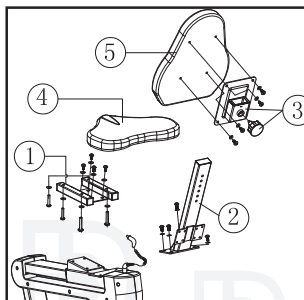

1. Install seat mount bracket to seat slide on the seat track using four M8 x 16mm bolts and four washers.
2. Install seat support to seat slide on the seat track using four M8 x 16mm bolts and four washers.
3. Loosen the seat back locking pin by turning it counter-clockwise 1-2 turns. Install the seat back mount bracket by sliding it onto the back support tube, pulling the seat pin out until a suitable hole is found.
4. Install the seat pad on seat mount bracket using four M8 x 45mm bolts and four washers
5. Install the seat back pad on seat back mount bracket using four M8 x 16mm bolts and washers.

### Step 3: Rear Handle Bar

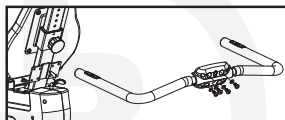

1. Install rear handle bar to the bracket on the rear of the back support tube using four M8 x 16mm and four flat washers
2. Plug in the HR pulse harness coming out of the plastic body to the receptor on the back of the handle bar.

### Step 4: Pedals Assembly

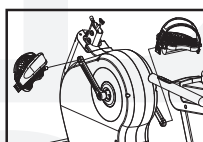

1. Use a 15mm open-end wrench to firmly affix the pedals to the cranks.
2. The left and right pedals are different and are denoted as right or left (R or L) on the top & bottom of each pedal.  
NOTE: Left pedal threads counterclockwise.
3. Retighten cranks after approximately 10 hours of use.

### Step 5: Console Mast & Water Bottle Assembly

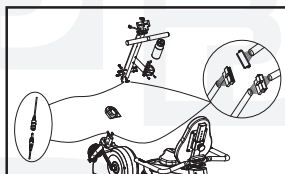

1. Remove console mast plastic cover from the unit's body by un-snapping it.
2. Slide console mast cover onto bottom of console mast
3. Connect both the main wire harness and the hand pulse harness in the main frame to the two wire harnesses in the bottom of the console mast, taking care to install correctly. (See plug alignment marks)
4. Install the console mast by sliding it into the console mast receptor while gently pulling the wiring harness. This will keep the slack out of the harness so the wires will not get pinched and short out. Insert and tighten three M8 x 16mm bolts, one flat washer on each side and a curve washer on the front using a 6mm Allen wrench. Be sure not to pinch wire harness while tightening these

## 500Sr Recumbent Assembly Instructions (Continued)

- three screws and make sure that the two top holes are light up with the holes on the receptor.
4. Snap console mast cover into top of sidecase.
5. Insert and tighten two M8 x 16mm bolts and flat washers onto the two holes above the console mast cover using a 6mm Allen wrench.
6. Place the bottle holder on the console mast. Insert and tighten two M5 x 15mm screws using a Phillips screwdriver.
7. Snap the water bottle into the bottle holder.

### Step 6: Console Assembly

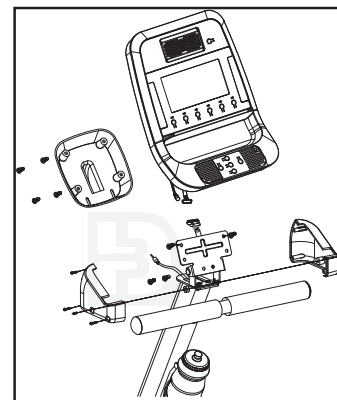

1. Insert the ends of the main wiring harness and hand pulse wiring harness, through the opening of the rear console cover.
2. Connect both plugs, from the main wiring harness and hand pulse wiring harness, to the plug receptors on the backside of the console taking care to install correctly (see plug alignment marks).  
WIRING HARNESS INSTALLATION HINT: Any excess wiring must be carefully inserted ("stored") back into the console mast before installing the console onto the console mounting plate.
3. Attach the console to the console mounting plate with the four M5 x 10mm screws on the top and bottom holes of the mounting plate using a Phillips screwdriver.
4. Attach the rear console cover to the back of the console using four M5 x 10mm screws using a Phillips screwdriver.
5. Attach the right console plastic mount hood to console mast using one M5 x 14mm bolt and Phillips screwdriver. The cover should sit above the plastic handlebar cover and below the mounting bracket for the console.
6. Attach the left console plastic mount hood to console mast using one M5 x 14mm bolt then to the right cover using three M3 x 14mm screws and a Phillips screwdriver.

### Step 7: Transformer Assembly

1. Plug transformer into plug receptor located on the front of the unit.
2. Plug the transformer into power outlet.  
NOTE: Be sure to use the right transformer for your power outlet, 110V or 220V.

## Workout Guidelines

### Good health is an exercise in common sense

The Surgeon General released a study in 2001, The Surgeon General's Call To Action To Prevent and Decrease Overweight and Obesity. It indicates that 61% of American adults are either overweight or obese. The study states that overweight increases the risk of health problems, such as heart disease, certain type of cancer, type 2 diabetes, etc. It further points out that overweight needs to be regarded primarily as a Health rather than as an Appearance issue.

The Surgeon General's Healthy weight advice for consumers is:

1. Aim for a healthy weight: Find your Body Mass Index (BMI) on the chart below.
2. Be active: Keep physically active to balance the calories you consume.
3. Eat well: Select sensible portion sizes.

$$\text{BMI} = (\text{weight (lb.)} / \text{height}^2 \text{ (in)}) \times 703$$

Height in Feet and Inches	Weight in Pounds													
	120	130	140	150	160	170	180	190	200	210	220	230	240	250
4'6	29	31	34	36	39	41	43	46	48	51	53	56	58	60
4'8	27	29	31	34	36	38	40	43	45	47	49	52	54	56
4'10	25	27	29	31	34	36	38	40	42	44	46	48	50	52
5'0	23	25	27	29	31	33	35	37	39	41	43	45	47	49
5'2	22	24	26	27	29	31	33	35	37	38	40	42	44	46
5'4	21	22	24	26	28	29	31	33	34	36	38	40	41	43
5'6	19	21	23	24	26	27	29	31	32	34	36	37	39	40
5'8	18	20	21	23	24	26	27	29	30	32	34	35	37	38
5'10	17	19	20	22	23	24	26	27	29	30	32	33	35	36
6'0	16	18	19	20	22	23	24	26	27	28	30	31	33	34
6'2	15	17	18	19	21	22	23	24	26	27	28	30	31	32
6'4	15	16	17	18	20	21	22	23	24	26	27	28	29	30
6'6	14	15	16	17	19	20	21	22	23	24	25	27	28	29
6'8	13	14	15	17	18	19	20	21	22	23	24	25	26	28

Healthy Weight    Overweight    Obese

Note: This chart is for adults (aged 20 years and older).

### Heart rate is an important key to your exercise.

The Surgeon General also released a report on physical activity and health. This report definitively stated that exercise and fitness are beneficial for a person's health and redefined that exercise is a key component of disease prevention and healthier living.

Medical research has shown us that there is an amount of exercise which is enough to condition the cardio respiratory system and the muscles of the body. This amount of exercise is between 60% and 85% of your maximum heart rate measured during a training session. This range allows enough exercise to achieve fitness, but not an excessive amount to cause injury. Your heart rate is an excellent indicator of the amount of stress placed on the cardiovascular system. Taking full advantage of this informa

## Workout Guidelines (Continued)

tion, the 500 model units are designed to include heart rate monitoring features.

If exercise intensity is too low or too high, no gains will be made in fitness. If the intensity is too low, the stress levels are ineffective. If the intensity is too high, injury or fatigue may set your exercise program back as you try to recover.

The best way to monitor exercise intensity is to accurately count your pulse during exercise. Your heart rate can easily be determined by counting your pulse at the chest, wrist or at the carotid artery on your neck. It is difficult to count your own pulse during exercise, mainly because you cannot count fast enough to get an accurate number. Heart rate is monitored and electronically displayed as a digital readout. Your target heart rate, the intensity needed to improve cardiovascular fitness, depends primarily on your age and not your state of fitness. It is calculated as a percentage of your maximum heart rate, estimated as 220 minus your age. It is most effective to train at your target heart rate between 60% and 85% of your maximum heart rate.

### Maximum Heart Rate & Training Zone

To calculate your maximum heart rate and find your training zone, use the following formula. An example has been provided below based on a 35-year-old person:

220 - Age = Maximum Heart Rate      (220 - 35 = 185)  
 60% of Maximum Heart Rate      (60% x 185 = 111bpm)  
 85% of Maximum Heart Rate      (85% x 185 = 157bpm)  
 Training Zone:      111bpm - 157bpm

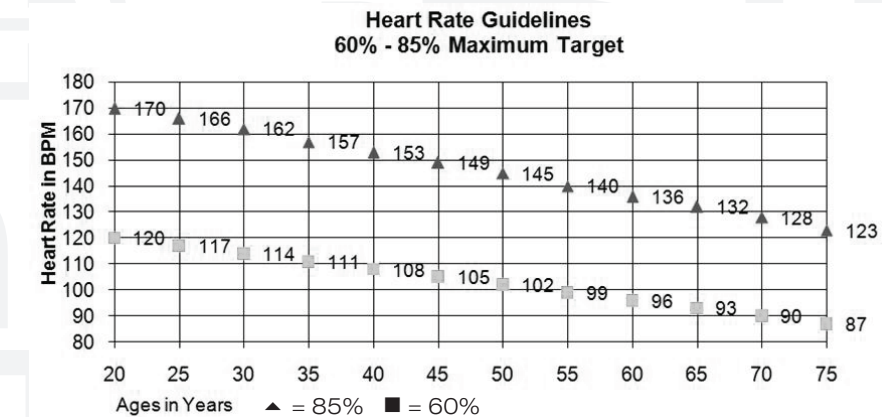

### Quantity & Quality

It is recommended that you accumulate at least 30 minutes of physical activity most days of the week. Physical activity should be initiated slowly and the intensity should be increased gradually. You should select activities that you enjoy and can fit into your daily life. Having Diamondback equipment at home certainly gives you the comfortable and convenient workout you want.

The American College of Sports Medicine makes the following recommendations for the quantity and

## Workout Guidelines (Continued)

quality of training for developing and maintaining cardio respiratory fitness in healthy adults:

- An activity that uses large muscle groups, maintained continuously, and is rhythmical and aerobic in nature.
- Duration: 20 to 60 minutes of continuous aerobic activity, including a warm-up and cool-down period for each exercise session.
- Frequency: 3 to 5 times per week.
- Intensity: 60% to 85% of maximum heart rate.
- In addition to aerobic exercise, it is recommended that you add strength training of moderate intensity twice per week to your program.

### Typical Target Zone Exercise Patterns for 35 year-old

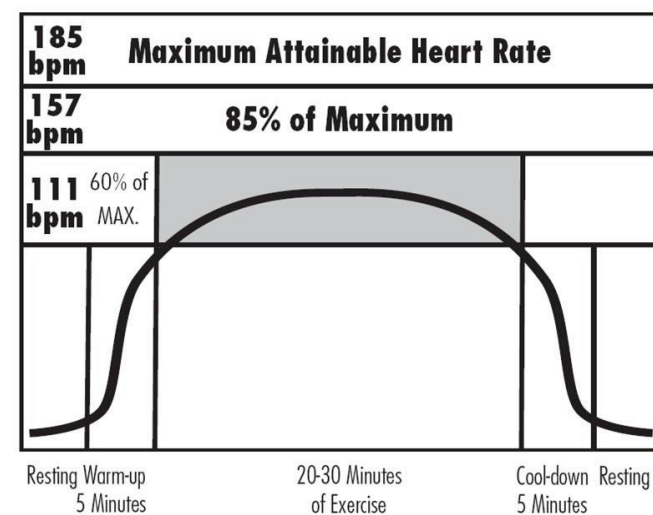

#### Get a smart start on exercising.

Anyone over the age of 35, as well as younger persons whom are overweight, should check with his/her physician before beginning any type of exercise program. People who have diabetes or high blood pressure, a family history of heart disease, high cholesterol or have lead a sedentary lifestyle should protect themselves with a medical check-up and a stress test, preferably administered during exercise by a healthcare professional.

1. Always stretch before your workout to loosen muscles, and afterwards to Cool Down.
2. The first few minutes of your workout should be devoted to warming up muscles before a vigorous workout, and building your heart rate slowly.
3. After your aerobic workout of about 24-32 minutes, spend 10 minutes gradually reducing your heart rate with a lower resistance level.

*Remember, to start slow, with intensity low, until you build endurance and strength. And always consult your physician before beginning any exercise program.*

## Console

### Pulse Hand Grips (Standard)

The 500 Model units are heart rate controlled and come standard with stainless steel pulse hand grips. To activate, gently grasp both hand grips to obtain a heart rate reading.

#### Operating Tips:

If you are not getting a consistent reading while using the hand pulse option, we recommend the following suggestions:

- Make sure that the palms of the hands are touching the contact area of each hand pulse grip.
- Maintain an even pressure on the grips.
- Do not hold the hand pulse grips too tightly.

## Console

### Glossary of Terms

- Idle mode = Console is reset and waiting for an entry. The dot matrix displays "DB". If there is no RPM for 5 minutes, the console will power down.
- LED = the lights on the face of the console.
- Watts = the rate of energy currently being expended.
- Work = the amount of energy expended during exercise.
- Intensity level = the resistance provided by the unit. The resistance gradually increases as the level goes up.

### Default Values

- Age = 35 years
- Weight = 155 lb. or 70kg for Metric system
- Time = 30 minutes; Segment time = 30/14 minutes.
- Intensity level: Level 1.

Note: The default values for Age, Weight and Time will update each time they are changed in the program settings.

### Operating Tips

- **Power On and Off:** When the AC Adapter is plugged into the unit, it automatically turns on. In the power save mode, press any key or start pedaling to wake up the console and start operation.
- **Reset:** To reset a program during its operation, press and hold the "Stop" key for 2 seconds. When the program resets, the console returns to idle mode.
- **Pause and Resume:** You may interrupt or pause a program for up to 5 minutes during a workout before the console resets. To pause a program, simply stop pedaling. To resume the program back to the point of where you left off, simply start pedaling.
- **Re-start a program:** The user may re-start a program after the program ends. Simply press "Start" key during Cool Down or Workout Summary mode. The program will be started immediately without Warm up. The program default will remain the same as previous program; the calories and distance will continue accumulating.

## Console (Continued)

- **Intensity adjustment:** During a program, the user may press the UP or DOWN key to adjust the resistance level. (Note: Resistance adjustments are not allowed in any Heart rate interactive program).
- **% MAX HR:** Age / (220 minus age).
- It is recommended to control your % Max heart rate within 60% – 85% for the most effective workout. It is also unsafe to exceed 90% and above. This elliptical is equipped with a safety warning message.
  - \* If your heart rate reaches 95% of max or goes over, the pulse display will blink 3 times and the console will beep twice.
  - \* If your heart rate stays at or over 95% of max it will repeat the warning every 3 minutes.
- **English/Metric Unit Setting:** The default Unit setting is the English system. To enter the system switching mode, press and hold the “START” and “ENTER” keys for 2 seconds, during Idle mode. The dot matrix display will show “EN” for English units or “ME” for Metric units. To change the setting, press the “UP” or “DOWN” key. After choosing the desired units press the “ENTER” key to return to Idle mode.

## Console Layout





## Displays

### A. Time Display



Time (hr:min or min:sec): This display, located on the top left hand corner of the display will show the time remaining in the current program. When the “Warm Up” or “Cool Down” message is displayed, this time refers to the time left in that section of the program

During the program setup this display will light up and the numbers will be blinking when the time entry is requested.

### B. Pulse/Age/Weight Display



Pulse (bpm): This display, located on the upper right hand corner will show your current heart rate in beats per minute. If there is no pulse detected, it will display “- - -” instead.

During the program setup this display will light up the message “ENTER AGE” or “ENTER WEIGHT” and the numbers will be blinking when these values are requested.

### C. Data Display



As soon as a program is started it will start accumulating Calories and Distance. It will also display current Speed, Resistance Level, RPMs and Watts.

### D. Dot Matrix Display

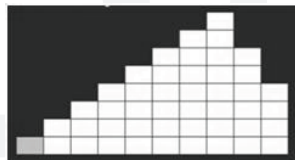

It displays the program profile during the program setup and executing modes.

- Display the Intensity profile
- Display the % Max HR profile during the HR interactive program

Profile definitions:

Intensity profile – Each horizontal row represents 2 levels of resistance from L1-L16; the higher the horizontal rows lit up, the higher the resistance.

- % Max HR profile – Each horizontal row represents % Max HR: 0-100%
- Each vertical column represents a time interval determined by the length of the program. A column will blink during the program to indicate the current workout segment.

## Function Keys

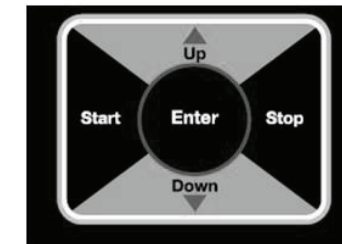

### Up/Down Keys

- During program setup, press “Up or Down key” to adjust the following – age, weight, & time
- After program is started, press “Up or Down key” to adjust the intensity level or HR setting.

### Enter Key

- After selecting a program, press “Enter” to accept the program and enter its setup mode.
- Adjusting age, weight... press “Enter” key to accept your entry.

### Start Key

- Press “Start” to start a program during program setup.
- Press “Start” to end Warm up and start program immediately.
- Press “Start” to re-start a program during Cool Down or Workout summary.

### Stop Key

- Press and hold “Stop” key for 2 seconds to reset the console.
- Press “Stop” to end program and enter Cool Down.
- Press “Stop” to enter workout summary during Cool Down.
- Press “Stop” to reset the console during workout summary.

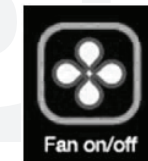

### Smart Fan™

The Console features a Smart Fan™ that can be adjusted to direct airflow. Turn the fan on or off by pressing the FAN ON/OFF key.

- Pressing the key once will turn the fan on in smart mode, in this mode the fan will adjust the air flow according to the speed the unit is being pedaled.
- Pressing the key a second time will turn the fan on to low speed
- Pressing the key a third time will turn the fan on to medium speed
- Pressing the key a fourth time will turn the fan on to high speed
- Pressing the key a fifth time will turn the fan off

## Audio

### **Audio Input Jack & Speakers**

The Console features a standard Audio Input Jack and Speakers. Using a two 3.5mm male plug adapter cable connect your audio device to the console. The volume for the speakers is fixed; control the volume of your music using your audio device.

## Workout Programs

### **Warm Up**

#### **Getting Started**

Your unit will automatically initiate a Warm Up mode for 3 minutes at the beginning of each program. This mode is design to prepare your body for an intensive workout and to reduce the possibility of injury during workout.

*Note: Warm Up is skipped for the Quick Start program.*

#### **Beginning the Program**

Warm Up is active as soon as a "Start" key is pressed and a program is executed. The message "WARM UP" will illuminate above the Dot Matrix and this mode will be started.

#### **During the Program**

##### **Display**

- Once it is started, the time display will start counting down from 3:00.
- The Pulse display will show a pulse if a heart rate signal is being detected
- The data display will start accumulating Calories and Distance. It will also display Speed, Resistance Level, RPMs and Watts.

##### **Adjustment**

- Intensity level = L1. Press "Level Up/Down" key to adjust the intensity level from L1- L5 only.
- "Start" key could be pressed to skip the warm up and execute the program immediately.

##### **Ending the Program**

- When 3-minutes are up or Start key is pressed, Warm Up will end and the program will execute.
- The calories and distance will be carried over into the program-executing mode.

##### **Pause, Reset a program**

See Console Operating Tips section for details, page 15

### **Cool Down**

#### **Getting Started**

Your unit is equipped with Cool Down at the end of each program. The time for Cool Down is 3 minutes. It starts as soon as a program ends. Cool Down is designed to reduce muscle stiffness and allow your heart rate to recover.

#### **Beginning the Program**

Cool Down is active as soon as a program ends or Stop key is pressed during program executing. The message "COOL DOWN" will illuminate above the Dot Matrix and this mode will be started.

## Workout Programs (Continued)

### During the Program

#### Display

- Once it is started, the time display will start counting down from 3:00.
- The Pulse display will show a pulse if a heart rate signal is being detected
- The data display continues accumulating Calories and Distance. It will also display Speed, Resistance Level, RPMs and Watts.

#### Adjustment

- Intensity level = L1. Press "Level Up/Down" key to adjust the intensity level from L1- L5 only.
- "Start" key could be pressed to re-start the previous program again.
- "Stop" key could be pressed to skip the Cool Down mode and active the Workout Summary immediately.

### Ending the Program

- When 3-minutes are up or Stop key is pressed, Cool Down will end and enter Workout Summary.

#### Pause & Reset a program

See Console Operating Tips section for details, page 15

### Workout Summary

#### Getting Started

For your convenience, your unit incorporates a Workout Summary right after the completion of the Cool Down. It will display the total workout data for your review for 1 minute before the Console resets.

#### Beginning the Program

Workout Summary appears as soon as the Cool Down mode ends or a "Stop" key is pressed during Cool Down mode.

### During the Program

#### Display

- The time display will display the total workout time
- The Pulse display will display the average pulse during the workout if a pulse signal was detected.
- The data display will display the total burned Calories, average speed, total distance traveled, average RPM and average watts during the workout.

#### Adjustment

The resistance cannot be adjusted during this time.

## Workout Programs (Continued)

### Ending the Program

When 1-minute duration is up or Stop key is pressed, Workout Summary will end and console will reset.

#### Pause & Reset a program

See Console Operating Tips section for details, page 15

### Quick Start

#### Getting Started

A Quick Start program is for someone who wants to bypass the setup mode and start their workouts right away. By picking Quick Start program, you are accepting the default values for calculations. The Warm Up mode is skipped at Quick Start program.

### Beginning the Program

During Idle mode, the Dot Matrix display will display "DB" and the program LED indicator will be lighting up one at the time. To begin this program, press "START" key once.

#### Program Default Values

- Time = 30 minutes
- Intensity level = L1

Note: the default age and weight will be what was entered and saved in a previous workout

### During the Program

#### Display

- The Time display will start counting down from 30:00.
- The Pulse display will show a pulse if a heart rate signal is being detected
- The data display will start accumulating Calories and Distance. It will also display Speed, Resistance Level, RPMs and Watts.

#### Adjustment

- Intensity level = L1. Press "Level Up/Down" key to adjust the intensity level from L1- L16. The level data display and the dot matrix window will update to show the level setting

### Ending the Program

- When 30-minute duration is up or Stop key is pressed, this program will end and Workout Summary will be active.
- "Start" key could be pressed to re-start the Quick Start program.
- "Stop" key could be pressed to reset the console.

#### Pause & Reset a program

See Console Operating Tips section for details, page 15

## Workout Programs (Continued)

### Classic Programs

#### Manual

##### Getting Started



The Manual program has no profile built into it. This allows you to build your own exercise profile while you workout.

##### Beginning the Program

During Idle mode, the Dot Matrix display will display "DB" and the program LED indicator will be lighting up one at the time. To begin this program, press the **"MANUAL"** program key, the LED indicator above it will light up.

##### Entering the program

When the "Manual" LED indicator is lit, it indicates you are about to select the Manual program.

Press the **"ENTER"** key to enter program setup mode. Messages will light up in the main display to guide you through the program setup mode step by step:

##### Enter Age:

1. The message **"Enter Age"** will show up in the Pulse display and the numbers will be blinking
2. You may press **UP** or **DOWN** keys to adjust the age.
3. After age adjustment, press **"ENTER"** key to accept and enter Weight adjustment. The age will be saved in the console as the new default age.

##### Enter Weight:

1. The message **"Enter Weight"** will show up in the Pulse display and the numbers will be blinking
2. You may press **UP** or **DOWN** keys to adjust the weight
3. After weight adjustment, press **"ENTER"** key to accept and enter Time adjustment. The weight will be saved in the console as the new default weight.

##### Enter your workout time:

1. The message "Time" will show up in the Time display and the numbers will be blinking
2. You may press UP or DOWN keys to adjust the time
3. After Time adjustment, press "ENTER" key to accept and begin the program.

Or press the **"START"** key to accept the default values and begin the program

- Default Age and Weight = the values previously saved in the console.
- Default time = 30Min

##### During the Program

Once the Enter key after adjusting the time is pressed or Start key is pressed, the Warm Up will be active. See Warm Up mode section for details.

## Workout Programs (Continued)

### Displays

- Once it is started, the Time display will start counting down from the entered workout time.
- The Pulse display will show a pulse if a heart rate signal is being detected
- The data display will start accumulating Calories and Distance. It will also display Speed, Resistance Level, RPMs and Watts.

### Adjustment

- Press "Level Up/Down" key to adjust the intensity level from L1 to L16. The Data display window and Dot matrix window will update the intensity accordingly.

### Ending the Program

- When program time is up or STOP key is pressed, this program will end and Cool Down will be active. See Cool Down section for details.
- "START" key could be pressed to re-start the Manual program again.
- "STOP" key could be pressed to skip the Cool Down and activate the Workout Summary immediately.

### Pause and Reset

See Console Operating Tips section for details, page 15

### Random

#### Getting Started



The Random program is designed to allow the user to choose from an unlimited number of computer generated profiles at random.

##### Beginning the Program

During Idle mode, the Dot Matrix display will display "DB" and the program LED indicator will be lighting up one at the time. To begin this program, press the **"RANDOM"** program key, the LED indicator above it will light up.

##### Entering the program

When the "RANDOM" LED indicator is lit, it indicates you are about to select the Random program.

Press the **"ENTER"** key to enter program setup mode. Messages will light up in the main display to guide you through the program setup mode step by step:

##### Enter Age:

1. The message "Enter Age" will show up in the Pulse display and the numbers will be blinking
2. You may press UP or DOWN keys to adjust the age.
3. After age adjustment, press "ENTER" key to accept and enter Weight adjustment. The age will be saved in the console as the new default age.

## Workout Programs (Continued)

### Enter Weight:

1. The message "Enter Weight" will show up in the Pulse display and the numbers will be blinking
2. You may press UP or DOWN keys to adjust the weight
3. After weight adjustment, press "ENTER" key to accept and enter Time adjustment. The weight will be saved in the console as the new default weight.

### Enter your workout time:

1. The message "Time" will show up in the Time display and the numbers will be blinking
2. You may press UP or DOWN keys to adjust the time
3. After Time adjustment, press "ENTER" key to accept and begin the program. (Note: you may press Start key anytime to skip the setup and begin the workout immediately.)

Or press the **"START"** key to accept the default values and begin the program

- Default Age and Weight = the values previously saved in the console.
- Default time = 30Min

### During the Program

Once the Enter key after adjusting the time is pressed or Start key is pressed, the Warm Up will be active. See Warm Up mode section for details.

### Displays

- Once it is started, the Time display will start counting down from the entered workout time.
- The Pulse display will show a pulse if a heart rate signal is being detected
- The data display will start accumulating Calories and Distance. It will also display Speed, Resistance Level, RPMs and Watts.

### Adjustment

- Press "Level Up/Down" key to adjust the intensity level from L1 to L16. The Data display window and Dot matrix window will update the intensity accordingly.

### Ending the Program

- When program time is up or STOP key is pressed, this program will end and Cool Down will be active. See Cool Down section for details.
- "START" key could be pressed to re-start the Random program again.
- "STOP" key could be pressed to skip the Cool Down and activate the Workout Summary immediately.

### Pause and Reset

See Console Operating Tips section for details, page 15

## Workout Programs (Continued)

### Interval

#### Getting Started



The Interval Trainer program helps to build the strength of your cardiovascular system. By alternating the workload from high to low, your heart gets an effective workout.

#### Beginning the Program

During Idle mode, the Dot Matrix display will display "DB" and the program LED indicator will be lighting up one at the time. To begin this program, press the **"INTERVALS"** program key, the LED indicator above it will light up.

#### Entering the program

When the "INTERVALS" LED indicator is lit, it indicates you are about to select the Interval program.

Press the **"ENTER"** key to enter program setup mode. Messages will light up in the main display to guide you through the program setup mode step by step:

#### Enter Age:

1. The message "Enter Age" will show up in the Pulse display and the numbers will be blinking
2. You may press UP or DOWN keys to adjust the age.
3. After age adjustment, press "ENTER" key to accept and enter Weight adjustment. The age will be saved in the console as the new default age.

#### Enter Weight:

1. The message "Enter Weight" will show up in the Pulse display and the numbers will be blinking
2. You may press UP or DOWN keys to adjust the weight
3. After weight adjustment, press "ENTER" key to accept and enter Time adjustment. The weight will be saved in the console as the new default weight.

#### Enter your workout time:

1. The message "Time" will show up in the Time display and the numbers will be blinking
2. You may press UP or DOWN keys to adjust the time
3. After Time adjustment, press "ENTER" key to accept and begin the program. (Note: you may press Start key anytime to skip the setup and begin the workout immediately.)

Or press the **"START"** to accept the default values and begin the program

- Default Age and Weight = the values previously saved in the console.
- Default time = 30Min

#### During the Program

Once the Enter key after adjusting the time is pressed or Start key is pressed, the Warm Up will be active. See Warm Up mode section for details.

## Workout Programs (Continued)

### Displays

- Once it is started, the Time display will start counting down from the entered workout time.
- The Pulse display will show a pulse if a heart rate signal is being detected
- The data display will start accumulating Calories and Distance. It will also display Speed, Resistance Level, RPMs and Watts.

### Adjustment

- Press “Level Up/Down” key to adjust the intensity level from L1 to L16. The Data display window and Dot matrix window will update the intensity accordingly.

### Ending the Program

- When program time is up or STOP key is pressed, this program will end and Cool Down will be active. See Cool Down section for details.
- “START” key could be pressed to re-start the Random program again.
- “STOP” key could be pressed to skip the Cool Down and activate the Workout Summary immediately.

### Pause and Reset

See Console Operating Tips section for details, page 15

## Hill Climb

### Getting Started



The Hill program simulates a hill climbing exercise with a preset hill profile. The exercise profile will guide you up a hill and down the other side.

### Beginning the Program

During Idle mode, the Dot Matrix display will display “DB” and the program LED indicator will be lighting up one at the time. To begin this program, press the “**HILL CLIMB**” program key, the LED indicator above it will light up.

### Entering the program

When the “HILL CLIMB” LED indicator is lit, it indicates you are about to select the Random program.

Press the “**ENTER**” key to enter program setup mode. Messages will light up in the main display to guide you through the program setup mode step by step:

#### Enter Age:

1. The message “Enter Age” will show up in the Pulse display and the numbers will be blinking
2. You may press UP or DOWN keys to adjust the age.
3. After age adjustment, press “ENTER” key to accept and enter Weight adjustment. The age will be saved in the console as the new default age.

## Workout Programs (Continued)

### Enter Weight:

1. The message “Enter Weight” will show up in the Pulse display and the numbers will be blinking
2. You may press UP or DOWN keys to adjust the time
3. After weight adjustment, press “ENTER” key to accept and enter Time adjustment. The weight will be saved in the console as the new default weight.

### Enter your workout time:

1. The message “Time” will show up in the Time display and the numbers will be blinking
2. You may press UP or DOWN keys to adjust the weight
3. After Time adjustment, press “ENTER” key to accept and begin the program. (Note: you may press Start key anytime to skip the setup and begin the workout immediately.)

Or press the “**START**” to accept the default values and begin the program

- Default Age and Weight = the values previously saved in the console.
- Default time = 30Min

### During the Program

Once the Enter key after adjusting the time is pressed or Start key is pressed, the Warm Up will be active. See Warm Up mode section for details.

### Displays

- Once it is started, the Time display will start counting down from the entered workout time.
- The Pulse display will show a pulse if a heart rate signal is being detected
- The data display will start accumulating Calories and Distance. It will also display Speed, Resistance Level, RPMs and Watts.

### Adjustment

- Press “Level Up/Down” key to adjust the intensity level from L1 to L16. The Data display window and Dot matrix window will update the intensity accordingly.

### Ending the Program

- When program time is up or STOP key is pressed, this program will end and Cool Down will be active. See Cool Down section for details.
- “START” key could be pressed to re-start the Random program again.
- “STOP” key could be pressed to skip the Cool Down and activate the Workout Summary immediately.

### Pause and Reset

See Console Operating Tips section for details, page 15

## Workout Programs (Continued)

### Custom Trainer

#### Getting Started

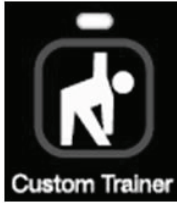

The program is designed to allow you to customize your workout. It includes a preset intensity profile that can be modified as needed. The changes to each segment can be saved for future use.

#### Beginning the Program

During Idle mode, the Dot Matrix display will display "DB" and the program LED indicator will be lighting up one at the time. To begin this program, press the **"CUSTOM TRAINER"** program key, the LED indicator above it will light up.

#### Entering the program

When the "CUSTOM TRAINER" LED indicator is lit, it indicates you are about to select the Custom Trainer program.

Press the **"ENTER"** key to enter program setup mode. Messages will light up in the main display to guide you through the program setup mode setup step by step:

##### Enter Age:

1. The message "Enter Age" will show up in the Pulse display and the numbers will be blinking
2. You may press UP or DOWN keys to adjust the age.
3. After age adjustment, press "ENTER" key to accept and enter Weight adjustment. The age will be saved in the console as the new default age.

##### Enter Weight:

1. The message "Enter Weight" will show up in the Pulse display and the numbers will be blinking
2. You may press UP or DOWN keys to adjust the weight
3. After weight adjustment, press "ENTER" key to accept and enter Time adjustment. The weight will be saved in the console as the new default weight.

##### Enter your workout time:

1. The message "Time" will show up in the Time display and the numbers will be blinking
2. You may press UP or DOWN keys to adjust the time
3. After Time adjustment, press "ENTER" key to accept and begin modifying the program's profile. (Note: you may press Start key anytime to skip the setup and begin the workout immediately.)

##### Modify Profile:

1. The first segment of the display will start blinking
2. You may press UP or DOWN keys to modify the profile from level 1 to level 16
3. After each segment is modified press the "ENTER" key to move to the next segment.
4. After modifying the entire profile, press "ENTER" key to begin the program. (Note: you may press Start key anytime to skip the setup and begin the workout immediately.)

Or press the **"START"** to accept the default values and begin the program

- Default Age and Weight = the values previously saved in the console.

## Workout Programs (Continued)

- Default time = 30Min

#### During the Program

Once the Enter key after adjusting the time is pressed or Start key is pressed, the Warm Up will be active. See Warm Up mode section for details.

#### Displays

- Once it is started, the Time display will start counting down from the entered workout time.
- The Pulse display will show a pulse if a heart rate signal is being detected
- The data display will start accumulating Calories and Distance. It will also display Speed, Resistance Level, RPMs and Watts.

#### Adjustment

- Press "Level Up/Down" key to adjust the intensity level from L1 to L16. The Data display window and Dot matrix window will update the intensity accordingly. The final change in intensity that is done to each segment it will be saved if the Enter key is pressed.

#### Ending the Program

- When program time is up or STOP key is pressed, this program will end and Cool Down will be active. See Cool Down section for details.
- "START" key could be pressed to re-start the Random program again.
- "STOP" key could be pressed to skip the Cool Down and activate the Workout Summary immediately.

#### Pause and Reset

See Console Operating Tips section for details, page 15

## Workout Programs (Continued)

### HR Interactive Program

Dot matrix display during HR Interactive programs – The dot matrix display will display program % Max HR profile, not intensity profile. The row of target % Max HR LEDs will light up to indicate your goal; then the current segment LEDs will light up and blink to show your actual heart rate. You could compare your actual heart rate against your goal while exercising.

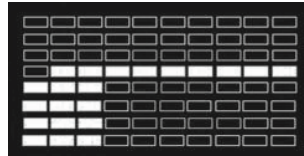

### Target HR

#### Getting Started

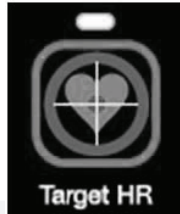

The Target Heart Rate program is designed to keep you training at your chosen heart rate level. Computer will adjust the intensity level automatically to ensure the target heart rate is achieved and maintained during the entire program.

HAND PULSE SENSORS MUST BE USED FOR THIS PROGRAM.

IMPORTANT: It is unsafe to exceed 95% of your maximum heart rate while exercising. Please consult your physician before performing any Heart Rate based training program.

#### Beginning the Program

During Idle mode, the Dot Matrix display will display "DB" and the program LED indicators will be lighting up one at the time. To begin this program, press the **"TARGET HR"** program key, the LED indicator above it will light up.

#### Entering the program

When the "TARGET HR" LED indicator is lit, it indicates you are about to select the Target HR program.

Press the **"ENTER"** key to enter program setup mode. Messages will light up in the main display to guide you through the program setup mode setup step by step:

##### Enter Age:

1. The message "Enter Age" will show up in the Pulse display and the numbers will be blinking
2. You may press UP or DOWN keys to adjust the age.
3. After age adjustment, press "ENTER" key to accept and enter Weight adjustment. The age will be saved in the console as the new default age.

##### Enter Weight

1. The message "Enter Weight" will show up in the Pulse display and the numbers will be blinking
2. You may press UP or DOWN keys to adjust the weight
3. After weight adjustment, press "ENTER" key to accept and enter Time adjustment. The weight will be saved in the console as the new default weight.

## Workout Programs (Continued)

### Enter your workout time:

1. The message "Time" will show up in the Time display and the numbers will be blinking
2. You may press UP or DOWN keys to adjust the time
3. After Time adjustment, press "ENTER" key to accept and begin the program. (Note: you may press Start key anytime to skip the setup and begin the workout immediately.)

Or press the **"START"** to accept the default values and begin the program

- Default Age and Weight = the values previously saved in the console.
- Default time = 30Min

### During the Program

Once the Enter key after adjusting the time is pressed or Start key is pressed, the Warm Up will be active. See Warm Up mode section for details.

### Display

- When warm up mode is completed, the console will detect if there is a valid heart rate signal before starting this program. If there is none, this program will not be started. The pulse display will blink "---" until a heart signal is detected.
- Once there is a valid heart rate signal detected, this program will be active. The pulse display will stop blinking "---" and it will start displaying the actual pulse
- The Time display will start counting down from the entered workout time.
- The data display will start accumulating Calories and Distance. It will also display Speed, Resistance Level, RPMs and Watts.

### Adjustment

- Press UP or DOWN key to adjust the desired Target HR. The dot matrix window will update the % Max HR profile accordingly.

### Ending the Program

- When program time is up or STOP key is pressed, this program will end and Cool Down will be active. See Cool Down section for details.
- "START" key could be pressed to re-start the Random program again.
- "STOP" key could be pressed to skip the Cool Down and activate the Workout Summary immediately.

### Pause and Reset

See Console Operating Tips section for details, page 15



## Maintenance

### CAUTION – FOR SAFE OPERATION

**Always** inspect hardware prior to any exercise session. Look for loose hardware, loose pedals, loose cranks and frayed wires. Repair or replace any damaged or worn parts, tighten all loose hardware.

As part of Diamondback Fitness' normal installation and set-up process, all pedal cranks must be tightened after 8 to 10 hours of initial riding to ensure parts are properly seated to axle. This is standard initial "break-in" service which must be performed after the first 8 to 10 hours of use. Un-tightened pedal cranks may become loose, causing damage which may void the warranty.

After training, always wipe down your unit. Perspiration that continuously settles on frame, pads or casing may eventually cause rust to the unit. Damage resulting from lack of proper maintenance will not be covered under warranty. To clean pads, use a mild soap and warm water. Dry with a clean towel.

If noises develop or malfunctions occur, contact your authorized Diamondback Fitness dealer.

## Domestic Warranty Information

(Applies to all product sold and placed within the continental US, Alaska, Hawaii, and Puerto Rico only)

### **Effective: May 2008**

Diamondback warrants its 500 model units to be free from defects in material and workmanship under normal use in home environments. Diamondback's obligation under this Warranty is limited to repair or replacement of any defective part without charge through an authorized service agent to the original purchaser with the following parameters:

### **Who is covered:**

The Warranty is extended to the individual or legal entity whose name appears on the Warranty registration card filed with Diamondback and may not be transferred to any other individual or legal entity.

### **To obtain service:**

To obtain service you must contact your authorized Diamondback Fitness dealer. Your dealer is also your authorized service agent. An authorized service agent must diagnose your unit in order to determine Warranty claims/issues.

Sales where the unit is delivered unassembled (in a carton) to the end user (e.g. Mail order or Internet sales) without a service contract purchased through the dealer voids the Warranty.

### **Warranty Registration:**

Warranty commitments are valid only with a completed Warranty card that is returned within 15 days from the date of purchase and includes the product serial number. Registration is available at [www.diamondbackfitness.com](http://www.diamondbackfitness.com).

Proof of purchase from Diamondback's authorized dealer will be required if the Warranty card is not registered prior to any consideration of Warranty claim.

### **What is covered**

Home use only

Frame: Lifetime limited Warranty, covers defects in welds, materials, and workmanship.  
Brake: Lifetime limited Warranty

Parts & Electronics: 3 Years  
Labor: 1 Year

### **Warranty voided if:**

The Warranty does not apply to any failure of the product, or any parts of the product, due to: assembly errors, alterations, modifications, misuse, abuse, accident, improper maintenance, or if the serial number on the product has been removed, altered or defaced. Assembly errors include but are not limited to:

Damaged wire harness.  
Stripped crank arms and/or pedals.  
Bolts used in the wrong location.

### **Parts & Service:**

Contact the authorized Diamondback dealer where unit as originally purchased. If you have moved, or that retailer is unavailable, use our dealer locator at [www.diamondbackfitness.com](http://www.diamondbackfitness.com) to help find another authorized dealer.

Diamondback is not responsible for arranging Warranty service and/or honoring extended warranties

**Domestic Warranty Information (Continued)**

**Notes**

provided by dealers.

**Exclusions:**

Warranty is void if the 500 model units is placed in a commercial or light commercial environment, such as health club, school, or correctional facility.

**Additional Rights:**

This Warranty is expressly in lieu of all other warranties, and any implied warranties of merchantability or fitness for a particular purpose created hereby, are limited to the same duration as the express Warranty herein. Raleigh America, Inc. shall not be liable for any incidental or consequential damages. Some states do not allow the exclusion or limitations of implied warranties, incidental or consequential, so the above limitations and exclusions may not apply to you.

Retailers and wholesale outlets for Diamondback Fitness Inc. products are not authorized to modify this Warranty in any way.

This Warranty gives the original owner specific legal rights. Other additional rights may vary from state to state.

Diamondback Fitness  
c/o Raleigh America, Inc.  
6004 S. 190th Street, Suite 101  
Kent, WA 98032  
Ph: 800.776.7642

Notes



**IMPORTANT! IMPORTANT! IMPORTANT! IMPORTANT!**

*Warranty card must be completed and returned to Diamondback within 15 days of purchase. Failure to comply may void manufacturer's Warranty. Or, you may register your product at [www.diamondbackfitness.com](http://www.diamondbackfitness.com).*

Your Name: \_\_\_\_\_

Address: \_\_\_\_\_

City: \_\_\_\_\_ State: \_\_\_\_\_ Zip: \_\_\_\_\_

Daytime phone No.: \_\_\_\_\_ Evening phone No.: \_\_\_\_\_

Dealer Store Name: \_\_\_\_\_

Address: \_\_\_\_\_

City: \_\_\_\_\_ State: \_\_\_\_\_ Zip: \_\_\_\_\_

Model: \_\_\_\_\_ Serial No.: \_\_\_\_\_

Purchase Date: \_\_\_\_\_

Environment Unit Placed:

Home  Light Institutional, i.e. Hotel, Business Center...

Mail Completed Form To:

Diamondback Fitness  
c/o Raleigh America, Inc.  
6004 S. 190th Street, Suite 101  
Kent, WA 98032  
Ph: 800.776.7642

## Free Manuals Download Website

<http://myh66.com>

<http://usermanuals.us>

<http://www.somanuals.com>

<http://www.4manuals.cc>

<http://www.manual-lib.com>

<http://www.404manual.com>

<http://www.luxmanual.com>

<http://aubethermostatmanual.com>

Golf course search by state

<http://golfingnear.com>

Email search by domain

<http://emailbydomain.com>

Auto manuals search

<http://auto.somanuals.com>

TV manuals search

<http://tv.somanuals.com>