

600T^m

600T^m

600T^m

Diamondback

f i t n e s s 

600 T^m OWNER'S MANUAL

600T^m



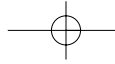

PURCHASER'S REFERENCE INFORMATION



IT IS IMPERATIVE THAT YOU FILL IN THE FOLLOWING INFORMATION AND REFER TO IT SHOULD THE NEED FOR SERVICE ARISE.

Product Name: Diamondback 600Tm Treadmill
Serial Number: R _____

SERIAL NUMBER
R0608640001
|||| ||| ||||| |||||
WARNING REMOVING OR ALTERATION
OF THIS LABEL VOIDS WARRANTY

To Activate Warranty:

REGISTER YOUR WARRANTY AT

www.diamondbackfitness.com

OR COMPLETELY FILL OUT THE ATTACHED WARRANTY CARD (SEE BACK COVER) AND RETURN TO DIAMONDBACK FITNESS WITHIN 15 DAYS OF THE DATE OF PURCHASE. FAILURE TO COMPLY WITH THE WARRANTY ACTIVATION PROCEDURE MAY VOID THE MANUFACTURER'S WARRANTY.



Serial Number

Dealer Name: _____

Dealer Address: _____

Dealer Telephone Number: () _____

Dealer Contact Name: _____

Date Purchased: _____

Shipping Materials:

Diamondback recommends that you retain the original packing materials (box and packing items) for future shipping needs.



TABLE OF CONTENTS

Purchaser's reference information	2
Introduction	4
Safety Instructions and Warnings	5
Assembly Instructions	7
Workout Guidelines	10
Maximum Heart Rate & Training Zone	
Quantity and Quality	
Heart Rate Monitoring Devices	13
Console	14
Glossary of Terms	
Default Values	
Operating Tips	
Console Layout	17
Displays	
Function Keys	
Workout Programs	20
Belt Start Sequence	
Warm Up	
Cool Down	
Workout Summary	
Quick Start	
Classic Programs	
Manual	
Interval Trainer	
Hill Walk	
Random Hills	
Easy Jog	
5K Train & 10K Run	
Thigh Burner	
HR Interactive Programs	
Target HR	
HR Intervals	
HR Hill	
Cardio Training	
Custom Programs 1, 2, 3 & 4	
Domestic Warranty Information	43
Maintenance	45
Warranty Card	47





INTRODUCTION

Congratulations on the purchase of your new 600Tm treadmill. You are about to experience one of the most effective and technically advanced methods of low impact, cardiovascular exercise available today. Your 600Tm was created by Diamondback Fitness, the innovative leader in fitness and bicycle equipment for nearly three decades.

Your 600Tm has all the latest features and design elements to make your workout extremely efficient and comfortable. Your console offers 6 display windows with easy to select programming buttons, plus a Polar® Compatible Heart Rate receiver. You can chose from 8 preset programs including Quick Start and Random options, plus 4 Heart Rate interactive programs. Our new treadmill is a serious cardio fitness machine that will keep you motivated, challenged and within reach of your fitness goals.

You can count on your Diamondback Treadmill to provide years of pleasure and fitness. The solid steel frame, quality construction, techno-savvy electronics and exceptional styling are guaranteed to provide you with the ultimate workout experience. Congratulations on choosing a treadmill from America's premier name in light institutional and home exercising equipment.

For more information or questions regarding your 600Tm, please go to our website at www.diamondbackfitness.com. Or please contact us:

Diamondback Fitness
300 Camarillo Ranch Road,
Camarillo, CA 93012
Ph. 1.800.776.7642
Fax: 1.805.388.5890

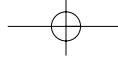

SAFETY INSTRUCTIONS AND WARNINGS

This treadmill is built for optimum safety and is designed to meet or exceed all domestic and international standards. However, basic precautions need to be followed when operating any exercise equipment. BE SURE TO READ THE ENTIRE OWNER'S MANUAL BEFORE OPERATING YOUR UNIT.

CAUTION – FOR SAFE OPERATION

1. Wear the safety cord and clip all times while using the treadmill.
2. Before beginning any exercise program on the treadmill, it is important to consult with your physician if you have any of the following: History of heart disease, high blood pressure, diabetes, chronic respiratory diseases, elevated cholesterol, or if you smoke cigarettes or experience any other chronic diseases or physical complaints.
3. If over the age of 35 or overweight, consult with your physician before beginning any exercise program.
4. Pregnant women should consult with their physician before beginning an exercise program.
5. If you experience dizziness, nausea, chest pains or other abnormal symptoms during exercise, stop the exercise session immediately. Consult your physician before continuing.
6. Drink fluids if you exercise for twenty or more minutes on the treadmill.
7. Always follow the console instructions for proper operation.

DANGER

To reduce the risk of electric shock, always unplug the treadmill from the electrical outlet immediately after using and before cleaning.

WARNING – TO REDUCE THE RISK OF BURNS, FIRE, ELECTRIC SHOCK, OR INJURY TO PERSONS:

1. This treadmill should never be left unattended when plugged in. Unplug from outlet when not in use, and before servicing or moving the unit.
2. Close supervision is necessary when using this treadmill around children, pets, invalids, or disabled persons. Keep children & pets away from the treadmill. Hands and feet may get caught in the moving parts which could result in serious injury.
3. Never operate your treadmill if it has a damaged cord or plug, or if it is not working properly. Contact your authorized Diamondback Fitness dealer for service and repair.
4. Keep the power cord away from heated surfaces.
5. Never insert any objects into openings. Keep hands and feet away from all moving parts.
6. This treadmill is designed for home use only.
7. Check the power requirement for your unit to see if it matches your local area power outlet.
8. Do not operate the heart rate monitor transmitter together with an electrical heart pacemaker. The transmitter may cause electrical disturbances.
9. Inspect this treadmill prior to exercising to ensure it is working properly. Always make sure all components are fastened securely.
10. This treadmill is intended for indoor use. Do not place the unit outdoors.
11. Place your treadmill on a solid, level surface when it is in use. Adjust the leveler on the treadmill if necessary.
12. Do not dismount the treadmill until it has come to a complete stop.
13. Do not operate if oxygen equipment is being utilized or if aerosol (spray) products are being



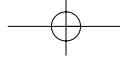

SAFETY INSTRUCTIONS & WARNINGS (CONTINUED)



Use open wrench to adjust the leveling pad here.

used in the area.

14. Keep the treadmill away from walls to allow proper ventilation. Air should be able to circulate freely around the unit. Keep all air openings free of dirt and dust.
15. To ensure proper functioning of your treadmill, do not install attachments or accessories not provided or recommended by Diamondback.
16. Place the treadmill in an area that will meet minimum clearance requirements: Front & Sides: 1 ft / 30 cm, Back 6 ft./ 180 cm
17. Always wear proper clothing and shoes when exercising on the treadmill.
18. Do not stand on the tread belt while performing auto-calibration.
19. Never walk or jog or run backwards on the treadmill.
20. Higher speed and higher incline is not for everyone. It is designed for occasional use of a skilled runner and may exceed many users' capabilities. Stop right away if you feel any discomfort.
21. Use this treadmill only for its intended use as described in this manual. User weight is not to exceed 350 pounds / 159 kilograms.
22. Use the handrails when getting on and off your treadmill.
23. Do not remove the treadmill covers or other components. Only an authorized Diamondback Fitness dealer should perform service.

GROUNDING INSTRUCTIONS

This product must be grounded. If it should malfunction or breakdown, grounding provides a path of least resistance for electric current to reduce the risk of electric shock. The treadmill is equipped with a cord having a grounding conductor and grounding plug. The plug must be plugged into an appropriate outlet that is properly installed and grounded in accordance with all local codes and ordinances.

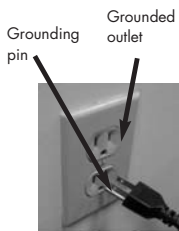

Figure
Grounding
Methods

DANGER

Improper connection of the grounding conductor can result in risk of electric shock. Check with a qualified electrician or serviceman if you are in doubt as to whether the treadmill is properly grounded. Do not modify the plug provided with this product- if it will not fit the outlet, have a proper outlet installed by a qualified electrician.

Your treadmill is for use on a 120 volt circuit and has a grounding plug that looks like the one illustrated in the picture above. Make sure the treadmill is connected to an outlet having the same configuration as the plug. Do not use an adapter with your treadmill.

SAFETY KEY CLIP & TETHER

- Your treadmill will not start unless the safety key is placed on the proper location of treadmill console.
- Attach the safety key clip properly onto your clothes before operating treadmill.
- In case of an emergency, pull the safety key off the treadmill, it will cut off the power to the console and stop the treadmill immediately.
- Place the safety key back in place, the treadmill will resume back to idle mode.
- Contact your dealer for a safety key replacement if you do not have one.



Place this clip onto your clothes *before* you start using treadmill.

SAVE THESE INSTRUCTIONS



ASSEMBLY INSTRUCTIONS

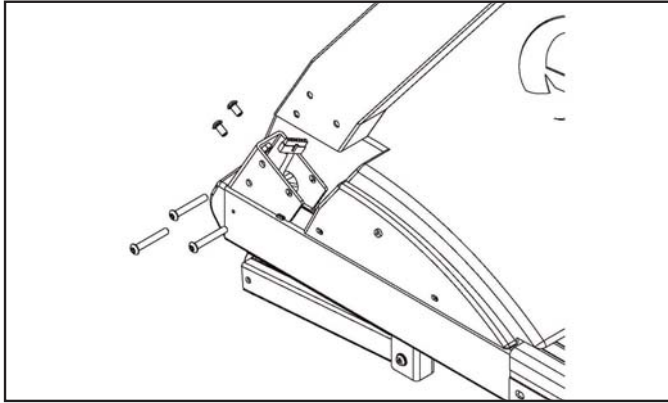

Step 1: Upright Posts Assembly

1. Straight out the main wire harness and insert it through the top of left upright post.
2. Slide the upright post onto its receptor and insert three M8 x55mm screws and washers on the side and two M8 x 15mm screws and washers on the front. Tighten these 5 screws with Allen wrench. Be careful not to pinch the main wire harness while tighten these screws.
3. Repeat procedure 2 for the Right upright post.
4. Make sure the screws are securely tightened

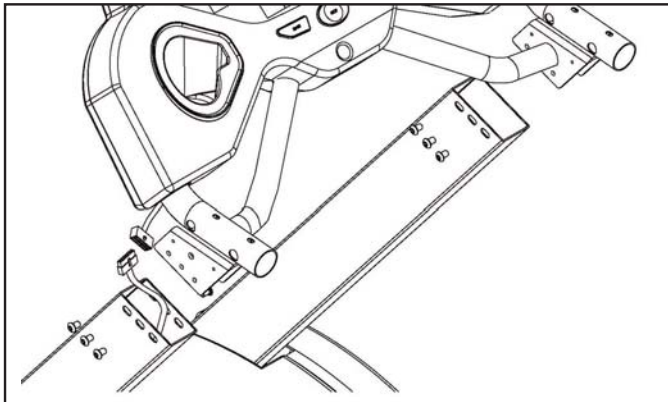

Step 2: Console Assembly

1. Hold the console next to the Left upright post and connect the main wire harness connectors together.
2. Insert the console U bracket into each side of upright post. Be careful not to pinch the wire harness while inserting the U bracket.
3. Insert three M8 x12mm screws and washers each on inner and outer Left upright post (totally 6 screws on each upright post).
4. Tighten the 6 screws securely with Allen wrench.
5. Repeat procedure 3 & 4 for Right upright post.
6. Make sure all screws are securely tightened.



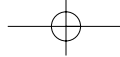

ASSEMBLY INSTRUCTIONS

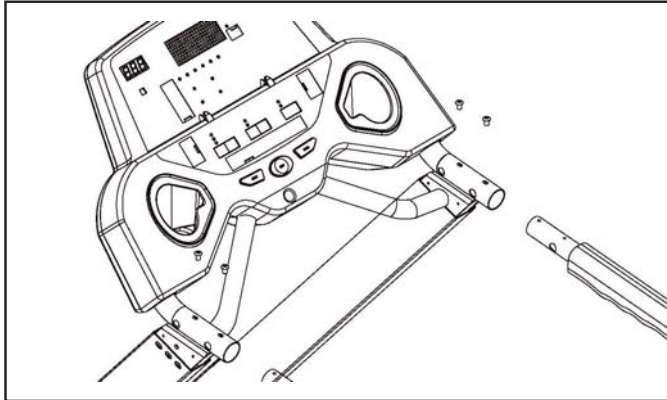

Step 3: Handrail Assembly

1. Insert Left handrail into Left handrail receptor.
2. Insert two M6 x12mm screws and tighten them with Allen wrench.
3. Repeat the procedure 1 & 2 for the Right handrail.
4. Make sure all screws are securely tightened.

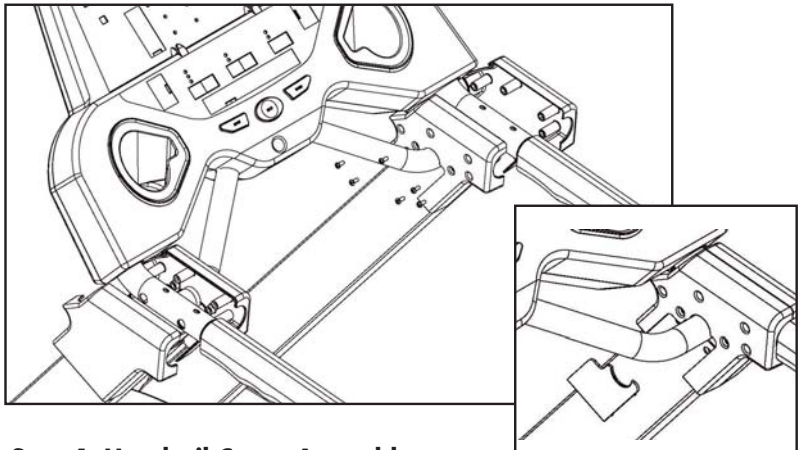

Step 4: Handrail Cover Assembly

1. Place the Left inner handrail cover into the Left handrail and tighten this cover with two M5 x12mm screws using Phillips screwdriver.
2. Now place the outer handrail cover through the handrail and into inner cover. Insert four more M5 x12mm screws. Tighten all 6 screws now.
3. Repeat procedure 1 & 2 for the Right handrail covers.
4. Place the handrail cover inserts into the inner handrail covers.



ASSEMBLY INSTRUCTIONS

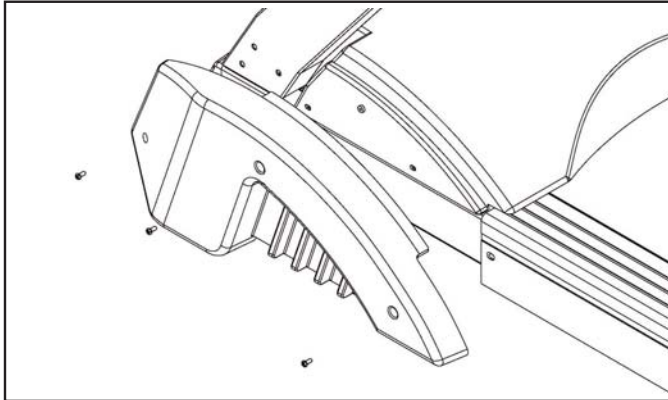

Step 5: Motor Cover Assembly

1. Place the Left motor cover onto the left side of frame.
2. Insert and tighten the self-tap M5 x 10mm screw into the center and top mounting hole using Phillips screwdriver.
3. Insert and tighten two M5 x16 on front and rear end of the cover using Phillips screwdriver.
4. Repeat procedure 1, 2 & 3 for Right motor cover.

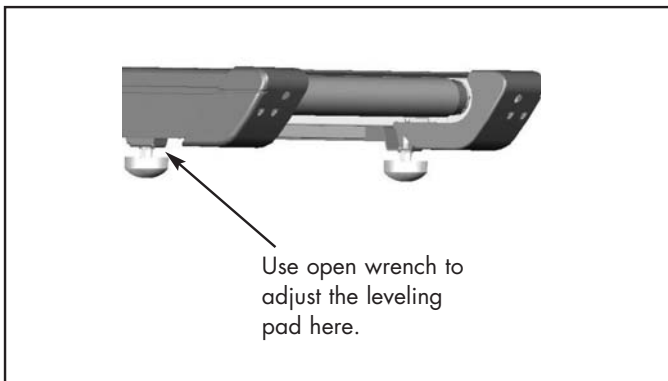

Step 6: Finish Up

1. Make sure the treadmill is leveled with the floor. Adjust it if necessary.
2. Plug your power cord in and turn ON the treadmill.
3. Make sure your safety key is in place.





WORKOUT GUIDELINES

Good health is an exercise in common sense.

The Surgeon General released a new study in 2001, The Surgeon General's Call To Action To Prevent and Decrease Overweight and Obesity. It indicates that 61% of American adults are either overweight or obese. The story states that overweight increases the risk of health problems, such as heart disease, certain types of cancer, type 2 diabetes, etc. It further points out that overweight needs to be regarded primarily as a Health rather than as an Appearance issue.

The Surgeon General's Healthy weight advice for consumers is:

1. Aim for a healthy weight: Find your Body Mass Index (BMI) on the chart below.
2. Be active: Keep physically active to balance the calories you consume.
3. Eat well: Select sensible portion sizes.

$$\text{BMI} = (\text{weight (lb)} \div \text{height}^2 \text{ (in)}) \times 703$$

Weight in Pounds

	120	130	140	150	160	170	180	190	200	210	220	230	240	250
4'6	29	31	34	36	39	41	43	46	48	51	53	56	58	60
4'8	27	29	31	34	36	38	40	43	45	47	49	52	54	56
4'10	25	27	29	31	34	36	38	40	42	44	46	48	50	52
5'0	23	25	27	29	31	33	35	37	39	41	43	45	47	49
5'2	22	24	26	27	29	31	33	35	37	38	40	42	44	46
5'4	21	22	24	26	28	29	31	33	34	36	38	40	41	43
5'6	19	21	23	24	26	27	29	31	32	34	36	37	39	40
5'8	18	20	21	23	24	26	27	29	30	32	34	35	37	38
5'10	17	19	20	22	23	24	26	27	29	30	32	33	35	36
6'0	16	18	19	20	22	23	24	26	27	28	30	31	33	34
6'2	15	17	18	19	21	22	23	24	26	27	28	30	31	32
6'4	15	16	17	18	20	21	22	23	24	26	27	28	29	30
6'6	14	15	16	17	19	20	21	22	23	24	25	27	28	29
6'8	13	14	15	17	18	19	20	21	22	23	24	25	26	28

Healthy Weight Overweight Obese

Note: This chart is for adults (aged 20 years and older).

Heart rate is an important key to your exercise.

The Surgeon General also released a report on physical activity and health. This report definitively stated that exercise and fitness are beneficial for a person's health and redefined that exercise is a key component of disease prevention and healthier living.

Medical research has shown us that there is an amount of exercise, which is enough to condition the cardio respiratory system and the muscles of the body. This amount of exercise is between 60% and 85% of your maximum heart rate measured during a training session. This range allows enough exercise to achieve fitness, but not an excessive amount to cause injury. Your heart rate is an excellent indicator of the amount of

WORKOUT GUIDELINES (CONTINUED)

stress placed on the cardiovascular system. Taking full advantage of this information, this treadmill is designed to include heart rate monitoring features.

If exercise intensity is too low or too high, no gains will be made in fitness. If the intensity is too low, the stress levels are ineffective. If the intensity is too high, injury or fatigue may set your exercise program back as you try to recover.

The best way to monitor exercise intensity is to accurately count your pulse during exercise. Your heart rate can easily be determined by counting your pulse at the chest, wrist or at the carotid artery on your neck. It is difficult to count your own pulse during exercise, mainly because you cannot count fast enough to get an accurate number. This treadmill is equipped with a wireless telemetry receiving system. What it does is automatically count your heart rate while you are wearing a heart rate chest belt during your exercising period. Heart rate is monitored and electronically displayed as a digital readout. Your target heart rate, the intensity needed to improve cardiovascular fitness, depends primarily on your age and not your state of fitness. It is calculated as a percentage of your maximum heart rate, estimated as 220 minus your age. It is most effective to train at your target heart rate between 60% and 85% of your maximum heart rate. In order to get the most accurate reading, it is recommended to enter your age before your workout.

Maximum Heart Rate & Training Zone

To calculate your maximum heart rate and find your training zone, use the following formula. An example has been provided below based for a 35-year-old person:

220 – Age = Maximum Heart Rate	(220 – 35 = 185)
60% of Maximum Heart Rate	(60% x 185 = 111bpm)
85% of Maximum Heart Rate	(85% x 185 = 157bpm)
Training Zone:	111bpm – 157bpm

Quantity & Quality

It is recommended that you accumulate at least 30 minutes of physical activity most days of the week. Physical activity should be initiated slowly and the intensity should be increased gradually. You should select activities that you enjoy and can fit into your daily life. Having Diamondback equipment at home certainly gives you the comfortable and convenient workout you want.

The American College of Sports Medicine makes the following recommendations for the quantity and quality of training for developing and maintaining cardio respiratory fitness in healthy adults:

- An activity that uses large muscle groups, maintained continuously, and is rhythmical and aerobic in nature.
- Duration: 20 to 60 minutes of continuous aerobic activity, including a warm-up and cool-down period for each exercise session.
- Frequency: 3 to 5 times per week.
- Intensity: 60% to 85% of maximum heart rate.
- In addition to aerobic exercise, it is recommended that you add strength training of moderate intensity twice per week to your program.



Heart Rate Guidelines 60% - 85% Maximum Target

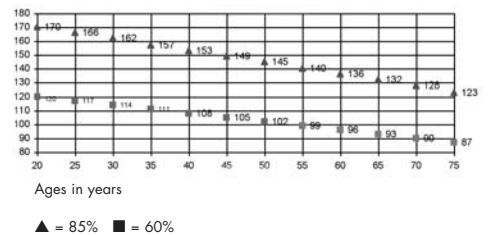

Typical Target Zone Exercise Patterns for 35 year-old

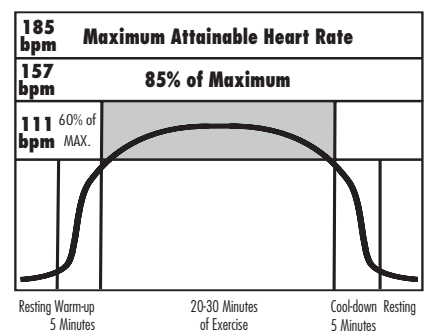



WORKOUT GUIDELINES (CONTINUED)

Get a smart start on exercising.

Anyone over the age of 35, as well as younger persons whom are overweight, should check with his/her physician before beginning any type of exercise program. People who have diabetes or high blood pressure, a family history of heart disease, high cholesterol or have lead a sedentary lifestyle should protect themselves with a medical check-up and a stress test, preferably administered during exercise by a health-care professional.

1. Always stretch before your workout to loosen muscles, and afterwards to cool down.
2. The first few minutes of your workout should be devoted to warming up muscles before a vigorous workout, and building your heart rate slowly.
3. After your aerobic workout of about 24-32 minutes, spend 10 minutes gradually reducing your heart rate with a lower resistance level.

Remember, to start slow, with intensity low, until you build endurance and strength. And always consult your physician before beginning any exercise program.

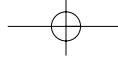

HEART RATE MONITORING DEVICES

Built in Wireless Heart Rate Receiver

This treadmill is equipped with a built-in receiver for your heart rate monitoring. To get an accurate reading using these devices, you will need to be within three feet of the console, and a minimum of four feet from others using a heart rate monitoring device.

(Note: The transmitter may fluctuate erratically if you are too close to other heart rate monitoring equipment or there is other electronics near by, such as TV, Radio...)

The receiver of the wireless ECG system is built into the console unit of this treadmill. While using heart rate control modes, the computer monitors the exact measurement of your pulse. Heart rate frequency is displayed while the computer continually compares heart rate to the preprogrammed personal data. The computer adjusts the wattage to maintain heart rate at the preprogrammed level.

How to Wear Your Sensor/ Transmitter (Chest Strap)

1. Buckle one end of the chest strap onto the transmitter.
2. Adjust the band length so that the fit is snug, but not too tight.
3. Buckle the other end of the chest strap onto the transmitter.
4. Center the transmitter on your chest below the pectoral muscle (breasts).
5. Stretch the transmitter away from your chest and moisten the conductive electrode strips located next to the buckles with water.

(Note: The transmitter is on automatically when being worn. It is off when it is not connected to your body. However, as moisture may activate the transmitter, thoroughly dry the transmitter to prolong battery life.)

Erratic Heart Rate Readings:

Erratic readings on the receiver can be caused by electromagnetic disturbances. If the heart rate readings appear to be abnormal, check that your product is not within range of other strong electromagnetic signals. Common sources are televisions, computers, cars, cell phones, TV antennas and high voltage power lines (both above and below ground). Please note: Static electricity in clothing or a flapping shirt can cause electrical interference, so some items of clothing, i.e. man-made fibers, can also be the cause. Please try wetting the t-shirt in the area where the transmitter is.

If the battery of the transmitter is running low, the transmission range decreases and may cause errors similar to the ones listed above in this document.

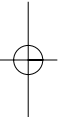
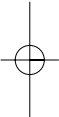



CONSOLE

Glossary of Terms

- Idle mode = Console is reset and waiting for an entry. The dot matrix display window will show "DB" and message display will scroll following a message of "SELECT A PROGRAM OR PRESS START". If no key input for 30 minutes, the console will enter sleep mode and the display will be shut off.
- Sleep mode – no key input during idle mode, the console display will be off. You can press any key to wake up the console and return to idle mode.
- LED = The lights on the face of the console.
- Watts = The rate of energy currently being expended.
- Work = The amount of energy expended during exercise.

Default Values

- Age = 35 years
- Weight = 155 lb or 70kg for Metric system
- Program Time = 30 minutes; for 5K or 10K program, the program default time is 1 hour.
- Max program time = 4 hours. When continues workout time reaches 4 hours, the treadmill will enter cool down mode.
- Speed default for Warm up and Cool down is 2.0mph.
- Incline default for Warm up and Cool down is 0%.
- Target HR default is 70% of max HR.

Operating Tips

- Power ON/OFF: Power ON/OFF switch is located in the front of the motor cover. Turn Power ON before use the treadmill and turn it OFF when not using treadmill.
 - Turn the Power ON, the incline will return to 0% automatically.
 - In the power save mode, press any key to wake up the console and start operation.
- Program start sequence
 - Program selecting mode - Press program selecting key to select a program, press "ENTER" to accept.
 - Program setting mode – console will prompt program setting for your adjustment, press UP/DOWN key or numeric quick keys to adjust the setting and ENTER to confirm.
 - Warm up mode – as soon as START key is pressed, Warm up mode will start, except Quick Start & Manual programs.
 - Program run mode – after warm up mode, the program run mode will start. The program time starts counting and dot matrix profile starts blinking.
 - Cool down mode - when program time is up, program will end and Cool down mode will begin.
 - Workout summary mode – after completing cool down mode, console will display your workout summary for your review.
- Reset: To reset a program during its operation, press and hold the "STOP" key for 2 seconds. When the program resets, the console returns to idle mode.

CONSOLE (CONTINUED)



- **Pause a program:** You may interrupt or pause a program for up to 30 minutes during a workout before the console resets. To pause a program, simply press "STOP" key once.
 - The dot matrix will scroll "PAUSE" during pause mode
 - The incline will stay at the current setting; speed will return to 0mph.
 - Press "STOP" key one more time during Pause mode, the program will end and enter workout summary mode.

- **Resume a program :** To resume a program back to the point of where you left off, either press "START" key during pause mode.

- **Switching a program:** The user may switch from current operating program to another program during program run mode, cool down or workout summary mode by pressing a program selecting key. Calories and distance will continue accumulating from previous program.
 - If "Classic Program" or "HR Interactive" program key is pressed during a program-executing mode, it will enter program-switching mode:
 - The dot matrix will switch to display the new program default profile display. You may continue pressing the program selecting key until your desire program LED is lit.
 - Press "ENTER" to accept this new program or "START" key to start this new program right away.
 - If "ENTER" key is pressed, it will enter this program setup mode; time display will be prompted with default time and wait for an entry. Age and weight default will be the last update.
 - Follow the prompts to set up the program. Press "UP/DOWN" key to adjust the setting. When finish, press "START" to start the program, the new program will begin, and Warm Up mode will be skipped.
 - If 3 seconds passes after your initial program selecting key pressed and no other key is pressed, the program will resume back to previous activities.

- **Re-start a program:** The user may re-start a program after the program ends. Simply press "START" key during Cool Down or Workout Summary mode. The program will be started immediately without Warm up. The program default will remain the same as previous program; the calories and distance will continue accumulating.

- **Speed adjustment:** When speed adjustment is allowed by a program, you may adjust the speed from 0 mph to 11 mph by pressing SPEED UP/DOWN key.
 - 10.6 - 12.0mph
 - 9.1 - 10.5mph
 - 7.6 - 10.5mph
 - 6.1 - 7.5mph
 - 4.6 - 6.0mph
 - 3.1 - 4.5mph
 - 1.6 - 3.0mph
 - 0.5 - 1.5mph
 - Dot matrix profile will adjust the display according to the Speed adjustment. Each row of LED at dot matrix display represents

CONSOLE LAYOUT

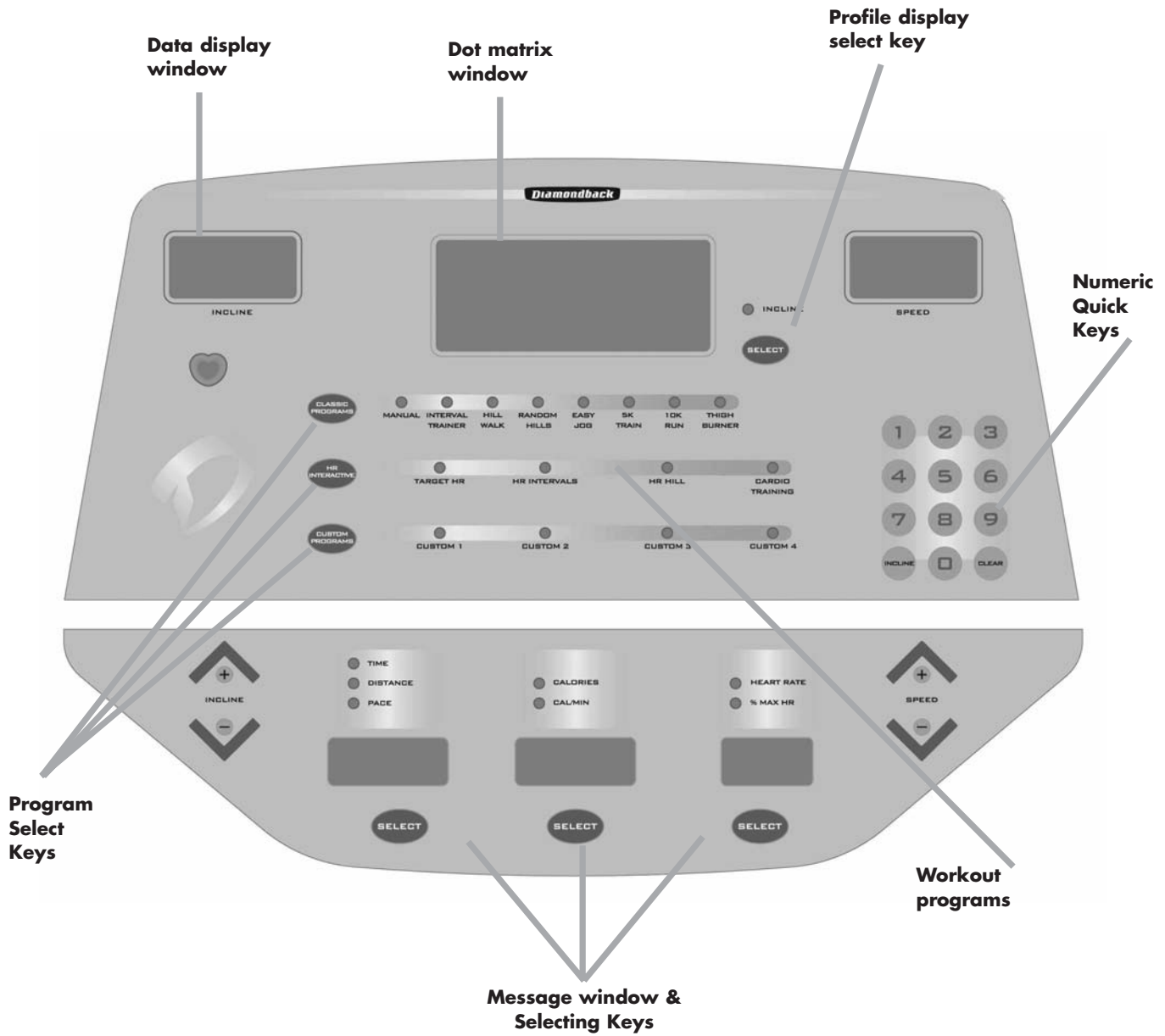

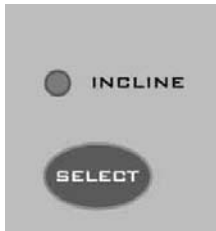
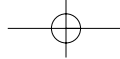

Select Key



Speed & Incline displays



Message & data displays

CONSOLE LAYOUT (CONTINUED)

Displays:

a. Dot Matrix /Profile display:

- It displays instruction letters during setup.
 - Display "AGE" during age setup; "WT" for weight setup; "TIME" for time setup & "HR" for HR setup.
 - Display "ENGL" or "METR" for English or Metric units switch.
 - Scroll "WARM UP" or "COOL DOWN" to indicate entering these modes.
- It displays the program profile during the program run mode.
 - Press this SELECT key to switch the profile display from default to Incline profile and light up its LED indicator or from Incline profile back to default profile and turn off the LED indicator.
 - Each column represents segment time = Program time / 20 columns. If the program time is less than 20 minutes, then the segment time will be 1 minute instead.

b. Workout data display:

a. Speed and Incline display

- Speed (mph) – Current speed.
- Incline (%) – current incline %

b. Other data displays

As soon as a program is started, it will start displaying the default workout data: time, calories & heart rate. You may select your favorite data displays by pressing the "SELECT" button under each data display, the LED indicator will light up to show which data is displaying.

- Time (hr: min or min: sec): The remaining of program time.
- Distance (mile): Total workout distance.
- Pace (min: sec): current minutes per mile.
- Calories (kcal): Total workout calories.
- Cal/min: current Calorie rate.
- Heart rate (bpm): Your current heart rate. If there is no pulse detected, it will display " - - - " instead.
- % max HR: Current % max HR.

- Pulse indicator:** the heart indicator will start blinking once there is heart rate signal detected by the console.

Function keys:

a. Speed Up/Down keys:

- During program setup, press Speed "UP/DOWN" key to adjust the following – age, weight, time & HR setting.
- After program started, press Speed "UP/DOWN" key to adjust the speed.



CONSOLE LAYOUT (CONTINUED)

- o Speed increment = 0.1mph.
- b. Incline Up/Down keys:**
- o During program setup, press incline "UP/DOWN" key to adjust the following – age, weight, time & HR setting.
 - o After program started, press Incline "UP/DOWN" key to adjust the incline.
 - o Incline increment = 0.5%.
- c. Enter key:**
- o After program selecting, press "ENTER" to accept the program and enter its setup mode.
 - o After age, weight, time..... adjustment, press "ENTER" key to accept your entry.
- d. Start key:**
- o Press "START" to start a program during program setup.
 - o Press "START" key to skip Warm up and enter program executing.
 - o Press "START" to re-start a program during Cool Down, workout summary mode.
 - o Press "START" to resume a program from pause mode.
- e. Stop key:**
- o Press and hold "STOP" button for 2 seconds to reset the console.
 - o Press "STOP" to pause program run mode.
 - o Press "STOP" to enter workout summary during Cool Down.
- f. Numeric Quick Keys:**
- o Press numeric keys to enter your Age, Weight during program set up. After entry, press ENTER to confirm. Ex: Press "5,4" for age 54.
 - o Press numeric keys to enter Time during program set up. Press ENTER to confirm after entry. The unit of the entry will be 1 minute. Ex: Press "1,0,0" for 100 minutes.
 - o Press numeric keys to enter HR setting during program set up mode only. Press ENTER to confirm your entry. Ex: Press "1,3,7" for 137bpm.
 - o Press numeric keys to adjust the Speed during program run mode. The entry will be 1.0mph increment with no decimal point. Ex: Press "4" for 4.0mph.
 - o Press "INCLINE" and numeric keys to adjust Incline during program run mode. Press "ENTER" to confirm your entry. Ex: Press "INCLINE, 5" for 5%.
 - o Press "CLEAR" after you press any numeric key to void an entry.
- b. Saftey key**
- o Place the safety clip onto your clothes properly before using treadmill.
 - o Treadmill will not start unless the safety key is properly engaged.
 - o Pull the safety off the treadmill will result power shut off and stop the treadmill immediately.
 - o Pull the safety key off the treadmill if you feel ill after using treadmill or any other emergency occurs.



**Incline & Speed
Up/Down keys**



**Start/Stop/Enter
keys**



**Numeric Quick
Keys**



Safety key



WORKOUT PROGRAMS

B E L T S T A R T S E Q U E N C E

Belt start sequence is designed with your safety in mind. It is an indication to let you know that the treadmill motor is about to start.

Anytime, treadmill is ready to starts from 0mph, the belt start sequence will appear as below:

- Dot matrix will display " 3, 2, 1, GO"
- As soon as GO appears, the belt will starts at 0.5mph and increasing to appropriate setting and program timer will begin.

W A R M U P

Getting Started

This treadmill automatically initiates a 3-minute Warm Up at the beginning of each program. It is designed to prepare your body for an intensive workout and to reduce the possibility of injury during workout.

Note: Warm Up is skipped for the Quick Start or Manual programs. Warm Up is skipped if it is a re-start program or switching from another program.

Beginning the Program

Warm Up is active as soon as the "START" key is pressed and a program is executed. The Dot matrix window will scroll "WARM UP" and then display program profile. This sequence will repeat until Warm up is finished.

During the Program

Data Display

- Once it is started, the data display window will start accumulating and display the default workout data of "time, distance, calories & heart rate". Press "SELECT" button to switch the data displays.
- The time will display count down from 3:00.
- Speed display will show default speed of 2.0 mph.
- Incline display will show default incline of 0%..

Adjustment

- Speed = 2.0mph. Press Speed "UP/DOWN" key or numeric quick key to adjust the speed from 0.5 – 3.5mph only.
- Incline = 0%. Press Incline "UP/DOWN" key or numeric quick key to adjust the incline from 0 – 12%.
- "START" key can be pressed to skip the warm up and start the program immediately.

Ending the Program

- When 3-minute duration is up or START key is pressed, Warm Up will end and the program will execute.
- There will be a beep sound to indicate the Warm up is over and the selected program begins.



WORKOUT PROGRAMS (CONTINUED)

Pause, Reset, Restart, or Switch the program
See Console section for details..

C O O L D O W N

Getting Started

This treadmill is equipped with a 3-minute Cool Down at the end of each program. It appears as soon as a program ends. Cool Down is designed to reduce muscle stiffness and allow your heart rate to recover.

Note: Cool Down is skipped for the Quick Start program.

Beginning the Program

Cool Down is active as soon as a program ends. The dot matrix window will scroll "COOL DOWN" and then display final program profile. This sequence will repeat until Cool Down is finished.

During the Program

Data Display

- Once it is started, the data display window will continue accumulating and display the default workout data of "time, distance, calories & heart rate". Press "SELECT" button to switch the data displays.
- The time will display "3:00" and start continuing down.
- Speed display will show default speed of 2.0 mph.
- Incline display will show default incline of 0%

Adjustment

- Speed = 2.0mph. Press Speed "UP/DOWN" key or numeric quick key to adjust the speed from 0,5 – 3.5mph only.
- Incline = 0%. Press Incline "UP/DOWN" key or numeric quick key to adjust the incline from 0 – 12%.
- "START" key could be pressed to re-start the previous program again.
- "STOP" key could be pressed to skip the cool down mode and active the Workout Summary immediately.

Ending the Program

- When 3-minute duration is up or STOP key is pressed, Cool Down will end and enter Workout Summary. See Workout summary for details.

Pause, Reset, Restart, or Switch the program
See Console section for details.

W O R K O U T S U M M A R Y

Getting Started

For your convenience, this treadmill incorporates a Workout Summary right after the completion of the Cool Down. It will display the total workout data for 3 minutes before the Console resets.





WORKOUT PROGRAMS (CONTINUED)

Beginning the Program

Workout Summary appears as soon as the Cool Down mode ends or a "STOP" key is pressed during Cool Down mode. The dot matrix will display the final program profile. The data display will stop counting and show the final data one at a time.

During the Program

Data Display

- Once this summary is started, the data window will display with default "time, calories & heart rate" displays: :
 - Time display shows total Program time.
 - Distance display shows the total distance.
 - Calories display shows total calories accumulated for the workout.
 - The Incline Display shows the average incline
 - The Speed Display shows the average speed

Press "UP/DOWN" key to switch to the next data display:

- The Cal/min display shows the average caloric rate
- The Pace display shows the average pace for the workout
- The Heart Rate display shows average HR; if there is no HR, it will display "--".
- The %max HR display the average % Max HR; if there is no HR, it will display "--".

Adjustment

- Press "START" key to re-start this program.
- Press STOP key to end workout summary and enter idle mode.
- Press program selecting key to enter switching program sequence.

Ending the Program

- When 30-second duration is up, Workout Summary will end and console will reset.

Pause, Reset, Restart, or Switch the program

See Console section for details.

Q U I C K S T A R T

Getting Started

A Quick Start program is for someone who wants to bypass the setup mode and start their workouts right away. By picking Quick Start program, you are accepting the default values for calculations. Be sure to include a Warm Up period during your workout since the Warm Up mode is skipped in the Quick Start program.

Beginning the Program

During idle mode, the dot matrix window displays "DIAMONDBACK" Messages, to begin this program, simply press "START" key once.



Start Key



WORKOUT PROGRAMS (CONTINUED)

Program Default Values

- Max program time = 4 hours
- Default Speed = 0.5mph
- Default Incline = 0%
- Default profile = speed profile; each segment time = 1 minute.

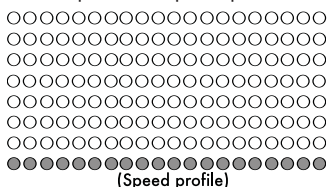

During the Program

Data Display

- As soon as the "START" button is pressed during idle mode, this program will begin; the data display window will display the default workout data of "time, calories & heart rate. Press "SELECT" button to switch the data displays.
- Time display will show 00:00 and count up.
- Speed display will show default speed of 2.0 mph.
- Incline display will show default incline of 0%

Adjustment

- Press Speed "UP/DOWN" key or numeric quick key to adjust the speed from 0 - 11mph. The speed display will update the current & future speed and the dot matrix window will update the profile accordingly.
- Press Incline "UP/DOWN" key or numeric quick key to adjust the incline from 0 -12%. The incline display will update the current & future incline and the dot matrix window will update the incline profile if this display is selected.
- Press "SELECT" key next to dot matrix window to switch the profile display.

Ending the Program

- When the max program time achieves, or "STOP" key has been pressed twice during Quick Start, this program will end and enter workout summary mode.
- There will be a beep sound to indicate the program ended.

Pause, Reset, Restart, or Switch the program

See Console section for details.

C L A S S I C P R O G R A M S

MANUAL PROGRAM

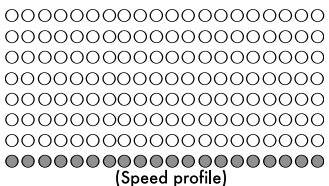

Classic Programs



WORKOUT PROGRAMS (CONTINUED)

Getting Started

You could build your own profile with Manual program. Be sure to include a Warm Up period during your workout since the Warm Up mode is skipped in the Manual program.

Beginning the Program

During idle mode, the dot matrix window displays "DIAMONDBACK.....". To begin this program, press "Classic Programs" key until "Manual" program LED indicator lights up.

Accepting Default values or Entering the program setting mode

When the message display flashes, "MANUAL", "PRESS ENTER", it indicates you are about to select the Manual program.

- Press "START" key to accept current default values and begin Manual program workout.
 - Default Time = 30 minutes
 - Default Speed = 0.5mph.
 - Default Incline = 0%.
 - Default profile = speed profile.
- Or press "ENTER" to enter program setup mode. The dot matrix & data displays will take you through the program setup mode step by step as below:

Enter Age

1. If Enter key is pressed, the dot matrix window will flash "AGE".
2. The time display will display & blink the default age.
3. You may press "UP/DOWN" or numeric quick key to adjust the age.
4. After age adjustment, press "ENTER" to accept and enter Weight adjustment.

Enter Weight

1. If Enter key is pressed after age adjustment, the dot matrix window will flash "WT".
2. The time display will display & blink the default weight.
3. You may press "UP/DOWN" or numeric quick key to adjust the weight.
4. After weight adjustment, press "ENTER" to accept and enter Time adjustment.

Enter Time

1. If Enter key is pressed after weight adjustment, the dot matrix window will flash "TIME".
2. The time display will display & blink the default time = 30:00.
3. You may press "UP/DOWN" or numeric quick key to adjust the time up to 4:00 (hr: min).
4. After time adjustment, press "ENTER" or "START" to accept and begin this program.

(Note: you may press START key anytime to skip the setup and begin the workout immediately.)

During the Program

As soon as the "ENTER" or "START" key is pressed, the Manual program will start.

Data Display

- Once the program is started, this program will begin; the data display window will display the default workout data of "time, calories & heart rate". Press

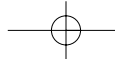

WORKOUT PROGRAMS (CONTINUED)

"Select" button to switch the data displays.

- Time display will show the selected program time and count down.
- Speed display will show default speed of 0.5 mph.
- Incline display will show default incline of 0%.

Adjustment

- Press Speed "UP/DOWN" key or numeric quick key to adjust the speed from 0 – 11mph. The speed display will update the current & future speed and the dot matrix window will update the profile accordingly.
- Press Incline "UP/DOWN" key or numeric quick key to adjust the incline from 0 -12%. The incline display will update the current & future incline and the dot matrix window will update the incline profile if this display is selected.
- Press "SELECT" key next to dot matrix window to switch the profile display.

Ending the Program

- When selected program time is up, this program will end and Cool down will be active. See Cool down section for details.
- If STOP key is pressed twice during program run mode, the cool down mode will end and enter workout summary mode.
- There will be a beep sound to indicate the program ended.

Pause, Reset, Restart, or Switch the program
See Console section for details.



INTERVAL TRAINER

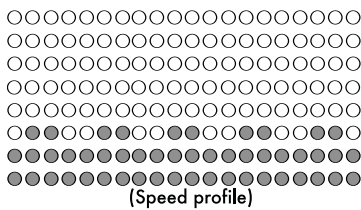

Getting Started

The Interval Trainer program helps to build the strength of your cardiovascular system. By alternating the workload from high speed to low speed & incline, your heart gets an effective workout.

Beginning the Program

During idle mode, the dot matrix window displays "DIAMONDBACK.....". To begin this program, press "Classic Programs" key until "Interval Trainer" program LED indicator lights up.

Accepting Default values or Entering the program setting mode

When the message display flashes, "INTERVAL TRAINER", "PRESS ENTER", it indicates you are about to select the Interval Trainer program. Press "START" or "ENTER" key to go to the next step.

- Press "START" key to accept current default values and begin Interval Trainer program workout.



WORKOUT PROGRAMS (CONTINUED)

- o Default Time = 30 minutes
- o Default profile = speed profile
- o Default speed & incline:

Segment	1	2	3	4	5	6	7	8	9	10	11	12	13	14	15	16	17	18	19	20
Speed	2.5	4.0	4.0	2.5	2.5	4.0	4.0	2.5	2.5	4.0	4.0	2.5	2.5	4.0	4.0	2.5	2.5	4.0	4.0	2.5
Incline	0.0	5.0	5.0	0.0	0.0	5.0	5.0	0.0	0.0	5.0	5.0	0.0	0.0	5.0	5.0	0.0	0.0	5.0	5.0	0.0

- Or press "ENTER" to enter program setup mode The dot matrix & data displays will take you through the program setup mode step by step as below: (same as Manual program setup)
 - o Enter Age
 - o Enter Weight
 - o Enter Time

During the Program

As soon as the "ENTER" or "START" key is pressed, the Warm Up will be active. See Warm Up mode section for details.

Data Display

- When Warm Up mode is completed, this program will begin; the data display window will display the default workout data of "time, distance, calories & heart rate". Press "Select" button to switch the data displays.
- Time display will show the selected program time and count down.
- Speed display will start with speed of 2.5 mph.
- Incline display will start with incline of 0%.

Adjustment

- Press Speed "UP/DOWN" key or numeric quick key to adjust the speed any time during the program. The speed of the remaining segments will be updated to the new setting proportionally and the dot matrix window will update the speed profile accordingly as well.
- Press Incline "UP/DOWN" key or numeric quick key to adjust the incline any time during the program. The speed of the remaining segments will be updated to the new setting proportionally and the dot matrix window will update the incline profile accordingly as well.
- Press "SELECT" key next to dot matrix window to switch the profile display.

Ending the Program

- When selected program time is up, this program will end and Cool down will be active. See Cool down section for details.
- If STOP key is pressed twice during program run mode, the cool down mode will end and enter workout summary mode.
- There will be a beep sound to indicate the program ended.

Pause, Reset, Restart, or Switch the program

See Console section for details.

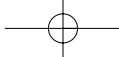

WORKOUT PROGRAMS (CONTINUED)

HILL WALK

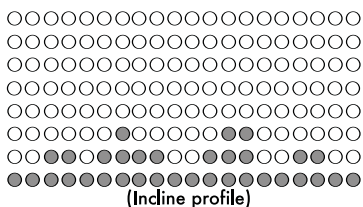

Getting Started

The Hill Walk program simulates a hill climb exercise with a preset hill profile and slow speed to walk. The exercise profile will guide you through the up hill climb or down hill glide.

Beginning the Program

During idle mode, the dot matrix window displays "DIAMONDBACK". To begin this program, press "Classic Programs" key until "Hill Walk" program LED indicator lights up.

Accepting Default values or Entering the program setting mode

When the dot matrix display shows Hill Walk program profile, it indicates you are about to select the Hill Walk program.

- Press "START" key to accept current default values and begin Hill Walk program workout.
 - o Default Time = 30 minutes
 - o Default profile = incline profile
 - o Default speed & incline:

Segment	1	2	3	4	5	6	7	8	9	10	11	12	13	14	15	16	17	18	19	20
Speed	3.0	3.0	3.0	3.0	3.0	3.0	3.0	3.0	3.0	3.0	3.0	3.0	3.0	3.0	3.0	3.0	3.0	3.0	3.0	3.0
Incline	0.0	1.0	2.0	2.5	0.5	2.0	4.0	2.5	2.0	0.0	1.0	2.5	4.0	4.5	1.0	1.0	2.5	2.0	1.0	0.5

- Or press "ENTER" to enter program setup mode The dot matrix & data displays will take you through the program setup mode step by step as below: (same as Manual program setup)
 - o Enter Age
 - o Enter Weight
 - o Enter Time

During the Program

As soon as the "ENTER" or "START" key is pressed, the Warm Up will be active. See Warm Up mode section for details.

Data Display

- When Warm Up mode is completed, this program will begin; the data display window will display the default workout data of "time, distance, calories & heart rate". Press "SELECT" button to switch the data displays.
- Time display will show the selected program time and count down.
- Speed display will start with speed of 3.0 mph.
- Incline display will start with incline of 0%.



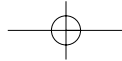

WORKOUT PROGRAMS (CONTINUED)

Adjustment

- Press Speed "UP/DOWN" key or numeric quick key to adjust the speed anytime during the program. The speed of the remaining segments will be updated to the new setting proportionally and the dot matrix window will update the speed profile accordingly as well.
- Press Incline "UP/DOWN" (key or numeric quick key) to adjust the incline anytime during the program. The incline of the remaining segments will be updated to the new setting proportionally and the dot matrix window will update the incline profile accordingly as well.
- Press "SELECT" key next to dot matrix window to switch the profile display.

Ending the Program

- When selected program time is up, this program will end and Cool down will be active. See Cool down section for details.
- If STOP key is pressed twice during program run mode, the cool down mode will end and enter workout summary mode.
- There will be a beep sound to indicate the program ended.

Pause, Reset, Restart, or Switch the program

See Console section for details.

RANDOM HILLS

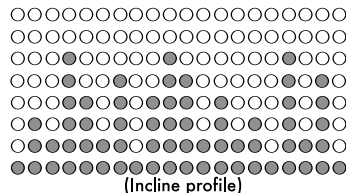

Note: Profile shown here is for reference only; computer will generate a different profile each key press

Getting Started

The Random Hills program is designed to allow the user to choose from an unlimited number of computer generated incline profiles

Beginning the Program

During idle mode, the dot matrix window displays "DIAMONDBACK". To begin this program, press "Classic Program" key until "Random Hills" program LED indicator lights up.

Accepting Default values or Entering the program setting mode

- Press "START" key to accept current default values and begin Random Hills program workout.
 - o Default Time = 30 minutes
 - o Default profile = incline profile
 - o Default speed = 2.0mph
 - o Default incline = computer generate an incline profile each time
- Or press "ENTER" to enter program setup mode The dot matrix & data displays will take you through the program setup mode step by step as below: (same as Manual program setup)
 - o Enter Age





WORKOUT PROGRAMS (CONTINUED)

- o Enter Weight
- o Enter Time

During the Program

As soon as the "ENTER" or "START" key is pressed, the Warm Up will be active. See Warm Up mode section for details.

Data Display

- When Warm Up mode is completed, this program will begin; the data display window will display the default workout data of "time, distance, calories & heart rate". Press "Select" button to switch the data displays.
- Time display will show the selected program time and count down.
- Speed display will start with speed of 2.0 mph.
- Incline display will start with 1st incline setting.

Adjustment

- Press Speed "UP/DOWN" key or numeric quick key to adjust the speed any time during the program. The speed of the remaining segments will be updated to the new setting and the dot matrix window will update the speed profile accordingly as well.
- Press Incline "UP/DOWN" key or numeric quick key to adjust the incline any time during the program. The incline of the remaining segments will be updated to the new setting proportionally and the dot matrix window will update the incline profile accordingly as well.
- Press "SELECT" key next to dot matrix window to switch the profile display.

Ending the Program

- When selected program time is up, this program will end and Cool down will be active. See Cool down section for details.
- If STOP key is pressed twice during program run mode, the cool down mode will end and enter workout summary mode.
- There will be a beep sound to indicate the program ended.

Pause, Reset, Restart, or Switch the program

See Console section for details.

EASY JOG

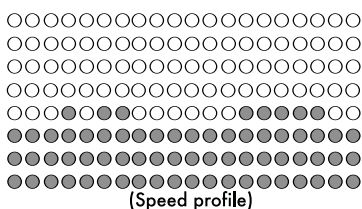

Getting Started

The Easy Jog program is designed for a beginner who just starts jogging training. It is completed with small incline and low speed throughout the program to help you getting started with jogging exercise. You can gradually increase the speed or incline over time when you are getting better and better.

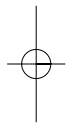



WORKOUT PROGRAMS (CONTINUED)

Beginning the Program

During idle mode, the dot matrix window displays "DIAMONDBACK". To begin this program, press "Classic Programs" key until "Easy Jog" program LED indicator lights up.

Accepting Default values or Entering the program setting mode

When the dot matrix display shows Easy Jog program profile, it indicates you are about to select the Easy Jog program:

- Press "START" key to accept current default values and begin Easy Jog program workout.
 - Default Time = 30 minutes
 - Default profile = speed profile
 - Default speed & incline

Segment	1	2	3	4	5	6	7	8	9	10	11	12	13	14	15	16	17	18	19	20
Speed	4.0	4.0	4.3	4.6	4.2	4.8	5.0	4.4	4.2	4.5	4.0	4.4	4.4	4.8	5.0	5.0	5.2	5.5	4.5	4.0
Incline	0.0	0.5	1.0	0.5	0.5	0.5	0.0	1.5	2.0	2.0	2.5	2.0	1.5	0.5	1.0	1.5	1.0	0.5	0.5	0.0

- Or press "ENTER" to enter program setup mode The dot matrix & data displays will take you through the program setup mode step by step as below: (same as Manual program setup)
 - Enter Age
 - Enter Weight
 - Enter Time

During the Program

As soon as the "ENTER" or "START" key is pressed, the Warm Up will be active. See Warm Up mode section for details.

Data Display

- When Warm Up mode is completed, this program will begin; the data display window will display the default workout data of "time, distance, calories & heart rate". Press "Select" button to switch the data displays.
- Time display will show the selected program time and count down.
- Speed display will start with speed of 4.0 mph.
- Incline display will start with incline of 0%.

Adjustment

- Press Speed "UP/DOWN" key or numeric quick key to adjust the speed any time during the program. The speed of the remaining segments will be updated to the new setting and the dot matrix window will update the speed profile accordingly as well.
- Press Incline "UP/DOWN" key or numeric quick key to adjust the incline any time during the program. The incline of the remaining segments will be updated to the new setting proportionally and the dot matrix window will update the incline profile accordingly as well.
- Press "SELECT" key next to dot matrix window to switch the profile display.

Ending the Program

- When selected program time is up, this program will end and Cool down will be active. See Cool down section for details.
- If STOP key is pressed twice during program run mode, the cool down mode will end and enter workout summary mode.

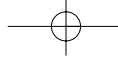

WORKOUT PROGRAMS (CONTINUED)

- There will be a beep sound to indicate the program ended.

Pause, Reset, Restart, or Switch the program
See Console section for details.



5K TRAIN & 10K RUN

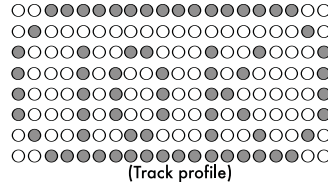
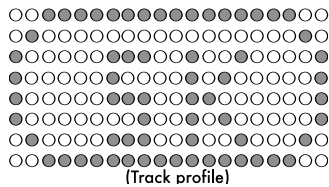

Getting Started

The 5K Train & 10K Run programs are the distance training programs. It sets the distance target to be 5000m or 10,000m and you can set up your pace by entering the time. It is very easy to see your speed improvement over time, because your time to get to 5K or 10K will be shorter and shorter.

Beginning the Program

During idle mode, the dot matrix window displays "DIAMONDBACK". To begin this program, press "Classic Programs" key until "5K Train" or "10K Run" program LED indicator lights up

Accepting Default values or Entering the program setting mode

When the dot matrix display shows 5K Train or 10K Run program profile, it indicates you are about to select the 5K Train or 10K Run program.

- Press "START" key to accept current default values and begin 5K Train or 10K Run program workout.
 - o Default Time = 1:00 (hr: min)
 - o Default profile = track profile
 - o Default incline = 0%
- Or press "ENTER" to enter program setup mode The dot matrix & data displays will take you through the program setup mode step by step as below: (same as Manual program setup)
 - o Enter Age
 - o Enter Weight
 - o Enter Time: when you adjust the time, the Speed display will calculate the average speed and display so you know how fast you have to run to get to 5K in your selected time. The speed range is 0 – 11mph.

During the Program

As soon as the "ENTER" or "START" key is pressed, the Warm Up will be active. See Warm Up mode section for details.

Data Display

- When Warm Up mode is completed, this program will begin; the data display window will display the default workout data of "time, distance, calories & heart rate". Press "Select" button to switch the data displays.



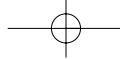

WORKOUT PROGRAMS (CONTINUED)



- Time display will show the selected program time and count down.
- Speed display will start with the calculated speed.
- Incline display will start with incline of 0%.

Dot Matrix profile display

As soon as the program run mode begin, the dot matrix profile display will display a 5K track or 10K track profile and start blinking in the smaller track. The blinking LED is showing where your position is vs. goal. Each LED blinks (Time / 32) minutes. When you completed the track, you complete a 5K or 10K course..

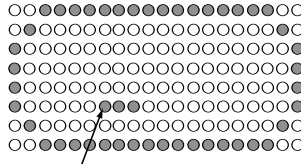

Adjustment

- Because the speed is calculated from your selected time, therefore the speed can not be adjusted during program run mode.
- Press Incline "UP/DOWN" key or numeric quick key to adjust the incline from 0 -12%. The incline display will update the current & future incline and the dot matrix window will update the incline profile if this display is selected.
- Press "SELECT" key next to dot matrix window to switch the profile display.

Ending the Program

- When selected program time is up, this program will end and Cool down will be active. See Cool down section for details.
- If STOP key is pressed twice during program run mode, the cool down mode will end and enter workout summary mode.
- There will be a beep sound to indicate the program ended.

Pause, Reset, Restart, or Switch the program

See Console section for details.

THIGH BURNER

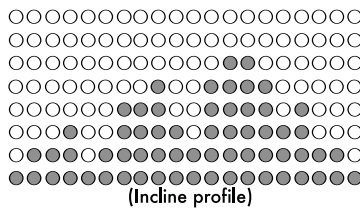

Getting Started

The program is designed to tone your Thighs & Glutes; it includes a series of up hill climbing exercises and a preset incline profile. Workout on this program often, you will see the result in no time

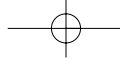

WORKOUT PROGRAMS (CONTINUED)

Beginning the Program

During idle mode, the dot matrix window displays "DIAMONDBACK". To begin this program, press "Classic Programs" key until "Thigh Burner" program LED indicator lights up.

Accepting Default values or Entering the program setting mode

When the dot matrix display shows Thigh Burner program profile, it indicates you are about to select the Thigh Burner program:

- Press "START" key to accept current default values and begin Thigh Burner program workout.
 - Default Time = 30 minutes
 - Default profile = incline profile
 - Default speed & incline:

Segment	1	2	3	4	5	6	7	8	9	10	11	12	13	14	15	16	17	18	19	20
Speed	3.0	3.0	3.0	3.0	3.0	3.0	3.0	3.0	3.0	3.0	3.0	3.0	3.0	3.0	3.0	3.0	3.0	3.0	3.0	3.0
Incline	1.0	3.0	2.5	4.5	1.5	3.5	6.0	7.0	8.5	4.0	2.5	8.5	10.0	10.5	8.0	4.5	6.5	2.0	3.0	0.5

- Or press "ENTER" to enter program setup mode The dot matrix & data displays will take you through the program setup mode step by step as below: (same as Manual program setup)
 - Enter Age
 - Enter Weight
 - Enter Time

During the Program

As soon as the "ENTER" or "START" key is pressed, the Warm Up will be active. See Warm Up mode section for details.

Data Display

- When Warm Up mode is completed, this program will begin; the data display window will display the default workout data of "time, distance, calories & heart rate". Press "Select" button to switch the data displays.
- Time display will show the selected program time and count down.
- Speed display will start with speed of 4.0 mph.
- Incline display will start with incline of 0%.

Adjustment

- Press Speed "UP/DOWN" key or numeric quick key to adjust the speed any time during the program. The speed of the remaining segments will be updated to the new setting and the dot matrix window will update the speed profile accordingly as well.
- Press Incline "UP/DOWN" key or numeric quick key to adjust the incline any time during the program. The incline of the remaining segments will be updated to the new setting proportionally and the dot matrix window will update the incline profile accordingly as well.
- Press "SELECT" key next to dot matrix window to switch the profile display.

Ending the Program

- When selected program time is up, this program will end and Cool down will be active. See Cool down section for details.
- If STOP key is pressed twice during program run mode, the cool down mode





WORKOUT PROGRAMS (CONTINUED)



HR Interactive Programs

- will end and enter workout summary mode.
- There will be a beep sound to indicate the program ended.

Pause, Reset, Restart, or Switch the program
See Console section for details.

H R I N T E R A C T I V E P R O G R A M S

Dot matrix display during HR Interactive programs – The dot matrix display will display program % Max HR profile, not speed profile. The row of target % Max HR LEDs will light up to indicate your goal; then the current segment LEDs will light up and blink to show your actual heart rate. You could compare your actual heart rate against your goal while exercising.

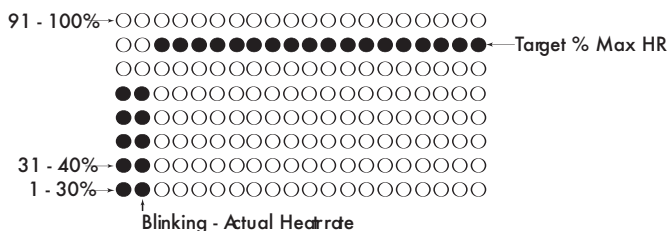

TARGET HR

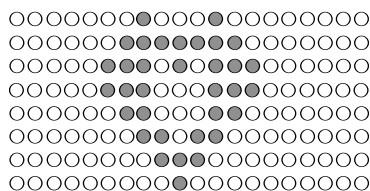

Getting Started

The Target Heart Rate program is designed to keep you training at your chosen heart rate level. Computer will adjust the speed automatically to ensure the target heart rate is achieved and maintained during the entire program.

A HEART RATE MONITORING DEVICE MUST BE USED FOR THIS PROGRAM. FOR BETTER RESULTS, A CHEST STRAP IS RECOMMENDED FOR THIS OPERATION.

IMPORTANT: It is unsafe to exceed 95% of your maximum heart rate while exercising. Please consult your physician before performing any Heart Rate based training program.

Beginning the Program

During idle mode, the dot matrix window displays "DIAMONDBACK". To begin this program, press "HR Interactive" key until "Target HR" program LED indicator lights up.



WORKOUT PROGRAMS (CONTINUED)

Accepting Default values or Entering the program setting mode

When the dot matrix display shows Target HR program profile, it indicates you are about to select the Target HR program:

- Press "START" key to accept current default values and begin Target HR program workout.
 - Default Time = 30 minutes
 - Default Target HR = 70% of your max HR
 - Default profile = % max HR profile

- Or press "ENTER" to enter program setup mode The dot matrix & data displays will take you through the program setup mode step by step as below:
 - Enter Age
 - Enter Weight
 - Enter Time
 - Enter Heart Rate
 1. If Enter key is pressed after time adjustment, the dot matrix window will flash "HR".
 2. The Heart Rate display will display & blink the default target, calculated from 70%.
 3. You may press Speed or Incline "UP/DOWN" key or numeric quick key to adjust the target HR up to 85% of Max HR.
 4. After HR adjustment, press "ENTER" or "START" to accept and begin this program.

(Note: you may press START key anytime to skip the setup and begin the workout immediately.)

During the Program

As soon as the "ENTER" or "START" key is pressed, the Warm Up will be active. See Warm Up mode section for details.

Data Display

- When Warm Up mode is completed, this program will begin; the data display window will display the default workout data of "time, distance, calories & heart rate". Press "Select" button to switch the data displays.
- Time display will show the selected program time and count down.
- Incline display will start with incline of 0%.
- Heart Rate display:
 - If there is no pulse input, the Heart rate data display will show "--" and blink. If there continues to be no pulse input, this console will maintain its current resistance setting and not changing until the program ends or is changed.
 - If there is a valid pulse, the Heart rate display will show the actual pulse reading.

Adjustment

- Computer will adjust the speed to achieve your Heart rate goal; therefore speed can not be adjusted during program run mode. Press Speed "UP/DOWN" key will adjust the target HR goal.
- The numeric quick key can not be used to adjust the target HR setting during program run mode.
- Press Incline "UP/DOWN" key to adjust the incline from 0 -12%. The incline display will update the current & future incline and the dot matrix window will update the incline profile if this display is selected.



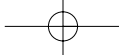

WORKOUT PROGRAMS (CONTINUED)



- Press "SELECT" key next to dot matrix window to switch the profile display.

Ending the Program

- When selected program time is up, this program will end and Cool down will be active. See Cool down section for details.
- If STOP key is pressed twice during program run mode, the cool down mode will end and enter workout summary mode.
- There will be a beep sound to indicate the program ended.

Pause, Reset, Restart, or Switch the program

See Console section for details.

HR INTERVALS

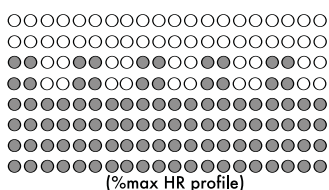

Getting Started

The Heart Rate Intervals program is designed to alternate periods of hard work (Work phase) with periods of easy work (Rest phase). The console will adjust the resistance level up to meet your Work heart rate goal and adjust it down to recover. This phase changes every 2 segments to best condition your cardiovascular system.

A HEART RATE MONITORING DEVICE MUST BE USED FOR THIS PROGRAM. FOR BETTER RESULTS, A CHEST STRAP IS RECOMMENDED FOR THIS OPERATION.

IMPORTANT: It is unsafe to exceed 95% of your maximum heart rate while exercising. Please consult your physician before performing any Heart Rate based training program.

Beginning the Program

During idle mode, the dot matrix window displays "DIAMONDBACK". To begin this program, press "HR Interactive" key until "HR Intervals" program LED indicator lights up.

Accepting Default values or Entering the program setting mode

When the dot matrix display shows HR Interval program profile, it indicates you are about to select the HR Intervals program:

- Press "START" key to accept current default values and begin HR Intervals program workout.
 - o Default Time = 30 minutes
 - o Default Target HR = 80% of your max HR. Rest HR = 65% of max HR
 - o Default profile = % max HR profile
- Or press "ENTER" to enter program setup mode The dot matrix & data displays will take you through the program setup mode step by step as below:
 - o Enter Age





WORKOUT PROGRAMS (CONTINUED)

- o Enter Weight
- o Enter Time
- o Enter Work HR
 1. If "ENTER" key is pressed after time adjustment, the Work HR setting columns of dot matrix window will blink.
 2. The Heart rate display will display & blink the default Work HR.
 3. You may press Speed or Incline "UP/DOWN" key or numeric quick key to adjust the Work HR from "65% to "90% of Max HR".
 4. After Work HR adjustment, press "ENTER" or "START" to accept and begin this program
- o Enter Rest HR
 1. If "ENTER" key is pressed after Work HR adjustment, the Rest HR setting columns of dot matrix window will blink.
 2. The Heart rate display will display & blink the default Rest HR.
 3. You may press Speed or Incline "UP/DOWN" key or numeric quick key to adjust the Rest HR from 80bpm up to the Work HR setting.
 4. After Rest HR adjustment, press "ENTER" to accept and begin this program.

(Note: you may press START key anytime to skip the setup and begin the workout immediately.)

During the Program

As soon as the "ENTER" or "START" key is pressed, the Warm Up will be active. See Warm Up mode section for details.

Data Display

- When Warm Up mode is completed, this program will begin; the data display window will display the default workout data of "time, distance, calories & heart rate". Press "Select" button to switch the data displays.
- Time display will show the selected program time and count down.
- Incline display will start with incline of 0%.
- Heart Rate display:
 - o If there is no pulse input, the Heart rate data display will show " - - " and blink. If there continues to be no pulse input, this console will maintain its current resistance setting and not changing until the program ends or is changed.
 - o If there is a valid pulse, the Heart rate display will show the actual pulse reading.

Adjustment

- Computer will adjust the speed to achieve your Heart rate goal; therefore speed can not be adjusted during program run mode.
- Press Speed "UP/DOWN" key will adjust the target HR goal.
 - o Press Speed "UP/DOWN" key during Rest HR segment to adjust the Rest HR setting of the remaining program. The Pulse window will blink the Rest HR setting and adjust. Until the adjustment is done, it then will resume to display actual HR. Dot matrix window will update the Rest %Max HR profile accordingly.
 - o Press Speed "UP/DOWN" key during Work HR segment to adjust the Work HR setting of the remaining program. The Pulse window will blink the Work HR setting and adjust. Until the adjustment is done, it then will resume to display actual HR. Dot matrix window will update the Work %Max HR





WORKOUT PROGRAMS (CONTINUED)

profile accordingly.

- The numeric quick key can not be used to adjust the target HR setting during program run mode.
- Press Incline "UP/DOWN" key to adjust the incline from 0 -1.5%. The incline display will update the current & future incline and the dot matrix window will update the incline profile if this display is selected.
- Press "SELECT" key next to dot matrix window to switch the profile display.

Ending the Program

- When selected program time is up, this program will end and Cool down will be active. See Cool down section for details.
- If STOP key is pressed twice during program run mode, the cool down mode will end and enter workout summary mode.
- There will be a beep sound to indicate the program ended.

Pause, Reset, Restart, or Switch the program

See Console section for details.

HR HILL

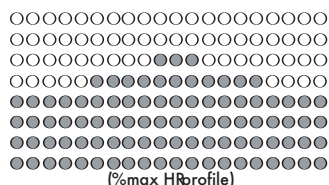

Getting Started

The HR Hill program is based on a percentage (%) of your maximum heart rate (220 minus your age). Within each training zone subtle physiological effects take place to enhance your fitness status.

- The energy efficient or Recovery zone – 60% to 70%
Training within this zone develops basic endurance and aerobic capacity.
- The Aerobic zone – 70% to 80%
Training within this zone to develop your cardiovascular system.
- The Anaerobic zone – 80% to 90%
Training within this zone will develop your lactic acid system.

A HEART RATE MONITORING DEVICE MUST BE USED FOR THIS PROGRAM. FOR BETTER RESULTS, A CHEST STRAP IS RECOMMENDED FOR THIS OPERATION.

IMPORTANT: It is unsafe to exceed 95% of your maximum heart rate while exercising. Please consult your physician before performing any Heart Rate based training program.

Beginning the Program

During idle mode, the dot matrix window displays "DIAMONDBACK". To begin this program, press "HR Interactive" key until "HR Hill" program LED indicator lights up.





WORKOUT PROGRAMS (CONTINUED)

Accepting Default values or Entering the program setting mode

When the dot matrix display shows HR Hill program profile, it indicates you are about to select the HR Hill program:

- Press "START" key to accept current default values and begin HR Hill program workout.
 - Default Time = 30 minutes
 - Default profile = % max HR profile
 - Default target HR:

Segment	1	2	3	4	5	6	7	8	9	10	11	12	13	14	15	16	17	18	19	20
% Max HR	65	65	65	70	70	75	75	75	75	82	82	82	75	75	75	75	70	70	65	65

- Or press "ENTER" to enter program setup mode The dot matrix & data displays will take you through the program setup mode step by step as below:
 - Enter Age
 - Enter Weight
 - Enter Time

(Note: you may press START key anytime to skip the setup and begin the workout immediately.)

During the Program

Data Display

- When Warm Up mode is completed, this program will begin; the data display window will display the default workout data of "time, calories & heart rate". Press "Select" button to switch the data displays.
- Time display will show the selected program time and count down.
- Incline display will start with incline of 0%.
- Heart Rate display:
 - If there is no pulse input, the Heart rate data display will show "--" and blink. If there continues to be no pulse input, this console will maintain its current resistance setting and not changing until the program ends or is changed.
 - If there is a valid pulse, the Heart rate display will show the actual pulse reading.

Adjustment

- Computer will adjust the speed to achieve your Heart rate goal; therefore speed can not be adjusted during program run mode. Press Speed "UP/DOWN" key will adjust the current & future target HR goal proportionally. The dot matrix profile will update the profile accordingly.
- The numeric quick key can not be used to adjust the target HR setting during program run mode.
- Press Incline "UP/DOWN" key to adjust the incline from 0 -12%. The incline display will update the current & future incline and the dot matrix window will update the incline profile if this display is selected.
- Press "SELECT" key next to dot matrix window to switch the profile display.

Ending the Program

- When selected program time is up, this program will end and Cool down will be active. See Cool down section for details.

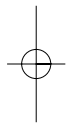



WORKOUT PROGRAMS (CONTINUED)

- If STOP key is pressed twice during program run mode, the cool down mode will end and enter workout summary mode.
- There will be a beep sound to indicate the program ended.

Pause, Reset, Restart, or Switch the program
See Console section for details..

CARDIO TRAINING

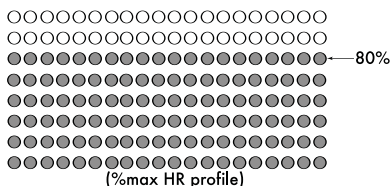

Getting Started

The Cardio Training program is designed to keep your heart rate at your anaerobic stage. The heart rate is maintained at 80% of Max heart rate to develop your lactic acid system and build your strength most effectively.

A HEART RATE MONITORING DEVICE MUST BE USED FOR THIS PROGRAM. FOR BETTER RESULTS, A CHEST STRAP IS RECOMMENDED FOR THIS OPERATION.

IMPORTANT: It is unsafe to exceed 95% of your maximum heart rate while exercising. Please consult your physician before performing any Heart Rate based training program.

Beginning the Program

During idle mode, the dot matrix window displays "DIAMONDBACK". To begin this program, press "HR Interactive" key until "Cardio Training" program LED indicator lights up.

Accepting Default values or Entering the program setting mode

When the dot matrix display shows cardio Training program profile, it indicates you are about to select the Cardio Training program:

- Press "START" key to accept current default values and begin Cardio Training program workout.
 - o Default Time = 30 minutes
 - o Default Target HR = 80% of your max HR
 - o Default profile = % max HR profile
- Or press "ENTER" to enter program setup mode The dot matrix & data displays will take you through the program setup mode step by step as below:
 - o Enter Age
 - o Enter Weight
 - o Enter Time

(Note: you may press START key anytime to skip the setup and begin the workout immediately.)



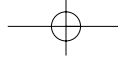

WORKOUT PROGRAMS (CONTINUED)

During the Program

As soon as the "ENTER" or "START" key is pressed, the Warm Up will be active. See Warm Up mode section for details.

Data Display

- When Warm Up mode is completed, this program will begin; the data display window will display the default workout data of "time, calories & heart rate". Press "Select" button to switch the data displays.
- Time display will show the selected program time and count down.
- Incline display will start with incline of 0%.
- Heart Rate display:
 - If there is no pulse input, the Heart rate data display will show "--" and blink. If there continues to be no pulse input, this console will maintain its current resistance setting and not changing until the program ends or is changed.
 - If there is a valid pulse, the Heart rate display will show the actual pulse reading.

Adjustment

- Computer will adjust the speed to achieve your Heart rate goal; therefore speed can not be adjusted during program run mode. Press Speed "UP/DOWN" key will adjust the current & future target HR goal.
- The numeric quick key can not be used to adjust the target HR setting during program run mode.
- Press Incline "UP/DOWN" key to adjust the incline from 0 -12%. The incline display will update the current & future incline and the dot matrix window will update the incline profile if this display is selected.
- Press "SELECT" key next to dot matrix window to switch the profile display.

Ending the Program

- When selected program time is up, this program will end and Cool down will be active. See Cool down section for details.
- If STOP key is pressed twice during program run mode, the cool down mode will end and enter workout summary mode.
- There will be a beep sound to indicate the program ended.

Pause, Reset, Restart, or Switch the program

See Console section for details.

CUSTOM PROGRAMS 1, 2, 3 & 4

Getting Started

These programs are designed to be user-friendly tools. You can build your own programs and save them for later workout. With this function, you will be able to call up your favorite program, which stores all of your accurate user information, and begin your exercise right away.

Save a program into Custom programs

To save your favorite program into Custom program during Cool Down and Workout summary, first to select a Custom program number you want to save your favorite pro-



Custom Programs



WORKOUT PROGRAMS (CONTINUED)

gram. Second, press the "Custom Programs" key and hold the key when the right Custom Program number LED indicator lights up for 2 seconds. There will be 2 beeps to indicate that your program has been saved.

- Following information of this program will be saved:
 - Age & Weight
 - Program time
 - Speed, Incline, profile
 - HR setting if it is a HR Interactive program
- If there was a program saved in this Custom program before, the new program will overwrite the previous program.

Selecting Custom Program and Beginning the Program

To select a User program, press "Custom Program" key until the right custom program number is highlighted. Press "ENTER" to confirm your entry.

- If there was no saved program, the dot matrix display will scroll, "NO PROGRAM" and wait for an instruction.
- If there was a saved program, the dot matrix will display the program profile.
- Press "ENTER" or "START" key to accept current default values and begin program workout.

During the Program

Once ENTER or START key is pressed, the Warm Up will be active. See Warm Up mode section for details.

Data Display

When warm up is completed, the console will start program run mode.

Adjustment:

It depends on the saved program; see the each program section for details.

Ending the Program

- When selected program time is up, this program will end and Cool down will be active. See Cool down section for details.
- If STOP key is pressed twice during program run mode, the cool down mode will end and enter workout summary mode.
- There will be a beep sound to indicate the program ended.

Pause, Reset, Restart, or Switch the program

See Console section for details..

DOMESTIC WARRANTY INFORMATION

(Applies to all product sold and placed within the continental US, Alaska, Hawaii, and Puerto Rico only)



Effective: August 2006

Diamondback warrants its 600Tm Treadmill to be free from defects in material and workmanship under normal use in the home and light instructional environments. Diamondback's obligation under this Warranty is limited to repair or replacement of any defective part without charge through an authorized service agent to the original purchaser with the following parameters:

Who is covered:

The Warranty is extended to the individual or legal entity whose name appears on the Warranty registration card filed with Diamondback and may not be transferred to any other individual or legal entity.

To obtain service:

To obtain service you must contact your authorized Diamondback Fitness dealer. Your dealer is also your authorized service agent. An authorized service agent must diagnose your unit in order to determine Warranty claims/issues.

Sales where the unit is delivered unassembled (in a carton) to the end user (e.g. mail order or Internet sales) without a service contract purchased through the dealer voids the Warranty.

Warranty Registration:

Warranty commitments are valid only with a completed Warranty card that is returned within 15 days from the date of purchase and includes the product serial number. Registration is available at www.diamondbackfitness.com.

Proof of purchase from Diamondback's authorized dealer will be required if the Warranty card is not registered prior to any consideration of Warranty claim.

WHAT IS COVERED

Home:

Frame:	Lifetime limited Warranty, covers defects in welds, materials, and workmanship.
Drive Motor:	Lifetime limited warranty
Parts & Electronics:	3 years
Normal Wear Items:	90-day limited on foam grips, etc.



DOMESTIC WARRANTY INFORMATION (CONTINUED)

Warranty voided if:

The Warranty does not apply to any failure of the product, or any parts of the product, due to: assembly errors, alterations, modifications, misuse, abuse, accident, improper maintenance, or if the serial number on the product has been removed, altered or defaced. Assembly errors include but are not limited to:

Damaged wire harness.
Bolts used in the wrong location.

Parts & Service:

Contact the authorized Diamondback dealer where unit as originally purchased. If you have moved, or that retailer is unavailable, use our dealer locator at www.diamondbackfitness.com to help find another authorized dealer.

Diamondback is not responsible for arranging Warranty service and/or honoring extended warranties provided by dealers.

Exclusions:

Warranty is void if the 600Tm model unit is placed in a commercial or light commercial environment, such as health club, school, or correctional facility.

Additional Rights:

This Warranty is expressly in lieu of all other warranties, and any implied warranties of merchantability or fitness for a particular purpose created hereby, are limited to the same duration as the express Warranty herein. Diamondback Fitness, Inc. shall not be liable for any incidental or consequential damages. Some states do not allow the exclusion or limitations of implied warranties, incidental or consequential, so the above limitations and exclusions may not apply to you.

Retailers and wholesale outlets for Diamondback Fitness, Inc. products are not authorized to modify this Warranty in any way.

This Warranty gives the original owner specific legal rights. Other additional rights may vary from state to state.

Diamondback Fitness, Inc

300 Camarillo Ranch Road
Camarillo, CA 93012

800-776-7642

MAINTENANCE

CAUTION – FOR SAFE OPERATION

Always inspect hardware prior to any exercise session. Turn power switch to the "OFF" position and unplug electrical cord from the outlet before attempting maintenance. Inspect unit for loose parts and frayed wires. Repair or replace any damaged or worn parts, tighten all loose hardware as necessary.

After training, always wipe down your treadmill. Perspiration that continuously settles on frame, pads or casing may eventually cause rust or damage to the unit. Damage resulting from lack of proper maintenance will not be covered under warranty.

A proper maintenance will extend the life and ensure a better performance of the treadmill. Below you will find our recommendations for the maintenance of your treadmill:

Overall Cleaning

Use a damp cloth to clean outer surface and console of the treadmill. **DO NOT USE PETROLEUM BASED PRODUCTS TO CLEAN ANY PART OF THE TREADMILL.** Use a clean, lint free, cloth to occasionally clean the deck surface.

Belt/Deck Maintenance

Lubrication to the deck is very important to your treadmill. It will reduce the wear of the deck and maintain the smooth running surface. Although this treadmill has been pre-lubed at the factory but periodic lubrication is still necessary. It is difficult to predict exactly when the belt will need lubrication, one of the most common symptoms is a hesitation or pause of the belt when you set your foot. Here are some of the tips for deck lubrication:

- Wipe entire deck surface with a clean, lint free cloth.
- Lubricate deck with the Diamondback Lubrication Kit (which can be purchased through your Diamondback Dealer.)
- Follow the instructions as specified in the Lubrication Kit.
- Lubricate your treadmill approximately every 6 months of normal use.

Belt Adjustment

Proper belt adjustment is important for smooth and safe operation of the treadmill. If the belt is too loose, you will feel a slight hesitation each time you take a step. (If this symptom occurs, first turn the treadmill off and try lubricating the deck/belt – see Belt/Deck Maintenance.)

The adjustment screws must be tightened evenly in order to adjust the belt properly. The adjustment screws are located at the rear of the treadmill in the end caps.



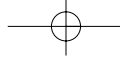

MAINTENANCE (CONTINUED)



1/4 Turn each time on
both sides

Both adjustment screws should be tightened 1/4 turn in a clockwise direction with a wrench and the belt checked for slipping after each adjustment. If the belt continues to slip, repeat this process until the belt stops slipping. Make sure to only turn the adjustment screws 1/4 turn each time until the slipping stops. This will insure that you do not over-tighten the rollers. Over-tighten the rollers may cause serious damage to the treadmill.

If the belt tracks too close to one side, loosen the adjustment screw on the opposite side, turning it counterclockwise 1/4 turn. Restart the treadmill and run it at 5 mph/8 kph for 1 to 2 minutes to insure the belt will stay in the center. Repeat the procedure if necessary.

If noises develop or malfunctions occur, contact your authorized Diamondback fitness dealer.



WARRANTY CARD



Important! • Important! • Important! • Important! • Important! • Important!

Warranty card must be completed and returned to Diamondback within 15 days of purchase. Failure to comply may void manufacturer's Warranty. Or, you may register your product at www.diamondbackfitness.com.

Your Name: _____

Address: _____

City: _____ State: _____ Zip: _____

Daytime phone No.: _____ Evening phone No.: _____

Dealer Store Name: _____ Address: _____

City: _____ State: _____ Zip: _____

Model: _____ Serial No.: _____

Purchase Date: _____

Environment Unit Placed:

- Home
- Light Institutional, i.e. Hotel, Business Center...

Mail completed form to:

Diamondback Fitness - Warranty Card

300 Camarillo Ranch Road

Camarillo, CA 93012

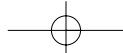

Please refer to www.diamondbackfitness.com for instructions in French.
Svp référez-vous www.diamondbackfitness.com pour instructions en français.

www.diamondbackfitness.com



Diamondback Fitness
300 Camarillo Ranch Road
Camarillo, CA 93012
T 800-776-7642
F 805-388-5890

well equipped for success

Part no. 22-96-909



Free Manuals Download Website

<http://myh66.com>

<http://usermanuals.us>

<http://www.somanuals.com>

<http://www.4manuals.cc>

<http://www.manual-lib.com>

<http://www.404manual.com>

<http://www.luxmanual.com>

<http://aubethermostatmanual.com>

Golf course search by state

<http://golfingnear.com>

Email search by domain

<http://emailbydomain.com>

Auto manuals search

<http://auto.somanuals.com>

TV manuals search

<http://tv.somanuals.com>