

ePowerSwitch

(iSWITCH)

User's Manual



20020925 Rev4

Table of Contents

Warnings	3
Quick Install Procedure	4
Introduction	7
Remote Power Manager (iSwitch) Features	7
iSwitch Package	7
Setup Procedure	8
1. Setup via the USB Port	8
2. Setup via the Serial Port	18
3. Setup via the Ethernet Port	25
Telnet Configuration	26
Web-Based Configuration	31
Firmware Upgrade Procedures	39
Telephone Access Interface	44
Daisy Chaining	45
Troubleshooting	46
Appendix	47
1. Communities	47
2. Gateways	47
3. IP Address	47
4. Subnetting and Subnet Masks	47
Glossary	49
Obtaining Technical Assistance	50
Limited Product Warranty	51

NOTICE: This equipment has been tested and found to comply with the limits for a "Class B digital device, pursuant to Part 15 of the FCC rules. These limits are designed to provide reasonable protection against harmful interference when the equipment is operated in a commercial environment. This equipment generates, uses and can radiate radio frequency energy and if not installed and used in accordance with the instruction manual, may cause interference to radio communications. Operation of this equipment in a residential area is likely to cause harmful interference, in which case the user will be required to correct the interference at the user's own expense.

This digital apparatus does not exceed the "Class B" limits for radio noise emissions from digital apparatus set out in the Radio interference regulations of the Canadian Department of Communications.

Trademarks

Remote Power Manager (ePowerSwitch) is a trademark of DigiPower Manufacturing, Inc.
IBM, IBM NetView/6000 are trademarks or registered trademarks of International Business Machines Corp.
Hewlett-Packard, HP, HP Open View are trademarks or registered trademarks of Hewlett-Packard Company.
Microsoft, MS, MS-DOS, XENIX are registered trademarks and Windows, Windows NT, LAN Manager, and Win32 are trademarks of Microsoft Corporation.
NT is a trademark of Northern Telecom Limited.
Novell and NetWare are registered trademarks, and NLM is a trademark of Novell, Inc.
SunConnect SunNet is a trademark or registered trademark of Sun Microsystems Computer Corporation.
Xerox is a registered trademark of the Xerox Corporation.

Conventions Used In This Guide

This guide uses these conventions:

Bold italic print, as shown in this example, indicates field names, menu items, or values in the Computer Interface Card (CIC) software agent.

Bold print, as shown in this example, indicates filenames, directories, or items that you must type exactly as they appear.

Italic print words or letters in braces { } indicate values that you must supply. For example: *{drive}:\setup*

Italic print words or letters in brackets < > indicate keys to press. If two keys are separated by a + plus symbol, then the first key should be pressed and held down while pressing the second key. For example: *<alt+enter>*.

Note: **Notes contrast from the text to emphasize their importance.**

Warning: **These messages alert you to specific procedures or practices; serious consequences may result including injury if you disregard them.**

Quick Install Procedure

This section will guide you through the quick installation of the iSwitch.

1. Install mounting brackets: page 4.
2. Install all input and output connections: pages 5 and 6.
3. Program you IP address: page 9.
For USB setup:
 - a) Insert Driver Setup Diskette in floppy drive.
 - b) Run Setup.exe from floppy drive.
 - c) Program IP address per Page 15.
 - d) Program Subnet mask per Page 15.
 - e) Program Default Route per Page 15.
 - f) Program DNS Server per Page 15.
 - g) Note: Default user name is: admin.
 - h) Note: Default password is admin.

At this point the unit is operational: Review the (section Quick Install) pages 4-7 to become familiar with the general functions. Review the entire User's Manual in detail for more in-depth functions.

4. Set iSwitch's front control buttons for Internet/remote
5. Use browser to monitor and control.
6. Note: Smart phone default password must include # as last character
7. For NT shutdown setup, use control panel / UPS configure.
 - a) RJ11 connections on the rear panel are disconnected if they contain a plug in the housing.

The iSwitch comes with brackets for mounting in a standard 19-inch rack. To mount the iSwitch into a rack perform the following procedure:

1. Attach the mounting brackets to the unit as shown, using the four retaining screws provided for each of the brackets.

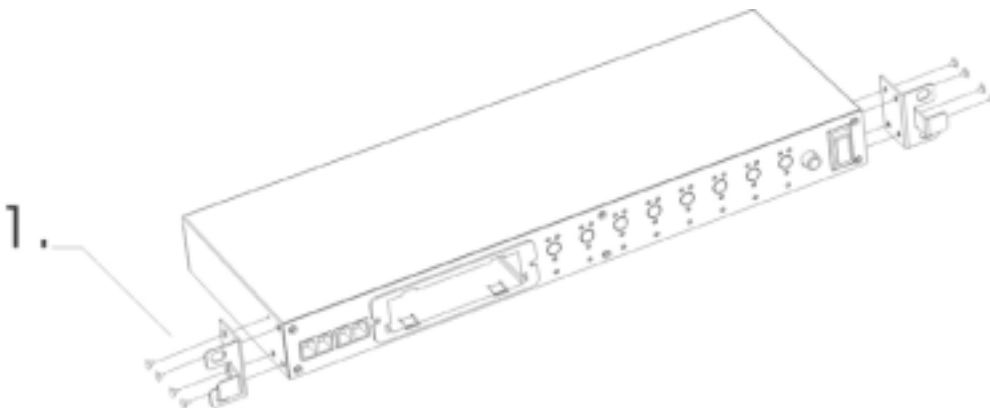

2. Choose a location for the brackets. A notched hole on the vertical rail denotes the middle of a U slot.
3. Align the mounting holes of brackets with the notched hole on the vertical rail and attach with the retaining screws.

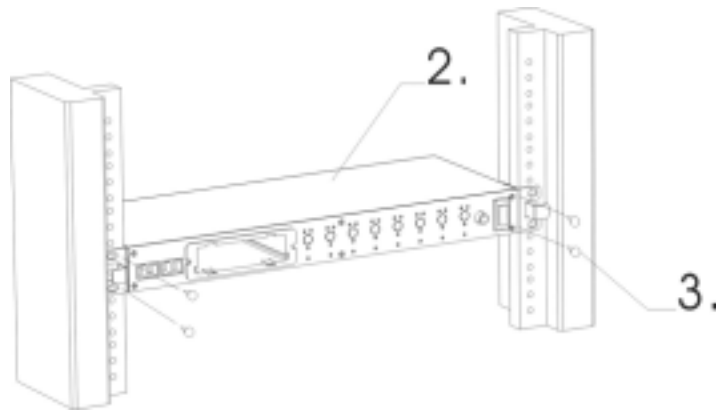

iSwitch-Front Panel

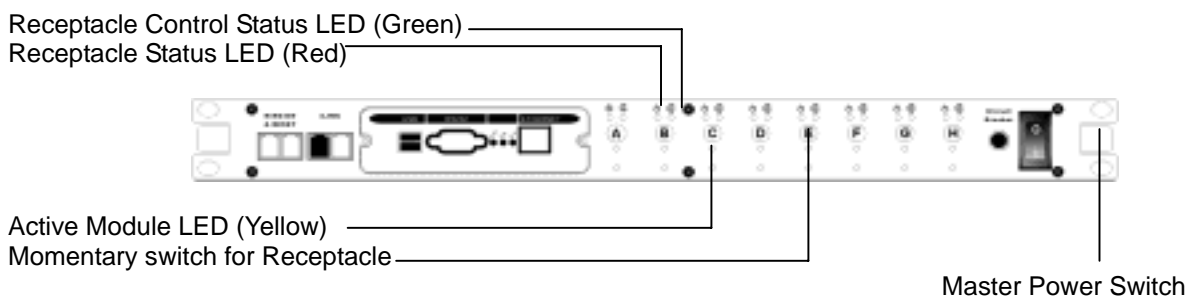
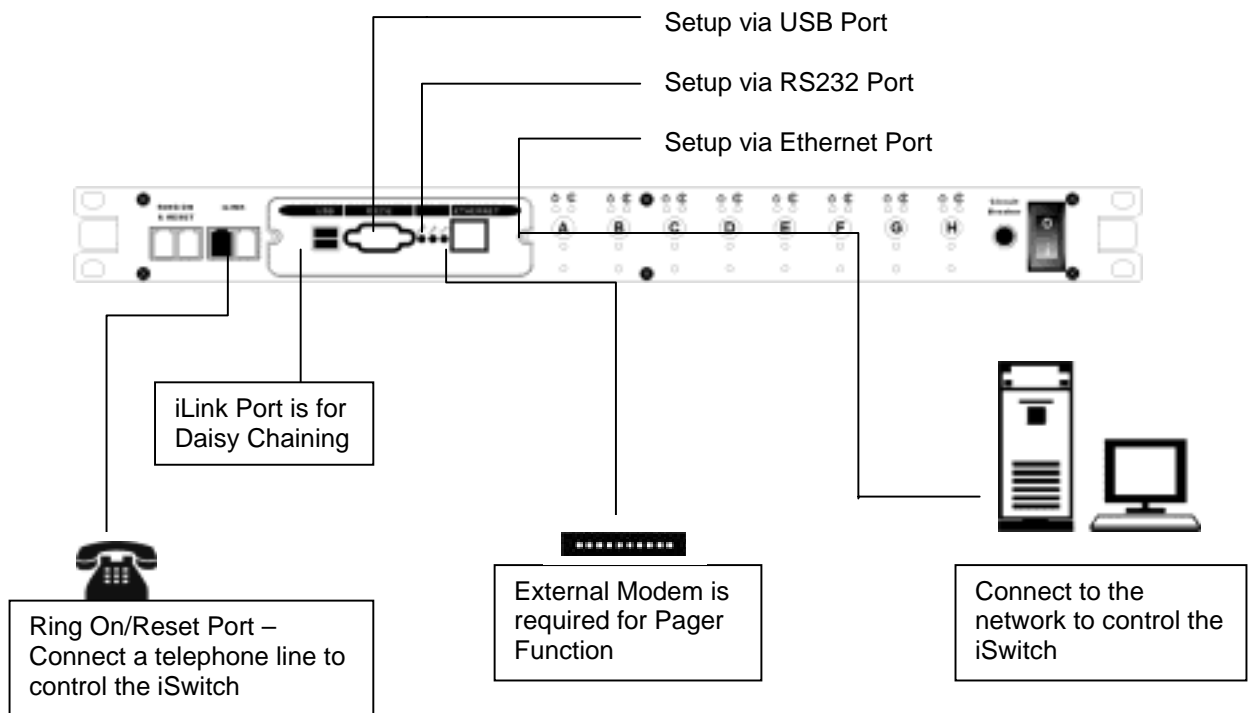

Receptacle Status LED (Red): When the LED is illuminated the receptacle is on and providing AC Power. When the LED is off the receptacle is not providing AC Power.

Receptacle Control Status LED (Green): When the control LED is illuminated, the momentary switch is disabled and the output receptacle is programmed for remote control. When the LED is off, the momentary switch is active and the receptacle may be turned on or off by pressing and releasing the switch. Pressing and holding the momentary switch for three seconds will change the state from remote to local control.

Active Module LED (Yellow): When illuminated this LED indicates which module or client is currently being accessed via remote control.

Momentary switch for receptacle control: Pressing and holding the momentary switch for three seconds will change the state from remote to local control. Pressing and holding the momentary switch for one second will change the state from on to off or from off to on.

iSwitch-Rear Panel

NT SERVER PORTS A-H: Provides controlled shutdown for NT server. Port A controls receptacle A; Port B controls receptacle B, etc. (optional)

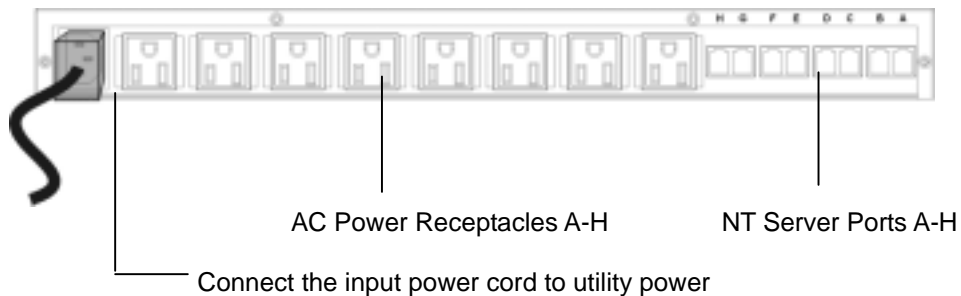

Program your iSwitch's IP address per USB, RS232 or Ethernet.

The preferred method for programming is the USB method. For USB setup procedure see page 9. Please note: this method requires Windows 98 or higher.

The next method is the RS232 Serial Port Setup. For RS232 / serial port setup procedure see page 19.

The last method is the Ethernet Port Setup. For Ethernet / network setup procedure see page 27.



The Remote Power Manager (iSwitch) is a network-manageable, intelligent power control unit designed to provide control of power for up to eight electrical devices.

NOTE: If the iSwitch is turned off by the master power switch, you have to wait approximately thirty seconds before restarting the iSwitch to allow the iSwitch to internally reset.

iSwitch Features

Internet ready — Individually control each of the eight AC receptacles by using a Web Browser.

Remotely and individually reboot locked up servers.

If the network locks up, you can use the telephone to control the iSwitch to shutdown or to reboot locked up devices or servers.

Sequentially apply power to the equipment that is plugged into the iSwitch.

Multiple OS support—As long as there is Network Management software present.

Remote setup support— Once an IP address is assigned, the rest can be setup remotely through telnet commands.

USB port setup—In addition to the regular serial port setup, this adapter also has a USB setup feature for initial setup of this card. (Requires Windows 98 or higher)

Remote Control—Turns each of the AC receptacles on/off when the NMS sends the proper command.

Remote Firmware upgrade support - The Remote Power Manager supports firmware upgrade through TFTP server remotely. A serial upgrade method is available too.

iSwitch Package

The standard iSwitch package contains a Remote Power Manager Unit with supporting hardware and software. The components of your package are:

1. Remote Power Manager Unit
2. Rack mount Brackets
3. AC Power Cord
4. USB Cable
5. DB9 Female-to-Female Serial Cable
6. RJ-11 to RS232 NT Server Cable
7. RJ-11 Cascade Cable (RS485)
8. 3.5" Diskette (includes USB device driver, USB setup software, and the User's Manual)



Figure 1- ePowerSwitch Unit

Setup Procedure

This section describes the setup procedures of the iSwitch when you connect it to the network.

NOTE: The minimum requirement to operate the iSwitch is to set the IP address.

There are four different ways to setup the iSwitch.

1. Setup the IP Address via the USB port (software included). **Requires Windows 98 or higher.**
2. Setup the IP Address via the Serial port using Hyper Terminal. **Requires Hyper Terminal version 3.0 or higher.**
3. Setup the IP Address via the Ethernet Port by using the ARP command (first time only), then use the Web Configuration to finish the setup.
4. Setup the IP Address via the Ethernet Port by using the ARP command (first time only), then use the Telnet Configuration to finish the setup.

Setup via the USB Port (Requires Windows 98 or higher)

The following items must be obtained before attempting to setup the iSwitch: A valid IP Address, a USB Cable (provided), the USB Driver/USB setup file (enclosed diskette) and a PC with Windows 98 or higher.

1. Connect one end of the USB Cable to the USB Port on the computer.
2. Connect the other end of the USB Cable to the USB Port on the iSwitch.
3. Turn the computer on and let it boot-up.
4. Insert the floppy diskette with the USB Driver/USB setup files into the appropriate drive.
5. Plug the iSwitch's power cord into the wall outlet.
6. Turn on the iSwitch.
7. Windows will display the following message (first time only):

New Hardware Found

USB Device

Windows has found new hardware and is locating the drivers for it.

8. The Hardware wizard will guide you through installing the USB Driver. Click Next.



9. Hardware wizard will search for the best USB Driver. Click Next.



10. Check, Specify a location. Click Browse.



11. Open the appropriate 3½" Floppy Drive. Open the USB folder. Open the Driver folder. Click OK.

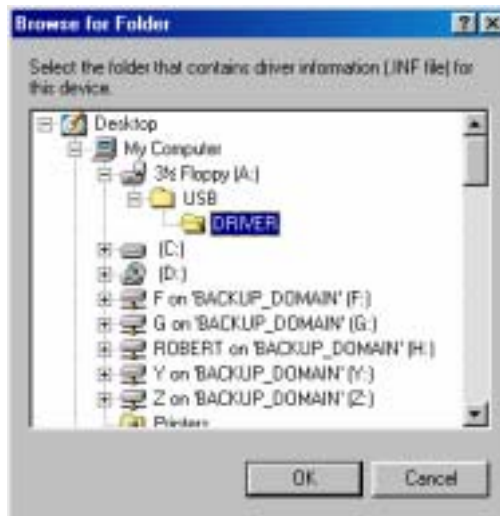

12. Windows will search for the new USB Driver. Click Next.



13. Windows has found the USB Driver for the USB device. Click Next.



14. Windows has found the best Driver for this USB device. Click Next.



15. Windows is copying the USB Driver files to your "C:" drive. Click Next



16. Windows is finished installing the USB Driver. Click Finish. To your "C:" drive. Click Next



17. On the Desktop, right click "My Computer". Open Properties.

18. Open the Device Manager. Wait for approximately 30 seconds for the "Human Interface Device" to appear. Open the Human Interface Device. Click on "Usb-interface power device". Click OK.

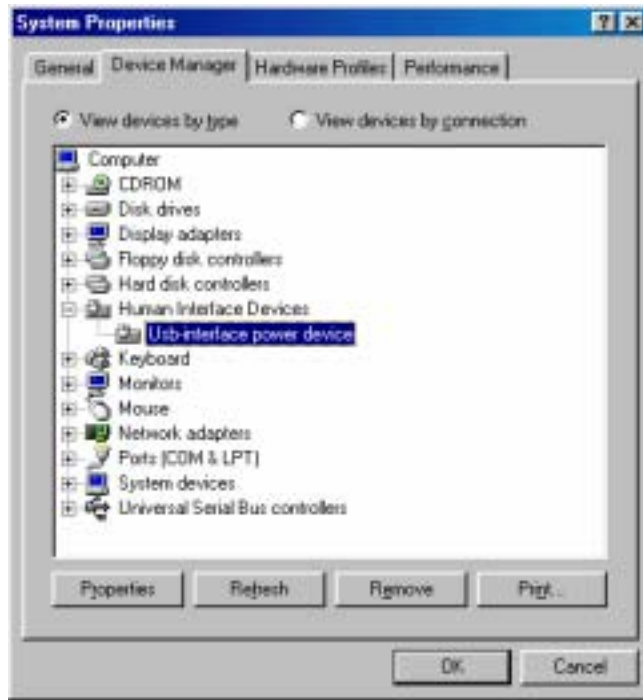

19. Open Windows Explorer. Open the appropriate 3½" Floppy Drive. Open the USB folder. Open USBSetup.exe. **Note:** The USB setup icon must be green before you can run the USB setup program.

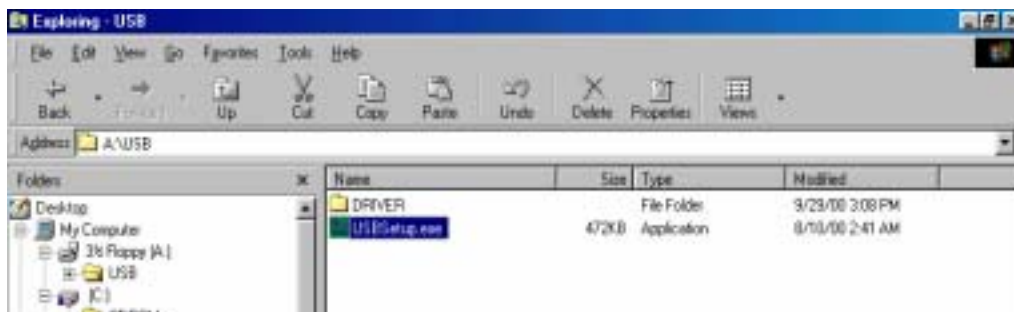

20. The Power Device Configuration tool is loading



21. This is the Power Device Configuration Tool screen. On the Toolbar open Configuration. Then open System.



22. This is the System Parameter Configuration screen fill in all the information: the IP Address, the Subnet Mask, the Default Route (Gateway) and the DNS Server. Use the Tab key to move from one field to the next field. Then click OK.

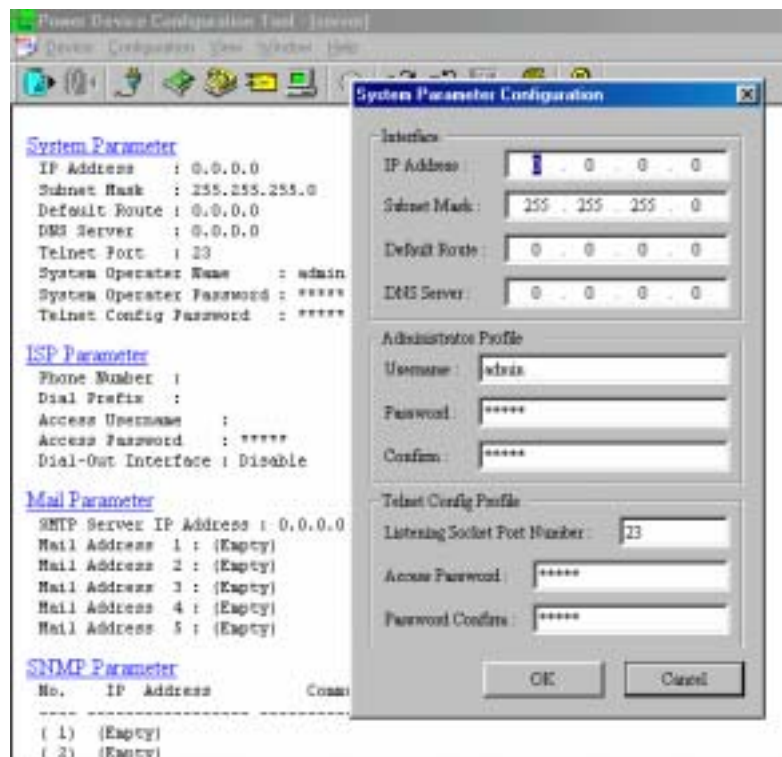

23. This is the Power Device Configuration Tool screen. After you have entered in all of the pertinent information, you have to **Update and Restart** to save all the information that was entered into the System Parameter Configuration screen. The Update and Restart icon (with the red arrow) is right beneath the "Device" drop down menu.



24. Enter the Supervisor Name and the Supervisor Password. The Default Supervisor Name and the Supervisor Password is **admin** (lower case). Then click OK



25. This is the Power Device Configuration screen. Click Yes to Update the Power Device.

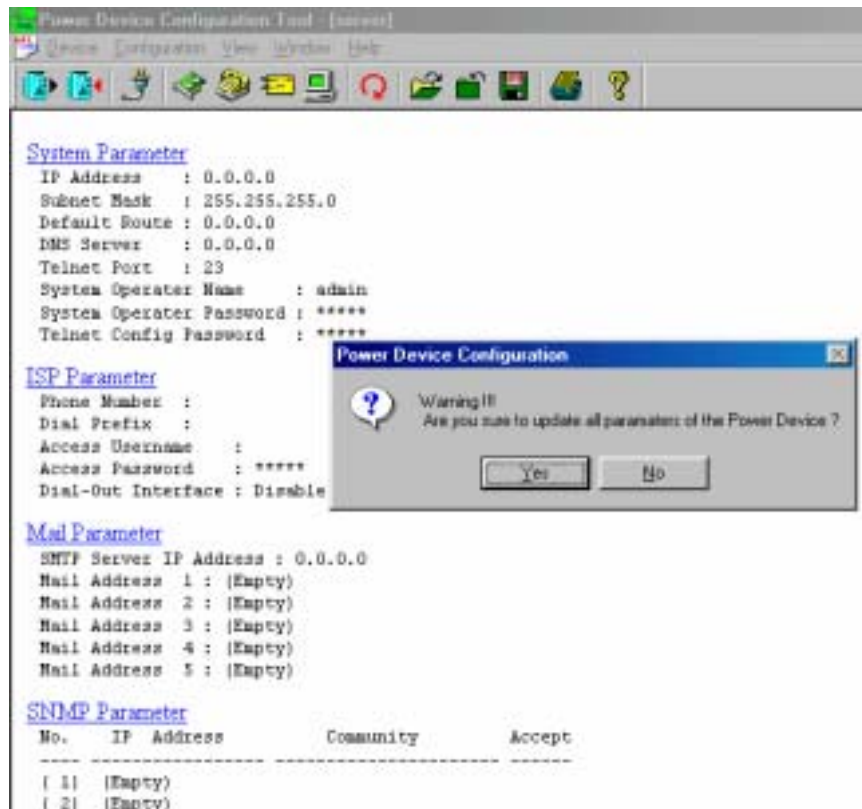

26. This is the Device Parameter Transmitting screen. The Power Device is being Updated.

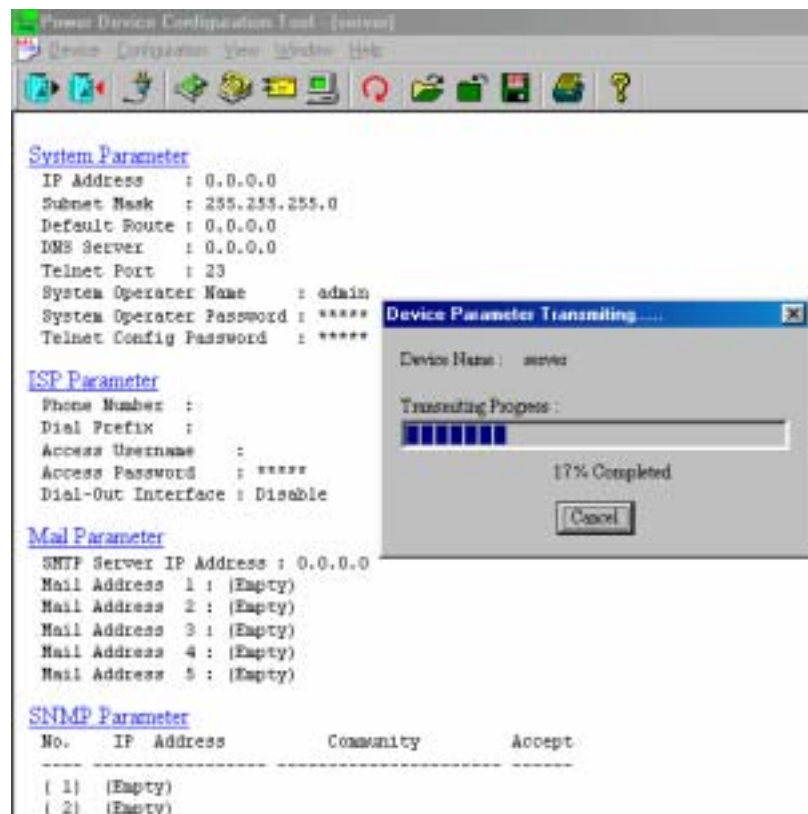

27. The Power Device has been successfully updated. Click OK.

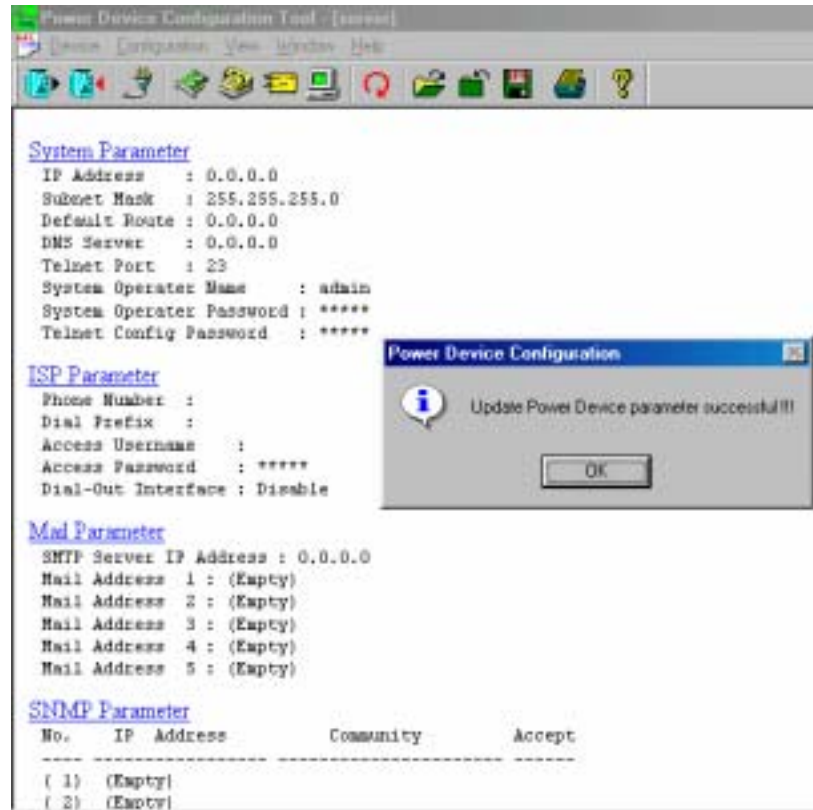

28. The Power Device has to be Restarted. Click Yes.

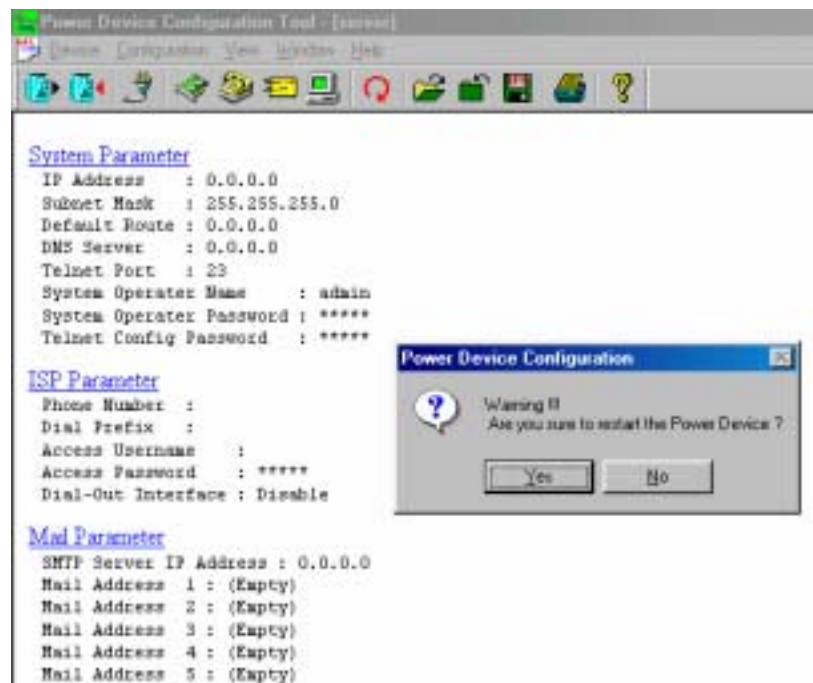

29. The USB Setup Procedure is complete. The iSwitch is fully operational. Unplug the USB Cable from the

iSwitch and from the computer. Plug the Ethernet Cable into the iSwitch and after about thirty seconds the Link LED will start blinking, now you can communicate with the iSwitch. The Ping command is supported at this time. Startup a Browser and type in the IP Address. The default password is **admin** (lower case). Go to the section in the User's Manual titled "Web-Based Configuration" it will guide you through the Web pages.

Setup via the Serial Port

NOTE: When using Hyper Terminal use Version 3.0 or higher.

The following items must be obtained before attempting to setup the iSwitch: A valid IP Address, a DB9 female-to-female Serial Cable (provided). There are a wide variety of Terminal Emulation packages, but for the most part they should be very similar. The following setup procedure is using Hyper Terminal.

1. Connect one end of the DB9 female-to-female Cable to the Serial port on the computer.
2. Connect the other end of the DB9 female-to-female cable to the Serial port on the iSwitch.
3. Turn the computer on and let it boot-up.
4. From the Desktop open the Start menu. Pick Programs, Accessories, Communications and Hyper Terminal. Open Hyper Terminal (requires version 3.0 or higher).
5. Open HYPERTRM.EXE.
6. Enter a name (iSwitch). Click OK.



7. Connect using the appropriate Com port. Click OK



8. Configure the port settings. Bits per second: "115200", Data bits: "8", Parity: "None", Stop bits: "1", Flow control: "None". Click OK



9. On the Toolbar open the File menu, and then open Properties.

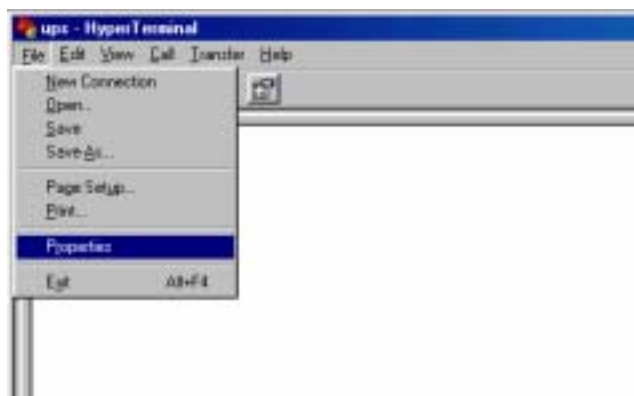

- Open the Settings Tab. Function, arrow and ctrl keys act as: Terminal Keys, Backspace key sends: Ctrl+H, Emulation: VT100, Telnet terminal: VT100, Backscroll buffer lines: 500. Click OK.

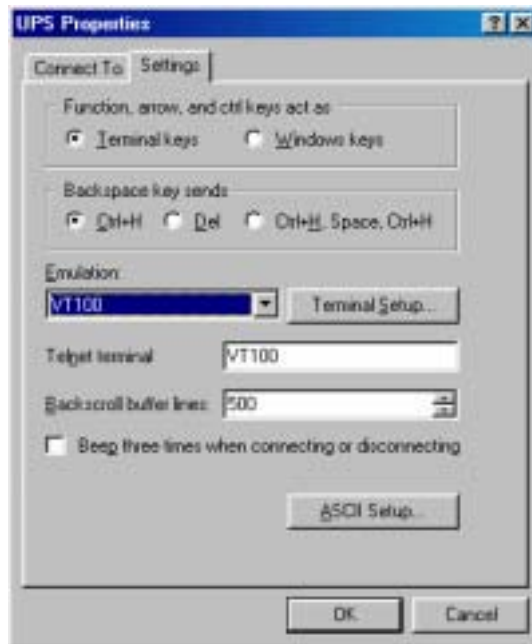

- Plug the iSwitch's power cord into the AC outlet and turn the iSwitch on.

- When the message "Press '/' key within 5 seconds to enter console configuration" appears press the forward slash key (/) within the 5 seconds or the iSwitch will time out and then you have to start over.

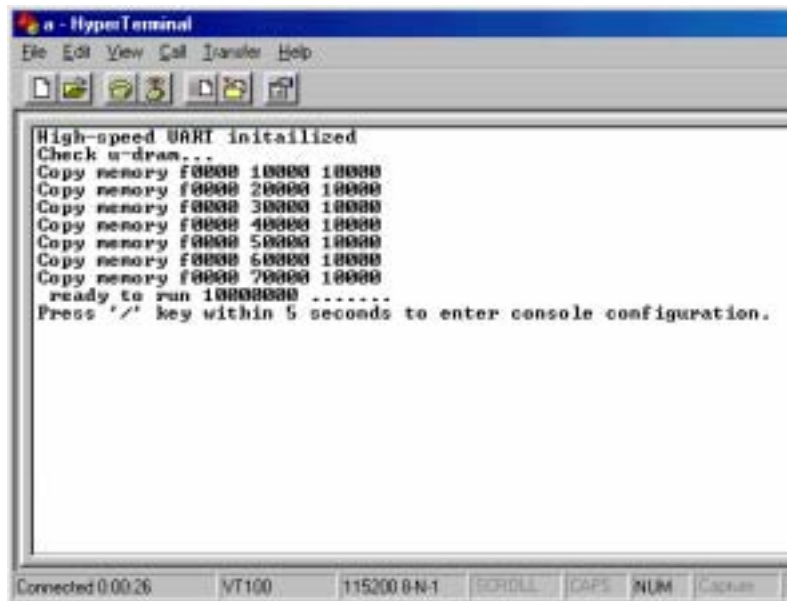

- Next you will be asked for the User Password. The default password is **admin**. Enter the password, then hit enter.

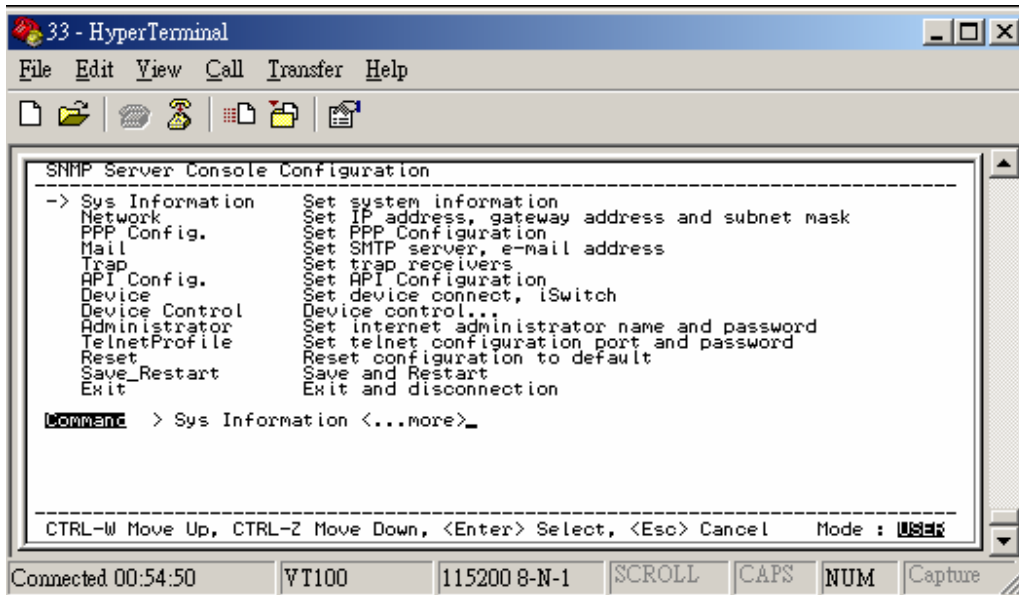

14. Ctrl-Z moves the cursor down and Ctrl-W moves the cursor up. Pick Network, then hit enter.

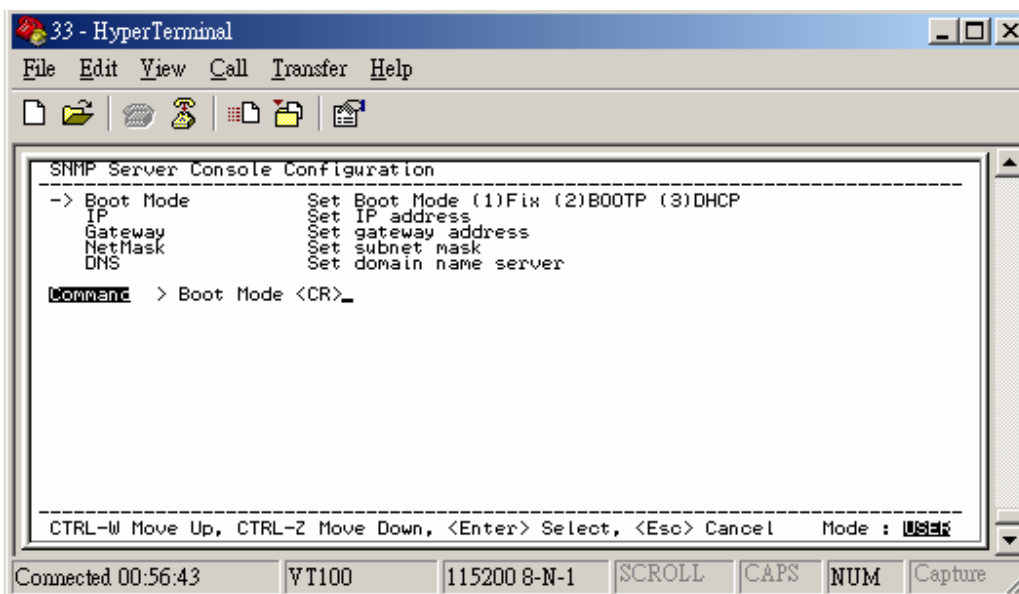

15. Enter in the IP Address, the Gateway Address, the Subnet Mask and the DNS (all required). Hit the "Escape" key to return to the main menu.

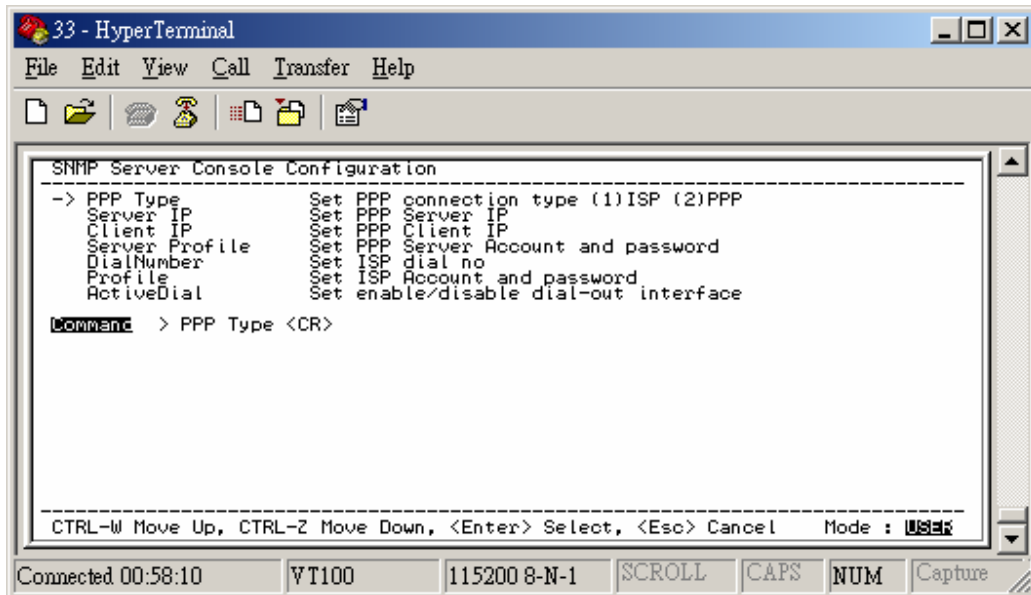

- Arrow down to PPP Config and hit enter. Enter in the ISP dial number, the ISP account/password and the enable/disable dial-out interface (not required). Hit the "Escape" key to return to the main menu.

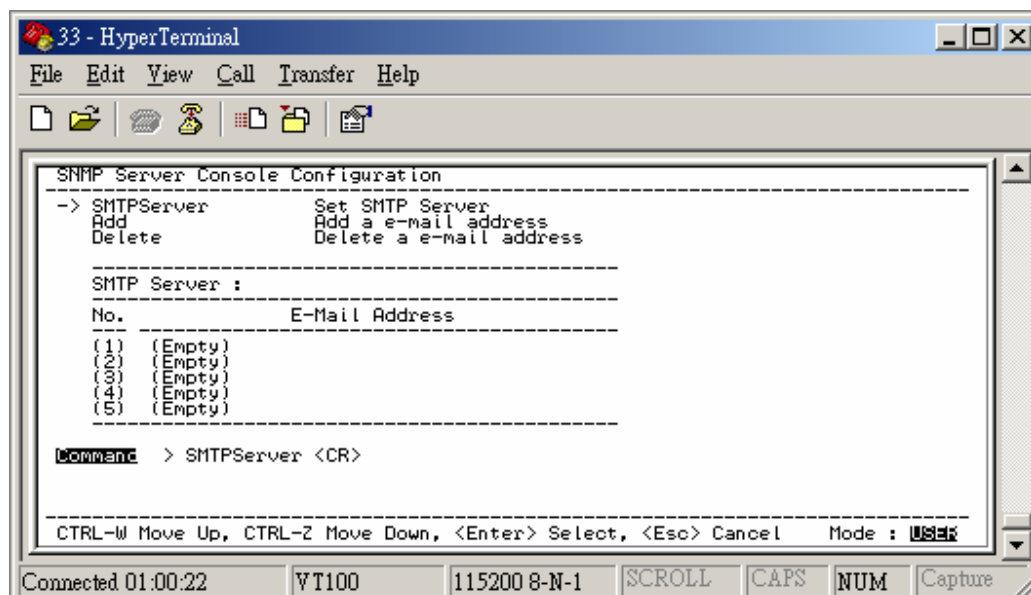

- Arrow down to Mail and hit enter. Enter in the SMTP Server (not required). The user can add or delete email addresses. Hit the "Escape" key to return to the main menu.

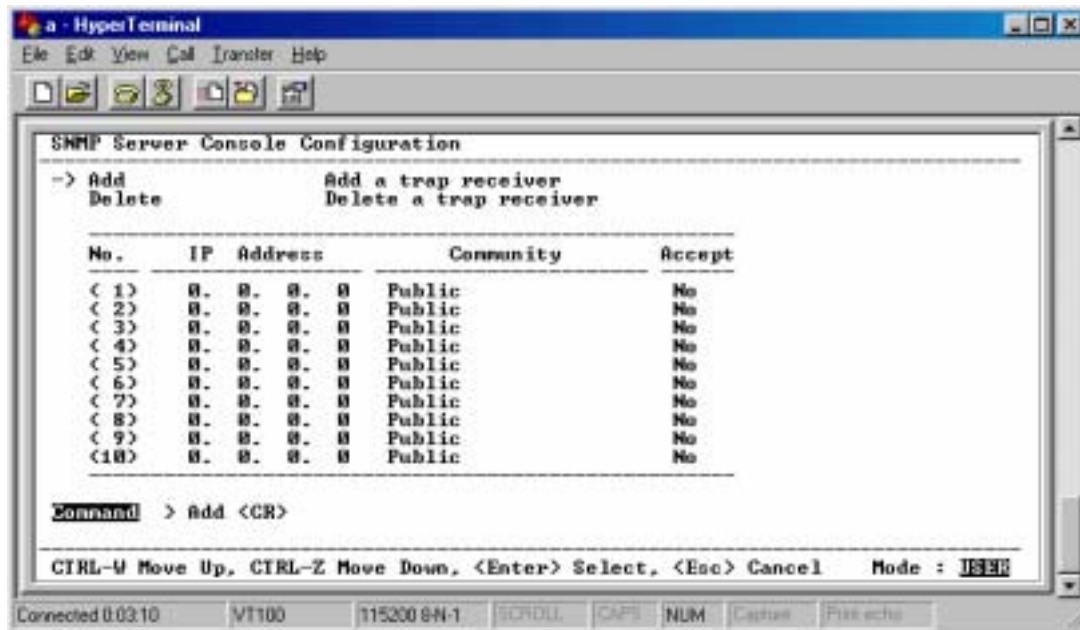

18. Arrow down to Trap and hit enter. This screen allows the user to send Traps about the UPS to ten IP Addresses (not required). Also, you may determine the severity levels and what type of access, read only or read and write, to assign to a particular IP manager. Hit the "Escape" key to return to the main menu.

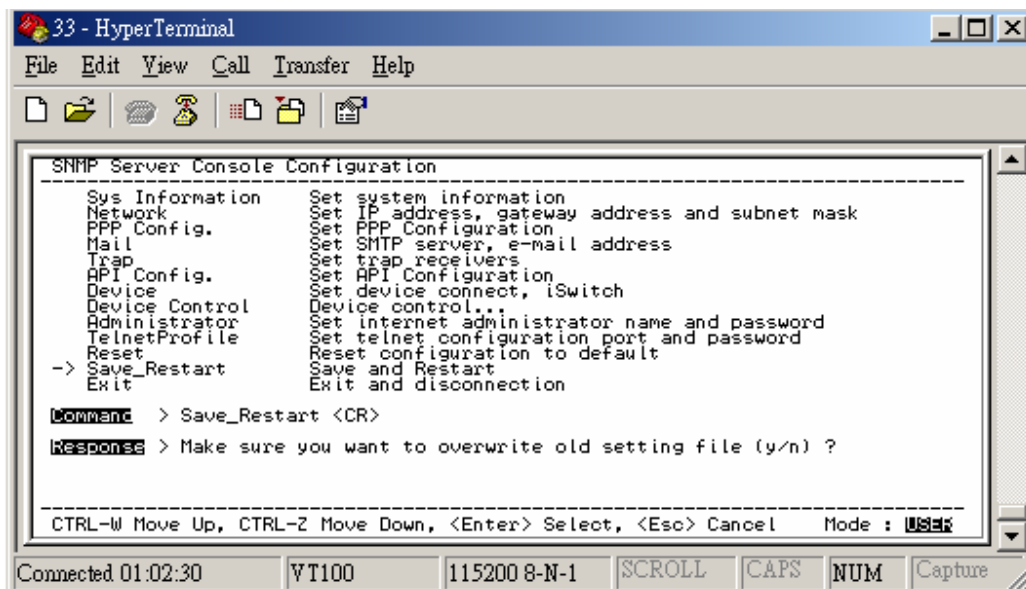

19. Once you have finished with the entire configuration, cursor down to Save_Restart and hit enter. Make sure you want to overwrite the old settings (y/n)? Hit the y key, then hit enter.

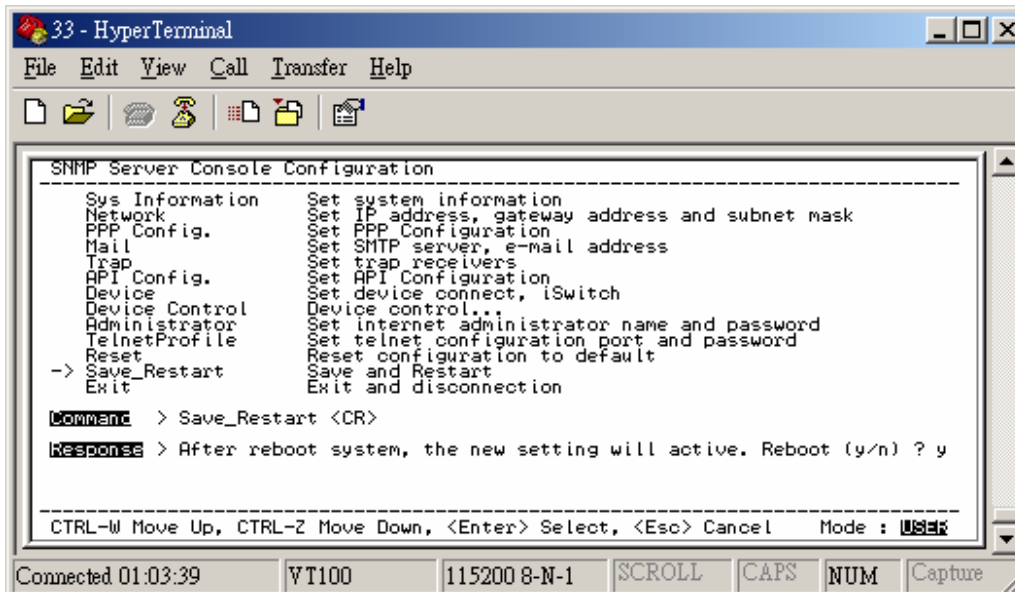

20. After rebooting the system, the new settings will be activated. Reboot (y/n)? Hit the y key then hit enter. Once the system has rebooted, cursor down to Exit then hit enter.
21. The Serial Setup Procedure is complete. The iSwitch is fully operational. Unplug the DB9 female-to-female Serial Cable from the iSwitch and from the computer. Plug the Ethernet Cable into the iSwitch and after about thirty seconds the Link LED will start blinking, now you can communicate with the iSwitch. The Ping command is supported at this time. Startup a Browser and type in the IP Address. The default password is **admin** (lower case). Go to the section in the User's Manual titled "Web-Based Configuration" it will guide you through the Web pages.
22. All functions description please refer to Page 30.

Setup via the Ethernet Port

The following items must be obtained before attempting to setup the iSwitch: A valid IP Address, a Computer on the network and an Ethernet cable connected to the network.

1. Connect the Ethernet cable to the iSwitch's Ethernet Port.
2. Turn the computer on and let it boot-up.
3. Plug the iSwitch's power cord into the AC outlet and turn the iSwitch on.
4. Wait for approximately thirty seconds for the Link LED to start blinking.
5. From the Desktop open the Start menu. Pick Programs and then open the MS-DOS Prompt.

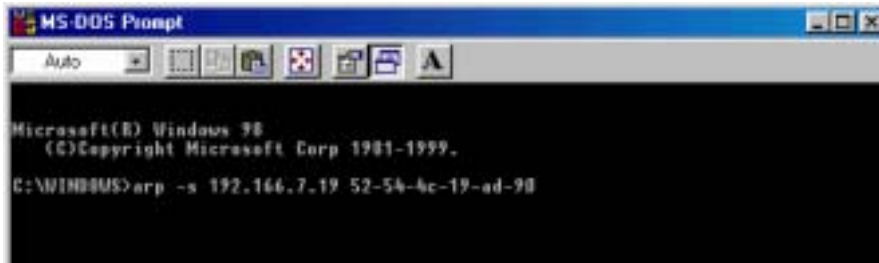

```
MS-DOS Prompt
Auto
Microsoft(R) Windows 98
(C)Copyright Microsoft Corp 1981-1999.
C:\WINDOWS>arp -s 192.166.7.19 52-54-4c-19-ad-90
```

6. This is an example. At the MS-DOS Prompt type: `arp -s 192.166.7.19 52-54-4c-19-ad-90`. Then hit enter. The first string is the IP Address; the second string is the MAC Address (which can be found on the front of the iSwitch).

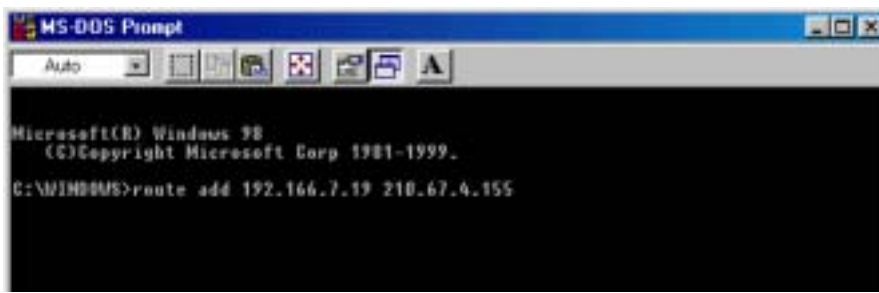

```
MS-DOS Prompt
Auto
Microsoft(R) Windows 98
(C)Copyright Microsoft Corp 1981-1999.
C:\WINDOWS>route add 192.166.7.19 210.67.4.155
```

7. At the MS-DOS prompt type: `route add 192.166.7.19 210.67.4.155`. Then hit enter. The first string is the IP Address and the second string is the Gateway Address.
NOTE: The PING Command is not supported at this time.
8. At the MS-DOS Prompt type `exit`. Then hit enter.
9. There are two options to finish setting up all of the parameters. Option #1 The Web-Based Configuration, Option #2 Telnet.
10. Option #1. Startup a Browser and type in the IP Address. The default name and password is **admin** (lower case). Go to the section in the User's Manual titled "Web-Based Configuration" it will guide you through the setup of all the parameters.
11. Option #2. Go to the section in the User's Manual titled "Telnet Configuration" it will guide you through the setup of all the parameters.

Telnet Configuration

This section will guide you through finishing the configuration of the iSwitch using Telnet.

NOTE: You must complete the appropriate Setup Procedure before proceeding with the Telnet Configuration.

NOTE: You must have given the iSwitch an IP Address.

NOTE: The connection by telnet client limits only 2 users.

NOTE: Telnet client connects to CIC card will be timeout over 75 sec.

The Ethernet cable is connected to the iSwitch and the iSwitch is on.

1. From the Desktop open the Start menu. Pick Programs and then open the MS-DOS Prompt.

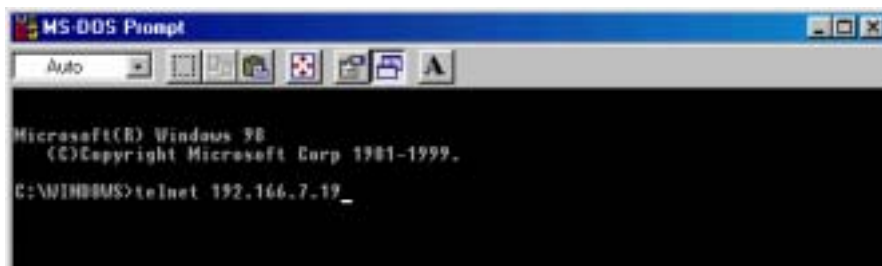

2. This is an example. At the MS-DOS Prompt type telnet 192.166.7.19 (IP Address). Then hit enter.
3. Next you will be asked for the User Password. The default password is **admin**. Enter the password, then hit enter.

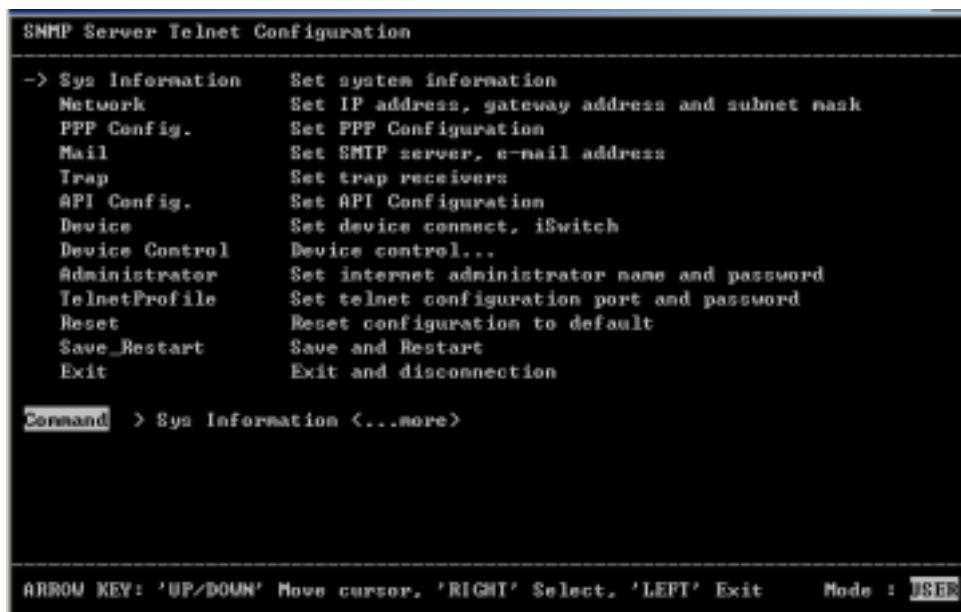

- Pick Network, then hit enter.

```
SNMP Server Telnet Configuration
-----
-> Boot Mode          Set Boot Mode (1)Fix (2)BOOTP (3)DHCP
   IP                 Set IP address
   Gateway            Set gateway address
   NetMask            Set subnet mask
   DNS                Set domain name server

Command > Boot Mode <CR>_

ARROW KEY: 'UP/DOWN' Move cursor, 'RIGHT' Select, 'LEFT' Exit      Mode : USER
```

- Pick IP, then hit enter. Input your IP Address, Gateway Address, Subnet Mask and the DNS (all required). Then hit the left arrow key to exit to the main menu.

```
SNMP Server Telnet Configuration
-----
-> PPP Type           Set PPP connection type (1)ISP (2)PPP
   Server IP         Set PPP Server IP
   Client IP         Set PPP Client IP
   Server Profile    Set PPP Server Account and password
   DialNumber        Set ISP dial no
   Profile           Set ISP Account and password
   ActiveDial        Set enable/disable dial-out interface

Command > PPP Type <CR>_

ARROW KEY: 'UP/DOWN' Move cursor, 'RIGHT' Select, 'LEFT' Exit      Mode : USER
```

- Arrow down to PPP Config and hit enter. Enter in the ISP dial number, the ISP account/password and the enable/disable dial-out interface (not required). Hit the left arrow key to return to the main menu.

```

SNMP Server Telnet Configuration
-----
-> SMTPServer      Set SMTP Server
  Add              Add a e-mail address
  Delete           Delete a e-mail address

-----
SMTP Server :
-----
No.      E-Mail Address
-----
<1> <Empty>
<2> <Empty>
<3> <Empty>
<4> <Empty>
<5> <Empty>
-----

Command > SMTPServer <CR>_

-----
ARROW KEY: 'UP/DOWN' Move cursor, 'RIGHT' Select, 'LEFT' Exit      Mode : USER

```

- Arrow down to Mail and hit enter. Enter in the SMTP Server (not required). The user can add or delete email addresses. Hit the left arrow key to return to the main menu.

```

SNMP Server Telnet Configuration
-----
-> Add              Add a trap receiver
  Delete           Delete a trap receiver

-----
No.  IP Address      Community      Accept
-----
< 1> 0. 0. 0. 0      Public         No
< 2> 0. 0. 0. 0      Public         No
< 3> 0. 0. 0. 0      Public         No
< 4> 0. 0. 0. 0      Public         No
< 5> 0. 0. 0. 0      Public         No
< 6> 0. 0. 0. 0      Public         No
< 7> 0. 0. 0. 0      Public         No
< 8> 0. 0. 0. 0      Public         No
< 9> 0. 0. 0. 0      Public         No
<10> 0. 0. 0. 0      Public         No
-----

Command > Add <CR>_

-----
ARROW KEY: 'UP/DOWN' Move cursor, 'RIGHT' Select, 'LEFT' Exit      Mode : USER

```

- Arrow down to Trap and hit enter. This screen allows the user to send Traps about the iSwitch to ten IP Addresses (not required). Also, you may determine the severity levels and what type of access, read only or

read and write, to assign to a particular IP manager. Hit the left arrow key to return to the main menu.

```
SNMP Server Telnet Configuration
-----
Sys Information      Set system information
Network             Set IP address, gateway address and subnet mask
PPP Config.         Set PPP Configuration
Mail                Set SMTP server, e-mail address
Trap               Set trap receivers
API Config.         Set API Configuration
Device             Set device connect, iSwitch
Device Control      Device control...
Administrator       Set internet administrator name and password
TelnetProfile       Set telnet configuration port and password
Reset              Reset configuration to default
-> Save_Restart     Save and Restart
Exit               Exit and disconnection

Command > Save_Restart <CR>

-----
ARROW KEY: 'UP/DOWN' Move cursor, 'RIGHT' Select, 'LEFT' Exit      Mode : USER
```

9. Once you have finished with the entire configuration, arrow down to Save_Restart and hit enter. Make sure you want to overwrite the old settings (y/n)? Hit the y key, then hit enter.

```
SNMP Server Telnet Configuration
-----
Sys Information      Set system information
Network             Set IP address, gateway address and subnet mask
PPP Config.         Set PPP Configuration
Mail                Set SMTP server, e-mail address
Trap               Set trap receivers
API Config.         Set API Configuration
Device             Set device connect, iSwitch
Device Control      Device control...
Administrator       Set internet administrator name and password
TelnetProfile       Set telnet configuration port and password
Reset              Reset configuration to default
-> Save_Restart     Save and Restart
Exit               Exit and disconnection

Command > Save_Restart <CR>

Response > Make sure you want to overwrite old setting file (y/n) ?

-----
ARROW KEY: 'UP/DOWN' Move cursor, 'RIGHT' Select, 'LEFT' Exit      Mode : USER
```

10. After rebooting the system, the new settings will be activated. Reboot (y/n)? Hit the y key then hit enter.

11. The iSwitch has rebooted to activate the new settings. Click OK. Arrow down to exit then hit enter.

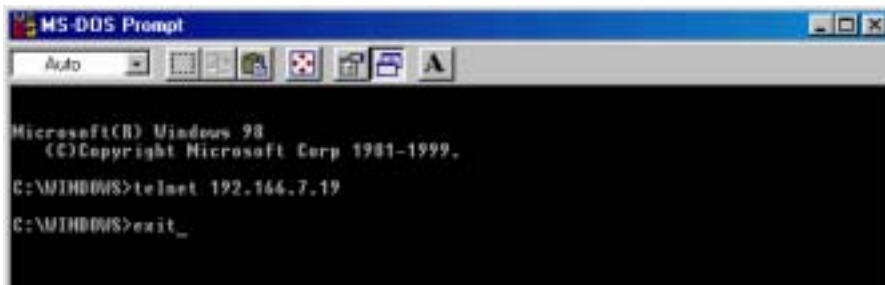

```
Microsoft Windows [Version 3.11]
(C) Copyright 1988-1999 Microsoft Corporation

C:\WINDOWS>telnet 192.168.7.19
C:\WINDOWS>exit
```

12. At the MS-DOS Prompt type exit, then hit enter.

13. The Telnet Configuration is complete. The iSwitch is fully operational. After about thirty seconds the Link LED will start blinking, now you can communicate with the iSwitch. The Ping command is supported at this time. Startup a Browser and type in the IP Address. The default password is **admin** (lower case). Go to the section in the User's Manual titled "Web-Based Configuration" it will guide you through the Web pages.

14. All functions description please refer to Page 30.

Web-Based Configuration

This section will guide you through the Web-Based-Configuration and the Web Pages of the Remote Power Manager (iSwitch).

NOTE: You must complete the appropriate Setup Procedures before proceeding with the Web-Based-Configuration.

The Ethernet cable is connected to the iSwitch and the iSwitch is on.

1. Startup a Web browser.
2. Type in your IP Address.
3. Next you will be asked for the User Name and Password. The default Name and Password is **admin**. Enter the password, then hit enter. Then, in the browser left side will show up the option menu. You can configure the iSwitch by selecting menu.

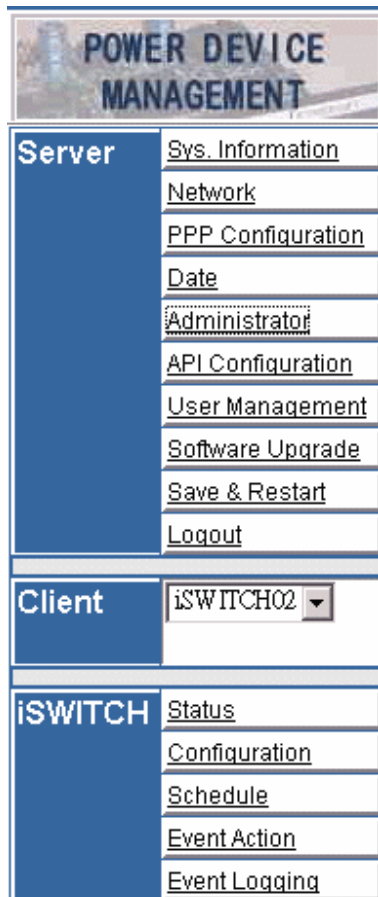

Server	
Sys. Information	Support MIB II to define the System Group
Network	Set the network parameters, including IP address etc.
PPP Configuration	Set the information when controlled through modem.
Date	Set ePowerSwitch server date
Administrator	1. Set the administrator's login name and password. 2. Set the security level
API Configuration (option)	Provide Application Programming Interface
User Management	Set the general users' login name, password and controllable outlet.
Software Upgrade	1. Indicate the firmware version. 2. Provide the upgrade interface by TFTP.
Save & Restart	The procedure must be executed after change some information
Client	List all the devices cascading through RS485
iSwitch	
Status	Indicate the outlets status, turn on/off the outlets
Configuration	Set the outlets' functions.
Schedule	Set the outlets controlled schedule.
Event Action	Based on the pre-set action happened by iSwitch, notify the user through every kind of ways.
Event Logging	Record all the iSwitch events.

- This is the screen where you can set the Network parameters. After you have finished filling in all of the information, click Save.

BOOT MODE: iSwitch support DHCP, BOOTP and FIXED IP

Set Network	
IP Address	61.218.90.221
Gateway Address	61.218.90.217
Subnet Mask	255.255.255.248
Domain Name Server	
Server ID	server
TFTP Server IP Address	
TFTP File Name	device.bin
SNMP Read Community	*****
SNMP Write Community	*****
BOOT Mode	FIX

Save

Back

- The PPP connection is useful if it is not possible to make a direct network connection to the iSwitch. An external modem is needed to connect to the front serial port of the iSwitch. The iSwitch support two ways using modem to connect directly.

ISP

After dialing in the remote user must hang up after the third ring. Based on the information that the user puts into the PPP configuration, the iSwitch will automatically dial up to the designated ISP and send an email to the designated email address with the assigned IP address from the ISP. The user may browse and control the iSwitch with this dynamic IP address. When the user is ready to exit click the "Disconnect Now" button at the bottom of the screen.

PPP

Both side are connected by modem.

NOTE: The user must complete one of the Setup Procedures and fill in all of the information in the PPP Configuration before the Dial-up Function will work.

PPP Configuration	
<input type="checkbox"/> Enable PPP Function	
PPP Type	PPP
ISP Dial Number	207
ISP Account	admin
ISP Password	*****
Modem Configuration	
Baudrate	115200
Dial Prefix	Initialization String
	ATL1
Mail Configuration	
SMTP Server	61.218.90.211
Returned Address	lucilee@digipower.com.tw
Message Subject	ISP IP Address
Email Address	lucilee@digipower.com.tw
PPP Mode(Dial in) Configuration	
PPP Server IP	169.254.1.1
PPP Client IP	169.254.1.4
PPP Administrator's Name	admin
PPP Administrator's Password	*****
<input type="button" value="Save"/> <input type="button" value="Disconnect Now"/>	
<input type="button" value="Back"/>	

6. This is the screen where you set the Date and Time. After you have finished filling in the information, click Save.

Set Server Date & Time

Server Date (MM/DD/YYYY) 10/12/2001

Server Time (HH:MM:SS) 06:35:51

Save

Back

7. This is the screen where you can change the Administrator's Name and Password. After you have finished filling in the information, click Save.

NOTE: The Supervisor's name and password can be from 1 to 19 digits. The Supervisor's name and password is not limited to an alphanumeric character (i.e. a#1b\$2z%9).

NOTE: Be sure to write down your Supervisor's name/password and keep it in a safe place. If the user forgets the name/password the iSwitch will have to be Flash Upgraded before the user can access the iSwitch.

NOTE: It will be enhanced the security level to MD5 after the Enable Security Login checked.

Set Administrator

Enable Security Login

Administrator's Name admin

Administrator's Password *****

Re-Enter Password *****

Save

Back

8. This is the screen where the administrator can enable the application program interface to certain users. After you have finished filling in the information, click Save. **(Optional)**

9. This is the screen where the administrator can give certain rights to certain users. After you have finished filling in the information, click Save.

User Name	Password	A	B	C	D	E	F	G	H
<input type="text"/>	<input type="text"/>	<input type="checkbox"/>	<input type="checkbox"/>	<input type="checkbox"/>	<input type="checkbox"/>	<input type="checkbox"/>	<input type="checkbox"/>	<input type="checkbox"/>	<input type="checkbox"/>
<input type="text"/>	<input type="text"/>	<input type="checkbox"/>	<input type="checkbox"/>	<input type="checkbox"/>	<input type="checkbox"/>	<input type="checkbox"/>	<input type="checkbox"/>	<input type="checkbox"/>	<input type="checkbox"/>
<input type="text"/>	<input type="text"/>	<input type="checkbox"/>	<input type="checkbox"/>	<input type="checkbox"/>	<input type="checkbox"/>	<input type="checkbox"/>	<input type="checkbox"/>	<input type="checkbox"/>	<input type="checkbox"/>
<input type="text"/>	<input type="text"/>	<input type="checkbox"/>	<input type="checkbox"/>	<input type="checkbox"/>	<input type="checkbox"/>	<input type="checkbox"/>	<input type="checkbox"/>	<input type="checkbox"/>	<input type="checkbox"/>

10. This is the screen where you can upgrade to the latest version of software. After you have finished filling in the information, click YES.

NOTE: Make sure that the firmware file (for example: ups.bin) is located in the default directory of the TFTP server.

11. After filling in all of the information be sure to **Save and Restart** before exiting the program.



iSwitch

12. This screen allows the user to see the status of the iSwitch. The user can control each receptacle individually or all of them at the same time. The iSwitch has to be setup in the remote mode to control the receptacles via the Internet. The iSwitch can also be setup for the local mode. The user can control the receptacles by the momentary switches on the front panel.

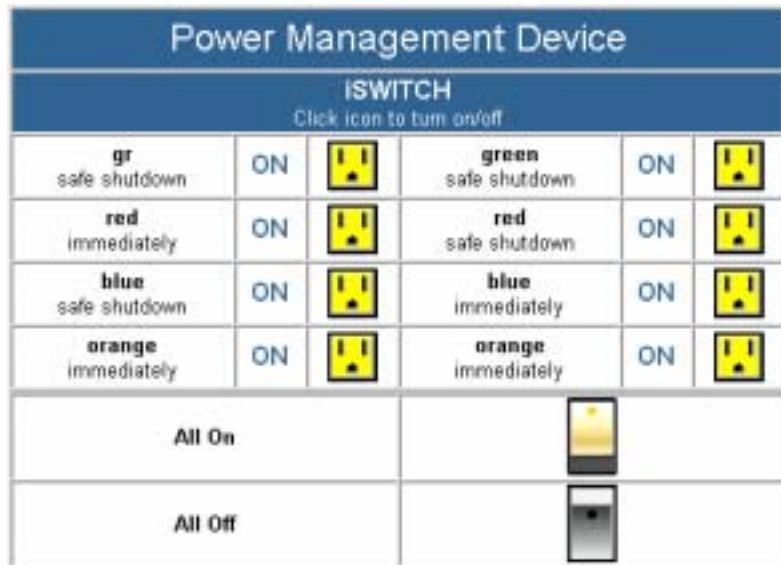

13.

a. ID Address Configuration and Identification:

Since 16 iSWITCHs can be daisy chained together to share one CIC, each unit can be individually named.

b. Name:

The name of each outlet can be labeled to whatever you like it to be called (i.e. server1, DSL modem or webserver1).

c. Power Resume Delay:

The power resume delay is convenient for sequential startup.

d. Ring On/Reset:

Each outlet can be individually programmed to enable ring On/Off or reset. And phone control. (Optional, see P.47)

e. Safe Shutdown/Reboot:

The safe shutdown feature has a configurable delay time to safely shutdown the NT server.

To enable this safe shutdown function, in both NT and WIN 2000, you need to have three setting for the UPS to configure it.

Connect the communication port on the rear of iSWITCH to NT or WIN 2000 server with the PC Communication cable. Connect the corresponding outlet on the rear of iSWITCH to the NT or WIN 2000 server with the PC input power cord. Check the corresponding box of safe waiting device shutdown in iSWITCH configuration page to enable this function.

iSWITCH Configuration					
ID Address Configuration		iSWITCH ¹			
Identification		iSWITCH			
Outlet	Name	Power Resume Delay	Ring On/Reset	Safe Shutdown/Reboot	
OutletA	gr	0001 sec	<input checked="" type="checkbox"/>	<input checked="" type="checkbox"/> / <input type="checkbox"/>	0010 sec
OutletB	red	0002 sec	<input checked="" type="checkbox"/>	<input type="checkbox"/> / <input type="checkbox"/>	0300 sec
OutletC	blue	0003 sec	<input checked="" type="checkbox"/>	<input checked="" type="checkbox"/> / <input type="checkbox"/>	0010 sec
OutletD	orange	0004 sec	<input checked="" type="checkbox"/>	<input type="checkbox"/> / <input type="checkbox"/>	0300 sec
OutletE	green	0005 sec	<input checked="" type="checkbox"/>	<input checked="" type="checkbox"/> / <input type="checkbox"/>	0010 sec
OutletF	red	0006 sec	<input checked="" type="checkbox"/>	<input checked="" type="checkbox"/> / <input type="checkbox"/>	0010 sec
OutletG	blue	0007 sec	<input checked="" type="checkbox"/>	<input type="checkbox"/> / <input type="checkbox"/>	0300 sec
OutletH	orange	0008 sec	<input checked="" type="checkbox"/>	<input type="checkbox"/> / <input type="checkbox"/>	0040 sec

UPS Interface Configuration On: COM1

UPS Signal Polarity:

 Warning: Please consult your UPS documentation before attempting to configure signal polarities.

Power Fail/On Battery: Negative Positive
 Low Battery: Negative Positive
 UPS Shutdown: Negative Positive

14. This screen allows the User to schedule daily/weekly shutdowns and restarts of individual receptacles (be sure to check the appropriate box). The safe shutdown is dedicated to Microsoft Windows NT (4.0, 2000, workstation and server). Click on the corresponding outlet to enable the safe shutdown feature. The safe shutdown feature has a configurable delay time to safely shutdown the NT server. Then click Save.

Date	Action	Shutdown Time (HH:MM)	Restart Time (HH:MM)
MON	<input checked="" type="checkbox"/> Enable	12:00	18:00
TUE	<input type="checkbox"/> Enable	00:00	00:00
WED	<input type="checkbox"/> Enable	00:00	00:00
THU	<input type="checkbox"/> Enable	00:00	00:00
FRI	<input type="checkbox"/> Enable	00:00	00:00
SAT	<input type="checkbox"/> Enable	00:00	00:00
SUN	<input type="checkbox"/> Enable	00:00	00:00

15. This screen allows the User to depend on the iSwitch event to set notification. There are five ways to notify user.

Event List

- Alarm iSwitch Outlet Fault
- Alarm iSwitch Restart
- Alarm iSwitch Lost

Configure

PAGER BROADCAST LOGGING TRAP MAIL

Back

- a. Pager
 Input the code defined by user himself to Alarm-Add and Alarm-Remove.

- b. Broadcast
 It must run an application in the client to receive this broadcast message.

- c. Logging
 Enable the event logging function.

- d. Trap
Set the SNMP trap.

Trap

Event :

Trap Enable

Trap Receiver Configuration

Accept	IP Address	Community
<input type="checkbox"/>	<input type="text"/>	public
<input type="checkbox"/>	<input type="text"/>	public
<input type="checkbox"/>	<input type="text"/>	public
<input type="checkbox"/>	<input type="text"/>	public
<input type="checkbox"/>	<input type="text"/>	public
<input type="checkbox"/>	<input type="text"/>	public
<input type="checkbox"/>	<input type="text"/>	public
<input type="checkbox"/>	<input type="text"/>	public
<input type="checkbox"/>	<input type="text"/>	public
<input type="checkbox"/>	<input type="text"/>	public
<input type="checkbox"/>	<input type="text"/>	public

[Back](#) [Home](#)

- e. Mail
Send the event to the user pre-set email account.

Mail

Event :

Mail Enable

Mail Configuration

DNS Server

SMTP Server

Returned Address

Message Subject

Email Address

[Back](#)

16. This screen allows the user to check the iSwitch event log.

View Event Log	
Date From:(MM/DD/YYYY)	<input type="text"/>
Date To:(MM/DD/YYYY)	<input type="text" value="10/12/2001"/>
Event Type:	<input type="text" value="All"/>
<input type="button" value="OK"/>	
<input type="button" value="Back"/>	

The Web-Based Configuration is complete. The iSwitch is fully operational.

Firmware Upgrade Procedures

Firmware Upgrade via TFTP

With a Web browser, click on “Software upgrade”, input TFTP server’s IP address and go. Make sure that the firmware file (For example: ups.bin) is located in the default directory of the TFTP server.

Firmware Upgrade via Serial Port:

NOTE: When using Hyper Terminal use Version 3.0 or higher.

The following items must be obtained before attempting to upgrade the iSwitch: The firmware upgrade software, a DB9 female-to-female Serial Cable (provided). There are a wide variety of Terminal Emulation packages, but for the most part they should be very similar. The following upgrade procedure is using Hyper Terminal.

1. Go to the section titled “Setup via Serial Port” (page 19) and follow steps 1 through 10.
2. Plug the iSwitch’s power cord into the AC outlet and turn the iSwitch on.

3. Once the message "Check u-dram" appears hit the "c" key. Then at the cursor type "upall" then hit enter. Once the User hits enter, you have approximately thirty seconds to complete the next four steps.

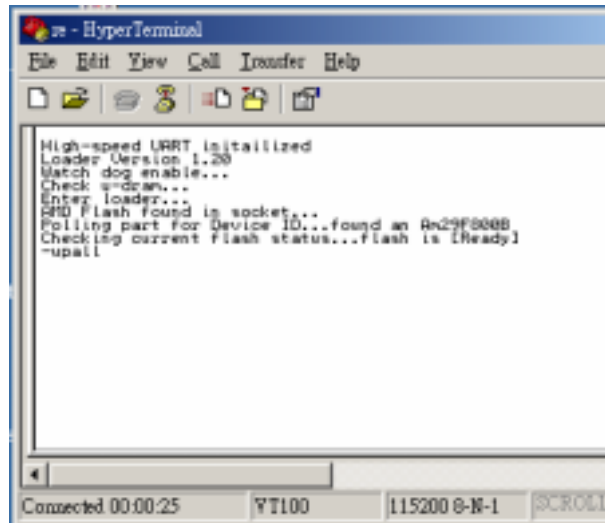

4. Go to the tool bar and select Transfer. Open Send File.

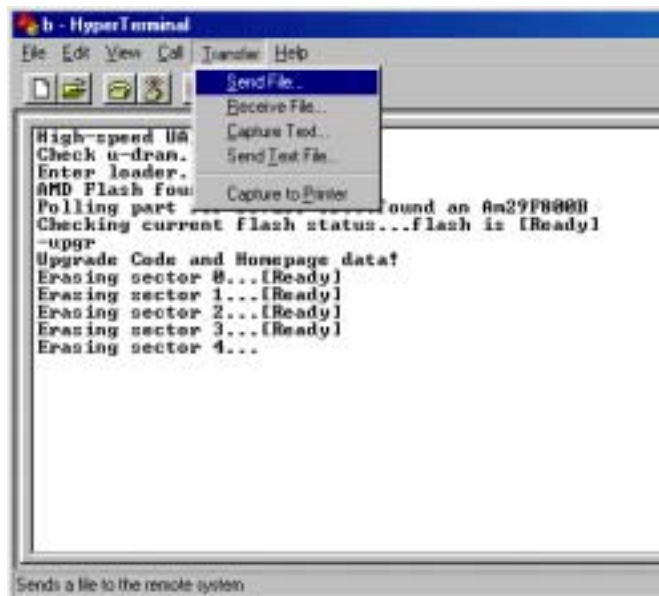

5. Select "X modem" under Protocol.

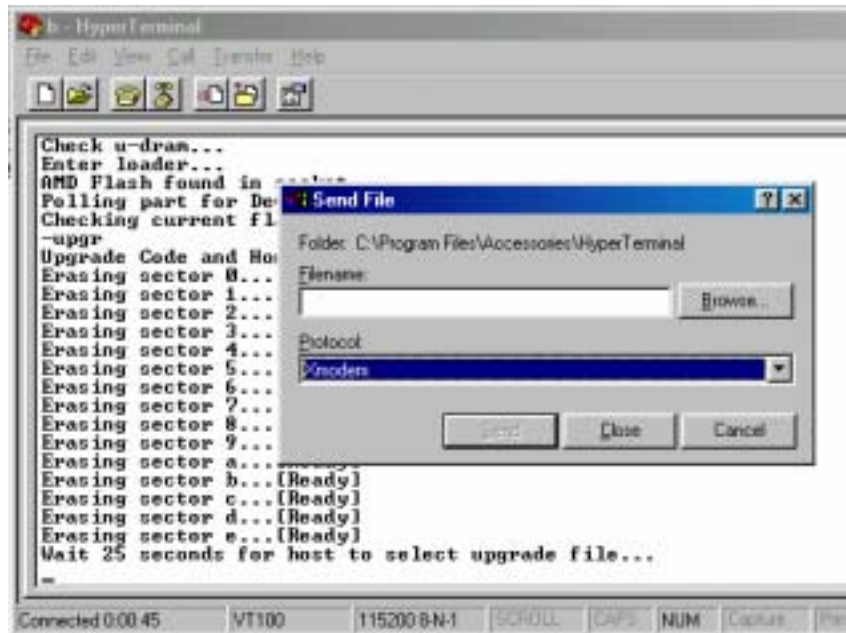

6. Click Browse. Look in the location where the Firmware upgrade software is located. Select the File name: "test.bin" and click open.

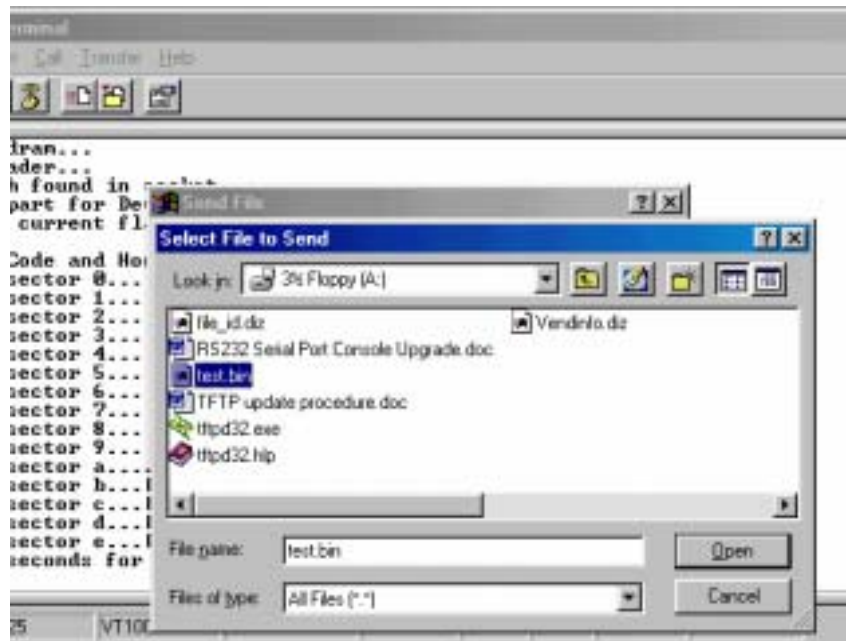

7. Click Send.

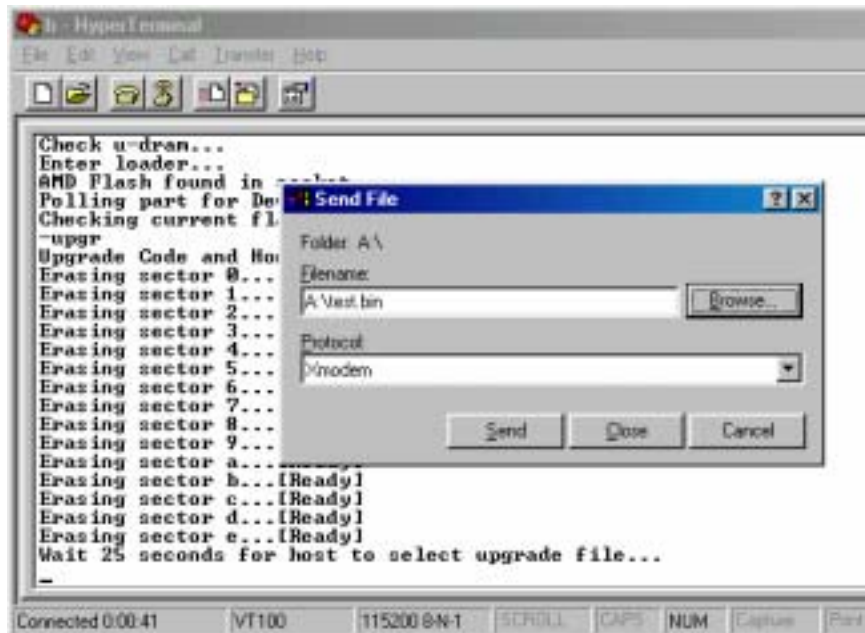

8. The Firmware upgrade will take approximately eight minutes to complete.

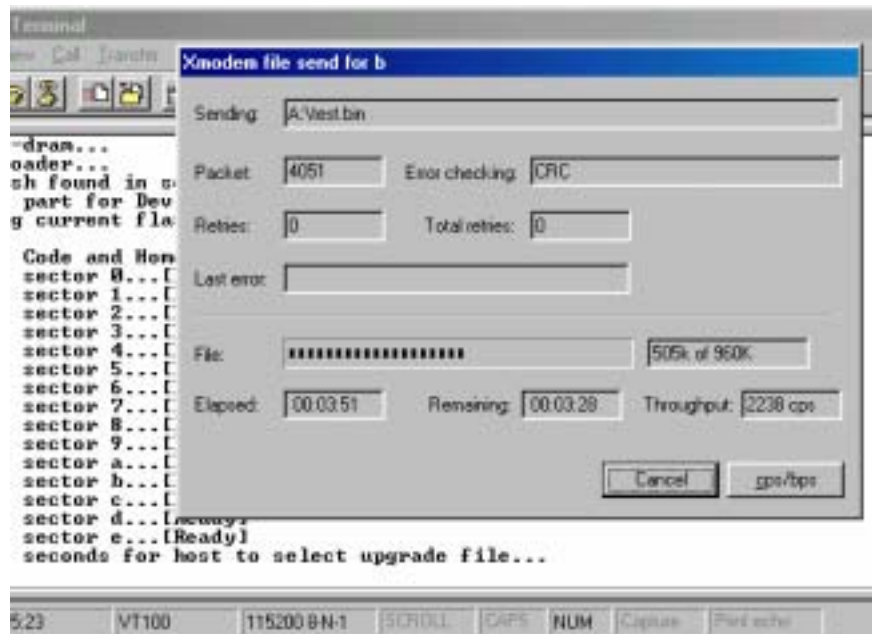

9. The Firmware upgrade is complete.

NOTE: The user has to reconfigure all of the settings after the Firmware upgrade is complete, because all of the user's settings will default to the original default settings.

```
b - HyperTerminal
File Edit View Call Transfer Help

Enter loader...
AMD Flash found in socket...
Polling part for Device ID...found an Am29F8000
Checking current flash status...flash is [Ready]
-UPGR
Upgrade Code and Homepage data!
Erasing sector 0...[Ready]
Erasing sector 1...[Ready]
Erasing sector 2...[Ready]
Erasing sector 3...[Ready]
Erasing sector 4...[Ready]
Erasing sector 5...[Ready]
Erasing sector 6...[Ready]
Erasing sector 7...[Ready]
Erasing sector 8...[Ready]
Erasing sector 9...[Ready]
Erasing sector a...[Ready]
Erasing sector b...[Ready]
Erasing sector c...[Ready]
Erasing sector d...[Ready]
Erasing sector e...[Ready]
Wait 25 seconds for host to select upgrade file...
Upgrade Complete!
-
```

Connected 0:09:56 VT100 115200 8N-1 SCROLL CAPS NUM

Telephone Access Interface

1. Dial up the iSwitch.
2. After three rings the iSwitch will respond by sending out three short beeps to the caller. Then the iSwitch waits for the user to enter the password.
3. The user enters an access password (default password is 123456789#).
4. The iSwitch will send out three short beeps to confirm a successful login, or one long beep to deny access.
5. Once logged in, the remote user can punch in 4-8 digits. The first two digits specify which iSwitch, the next digit specifies which output receptacle and the next digit specifies which command. The last four digits specify the amount of time:
Command format: **XXNA#**:
XX - 00—16 is the iSwitch's device number for a daisy chain, if there is no daisy chain, then any number is accepted.
N - outlet number: 1(A)—8(H), 9 controls all the outlets.
A - action type: 0=off, 1=on, 2=reset.
I.E. 0111# RPM01 turn on Outlet A.
I.E. 0120# RPM01 turn off Outlet B.
I.E. 0212# RPM02 reset outlet A.
I.E. 01113600# means turn A on after 3600 minutes.
I.E. 01103600# means turn A off after 3600 minutes.
I.E. 01123600# means reset A after 3600 minutes.
6. Use a combination of 0111XXXX# or 0112XXXX# to get a different delay time. XXXX max value is 9999, which is about 166 hours or 6.94 days.
7. Use the "*" key to cancel a command at any time.
8. The iSwitch will acknowledge the receipt of the commands by issuing 2 short beeps. A long beep indicates a failure or a non-recognizable command.
9. To change the password. The default password is 123456789#. The user has to enter the previous password in order to change their password.
NOTE: The Password has to have a minimum of 7 digits and can have a maximum of 10 digits.
10. The user enters 888# or whatever previous password. Then the iSwitch responds with three short beeps acknowledging access granted. The user then enters the new password as follows: 888XXXXXXXXXX#, and the iSwitch acknowledges with 2 short beeps. Then user inputs 888XXXXXXXXXX# the second time to re-confirm the new password. The iSwitch acknowledges with 4 short beeps, indicating that the password has been changed.
11. Hang up to close any access.
12. Forgot telephone interface password? Please do the following steps to restore the default password.
 - a. Dial up the iSwitch.
 - b. After three sequence rings, the iSWITCH will respond by sending out 3 short beeps to the caller and waiting for user to enter password. Then pressing the button A and H simultaneously on the iSwitch within twenty seconds.
 - c. When the LED A and H blinking, release the two buttons, the iSWITCH will respond by sending out 4 short beeps to the caller. The password will be restored to default.
13. The iSwitch is in a waiting loop to receive the command string. Each command string should be entered within 20 seconds. After 180 seconds without any user input, the iSwitch will logout the user.
14. The 9 command set is for the administrator:
0190# to turn every port off.
0191# to turn every port on.
0192# to reset every port with a delay of 8 minutes, which will allow safe shutdowns. The delay can be changed by command 888911XXXX#, where XXXX can range from 1 to 9999 minutes.
15. The user enters 000# that can force to break connection with iSwitch.

Daisy Chaining

The Remote Power Manager (iSwitch) can be Daisy Chained up to a maximum of sixteen units. Each iSwitch in the Daisy Chain must have its own unique identification number. The default ID# is "0". The first iSwitch must have the Internet Power Management Card install and must be configured before you can begin Daisy Chaining any additional RPMs. Only the first iSwitch requires the Internet Power Management Card. All of the other RPMs in the Daisy Chain do not require that the Internet Power Management Card be installed. Follow the procedure below to Daisy Chain the RPMs:

Figure 1 - First iSwitch



1. Make sure that the Terminator is plugged into the first iSwitch's iLink port (see Figure 1).
2. Plug the first iSwitch's power cord into utility power.
3. Turn the master power switch on.
4. Setup the iSwitch (see Setup Procedure page 9).
5. Configure the first iSwitch's ID number (each iSwitch must have it's own unique ID#, the default ID# is "0").

Figure 2 - First and second iSwitch

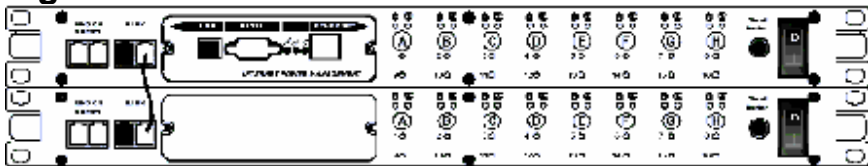

6. Make sure that the second iSwitch has the Terminator plugged into the iLink port (see Figure 2).
7. Connect the first and second iSwitch together with the iLink cable.
8. Plug the second iSwitch's power cord into utility power.
9. Turn the master power switch on.
10. Configure the second iSwitch's ID number (each iSwitch must have it's own unique ID#, the default ID# is "0").
11. If there are only two RPMs required for this application, then this completes the Daisy Chaining procedure and the RPMs are ready for use.
12. If your application requires additional RPMs, then continue on with the Daisy Chaining procedure.

Figure 3 - First, second and third iSwitch

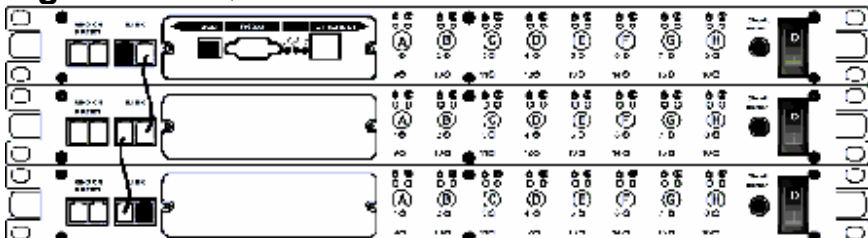

13. Make sure that the third iSwitch has the Terminator plugged into the iLink port (see Figure 3).
14. Remove the Terminator from the second iSwitch.
15. Connect the second and third iSwitch together with the iLink cable.

16. Plug the third iSwitch's power cord into utility power.
17. Turn the master power switch on.
18. Configure the third iSwitch's ID number (each iSwitch must have it's own unique ID#, the default ID# is "0").
19. If there are only three RPMs required for this application, then this completes the Daisy Chaining procedure and the RPMs are ready for use.
20. If your application requires additional RPMs (maximum of sixteen), then repeat steps 13-19 of the Daisy Chaining procedure.

Troubleshooting

- Problem:** The TES (Terminal Emulation Software) does not display anything.
Solution: Make sure the TES's communication parameters are correct. They should be 115200-baud rate, no parity, 8-data bits, and 1 stop bit. The cable is a DB9 Female-to-Female serial cable.
- Problem:** The NMS cannot ping the Remote Power Manager (iSwitch).
Solution: Make sure the network connection to the Remote Power Manager (iSwitch) is good.
Solution: Make sure the cable is in good condition.
Solution: Make sure to set the Community String. Name the community with any lowercase name.
Solution: Make sure to set the Manager Table.
Solution: Make sure the Gateway is correct.
Solution: Make sure to Save and Restart after the Setup Procedure.
- Problem:** My NT server shutdown.
Solution: Verify that the NT server is not setup to have a scheduled shutdown.
Solution: Verify that the RJ-11 NT server cable, on the iSwitch and the NT server, is properly secured.
- Problem:** All the LEDs are off and all of the output receptacles are dead.
Solution: Turn the master power switch ON.
Solution: Reset the AC circuit breaker.
- Problem:** The iSwitch will not communicate and all of the LEDs on the Internet Power Management card are ON.
Solution: There has been a collision of the packets. The iSwitch needs to be reset. Turn the iSwitch off and wait for approximately one minute, then turn the iSwitch back ON.
- Problem:** All the LEDs are off and all of the output receptacles are on.
Solution: The iSwitch needs to be reset. Turn the iSwitch off and wait for approximately one minute, then turn the iSwitch back ON.
- Problem:** The user cannot change from one Web Page to the next.
Solution: There has been a collision of the packets. The iSwitch needs to be reset. Turn the iSwitch off and wait for approximately one minute, then turn the iSwitch back ON.
- Problem:** I forgot my password for the Smart Phone.
Solution: The Smart Phone Card will have to be replaced.
- Problem:** I forgot my Supervisor's name/password.
Solution: The iSwitch will have to be Flash Upgraded.

This section discusses: Communities, Gateways, IP Addresses, and Sub net masking.

Communities

A community is a string of printable ASCII characters that identifies a user group with the same access privileges. For example, a common community name is "public."

For security purposes, the SNMP agent validates requests before responding. The agent can be configured so that only trap managers that are members of a community can send requests and receive responses from a particular community. This prevents unauthorized managers from viewing or changing the configuration of a device.

Gateways

Gateway, also referred to as a router, is any computer with two or more network adapters connecting to different physical networks. Gateways allow for transmission of IP packets among networks on an Internet.

IP Addresses

Every device on an Internet must be assigned a unique IP (Internet Protocol) address. An IP address is a 32-bit value comprised of a network ID and a host ID. The network ID identifies the logical network to which a particular device belongs. The host ID identifies the particular device within the logical network. IP addresses distinguish devices on an Internet from one another so that IP packets are properly transmitted.

IP addresses appear in dotted decimal (rather than in binary) notation. Dotted decimal notation divides the 32-bit value into four 8-bit groups, or octets, and separates each octet with a period. For example, 199.217.132.1 is an IP address in dotted decimal notation.

To accommodate networks of different sizes, the IP address has three divisions—Classes A for large, B for medium and C for small. The difference among the network classes is the number of octets reserved for the network ID and the number of octets reserved for the host ID.

Class	Value of First Octet	Network ID	Host ID	Number of Hosts
A	1-126	First octet	Last three octets	16,387,064
B	128-191	First two octets	Last two octets	64,516
C	192-223	First three octets	Last octet	254

Any value between 0 and 255 is valid as a host ID octet except for those values the InterNIC reserves for other purposes.

Value	Purpose
0, 255	Subnet masking
127	Loopback testing and interprocess communication on local devices
224-254	IGMP multicast and other special protocols

Subnetting and Subnet Masks

Subnetting divides a network address into sub-network addresses to accommodate more than one physical network on a logical network.

For example: A Class B company has 100 LANs (Local Area Networks) with 100 to 200 nodes on each LAN. To classify the nodes by its LANs on one main network, this company segments the network address into 100 sub-network addresses. If the Class B network address is 150.1.x.x, the address can be segmented further from 150.1.1.x through 150.1.100.x.

A subnet mask is a 32-bit value that distinguishes the network ID from the host ID for different sub-networks on the same logical network. Like IP addresses, subnet masks consist of four octets in dotted decimal notation. You can use subnet masks to route and filter the transmission of IP packets among your sub-networks. The value "255" is assigned to octets that belong to the network ID, and the value "0" is assigned to octets that belong to the host ID.

For the example above, if you want all the devices on the sub-networks to receive each other's IP packets, set the subnet mask to 255.255.0.0. If you want the devices on a single sub-network only to receive IP packets from other devices on its own sub-network, set the subnet mask to 255.255.255.0 for the devices on that sub-network.

Subnet Mask	Routing and Filtering
0.0.0.0	IP packets are transmitted to all devices.
255.0.0.0	IP packets are only transmitted to devices that are IP that's first octet matches the sender's IP address's first octet.
255.255.0.0	IP packets are only transmitted to devices that are IP that's first two octets match the sender's IP address's first two octets.
255.255.255.0	IP packets are only transmitted to devices that are IP that's first three octets match the sender's IP address's first three octets.

Glossary

The Glossary section defines the terms used in the Computer Interface Card (CIC) -MP environment.

Agent	Implemented SNMP applications in network elements (hosts). Agents perform the network management's functions as requested by the network administrator from an NMS.
Dry Closure Input	Non-powered contact type inputs—switch, relay contact, open-collector.
Dry Closure Output	Form C dry-contact outputs, which are common, normally open, or normally closed.
Ethernet	Local Area Network technology, originally developed by the Xerox Corporation, can link up to 1,024 nodes in a bus network. Ethernet provides raw data transfer in a rate of 10 megabits/sec. with actual throughputs in 2 to 3 megabits/sec. using a baseband (single-channel) communication technique. Ethernet uses carrier sense multiple access collision detection (CSMA/CD) that prevents network failures when two devices attempt to access the network at the same time. LAN hardware manufactures use Ethernet protocol; their products may not be compatible.
Gateway	A computer that attaches to a number of networks and routes packets between them. The packets can be different protocols at the higher levels.
IP	<i>Internet Protocol</i> —The TCP/IP standard protocol defines the IP datagram as the unit of information passed across a network.
IP Address	<i>Internet Protocol Address</i> —A 32-bit address assigned to hosts participating in a TCP/IP network. The IP address consists of network and host portions. It is assigned to an interconnection of a host to a physical network.
MAC	<i>Medium Access Control</i> —The network layer between the physical and the data link layers. Specifically, the physical (hardware) address exists in this layer.
MIB	<i>Management Information Base</i> —The database, i.e., set of variables maintained by a gateway running SNMP.
NC	<i>Normally Closed</i> —Refers to a contact switch that is normally closed.
NIC	<i>Network Interface Controller</i> —The hardware interface to the physical connection to the network.
NMS	<i>Network Management Station</i>
NO	<i>Normally Open</i> —Refers to a contact switch that is normally open.
OID	<i>Object Identifier</i> —The variables defined in a MIB.
Personality	The current device specific software uploaded to the Computer Interface Card (CIC).
Router	A computer that manages traffic between different network segments or different network topologies. It directs the destination IP address. The network media can be different, but the higher-level protocols must be the same.
RS-232	A specification for serial communication between data communication equipment and computers.
SNMP	<i>Simple Network Management Protocol</i> —A standard protocol used to monitor IP hosts, networks, and gateways. SNMP defines a set of simple operations that can be performed on the OIDs of the MIBs managed by the monitored Agents. It employs the UDP/IP transport layer to move its object between the Agents and the NMS.
Sub-Agent	A software module that manages specific MIB sub-groups for an Agent. They communicate with the Agent using a SMUX (multiplexer).
TCP/IP	<i>Transmission Control Protocol/Internet Protocol</i> —A protocol suite used by more than 15 million users with a UNIX association and widely used to link computers of different kinds.

TES	<i>Terminal Emulation Software</i> —Communications program to transform a personal computer into a terminal for the purpose of data communications.
TFTP Server	<i>Trivial File Transfer Protocol Server</i> —A host to provide services according to TFTP; a TCP/IP standard protocol for file transfer with minimal capability and overhead depending on UDP for its datagram delivery service.
UDP/IP	<i>User Datagram Protocol/Internet Protocol</i> —A TCP/IP standard protocol. It enables transfer of information between applications running on different host. It is referred to as an unreliable, connectionless datagram delivery service.
UPS	<i>Uninterruptible Power Supply</i> —A device that supplies power to your system with rechargeable batteries if there is an AC power failure.

Obtaining Technical Assistance

1. Use the **TROUBLESHOOTING** section to eliminate obvious causes.
2. Verify there are no circuit breakers tripped. A tripped circuit breaker is the most common problem.
3. Call your dealer for assistance. Please have the following information available **BEFORE** calling the Technical Support Department.
 - A. Your Name and address.
 - B. Where and when the unit was purchased.
 - C. All of the model information of the iSwitch.
 - D. Any information on the failure, including LEDs that may or may not be illuminated.
 - E. A description of the protected equipment, including model numbers if possible.
 - F. A technician will ask you for the above information and, if possible, help solve your problem over the phone. In the event that the unit requires factory service, the technician will issue you a Return Material Authorization Number (RMA #).
 - G. If the iSwitch is under warranty, the repairs will be done at no charge. If not, there will be a charge for repair.
4. Pack the iSwitch in its original packaging. If the original packaging is no longer available, ask the Technical Support Technician about obtaining a new set. It is important to pack the iSwitch properly in order to avoid damage in transit. Never use Styrofoam beads for a packing material.
 - A. Include a letter with your name, address, daytime phone number, RMA number, a copy of your original sales receipt, and a brief description of the problem.
5. Mark the RMA # on the outside of all packages. The factory cannot accept any package without the RMA # marked on the outside.

Free Manuals Download Website

<http://myh66.com>

<http://usermanuals.us>

<http://www.somanuals.com>

<http://www.4manuals.cc>

<http://www.manual-lib.com>

<http://www.404manual.com>

<http://www.luxmanual.com>

<http://aubethermostatmanual.com>

Golf course search by state

<http://golfingnear.com>

Email search by domain

<http://emailbydomain.com>

Auto manuals search

<http://auto.somanuals.com>

TV manuals search

<http://tv.somanuals.com>