

RP300A

Artist

MODELING GUITAR PROCESSOR

DigiTech
The Power to Create



User's Guide

IMPORTANT SAFETY INFORMATION



The symbols shown above are internationally accepted symbols that warn of potential hazards with electrical products. The lightning flash with arrowpoint in an equilateral triangle means that there are dangerous voltages present within the unit. The exclamation point in an equilateral triangle indicates that it is necessary for the user to refer to the owner's manual.

These symbols warn that there are no user serviceable parts inside the unit. Do not open the unit. Do not attempt to service the unit yourself. Refer all servicing to qualified personnel. Opening the chassis for any reason will void the manufacturer's warranty. Do not get the unit wet. If liquid is spilled on the unit, shut it off immediately and take it to a dealer for service. Disconnect the unit during storms to prevent damage.

SAFETY INSTRUCTIONS

NOTICE FOR CUSTOMERS IF YOUR UNIT IS EQUIPPED WITH A POWER CORD.

WARNING: THIS APPLIANCE MUST BE EARTHED.

The cores in the mains lead are coloured in accordance with the following code:

GREEN and YELLOW - Earth BLUE - Neutral BROWN - Live

As colours of the cores in the mains lead of this appliance may not correspond with the coloured markings identifying the terminals in your plug, proceed as follows:

- The core which is coloured green and yellow must be connected to the terminal in the plug marked with the letter E, or with the earth symbol, or coloured green, or green and yellow.
- The core which is coloured blue must be connected to the terminal marked N or coloured black.
- The core which is coloured brown must be connected to the terminal marked L or coloured red.

This equipment may require the use of a different line cord, attachment plug, or both, depending on the available power source at installation. If the attachment plug needs to be changed, refer servicing to qualified service personnel who should refer to the table below. The green/yellow wire shall be connected directly to the units chassis.

CONDUCTOR	WIRE COLOR		
	Normal	Alt	
L	LIVE	BROWN	BLACK
N	NEUTRAL	BLUE	WHITE
E	EARTH GND	GREEN/YEL	GREEN

WARNING: If the ground is defeated, certain fault conditions in the unit or in the system to which it is connected can result in full line voltage between chassis and earth ground. Severe injury or death can then result if the chassis and earth ground are touched simultaneously.

LITHIUM BATTERY WARNING

CAUTION!

This product may contain a lithium battery. There is danger of explosion if the battery is incorrectly replaced. Replace only with an Eveready CR 2032 or equivalent. Make sure the battery is installed with the correct polarity. Discard used batteries according to manufacturer's instructions.

ADVARSEL!

Lithiumbatteri - Eksplosjonsfare. Ved utskifting benyttes kun batteri som anbefalt av apparatfabrikanten. Brukt batteri returneres apparatleverandøren.

ADVARSEL!

Lithiumbatteri - Eksplosjonsfare ved feilagtig håndtering. Utskiftning må kun ske med batteri av samme fabrikat og type. Levér det brukte batteri tilbake til leverandøren.

VAROITUS!

Paristo voi räjähtää, jos se on virheellisesti asennettu. Vaihda paristo ainoastaan laitevalmistajan suosittelemaan tyyppiin. Hävitä käytetty paristo valmistajan ohjeiden mukaisesti.

WARNING!

Explosionsfara ved feilagtigt batteribytte. Använd samma batterityp eller en ekvivalent typ som rekommenderas av apparatillverkaren. Kassera använt batteri enligt fabrikkantens instruksjon.

ELECTROMAGNETIC COMPATIBILITY

This unit conforms to the Product Specifications noted on the **Declaration of Conformity**.

Operation is subject to the following two conditions:

- this device may not cause harmful interference, and
- this device must accept any interference received, including interference that may cause undesired operation.

Operation of this unit within significant electromagnetic fields should be avoided.

- use only shielded interconnecting cables.

IMPORTANT SAFETY INFORMATION

WARNING FOR YOUR PROTECTION

PLEASE READ THE FOLLOWING:

KEEP THESE INSTRUCTIONS

HEED ALL WARNINGS

FOLLOW ALL INSTRUCTIONS

DO NOT USE THIS APPARATUS NEAR WATER

CLEAN ONLY WITH A DRY CLOTH.

DO NOT BLOCK ANY OF THE VENTILATION OPENINGS. INSTALL IN ACCORDANCE WITH THE MANUFACTURER'S INSTRUCTIONS.

DO NOT INSTALL NEAR ANY HEAT SOURCES SUCH AS RADIATORS, HEAT REGISTERS, STOVES, OR OTHER APPARATUS (INCLUDING AMPLIFIERS) THAT PRODUCE HEAT.

ONLY USE ATTACHMENTS/ACCESSORIES SPECIFIED BY THE MANUFACTURER.

UNPLUG THIS APPARATUS DURING LIGHTNING STORMS OR WHEN UNUSED FOR LONG PERIODS OF TIME.

Do not defeat the safety purpose of the polarized or grounding-type plug. A polarized plug has two blades with one wider than the other. A grounding type plug has two blades and a third grounding prong. The wide blade or third prong are provided for your safety. If the provided plug does not fit your outlet, consult an electrician for replacement of the obsolete outlet.

Protect the power cord from being walked on or pinched particularly at plugs, convenience receptacles, and the point where they exit from the apparatus.

Use only with the cart stand, tripod bracket, or table specified by the manufacture, or sold with the apparatus. When a cart is used, use caution when moving the cart/apparatus combination to avoid injury from tip-over.



Refer all servicing to qualified service personnel. Servicing is required when the apparatus has been damaged in any way, such as power-supply cord or plug is damaged, liquid has been spilled or objects have fallen into the apparatus, the apparatus has been exposed to rain or moisture, does not operate normally, or has been dropped.

POWER ON/OFF SWITCH: For products provided with a power switch, the power switch DOES NOT break the connection from the mains.

MAINS DISCONNECT: The plug shall remain readily operable. For rack-mount or installation where plug is not accessible, an all-pole mains switch with a contact separation of at least 3 mm in each pole shall be incorporated into the electrical installation of the rack or building.

FOR UNITS EQUIPPED WITH EXTERNALLY ACCESSIBLE FUSE RECEPTACLE: Replace fuse with same type and rating only.

MULTIPLE-INPUT VOLTAGE: This equipment may require the use of a different line cord, attachment plug, or both, depending on the available power source at installation. Connect this equipment only to the power source indicated on the equipment rear panel. To reduce the risk of fire or electric shock, refer servicing to qualified service personnel or equivalent.

This Equipment is intended for rack mount use only.

U.K. MAINS PLUG WARNING

A molded mains plug that has been cut off from the cord is unsafe. Discard the mains plug at a suitable disposal facility. NEVER UNDER ANY CIRCUMSTANCES SHOULD YOU INSERT A DAMAGED OR CUT MAINS PLUG INTO A 13 AMP POWER SOCKET. Do not use the mains plug without the fuse cover in place. Replacement fuse covers can be obtained from your local retailer. Replacement fuses are 13 amps and MUST be ASTA approved to BS1362.

DECLARATION OF CONFORMITY

Manufacturer's Name: DigiTech

Manufacturer's Address: 8760 S. Sandy Parkway
Sandy, Utah 84070
USA

declares that the product:

Product name: RP300 A
Product option: all (requires Class II power adapter that conforms to the requirements of EN60065, EN60742, or equivalent.)

conforms to the following Product Specifications:

Safety: IEC 60065 (1998)

EMC: EN 55013 (1990)
EN 55020 (1991)

Supplementary Information:

The product herewith complies with the requirements of the Low Voltage Directive 73/23/EEC and the EMC Directive 89/336/EEC as amended by Directive 93/68/EEC.

Vice-President of Engineering
8760 S. Sandy Parkway
Sandy, Utah 84070, USA

Date: February 21, 2003

European Contact: Your local DigiTech Sales and Service Office or

Harman Music Group
8760 South Sandy Parkway
Sandy, Utah
84070 USA
Ph: (801) 566-8800
Fax: (801) 568-7583

Warranty

We at **DigiTech** are very proud of our products and back-up each one we sell with the following warranty:

1. The warranty registration card must be mailed within ten days after purchase date to validate this warranty.
2. DigiTech warrants this product, when used solely within the U.S., to be free from defects in materials and workmanship under normal use and service.
3. DigiTech liability under this warranty is limited to repairing or replacing defective materials that show evidence of defect, provided the product is returned to DigiTech WITH RETURN AUTHORIZATION, where all parts and labor will be covered up to a period of one year. A Return Authorization number may be obtained from DigiTech by telephone. The company shall not be liable for any consequential damage as a result of the product's use in any circuit or assembly.
4. Proof-of-purchase is considered to be the burden of the consumer.
5. DigiTech reserves the right to make changes in design, or make additions to, or improvements upon this product without incurring any obligation to install the same on products previously manufactured.
6. The consumer forfeits the benefits of this warranty if the product's main assembly is opened and tampered with by anyone other than a certified DigiTech technician or, if the product is used with AC voltages outside of the range suggested by the manufacturer.
7. The foregoing is in lieu of all other warranties, expressed or implied, and DigiTech neither assumes nor authorizes any person to assume any obligation or liability in connection with the sale of this product. In no event shall DigiTech or its dealers be liable for special or consequential damages or from any delay in the performance of this warranty due to causes beyond their control.

NOTE: The information contained in this manual is subject to change at any time without notification. Some information contained in this manual may also be inaccurate due to undocumented changes in the product or operating system since this version of the manual was completed. The information contained in this version of the owner's manual supersedes all previous versions.

Table of Contents

Safety Information	I
Declaration of Conformity	II
Warranty	III
Table of Contents	III

Section One - Introduction

Getting Acquainted	I
Included Items	I
A Guided Tour	2
Front Panel	2
Rear Panel	3
Getting Started	4
Making Connections	4
Mono Operation	4
Stereo Operation	4
Applying Power	5
About the RP300	6
The Presets	6
Performance Mode	6
Bypass Mode	6
Tuner Mode	6
Learn-A-Lick	7
Jam-A-Long	7
Drum Machine	7

Section Two - Editing Functions

Editing/Creating Presets	8
The Matrix	8
Storing/Copying	9

Section Three - Effects and Parameters

About the Effects	10
Effect Definitions	10
Pickup/Wah	10
Compressor	11

Amp Modeling	11
EQ	12
Cabinet/Gate	12
Effects	13
Chorus	13
Flanger	13
Triggered Flange	13
Phaser	14
Triggered Phaser	14
Tremolo	14
Panner	14
Vibrato	15
Rotary	15
Ya Ya™	15
Auto Ya™	15
SynthTalk™	16
Envelope	16
Detune	16
Pitch Shift	16
Whammy™	16
Delay	17
Reverb	17

Section Four - Other Functions

Expression Pedal	18
V-Switch	19
LFO	19
Factory Reset	20
Expression Pedal Calibration	20
V-Switch Sensitivity	21

Section Five - Appendix

Preset List	22
Specifications	23

Section-I Introduction

Getting Acquainted

Congratulations and thank you for your purchase of the RP300A Modeling Guitar Processor. DigiTech commissioned today's top players to contribute their own presets to the RP300A, giving you the latest sounds available from our award winning amp modeling and effects processing. We recommend that you take a few minutes to become better acquainted with what the RP300A has to offer by going through this User's Guide with your RP300A in front of you. It is your key to unlocking the full potential within the RP300A.

Included Items

Before you get started, please make sure that the following items have been included:

- **RP300A**
- **PS0913B Power Supply**
- **Warranty Card**

The utmost care was taken while your RP300A was being manufactured. Everything should be included and in perfect working order. If anything is missing, contact the factory at once. Please help us become acquainted with you and your needs by completing your warranty card. It is your safeguard should a problem arise with your RP300A.

A Guided Tour of the RP300A

The Front Panel

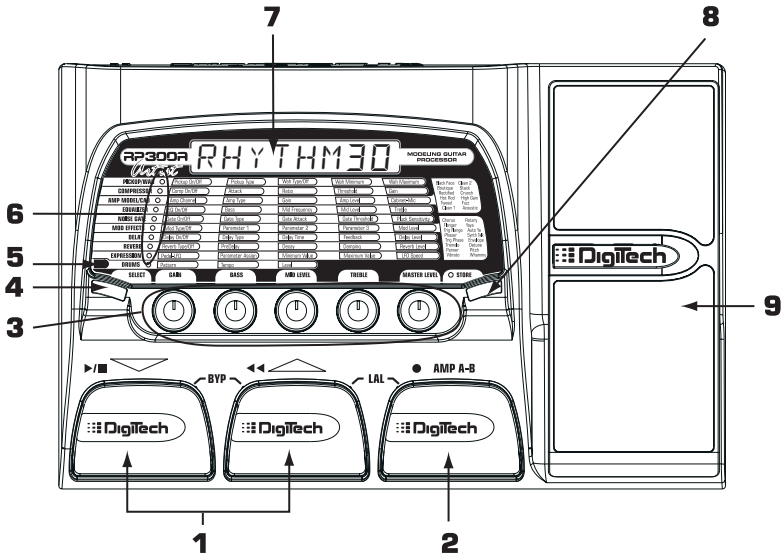

- 1. Up/Down Footswitches** - These 2 Footswitches are used to select Presets, access the Tuner, or bypass the RP300A. The Footswitch on the left will decrease, and the middle Footswitch will increase the Preset number. Pressing both Footswitches together will bypass the currently selected Preset. Pressing and holding both Footswitches will access the Tuner.
- 2. Amp A/B Footswitch** - This Footswitch is used to switch between two amp channels for the selected preset. This switch is also used in conjunction with the Up Footswitch, to access the Learn-A-Lick mode.
- 3. Knobs** - These knobs perform various functions depending on which mode is currently active in the RP300A. In performance mode, the knobs control the Amp Gain, Bass EQ, Mid EQ, Treble EQ, and Master Level. In Edit mode, these knobs adjust the Parameter values listed directly above each knob for the selected effect. When the Drum Machine is on, these knobs control the Pattern, Tempo, and Level. In Tuner mode, these knobs are used to select the desired tuning reference.
- 4. Select Button** - This button is used to enter the Edit mode, and to select individual effects to be edited. Successive presses of this button will advance through all available Effects. It is also used to change playback speed in Learn-A-Lick mode.
- 5. Drums** - The Drums button is used to turn on and off the built-in drum machine. When the drum machine is active, the Drums LED lights and the selected drum pattern play continuously.
- 6. Matrix** - The matrix provides information regarding the current Preset, and Parameter edit functions. In performance mode, the LEDs running down the left side of the Matrix will provide a visual indication of which effects are in use for the currently selected Preset. In Edit mode, the LEDs indicate the Effect currently selected for editing.

7. **Display** - The Display provides information for different functions depending on the mode that is active. In Performance mode, the Display will show the currently selected Preset name and numeric location. In Edit mode, the Display will show the name and value of the selected parameter. In Tuner mode, the Display will show the note being played and whether the note is sharp, flat, or in tune.
8. **Store** - The Store button is used to save your custom edits to the user Presets.
9. **Expression Pedal** - The Expression Pedal adjusts the RP300A's assigned Effect Parameter in real time. Almost every Parameter is available for Expression Pedal control.

Rear Panel

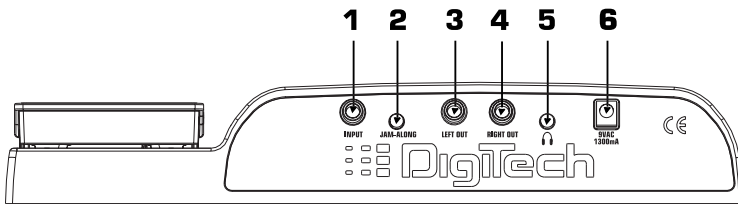

1. **Input** - Connect your instrument to this jack.
2. **Jam-A-Long/Learn-A-Lick Jack** - Connect this jack to the headphone output of a tape or CD player in order to jam along with the music, or to record a musical passage into the Learn-A-Lick phrase recorder. Use an 1/8" stereo plug for this connection. See page 7 for more on using the Jam-A-Long and Learn-A-Lick functions.
3. **Left Output** - Connect from this jack to the input of a single amplifier for mono applications. For stereo applications, connect this output to the input of the left amp, left channel of a power amp, or left channel of a mixing console.
4. **Right Output** - Connect from this jack to the input of the right amp, right channel of a power amp, or right channel of a mixing console.
5. **Headphones** - Connect a pair of stereo headphones to this 1/8" jack.
6. **Power Input** - Connect only the DigiTech PS0913B power supply to this jack.

Getting Started

Making Connections

There are several different connection options available with the RP300A. Before connecting the RP300A, make sure that the power to your amplifier and the RP300A is turned off. There is no power switch on the RP300A. To turn the RP300A on or off, simply connect or disconnect the included PS0913B power supply from the **Power Jack** to an AC outlet.

Mono Operation

Connect your guitar to the **Input** of the RP300A. Connect a single mono instrument cable from the **Left Output** of the RP300A to the instrument input or effect return on your amplifier, to a channel input of a mixer, or to the line input of a power amp. If connecting to a mixing console, be sure to select one of the RP300A's Speaker Cabinet models. See page 12 for more on using the Speaker Cabinet modeling.

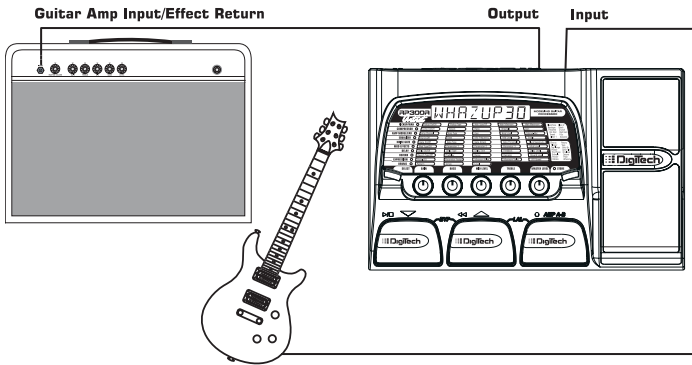

Stereo Operation

For stereo operation connect the guitar to the **Input** of the RP300A. Connect the **Left Output** to the input of one amplifier, channel of a mixer, or power amp. Connect the **Right Output** to a second amplifier, second channel of a mixer, or power amp. If connecting to a mixing console, set the pan controls of the mixer hard left and right in order to retain stereo separation and be sure to select one of the RP300A's Speaker Cabinet models. See page 12 for more on using the Speaker Cabinet modeling.

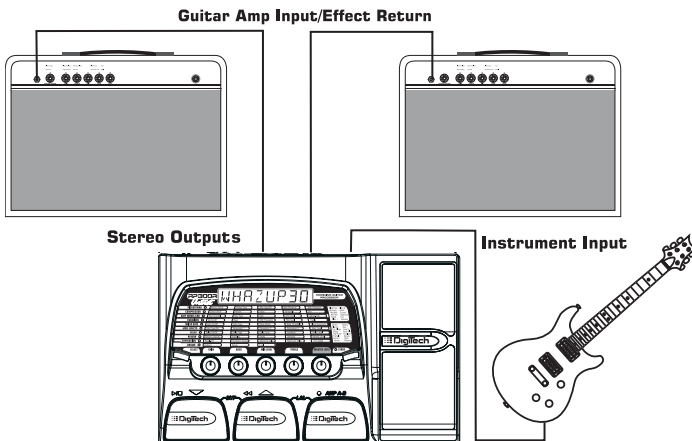

NOTE: When using a guitar amp, it may be best to connect the guitar to the **Input** of the RP300A and the **Output** of the RP300A to the effect return of the amplifier.

Applying Power

Before applying power to anything, set your amp(s) to a clean tone and set the tone controls to a flat EQ response (on most amps, this would be 0 or 5 on the tone controls). Then follow the steps listed below.

1. Turn the amp volume all the way down.
2. Connect the plug of the PS0913B power supply to the **Power Jack** on the rear panel of the RP300A.
3. Connect the other end of the PS0913B power supply to an AC outlet and turn the Master Level knob until the display reads **MLEVEL 0**.
4. Turn the power of your amplifier(s) to the on position and adjust the volume(s) to a normal playing level.
5. Gradually increase the RP300A's **Master Level** to achieve the desired volume.

4. Turn Amp Volume Up

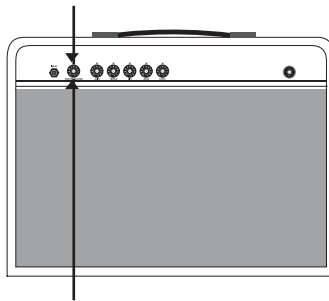

1. Turn Amp Volume Down

2. Connect PS0913B to Power Jack

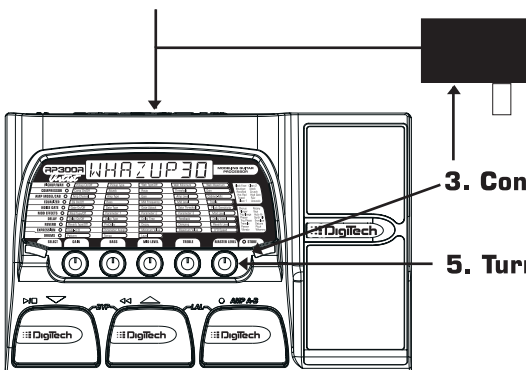

3. Connect PS0913B to AC Outlet

5. Turn RP300 Volume Up

About the RP300A

The Presets

Presets are named and numbered locations of programmed sounds which reside in the RP300A. Presets are recalled with the **Footswitches**. The active effects in each Preset will be indicated by the lighted LEDs in the Effect Matrix. The RP300A comes with 40 User Presets (Presets U1-U40), 40 Factory Artist Presets (Presets A1-A40), and 40 DigiTech factory presets (F1-F40). The User Presets are locations where your creations may be stored. The Artist/Factory Presets will not allow you to store any changes to them. From the factory, the 40 User Presets are exact duplicates of the 40 Factory Artist Presets. This allows you to create your own Presets without the worry of losing the sounds that came with the RP300A.

Performance Mode

When you first apply power to the RP300A, it will power up in Performance mode. Performance mode provides access to all of the Presets within the RP300A via the **Up** and **Down Footswitches**. The **Number 1 Knob** (left) will adjust the Gain for the selected Amp Type, the **Number 2 Knob** (second from the left) will adjust the amount of Bass enhancement, the **Number 3 Knob** (middle) will adjust the amount of Mid-range enhancement, the **Number 4 Knob** (second from the right) will adjust the amount of Treble (high frequency) enhancement, and the **Number 5 Knob** (right) will adjust the Master Level (volume).

Bypass Mode

The RP300A Presets can be bypassed for a clean, unprocessed guitar tone. To bypass the RP300A, press both the **Up** and **Down Footswitches** simultaneously. The Display will read **BYPASS** indicating the Preset is bypassed. Pressing any of the 3 **Footswitches** will exit Bypass and return the RP300A to the previously selected Preset.

Tuner Mode

The Tuner in the RP300A allows you to quickly tune or check the tuning on your guitar. Enter Tuner mode by pressing and holding the **Up** and **Down Footswitches** simultaneously. The Display will briefly show **TUNER** indicating that you are in Tuner mode. To begin tuning, play a note on your guitar (a harmonic at the 12th fret usually works best). The right 2 characters in the Display will show the note being played. The left characters in the Display indicate whether you are sharp or flat. Arrows pointing to the left (<< >) indicate the note is sharp and should be tuned down. Arrows pointing to the right (>> <) indicate the note is flat and should be tuned up. When the note is in tune, the Display will show **TUNE D**.

Indicates Note is Flat Indicates Note is Sharp Display Shows Note Played

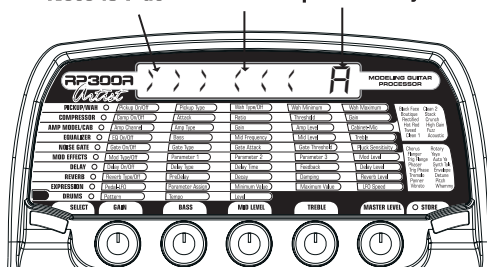

In Tuner mode, you can change your tuning reference. The default factory setting is A=440 Hz. (displayed as A=440). Rotating the **Number 1 Knob** will select alternate dropped tunings. Alternate tunings are A = Ab, A = G, and A = Gb. The display window will briefly flash the currently selected tuning preference.

The output is muted in Tuner mode. The Expression Pedal will unmute the output allowing signal to be heard while tuning. Exit tuner mode by pressing any of the 3 **Footswitches**.

Learn-A-Lick Mode

Learn-A-Lick allows you to record a 10 second passage of music and play it back as slow as 1/4 speed with no change in pitch. This is useful for picking out the notes of a fast solo passage.

There are 6 functions for Learn-A-Lick including:

- Stop (Controlled by the Down Footswitch)
- Rewind (Controlled by the Up Footswitch)
- Play (Controlled by the Down Footswitch)
- Record (Controlled by the Amp A-B Footswitch)
- Playback Speed (Controlled with Select Button)
- Sampled Phrase Volume (Controlled by the Expression Pedal)

Using Learn-A-Lick

1. Connect your CD or tape player headphone output to the **Jam-A-Long** input jack on the rear panel using an 1/8" stereo plug. Set the level of the CD/tape player to a desired listening level.
2. Cue up to the passage you want to record and hit pause on the CD or tape player.
3. Press and hold the **Up** and **Amp A-B** Footswitches to enter Learn-A-Lick mode. The display will briefly read: *LALICK*.
4. When the Display reads *READY*, release the pause button on your playback device and press the **Amp A-B** (Record) Footswitch. The display will read: *RECORDING* and the right two Display digits will provide a time elapsed reference while recording. When recording is completed, the phrase will be set to an auto-loop playback mode indicated by *PLAY* in the Display. Press stop or pause on the CD or Tape player.
5. Use the **Select** button to choose the playback speed. Successive presses of the **Select** button will advance through all playback speeds up to 1/4th of the original speed. Your interval choices include: 1/4, 3/8, 1/2, 5/8, 3/4, 7/8, and *FULL*, speeds.
6. Pressing the **Up** Footswitch steps back through the loop at 1 second intervals.
7. The **Expression Pedal** will control output level of the recorded phrase.
8. To stop or restart the playback, press the **Down** (Stop/Play) Footswitch.
9. To record a new passage, press the **Amp A-B** (Record) Footswitch again.
10. To exit the Learn-A-Lick mode, press and hold the **Up** and **Amp A-B** Footswitches simultaneously.

Jam-A-Long

The Jam-A-Long feature allows you to connect a Tape or CD player to the RP300A, and Jam with your favorite artists. To use the Jam-A-Long feature, connect the headphone output of your tape or CD player to the **Jam-A-Long** input on the rear panel of the RP300A using an 1/8" stereo cable. Then press play on your tape or CD player. The signal from your tape or CD player is routed to the left, right, and headphone outputs of the RP300A.

Drum Machine

The RP300A includes several sampled drum patterns which are useful for developing a good sense of timing. Pressing the **Drums** button will enable the built-in drum machine (except when in Store or Bypass mode). When the drum machine is active:

The **Number 1 Knob** is used to select the drum Pattern. Choices include:

ROCK 1	HR0CK3	FUNK3	DANCE4	SWING1
ROCK 2	POP1	BLUES	URBAN1	SWING2
ROCK 3	POP2	JAZZ	URBAN2	REGGAE
ROCK 4	POP3	DANCE1	ENTRY1	CHACHA
HR0CK1	FUNK1	DANCE2	ENTRY2	BOSSA1
HR0CK2	FUNK2	DANCE3	ENTRY3	BOSSA2

The **Number 2 Knob** adjusts the drum Tempo and ranges from *BPM 40* (40 beats per minute) to *BPM240* (240 beats per minute).

The **Number 3 Knob** adjusts the volume Level of the drum loop and ranges from *1* to *99*. Press the **Drums** button again to stop playback of the drum loop.

Section Two - Editing Functions

Editing/Creating Presets

Creating your own signature sound with the RP300A is easy and intuitive. The RP300A lets you create your own Presets, or fine tune existing Presets to suit your needs. When creating or editing a sound, you must first start with one of the User, Artist Factory, or Factory Presets. It is not possible to start with a completely empty Preset. The Preset number does not necessarily need to be the location which you intend to have it reside, as you can save your creation to any User Preset location during the store process.

To edit or create a Preset:

1. Use the **Up** or **Down Footswitches** to select a Preset which will be your starting point.
2. Once you have found a Preset that you wish to edit, press the **Select** button once. This will take you into the Editing mode.
3. Use the **Select** button in conjunction with the **Matrix LEDs** to choose the effect you wish to edit. Successive presses of the **Select** button will advance to the next Effect in the Matrix.
4. Use the **5 Knobs** to change parameter values.
5. Store your edited Preset. See page 9 for more on the Store procedure.

The Matrix

The Matrix is where all Effects and Parameters are selected for editing. In Edit mode, successive presses of the **Select** button will advance to the next Effect row. The LED will light to indicate which Effect group has been selected. Each Effect group will have up to 5 Parameters which can be modified. The **Knob** directly below each column is used to change the Parameter value of the selected Effect. As a **Knob** is rotated, the corresponding Parameter's name and value or status will be shown in the Display.

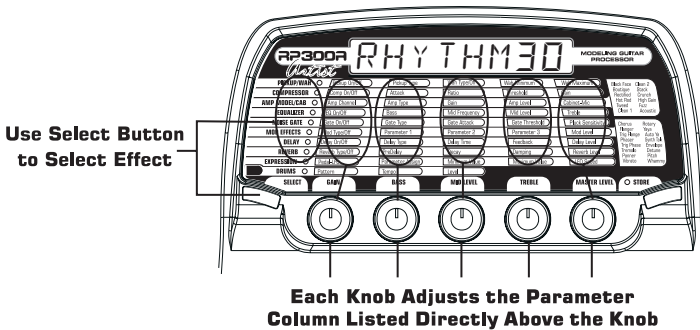

When the stored value of a Parameter is changed, the Store LED will light indicating that you need to store the changes. Changing Presets, or turning the power off before storing will erase any changes made and the RP300A will revert to the stored values for the Preset.

Storing/Copying/Naming a Preset

Once the Preset has been modified to your liking, you may store your settings to any of the 40 User Preset locations (Presets UI-U40). The following steps outline the procedure for storing changes to a Preset or copying a Preset to a different location:

1. Press the **Store** button once. The Store button LED will blink and the first character in the Display will Flash indicating that you can now name your custom creation.
2. Use the **Number 1 Knob** or **Up/Down Footswitches** to select the desired alpha-numeric character.
3. Rotate the **Number 2 Knob** clockwise to select the next character location, and counterclockwise to select the previous character location. Then repeat step 2 to select the desired alpha-numeric character.

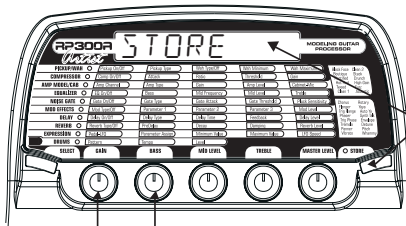

1. Press Store and Characters in Display Flash Individually

2. Number 1 Knob Selects Alpha-Numeric Characters

3. Number 2 Knob Selects Next or Previous Characters in Display

4. Once the desired name is shown in the display, press the **Store** button again to enter the second stage of the storing process. The Display will alternate between showing the new name, and the name of the Preset about to be overwritten.
5. Select the User Preset location your new sound will reside in using the **Number 5 Knob** or the **Up/Down Footswitches**. The Display will continue to alternate between showing the new Preset name and name of the Preset about to be overwritten.

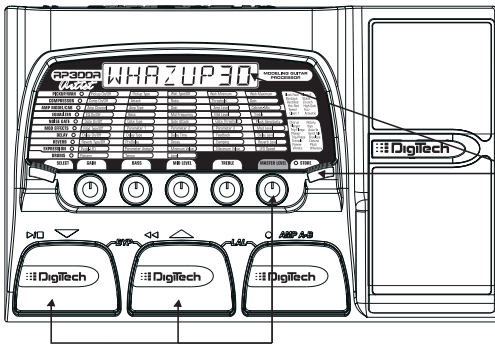

4. Press Store Again Preset Name and Numeric Location Flash in Display

5. Select Numeric Destination with Footswitches or Number 5 Knob

6. Press the **Store** button again to save the changes.

Press the **Select** or **Drums** buttons at any time to abort the Store procedure.

The procedure for copying one Preset to another Preset location is the same. Simply use the **Footswitches** to select the Preset that you want to copy, then follow the steps listed above.

Section Three - Effects and Parameters

About the Effects

The RP300A can be thought of as several different “virtual” amplifiers and individual, hi-tech stomp boxes in a single programmable package. With stomp boxes, the order in which they are connected can drastically affect the overall sound quality. The RP300A has placed the Effects in an order for optimum sound quality. The following diagram shows the order of the effects contained in the RP300A.

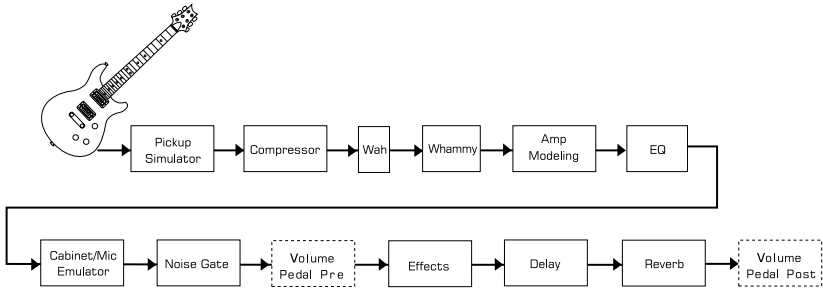

Effect Definitions

Each Effect within the RP300A can be programmed to suit your personal taste and application. Understanding how these Effects will alter the sound, and how each Parameter will alter the Effect will help you achieve the sound you are looking for. The following overview of the RP300A's Effects outlines what each Effect and Parameter does.

Pickup/Wah

The **Pickup Simulator** provides the thick tone of a humbucker pickup to a guitar with single coil pickups, or the bright edgy sound of a single coil pickup to a guitar with a humbucker. This allows you to have the best of both worlds without having to change guitars during a performance.

Wah is an effect controlled by the Expression Pedal. As the Expression Pedal is rocked back and forth, it makes the guitar sound as if it is saying “Wah.” The Wah is engaged and disengaged by applying pressure to the V-Switch located under the toe of the Expression Pedal. See Page 19 for more information regarding the V-Switch.

Pickup On/Off - The **Number 1 Knob** turns the Pickup simulator on (ON) and off (OFF).

Pickup Type - The **Number 2 Knob** selects the type of Pick Up to be simulated. Values include: *SC > HUM* (Gives a single coil pick up the warm tone of a humbucker), and *HUM > SC* (Gives a humbucker the unique sound of a single coil).

Wah Type - The **Number 3 Knob** selects the type of Wah. Values include: *CRY* (Cry Wah is a traditional sounding Wah), *BOUTIQ* (Boutique Wah is a wide sweeping Wah with a more modern sound) and *FULRNG* (Full Range Wah sweeps the entire spectrum of audible frequencies).

Wah Minimum - The **Number 4 Knob** is used to select the minimum point the Wah will reach in the toe up position of the Expression Pedal. Ranges from 1 to 99.

Wah Maximum - The **Number 5 Knob** is used to select the maximum point the Wah will reach in the toe down position of the Expression Pedal. Ranges from 1 to 99.

Compressor

A **Compressor** is used to increase sustain, tighten up the guitar signal, and prevent the signal from clipping the input of other effects. It sets a maximum boundary (Threshold) for the strength of a signal. If a signal exceeds the Threshold, it is squeezed back into compliance based upon the compression Ratio setting.

Comp On/Off - The **Number 1 Knob** turns the Compressor on (ON) and off (OFF).

Attack - The **Number 2 Knob** adjusts the length of time it takes for the Compressor to respond to a signal exceeding the Threshold. Values include: *FAST*, *MEDIUM*, and *SLOW*.

Ratio - The **Number 3 Knob** adjusts the input to output ratio once the Threshold has been exceeded. For instance, a Ratio of 4 to 1 means that a signal exceeding the Threshold by 4 dB will only be allowed 1 dB of increased output. Ranges include: *1 2-1* (1.2 to 1), *1 5-1* (1.5 to 1), *1 8-1* (1.8 to 1), *2 0-1* (2 to 1), *2 5-1* (2.5 to 1), *3 0-1* (3 to 1), *4 0-1* (4 to 1), *5 0-1* (5 to 1), *8 0-1* (8 to 1), *10 0-1* (10 to 1), *20 0-1* (20 to 1), and *∞-1* (infinity to 1).

Threshold - The **Number 4 Knob** adjusts the maximum strength the signal is allowed to reach before the compressor begins to work. Ranges from *1* to *99*.

Gain - The **Number 5 Knob** adjusts the Output Gain from the Compressor. Ranges from *0* to *6* (dB).

Amp Modeling/Cab

Amp Modeling is a technology which applies the tone of one of several vintage or modern amps to your guitar signal. The RP300A's Amp Modeling also provides an acoustic guitar simulation. The Amp Modeling section includes an A and a B channel. Each channel can be individually programmed to include different settings for Amp Gain, Amp Level, Cabinet Type, Mic Position, and EQ. This allows you to switch from a clean to a distorted setting while retaining all other Effects settings. Switching Amp channels is accomplished instantly with the **Amp A/B Footswitch**.

The **Cabinet Modeling** simulates different types of miked speaker cabinets. You have your choice of 6 Cabinet Types and 4 Mic Placements in relationship to each speaker cabinet.

Amp Channel - The **Number 1 Knob** selects the *A* or *B* channel. You may also use the **A/B Footswitch** to select the amp channel during the editing process.

Amp Type - The **Number 2 Knob** selects one of the Amp Models or Acoustic Simulator. Choices include:

DIRECT - Turns the modeling off

BLKFACE - Based on a '65 Fender Twin Reverb

BOUQU - Based on a Matchless DC30

RECTIF - Based on a Mesa Dual Rectifier

HOTROD - Based on a Mesa Boogie Mark II C

TWEED - Based on a '57 Fender Tweed Deluxe

CLEAN1 - Based on a Vox AC30 top boost

CLEAN2 - A clean tube combo setting

STACK - Based on a Marshall JCM900

CRUNCH - A nice crunchy combo

HIGAIN - Based on a Johnson JM150 High Gain

FUZZ - A vintage fuzz distortion

ACOUST - A flat top acoustic guitar

Marshall® is a registered trademark of Marshall Amplification Plc. Vox® is a registered trademark of Korg UK. Fender, Matchless, and Mesa Boogie, are trademarks of their respective companies and are in no way associated with DigiTech.

Amp Gain - The **Number 3 Knob** adjusts the Gain (distortion) for the selected Amp Model (not available for Acoustic). The Gain parameter ranges from *0* to *99*.

Amp Level - The **Number 4 Knob** adjusts the Level (volume) of the selected Amp Model. The Level parameter ranges from *1* to *99*.

Cabinet-Mic - The **Number 5 Knob** selects the type of simulated Speaker cabinet as well as mic placement in relation to the speaker. Your choices include:

DIRECT - Cabinet Off

1x12 1 - 1x12 Mic 1

1x12 2 - 1x12 Mic 2

1x12 3 - 1x12 Mic 3

1x12 4 - 1x12 Mic 4

4x12V 1 - 4x12 Vintage Mic 1

4x12V 2 - 4x12 Vintage Mic 2

4x12V 3 - 4x12 Vintage Mic 3

4x12V 4 - 4x12 Vintage Mic 4

2x120 1 - 2x12 Open Back Mic 1

2x120 2 - 2x12 Open Back Mic 2

2x120 3 - 2x12 Open Back Mic 3

2x120 4 - 2x12 Open Back Mic 4

4x12B 1 - 4x12 British Mic 1

4x12B 2 - 4x12 British Mic 2

4x12B 3 - 4x12 British Mic 3

4x12B 4 - 4x12 British Mic 4

2x12C 1 - 2x12 Closed Back Mic 1

2x12C 2 - 2x12 Closed Back Mic 2

2x12C 3 - 2x12 Closed Back Mic 3

2x12C 4 - 2x12 Closed Back Mic 4

4x12G 1 - 4x12 Green Mic 1

4x12G 2 - 4x12 Green Mic 2

4x12G 3 - 4x12 Green Mic 3

4x12G 4 - 4x12 Green Mic 4

The following diagram shows the difference between the Mic 1 through Mic 4 selections:

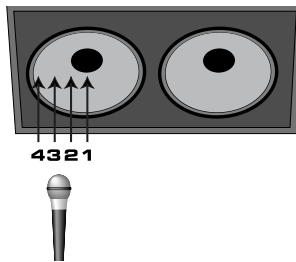

EQ

Equalization is an extremely useful tool used to further shape the tonal response of your guitar signal. The EQ in the RP300A is similar to the tone knobs on an amplifier. All three EQ parameters range from -12dB to +12 dB.

EQ On/Off - The **Number 1 Knob** turns the EQ on (ON) and off (OFF).

Bass - The **Number 2 Knob** adjusts the amount of low end enhancement.

Mid Frequency - The **Number 3 Knob** selects the frequency to which the boost will be applied by the mid level knob. Ranges from 500HZ (500 Hz.) to 3000HZ (3000 Hz.)

Mid Level - The **Number 4 Knob** adjusts the amount of mid range enhancement.

Treble - The **Number 5 Knob** adjusts the amount of high end enhancement.

Noise Gate

A **Noise Gate** is designed to eliminate hiss and ambient noise while you are not playing. A Noise Gate can also be used to create an automatic swell in volume. The RP300A includes two different types of Noise Gates: Silencer™, and Pluck. The Silencer™ operates as a standard Noise Gate. The Pluck Noise Gate is designed to close after every note (depending on the Pluck Sensitivity). This allows automatic volume swells to occur on a note for note basis.

Gate On/Off - The **Number 1 Knob** turns the Noise Gate on (ON) and off (OFF).

Gate Type - The **Number 2 Knob** selects between the *SILNCER* (Silencer™) or *PLUCK* (Pluck) type of Noise Gates.

Gate Attack - The **Number 3 Knob** adjusts the length of time it takes the gate to open once the Threshold has been exceeded before the signal becomes audible. Ranges from 1 (immediate signal), to 9 (Selects the Auto Swell volume swell effect. This setting will gradually ramp up the volume).

Gate Threshold - The **Number 4 Knob** sets the signal strength required to open or close the Noise Gate. The Gate Threshold parameter ranges from 1 (opens easily) to 40 (requires strong signals to open).

Pluck Sensitivity - The **Number 5 Knob** controls the point where the Gate re-triggers when using the Pluck type Noise Gate. This Parameter is only available when Pluck is the selected type of Noise Gate. Ranges from 1 (requires strong signals to re-trigger) to 99 (re-triggers with weak signals).

Mod Effects

The Modulation Effects row in the RP300A is a multi-function module allowing you to select effects such as; Chorus, Flanger, Triggered Flanger, Phaser, Triggered Phaser, Tremolo, Panner, Vibrato, Rotary Speaker, YaYa™, AutoYa™, SynthTalk™, Envelope Filter (auto wah), Detune, Pitch Shift, and Whammy™ effects. When the Effects row is selected, the **Number 1 Knob** is used to turn the Effect module (EFFECT OFF), and select the type of Modulation Effect to be used. Only one of the effects in this row can be used at a time. After selecting the type of effect in this module, the **Number 2, Number 3, Number 4, and Number 5 Knobs** can then be used to adjust the individual Parameters associated with the selected effect. The following list describes each Effect and their Parameters in more detail:

Chorus (CHORUS)

A **Chorus** adds a short delay to your signal. The delayed signal is modulated in and out of tune and then mixed back with the original signal to create a thicker sound.

Parameter 1 - The **Number 2 Knob** adjusts the rate (Speed) of the modulation. Ranges from 1 to 99.

Parameter 2 - The **Number 3 Knob** adjusts the intensity (Depth) of the modulation. Ranges from 1 to 99.

Mod Level - The **Number 5 Knob** controls the volume of the Chorus. Ranges from 0 to 99.

The Number 4 Knob has no function when the Chorus is selected.

Flange (FLANGE)

A **Flanger** uses the same principle as a Chorus but uses a shorter delay time and adds regeneration (or repeats) to the modulating delay. This results in an exaggerated up and down sweeping motion to the effect.

Parameter 1 - The **Number 2 Knob** adjusts the rate (Speed) of the modulation. Ranges from 1 to 99.

Parameter 2 - The **Number 3 Knob** adjusts the intensity (Depth) of the Modulation. Ranges from 1 to 99.

Parameter 3 - The **Number 4 Knob** adjusts the amount of regeneration (repeats) added to the Flanger delay. Ranges from 1 to 99.

Mod Level - The **Number 5 Knob** controls the mix of wet and dry signal. Ranges from 0 (all dry) to 99 (all wet).

Triggered Flanger (TRGF LG)

A **Triggered Flanger** is the same sound as a regular Flanger but allows you to choose the starting point of the Flanger sweep. In a regular Flanger, the low frequency oscillator (LFO) is continually sweeping up and down. This means that when you begin to play, the flanger may be at the top, bottom, or any random point of the sweep. With a Triggered Flanger, every time the signal exceeds the **Sensitivity** level setting, the Flanger will begin at the point of the sweep that you designate with the value of the **LFO Start** Parameter.

Parameter 1 - The **Number 2 Knob** adjusts the rate (Speed) of the modulation. Ranges from 1 to 99.

Parameter 2 - The **Number 3 Knob** adjusts the strength the signal must be (Sensitivity) in order to trigger the Flanger. Ranges from 1 (requiring strong signals to trigger) to 99 (triggers with weak signals).

Parameter 3 - The **Number 4 Knob** selects the point at where the Flanger will begin its sweep (LFO Start). Ranges from 0 to 99.

Mod Level - The **Number 5 Knob** controls the mix of wet and dry signal. Ranges from 0 (all dry) to 99 (all wet).

Phaser (PHASER)

A **Phaser** splits the incoming signal, and then changes the phasing of the signal. This signal is then taken in and out of phase and mixed back in with the original signal. As the phasing changes, different frequencies get canceled resulting in a warm sort of twisting sound.

Parameter 1 - The **Number 2 Knob** adjusts the rate (Speed) of the modulating phase. Ranges from 1 to 99.

Parameter 2 - The **Number 3 Knob** adjusts the intensity (Depth) of the modulation. Ranges from 1 to 99.

Parameter 3 - The **Number 4 Knob** adjusts the amount of effected signal returned to the input of the Phaser (Regeneration). Ranges from 1 to 99.

Mod Level - The **Number 5 Knob** controls the mix of wet and dry signal. Ranges from 0 (all dry) to 99 (all wet).

Triggered Phaser (TRGPHR)

A **Triggered Phaser** is the same sound as a regular Phaser but allows you to choose the starting point of the Phaser sweep. In a regular Phaser, the low frequency oscillator (LFO) is continually changing the phase of the signal. This means that when you begin to play, the phaser may be at the any random point of the phase. With a Triggered Phaser, every time the signal exceeds the **Sensitivity** level setting, the Phaser will begin at the point of phasing that you designate with the value of the **LFO Start** Parameter.

Parameter 1 - The **Number 2 Knob** adjusts the rate (Speed) of the modulating phase. Ranges from 1 to 99.

Parameter 2 - The **Number 3 Knob** adjusts the strength the signal must be (Sensitivity) in order to trigger the Phaser. Ranges from 1 (requiring strong signals to trigger) to 99 (triggers with weak signals).

Parameter 3 - The **Number 4 Knob** selects the point at where the Phaser will begin its sweep (LFO Start). Ranges from 0 to 99.

Mod Level - The **Number 5 Knob** controls the mix of wet and dry signal. Ranges from 0 (all dry) to 99 (all wet).

Tremolo (TREMLO)

A **Tremolo** effect modulates the volume of the signal at an even rate.

Parameter 1 - The **Number 2 Knob** adjusts the rate (Speed) at which the volume modulates. Ranges from 1 to 99.

Parameter 2 - The **Number 3 Knob** adjusts the intensity (Depth) of the modulating volume. Ranges from 0 to 99.

The Number 4 and 5 knobs have no function when the Tremolo is selected.

Panner (PANNER)

An **Auto Panner** modulates the sound from left to right at an even rate.

Parameter 1 - The **Number 2 Knob** adjusts the rate (Speed) at which the signal pans from side to side. Ranges from 1 to 99.

Parameter 2 - The **Number 3 Knob** adjusts the intensity (Depth) of the changing pan. Ranges from 0 to 99.

The Number 4 and 5 knobs have no function when the Panner is selected.

Vibrato (VIBRATO)

A **Vibrato** effect modulates the pitch of the incoming signal at an even rate.

Parameter 1 - The **Number 2 Knob** adjusts the rate (Speed) at which the pitch modulates. Ranges from 1 to 99.

Parameter 2 - The **Number 3 Knob** adjusts the intensity (Depth) of the modulating pitch. Ranges from 1 to 99.

The Number 4 and 5 knobs have no function when the Vibrato is selected.

Rotary Speaker (ROTARY)

Rotary Speaker is an emulation of a device that included a spinning horn and rotor (woofer). The rotation of these two speakers produced an interesting combination of the sound panning from side to side, as well as a slight pitch change due to speed of the sound coming towards, and then going away from the listener.

Parameter 1 - The **Number 2 Knob** adjusts the rate (Speed) of the spinning speakers. Ranges from 1 to 99.

Parameter 2 - The **Number 3 Knob** controls the intensity of the Effect. Ranges from 0 to 99.

Parameter 3 - The **Number 4 Knob** controls the doppler effect which is the ratio between the horn and the rotor positions. Ranges from 1 to 99.

Mod Level - The **Number 5 Knob** controls the mix of wet and dry signal. Ranges from 0 (all dry) to 99 (all wet).

YaYa™ (YAYÄ)

The **YaYa™** is an effect exclusive to DigiTech products. The **YaYa™** is controlled by the Expression Pedal and combines the characteristics of a wah and a flanger together providing a unique talk box type of effect. As the Expression Pedal is rocked back and forth, the guitar appears to say "Yah." The **YaYa™** effect must be linked to the Expression Pedal in order to function. See page 18 for more information on linking the Expression Pedal.

Parameter 1 - The **Number 2 Knob** adjusts the Pedal.

Parameter 2 - The **Number 3 Knob** adjusts the intensity of the **YaYa™** effect. Ranges from 1 to 99.

Parameter 3 - The **Number 4 Knob** adjusts the throaty quality of the **YaYa™** effect. Ranges from 1 to 50.

Mod Level - The **Number 5 Knob** controls the mix of wet and dry signal. Ranges from 0 (all dry) to 99 (all wet).

AutoYa™ (AUTOYÄ)

Like the **YaYa™**, an **AutoYa™** combines the characteristics of a Wah and a Flanger together creating an almost human vowel sound as if the guitar were saying "Yah." The **AutoYa™** automatically provides this animation by modulating the sound at an even rate.

Parameter 1 - The **Number 2 Knob** adjusts the rate (Speed) of the modulation. Ranges from 1 to 99.

Parameter 2 - The **Number 3 Knob** adjusts the intensity of the **AutoYa™** effect. Ranges from 1 to 99.

Parameter 3 - The **Number 4 Knob** adjusts the throaty quality of the **AutoYa™** effect. Ranges from 1 to 50.

Mod Level - The **Number 5 Knob** controls the mix of wet and dry signal. Ranges from 0 (all dry) to 99 (all wet).

SynthTalk™ (SYNTLK)

SynthTalk™ is another effect exclusive to DigiTech. It makes your guitar seem to speak based upon the dynamics of your playing style.

Parameter 1 - The **Number 2 Knob** adjusts the Attack of the synthesized voice. Ranges from 1 to 99.

Parameter 2 - The **Number 3 Knob** adjusts the Release of the synthesized voice. Ranges from 1 to 99.

Parameter 3 - The **Number 4 Knob** changes the characteristics of the various synth voices. Ranges from 0 to 99.

Mod Level - The **Number 5 Knob** adjusts the sensitivity or the input signal required to trigger the SynthTalk™ effect. Ranges from 0 to 99.

Envelope Filter (ENVELOP)

The **Envelope Filter** is an automatic Wah effect that alters your sound based upon how hard the strings are struck.

Parameter 1 - The **Number 2 Knob** adjusts amount of Wah sweep once the Wah is triggered. Ranges from 1 to 99.

Parameter 2 - The **Number 3 Knob** adjusts the sensitivity or the input signal required to trigger the Wah effect. Ranges from 1 to 99.

Mod Level - The **Number 5 Knob** controls the mix of wet and dry signal. Ranges from 0 (all dry) to 99 (all wet).

The Number 4 Knob has no function when the Envelope Filter is selected.

Detune (DETUNE)

A **Detuner** will make a copy of your incoming signal, take the copied signal slightly out of tune from the original, and mix the two signals together. The result is a doubling type of effect as if two guitars were playing the same part together.

Parameter 1 - The **Number 2 Knob** adjusts the amount of pitch difference applied to the copied signal. Ranges from -18 to 18.

Mod Level - The **Number 5 Knob** controls the volume of the detuned note. Ranges from 0 to 99.

The Number 3 and 4 knobs have no function when the Detune effect is selected.

Pitch Shift (PITCH)

A **Pitch Shifter** copies the incoming signal, then shifts the pitch of the copied note to a different note. The shifted note is then mixed back with the original signal sounding as if two guitars were playing in harmony.

Parameter 1 - The **Number 2 Knob** selects the interval of the shifted pitch. Ranges from -12 (12 semitones below) to 24 (24 semitones above).

Mod Level - The **Number 5 Knob** controls the volume of the shifted pitch. Ranges from 0 to 99.

The Number 3 and 4 knobs have no function when the Pitch Shift effect is selected.

Whammy™ (WHAMMY)

Whammy™ is an effect that uses an Expression Pedal to bend the pitch of the incoming signal, or add a bendable harmony with the original signal. As the Pedal is moved, the note will bend either up or down. When Whammy™ is selected, it is automatically placed before the Amp Modeling as shown in the block diagram (at the beginning of the Effects section). The Whammy™ effect must be linked to the Expression Pedal in order to function. See page 18 for more information on linking the Expression Pedal.

Parameter 1 - The **Number 2 Knob** selects the interval and direction of the pitch bend. Choices are as follows:

Whammy (no Dry Signal)

1OCTUP (1 octave above)
2OCTUP (2 octaves above)
2NDOWN (a second below)
REV2ND (a second below reversed pedal action)
4THDOWN (a fourth below)
1OCTDN (an octave below)
2OCTDN (2 octaves below)
DIVEBOMB (Dive Bomb)

Harmony Bends (Dry Signal Added)

M3>M3 (a minor third to a Major third)
2NDMA3 (a second above to a Major third above)
3RD4TH (a third above to a fourth above)
4TH5TH (a fourth above to a fifth above)
5THOCT (a fifth above to an octave above)
HOCTUP (one octave above)
HOCTDN (one octave down)

Mod Level - The **Number 5 Knob** adjusts the volume of the Whammy™. Ranges from 0 to 99.

The Number 3 and 4 knobs have no function when the Whammy™ is selected.

Delay

Delay is an effect that will record a portion of the incoming signal, and then play it back a short time later. The recording can repeat just once, several times, or infinitely (which turns off the input to the Delay and allows you to play over the top of a passage in the Delay loop).

Delay On/Off - The **Number 1 Knob** turns the Delay on (ON) and off (OFF).

Delay Type - The **Number 2 Knob** selects one of the 3 different types of Delay. Values include: DIGITAL (Digital Delay), ANALOG (Analog Delay), P PONG (Ping Pong Delay).

Delay Time - The **Number 3 Knob** adjusts the amount of Delay time. Ranges from 10 MS through 990 MS (10 through 990 ms in 10 ms increments), and 1.0 SEC through 2.0 SEC (1 second through 2 seconds in 100 ms increments).

Feedback - The **Number 4 Knob** adjusts the number of times the delayed signal will repeat. Ranges from 1 to 99 and HOLD (infinite repeat).

Delay Level - The **Number 5 Knob** adjusts the volume of the Delay signal. Ranges from 0 to 99.

Reverb

Reverb can give the listener a sense that the material is being performed in various acoustical environments. It can provide the tight acoustics of a small room, or the ambience of huge arena.

Reverb Type - The **Number 1 Knob** selects the Type of Reverb or acoustic environment.

The RP300A provides your choice of ten different environments including:

REV OFF = Reverb Off	PLATE = Plate	GARAGE = Parking Garage
STUDIO = Studio	HALL = Hall	ARENA = Arena
ROOM = Wood Room	AMPTHE = Amplitheater	SPRING = Spring
CLUB = Club	CHURCH = Church	

PreDelay - The **Number 2 Knob** adjusts the amount of time it takes for the initial sound to reach the first reflective surface in the simulated environment. Ranges from 0 to 15.

Decay - The **Number 3 Knob** adjusts the length of time the Reverb is audible. Ranges from 1 to 99.

Damping - The **Number 4 Knob** controls the amount of sound which is absorbed in the simulated environment. Ranges from 0 to 99.

Reverb Level - The **Number 5 Knob** adjusts the volume of the Reverb. Ranges from 0 to 99.

Section Four - Other Functions

Expression Pedal

The Expression Pedal on the RP300A can be assigned to control the RP300A's Volume, Whammy™, Ya Ya™, or just about any other parameter in real time with your foot. When a parameter has been assigned to the Expression Pedal, a programmable minimum and maximum value can also be assigned. The procedure for assigning a parameter to the Expression Pedal is as follows:

1. Press the **Select** button until the Expression row has been selected (indicated by the LED lighting on the Expression row).
2. Rotate the **Number 1 Knob** until the word *PEDAL* appears in the Display.
3. Rotate the **Number 2 Knob** until the desired Parameter appears in the Display. Your choices include:

A *GAIN* (Amp Gain) - Expression Pedal controls the Amp Gain or amount of distortion for the selected Amp Type.

A *MPLVL* (Amp Level) - Expression Pedal controls the Volume of the selected Amp Type.

Modulation Effects Parameters

Active Effect	Available Parameters
---------------	----------------------

Chorus	<i>SPEED</i> (Speed), <i>DEPTH</i> (Depth)
Flanger	<i>SPEED</i> (Speed), <i>DEPTH</i> (Depth), <i>REGEN</i> (Regeneration)
Triggered Flanger	<i>SPEED</i> (Speed), <i>SENSIV</i> (Sensitivity), <i>LFOSTR</i> (LFO Start)
Phaser	<i>SPEED</i> (Speed), <i>DEPTH</i> (Depth), <i>REGEN</i> (Regeneration)
Triggered Phaser	<i>SPEED</i> (Speed), <i>SENSIV</i> (Sensitivity), <i>LFOSTR</i> (LFO Start)
Tremolo	<i>SPEED</i> (Speed), <i>DEPTH</i> (Depth)
Vibrato	<i>SPEED</i> (Speed), <i>DEPTH</i> (Depth)
Rotary Speaker	<i>SPEED</i> (Speed), <i>DEPTH</i> (Depth), <i>DOPPLER</i> (Doppler)
Panner	<i>SPEED</i> (Speed), <i>DEPTH</i> (Depth)
YaYa™	<i>PEDAL</i> (Pedal), <i>DEPTH</i> (Depth), <i>RANGE</i> (Range)
Auto Ya™	<i>SPEED</i> (Speed), <i>DEPTH</i> (Depth), <i>RANGE</i> (Range)
SynthTalk	<i>ATTACK</i> (Attack), <i>RELEASE</i> (Release), <i>VOX</i> (Vox), <i>SENSIV</i> (Sensitivity)
Envelope Filter	<i>AMOUNT</i> (Amount), <i>SENSIV</i> (Sensitivity)
Detune	<i>AMOUNT</i> (Amount)
Pitch Shift	<i>AMOUNT</i> (Amount)
Whammy™	<i>AMOUNT</i> (Amount)

Y *Y* *A* (YaYa™) - Expression Pedal acts as a Ya Ya™ Effect when Ya Ya™ is engaged.

W *H* *A* *M* *M* *Y* (Whammy™) - Expression Pedal acts as a Whammy™ Pedal when Whammy™ is engaged.

E *F* *F* *L* *V* *L* (Effect Level) - Expression Pedal controls the Mix Level of the selected Modulation Effect Type.

F *B* *A* *C* *K* (Feedback) - Expression Pedal controls the amount of Delay Feedback.

D *L* *A* *I* *V* *L* *V* (Delay Level) - Expression Pedal controls the Mix Level of the selected Delay Type.

D *E* *C* *A* *I* (Decay) - Expression Pedal controls the length of Reverbs Decay time.

R *E* *V* *L* *V* *L* (Reverb Level) - Expression Pedal controls the Reverbs Mix Level.

V *O* *L* *P* *R* *E* (Volume Pre) - Expression Pedal controls the Volume after the Amp Modeling but before the Effects.

V *O* *L* *P* *O* *S* *T* (Volume Post) - Expression Pedal controls the Volume at the end of the Effects chain.

3. Rotate the **Number 3 Knob** to select the minimum value the assigned parameter will reach with the Expression Pedal in the toe up position (not available when volume is the assigned parameter).
4. Rotate the **Number 4 Knob** to select the maximum value the assigned parameter will reach with the Expression Pedal in the toe down position (not available when volume is the assigned parameter).
5. Store your Expression Pedal assignment to your Preset. See page 9 for more information on the storing procedure.

V-Switch

The RP300A's Expression Pedal includes DigiTech's exclusive V-Switch. The V-Switch allows the Expression Pedal assignment to be switched on the fly. Applying extra pressure to the toe of the Expression Pedal will engage the V-Switch and the function of the Expression Pedal will switch between the assigned parameter and Wah. The sensitivity or amount of pressure required to engage the V-Switch can be adjusted to suit your personal taste (or weight of your foot). See page 21 for the V-Switch Sensitivity adjustment procedure.

LFO

The RP300A includes two assignable low frequency oscillators (LFO TR and LFO SQ) which can be assigned to any of the same parameters available for assignment to the Expression Pedal. A low frequency oscillator will automatically vary the value of the assigned parameter at a steady rate. A minimum and maximum value each LFO will reach may be also be assigned. For instance; if the Amp Gain was assigned to LFO TR, and the minimum value was set at 1 and the maximum value was set at 99, the RP300A would automatically sweep the amount of distortion from a clean sound to a distorted sound. Individual LFO speeds are also available for assignment. In the previous example, the LFO speed would determine the length of time it took the LFO to sweep from the clean to the distorted sound. LFO TR oscillates using a triangle waveform and LFO SQ uses a square waveform. The procedure for assigning the LFOs in the RP300A is as follows:

1. Press the **Select** button until the Expression row has been selected (indicated by the LED lighting on the Expression row).
2. Rotate the **Number 1 Knob** to select whether you want to assign *LFO TR* (LFO TR) or *LFO SQ* (LFO SQ).
3. Rotate the **Number 2 Knob** until the desired Parameter appears in the Display. Your choices include:

A GAIN (Amp Gain) - The LFO controls the Amp Gain or amount of distortion for the selected Amp Type.

AMPLVL (Amp Level) - The LFO controls the Volume of the selected Amp Type.

Modulation Effects Parameters

Active Effect	Available Parameters
Chorus	<i>SPEED</i> (Speed), <i>DEPTH</i> (Depth)
Flanger	<i>SPEED</i> (Speed), <i>DEPTH</i> (Depth), <i>REGEN</i> (Regeneration)
Triggered Flanger	<i>SPEED</i> (Speed), <i>SENSIV</i> (Sensitivity), <i>LFOSTR</i> (LFO Start)
Phaser	<i>SPEED</i> (Speed), <i>DEPTH</i> (Depth), <i>REGEN</i> (Regeneration)
Triggered Phaser	<i>SPEED</i> (Speed), <i>SENSIV</i> (Sensitivity), <i>LFOSTR</i> (LFO Start)
Tremolo	<i>SPEED</i> (Speed), <i>DEPTH</i> (Depth)
Vibrato	<i>SPEED</i> (Speed), <i>DEPTH</i> (Depth)
Rotary Speaker	<i>SPEED</i> (Speed), <i>DEPTH</i> (Depth), <i>DOPLER</i> (Doppler)
Panner	<i>SPEED</i> (Speed), <i>DEPTH</i> (Depth)
YaYa™	<i>PEDAL</i> (Pedal), <i>DEPTH</i> (Depth), <i>RANGE</i> (Range)
Auto Ya™	<i>SPEED</i> (Speed), <i>DEPTH</i> (Depth), <i>RANGE</i> (Range)
SynthTalk	<i>ATTACK</i> (Attack), <i>RELEASE</i> (Release), <i>VOX</i> (Vox), <i>SENSIV</i> (Sensitivity)
Envelope Filter	<i>AMOUNT</i> (Amount), <i>SENSIV</i> (Sensitivity)
Detune	<i>AMOUNT</i> (Amount)
Pitch Shift	<i>AMOUNT</i> (Amount)
Whammy™	<i>AMOUNT</i> (Amount)

YAYA (YaYa™) - The LFO controls the Ya Ya™ Effect when YaYa™ is engaged.

WHAMMY (Whammy™) - The LFO controls the Whammy™ effect when Whammy™ is engaged.

EFFLVL (Effect Level) - The LFO controls the Mix Level of the selected Effect Type.

FBCK (Feedback) - The LFO controls the amount of Delay Feedback.

DLVLVL (Delay Level) - The LFO controls the Mix Level of the selected Delay Type.

DECAY (Decay) - The LFO controls the length of Reverbs Decay time.

REVLVL (Reverb Level) - The LFO controls the Reverbs Mix Level.

VOLPRE (Volume Pre) - The LFO controls the Volume after the Amp Modeling but before the Effects.

VOLPOST (Volume Post) - The LFO controls the Volume at the end of the Effects chain.

4. Rotate the **Number 3 Knob** to select the minimum value the assigned parameter will reach at the bottom turn around point for the LFO (not available when volume is the assigned parameter).
5. Rotate the **Number 4 Knob** to select the maximum value the assigned parameter will reach at the top turn around point for the LFO (not available when volume is the assigned parameter).
6. Rotate the **Number 5 Knob** to select the speed at which the LFO will oscillate from the minimum to the maximum value.
7. Store your LFO assignment to your Preset. See page 9 for more information on the storing procedure.

Factory Reset

This function resets the RP300A to its original factory settings. This procedure will erase all custom user Presets, and recalibrate the Expression Pedal.

ATTENTION: Performing this function will erase all user-programmed data. All such data will be lost forever! Be sure you want to erase the memory and start fresh before continuing with this procedure.

The procedure for performing a Factory Reset is as follows:

1. Disconnect the power supply from the RP300A.
2. Press and hold the **Select** button while re-connecting the power to the RP300A.
3. When the display shows *RST* , release the **Select** button and press the **Store** button. The display will read *RESET* indicating that the RP300A has reset the original factory settings. At this point, the RP300A will automatically advance to the Expression Pedal calibration menu. Follow steps 4 through 7 of the Expression Pedal calibration section.

Expression Pedal Calibration

The Expression Pedal on the RP300A needs to be recalibrated for use after a factory reset has been performed. This calibration procedure is automatically entered after a factory reset procedure. In the event the Pedal's calibration fails, or if the Pedal does not function properly, it can be re-calibrated using the Pedal Calibration procedure. This will not erase the User Presets. The procedure for Calibrating the Expression Pedal is as follows:

1. Disconnect the PS0913B power supply from the power jack on the RP300A.
2. Press and hold the **Down Footswitch** while re-connecting the power.
3. Continue to hold the **Down Footswitch** until the **Display** briefly reads *[CALIB]* (calibration).
4. When the Display reads *TOE DN*, rock the **Expression Pedal** forward to the toe down position.
5. Press any **Footswitch** and the **Display** now shows *TOE UP*.
6. Rock the **Expression Pedal** back to the toe up position.
7. Press any **Footswitch**. The RP300A will then enter the V-Switch Sensitivity adjustment menu and the Display will read *VSWTCH*.
8. If you do not wish to adjust the V-Switch sensitivity, press any **Footswitch** and the RP300A will return to Performance Mode and the Expression Pedal is now calibrated.

Note: If the Display shows *ERROR*, an error has occurred and steps 4 through 8 should be repeated.

V-Switch Sensitivity

If you wish to adjust the sensitivity setting of the V-Switch, follow steps 1 through 7 for Calibrating the Expression Pedal and then follow the steps listed below:

1. When the Display reads *VSWTCH*, rock the **Expression Pedal** forward (toe down) and apply extra pressure on the **toe of the Pedal** until the Display reads *DONE*.
2. The Display now alternates between showing *DONE* (with the V-Switch sensitivity value in the numeric Display) and *VSWTCHON* (or *VSWTCHOFF* depending on whether the V-Switch is on or off). You can audition the V-Switch sensitivity by applying pressure to the **toe of the Expression Pedal**.
3. Rotate the **Number 5 Knob** to change the value of the V-Switch sensitivity. You can audition the new value again by applying pressure to the **toe of the Expression Pedal**.
4. Once the desired sensitivity value is selected, press any **Footswitch**. The RP300A will return to Performance Mode and your settings are automatically saved.

Section Five - Appendix

Factory Preset List

Number	Artist Name	Preset Name	Number	Preset Name	Preset Name
U/A 1	James Fukai	JFUKAI	U/A 21	Evil D	LUSH
U/A 2	Dan Donegan	DAN 1	U/A 22	Joey Z	JOEYZ
U/A 3	Dan Donegan	DAN 2	U/A 23	Joey Z	WHIPIT
U/A 4	Jennifer Batten	LBLEB	U/A 24	Metal Mike Chlasciak	MTLMKE
U/A 5	Jennifer Batten	JBKPNB	U/A 25	Metal Mike Chlasciak	WARCRY
U/A 6	Mike Einziger	INCUB5	U/A 26	Metal Mike Chlasciak	RIP
U/A 7	Mike Einziger	INCUB2	U/A 27	Michael Wilton	CRHLEB
U/A 8	Clint Lowery	7JUST1	U/A 28	Michael Wilton	CHUNK
U/A 9	Clint Lowery	7JUST2	U/A 29	Marc Rizzo	ILLRIZ
U/A 10	Clint Lowery	7JUST3	U/A 30	Andy LaRocque	RHYTHM
U/A 11	Chad Kroeger	CHADNB	U/A 31	Andy LaRocque	SOLO
U/A 12	Chad Kroeger	CHADN2	U/A 32	Dave Murray	CLNSRM
U/A 13	Carlos Cavaso	CAVASO	U/A 33	Dave Murray	DABLUS
U/A 14	CJ Pierce	CJTXFL	U/A 34	Dave Murray	DR STD
U/A 15	CJ Pierce	CJXTN	U/A 35	Dave Murray	PDL DRV
U/A 16	CJ Pierce	CJXML	U/A 36	Paul Crook	CRKFLG
U/A 17	Dominic Cifarelli	CIFRLI	U/A 37	Paul Crook	CRKWHY
U/A 18	Glen Drover	DDOVER	U/A 38	Acey Slade	ACEY
U/A 19	Jody Payne	JDY	U/A 39	Glenn Tipton	TIPTON
U/A 20	Evil D	BLORT	U/A 40	Glenn Tipton	TIPTN2

Number	Preset Name	Display Name	Number	Preset Name	Display Name
F 1	SOLO	SOLO	F 21	TWEEDY	TWEEDY
F 2	CLASSIC CLEAN	CLSCLN	F 22	MATCH THIS	MATCH
F 3	CHUNKY	CHUNKY	F 23	VOX PHASE	VOXPHS
F 4	PEDAL YA	PEBLYA	F 24	STACKED	STACKD
F 5	SCOOP	SCOOP	F 25	JAZZY CLEAN	JAZCLN
F 6	OCTA SUB	OCTSUB	F 26	FUSION	FUSION
F 7	WAHS UP	WAHSUP	F 27	ROTARY CLUB	ROTARY
F 8	LIMPY	LIMPY	F 28	CLEAN STHS	STHS
F 9	COWPIE	COPIE	F 29	PEDAL BEND	PDLBND
F 10	VIBRO THANG	VIBRO	F 30	MUDDY ACOUSTIC	ACOUST
F 11	3RDS	3RDS	F 31	SLIDER	SLIDER
F 12	WHAM ME	WHAMME	F 32	TEXAS BLUES	TEXBLU
F 13	BOOGIE	BOOGIE	F 33	CLEAN FUNK	FUNK
F 14	RECTIFY	RECTFY	F 34	GAIN UP	GAINUP
F 15	TU BE	TU BE	F 35	DYNA PHASE	DYNPHA
F 16	SYNTH TALK	SNTHK	F 36	AUTO WAH	A WAH
F 17	CRUNCH	CRUNCH	F 37	SURFIN'	SURFIN
F 18	AUTO SWELL	SWELL	F 38	FOXY MAMA	FOXY
F 19	STUDIO CLEAN	STCLEN	F 39	ANGUS	ANGUS
F 20	TRIGGERED FLANGE	TRGFLG	F 40	TRIPLETS	TRIPLT

Specifications

Input: 1/4" TS

Jam-A-Long: 1 - 1/8" Stereo TRS

Outputs: 2 - 1/4" TS

Headphone: 1/8" Stereo TRS

A/D/A: 24 bit Delta Sigma

Power Supply: 9 VAC, 1.3A (PS0913B)

Power Consumption: 10 Watts

Memory: 40 User

40 Factory Artist

40 Factory

Effects: Pickup Simulator, Wah, Compressor, Amp and Acoustic Guitar Models, 3 band EQ, Noise Gate, Auto Swell, Pluck Gate, Cabinet Modeling, Mic Placement, Chorus, Flange, Triggered Flange, Phaser, Triggered Phaser, Tremolo, Panner, Vibrato, Rotary Speaker, AutoYa™, YaYa™, SynthTalk™, Envelope Filter, Pitch Shift, Detune, Whammy™, Delay, and Reverb.

Drum Machine: 30 Patterns

Simultaneous Effects: up to 11

Dimensions: 8.5" L x 13" W x 2.25" H

Weight: 3.76 lbs.

DigiTech
8760 S. Sandy Parkway, Sandy, Utah 84070
PH (801) 566-8800 FAX (801) 566-7005

International Distribution
8760 S. Sandy Parkway, Sandy, Utah 84070 USA
PH (801) 566-8800 FAX (801) 566-7005

**DigiTech and RP300A are trade marks of the
Harman Music Group Inc.**

Copyright the Harman Music Group

Printed in the USA 02/2003

Manufactured in the USA

RP300A Owners Manual 18-6406-A

**Please visit DigiTech on the World Wide Web at:
<http://www.digitech.com>**

 **A Harman International Company**

Free Manuals Download Website

<http://myh66.com>

<http://usermanuals.us>

<http://www.somanuals.com>

<http://www.4manuals.cc>

<http://www.manual-lib.com>

<http://www.404manual.com>

<http://www.luxmanual.com>

<http://aubethermostatmanual.com>

Golf course search by state

<http://golfingnear.com>

Email search by domain

<http://emailbydomain.com>

Auto manuals search

<http://auto.somanuals.com>

TV manuals search

<http://tv.somanuals.com>