

# PYTHON®

Responder LE Model 580  
Remote Start Keyless Entry  
Owner's Guide

*Directed*®  
E L E C T R O N I C S

© 2008 Directed Electronics, Vista, CA  
G4202P 2008-05



# Contents

---

Government regulations .....	5
Warning! Safety first .....	6
What's included.....	9
Important information .....	9
Your warranty.....	9
Replacement remotes.....	9
Responder LE 2-way remote.....	10
1-way companion remote.....	11
Transmitter configuration.....	11
Out of range notification.....	16
System maintenance.....	16
Low battery indicator .....	16
Remote control programming .....	17
Multi-car control capability.....	19
Locking the vehicle.....	20
Unlocking the vehicle .....	20
Using the remote start.....	22
Remote starting your vehicle.....	22
Runtime check .....	23
Manual transmission vehicles .....	24
Timer mode.....	25
Turbo timer mode.....	26
Smart start activation.....	27
Cabin temperature .....	29
Turning on the rear defogger.....	29
Valet take-over .....	30
Safety features.....	31
Optional starter anti-grind circuitry.....	31
Disabling the remote start system .....	31
Diagnostics .....	32
Locking .....	32
Unlocking .....	32
Owner recognition .....	33
Rapid resume logic.....	33
Power saver mode.....	33
System.....	33
2-way remote .....	34
Programming options.....	34
Convenience expansions.....	35
Glossary of terms .....	36
Quick reference guide .....	37
Limited lifetime consumer warranty .....	39



# Government regulations

---

This device complies with Part 15 of FCC rules. Operation is subject to the following two conditions: (1) This device may not cause harmful interference, and (2) This device must accept any interference received, including interference that may cause undesirable operation.

This equipment has been tested and found to comply with the limits for a class B digital device, pursuant to Part 15 of the FCC Rules. These limits are designed to provide reasonable protection against harmful interference in a residential installation. This equipment generates and can radiate radio frequency energy and, if not installed and used in accordance with the instruction manual, may cause harmful interference to radio communications. However, there is no guarantee that interference will not occur in a particular installation. If this equipment does cause harmful interference to radio or television, which can be determined by turning the equipment Off and ON, the user is encouraged to try to correct the interference by one or more of the following measures:

- Reorient or relocate the receiving antenna.
- Increase the separation between the equipment and receiver.
- Connect the equipment into an outlet on a circuit different from that to which the receiver is connected.
- Consult the dealer or an experienced radio / TV technician for help.

To satisfy FCC RF exposure compliance requirements, this device should be used in hand-held, hand operated configurations only. The device and its antenna must maintain a separation distance of 20 cm or more from the person's body, except for the hand and wrists, to satisfy RF exposure compliance. This device is designed to be used in a person's hands and its operating configurations do not support normal transmissions while it is carried in pockets or holsters next to a persons' body.

This device complies with the Industry Canada Radio Standards Specification RSS 210. Its use is authorized only on a no-interference, no-protection basis; in other words, this device must not be used if it is determined that it causes harmful interference to services authorized by IC. In addition, the user of this device must accept any radio interference that may be received, even if this interference could affect the operation of the device.

### **Warning:**

Changes or modifications not expressly approved by the party responsible for compliance could void the user's authority to operate this device.

## **Warning! Safety first**

---

The following safety warnings must be observed at all times:

Due to the complexity of this system, installation of this product must only be performed by an authorized Directed dealer.

When properly installed, this system can start the vehicle via a command signal from the remote control transmitter. Therefore, never operate the system in an enclosed area or partially enclosed area without ventilation (such as a garage). When parking in an enclosed or partially enclosed area or when having the vehicle serviced, the remote start system must be disabled using the installed toggle switch. It is the user's sole responsibility to properly handle and keep out of reach from children all remote control transmitters to assure that the system does not unintentionally remote start the vehicle. THE USER MUST INSTALL A CARBON MONOXIDE DETECTOR IN OR ABOUT THE LIVING AREA ADJACENT TO THE VEHICLE. ALL DOORS LEADING FROM ADJACENT LIVING AREAS TO THE ENCLOSED OR PARTIALLY ENCLOSED VEHICLE STORAGE AREA MUST AT ALL TIMES REMAIN CLOSED. These precautions are the sole responsibility of the user.

Remote starters on manual transmission vehicles operate differently than those with automatic transmission because you must leave your car in neutral. You must read this Owner's Guide to familiarize yourself with the proper procedures regarding manual transmission remote starters. If you have any questions, ask your installer or contact Directed at 1-800-753-0600.

Before remote starting a manual transmission vehicle, be sure to:

- Leave the vehicle in neutral and be sure no one is standing in front or behind the vehicle.
- Only remote start on a flat surface
- Have the parking brake fully engaged



Warning! It is the responsibility of the owner to ensure the parking/emergency brake properly functions. Failure to do so can result in personal injury or property damage. We recommend the owner have the parking/emergency brake system inspected and adjusted by a qualified automotive shop biannually.

Use of this product in a manner contrary to its intended mode of operation may result in property damage, personal injury, or death. (1) Never remotely start the vehicle with the vehicle in gear, and (2) Never remotely start the vehicle with the keys in the ignition. The user must also have the neutral safety feature of the vehicle periodically checked, wherein the vehicle must not remotely start while the car is in gear. This testing should be performed by an authorized Directed dealer in accordance with the Safety Check outlined in the product installation guide. If the vehicle starts in gear, cease remote start operation immediately and consult with the authorized Directed dealer to fix the problem.

After the remote start module has been installed, contact your authorized dealer to have him or her test the remote start module by performing the Safety Check outlined in the product installation guide. If the vehicle starts when performing the Neutral Safety Shutdown Circuit test, the remote start unit has not been properly installed. The remote start module must be removed or the installer must properly reinstall the remote start system so that the vehicle does not start in gear. All installations must be performed by an authorized Directed dealer.

OPERATION OF THE REMOTE START MODULE IF THE VEHICLE STARTS IN GEAR IS CONTRARY TO ITS INTENDED MODE OF OPERATION. OPERATING THE REMOTE START SYSTEM UNDER THESE CONDITIONS MAY RESULT IN PROPERTY DAMAGE OR PERSONAL INJURY. YOU MUST IMMEDIATELY CEASE THE USE OF THE UNIT AND SEEK THE ASSISTANCE OF AN AUTHORIZED Directed DEALER TO REPAIR OR DISCONNECT THE INSTALLED REMOTE START MODULE. DIRECTED WILL NOT BE HELD RESPONSIBLE OR PAY FOR INSTALLATION OR REINSTALLATION COSTS.

This product is designed for fuel injected vehicles only. Use of this product in a standard transmission vehicle must be in strict accordance with this guide.

This product should **not** be installed in any convertible vehicles, soft, or hard top with a manual transmission. Installation in such vehicles may pose certain risk.



# What's included

---

- One five-button/2-way Supercode Responder LE remote control
- One five-button/ 1-way Supercode remote
- The control module (installed out-of-sight)
- Control center with integrated status LED and Valet override switch
- A remote start defeat toggle switch
- Window decals
- Your warranty registration

## Important information

---

Congratulations on the purchase of your state-of-the-art remote start and keyless entry system. Due to the complexity of this system, it must be installed by an authorized dealer only. Installation of this product by anyone other than an authorized dealer voids the warranty. All dealers are provided with a preprinted dealer certificate to verify authorization.

By carefully reading this Owner's Guide prior to using your system, you will maximize the use of this system and its features. You can print additional or replacement copies of this manual by accessing our web site at [www.directed.com](http://www.directed.com).

### ► Your warranty

Your warranty registration must be completely filled out and returned within 10 days of purchase. Your product warranty will not be validated if your warranty registration is not returned. Make sure you receive the warranty registration from your dealer. It is also necessary to keep your proof of purchase, which reflects that the product was installed by an authorized dealer.

### ► Replacement remotes

Your system comes with one Responder LE remote control (P/N 7251) and one remote control (P/N 7152). If additional remotes are desired, please see your authorized dealer or visit [www.directedstore.com](http://www.directedstore.com) to order.

# Responder LE 2-way remote

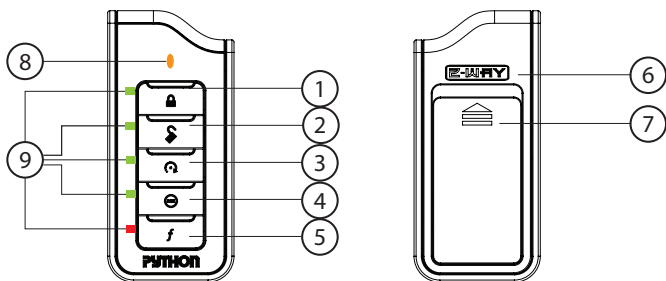

Feature	Description
1	Lock button Press for one second to lock.
2	Unlock button Press for one second to unlock.
3	Remote start button Press for one second to activate remote start.
4	Auxiliary button Press and hold for 1.5 second to activate optional trunk release.
5	Function button Allows access to programming and modifies operation of the other buttons.
6	Label Back of remote has label to identify the remote as 2-way or 1-way.
7	Battery Door Remove to access batteries when necessary. For more detail, see p. 16
8	Transmit indicator
9	LED indicators Flashes to indicate function confirmation

**Note:** If Keypad Lock is On, press **f** and then press **🔓** to exit.

# 1-way companion remote

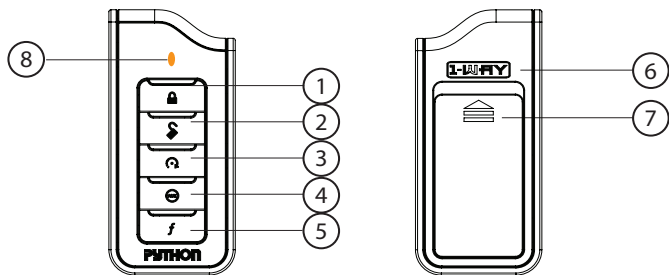





Note: See call-out table for 2-way

## ► Transmitter configuration

Level Button	Direct Access	<b>f</b> x 1	<b>f</b> x 2	<b>f</b> x 3	<b>f</b> x 4
Lock		Silent Lock			
Unlock		Silent Unlock	Valet Mode	Car Finder	
Remote Start		Reset Runtime	Timer Mode	Smart Start	Rear Defogger
Trunk Release		AUX 1	AUX 2	AUX 3	
Function Shift*		Cabin Temperature request* (2-way only)	Lock Status* (2-way only)	Runtime Check* (2-way only)	

\* **f** button must be pressed and held to access state

## Button

 Lock	<b>Command:</b> Press one time to Lock <b>Feedback:</b> Lock LED flashes for 1-sec with 1 beep. <b>Notes:</b> Press/hold for 1.5 seconds to Lock the system and then activate the Panic output*
 Unlock	<b>Command:</b> Press one time to Lock <b>Feedback:</b> Unlock flashes for 1-sec and remote beeps twice <b>Notes:</b>
 Remote Start	<b>Command:</b> Press one time to activate Remote Start <b>Feedback:</b> Remote Start LED flashes for 3-secs, remote start tones. <b>Notes:</b>
 AUX	<b>Command:</b> Press and hold for 1.5 seconds to activate the Trunk Release. <b>Feedback:</b> The AUX LED turns on for 3-secs and AUX activation tone sounds. <b>Notes:</b> This is an optional feature. See your sales rep/installer for details.
 Function Shift	<b>Command:</b> Press 1 to 4 times. ( See Function shift table.) <b>Feedback:</b> LED indicators turn on (according to the feature command) <b>Notes:</b> Each Press then release, shifts the function of the command button.

**Note:** Feedback is available on the 2-way remote only.

\* Horn honk is an optional feature. The panic and horn honk feature is available when this option is installed.

Pressing more than one button simultaneously generates an Error tone and the "Function" LED turns on.

## Feature List:

### Silent lock

**Command:** Press **f** one-time and then press 

**Feedback:** Lock LED flashes for 1-sec

**Notes:** Locks the system without horn honks\*

### Silent unlock

**Command:** Press **f** one-time and then press 

**Feedback:** Unlock LED flashes for 1-sec

**Notes:** Unlocks the system without horn honks\*

### Runtime reset

**Command:** Press **f** one-time and then 

**Feedback:** Remote start On tones sound.

**Notes:** Re-starts the remote start runtime counter if remote start is active. **Note:** If remote start is not active, the 2-WAY remote will respond with error tone.

### Aux 1

**Command:** Press **f** one time and then press 

**Feedback:** The Aux LED turns on for 3-secs, Aux activation tone sounds.

**Notes:** This is an optional feature. See your sales rep/installer for details.

### Cabin temperature

**Command:** Press **f** one time, then **Hold** for 1.5 seconds.

**Feedback:** Screen will display current in cabin temperature.

**Notes:** Cabin temperature is displayed on the remote. LED lights turn on to indicate a range. (See p.29)

## Valet mode

**Command:** Press **f** two-times and then .

**Feedback:** Remote beeps 1 to 2 times when entering Valet mode.

**Notes:** To enter or exit Valet mode, even if Locked. When entering Valet Mode the remote beeps one-time. When exiting Valet Mode the remote beeps two-times.

## Timer mode

**Command:** Press **f** two-times and then .

**Feedback:** Remote start LED turns on.

**Notes:** Enables or disables the remote start timer mode.

## Aux 2

**Command:** Press **f** two times and then press .

**Feedback:** The AUX LED turns on for 3-secs, and AUX activation sounds.

**Notes:** This is an optional feature. See your sales rep/installer for details.

## Car finder

**Command:** Press **f** three-times and then .

**Feedback:** Remote beeps 1 short beep, the vehicle emits 1 long horn honk\*, and the parking lights flash 10 times.

**Notes:** Lock/Unlock cancels the parking light flashes.

## Smart start

**Command:** Press **f** three-times and then press .

**Feedback:** Remote start LED turns on, with 1 beep for enable or 2 beeps for disable.

**Notes:** Enables or disables the Smart Start feature.

## Aux 3

**Command:** Press **f** three times and then press .

**Feedback:** The AUX LED turns on for 3-secs, AUX activation tone sounds.

**Notes:** This is an optional feature. See your sales rep/installer for details.

## Runtime check

**Command:** Press **f** three-times, and then **Hold** for 1.5 seconds.

**Feedback:** Remote start On tones sound.

**Notes:** Runtime remaining is displayed as per the LED on the remote. (See page 23). If the remote start is not active the 2-way responds with an error tone.

## Rear defogger

**Command:** Press **f** four times, and then . (Only after remote start is on.)

**Feedback:** Remote start LED on, 1 beep.

**Notes:** Manually turns on the defogger when remote start is on.

## ► Out of range notification

If a command is issued from the remote, but the remote is beyond the range of the vehicle to receive the command, the remote will respond with an out-of range notification. If this occurs, the transmit indicator on the remote flashes rapidly, the **f** key LED turns on, and the remote emits the error tone sounds.

Since conditions will vary in different areas (i.e.: Weather, RF interference, etc) range may be affected and require you to be closer to the vehicle for successful transmission.

## ► System maintenance

The system requires no specific maintenance. Your remotes are powered by small coin cell lightweight 3-volt lithium batteries that last approximately one year under normal use. The 2-way remote uses two CR2016 cell batteries and the 1-way remote uses one CR2032 cell battery. When the battery begins to weaken, the operating range is reduced.

## ► Low battery indicator

When the batteries are low on the 2-way remote it emits two groups of beeps, the **f** LED flashes, and the system emits an additional honk when unlocking to let you know its time to change the battery. When the battery is low on the 1-way remote, the remote responds the same, but without the LED flash.

**Note:** The Lock/Unlock confirmations should be programmed On, and the optional horn honk installed, for the system to emit any additional honks during unlocking. Ask your authorized dealer if you have any questions.



## ► Remote control programming

The Reponder LE 2-way remote control has menus for programming the remote to the system control module and for configuring the remote control user features.

Before you start make sure the keypad is unlocked. (See page 11)



### To program the remote user features:

1. Press and hold the **f** button on the remote for 12 seconds. (ignore the car indicator at 3 seconds). The remote emits one long beep, and the transmit LED turns on to indicate the Main Menu.
2. Press and hold the  button for 1.5 seconds: The remote beeps two times. You are now in the Remote Configuration menu.

The Lock, Unlock, Remote Start and Aux LEDs turn on and/or blink to indicate the current remote feature configuration. When the LED is On, the feature is On.

### To configure the remote control features:

Press and release the command button. The LED next to the button turns On or Off. The remote beeps to indicate the feature configuration.

Press the  button to access the Auto keypad lock feature. When the  LED is off, the keypad does not lock.

Press the  button to change the Auto keypad lock feature.

- Lock LED On: The keypad lock feature is On. When the  LED is on, the keypad automatically locks 60 seconds after the last button operation to avoid accidental command operations. When locked, if any command button is pressed the remote emits an error tone. The companion remote beeps once when the feature is programmed On.
- Lock LED Off: The keypad lock feature is Off and the keypad does not lock. The companion remote beeps twice when the feature is programmed Off.

If the keypad lock is On, press **f**, and then press  to unlock the keypad.

**Note:** If the auto keypad lock feature is programmed On, the remote unlocks when the vehicle ignition is turned Off. The remote stays unlocked to allow time to exit and unload the vehicle, and then lock the doors with the remote. When the  button is pressed, the keypad auto lock feature resumes normally.

Press the  button to access and change the Remote Beeps feature.

- Unlock LED On: The remote emits beeps normally. The companion remote beeps once to confirm the mode change.
- Unlock LED Off: The remote does not emit beeps except when programming. The companion remote beeps twice to confirm mode change.
- Unlock LED blinking: The remote emits beeps only if the optional horn honk input is hooked up and the factory alarm has been triggered. (This feature is not available on the 1-way companion remote).

Press the  button to access and change the Runtime Low Alert feature.

**Note:** This feature is not available on the 1-way companion remote.

- Remote Start LED On: The remote emits feedback output for Runtime Low Alert messages.
- Remote Start LED Off: The remote ignores Runtime Low Alert messages.

These messages are automatically sent while Remote Start is On to alert you when the runtime remaining is at 3 minutes, and again at 1 minute before shut down.

Press the  button to access and change the Page mode/Power saver mode.

**Note:** Not available on the 1-way companion remote.

- Aux LED On: the remote wakes up to listen for messages from the system
- Aux LED blinking: Power saver mode (see Note below)
- Aux LED Off: The remote does not wake up and listen for messages from the system to extend battery life. This means the remote does not receive the optional factory alarm trigger pages.

**Note:** If a remote button is not pressed for more than 72 hours, the remote automatically goes into sleep mode to extend battery life. It wakes up and resets each time a button is pressed.



## ► Multi-car control capability

You can use the Responder LE 2-way and 1-way companion remote control system for two cars, with full command capability for both vehicles.

While holding a command button and transmitting, the amber LED at the top of the remote control flashes in groups to indicate which car is being controlled.

- Car 1: 1 flash
- Car 2: 2 flashes

### To change the Car to be operated:

Press/hold the **f** button for 3 seconds or until the remote beeps and the  and/or  LEDs turn on. This indicates which car the remote currently operates.

- Car 1: 1 beep and Lock LED on
- Car 2: 2 beeps and Lock & Unlock LEDs on

**Note:** Using the 1-way companion remote, the amber LED flashes and beeps once for Car 1. The amber LED flashes and beeps twice for Car 2.

### To change Car while the LEDs are On:

1. Press and release the **f** button. The LEDs will change to indicate the car that can be operated.
2. After you select the car number, press any command button to operate the features. The selected car remains selected until the setting is changed.

## ► Locking the vehicle

To lock the vehicle, press the  button on the remote control.

The horn in the vehicle "honks" one-time, and the parking lights flash one-time. If the power door locks have been connected, the doors lock.



The system automatically checks for errors when it locks. The 2-way remote honks one-time and then flashes the  LED indicator to confirm locking. If no lock confirmation is received, the remote emits the out-of-range signal.

### If errors are found when locking:



If the door is open when you lock the vehicle, the horn honks once and the parking lights flash. The horn then honks a second time to indicate that the door is open and the LED on the control center flashes in groups of three

The 2-way remote control sounds a short "error" tone, and the LED indicators next to the  and **f** buttons flash. **Note:** The optional horn honk and door input has to be installed for this function.



### Locking without the honk (Silent Lock)

Press the **f** button on the remote one-time, and then press the  button. The vehicle locks without the confirmation honk. The parking lights flash one-time. The 2-way remote flashes the  LED to confirm locking. If no lock confirmation is received, the 2-way remote emits the out-of-range signal.

## ► Unlocking the vehicle

Lock the vehicle normally. Press the  button one time. The vehicle horn honks two-times and the parking lights flash. The 2-way remote beeps two-times and the  LED indicator flashes. The door locks, if connected, unlock. If no unlock confirmation is received, the 2-way remote emits the out-of-range signal.

### UnLocking without the honk (Silent Unlock)

Lock the vehicle normally. Press the **f** button on the remote one-time, and then press the  button. The vehicle unlocks without the confirmation honk. The parking lights flash two-times. The 2-way remote flashes the  LED to confirm unlocking. If no unlock confirmation is received, the 2-way remote emits the out-of-range signal.

## ➤ Overriding the optional starter kill

To bypass the optional starter kill without a remote control:

Use your override switch located on the control center (see diagram below) to bypass the system. This switch bypasses the system only if you have the vehicle key.

To check proper operation:

1. While the vehicle is locked, open the door. Immediately insert the key into the ignition and turn it to the Run or On position. (all the indicators in the dash turn on)
2. Press and release the Override Switch one time. The optional starter kill is bypassed. You can now start the vehicle with the key.

**Note:** The override switch feature allows you to select a specific number of presses needed to disable the system. If the override switch has been programmed to a new number of presses by your authorized dealer, that number should be indicated below.

Override Switch number of presses \_\_\_\_\_

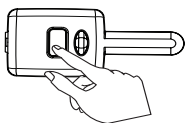

# Using the remote start

---

Read this user guide, including the warnings on page 6, before using the remote start. Ensure that the vehicle is parked in an open area, not in a garage. To use your remote start to pre-warm or pre-cool your vehicle, remember to set the climate controls to the desired settings before shutting Off the engine.

## ► Remote starting your vehicle

- Press the  button on the remote control. The vehicle parking lights flash.
- On the 2-way remote, the Remote Start LED flashes and ascending Remote Start tone plays.

The preset remote start run time is 12 minutes. This can be changed to between 12 and 60 minutes (see your authorized dealer for programming changes).

Your system has a feature, if programmed On, that automatically notifies you when the runtime is getting low. When the vehicle reaches 3-minutes of runtime remaining, it sends the 2-way remote control a paging signal. The 2-way beeps one-time, plays the error beep tone one-time, and then the  and **f** LEDs flash.

### Points to remember

If the hood is open or if the brake pedal is pressed, the vehicle will not remote start. **The remote start shuts down:**

- When the brake pedal is pressed
- The hood is opened
- When the remote start command is sent again from a remote control
- When runtime expires

## ► Runtime check

Your system has a feature (if programmed on) that automatically notifies you when the run time is getting low. The default runtime is 12 minutes.

To check the amount of runtime remaining:

After the vehicle is remote started, press the **f** button three-times and then hold until the remote beeps, and then release. The LEDs light up to indicate how much time is remaining.

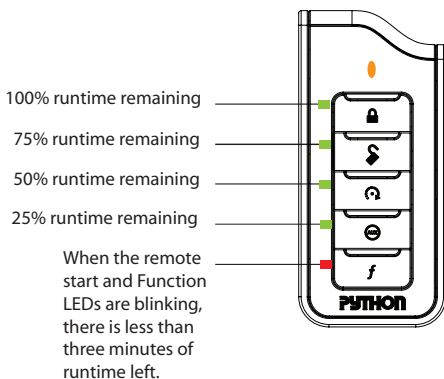

## ► Manual transmission vehicles

If the vehicle has manual transmission the proper steps must be followed before leaving the parked vehicle, or the remote start feature is disabled. This process is called MTS, manual transmission start.

1. While the vehicle is running, put the transmission in neutral.
2. Press the vehicle's foot brake.
3. Apply the emergency brake.
4. Release the vehicle's foot brake.  
**Note:** Pressing the brake again after this step will disable the remote start feature.
5. Using the remote control, activate the remote start within 15 seconds. The parking lights flash 5-times confirming that the remote start is active.
6. If the parking lights do not flash 5 times, you have not entered manual transmission mode and will need to repeat steps 1 thru 5.
7. Turn Off the ignition (the car should stay running when key is turned Off).
8. Exit the vehicle.
9. Lock the doors with the remote. (the vehicle should shut Off when locking the system).

You can now remote start the vehicle. If a door is opened before the next remote start activation, the system will not remote start.

### To drive your vehicle after it has been remote started:

1. Get in without stepping on the brake.
2. Insert the ignition key and turn it to the On position.
3. Now, step on the brake.

The remote control plays the remote start shutdown tone. You have now taken direct control from the remote start system.



## ► Timer mode

This unit can be programmed to start and run the engine every three hours, for a maximum of six cycles. The engine will run for the programmed run time and then shut down. After three hours, the system will restart the engine.

**Important:** Timer Mode should be used in open areas **only**. Never start and run the vehicle in an enclosed space such as a garage or carport.

### To activate timer mode with an automatic transmission:

1. Remote start the vehicle by pressing **f** twice and then press .
2. The parking lights flash rapidly four times to confirm timer mode entry. (The vehicle will not remote start at this point.)
3. The vehicle begins the timer mode sequence.

### To activate timer mode with a manual transmission:

1. Enter the MTS mode.
2. Exit the vehicle and lock the system.
3. Enter the timer mode. The parking lights quickly flash 4 times to confirm entry into timer mode (vehicle will not remote start at this point).  
The vehicle begins the timer mode sequence.

Timer Mode is exited automatically after the sixth run cycle. The parking lights slowly flash 4 times when exiting timer mode.

### To exit timer mode with the transmitter:

- Press the **f** button twice and then press . The parking lights flash slow four times to confirm timer mode is exited.

## To exit timer mode without the transmitter:

1. Make sure the remote start system is not operating the engine.
2. Turn the ignition on. Timer Mode is exited and the parking lights flash slowly four times.

**Note:** The Bitwriter can change the amount of times the remote start activates and, it can change the intervals between activations in timer mode.

## ► Turbo timer mode

### To activate turbo timer mode:

1. Make sure turbo timer is turned on.
2. Open the vehicle door.
3. While the vehicle is running, press **f** button 2-times, and then press  button. The parking lights flash one-time and the remote sounds the activation tone confirming that the remote start is activated.

**Note:** The 1-way remote only flashes the parking lights and does not emit any sounds.

4. Turn Off the ignition. The car remains running.
5. Exit the vehicle and Lock the system. The vehicle remains running for the programmed run time.

## To enter turbo timer mode with a manual transmission:

Perform the manual transmission procedure with the door open. Transmit the timer mode feature with the remote by pressing **f** two-times, and then press .

After exiting the vehicle, lock the system and the vehicle remains running for the programmed runtime. (The remote start feature is still enabled).

You can still remote start the vehicle after the turbo timer has timed out and shut Off the vehicle. For safety reasons, if a door is opened (while the system is Locked or Unlocked) while you are away, the remote start exits the manual transmission mode and will not remote start until the MTS sequence is re-initiated.

**Note:** An optional push button can be hardwired to the (-) activation input on the remote if you want to activate the turbo timer without using the remote start.

When the vehicle is running follow the procedures listed above, but instead of pressing the remote, press the push button the appropriate number of times to activate the remote start (factory setting is for 1 pulse).

The remote emits the remote start confirmation tone, after which you can turn Off the ignition and exit the vehicle. The car remains running for the pre-programmed amount of time.

## ► Smart start activation

With Smart Start you can activate remote start when the vehicle reaches a certain temperature, or when it reaches a certain voltage.



The factory setting for temperature high is 100°, and the low is 0° (F). The voltage setting is 10.5v. These settings can be adjusted or turned off by your installer using the Bitwriter.

## To activate Smart Start mode:

- Press the **f** button on the remote 3 times and then press the  button.

The 2-way remote beeps once, and flashes the remote start LED once.  
The parking lights flash 5 times **fast** to confirm the remote is in Smart Start mode.

## To activate Smart Start mode with a manual transmission:

1. Enter the MTS procedure.
2. Exit the vehicle and press the  button on the remote (the vehicle shuts down when locking).
3. Press the **f** button on the remote 3 times and then press the  button.  
The 2 way remote beeps once and flashes the remote start LED once.  
The parking lights flash 5 times **fast** to confirm the remote is in Smart Start mode.

The vehicle remote starts when the cabin temperature reaches the programmed threshold, or when the battery reaches the programmed voltage.

## Use one of the below methods to exit Smart Start mode:

- Perform the same steps to activate Smart Start mode
- Turn the ignition On to deactivate manually
- Press the brake pedal

The parking lights flash 5 times **slowly** to confirm the remote has exited Smart Start mode.

## ► Cabin temperature

Using the Responder LE you have the ability to check the temperature inside the vehicle.

Press the **f** button one-time and Hold it until the remote beeps, and then release. The LEDs light up indicating the temperature range of the vehicle.

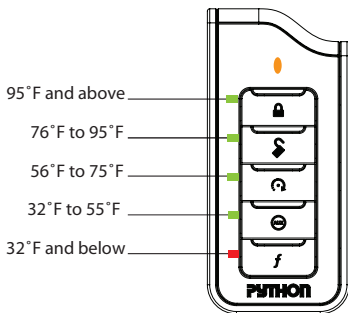

## ► Turning on the rear defogger

The rear defogger (if connected) is programmed to automatically activate when remote start is turned on. If the interior cabin temperature is above 55° F the defogger will not activate.

To manually activate the rear defogger after remote start is on:

- Press **f** four times, and then press 

**Note:** if remote start is not active, the remote emits an error tone.

## ► Valet take-over

The Valet take-over feature allows the vehicle to remain running after the key has been removed from the ignition. This feature is useful for occasions when you want to exit and lock the vehicle for short periods of time, but would like to leave the motor running and the climate controls on.

### To perform Valet take-over:

1. Before turning Off the engine, press and release the  button on the transmitter within 3 seconds.  
The parking lights flash one time to confirm that valet take-over has been initiated. Then wait a few seconds.
2. Turn the ignition key to the Off position (The engine remains running).
3. Exit the vehicle and lock the system with the remote.  
The engine runs until the pre-programmed time elapses or a shut-down input is received.

**Note:** To enable valet take-over with a manual transmission, open the door when going into MTS mode. The parking lights flash one-time to confirm entry into valet takeover. After you exit the vehicle you can lock the system with the remote and the car remains running. If the vehicle shuts down when locking, then the unit did not enter the valet take-over mode.

# Safety features

---

This system has several important safety features to ensure proper operation of the motor and prevent accidental damage to the engine or its components.

## ➤ Optional starter anti-grind circuitry

Whenever the vehicle is remote started, advanced anti-grind circuitry prevents the starter from engaging, even if the key is turned to the start position. This prevents damage to the starter motor if the key is turned to the start position during remote start operation.

**Note:** Anti-grind circuitry only works when the remote start system is operating the motor and the optional Failsafe® Starter Kill relay is installed.

## ➤ Disabling the remote start system

This feature allows the remote start unit to be temporarily disabled to prevent the vehicle from being remote started accidentally. This feature is useful when the vehicle is being serviced or stored in an enclosed area.

To disable the remote start, move the shutdown toggle switch to the Off position. Check with your installer for the location of the shutdown switch.  
Location of Shutdown Switch \_\_\_\_\_

# Diagnostics

---

The microprocessor at the heart of the system is constantly monitoring the switches that are connected to the main unit.

## ► Locking

If the system is locked at the same time that the door input is active, you will hear one horn honk to indicate locking, and then a second horn honk to indicate Bypass Notification.

**Note:** Bypass Notification does not occur if the optional horn input is not installed or when the system is in Silent Mode or if the notification honks have been programmed Off by the installer.

## ► Unlocking

Extra honks when unlocking the system is a notification that the batteries in the remote are low and need to be replaced.

**Important:** The optional horn honk feature must be installed.



## ► Remote start

This system can provide you with information to indicate what the problem is when using the remote start. When the remote start is activated and fails to engage, count the parking light flashes to determine the problem. The parking lights will flash between 5 - 8 times to indicate what caused the no start situation.

- 5 flashes: brake wire is active
- 6 flashes: hood pin is active
- 7 flashes: manual transmission mode is enabled and not initialized
- 8 flashes: neutral safety wire has no ground or the remote start defeat toggle switch is off.

Keep a record of the number of flashes, to assist your installer when taking the vehicle in for service.

## Owner recognition

---

Owner recognition lets up to four users of the system have unique settings to meet their specific needs. It is almost like having four separate systems in your vehicle, one for each user. This feature is only available to authorized dealers using the Bitwriter or Bitwriter 2 program tool.

## Rapid resume logic

---

This Directed system will store its current state to non-volatile memory. If power is lost and then reconnected the system will recall the stored state from memory.

For example, if the unit is in Valet Mode and the battery is disconnected for any reason, such as servicing the car, when the battery is reconnected the unit is still in Valet Mode. This applies to all states of the system including lock or unlock.

## Power saver mode

---

### ➤ System

Your system will automatically enter Power Saver Mode while locked or in Valet Mode, after a period of time in which no operation has been performed. This lowers the current draw on the vehicle's battery. Power Saver Mode takes over under the following conditions:

**Power Saver when the system is locked:** After the system has been Locked for 24 hours the LED flashes at half its normal rate, decreasing the system's current draw.

**Power Saver in Valet Mode:** When the system enters Valet Mode the Status LED on the Responder LE control center illuminates steadily. If the vehicle is not used (ignition is not turned on) for a one-hour period while the system is in Valet Mode, the status LED shuts Off. If the system remains in Valet Mode, the LED comes back on the next time the ignition is turned On, and then Off.

## ➤ 2-way remote

Your Responder LE 2way remote control has a feature called remote power save mode. When programmed On under remote options, the remote conserves power by disabling the paging function if unused for more than 72 hours. Pressing any button on the remote restores the paging function.

The default setting is On. See Remote control programming section of this guide or ask your dealer for details on how to program.

## Programming options

---

Your system has many custom programmable options. Some may require installation labor. Ask your authorized dealer for details.

The following is a list of the programmable options, with the factory settings in **Bold**.

- **Active** locking (remote only) passive locking, the system automatically locks the doors 30-seconds after the last door is closed; or Auto Re-lock automatically re-locks the doors 60 seconds after unlocking (if no door is opened).
- Locking/Unlocking with no horn honk confirmations **On** or Off.
- Ignition controlled door lock feature On or **Off**: When this feature is programmed on, the doors lock three seconds after the ignition is turned on, and unlock when the ignition is turned Off. The ignition lock and unlock are independent features that can be programmed separately.
- **Panic mode enabled**/disabled when the ignition is turned on or completely turned Off.
- **Comfort closure** is a programming option which closes the vehicle's windows after remote locking. **Note:** Comfort closure can only be used on cars that have the capability of closing the windows (and on some cars the sunroof as well) with the key cylinder in the door.

# Convenience expansions

---

Listed below are some of the expansion options available. Please consult your dealer for a complete explanation of all the options available to you.

**Power Trunk Release:** The accessory output of the system can operate a factory power release for the vehicle's trunk or hatch. Sometimes an optional relay is required. If the factory release is not power-activated, Directed®'s 522T trunk release solenoid can often be added.

**Power Window Control:** Automatic power window control is provided with the 529T and 530T systems. These can operate power windows, and can roll them up automatically when the system is Locked, roll them down, or both up and down.

# Glossary of terms

---

**2-Way Remote:** A hand-held, remote control which operates the various functions of your system and receives feedback and pages from the system.

**Control Center:** The control center contains the system's radio-frequency antenna, the valet and override switch, and the Status LED. For maximum remote-control range, the Control Center is usually located at the top of the windshield, centered near the rear-view mirror.

**Control Module:** The "brain" of your system. Usually hidden underneath the dash area of the vehicle. It houses the microprocessor which monitors your vehicle and controls all of the system's functions.

**Failsafe® Starter Kill** (if equipped): An automatic switch controlled by the system which prevents the vehicle's starter from cranking whenever the system is locked. The vehicle is never prevented from cranking when the system is unlocked in Valet® Mode, or should the starter kill switch fails. Your system is ready for this feature, however installation of this feature may require additional labor.

**Input:** Any physical connection to the system. An input can be provided by existing systems in the vehicle, such as ignition or courtesy lights.

**In-vehicle status LED:** A light used to indicate the status of your system. It is located on your systems control center.

**MTS:** Manual transmission start. Procedure required for using the remote start in a vehicle with a manual transmission.



**RF:** Radio frequency

**Valet Button:** A small push button switch located on your systems control center. It is used to override the starter interrupt when a remote is lost or damaged, or to enter or exit Valet Mode.





## Quick reference guide



- **Locking**  
To lock press . The lock LED flashes and the remote beeps one-time. If horn honk is installed, the remote emits a honk sound.
- **Unlocking**  
To unlock press . The unlock LED flashes for one-second, and the remote beeps two-times.
- **Bypassing the optional starter kill without a remote**

Turn on the ignition. Press and release the Valet button within 15 seconds.

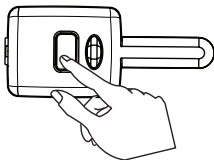
The system should now bypass. If it does not, you may have waited too long or pressed the button incorrect number of times.



Number of Valet button presses for disabling \_\_\_\_\_

- **Silent Lock**  
Press **f** one-time and then press . The lock LED flashes for one-second with no sound.
- **Silent UnLock**  
Press **f** one-time and then press . The unlock LED flashes for one-second with no sound.
- **Remote Start**  
Press . The remote start LED turns on for 3-seconds and remote start tone sounds..



- Rear Defogger  
Press **f** four-times, and then press  (only after remote start is On.)  
The remote beeps one-time and remote start LED turns On.

- To disable the remote start system

Move the shutdown toggle switch to the Off position.

Location of Shutdown Toggle Switch \_\_\_\_\_

- Valet Mode  
Press **f** two-times and then . The unlock and function LEDs blink and the remote beeps once. When valet mode is Off, the remote beeps two-times.

- Valet take-over

1. Before turning Off the engine, press and release the  button within 3 seconds. Then wait a few seconds.
2. Turn the ignition key to the Off position.
3. Exit the vehicle and lock the doors with the remote.  
The engine will remain running until the programmed time elapses or a shut-down input is received.



Cut along the dotted line and fold to keep in purse or wallet for a quick and easy reference.





# Limited lifetime consumer warranty

---

Directed Electronics. ("Directed") promises to the original purchaser to repair or replace (at Directed's election) with a comparable reconditioned model any Directed unit (hereafter the "unit"), excluding without limitation the siren, the remote transmitters, the associated sensors and accessories, which proves to be defective in workmanship or material under reasonable use during the lifetime of the vehicle provided the following conditions are met: the unit was purchased from an authorized Directed dealer, the unit was professionally installed and serviced by an authorized Directed dealer; the unit will be professionally reinstalled in the vehicle in which it was originally installed by an authorized Directed dealer; and the unit is returned to Directed, shipping prepaid with a legible copy of the bill of sale or other dated proof of purchase bearing the following information: consumer's name, telephone number and address; the authorized dealers name, telephone number and address; complete product description, including accessories; the year, make and model of the vehicle; vehicle license number and vehicle identification number. All components other than the unit, including without limitation the siren, the remote transmitters and the associated sensors and accessories, carry a one-year warranty from the date of purchase of the same. ALL PRODUCTS RECEIVED BY DIRECTED FOR WARRANTY REPAIR WITHOUT PROOF OF PURCHASE WILL BE DENIED. This warranty is non-transferable and is automatically void if: the original purchaser has not completed the warranty card and mailed it within ten (10) days from the date of purchase to the address listed on the card; the unit's date code or serial number is defaced, missing or altered; the unit has been modified or used in a manner contrary to its intended purpose; the unit has been damaged by accident, unreasonable use, neglect, improper service, installation or other causes not arising out of defects in materials or construction. The warranty does not cover damage to the unit caused by installation or removal of the unit. Directed, in its sole discretion, will determine what constitutes excessive damage and may refuse the return of any unit with excessive damage.

TO THE MAXIMUM EXTENT ALLOWED BY LAW, ALL WARRANTIES, INCLUDING BUT NOT LIMITED TO EXPRESS WARRANTY, IMPLIED WARRANTY, WARRANTY OF MERCHANTABILITY, FITNESS FOR PARTICULAR PURPOSE AND WARRANTY OF NON-INFRINGEMENT OF INTELLECTUAL PROPERTY, ARE EXPRESSLY EXCLUDED; AND DIRECTED NEITHER ASSUMES NOR AUTHORIZES ANY PERSON OR ENTITY TO ASSUME FOR IT ANY DUTY, OBLIGATION OR LIABILITY IN CONNECTION WITH ITS PRODUCTS. DIRECTED DISCLAIMS AND HAS ABSOLUTELY NO LIABILITY FOR ANY AND ALL ACTS OF THIRD PARTIES INCLUDING ITS AUTHORIZED DEALERS OR INSTALLERS. DIRECTED SECURITY SYSTEMS, INCLUDING THIS UNIT, ARE DETERRENTS AGAINST POSSIBLE THEFT. DIRECTED IS NOT OFFERING A GUARANTEE OR INSURANCE AGAINST VANDALISM, DAMAGE OR THEFT OF THE AUTOMOBILE, ITS PARTS OR CONTENTS; AND HEREBY EXPRESSLY DISCLAIMS ANY LIABILITY WHATSOEVER, INCLUDING

WITHOUT LIMITATION, LIABILITY FOR THEFT, DAMAGE AND/OR VANDALISM. THIS WARRANTY DOES NOT COVER LABOR COSTS FOR MAINTENANCE, REMOVAL OR REINSTALLATION OF THE UNIT OR ANY CONSEQUENTIAL DAMAGES OF ANY KIND. IN THE EVENT OF A CLAIM OR A DISPUTE INVOLVING DIRECTED OR ITS SUBSIDIARY, THE VENUE SHALL BE SAN DIEGO COUNTY IN THE STATE OF CALIFORNIA. CALIFORNIA STATE LAWS AND APPLICABLE FEDERAL LAWS SHALL APPLY AND GOVERN THE DISPUTE. THE MAXIMUM RECOVERY UNDER ANY CLAIM AGAINST DIRECTED SHALL BE STRICTLY LIMITED TO THE AUTHORIZED DIRECTED DEALER'S PURCHASE PRICE OF THE UNIT. DIRECTED SHALL NOT BE RESPONSIBLE FOR ANY DAMAGES WHATSOEVER, INCLUDING BUT NOT LIMITED TO, ANY CONSEQUENTIAL DAMAGES, INCIDENTAL DAMAGES, DAMAGE TO VEHICLE, DAMAGES FOR THE LOSS OF TIME, LOSS OF EARNINGS, COMMERCIAL LOSS, LOSS OF ECONOMIC OPPORTUNITY AND THE LIKE. NOTWITHSTANDING THE ABOVE, THE MANUFACTURER DOES OFFER A LIMITED WARRANTY TO REPLACE OR REPAIR THE CONTROL MODULE SUBJECT TO THE CONDITIONS AS DESCRIBED HEREIN. THIS WARRANTY IS VOID IF THE UNIT HAS NOT BEEN PURCHASED FROM DIRECTED, OR AN AUTHORIZED DIRECTED DEALER, OR IF THE UNIT HAS BEEN DAMAGED BY ACCIDENT, UNREASONABLE USE, NEGLIGENCE, ACTS OF GOD, NEGLIGENCE, IMPROPER SERVICE, OR OTHER CAUSES NOT ARISING OUT OF DEFECT IN MATERIALS OR CONSTRUCTION.

Some states do not allow limitations on how long an implied warranty will last or the exclusion or limitation of incidental or consequential damages. This warranty gives you specific legal rights and you may also have other rights that vary from State to State.

This warranty is only valid for sale of product(s) within the United States of America. Product(s) sold outside of the United States of America are sold "AS-IS" and shall have NO WARRANTY, express or implied. This product may be covered by a Guaranteed Protection Plan ("GPP"). See your authorized Directed dealer for details of the plan or call Directed Customer Service at 1-800-876-0800.

Make sure you have all of the following information from your authorized Directed dealer:

A clear copy of the sales receipt, showing the following:

- o Date of purchase
- o Your full name and address
- o Authorized dealer's company name and address
- o Type of alarm installed
- o Year, make, model and color of the automobile
- o Automobile license number
- o Vehicle identification number
- o All security options installed on automobile
- o Installation receipts

920-0003 06-06



## The company behind this system is Directed Electronics

Since its inception, Directed Electronics has had one purpose, to provide consumers with the finest vehicle security and car stereo products and accessories available. The recipient of nearly 100 patents and Innovations Awards in the field of advanced electronic technology.

Directed is ISO 9001 registered.

Quality Directed Electronics products are sold and serviced throughout North America and around the world.

Call (800) 274-0200 for more information about our products and services.

Designed and Engineered in the USA

***Directed***<sup>®</sup>  
E L E C T R O N I C S

G4202P 2008-05

Vista, CA 92081  
[www.directed.com](http://www.directed.com)

© 2008 Directed Electronics—All rights reserved

## Free Manuals Download Website

<http://myh66.com>

<http://usermanuals.us>

<http://www.somanuals.com>

<http://www.4manuals.cc>

<http://www.manual-lib.com>

<http://www.404manual.com>

<http://www.luxmanual.com>

<http://aubethermostatmanual.com>

Golf course search by state

<http://golfingnear.com>

Email search by domain

<http://emailbydomain.com>

Auto manuals search

<http://auto.somanuals.com>

TV manuals search

<http://tv.somanuals.com>