

# VIPER<sup>®</sup>

## AUDIO

OWNER'S  
MANUAL



model | **400.2**



## **CONGRATULATIONS**

Congratulations for choosing a Viper Audio power amplifier from Directed Electronics, the industry leader in high quality automotive security and audio equipment since 1990.

With the introduction of Viper Audio power amplifiers, Directed Electronics continues to set new standards of performance, reliability, and affordability in the mobile electronics industry.

Featuring high-efficiency MOSFET power supplies, flexible on-board crossovers, and state of the art audio design, Viper Audio power amplifiers will excite and

delight the mobile sound enthusiast with years of high-quality audio reproduction.

Viper Audio power amplifiers come with a two-year limited warranty if installed by an authorized Viper dealer. If not installed by an authorized dealer, Viper Audio power amplifiers are covered by a one-year, parts-and-labor limited warranty.

Be sure to retain your original sales receipt and refer to the warranty section of this guide for full details about your coverage.

## **TABLE OF CONTENTS**

Limited Two-Year Consumer Warranty .....	4
Features .....	5
Warning .....	5
Installation Guidelines .....	6
Wire Connector Plugs .....	7
Front Panel Connections/Status LED .....	8
Rear Panel Connections .....	8
Top Panel Controls .....	10
Top Panel Features .....	11
Speaker Wiring Diagrams .....	12
Crossover Settings and Gain Adjustment .....	13
Specifications .....	14

## **LIMITED TWO-YEAR CONSUMER WARRANTY**

Directed Electronics, Inc. promises to the original purchaser, to replace this product should it prove to be defective in workmanship or material under normal use, for a period of two years from the date of purchase by the dealer as indicated by the date code marking of the product **PROVIDED** the product was installed by an authorized Directed dealer. During this two-year period, there will be no charge for this replacement **PROVIDED** the unit is returned to Directed, shipping pre-paid. If the unit is installed by anyone other than an authorized Directed dealer, the warranty period will be one year from the date of purchase by the dealer as indicated by the date code marking of the product. During this one-year period there will be no charge for this replacement **PROVIDED** the unit is returned to Directed, shipping pre-paid. This warranty is non-transferable and does not apply to any unit that has been modified or used in a manner contrary to its intended purpose, and does not cover damage to the unit caused by installation or removal of the unit. This warranty is void if the product has been damaged by accident or unreasonable use, neglect, improper service or other causes not arising out of defects in materials or construction. **ALL WARRANTIES INCLUDING BUT NOT LIMITED TO EXPRESS WARRANTY, IMPLIED WARRANTY, WARRANTY OF MERCHANTABILITY, FITNESS FOR PARTICULAR PURPOSE, AND**

**WARRANTY OF NON-INFRINGEMENT OF INTELLECTUAL PROPERTY ARE EXPRESSLY EXCLUDED TO THE MAXIMUM EXTENT ALLOWED BY LAW, AND DIRECTED NEITHER ASSUMES NOR AUTHORIZES ANY PERSON TO ASSUME FOR IT ANY LIABILITY IN CONNECTION WITH THE SALE OF THE PRODUCT. DIRECTED HAS ABSOLUTELY NO LIABILITY FOR ANY AND ALL ACTS OF THIRD PARTIES INCLUDING ITS AUTHORIZED DEALERS OR INSTALLERS.** Unit must be returned to Directed, postage pre-paid, with: consumer's name, telephone number, and address, authorized dealer's name and address, and product description. **IN ORDER FOR THIS WARRANTY TO BE VALID, YOUR UNIT MUST BE SHIPPED WITH PROOF OF INSTALLATION BY AN AUTHORIZED DIRECTED DEALER. ALL UNITS RECEIVED BY DIRECTED FOR WARRANTY REPAIR WITHOUT PROOF OF DIRECTED DEALER INSTALLATION WILL BE COVERED BY THE LIMITED ONE-YEAR PARTS AND LABOR WARRANTY.** **Note:** This warranty does not cover labor costs for the removal and reinstallation of the unit. **BY PURCHASING THIS PRODUCT, THE CONSUMER AGREES AND CONSENTS THAT ALL DISPUTES BETWEEN THE CONSUMER AND Directed SHALL BE RESOLVED IN ACCORDANCE WITH CALIFORNIA LAWS IN SAN- DIEGO COUNTY, CALIFORNIA.**

## FEATURES

- Dual high-speed MOSFET switching power supplies and complimentary bipolar outputs.
- Stereo, mono, or simultaneous stereo/mono operation.
- Thermal, DC offset, reverse polarity and short circuit protection.
- Top-mounted controls located under illuminated Viper snake logo trim piece.
- The Viper logo and Viper badge are four-way adjustable for a custom look.
- Continuously variable 12 dB/octave two-way active crossover.
- Variable 12 dB bass EQ function.
- Buffered stereo full-range RCA output jacks.
- Gold-plated screw-block plugs and RCA jacks ensure maximum signal transfer.
- Rugged one-piece extruded heat sink finished with injection-molded mounting feet.

## WARNING



High-powered car audio systems may produce sound pressure levels that exceed the threshold at which hearing loss may result.

They may also impair a driver's ability to hear traffic sounds or emergency vehicles. Use common sense and practice safe listening habits when listening to or adjusting your audio system.

## INSTALLATION GUIDELINES

1. Please read this owner's manual carefully before installing this amplifier.
2. Disconnect the battery ground terminal prior to making any electrical connections.
3. Check for any hazards or obstructions such as gas tanks, fuel or brake lines, and wiring harnesses before mounting the amplifier.
4. Pick a mounting location that will provide adequate access and ventilation and protect the amplifier from heat, moisture, and dirt.
5. Avoid sharp metal areas when routing cables to the amplifier, and run RCA cables away from the power cables and other potentially noisy car harnesses.
6. The amplifier should be grounded with a short, heavy gauge wire connected directly to the car at a bare metal surface, preferably scraped body sheet metal. Do not use factory ground locations, seat bolts, or brackets that are spotwelded.
7. Always fuse your power connection within 8 to 10 inches of the battery terminal. Use a fuse or circuit breaker rated slightly more than the on-board fuse(s) of the amplifier(s). The gauge of power wire used should take into account the total current draw of the system, and the length of wire used. IASCA and other auto sound competition organizations have charts available for this; you can also find a chart in the MECP study guide. Minimum wire gauge recommendations for the individual amplifiers are listed on the specification page. Always use the same gauge wire for the amplifier ground that you use for the power wire. Be sure to examine the battery ground cable of the vehicle, and if necessary, upgrade it by adding an additional ground wire that is the same gauge as the amplifier's power wire. Remember, the amplifier can only deliver its rated output when it is not current limited by the power and ground supply wires.
8. This amplifier is designed to drive a speaker load that measures from 2 to 8 ohms. Keep in mind that heat is the long-term enemy of automotive electronics and the lower your speaker load, the more heat is

generated. For low impedance speaker applications or restricted ventilation installations, an external cooling fan may be advisable.

9. Battery and ground connections to the vehicle should be made with crimped ring terminals of the appropriate size (surface area is what counts); soldering the terminals after crimping is also recommended.

10. Due to the high-frequency MOSFET switching power supply, filtering the power cable is not generally required (remember that the amp can't deliver full output if the power supply is restricted). Proper grounding of the signal source is mandatory for the amplifier to reach its performance peak. If the RCA inputs are not grounded adequately via the signal source, electrical noise from the vehicle may be picked up in the system.

## **WIRE CONNECTOR PLUGS**

Power and speaker wire connections on Viper Audio power amplifiers are performed with the use of specially designed connectors that allow for ease of wire termination and installation convenience.

Poor connections are a common cause of poor sound quality or amplifier performance. Making proper wire connections is paramount to a reliable, quality sound system.

Please follow these recommendations to ensure a problem free installation:

1. Always use the proper gauge wire for the connector.
2. Cut wires to the minimum length necessary.

3. Trim the wire ends so bare wire does not protrude from the connector after termination.
4. Always tighten the connector screws firmly at least twice, once during installation and once more before returning the car to the customer.

**CAUTION:** Over tightening the screws can cause them to strip, creating loose connections. Tighten the screws twice firmly for a permanent, solid connection.

## **FRONT PANEL CONNECTIONS/STATUS LED**

1. **RCA Output Jacks** - These pass through RCA jacks can be used to send a signal to a second amplifier.
2. **RCA Input Jacks** - Accepts line level outputs from head units or signal processors at voltages between 150mV and 8 volts.
3. **Status LED** - Will light green to indicate the amplifier is on and operating normally and will be off if the amplifier shuts down due to short circuit, DC offset, or overheating detected by on-board protection circuitry.

**FIGURE 1—AMPLIFIER CONNECTIONS 400.2 FRONT**

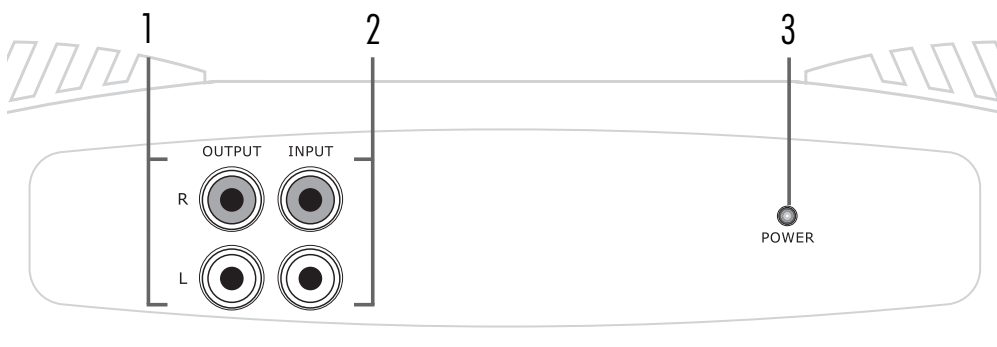

## **REAR PANEL CONNECTIONS**

1. **Speaker Out Terminals** - Connect the speakers to these terminals. (Refer to the *Speaker Connection* section of this guide.)
2. **Remote Turn On** - This terminal turns on the amplifier when (+) 12 volt is applied to it. Connect it to the remote turn on lead of the head unit or signal source. If a (+) 12 volt remote turn lead is not available, a Remote Power Adapter (P/N #55000) can be used to supply a remote turn on signal. DO NOT connect this terminal to constant (+) 12 volt.
3. **Power Fuses** - These fuses protect the amplifier against internal electrical damage and are meant to protect the amplifier only. All other power connections should be fused at the source.



4. **(+) 12 Volt Power** - Connect this terminal through a FUSE or CIRCUIT BREAKER to the positive terminal of the vehicle battery or the positive terminal of an isolated audio system battery.

**WARNING:** Always protect this power wire by installing a fuse or circuit breaker of the appropriate size within 12 inches of the battery terminal connection.

5. **Ground** - Connect this terminal directly to the sheet metal chassis of the vehicle using the shortest

wire necessary to make this connection. Always use wire of the same gauge or larger than the (+) 12 volt power wire. The chassis connection point should be scraped free of paint and dirt. Use only quality crimped and/or soldered connectors at both ends of this wire. **DO NOT** connect this terminal directly to the vehicle battery ground terminal or any other factory ground points

**FIGURE 2—AMPLIFIER CONNECTIONS 400.2 REAR**

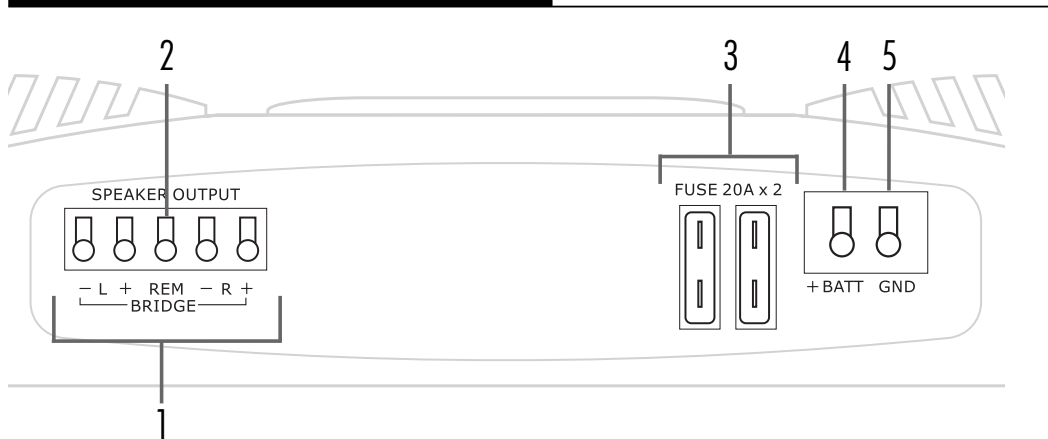

## TOP PANEL CONTROLS

1. **Input Gain Adjustment** - Controls amplifier sensitivity and is used to match the input level of the amplifier to the output level of the signal source.
2. **Crossover Selection Switch** - Controls the type of filter for the onboard active crossover. FLAT does not attenuate any frequencies and is for full range speaker systems. LPF attenuates high frequencies and is used for mid range speakers and tweeters. HPF attenuates low frequencies and is used for subwoofers speakers.
3. **Crossover Frequency Adjustment** - Adjusts the crossover point for the on board active crossover.
4. **Variable Bass EQ** - Adds 0 to 12db of additional boost to the speaker output when active.

FIGURE 3—AMPLIFIER CONTROLS TOP

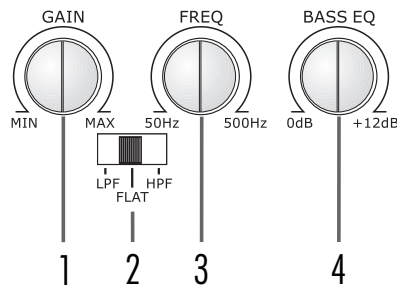

## **TOP PANEL FEATURES**

### **Control Panel Cover**

The amplifier's gain and filter controls are mounted under the elliptical control panel cover. Magnets hold the cover snugly and allow easy access.

- **To install the cover** - Place the straight end of the control panel cover into the notched end of the amplifier's top panel while elevating the curved end. Lower the curved end of the cover until the magnets make contact.
- **To remove the cover** - Place a finger on the curved end of the cover while lifting up the straight end with your thumb. When the magnets lose contact, lift and remove the cover.

### **Illuminated Window Alignment**

The illuminated window comes attached to the control panel cover with a light adhesive tape. An additional supply of precut adhesive tape is included in the hardware pack.

1. Firmly hold the control panel cover while gently pressing against the window from the top. If the window will not release easily use a small flat tool to pry it loose. Pry slowly and evenly from several points to avoid deforming or

cracking the window.

2. Apply two of the precut pieces of adhesive tape to the corners of the window that don't have tape. Make sure to apply the tape to the side that makes contact with the cover. Save the other two precut pieces of tape for future use.
3. Turn the illuminated window so the Viper snake logo will be in an upright position when the cover is re-attached to the amplifier. Press the window onto the underside of the control panel cover using the positioning pins for alignment.

### **Viper Badge Mounting**

The Viper Badge can be rotated in 90-degree increments to accommodate the amplifier's final mounting position.

1. Determine the final mounting position of the amplifier.
2. Determine the position required for the badge to be viewed horizontally.
3. Remove the protective cover for the adhesive tape on the under side of the badge.
4. Align the badge guideposts with the holes in the amplifier top panel.
5. Press down firmly until the logo is securely attached to the amplifier.

# SPEAKER WIRING DIAGRAMS

## Stereo operation (bottom view)

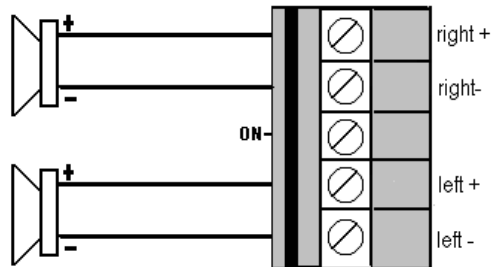

## Mono operation (bottom view)

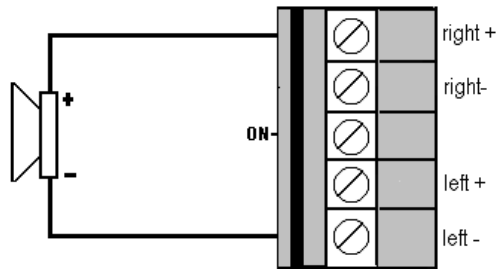

## Simultaneous stereo/mono operation (bottom view)

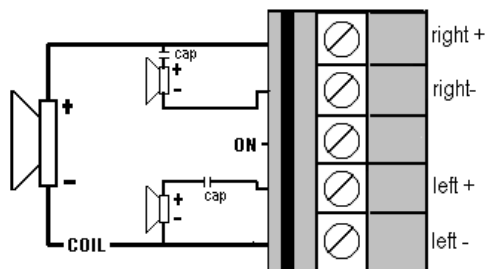

## **CROSSOVER SETTINGS AND GAIN ADJUSTMENT**

Your Viper Audio power amplifier needs to be adjusted carefully to achieve maximum performance. These are some guidelines to follow when fine-tuning the amplifier.

- For full-range and simultaneous stereo/mono bass applications, the crossover selection switch should be set to FLAT. If the amplifier is driving your subwoofers, set the switch to LPF, and for mid-bass/midrange output, set to HPF.
- The crossover frequency control needs to be adjusted to suit your particular system. For subwoofer applications, try to keep the setting low enough to prevent the image smearing (you should not be able to hear male voices from the subwoofer) but not so low as to create a gap between the subwoofer and the mid-bass/midrange speakers. For mid-bass/midrange settings, try to keep the setting low enough to keep your sound stage in front of you, without overdriving the speaker. It will be to your advantage to spend some extra time with this adjustment, listening to familiar music or system set-up discs to achieve the kind of musical reproduction that you prefer.
- The gain adjustment allows you to set proper signal match for clean, quiet amplifier operation. For full-range and simultaneous stereo/mono bass applications, start by playing some music you are familiar with. With the gain adjustment on the amplifier in the middle of its rotation, bring up the volume on your head unit to the 3/4 volume setting or until you start to hear distortion or clipping. If you hear distortion before you reach the 3/4 volume setting of your head unit, reduce the gain setting on the amplifier and start to raise the head unit volume again. When you can listen to the music at or slightly above 3/4 on your head unit without audible distortion, slowly raise the gain of the amplifier until distortion is heard, then back off the gain until the distortion is not audible. This setting will allow you to reach full output with all but the quietest of source material, while avoiding excessive noise in the system.
- The same procedure should be used for adjusting the amplifier when the on-board crossover is set to LPF or HPF, but you will also have to take into consideration the effect that gain adjustment has on system frequency response and imaging. Again, plan on spending some time with music that you know, getting the gain and crossover settings the way you like. Test discs and analyzers may help with this process, but in the end it's your ears that count - listen to the music!

## SPECIFICATIONS

<b>Viper model</b>	<b>400.2</b>
<b>RMS continuous power per channel</b> , both channels driven into 4 ohms from 20 to 20,000 Hz, with less than 0.08% Total Harmonic Distortion @ 14.4 VDC	125 watts
<b>RMS continuous power per channel</b> , both channels driven into 2 ohms from 20 to 20,000 Hz, with less than 0.1% Total Harmonic Distortion @ 14.4 VDC	200 watts
<b>RMS continuous power</b> bridged into a 4 ohm load from 20 to 20,000 Hz, with less than 0.1% Total Harmonic Distortion @ 14.4 VDC	400 watts
<b>Dynamic power rating</b> (IHF-202 Standard) bridged into 4 ohms	550 watts
Signal-to-Noise Ratio	Greater than 95 dB
Frequency Response	20-20,000 Hz $\pm$ 0.5 dB
Damping Factor @ 4 ohm	Greater than 200
Crossover	Switchable high or low pass 12 dB/octave, continuously variable from 50 to 500 Hz
Bass Equalization	Variable 0-12 dB
Input Impedance	20K ohms
Input Sensitivity	Variable from 150 mV to 8 volt
Output Impedance	2 to 8 ohms, stereo 4 to 8 ohms, bridged
Supply Voltage	10 to 16 VDC
Fusing and Power	40A
Minimum Cable Requirements (AWG) (Per amp, trunk mounted)	#8



# **Directed**<sup>®</sup>

**ELECTRONICS, INC.**

Directed Electronics, Inc.  
Vista, California 92083  
[www.directed.com](http://www.directed.com)

The company behind this system is Directed Electronics, Inc. Since its inception, Directed has had one purpose, to provide customers with the finest vehicle security, car stereo products, rear seat entertainment, and accessories available. The recipient of more than 20 patents in the field of advanced electronic technology, Directed is ISO 9001 registered.

**Directed<sup>®</sup> is committed to delivering world-class quality products and services that excite and delight our customers.**

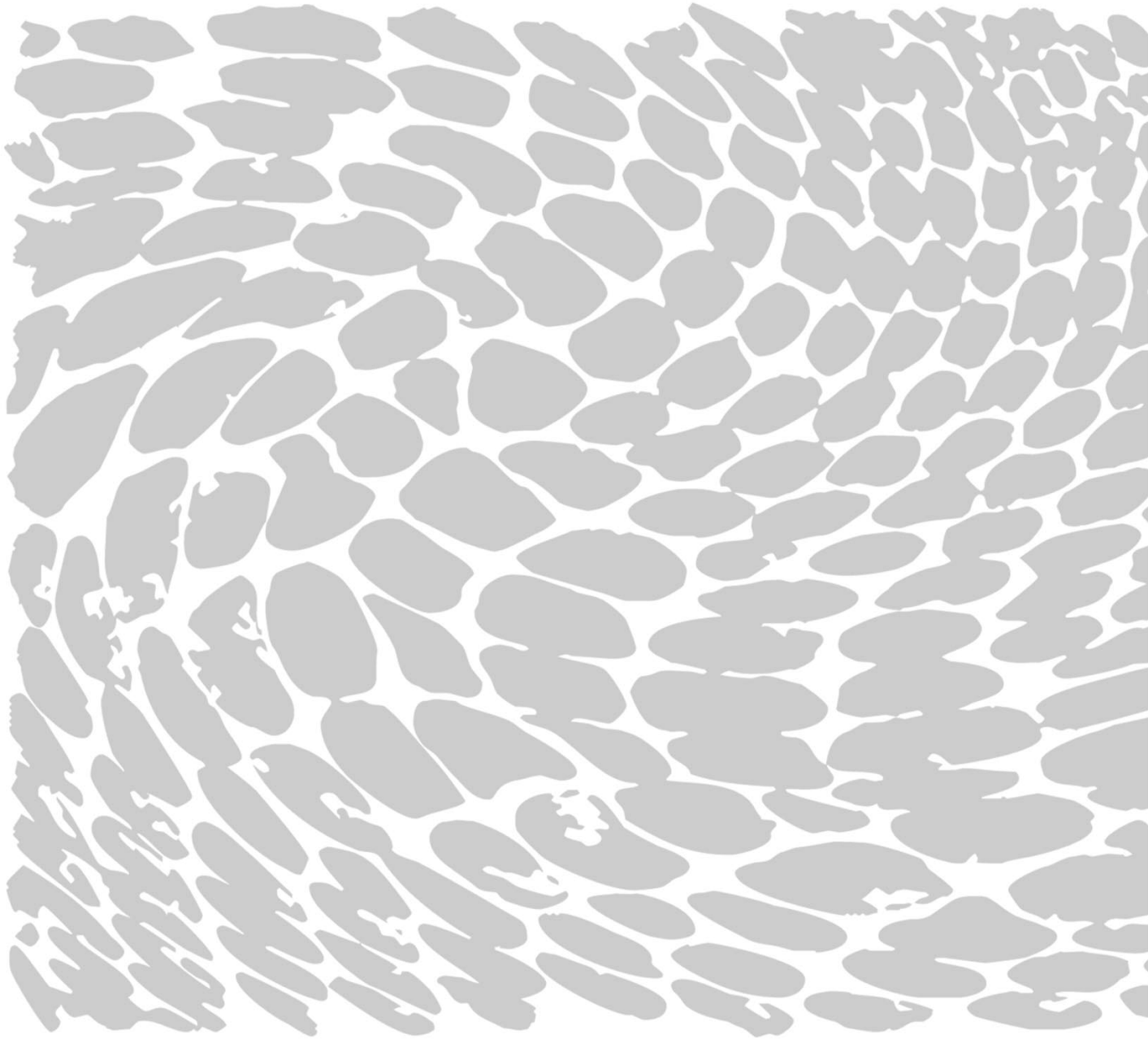

Directed is a proud member of



Quality Directed products are sold and serviced throughout North America and around the world

Call **800 274 0200** for more information about our products and services



## Free Manuals Download Website

<http://myh66.com>

<http://usermanuals.us>

<http://www.somanuals.com>

<http://www.4manuals.cc>

<http://www.manual-lib.com>

<http://www.404manual.com>

<http://www.luxmanual.com>

<http://aubethermostatmanual.com>

Golf course search by state

<http://golfingnear.com>

Email search by domain

<http://emailbydomain.com>

Auto manuals search

<http://auto.somanuals.com>

TV manuals search

<http://tv.somanuals.com>