

ASSEMBLY

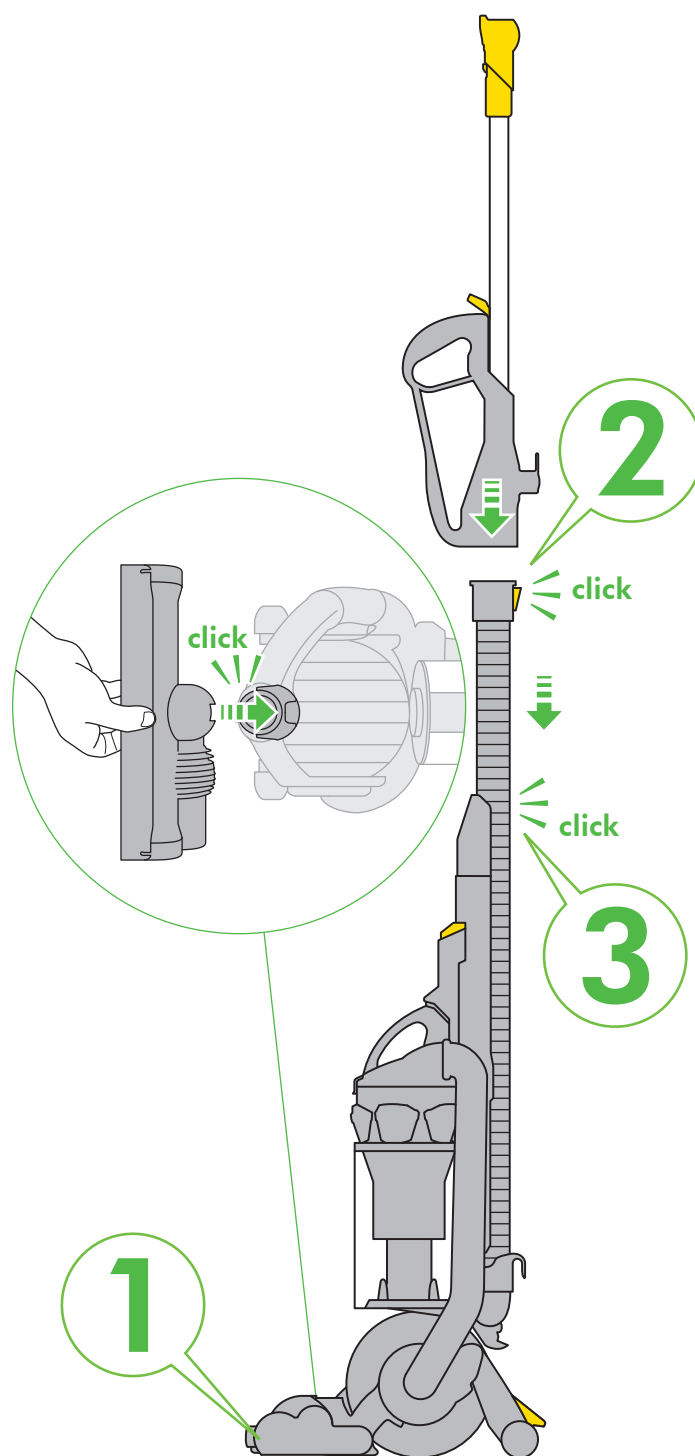

REGISTER FOR YOUR FREE 5 YEAR GUARANTEE TODAY

After registering for your 5 year guarantee, your Dyson vacuum cleaner will be covered for parts and labour for 5 years from the date of purchase, subject to the terms of the guarantee.

If you have any query about your Dyson vacuum cleaner, call the Dyson Customer Care Helpline with your serial number and details of where/when you bought the vacuum cleaner. Your serial number can be found on your rating plate which is behind the clear bin.

Most queries can be solved over the phone by one of our trained Dyson Customer Care Helpline staff.

Alternatively visit www.dyson.co.uk/support for online help, general tips and useful information about Dyson.

Note your serial number for future reference

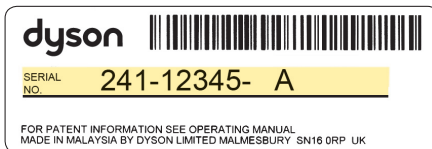

3 EASY WAYS TO REGISTER FOR YOUR FREE 5 YEAR GUARANTEE

REGISTER ONLINE

Visit our website to register your full parts and labour guarantee online.

www.dyson.com/register



REGISTER BY PHONE

Call our dedicated Helpline Open 7am–10pm. 7 days a week.

UK 0800 298 0298
IRL 01 475 7109



REGISTER BY MAIL

Complete and return the form to Dyson in the envelope supplied.



IMPORTANT SAFETY PRECAUTIONS

READ ALL INSTRUCTIONS BEFORE USING THIS VACUUM CLEANER

When using an electrical appliance, basic precautions should always be followed, including the following:



WARNING

TO REDUCE THE RISK OF FIRE, ELECTRIC SHOCK, OR INJURY:

1. This vacuum cleaner is for domestic use only. Do not use outdoors or on wet surfaces.
2. Do not handle plug or vacuum cleaner with wet hands.
3. Do not allow to be used as a toy. Close attention is necessary when used by or near children.
4. Do not use with damaged cable or plug. If the supply cable is damaged, it must be replaced by Dyson's authorised service centres in order to avoid a hazard.
5. If the vacuum cleaner is not functioning properly, has been dropped, damaged, left outdoors, or immersed in liquid, do not use, contact the Dyson Customer Care Helpline.
6. Do not use the vacuum cleaner if any parts appear to be faulty, missing or damaged.
7. Ensure all parts including the clear bin are securely attached before using or carrying the vacuum cleaner.
8. This vacuum cleaner is not intended for use by persons (including children) with reduced physical, sensory or mental capabilities, or lack of experience and knowledge, unless they have been given supervision or instruction concerning use of the vacuum cleaner by a person responsible for their safety. Children should be supervised to ensure that they do not play with the vacuum cleaner.
9. Do not leave vacuum cleaner when plugged in. Unplug from outlet when not in use, and before performing user maintenance, connecting or disconnecting the hose or changing accessories.
10. Store the vacuum cleaner indoors. Do not use or store this vacuum cleaner below 0°C (32°F). Ensure that the vacuum cleaner is at room temperature before operating. Put the vacuum cleaner away after use with the cable stored safely, to prevent tripping hazards.
11. If the vacuum cleaner overheats it will cut-out. It must be switched off, unplugged and allowed to cool down before attempting to check filters or for blockages.
12. Turn off all controls before unplugging.
13. Do not unplug by pulling on cable. To unplug, grasp the plug, not the cable.
14. Do not pull or carry by cable, use cable as a handle, close a door on cable, or pull cable around sharp edges or corners. Do not run vacuum cleaner over cable. Keep cable away from heated surfaces.
15. The use of an extension cable is not recommended.
16. Keep hair, loose clothing, fingers, and all parts of body away from openings and moving parts, such as the brushbar.
17. Do not put any object into openings. Do not use with any opening blocked; keep free of dust, lint, hair and anything that may reduce airflow.
18. Take extra care when vacuuming on stairs. Do not work with the vacuum cleaner above you on the stairs.
19. Keep the vacuum cleaner on the floor. Do not put the vacuum cleaner on chairs, tables etc.
20. Do not shake the vacuum cleaner or press the cyclone release button while carrying the vacuum cleaner, or it could fall and cause injury.
21. Do not use to pick up flammable or combustible liquids, such as gasoline, or use in areas where they may be present.
22. Do not pick up anything that is burning or smoking, such as cigarettes, matches, or hot ashes.
23. Check to ensure your electricity supply matches that shown on the rating plate. The vacuum cleaner must only be used as rated.
24. Use only as described in this manual. Use only Dyson recommended attachments.
25. Do not use without clear bin and filters in place.
26. Do not lubricate any parts, or carry out any maintenance or repair work other than that shown in this manual, or as advised by the Dyson Customer Care Helpline.

SAVE THESE INSTRUCTIONS

THIS VACUUM CLEANER IS INTENDED FOR HOUSEHOLD USE ONLY

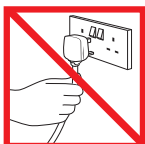

Do not pull on the cable.

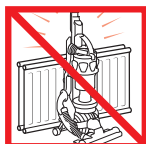

Do not store near heat sources.



Do not use near naked flame.



Do not run over the cable.



Do not pick up water or liquids.



Do not pick up burning objects.



Do not use above you on the stairs.



Do not put hands near the brush bar when the vacuum cleaner is in use.

Usage

ON/OFF

Clear bin emptying

MAX

THE BRITISH ALLERGY FOUNDATION SEAL OF APPROVAL

2

click

click

1

click

Blockages

1

2

Carpets/hard floors

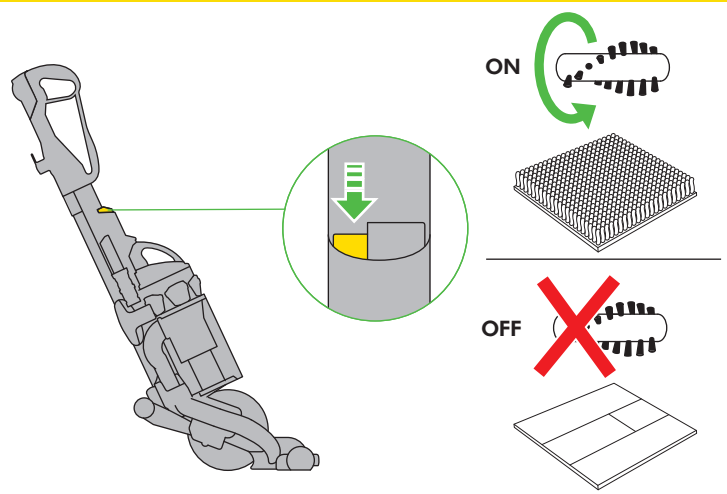

High-reach cleaning

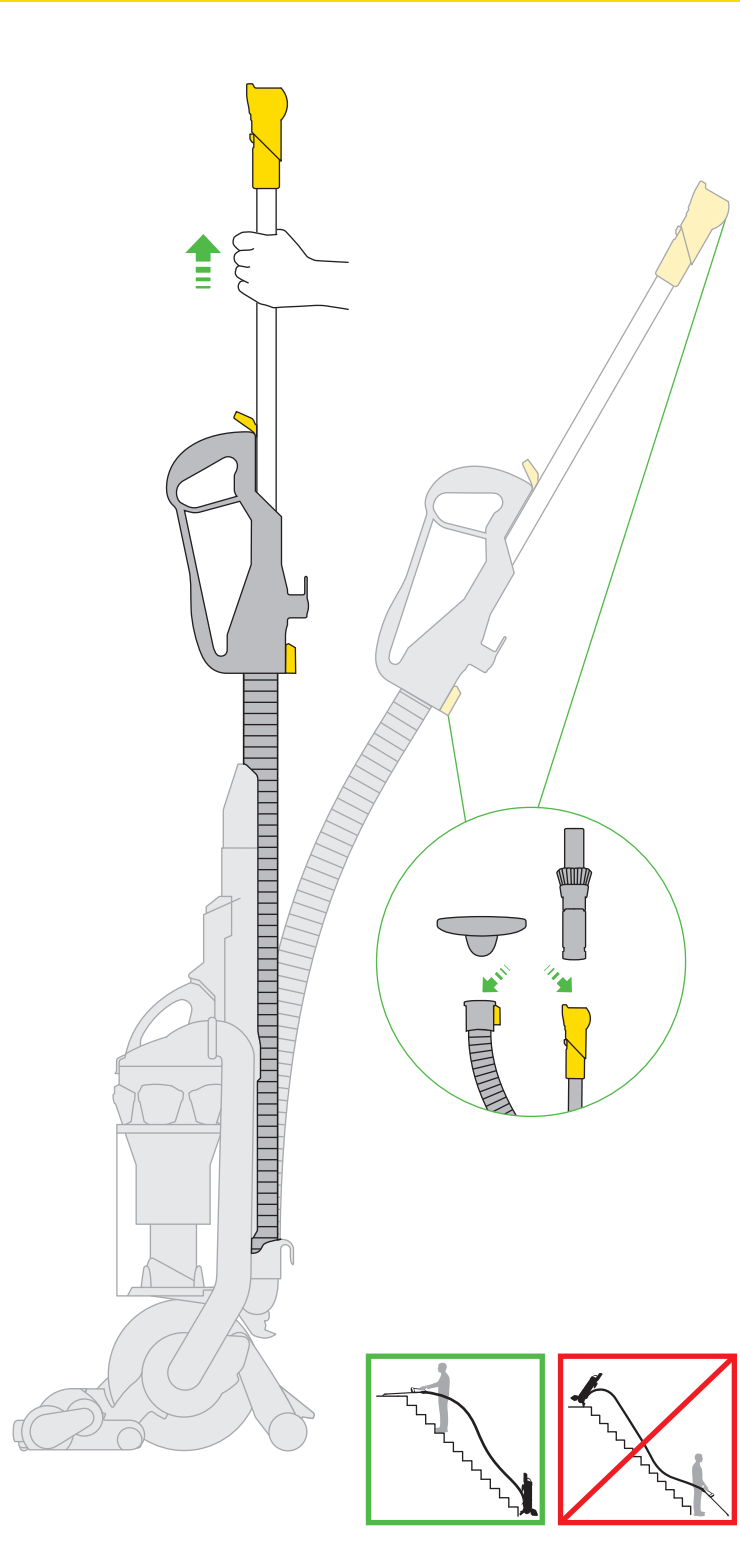

3

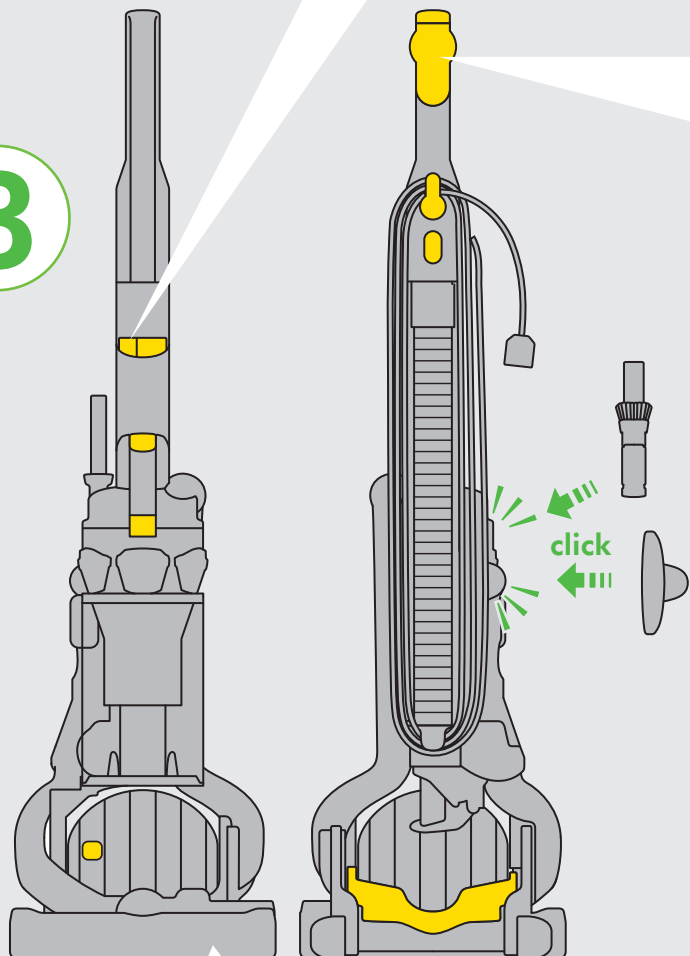

Clearing obstructions / Brush bar reset

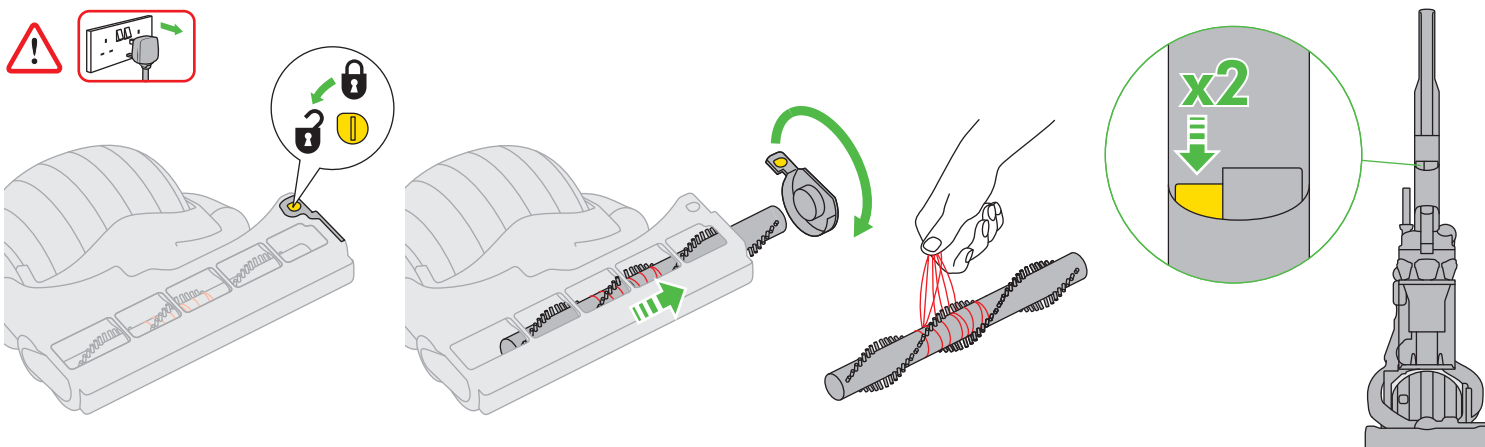

IMPORTANT!

WASH FILTERS

 **3**
months

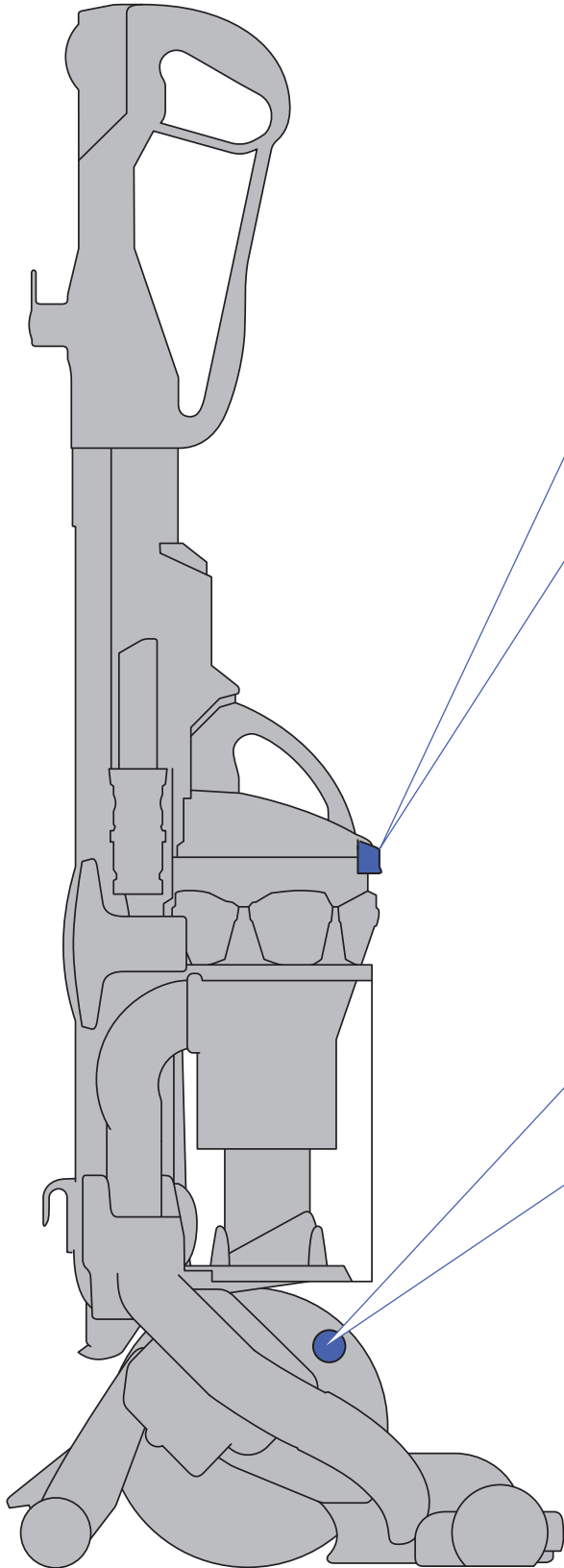

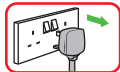
  **Filter A**

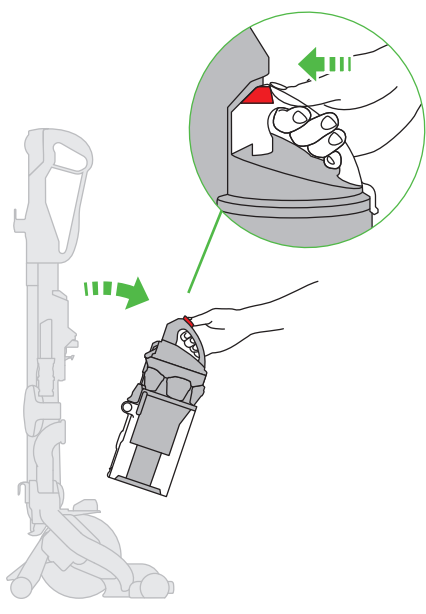

The diagram shows a hand pulling the motor unit out of the vacuum tube. A circular inset shows a hand pulling a red filter out of the motor unit. A second inset shows the red filter being placed into a grey bucket.

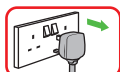
  **Filter B**

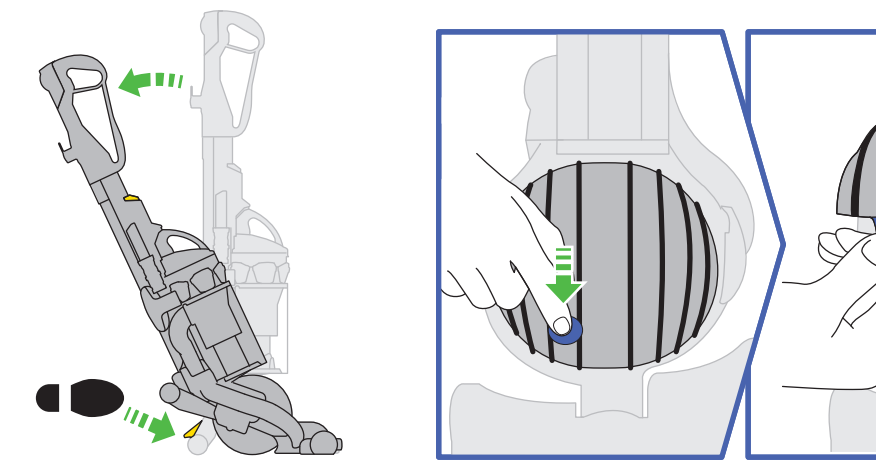

The diagram shows the motor housing being tilted. A circular inset shows a hand pulling a blue filter out of the motor housing. A second inset shows the blue filter being placed into a grey bucket.

Wash filters with cold water at least every 3 months.

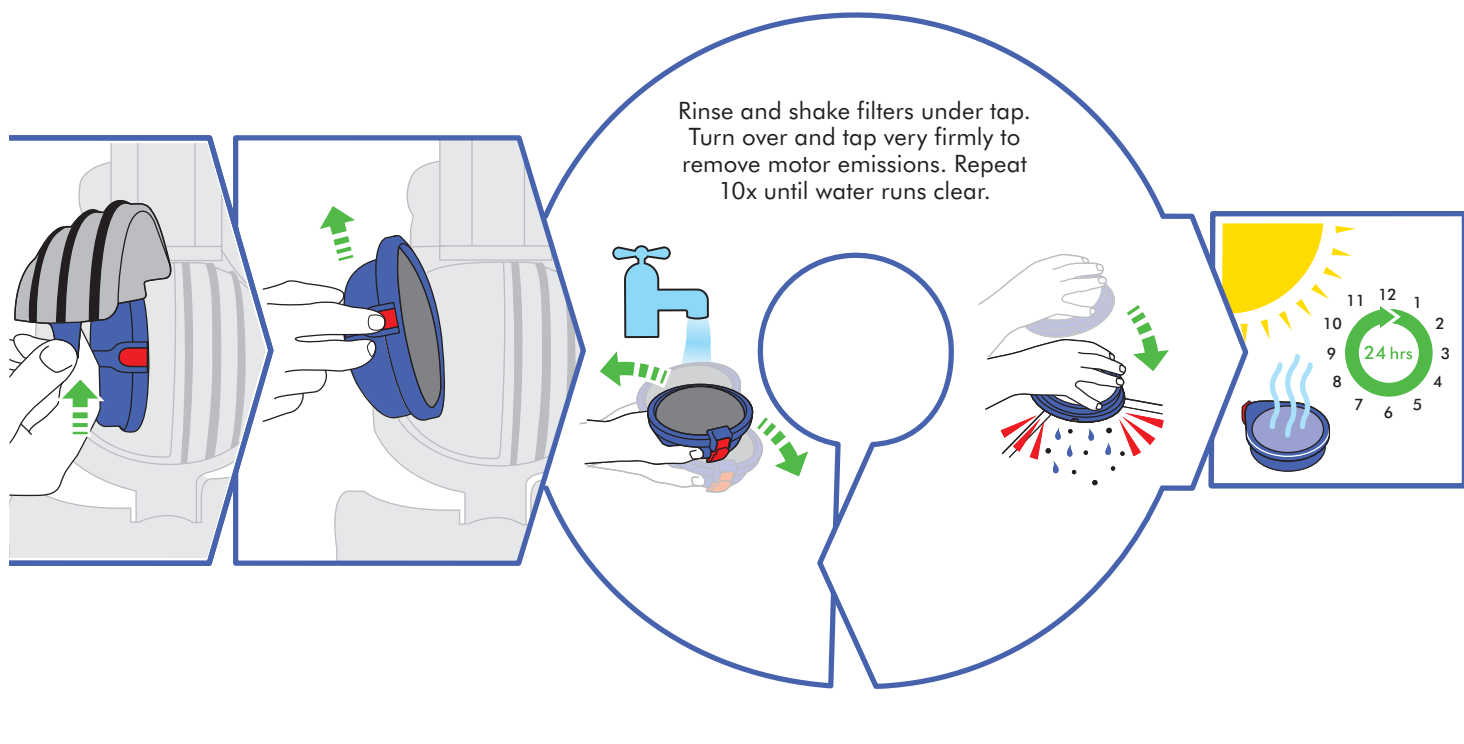
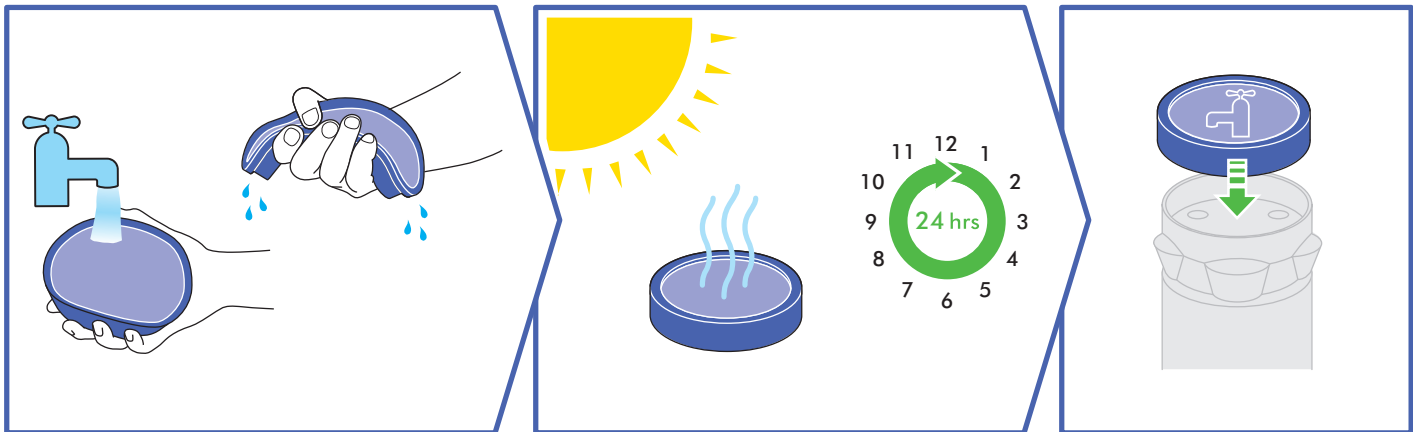

ASSEMBLY

- Lie vacuum cleaner flat and push on cleaner head until it clicks. Stand vacuum up straight, insert wand into hose and push into place until it clicks. Attach tool to the side of the vacuum cleaner.

USING YOUR DYSON VACUUM CLEANER

Press foot pedal and recline handle to use. The stabiliser stand will automatically lift up. To switch 'ON', depress power button in front of handle. When finished cleaning, push vacuum cleaner into an upright position and stabiliser wheels will automatically drop. Use the carrying handle to carry the vacuum cleaner.

⚠ CAUTION:

- When returning to the upright position, ensure that the stabiliser wheels are fully engaged before releasing the cleaner.
- Do not press the cyclone release button while carrying the vacuum cleaner or it could fall and cause injury.

PLEASE NOTE:

- Fine dust such as plaster or flour should only be vacuumed in very small amounts.
- Consult your flooring manufacturer's recommended instructions before vacuuming and caring for your flooring, rugs and carpets. Some carpets will fuzz if a rotating brushbar is used when vacuuming. If this is the case, we recommend vacuuming in hard floors mode and consulting with your flooring manufacturer. (Refer to carpets/hard floors section.)
- If used in a garage when car cleaning, care should be taken to wipe the soleplate and wheels with a dry cloth after vacuuming to clean off any sand, dirt, or pebbles which could damage delicate floors.

CARPETS/HARD FLOORS

The brushbar will always default to 'ON' (spinning) each time you switch on the vacuum cleaner and recline it for cleaning. The brushbar will automatically stop if it becomes obstructed. If the brushbar stops during use, please refer to the 'Clearing brushbar obstructions' section.

To switch the brushbar off (e.g. for hard floors), recline the vacuum cleaner and turn it 'ON', then press the brushbar 'on/off' button – the brushbar will stop spinning.

HIGH-REACH CLEANING

⚠ CAUTION:

- Switch 'OFF' the vacuum before changing tools.
- Powerful suction can cause the hose to 'pull back' – please take care.
- Take extra care when vacuuming on stairs; do not work with the vacuum above you on the stairs. Do not put the vacuum on chairs, tables etc.
- Ensure vacuum is in upright position before using tools.

PLEASE NOTE:

- To release the wand, open the wand cap and pull the red tube until the wand releases from the vacuum. Tools can be attached to either the hose or wand.
- The brush bar will not rotate when the vacuum is in an upright position.
- Ensure wand cap is closed when not in use.

CLEAR BIN EMPTYING

⚠ CAUTION:

- Switch 'OFF' and unplug the vacuum cleaner before emptying the bin.
- Empty as soon as the dirt reaches the level of the MAX mark – do not overfill. To remove the clear bin from the vacuum cleaner press the button at rear of carrying handle. To release the dirt, press the red bin release button.
- To minimize dust/allergen contact when emptying, encase base of bin tightly in a plastic bag before trigger releases dirt. Remove bin carefully and seal bag tightly, dispose as normal.

PLEASE NOTE:

- Do not use the vacuum cleaner without the clear bin in place.

CLEAR BIN CLEANING

⚠ CAUTION:

- Do not immerse the whole cyclone in water or pour water into the cyclones.
- Ensure the bin is completely dry before replacing.

PLEASE NOTE:

- Do not use detergents, polishes or air fresheners to clean the bin.
- Do not put the bin in a dishwasher.
- When vacuuming, certain carpets may generate small static charges in the clear bin. These are entirely harmless and are not associated with the mains supply. To minimise any effect from this, do not put your hand or insert any object into the clear bin unless you have first emptied it and rinsed it out with cold water.
- Clean the shroud with a cloth or dry brush to remove lint and dust.

WASHING YOUR FILTERS

DO THIS EVERY 3 MONTHS

⚠ CAUTION:

- Switch 'OFF' and unplug the vacuum cleaner before removing the filters.
- Ensure filters are completely dry before refitting into the vacuum cleaner.

PLEASE NOTE:

- This vacuum cleaner has two filters, located as shown. It is important to check your filters regularly and wash at least every 3 months according to instructions.
- The filter in the ball should be rinsed and tapped out until the water runs clean, then tapped out again to ensure all excess water is removed. Please leave to dry completely for 24 hours.
- It is normal for the filter in the ball to turn grey in colour. The filters may require

more frequent washing if vacuuming fine dust.

- Do not use detergents to clean the filters.
- Do not put the filters in a dishwasher, washing machine, tumble dryer, oven, microwave or near an open flame.

LOOKING FOR BLOCKAGES

⚠ CAUTION:

- Switch 'OFF' and unplug the vacuum cleaner before checking for blockages.
- Please ensure vacuum cleaner is upright before removing hose or airway inspection parts.
- Beware of sharp objects when clearing blockages.
- Refit all parts of the vacuum cleaner securely before using.

PLEASE NOTE:

- Clearing blockages is not covered by your vacuum cleaner's limited guarantee. If any part of your vacuum cleaner becomes blocked, it may overheat and then automatically shut off. Unplug the vacuum cleaner and leave to cool down. Clear blockage before restarting.

CLEARING BRUSH BAR OBSTRUCTIONS

⚠ CAUTION:

- Switch off and unplug the vacuum cleaner before clearing brushbar obstructions. Failure to do so could result in personal injury. If your brushbar is obstructed, it may shut off. If this happens you will need to remove the brushbar as shown and clear any obstructing debris.

CONFORMITY INFORMATION

The symbol  on the product or on its packaging indicates that this product should not be treated as household waste. Instead it should be handed over to the applicable collection point for the recycling of electrical and electronic equipment – this may be your local civic amenity site or a facility provided by the retailer selling the product or a replacement product. By ensuring this product is disposed of correctly, you will help prevent potential negative consequences for the environment and for human health, which could otherwise be caused by inappropriate waste handling of this product. For more detailed information about recycling of this product, please contact the Dyson Customer Care Helpline, your local authority civic amenity site or the retailer selling the product or a replacement product.

GUARANTEE – TERMS AND CONDITIONS

DYSON CUSTOMER CARE

If you have a question about your Dyson vacuum cleaner, call the Dyson Customer Care Helpline with your serial number and details of where and when you bought the vacuum cleaner, or contact us via the website. The serial number can be found on the main body of the vacuum cleaner behind the clear bin. Most questions can be solved over the phone by one of our Dyson Customer Care Helpline staff.

If your vacuum cleaner needs service, call the Dyson Customer Care Helpline so we can discuss the available options. If your vacuum cleaner is under guarantee, and the repair is covered, it will be repaired at no cost.

PLEASE REGISTER AS A DYSON MACHINE OWNER

THANK YOU FOR CHOOSING TO BUY A DYSON VACUUM CLEANER.

To help us ensure you receive prompt and efficient service, please register as a Dyson machine owner. There are three ways to do this:

- Online at www.dyson.co.uk
- By calling the Dyson Customer Care Helpline.
- By completing and returning the enclosed form to us by mail. This will confirm ownership of your Dyson vacuum cleaner in the event of an insurance loss, and enable us to contact you if necessary.

LIMITED 5 YEAR GUARANTEE

TERMS AND CONDITIONS OF THE DYSON 5 YEAR LIMITED GUARANTEE.

WHAT IS COVERED

- The repair or replacement of your vacuum cleaner (at Dyson's discretion) if your vacuum cleaner is found to be defective due to faulty materials, workmanship or function within 5 years of purchase or delivery (if any part is no longer available or out of manufacture Dyson will replace it with a functional replacement part).
- Use of the vacuum cleaner in UK and Ireland.

WHAT IS NOT COVERED

Dyson does not guarantee the repair or replacement of a product as a result of:

- Normal wear and tear (e.g. fuse, belt, brush bar, batteries etc).
- Accidental damage, faults caused by negligent use or care, misuse, neglect, careless operation or handling of the vacuum cleaner which is not in accordance with the Dyson Operating Manual.
- Blockages – please refer to the Dyson Operating Manual for details of how to unblock your vacuum cleaner.
- Use of the vacuum cleaner for anything other than normal domestic household purposes.
- Use of parts not assembled or installed in accordance with the instructions of Dyson.
- Use of parts and accessories which are not Dyson Genuine Components.
- Faulty installation (except where installed by Dyson).
- Repairs or alterations carried out by parties other than Dyson or its authorised agents.
- If you are in any doubt as to what is covered by your guarantee, please call the Dyson Customer Care Helpline.

SUMMARY OF COVER

- The guarantee becomes effective at the date of purchase (or the date of delivery if this is later).
- You must provide proof of delivery/purchase before any work can be carried out on your vacuum cleaner. Without this proof, any work carried out will be chargeable. Please keep your receipt or delivery note.
- All work will be carried out by Dyson or its authorised agents.
- Any parts which are replaced will become the property of Dyson.
- The repair or replacement of your vacuum cleaner under guarantee will not extend the period of guarantee.
- The guarantee provides benefits which are additional to and do not affect your statutory rights as a consumer.

ABOUT YOUR PRIVACY

Your information will be held by Dyson Limited and its partner companies for promotional, marketing and servicing purposes.

If your personal details change, if you change your mind about any of your marketing preferences or if you have any queries about how we use your information, please let us know by contacting Dyson Limited, Tetbury Hill, Malmesbury, Wiltshire SN16 0RP England, or by calling the Dyson Customer Care Helpline on UK: 0800 298 0298 or IRL: 01 475 7109. Or you can email us at askdyson@dyson.co.uk.

For more information on how we protect your privacy, please see our privacy policy on www.dyson.co.uk

The British Allergy Foundation is a UK national charity with the aim of improving awareness, prevention and treatment of allergies. The British Allergy Foundation Seal of Approval is a UK registered trademark.

PRODUCT INFORMATION

Product weight 7.5kg.

Please note: Small details may vary from those shown.

This product is protected by the following intellectual property rights:

PATENT/PATENT APPLICATION NUMBERS

JP 2004-537336; EP 1361812; AU 744408; EP 1119282; JP 2002-527132;
US 6,519,807; AU 744362; EP 1121043; JP 2002-527131; US 6,572,078;
GB 0326102.1; AU 2002-226556; EP 1370172; JP 2004-528876;
US 6,991,666; AU 2002-225207; EP 1361814; JP 2004-520137; US 7,018,439;
AU 2001-240894; EP 1268076; JP 2003-528704; US 6,835,222; AU 2002-
225232; EP 1361815; JP 3940082; US 6,974,488; AU 2003-283157;
EP 1526796; JP 2006-503607; US 2005-0235454; AU 2003-283159;
EP 1526797; JP 2005-534442; AU 2003-283161; EP 1526798; JP 2006-
503608; AU 2004-294771; EP 1680232; JP 2007-508934; US 2007-0079579;
AU 2005-263889; EP 1768536.

Equivalent patents, registered designs and applications exist in other countries.

IMPORTANT!

WASH FILTERS



Wash filters with cold water at least every 3 months.



Dyson Customer Care

If you have a question about your Dyson vacuum cleaner, call the Dyson Customer Care Helpline with your serial number and details of where and when you bought the cleaner, or contact us via the Dyson website. The serial number can be found on the main body of the vacuum cleaner behind the clear bin.

GB Dyson Customer Care
askdyson@dyson.co.uk
0800 298 0298

Dyson Ltd, Tetbury Hill, Malmesbury, Wiltshire SN16 0RP.

IRL Dyson Customer Care
irelandservice@dyson.com
01 475 7109

Dyson Ireland Limited, Unit G10, Grants Lane,
Greenogue Business Park, Rathcoole, Dublin 24





GUARANTEE FORM

Serial number

--

Date of purchase / /

Country of purchase UK Ireland

Title

Surname

--

First name

--

Address

Postcode

--

e-mail

--

Telephone

Mobile

--

As a Dyson machine owner, you can hear about Dyson inventions and ideas before anyone else. If it's okay to contact you, please let us know how we may do this.

Sometimes we might ask for feedback on our ideas or invite you to try new products and services. Would it be okay if our partner companies occasionally get in touch about this?

By mail Yes No
By phone Yes No
By email Yes No
By text message Yes No

Tick box if no

3 EASY WAYS TO REGISTER FOR YOUR FREE 5 YEAR GUARANTEE

REGISTER ONLINE



Visit our website to register your full parts and labour guarantee online.

www.dyson.com/register

REGISTER BY PHONE



Call our dedicated Helpline Open 7am-10pm. 7 days a week.

UK 0800 298 0298
IRL 01 475 7109

REGISTER BY MAIL



Complete and return the form to Dyson in the envelope supplied.

Free Manuals Download Website

<http://myh66.com>

<http://usermanuals.us>

<http://www.somanuals.com>

<http://www.4manuals.cc>

<http://www.manual-lib.com>

<http://www.404manual.com>

<http://www.luxmanual.com>

<http://aubethermostatmanual.com>

Golf course search by state

<http://golfingnear.com>

Email search by domain

<http://emailbydomain.com>

Auto manuals search

<http://auto.somanuals.com>

TV manuals search

<http://tv.somanuals.com>