

# dyson

DC  
01

## Operating manual

Please read carefully before assembling or using your DCO1 vacuum cleaner.



### Important safety instructions – please read before use

WHEN USING THE DYSON DCO1 VACUUM CLEANER PLEASE ADHERE TO THESE SIMPLE PRECAUTIONS. BY DOING SO YOU WILL REDUCE THE RISK OF FIRE, ELECTRICAL SHOCK OR INJURY.

1. Do not leave your Dyson cleaner with the plug connected to a mains outlet – unplug when not in use. Turn the cleaner off with the switch button before removing from the mains outlet.
2. Always remove the plug from a mains outlet before carrying out any maintenance. Do not carry out any maintenance work on the cleaner other than that outlined in this manual, especially where electrical components are concerned.
3. Do not use without the clear bin assembly fitted correctly and both filters in place.
4. Do not fit anything other than Dyson spare parts (available on the Helpline on 1800 239 766). Use of non-Dyson parts could invalidate your guarantee.
5. Do not continue to use the cleaner if any part appears to be faulty, missing or damaged. In these cases, contact the Dyson Helpline on 1800 239 766.
6. Do not put any part of the body, clothes or any object near or into the openings or moving parts of the machine. Do not use the machine with any of the openings blocked with any object that may restrict the airflow.
7. Do not pull on the supply cord, run over it or pull it around sharp edges or near/over hot surfaces. If damaged, call the Dyson Helpline. Do not handle the cleaner or plug with wet hands.
8. Do not use the cleaner if the cord or plug are damaged or if the cleaner has been damaged, dropped or has come into contact with water or any other liquid. In these cases, contact the Helpline.
9. Do not use the cleaner to pick up water or any other liquid. Electrical shocks could occur if used outdoors or on wet surfaces.
10. Do not use the cleaner to pick up flammable or combustible substances or hot ashes or burning objects of any kind. Do not use near such substances.
11. Do not work below the cleaner on the stairs.
12. Do not immerse the whole cleaner in water for cleaning. The clear bin alone may be washed out after emptying. Ensure this is completely dry before using the cleaner again.
13. Static charge can occur in many ways and, when vacuuming, certain carpets may generate small static charges in the clear bin. These are entirely harmless and are not associated with the mains supply. To minimise any effect from this, do not put your hand or insert any object into the clear bin unless you have first emptied and rinsed out the clear bin with water.
14. Cleaners with brush bars may mark the surface of smooth floors.
15. Ensure that hands, feet and fingers, particularly those of small children, are kept away from the cleaner and especially from the brush bar.
16. Please note that the brush bar continues to turn while the hose is in use – ensure that the cable is clear of the machine during this operation and that the cleaner is not placed near anything which may come into contact with the brushbar.
17. Do not use the cleaner directly facing gas fires, boilers or open fires, whether lit or unlit. Exhaust air discharged at the front of the cleaner may extinguish a gas fire or pilot light or disturb ashes in an open fire. Always avoid directing the cleaner towards naked flames.

dyson

Helpline 1800 239 766  
Facsimile (02) 9526 7122  
Contact for all service assistance

DYSON CUSTOMER CARE  
PO BOX 2715  
TAREN POINT  
NSW 2229  
AUSTRALIA

# 1. Getting started

Assemble the machine as follows:

## Wand & hose assembly

Push yellow hose cuff firmly over wand end with twisting motion.

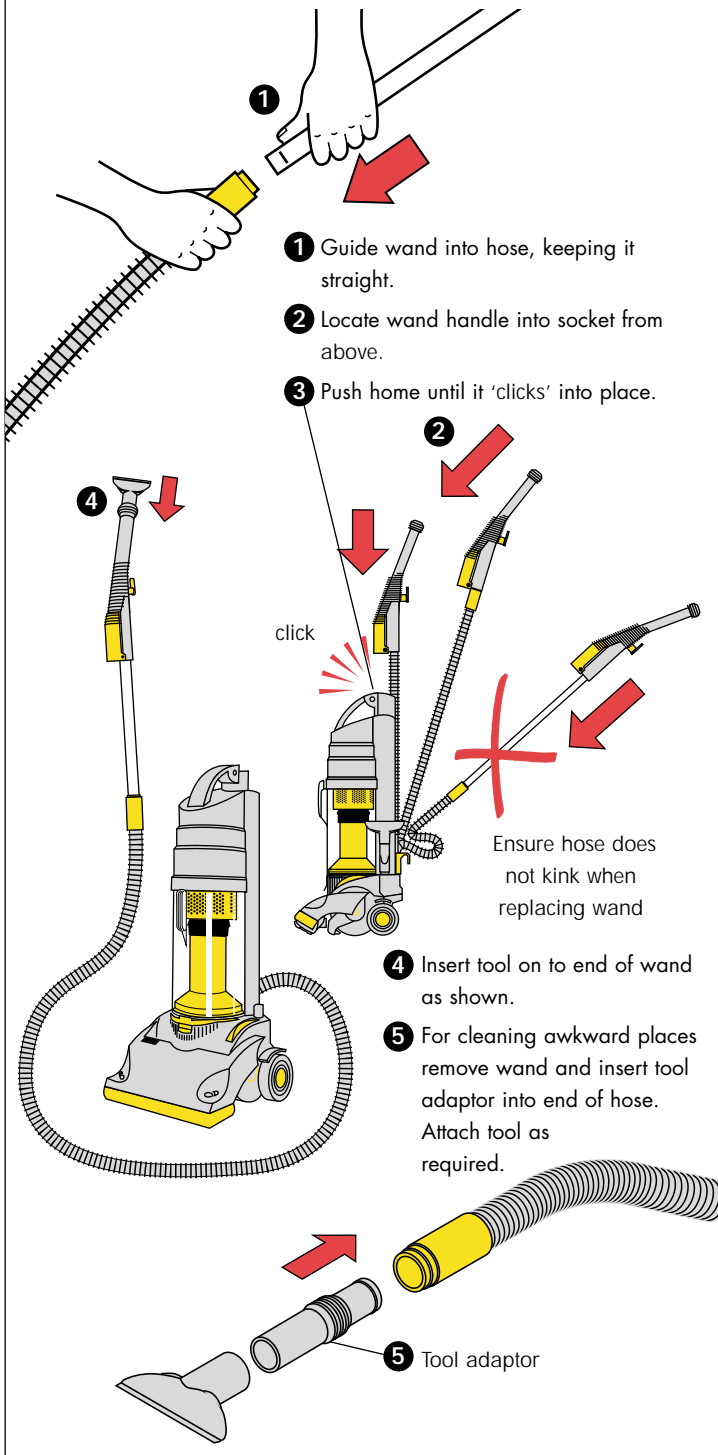

## On/Off switch

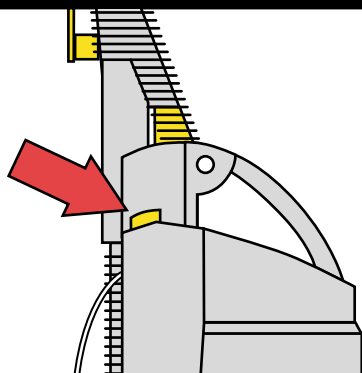

PLEASE READ ALL INSTRUCTIONS CAREFULLY BEFORE USING YOUR DYSON VACUUM CLEANER.

## Accessory tool location

All tools are stored neatly on the tool storage posts.

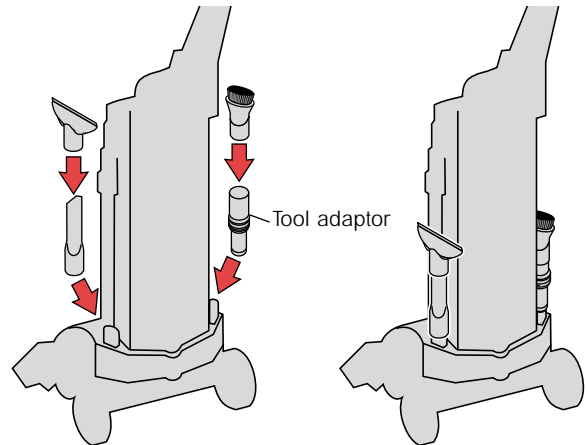

## Cord storage

Wrap cord around both cable winders.

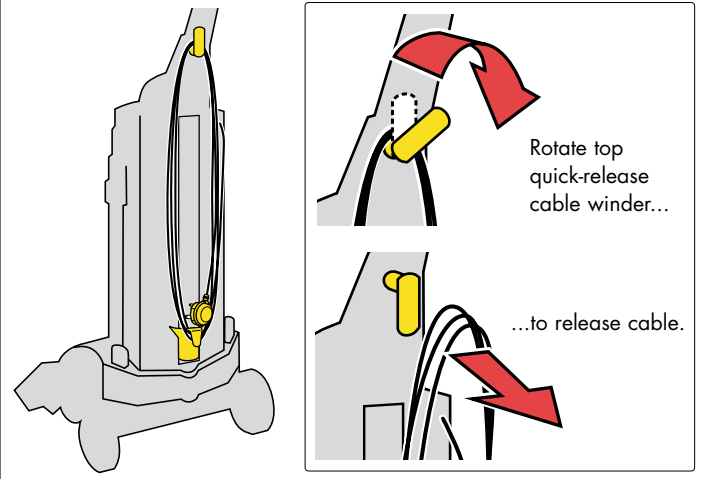

## Cleaner head adjustment

Hold the cleaner head down with foot and tilt machine back.

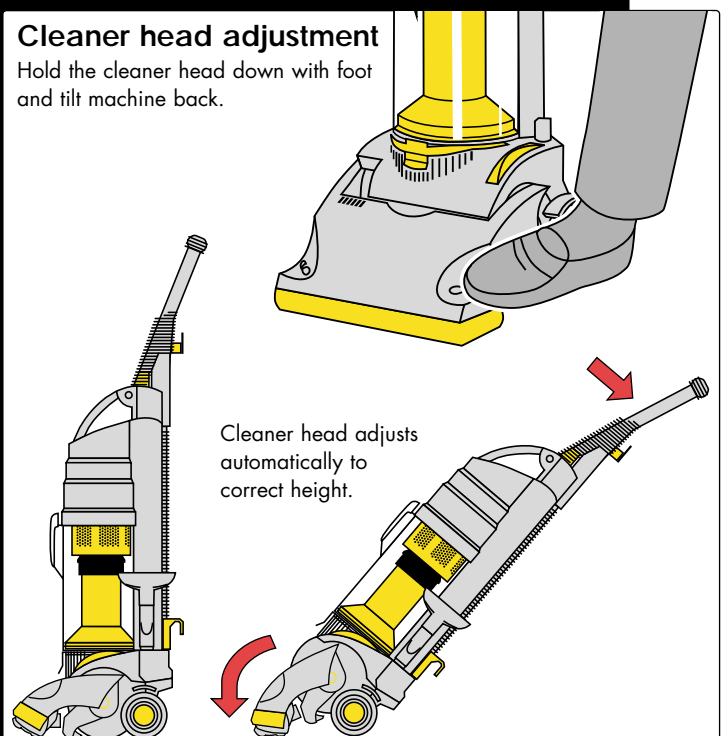

## 2. How to use



**WARNING!** For your own safety please remember to unplug the machine when not in use and before carrying out maintenance.

### Clear bin capacity

Do not fill above this line.

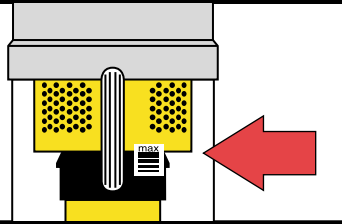

### Carrying handle

Ensure clear bin is firmly in place before lifting.

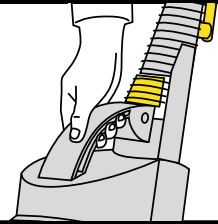

### Clear bin removal & emptying

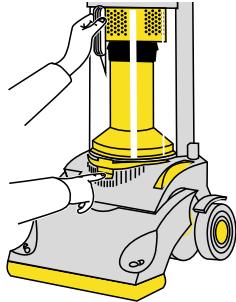

- 1 Press yellow bin catch to release bin.

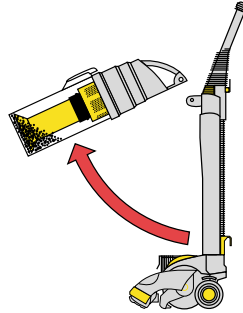

- 2 Remove clear bin and cyclone top from machine by lifting up until it releases.

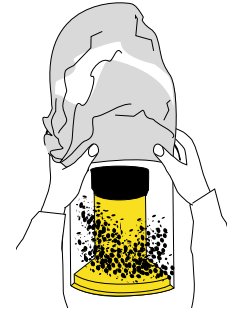

- 3 Remove clear bin from cyclone top and wrap a plastic bag around the rim of the clear bin.

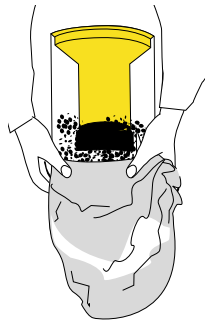

- 4 Invert clear bin and wait at least 10 seconds before releasing.

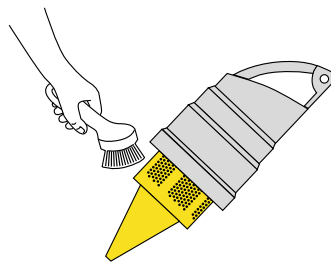

- 5 Wipe shroud holes free of all dust and debris.

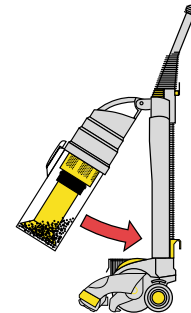

- 6 Replace clear bin and cyclone top ensuring that they 'click' into upright position.

### Filter changing

- 1 Lift out pre-filter. Unhinge filter cage and replace old S-level submicro filter at least every three months.
- 2 Lift yellow bin catch for access to second S-level submicro filter. Also replace at least every three months.

Also see back page.

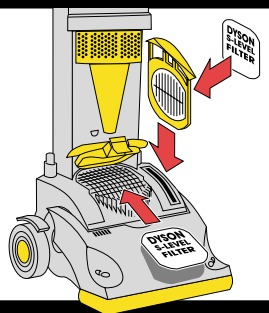

### Optional clear bin cleaning



Remove clear bin from machine to wash in water if desired. After washing ensure that the yellow bin inner is in place (See step 7 of 'Blockage procedure' in your instructions).

Do not use strong detergents and ensure clear bin is fully dry before replacing on machine

## DANGER!

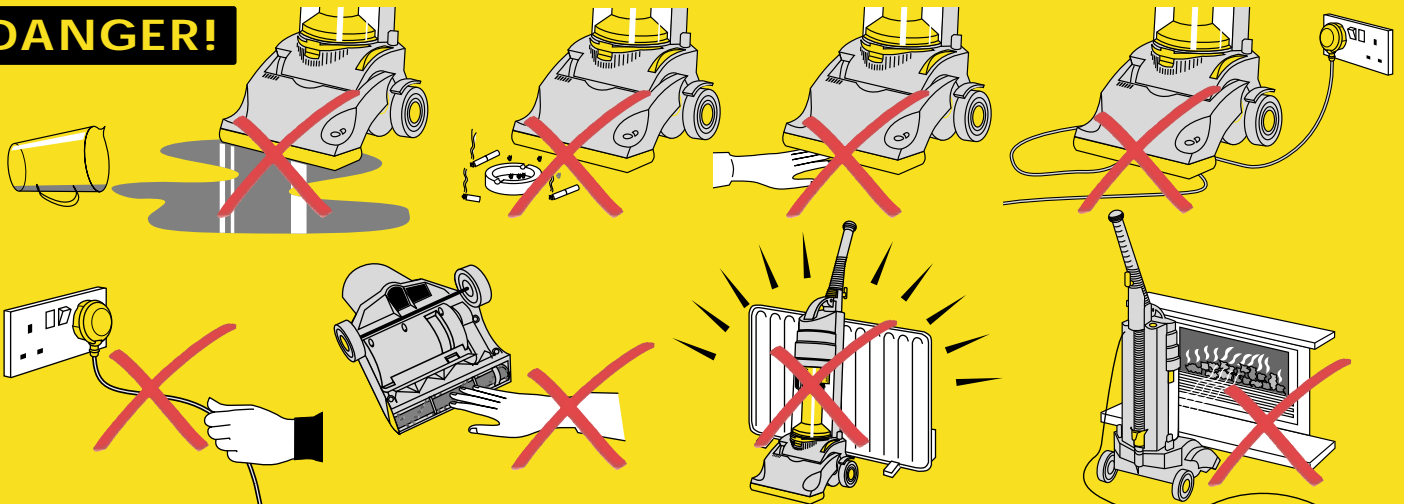

# 3. Changing the belt

Replacement belts are available direct from Dyson Customer Care (Tel: 1800 239 766)



**WARNING!** For your own safety please remember to unplug the machine when not in use and before carrying out maintenance.

## 1. Remove soleplate

- 1 Undo three cross-head screws.
- 2 Remove soleplate by lifting from the back, and then remove brush bar.

**IMPORTANT** Use only genuine Dyson belts.

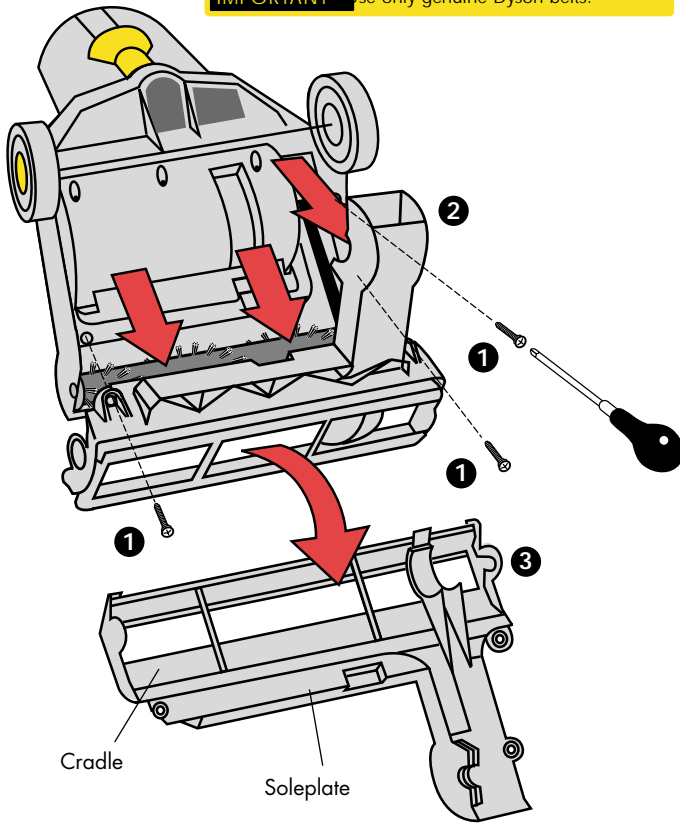

- 3 If cradle becomes detached from soleplate, align circular ends of cradle with corresponding holes of soleplate and slot into place, ensuring that 'front' edge of cradle faces the right direction.

## 2. Line up brush bar

- 1 Fit belt over motor shaft and domed section of brush bar.
- 2 Pull belt taut and locate brush bar in slot.

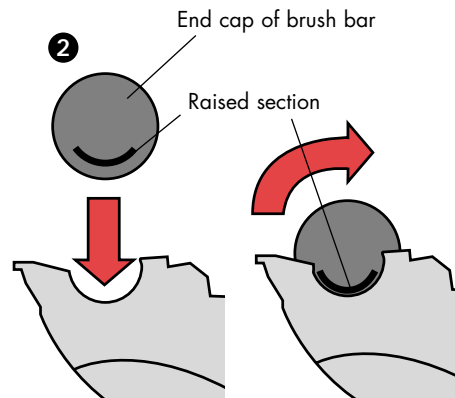
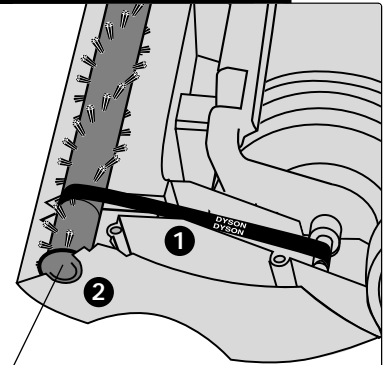

With raised section on end of brush bar orientated as shown, locate brush bar in slot and rotate end cap towards back of machine until it comes to a stop.

## 3. Centralise belt

**VERY IMPORTANT**  
Rotate brush bar by hand to centralise belt before re-fitting soleplate to machine.

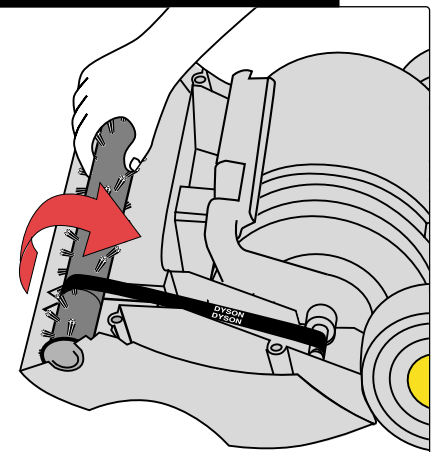

## Thread removal

After unplugging the cleaner, carefully remove any entwined cotton, wool or fluff with scissors.

NOTE: Failure to remove these may result in loss of performance and possible damage to the machine.

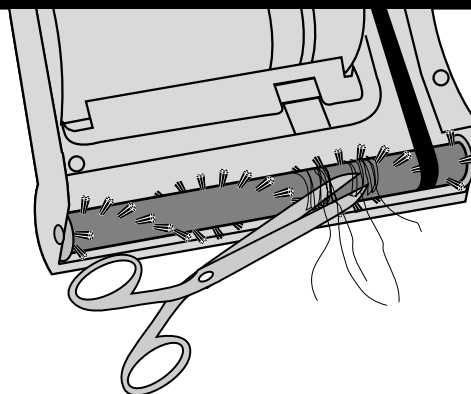

**dyson**

**Helpline 1800 239 766**  
**Facsimile (02) 9526 7122**  
**Contact for all service assistance**

DYSON CUSTOMER CARE  
PO BOX 2175  
TAREN POINT  
NSW 2229  
AUSTRALIA

# 4. Blockage procedure



**WARNING!** For your own safety please remember to unplug the machine when not in use and before carrying out maintenance.

**IMPORTANT** Please check your DCO1 for blockages if you notice that the vacuum cleaner stops picking up, the sound of the vacuum cleaner changes pitch, or the suction reduces or stops altogether. Any 'Blockage only' repairs will incur a charge of \$60.00\*, so please check your machine carefully.

\*Price correct at time of printing.

## 1. Check filters

Filter life is dependent on the amount the vacuum cleaner is used but they must be replaced at least **every 3 months**.

Replace both submicro filters with DYSON part number DUP 03-33-002.

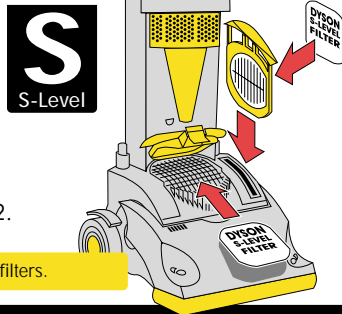

**IMPORTANT** Use only genuine Dyson filters.

## 2. Clean shroud

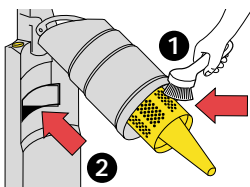

- 1 Wipe shroud holes free of all dust/debris.
- 2 Check air duct behind bin for debris.

## 3. Check wand/hose

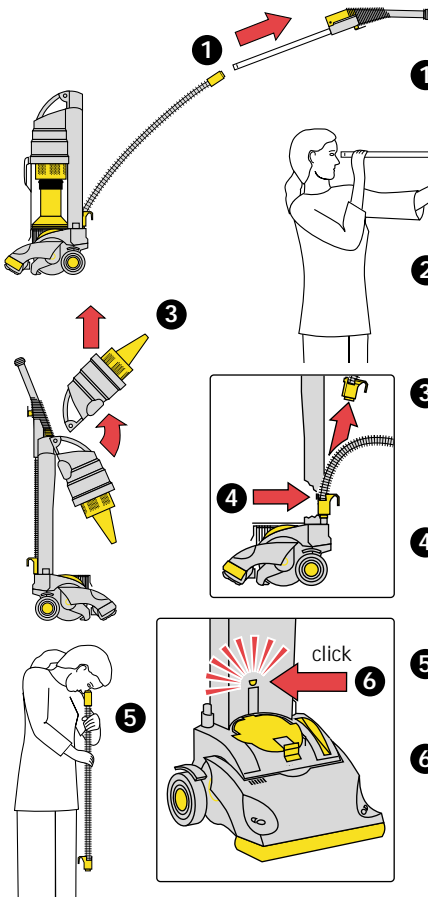

- 1 Remove wand handle from machine.
- 2 Look down wand and check for daylight. Remove any blockage with a stiff wire.
- 3 Remove clear bin and cyclone top, by lifting up until it releases. Then gently pull off from ball socket.
- 4 Remove hose from machine by pressing yellow button behind bin cavity.
- 5 Check for any blockages in hose and remove.
- 6 When returning hose, ensure the yellow button 'clicks' into place. (A tool may be required to ease re-assembly).

## 4. Check belt & soleplate

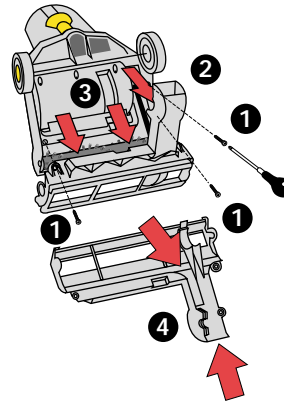

- 1 Remove three screws to undo soleplate.
- 2 Lift soleplate to remove.
- 3 Check condition of belt and replace if necessary. (See 'Changing the belt' section in your instructions).
- 4 Check that soleplate passage is clear and remove blockages if necessary.

## 5. Check cleaner head & flaps

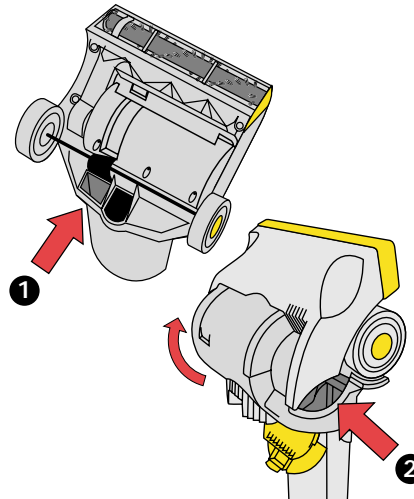

Turn machine upside down. Remove soleplate. Raise inspection flap 1 and look down through aperture. If you cannot see daylight, remove any blockage with a stiff wire.

Rotate cleaner head so that opening 2 becomes exposed, keeping inspection flap raised.

Look through 2 to see if light is visible and to check that the passage is clear of any blockages.

## 6. Check yellow bin inner

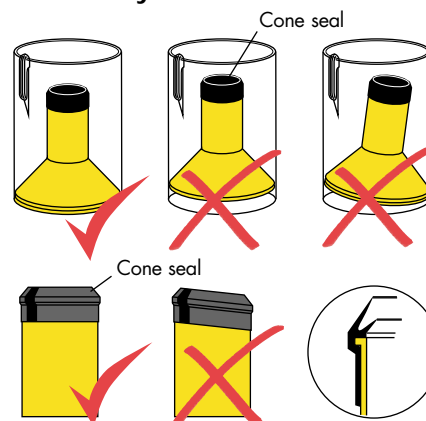

Check that yellow bin inner is in place, especially if you have washed it. (See 'How to use' section in your instructions).

Do not remove cone seal. Check cone seal is in place: failure to do so could result in clogging of the pre-filter and damage to the motor.

The lip of the cone seal should sit over the rim of the yellow bin inner.

If you are still unable to get 'suction', call Dyson Customer Care on 1800 239 766.

DYSON CUSTOMER CARE  
BO BOX 2175  
TAREN POINT  
NSW 2229  
AUSTRALIA



# Important

S  
S-Level

Please note that if the filters are not checked regularly and changed as required, the motor may overheat, which will cause the thermal cut-out to operate.

**NOTE:** Vacuuming builder's dust and some carpet fresheners may cause the filters to require changing more frequently. (Dyson does not recommend the use of carpet fresheners).

Replacement filters are available from your local retailer or direct from Dyson. Call or fax the Helpline for orders.

**IMPORTANT:** Use only genuine Dyson filters, which have been tested and approved for this cleaner.

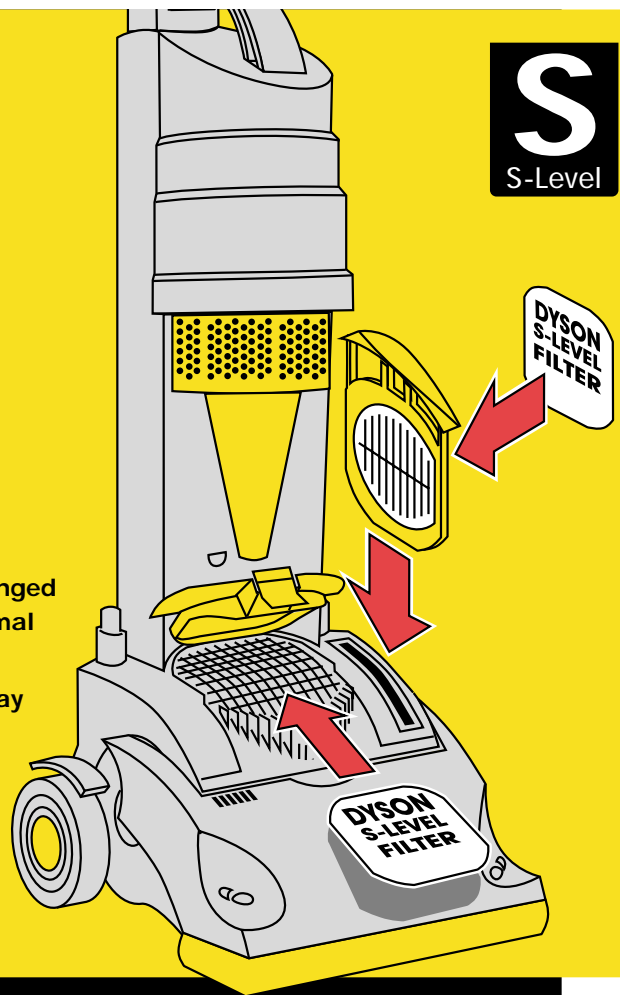

## NOTE

Your Dyson has a built-in thermal cut-out to protect it in the event of a restriction to the airflow and may suddenly stop working temporarily if you do not change the filters at the stated time, or if blockages are not cleared immediately.

If the vacuum cleaner suddenly stops working (ie. the motor makes no sound when switched on) then please check your cleaner for blockages as

detailed in this operating manual. (Remember also to check the fuse in the plug). Having established that there are no blockages and that the filters have been replaced within the stated time, leave your vacuum cleaner unplugged for 60 minutes and then try using it again.

**If the vacuum cleaner still does not work, please call Dyson Customer Care (Tel: 1800 239 766).**

**IMPORTANT ALWAYS UNPLUG THE VACUUM CLEANER FROM THE WALL SOCKET BEFORE INSPECTING IT**

## NOTE

Check that your supply corresponds to that shown on the rating plate. The appliance must only be used as rated, it should be fitted with an ASTA approved fuse to BS1362.

For your convenience this appliance is supplied with a plug which is fitted with a 13amp fuse of the appropriate rating.

**Never** put the plug into the socket outlet without the fuse cover fitted. Replacement fuse covers are available from Dyson Customer Care. If the plug supplied is not suitable for your socket outlet, it should be cut off and destroyed/safely disposed of. **Warning: Under no circumstances should the severed plug be inserted into a 13A socket, serious danger of electric shock would result from the exposed wires.**

The mains lead can then be shortened to the minimum required length, suitably prepared and the correct style of plug to suit your household wiring system should be fitted. The following wiring instructions should be followed. **If in doubt, consult a qualified electrician.**

**Unwanted products and the environment** Should you find that your product needs replacing one day, or is of no further use to you, think of protecting the environment. Dyson will accept your old products and recycle them in an environmentally friendly way.

## IMPORTANT

The wires in the mains lead are coloured in accordance with the following codes.

**Brown – Live**

**Blue – Neutral**

As the colours of the wires in the mains lead may not correspond with the colours or markings identifying the terminals in your plug, proceed as follows:

The wire which is coloured **Blue** must be connected to the terminal which is marked with the letter **N** or coloured **Black**.

The wire that is coloured **Brown** must be connected to the terminal which is marked with the letter **L** or coloured **Red**.

Neither wire should be connected to the earth terminal of a three pin plug which is marked with the letter **E** or  $\perp$  or coloured **Green** or **Green and Yellow**.

Always ensure that the cable clamp is fitted and that it clamps the cable outer and **NOT** the coloured wires.

If the supply cord of the appliance is damaged, disconnect the appliance from the socket outlet immediately. The supply cord must be replaced and only by Dyson Appliances Ltd. or their appointed agent as special purpose tools and service techniques are required.

dyson

Helpline 1800 239 766  
Facsimile (02) 9526 7122  
Contact for all service assistance

DYSON CUSTOMER CARE  
PO BOX 2175  
TAREN POINT  
NSW 2229  
AUSTRALIA

## Free Manuals Download Website

<http://myh66.com>

<http://usermanuals.us>

<http://www.somanuals.com>

<http://www.4manuals.cc>

<http://www.manual-lib.com>

<http://www.404manual.com>

<http://www.luxmanual.com>

<http://aubethermostatmanual.com>

Golf course search by state

<http://golfingnear.com>

Email search by domain

<http://emailbydomain.com>

Auto manuals search

<http://auto.somanuals.com>

TV manuals search

<http://tv.somanuals.com>