

DC23 MOTORHEAD

ASSEMBLY

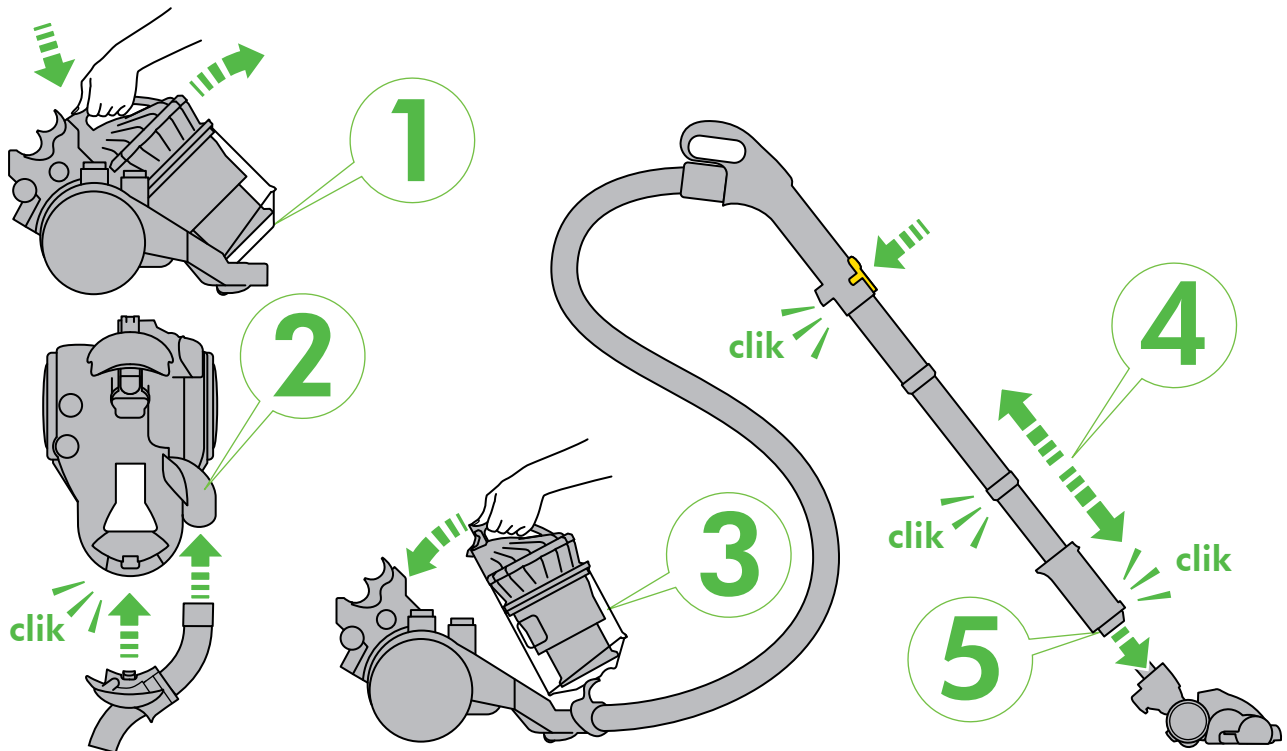



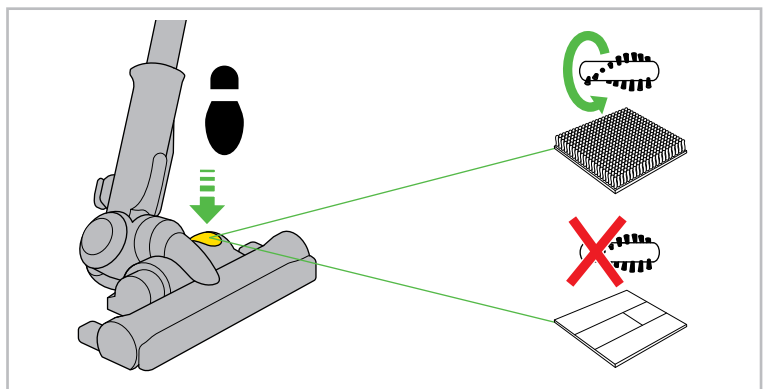

 **3** months

WASH FILTER

Wash filter with cold water at least every 3 months.

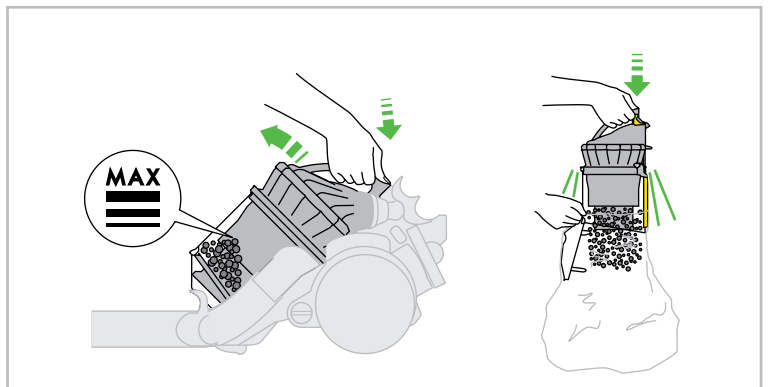

**REGISTER
YOUR 2 YEAR
GUARANTEE
TODAY**



Your Dyson vacuum cleaner will be covered for parts and labour for 2 years from the date of purchase, subject to the terms of the guarantee.

If you have a query about your Dyson vacuum cleaner, call the Dyson Customer Care Helpline quoting the serial number and details of where/when you bought the vacuum cleaner. The serial number can be found on your rating plate which is behind the clear bin.

Most queries can be solved over the phone by one of our trained Dyson Customer Care Helpline staff.

Note your serial number for future reference

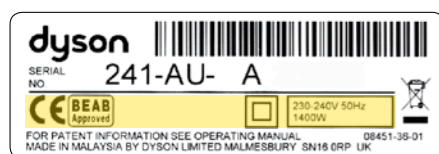

This illustration is for example purposes only.

IMPORTANT SAFETY PRECAUTIONS

READ ALL INSTRUCTIONS BEFORE USING THIS VACUUM CLEANER

When using an electrical appliance, basic precautions should always be followed, including the following:

⚠ WARNING

TO REDUCE THE RISK OF FIRE, ELECTRIC SHOCK, OR INJURY:

1. This vacuum cleaner is for domestic use only. Do not use outdoors or on wet surfaces.
2. Do not handle plug or vacuum cleaner with wet hands.
3. CAUTION: This vacuum cleaner's hose contains electrical connections: Do not use to suck up water or other liquids. Do not immerse in water for cleaning. The hose should be checked regularly and must not be used if damaged.
4. Do not allow the vacuum cleaner to be used as a toy. Close attention is necessary when used by or near children.
5. Do not use with damaged cable or plug. If the supply cable is damaged, it must be replaced by Dyson's authorised service centres in order to avoid a hazard.
6. If the vacuum cleaner is not functioning properly, has been dropped, damaged, left outdoors, or immersed in liquid, do not use, contact the Dyson Customer Care Helpline.
7. Do not use the vacuum cleaner if any parts appear to be faulty, missing or damaged.
8. Ensure all parts including the clear bin are securely attached before using or carrying the vacuum cleaner.
9. This vacuum cleaner is not intended for use by persons (including children) with reduced physical, sensory or mental capabilities, or lack of experience and knowledge, unless they have been given supervision or instruction concerning use of the vacuum cleaner by a person responsible for their safety. Children should be supervised to ensure that they do not play with the vacuum cleaner.
10. Do not leave the vacuum cleaner when plugged in. Unplug from outlet when not in use, and before performing user maintenance, connecting or disconnecting the hose or changing accessories.
11. Store the vacuum cleaner indoors. Do not use or store this vacuum cleaner below 0°C (32°F). Ensure that the vacuum cleaner is at room temperature before operating. Put the vacuum cleaner away after use with the cable stored safely, to prevent tripping hazards.
12. If the vacuum cleaner overheats it will cut-out. It must be switched off, unplugged and allowed to cool down before attempting to check filters or for blockages. Ensure any blockage is cleared before restarting the vacuum cleaner.
13. Turn off all controls before unplugging.
14. Do not unplug by pulling on cable. To unplug, grasp the plug, not the cable.
15. Do not pull or carry by cable, use cable as a handle, close a door on cable, or pull cable around sharp edges or corners. Do not run vacuum cleaner over cable. Keep cable away from heated surfaces.
16. The use of an extension cable is not recommended.
17. Keep hair, loose clothing, fingers, and all parts of body away from openings and moving parts, such as the brush bar.
18. Do not put any object into openings. Do not use with any opening blocked; keep free of dust, lint, hair, and anything that may reduce air flow. Switch off and unplug the vacuum cleaner before attempting to remove any blockage.
19. Take extra care when vacuuming on stairs. Do not work with the vacuum cleaner above you on the stairs.
20. Keep the vacuum cleaner on the floor. Do not put the vacuum cleaner on chairs, tables etc.
21. Do not shake the vacuum cleaner or press the cyclone release button while carrying the vacuum cleaner, or it could fall and cause injury.
22. Do not use to pick up flammable or combustible liquids, such as petrol, or use in areas where they may be present.
23. Do not pick up anything that is burning or smoking, such as cigarettes, matches, or hot ashes.
24. Check to ensure your electricity supply matches that shown on the rating plate. The vacuum cleaner must only be used as rated.
25. Use only as described in this manual. Use only Dyson recommended attachments.
26. Do not use without the clear bin and filters in place.
27. Do not lubricate any parts, or carry out any maintenance or repair work other than that shown in this manual, or as advised by the Dyson Customer Care Helpline.

3 EASY WAYS TO REGISTER YOUR 2 YEAR GUARANTEE

REGISTER ONLINE
Visit our website to register your full parts and labour guarantee online (Australia only).
www.dyson.com.au/register

REGISTER BY PHONE
Call our dedicated Helpline.
AU 1800 239 766
NZ 0800 397 667

REGISTER BY MAIL
Complete and return the form to Dyson in the envelope supplied.

SAVE THESE INSTRUCTIONS

THIS VACUUM CLEANER IS INTENDED FOR HOUSEHOLD USE ONLY



Do not pull on the cable.



Do not store near heat sources.



Do not use near naked flame.



Do not run over the cable.



Do not pick up water or liquids.



Do not pick up burning objects.



Do not use above you on the stairs.



Do not put hands near the brush bar when the vacuum cleaner is in use.

Power and cable

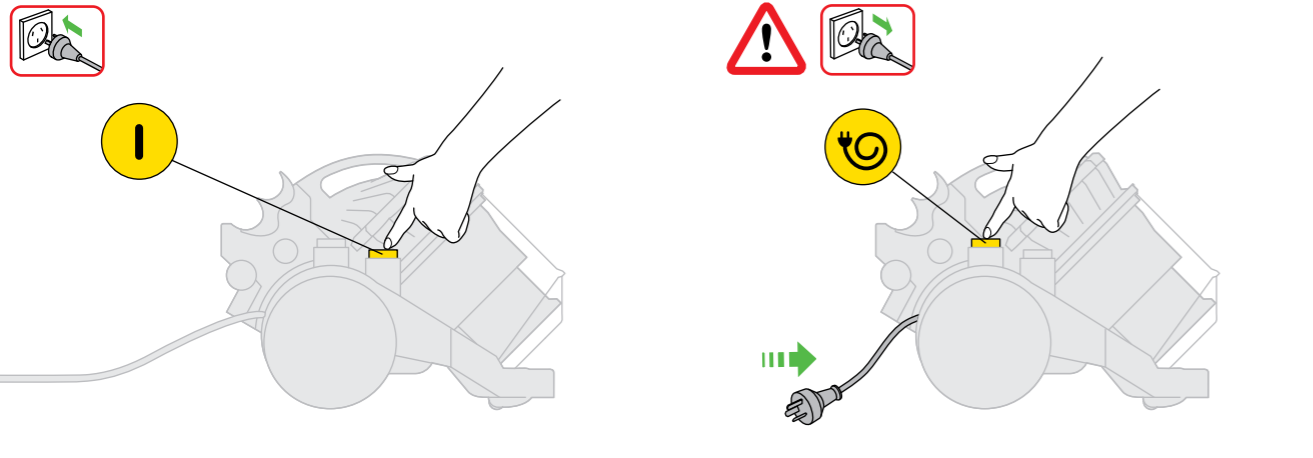

Storage

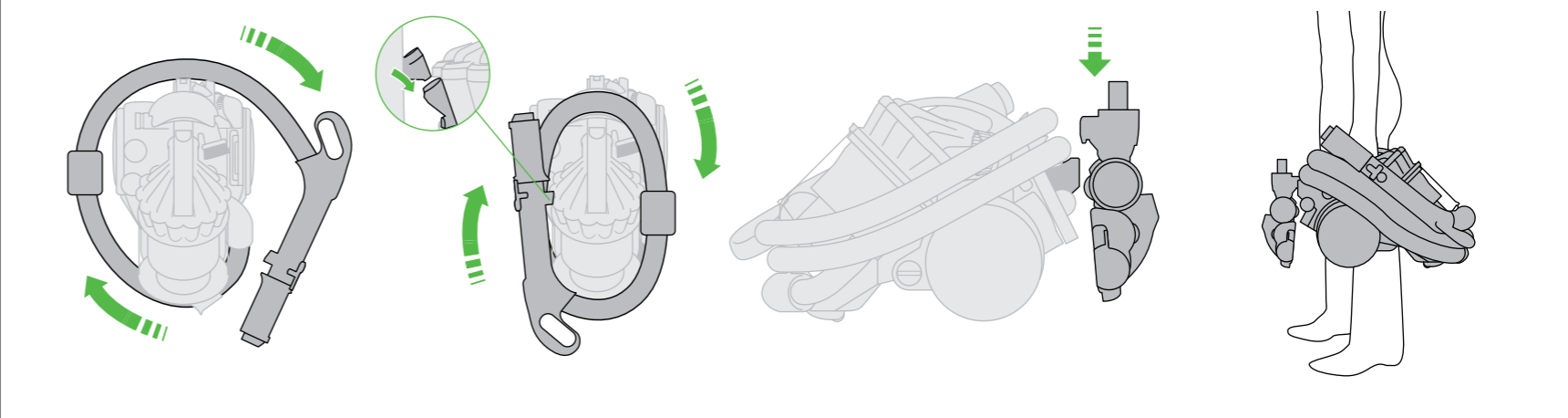

Emptying the clear bin

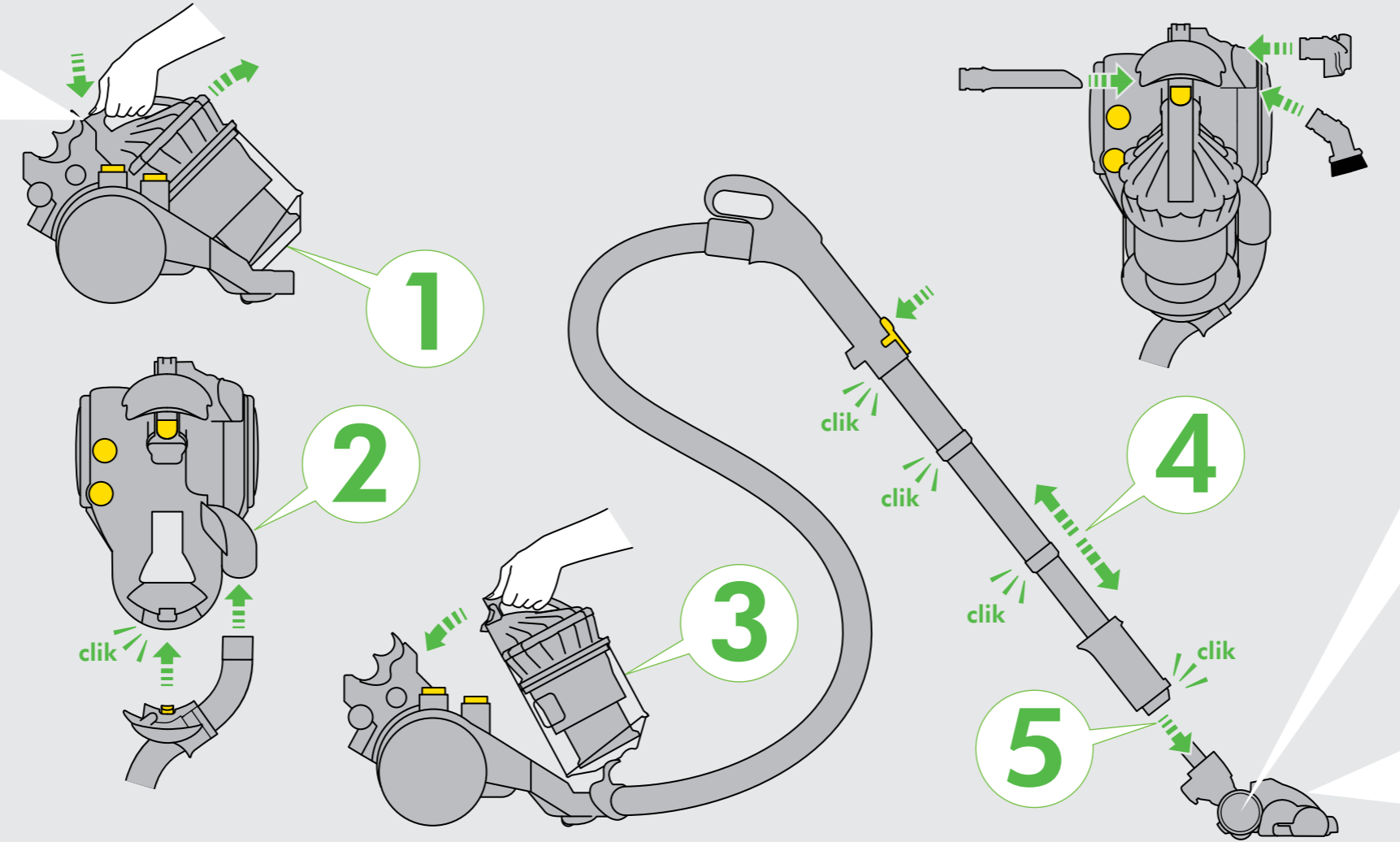
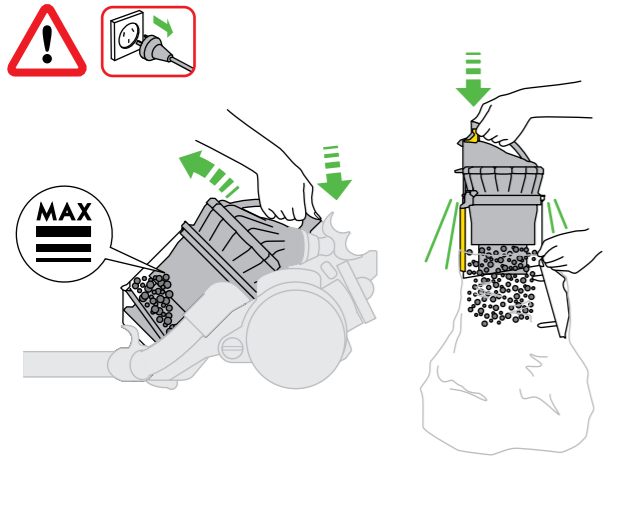

Motorised head

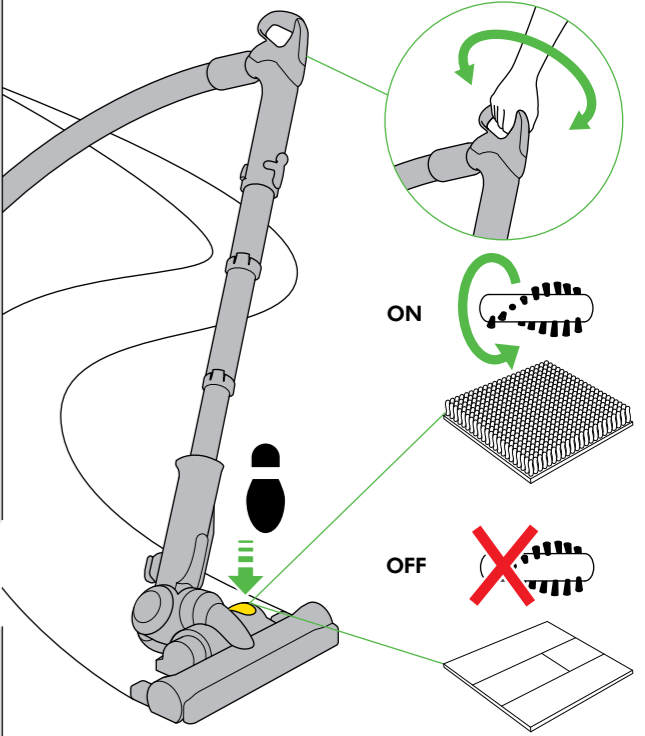

Tools

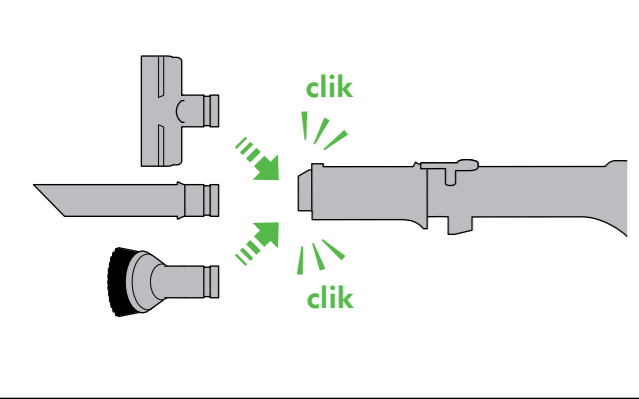

Clearing brush bar obstructions

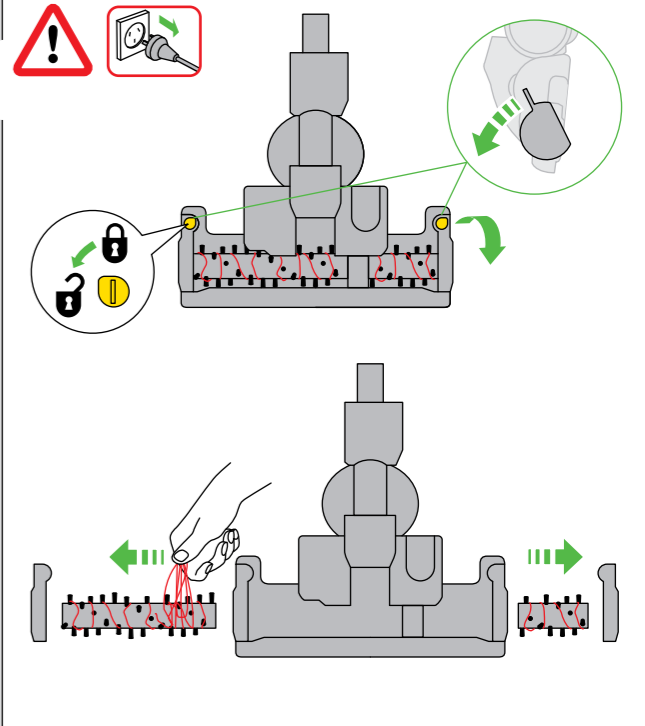

Cleaning the clear bin

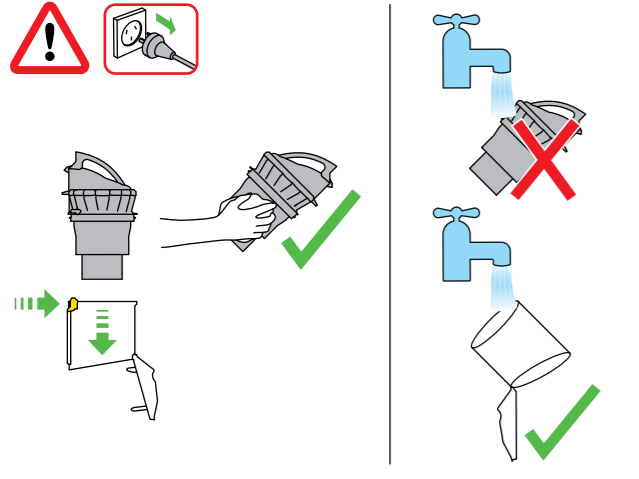

Looking for blockages

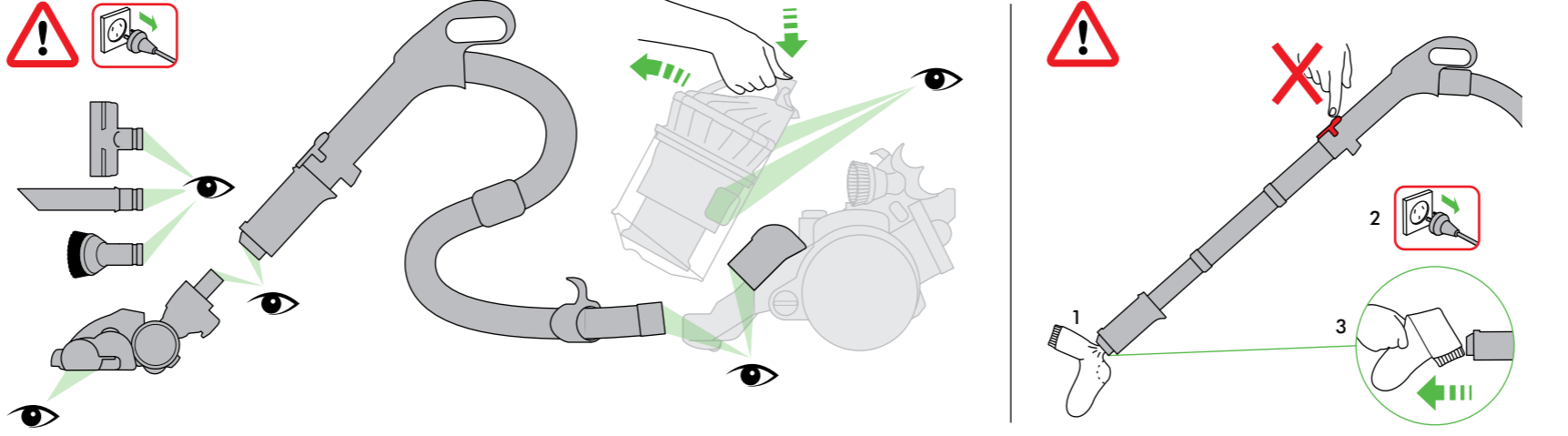

IMPORTANT!

WASH FILTER



Wash filter with cold water at least every 3 months.

Register for a filter wash reminder by email (Australia only);
customer@dyson.com.au

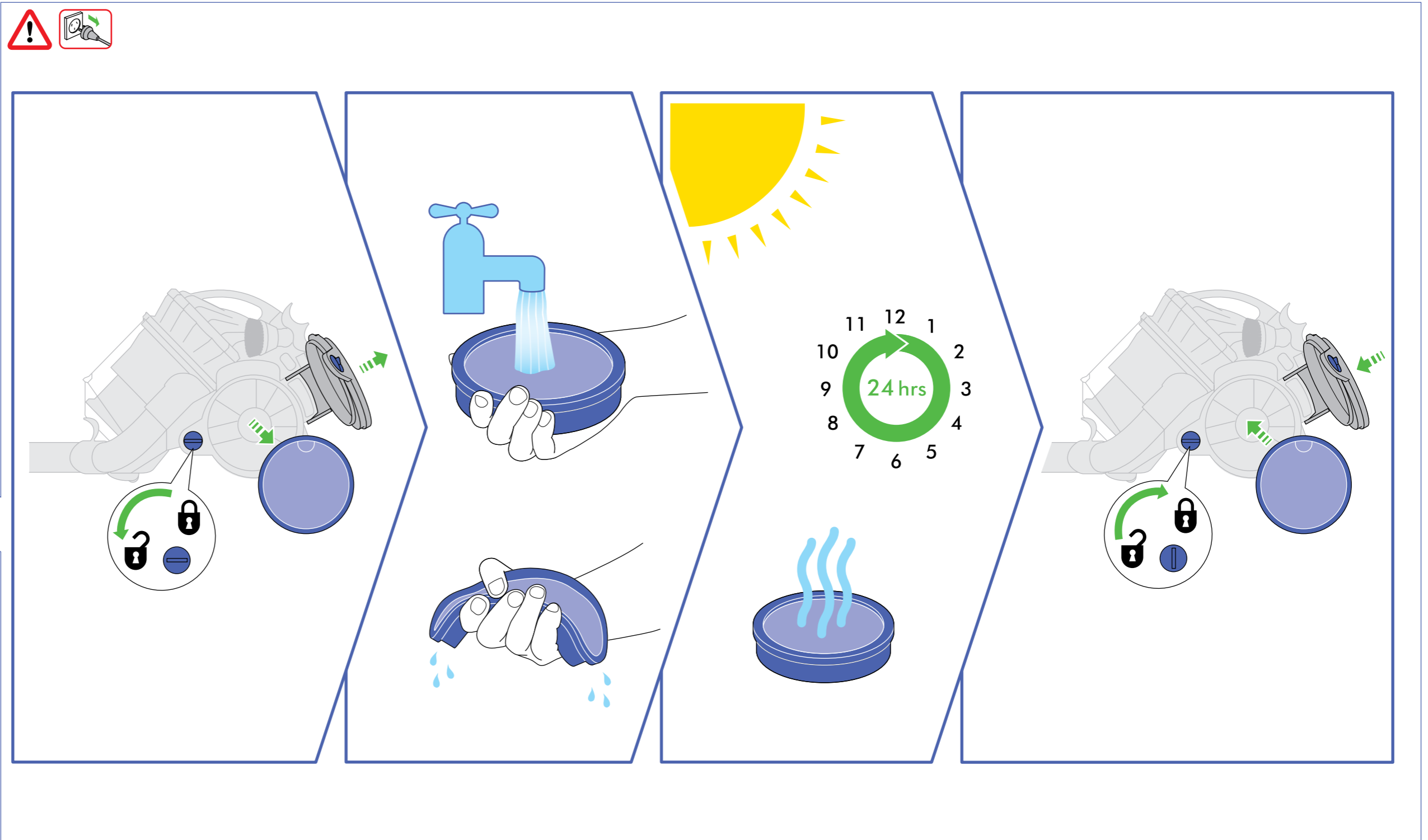

USING YOUR DYSON VACUUM CLEANER



CAUTION:

- This vacuum cleaner's hose contains electrical connections: Do not use to suck up water or other liquids. Do not immerse in water for cleaning. The hose should be checked regularly and must not be used if damaged.

PLEASE NOTE:

- Always extend the cable fully to the red tape before use.
- Fine dust such as plaster or flour should only be vacuumed in very small amounts.
- Do not use the vacuum cleaner to pick up sharp hard objects, such as small toys, pins, paper clips etc.
- Consult your flooring manufacturer's recommended instructions before vacuuming and caring for your flooring, rugs and carpets. Some carpets will fuzz if a rotating brush bar is used when vacuuming. If this happens, we recommend vacuuming in hard floors mode and consulting with your flooring manufacturer.
- If used in a garage, care should be taken to wipe the soleplate and wheels with a dry cloth after vacuuming to clean off any sand, dirt, or pebbles which could damage delicate floors.
- When vacuuming, certain carpets may generate small static charges in the clear bin. These are entirely harmless and not associated with the main supply. To minimise any effect from this, do not put your hand or insert any object into the clear bin unless you have emptied it and rinsed it out with cold water.
- Only use parts recommended by Dyson; failure to do so could invalidate your guarantee.

EMPTYING THE CLEAR BIN



CAUTION:

- Switch OFF and unplug the vacuum cleaner before emptying the clear bin.
- Empty as soon as the dirt reaches the level of the MAX mark – do not overfill. To remove the clear bin from the vacuum cleaner press the button at the rear of the carrying handle. To release the dirt, press the button on the front of the clear bin.

PLEASE NOTE:

- Do not use the vacuum cleaner without the clear bin in place.
- To minimise dust/allergen contact when emptying, encase the clear bin tightly in a plastic bag and empty. Remove the clear bin carefully and seal bag tightly, dispose as normal.

CLEANING THE CLEAR BIN



CAUTION:

- Do not immerse the whole cyclone in water or pour water into the cyclones.
- Ensure the clear bin is completely dry before replacing.
- Clean the shroud with a cloth or dry brush to remove lint and dust.

PLEASE NOTE:

- Do not use detergents, polishes or air fresheners to clean the clear bin.
- Do not put the clear bin in a dishwasher.

WASHING YOUR FILTER



CAUTION:

- Switch OFF and unplug the vacuum cleaner before removing the filter.
- Ensure filter is completely dry before refitting into the vacuum cleaner.

PLEASE NOTE:

- It is important to check your filter regularly and wash at least every 3 months according to instructions, to maintain performance.
- Please leave to dry completely for 24 hours.
- The filter may require more frequent washing if vacuuming fine dust.
- Do not use detergents to clean the filter.
- Do not put the filter in a dishwasher, washing machine, tumble dryer, oven, microwave or near an open flame.
- Register to require a filter wash reminder by email (Australia only); customercare@dyson.com.au

LOOKING FOR BLOCKAGES



CAUTION:

- Switch OFF and unplug the vacuum cleaner before checking for blockages.
- Beware of sharp objects when clearing blockages.
- Refit all parts of the vacuum cleaner securely before using.

PLEASE NOTE:

- Clearing blockages is not covered by your vacuum cleaner's limited guarantee. If any part of your vacuum cleaner becomes blocked, it may overheat and then automatically shut off. Unplug the vacuum cleaner and leave to cool down. Clear blockage before restarting.
- Large items may block the tools or wand inlet, if this happens switch the vacuum cleaner off and remove the plug before removing the blockage. Do not operate the wand release catch.

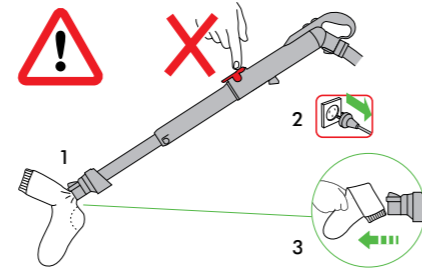

CLEARING BRUSH BAR OBSTRUCTIONS



CAUTION:

- Switch 'OFF' and unplug the vacuum cleaner before clearing brush bar obstructions.
- If your brush bar is obstructed, it may shut off. If this happens you will need to remove the brush bar as shown and clear any obstructing debris.

2 YEAR DYSON GUARANTEE TERMS AND CONDITIONS

- Terms and conditions of the complimentary Dyson 2 year guarantee
- The guarantee becomes effective from the date of purchase.
- The guarantee is only valid when purchase is made from an authorised retailer.
- All work will be carried out by Dyson Appliances (Aust) Pty Ltd, Avery Robinson Ltd (New Zealand).
- Any parts replaced will become the property of Dyson Appliances (Aust) Pty Ltd.
- The repair or replacement of your vacuum cleaner under guarantee will not extend the period of guarantee.
- The guarantee provides benefits which are additional to and do not affect your statutory rights as a consumer.
- You must provide proof of purchase before any work can be carried out on your vacuum cleaner. Without this proof, any work carried out will be chargeable. Please keep your receipt.

WHAT IS COVERED

- The repair or replacement of your vacuum cleaner if your vacuum cleaner is found to be defective due to faulty materials, workmanship or function within 2 years of purchase (if any part is no longer available or out of manufacture, Dyson will replace it with a functional replacement part).

WHAT IS NOT COVERED

Dyson shall not be liable for costs of repair or replacement of a product incurred as a result of:

- Normal wear and tear (e.g fuse, belt, brush bar).
- Industrial use of the vacuum cleaner such as vacuuming gyprock dust or builders dust may void your guarantee.
- Accidental damage, faults caused by negligent use or care, neglect, careless operation or handling of the vacuum cleaner which is not in accordance with the Dyson Operating Manual.
- Blockages – please refer to the Dyson Operating Manual for details on how to unblock your vacuum cleaner.
- Use of the vacuum cleaner for anything other than normal domestic purposes in the country of purchase.
- Use of parts not assembled or installed in accordance with the instructions of Dyson.
- Use of parts and accessories other than those produced or recommended by Dyson.
- External sources such as transit damage or weather.
- Repairs or alterations carried out by parties other than Dyson or its authorised agents.

If you are in any doubt as to what is covered by your guarantee, please call the Dyson Customer Care Helpline on:

Australia 1800 239 766
New Zealand 0800 397 667

Remember: Always disconnect plug from mains before inspecting for problems.

- If your vacuum cleaner will not operate, first check: mains socket has electricity supply – the plug is properly inserted into the socket.
 - Sucking up certain items such as stockings, clippings of cloth, sizeable pieces of paper etc may block the hose or ducts. Should a blockage occur, first disconnect the vacuum cleaner from the electricity supply and refer to the 'blockage' section in the Dyson Operating Manual.
 - Never pick up hot cinders or lighted cigarette ends.
 - Do not attempt to pick-up water with your Dyson vacuum cleaner. It has not been designed as a wet pick-up cleaner.
- If you are still experiencing problems with your Dyson vacuum cleaner, please call the Dyson Customer Care Helpline on:
Australia 1800 239 766
New Zealand 0800 397 667

REGISTERING YOUR GUARANTEE

To help us ensure you receive prompt and efficient service, please register as a Dyson owner. There are three ways to do this:

- Online at (Australia only) customercare@dyson.com.au
 - By calling the Dyson Customer Care Helpline.
 - By completing and returning the enclosed form to us by mail.
- This will confirm ownership of your Dyson vacuum cleaner in the event of an insurance loss, and enable us to contact you if necessary.

DYSON CUSTOMER CARE

If you have a query about your Dyson vacuum cleaner call the Dyson Customer Care Helpline quoting the serial number, or contact us via the Dyson website. The serial number can be found behind the clear bin.

Most queries can be solved over the phone by one of our Dyson Customer Care Helpline staff.

If your Dyson vacuum cleaner needs a service, call the Dyson Customer Care Helpline so we can discuss the available options.

If your vacuum cleaner is under guarantee and the repair is covered, it will be repaired at no cost.

DYSON CUSTOMER CARE DETAILS

Any queries – just call the Dyson Customer Care Helpline

AU: 1800 239 766 (Mon-Fri 8:00am to 6:00pm EST,
Sat-Sun 8:30am to 4:00pm EST) www.dyson.com.au
NZ: 0800 397 667 (Mon-Fri 8:30am to 5:00pm) www.dyson.co.nz

ABOUT YOUR PRIVACY

Dyson may use this information for future marketing and research purposes (including sending commercial electronic messages) and may disclose it to third parties for the purposes of providing the services you have requested or to our business partners or professional advisers. If you wish to access your personal information or see our full privacy policy, please contact us at customercare@dyson.com.au

CONFORMITY INFORMATION

A sample of this product has been tested and found to be in conformity with the following European Directive: 2006/95/EC Low voltage Directive, 93/68/EEC CE Marking Directive, 2004/108/EC EMC Directive.

PRODUCT INFORMATION

Product weight 10.86kg.

Please note: Small details may vary from those shown.

This product is protected by the following intellectual property rights:

PATENT/PATENT APPLICATION NUMBERS

CA 2,439,032; AU 2002-229966; EP 1361812; JP 2004-537336;
US 2004/0128789; GB 2407784; WO 2005/053855; AU 2002226556;
CA 2,439,250; EP 1370172; JP 2004-528876; US 2004-0074213;
AU 2002225207; CA 2,438,069; EP 1361814; JP 2004-520137;
US 2004-0112022; AU 2001240894; EP 1268076; JP 2003-528704;
US 6,835,222; AU 2002-225232; CA 2,438,079; EP 1361815;
JP 2004-520139; US 6,974,488; AU 637 272; EP 0636338; JP 1948 863;
US 5,078,761; GB 2413974; WO 2005/110608; AU 2003-202714;
CA 2,476,428; EP 1474242; GB 2385292; JP 2003-567583;
US 2005-010229892; GB 2407022; JP 2004-023962; AU 2003255837;
EP 1551270; GB 2392827; JP 2004-023963; US 2004-023963; GB 0510864.2;
MY PI20062350; TW 95118685; TH 0601002378; WO 2006/125944;
GB 0510863.4; MY PI20062352; TH 0601002379; TW 95118686;
WO 2006/125945; GB 0510862.6; MY PI20062351; TW 95118687;
TH 0601002380; WO 2006/125946; AU 2003252873; EP 1380247;
JP 2004-100960; US 2004-0111828; AU 2002233553; EP 1365676;
JP 2004-524097; US 2004-0078925; GB 0625806.5.

Equivalent patents, registered designs and applications exist in other countries.

IMPORTANT!

WASH FILTER



Wash filter with cold water at least every 3 months.



Dyson Customer Care

If you have a question about your Dyson vacuum cleaner, call the Dyson Customer Care Helpline with your serial number and details of where and when you bought the vacuum cleaner, or contact us via the Dyson website. The serial number can be found on the main body of the vacuum cleaner behind the clear bin.

AU Dyson Customer Care

customer@dyson.com.au
1800 239 766
Dyson Appliances (Aust) Pty Ltd.,
PO Box 2835,
Taren Point, NSW 2229,
Australia
www.dyson.com.au

NZ Dyson Customer Care

dyson@averyrobinson.co.nz
0800 397 667
Avery Robinson Ltd.,
Unit F, 151D Marua Road,
Ellerslie, Auckland, 1051
New Zealand
www.dyson.co.nz

dyson

QUESTIONNAIRE

Please take a few moments to answer our questions.
They will help us develop new products for the future.

- This vacuum cleaner is...
 - My first vacuum cleaner
 - A replacement vacuum cleaner
 - An additional vacuum cleaner
- Which brand of cleaner are you replacing or adding to?

<input type="checkbox"/> Dyson	<input type="checkbox"/> Electrolux
<input type="checkbox"/> Hoover	<input type="checkbox"/> LG
<input type="checkbox"/> Miele	<input type="checkbox"/> Panasonic
<input type="checkbox"/> Samsung	<input type="checkbox"/> Nilfisk
<input type="checkbox"/> Vax	<input type="checkbox"/> Kambrook
<input type="checkbox"/> Volta	<input type="checkbox"/> Wertheim
<input type="checkbox"/> Other, please specify	
- Why did you choose to buy a Dyson vacuum cleaner?
(Please rank in order, 1-5. 1 being the most important).
 - Dyson reputation
 - Good for pet hair pick-up
 - Performs consistently well
 - No loss of suction
 - Previous experience of Dyson
 - Good for people suffering from asthma and allergies
 - Features
 - HEPA filtration
 - Hygienic and germ free cleaning
 - Price/special offer
 - Wanted a bagless cleaner
 - Compact and easy to store
 - Store staff recommendation
 - Picks up more dust than others
 - Latest model/technology
 - Reliability/quality
 - Friend/family recommendation
 - Other
- Where did you first hear about the Dyson model you bought?
 - From friends and family
 - Saw it on the internet
 - From TV/a magazine advert
 - Saw it in a store catalogue
 - Saw it in a store
 - Recommended by salesperson
- Do you own a Dyson handheld?
 - Yes
 - No
- What is your average household income?
 - Less than \$45,000
 - Between \$45,000 – \$74,000
 - Between \$75,000 – \$100,000
 - Over \$100,000
- Do you have any household pets?

<input type="checkbox"/> Dog	<input type="checkbox"/> Cat
<input type="checkbox"/> None	<input type="checkbox"/> Other
- Does anyone in your household suffer from any of the following?

<input type="checkbox"/> Asthma	<input type="checkbox"/> Allergies
<input type="checkbox"/> None	
- To which age group do you belong?

<input type="checkbox"/> 16 – 24	<input type="checkbox"/> 25 – 34
<input type="checkbox"/> 35 – 44	<input type="checkbox"/> 45 – 54
<input type="checkbox"/> 55 – 64	<input type="checkbox"/> 65+
- Would you recommend a Dyson vacuum cleaner to your family and friends?
 - Yes
 - No
- Do you have children?

<input type="checkbox"/> Pre-school	<input type="checkbox"/> Aged 5-17 years
<input type="checkbox"/> Aged +17 years	<input type="checkbox"/> Children no longer at home
<input type="checkbox"/> Pregnant	<input type="checkbox"/> No children
- Which best describes your house?
(Tick one from each column).

<input type="checkbox"/> Own house	<input type="checkbox"/> Up to 2 beds
<input type="checkbox"/> Rented house	<input type="checkbox"/> 3-4 beds
<input type="checkbox"/> Own apartment/villa	<input type="checkbox"/> More than 4 beds
<input type="checkbox"/> Rented apartment/villa	
<input type="checkbox"/> Live with parents	
<input type="checkbox"/> Share accommodation	

THANK YOU FOR YOUR TIME



Date of purchase

/ /

Country of purchase

Australia New Zealand

Serial number

Title

Surname

First name

Address

Postcode

e-mail

Telephone

Warranty

Did you purchase an extended warranty? Yes No
 If yes, for what additional period? 1 year 2 years 3 years

Store of purchase

Privacy Act

Dyson may use this information for future marketing and research purposes (including sending commercial electronic messages) and may disclose it to third parties for the purposes of providing the services you have requested or to our business partners or professional advisers. If you wish to access your personal information or see our full privacy policy, please contact us at customer@dyson.com.au
 If you do not wish to receive marketing information by these methods from Dyson please tick this box.

3 EASY WAYS TO REGISTER YOUR 2 YEAR GUARANTEE

REGISTER ONLINE



Visit our website to register your full parts and labour guarantee online (Australia only).

www.dyson.com.au/register

REGISTER BY PHONE



Call our dedicated Helpline.

AU 1800 239 766
 NZ 0800 397 667

REGISTER BY MAIL



Complete and return the form to Dyson in the envelope supplied.



Free Manuals Download Website

<http://myh66.com>

<http://usermanuals.us>

<http://www.somanuals.com>

<http://www.4manuals.cc>

<http://www.manual-lib.com>

<http://www.404manual.com>

<http://www.luxmanual.com>

<http://aubethermostatmanual.com>

Golf course search by state

<http://golfingnear.com>

Email search by domain

<http://emailbydomain.com>

Auto manuals search

<http://auto.somanuals.com>

TV manuals search

<http://tv.somanuals.com>