



SPECIFICATIONS KF300z

DESCRIPTION

A 3-way full range loudspeaker in a vented trapezoidal enclosure. Includes a 12-in woofer, a horn-loaded 7-in midrange cone with Radial Phase Plug™, and a 1.4-in exit compression driver on a 90° x 45° constant directivity horn. The internal crossover is user-switchable for either passive or bi-amp operation (with a passive LF/MF crossover). The enclosure has six fly points, three each top and bottom, plus an integral pole mount cup. Handles are located for the best balance when carrying.

APPLICATION

The KF300z is one of the smallest, full-range, 3-way loudspeakers available. It is particularly suited for portable or installed applications, including band PA, club systems, corporate AV, and theatrical productions. The midrange section incorporates a 7-in radial phase plug based on EAW's patented 10-in Radial Phase Plug™ used in other KF Series products. This design produces a time-coherent midrange wavefront that is critical to ensuring good vocal articulation. The appearance of the KF300z is enhanced with a curved grille that matches other KF300 as well as companion KF600 Series products. Six year warranty.

PERFORMANCE

Frequency Response (Hz)	
±3 dB	100 Hz to 20 kHz
-10 dB	80Hz
Axial Sensitivity (dB SPL/1 Watt/1m)	
Passive	92
LF/MF	92
HF	101
Impedance (Ohms)	
Passive	4
LF/MF	4
HF	8
Power Handling, AES Standard (Watts)	
Passive	750
LF/MF	750
HF	200
Calculated Maximum Output (dB SPL, @ 1m)	
Full Range Peak	127.0
Bi-amped LF/MF Peak	127.0
Bi-amped HF Peak	130.0
Full Range Long Term	121.0
Bi-amped LF/MF Long Term	121.0
Bi-amped HF Long Term	124.0
Nominal Coverage Angle / -6 dB points (degrees)	
Horizontal	90
Vertical	45



PHYSICAL

Part Number	0001325
LF Subsystem & Loading	1x 12-in, vented
MF Subsystem & Loading	1x 7-in horn-loaded cone
HF Subsystem & Loading	1x 1.4-in exit/2.5-in diaphragm compression driver on constant directivity horn
System Configuration	3-way, full-range
Powering Configuration(s)	Switchable full-range or bi-amplified (passive LF/MF crossover)
Controls (switches, knobs)	Powering mode switch
Recommended High-Pass Frequency (12 dB/octave)	80 Hz
Enclosure Materials	Exterior grade Baltic birch plywood
Finish	Wear resistant textured black paint
Connectors	2x Neutrik NL4 Speakon
Mounting Hardware	6x 3-position flytracks with integral 3/8"-16 threaded mounting/suspension points (3 each top & bottom), recessed cup for standmount
Grille	Powder coated perforated steel, foam backed





SPECIFICATIONS KF300z

DIMENSIONAL DRAWING

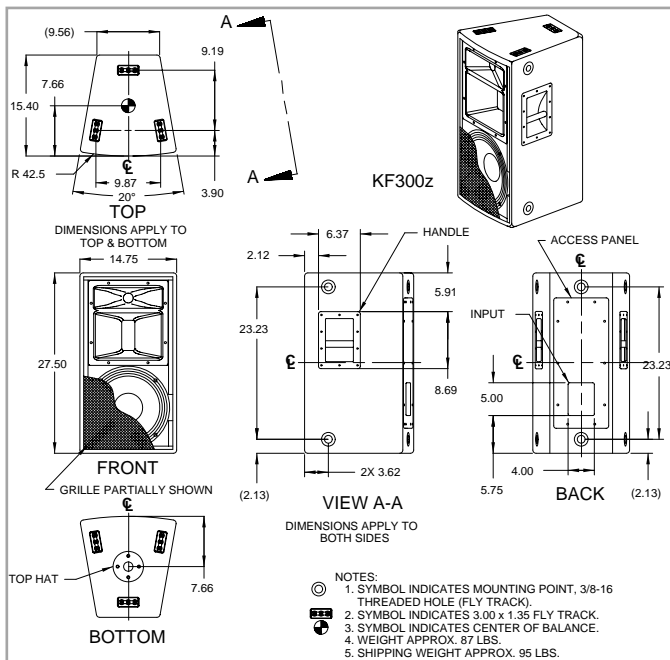

Manufacturing tolerances are +/- 0.13 and +/- 1°

PHYSICAL continued

Dimensions	inches	millimeters
Height	27.5	699
Width (Front)	14.8	375
Width (Rear)	9.5	241
Depth	15.4	391
Trapezoid Angle	10 degrees per side	
Weights	pounds	kilograms
Net Weight	87	39.6
Shipping Weight	95	43.2

A & E SPECIFICATIONS

The 3-way full-range loudspeaker shall incorporate a vented 12-in LF transducer, a 7-in horn-loaded cone MF transducer with Radial Phase Plug™, and a 1.4-in exit / 2.5-in diaphragm HF compression driver on a constant directivity horn. The MF/HF horn shall have a nominal beamwidth of 90° (h) x 45° (v).

System frequency response shall vary no more than ±3 dB from 100 Hz to 20 kHz measured on axis. In passive mode, the loudspeaker shall produce a sound pressure level (SPL) of 92 dB SPL on axis at 1 meter with a power input of 1 watt, and shall be capable of producing a peak output of 127 dB SPL on axis at 1 meter. It shall handle 750 watts of amplifier power (AES Standard) and shall have a nominal impedance of 4 ohms.

In bi-amped mode, the LF/MF section shall produce a sound pressure level (SPL) of 92 dB SPL on axis at 1 meter with a power input of 1 watt, and shall be capable of producing a peak output of 127 dB SPL on axis at 1 meter. It shall handle 750 watts of amplifier power (AES Standard) and shall have a nominal impedance of 4 ohms. In addition, the HF section in bi-amped mode shall produce a sound pressure level (SPL) of 101 dB SPL on axis at 1 meter with a power input of 1 watt, and shall be capable of producing a peak output of 130 dB SPL on axis at 1 meter. It shall handle 200 watts of amplifier power (AES Standard) and shall have a nominal impedance of 8 ohms.

The loudspeaker enclosure shall be trapezoidal in shape. It shall be constructed of exterior grade Baltic birch plywood and shall employ extensive internal bracing. It shall be finished in wear resistant textured black paint. Input connectors shall be 2x Neutrik NL4 Speakon. The system shall include a switch allowing it to be operated in passive or bi-amp powering mode. A total of six 3-position flytracks with integral 3/8"-16 threaded mounting/suspension points (3 each top and bottom) shall be provided. The front of the loudspeaker shall be covered with a powder coated perforated steel grille backed with open cell foam to protect against dust.

The 3-way full-range loudspeaker shall be the EAW model KF300z.



Free Manuals Download Website

<http://myh66.com>

<http://usermanuals.us>

<http://www.somanuals.com>

<http://www.4manuals.cc>

<http://www.manual-lib.com>

<http://www.404manual.com>

<http://www.luxmanual.com>

<http://aubethermostatmanual.com>

Golf course search by state

<http://golfingnear.com>

Email search by domain

<http://emailbydomain.com>

Auto manuals search

<http://auto.somanuals.com>

TV manuals search

<http://tv.somanuals.com>