



DUAL 18 INCH SUBWOOFER

See *NOTES TABULAR DATA* for details

CONFIGURATION

Subsystem

	<i>Transducer</i>	<i>Loading</i>
SUB	2x 18 in cone	Vented

Operating Mode

	<i>Amplifier Channels</i>	<i>External Signal Processing</i>
Single-amp	LF1/LF2	DSP w/1-way filter
Dual-amp	LF1, LF2	DSP w/1-way filter

PERFORMANCE

Operating Range	28 Hz to 160 Hz
------------------------	-----------------

Nominal Beamwidth

Horz	360°
Vert	360°

Axial Sensitivity (SPL)

LF1/LF2 (<i>whole space</i>)	95 dB	28 Hz to 160 Hz
(<i>half space</i>)	101 dB	28 Hz to 160 Hz

Input Impedance (ohms)

	<i>Nominal</i>	<i>Minimum</i>
LF1/LF2	4	3.8 @ 30 Hz
LF1, LF2	8 (each)	7.5 @ 30 Hz (each)

High Pass Filter

High Pass	=>30 Hz, 12 dB/octave
-----------	-----------------------

Accelerated Life Test

System	LF1/LF2	98 V	2400 W @ 4 ohm
	LF1, LF2	98 V (each)	1200 W @ 8 ohm (each)

Transducer (AES)	1200 W (each)
------------------	---------------

Calculated Axial Output Limit (*whole space SPL*)

	<i>Average</i>	<i>Peak</i>
LF1/LF2 (<i>whole space</i>)	129 dB	135 dB
(<i>half space</i>)	135 dB	141 dB

ORDERING DATA

<i>Description</i>	<i>Part Number</i>
SB1002 Dual 18 inch Subwoofer Black	0023835

Optional Accessories

FB1SB Subwoofer Fly Bar	0023840
PLT1K2 Caster Pallet	0023841

DESCRIPTION

EAW SB subwoofers are premium products designed for the most demanding professional applications. A broad range of capabilities and sizes provide designers with selections that can be specifically matched to the application. Top quality drivers, engineered by EAW, supply the highest output and best sonic performance possible for a given form factor. All SB models are direct radiating, with optimally tuned, vented enclosures. SB subwoofers are the choice where the absolute best sonic performance, highest reliability, and most robust physical construction are required.

The SB1002 is a large-format, high-output subwoofer system that can be ground-stacked or easily flown via an integral rigging system, making it ideal for a wide range of live and installed sound applications. It offers the fatter-sounding output of dual 18-inch cone drivers, with the mounting of these drivers maximizing cone area and minimizing front area, providing the acoustical performance and physical configuration well suited for creating large subwoofer arrays. The drivers are designed specifically for the SB1002, offering very large (4.5-inch) voice coils as well as powerful neodymium magnet structures that also reduce weight.

The SB1002 is designed to be used with sophisticated digital signal processing to optimize the LF response. EAW UX and MX Series processors are recommended for the required crossover and equalization.

The rigging system, similar to that of EAW's popular KF760 Series line arrays, features a fast, easy-to-use two-point approach that accommodates flown arrays of up to 12 SB1002 units. A handle on the rear upper corner of the SB1002 enclosure provides added guidance and convenient "push-pull" ability in the flying process.

Applications include large live music and dance clubs, houses of worship, performing arts/auditoriums, corporate events, and concert touring.

Six Year Warranty.

ENCLOSURE

- Material Baltic birch plywood
- Finish RoadCoat™ wear resistant textured black paint
- Grille Powder-coated perforated steel

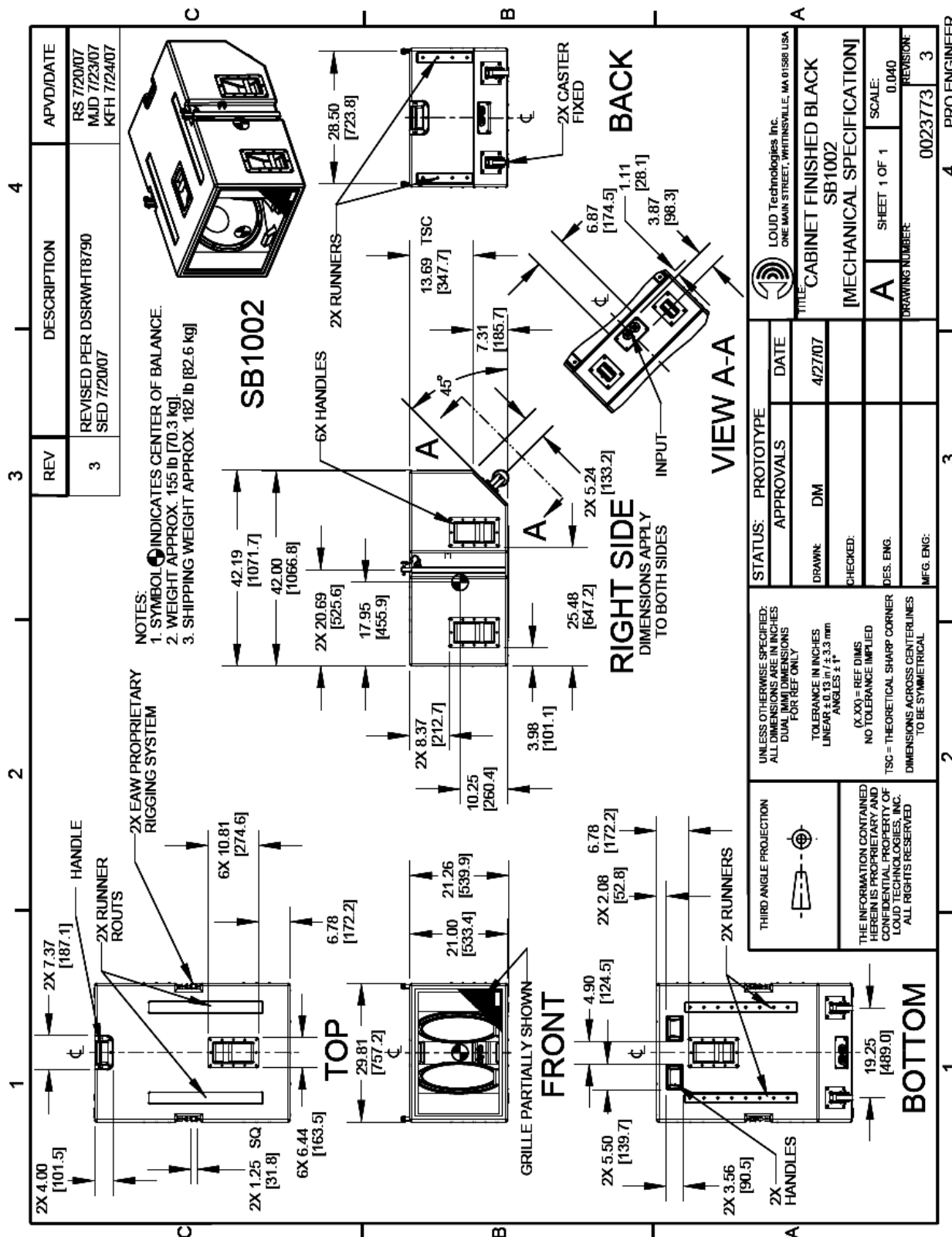

REV	DESCRIPTION	APVD/DATE
3	REVISED PER DSRWHT8790 SED 7/20/07	RS 7/20/07 MJJ 7/23/07 KFH 7/24/07

LOUD Technologies Inc. ONE MAIN STREET, WHITINSVILLE, MA 01588 USA	
TITLE: CABINET FINISHED BLACK SB1002 [MECHANICAL SPECIFICATION]	
STATUS: PROTOTYPE	DATE: 4/27/07
APPROVALS:	DRAWING: DM
CHECKED:	DES. ENG.
DIMENSIONS APPLY TO BOTH SIDES	SHEET 1 OF 1 SCALE: 0.040
MFG. ENG.	DRAWING NUMBER: 0023773 REVISION: 3

NOTES: This drawing has been reduced. Do not scale.

PERFORMANCE DATA

See **NOTES GRAPHIC DATA** for details

Frequency Response: Processed

LF1/2 Whole Space = green

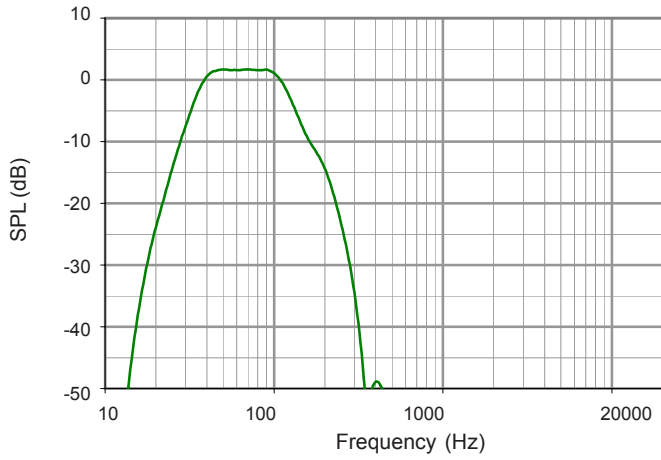

Frequency Response: Unprocessed

LF1/2 Whole Space = green

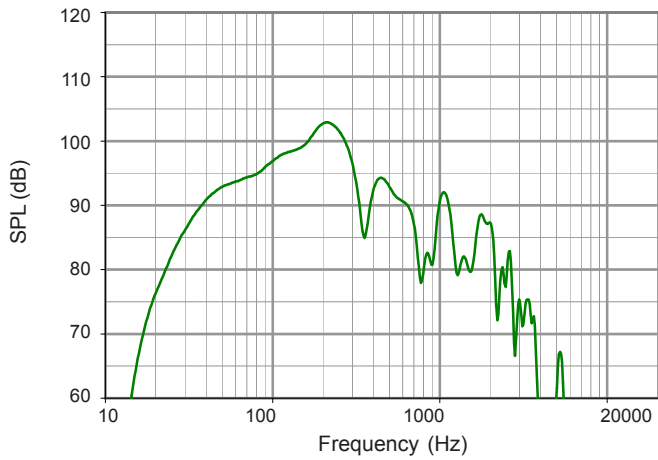

Frequency Response: Digital Signal Processor

LF = green

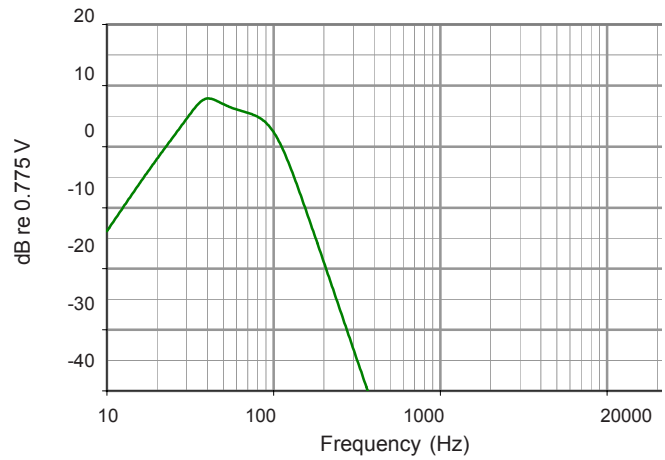

Impedance Magnitude

LF1/2 = green LF1, LF 2 (each) = orange

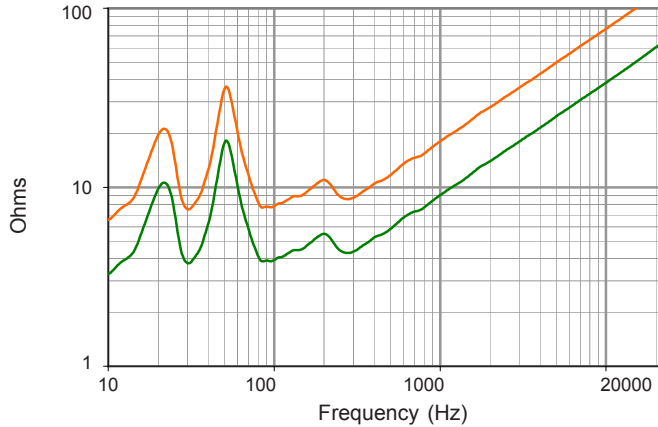

INPUT PANEL

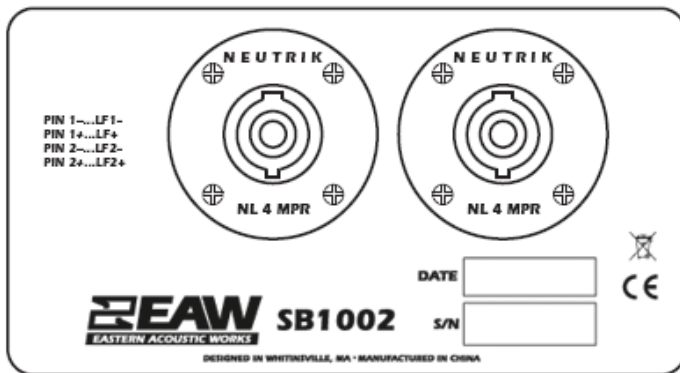

SIGNAL DIAGRAM

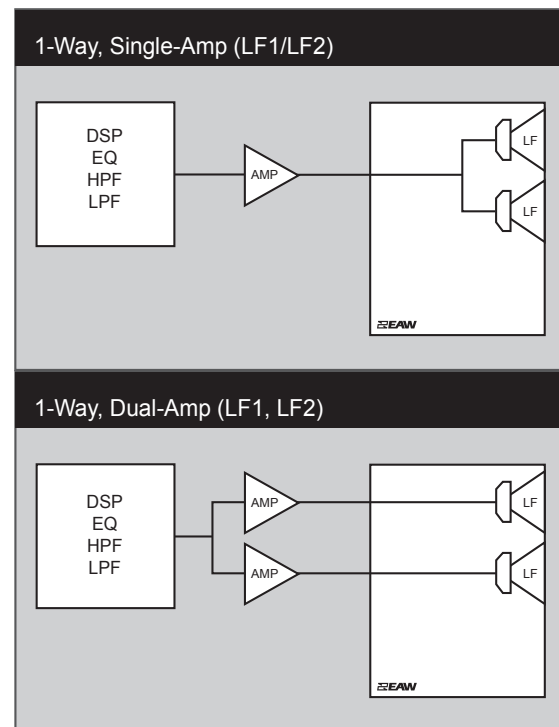

LEGEND

- DSP:** User-supplied Digital Signal Processor.
HPF: High Pass Filter for crossover or specified High Pass Filter.
LPF: Low Pass Filter for crossover.
LF/MF/HF: Low Frequency / Mid Frequency / High Frequency.
AMP: User-supplied Power Amplifier.
XVR: Passive LPFs, HPFs, and EQ integral to the loudspeaker.

NOTES

TABULAR DATA

- Measurement/Data Processing Systems:** Primary - FChart: proprietary EAW software; Secondary - Brüel & Kjær 2012.
- Microphone Systems:** Earthworks M30; Brüel & Kjær 4133
- Measurements:** Dual channel FFT; length: 32 768 samples; sample rate: 48 kHz; logarithmic sine wave sweep.
- Measurement System Qualification** (includes all uncertainties): SPL: accuracy +/-0.2 dB @ 1 kHz, precision +/-0.5 dB 20 Hz to 20 kHz, resolution 0.05 dB; Frequency: accuracy +/-1 %, precision +/-0.1 Hz, resolution the larger of 1.5 Hz or 1/48 octave; Time: accuracy +/-10.4 µs, precision +/-0.5 µs, resolution 10.4 µs; Angular: accuracy +/-1°, precision +/-0.5°, resolution 0.5°.
- Environment:** Measurements time-windowed and processed to eliminate room effects, approximating an anechoic environment. Data processed as anechoic or fractional space, as noted.
- Measurement Distance:** 7.46 m. Acoustic responses represent complex summation of the subsystems at 20 m. SPL is referenced to other distances using the Inverse Square Law.
- Volts:** Measured rms value of the test signal.
- Watts:** Per audio industry practice, "loudspeaker watts" are calculated as voltage squared divided by rated nominal impedance. Thus, these are not True Watt units of energy as defined by International Standard.
- SPL:** (Sound Pressure Level) Equivalent to the average level of a signal referenced to 0 dB SPL = 20 microPascals.
- Subsystem:** This lists the transducer(s) and their acoustic loading for each passband. Sub = Subwoofer, LF = Low Frequency, MF = Mid Frequency, HF = High Frequency.
- Operating Mode:** User selectable configurations. Between system elements, a comma (,) = separate amplifier channels; a slash (/) = single amplifier channel. DSP = Digital Signal Processor. IMPORTANT: To achieve the specified performance, the listed external signal processing must be used with EAW-provided settings.
- Operating Range:** Range where the processed Frequency Response stays within -10 dB SPL of the power averaged SPL within this range; measured on the geometric axis. Narrow band dips are excepted.
- Nominal Beamwidth:** Design angle for the -6 dB SPL points, referenced to 0 dB SPL as the highest level.
- Axial Sensitivity:** Power averaged SPL over the Operating Range with an input voltage that would produce 1 W at the nominal impedance; measured with no external processing on the geometric axis, referenced to 1 m.
- Nominal Impedance:** Selected 4, 8, or 16 ohm resistance such that the minimum impedance point is no more than 20% below this resistance over the Operating Range.
- High Pass Filter:** This helps protect the loudspeaker from excessive input signal levels at frequencies below the Operating Range.
- Accelerated Life Test:** System: Maximum test input voltage applied with an EIA-426B defined spectrum; measured with specified signal processing; Transducer: AES2-1984 R 1997.
- Calculated Axial Output Limit:** Highest average and peak SPLs possible during the Accelerated Life Test. The Peak SPL represents the 2:1 (6 dB) crest factor of the Life Test signal.

GRAPHIC DATA

- Resolution:** To remove insignificant fine details, 1/12 octave cepstral smoothing was applied to acoustic frequency responses and 1/3 octave cepstral smoothing was applied to the beamwidth and impedance data. Other graphs are plotted using raw data.
- Frequency Responses:** Variation in acoustic output level with frequency for a constant input signal. Processed: normalized to 0 dB SPL. Unprocessed inputs: 2 V (4 ohm nominal impedance), 2.83 V (8 ohm nominal impedance), or 4 V (16 ohm nominal impedance) referenced to a distance of 1 m.
- Processor Response:** The variation in output level with frequency for a constant input signal of 0.775 V = 0 dB reference.
- Impedance:** Variation in impedance magnitude, in ohms, with frequency without regard to voltage/current phase. This means the impedance values may not be used to calculate True Watts (see 8 above).



Free Manuals Download Website

<http://myh66.com>

<http://usermanuals.us>

<http://www.somanuals.com>

<http://www.4manuals.cc>

<http://www.manual-lib.com>

<http://www.404manual.com>

<http://www.luxmanual.com>

<http://aubethermostatmanual.com>

Golf course search by state

<http://golfingnear.com>

Email search by domain

<http://emailbydomain.com>

Auto manuals search

<http://auto.somanuals.com>

TV manuals search

<http://tv.somanuals.com>