



Service Manual

**761x (VHF)
764x (UHF)
Conventional Mobile**

VHF 146-174 MHz
45 Watts
Part No. 242-7610-0xx

UHF 400-430, 450-470, 470-490,
490-512 MHz
35 Watts
Part No. 242-7640-0xx



First Printing
November 1998



**761x (VHF)
764x (UHF)**

CONVENTIONAL FM TWO-WAY RADIO

**VHF 146-174 MHz
45 Watts**

**UHF 400-430, 450-470, 470-490, or 490-512 MHz
35 Watts**

Copyright© 1998 by Transcript International Incorporated

Transcript offers communication solutions in two core areas: land mobile radio products and systems, and information security. EFJohnson land mobile radios and systems provides wireless communication for a variety of markets including government, public safety, and commercial users. Transcript's information security devices utilize sophisticated scrambling and encryption techniques to protect sensitive voice and data transmissions.

Viking Head/EFJohnson logo and Call Guard® are registered trademarks of Transcript International Incorporated. Smartrunk II™ is a trademark of Smartrunk Systems Inc. All other company and/or product names used in this manual are trademarks and/or registered trademarks of their respective manufacturer.

Information in this manual is subject to change without notice.

TABLE OF CONTENTS

1	GENERAL INFORMATION	
1.1	SCOPE OF MANUAL	1-1
1.2	TRANSCEIVER DESCRIPTION	1-1
	General	1-1
1.3	PRODUCT WARRANTY	1-1
1.4	PART NUMBER BREAKDOWN	1-1
1.5	TRANSCEIVER IDENTIFICATION	1-1
1.6	ACCESSORIES	1-1
1.7	FACTORY CUSTOMER SERVICE	1-1
1.8	FACTORY RETURNS	1-2
1.9	REPLACEMENT PARTS	1-3
1.10	INTERNET HOME PAGE	1-3
2	INSTALLATION AND DISASSEMBLY	
2.1	GENERAL	2-1
	Scope of Instructions	2-1
	Performance Tests	2-1
	Transceiver Programming	2-1
	Power Source	2-1
2.2	TRANSCEIVER INSTALLATION	2-1
	Selecting Mounting Location	2-1
	Installing Mounting Bracket	2-2
	Installing Microphone Hanger	2-2
2.3	POWER CABLE INSTALLATION	2-2
	General	2-2
	Cable Installation	2-2
	Power Cable Fuses	2-3
2.4	USING AN EXTERNAL SPEAKER	2-3
2.5	ACCESSORY CABLE INSTALLATION	2-3
2.6	TRANSCEIVER DISASSEMBLY	2-4
2.7	2-TONE/5-TONE MODULE INSTALLATION	2-5
	Installation Procedure	2-5
	2-Tone Programming	2-5
	5-Tone Programming	2-5
3	OPERATION	
3.1	FEATURES	3-1
3.2	CONTROLS AND DISPLAY	3-2
	Front Panel Controls	3-2
	Display	3-2
	Back Panel	3-2
3.3	BASIC OPERATION	3-2
	Turning Power On and Off	3-2
	Entering a Password	3-3
	Volume Level Adjustment	3-3
	Power-On Menu	3-3
	Channel Selection	3-3
	Adjusting Squelch Level	3-3
	Bank Select	3-4
	Automatic Scan Enable	3-4
	Backlight On-Off	3-4
	Beep On-Off	3-4
3.4	RECEIVING AND PLACING CALLS	3-4
	Introduction	3-4
	Receiving a Call	3-4
	Placing a Call	3-4
	Monitoring Before Transmitting	3-4
	Time-Out Timer	3-5
3.5	PROGRAMMABLE FUNCTIONS	3-5
	Introduction	3-5
	Backlight On-Off	3-5
	Bank Select	3-5
	Beep On-Off	3-5
	Call Guard Tone Select	3-6
	Channel Select	3-6
	DTMF Number Select	3-6
	Emergency Key	3-6
	Lock Key	3-6
	Monitor Mode Select	3-6
	Output Power Select	3-6
	Priority Channel Select	3-6
	Receive Attenuate	3-6
	Scan Select	3-6
	Scan List Programming	3-7
	Talk-Around Select	3-7
	2-Tone Calling Features	3-7
	5-Tone Calling Features	3-7
	Wide/Narrow Band Select	3-7
3.6	CHANNEL SCAN	3-7
	Introduction	3-7
	Scan Lists	3-7
	Priority Channel Sampling	3-8
4	PROGRAMMING	
4.1	GENERAL	4-1
	Programming Setup	4-1
	Programming Cables	4-1
	Programming Software	4-1
4.2	STARTING THE PROGRAM	4-2
4.3	SPECIAL KEYS AND FUNCTIONS	4-2
4.4	MENU FLOW	4-2
	Introduction	4-2
	File Menu	4-2
	Screen Menu	4-3
	Program Menu	4-3
	Print Menu	4-3
	Model Menu	4-3
	Setup menu	4-4

TABLE OF CONTENTS (CONT'D)

4.5	UNIQUE PMR (EUROPEAN) SCREENS . . . 4-15	6	ADJUSTMENT PROCEDURE
	General 4-15	6.1	GENERAL 6-1
	Unique PMR Screens 4-15		Suggested Test Equipment 6-1
4.6	CLONING (PROGRAMMING ONE TRANSCEIVER WITH ANOTHER) 4-16		Test Channels 6-2
5A	VHF (7610) CIRCUIT DESCRIPTION		Test Cable 6-2
5.1	VHF RECEIVER CIRCUIT 5-1		Computer-Aided Tuning 6-3
	Antenna Switching Circuit 5-1		Reprogramming if EEPROM is Replaced or Error Occurs 6-4
	RF Circuit 5-1	6.2	PRELIMINARY SETUP 6-4
	First Mixer And First IF Circuits 5-1	6.3	PLL ADJUSTMENT (VHF MODELS) 6-4
	Second IF and Demodulator Circuits 5-1	6.4	TRANSMITTER ADJUSTMENTS (VHF MODELS) 6-4
	Audio Amplifier Circuit 5-2		Reference Frequency 6-4
	Receiver Mute Circuit 5-2		Output Power Adjust 6-5
5.2	VHF TRANSMITTER CIRCUIT 5-3		FM Deviation Adjust 6-5
	Microphone Amplifier Circuit 5-3		DTCS Waveform Adjust 6-6
	Modulation Circuit 5-3	6.5	RECEIVER ADJUSTMENTS (VHF MODELS) 6-6
	Transmit Driver Circuit 5-3		Bandpass Filter Adjust 6-6
	Power Amplifier Module 5-3		Squelch Adjust 6-6
	APC Circuit 5-4		Beep Tone Level 6-7
5.3	VHF PLL CIRCUIT 5-4	6.6	PLL ADJUSTMENT (UHF MODELS) 6-8
	PLL Circuit 5-4	6.7	TRANSMITTER ADJUSTMENTS (UHF MODELS) 6-8
	VCO Circuit 5-5		Reference Frequency 6-8
5.4	VHF IC PIN DESCRIPTIONS 5-5		Output Power Adjust 6-8
	VHF Power Supply 5-5		FM Deviation Adjust 6-8
	VHF CPU IC1 Port Allocation 5-5		DTCS Waveform Adjust 6-9
	VHF I/O Expander IC5 (Main Unit) 5-6	6.8	RECEIVER ADJUSTMENTS (UHF MODELS) 6-10
	VHF Port Expander IC11 (Main Unit) 5-6		Bandpass Filter Adjust 6-10
5B	UHF (7640) CIRCUIT DESCRIPTION		Squelch Adjust 6-10
5.5	UHF RECEIVER CIRCUIT 5-7		Beep Tone Level 6-10
	Antenna Switching Circuit 5-7	7	PARTS LIST
	RF Circuit 5-7		VHF (761x) Models
	First Mixer And First IF Circuits 5-7		Main Unit 7-1
	Second IF and Demodulator Circuits 5-7		Front Unit 7-18
	Audio Amplifier Circuit 5-8		Chassis Parts 7-20
	Receiver Mute Circuit 5-8		Exploded View 7-21
5.6	UHF TRANSMITTER CIRCUIT 5-9		UHF (764x) Models
	Microphone Amplifier Circuit 5-9		Main Unit 7-8
	Modulation Circuit 5-9		Front Unit 7-18
	Transmit Driver Circuit 5-9		Chassis Parts 7-20
	Power Amplifier Module 5-9		Exploded View 7-22
	APC Circuit 5-10		
5.7	UHF PLL CIRCUIT 5-10		
	PLL Circuit 5-10		
	VCO Circuit 5-11		
	UHF Power Supply 5-11		
	UHF CPU IC1 Port Allocation 5-11		
	UHF I/O Expander IC12 (Main Unit) 5-12		
	UHF Port Expander IC13 (Main Unit) 5-12		

TABLE OF CONTENTS (CONT'D)

8 SCHEMATIC DIAGRAMS AND COMPONENT LAYOUTS

VHF (761x) Models

Block Diagram	8-1
Transistor and Diode Basing	8-2
Main Unit Board Bottom View	8-3
Main Unit Board, Top View	8-4
Main Unit Schematic	8-5
Front Unit PC Board	8-10
Front Unit Schematic	8-11

UHF (764x) Models

Block Diagram	8-6
Transistor and Diode Basing	8-12
Main Unit Board Bottom View	8-7
Main Unit Board, Top View	8-8
Main Unit Schematic	8-9
Front Unit PC Board	8-10
Front Unit Schematic	8-11

LIST OF TABLES

1-1	75xx Accessories	1-2
3-1	Option Key Programmable Functions	3-5
4-1	Memory Channel Screen Description (LMR Models)	4-4
4-2	Key and Display Assign Screen Description	4-7
4-3	DTMF Autodial Screen Description	4-9
4-4	Continuous Tone Screen Description	4-10
4-5	Scan Function Screen Description	4-10
4-6	2-Tone Code Channel Screen Description	4-11
4-7	Common Screen Description	4-13
4-8	Expert Screen Description	4-14
6-1	VHF Test Frequencies	6-3
6-2	UHF Test Frequencies	6-3

LIST OF FIGURES

2-1	Installation Components	2-1
2-2	Mounting Bracket Installation	2-2
2-3	Accessory Cable Installation	2-3
2-4	Cover and Front Panel Removal	2-4
2-5	PC Board Screws	2-4
2-6	Removing PC Board	2-4
2-7	2/5-Tone Module Installation	2-5
3-1	7600 Front Panel	3-1
4-1	Programming Setup	4-1
4-2	Memory Channel Screen (PMR Models)	4-17
5-1	Second IF System IC3 (VHF)	5-2
5-2	Audio Switching and Amplifier Circuit (VHF)	5-2
5-3	PLL Circuit (VHF)	5-4
5-4	Second IF System IC1 (UHF)	5-8
5-5	Audio Switching and Amplifier Circuit (UHF)	5-8
5-6	PLL Circuit (UHF)	5-10
6-1	Test Setup	6-1
6-2	Screen Display Example	6-2
6-3	Test Cable Schematic	6-2
6-4	VHF Adjustment Points	6-5
6-5	Beep Tone Level Adjustment	6-7
6-6	UHF Adjustment Points	6-9

SECTION 1 GENERAL INFORMATION

1.1 SCOPE OF MANUAL

This service manual contains operation, installation, programming, alignment, and service information for the EFJohnson® 7610 and 7640 mobile transceivers.

1.2 TRANSCEIVER DESCRIPTION

1.2.1 GENERAL

The 7600-series mobile transceivers operate on conventional (non-trunked) channels. The 7610 operates in the VHF frequency range of 146-174 MHz, and the 7640 operates in the UHF frequency range of 400-430, 450-470, 470-490, or 488-512 MHz. Up to 32 channels can be programmed. Power output is user selectable or fixed for the following levels. Refer to Section 3.1 for more information on features.

Model	High	Low 1	Low 2
7610 (VHF)	45W	25W	4.5W
7640 (UHF)	35W	20W	3.5W

These transceivers are digitally synthesized and microprocessor controlled. Transceiver programming is performed using a PC-compatible computer, a special EFJohnson programming cable, and programming software (see Table 1-1). The alignment procedure is performed using this same hardware setup, a fabricated test cable, and special Adjust software included with the programming software (see Section 4).

1.3 PRODUCT WARRANTY

The warranty statement for this transceiver is available from your product supplier or from the Warranty Department, EFJohnson, 299 Johnson Avenue, P.O. Box 1249, Waseca, MN 56093-0514. This information may also be requested from the Warranty Department by phone as described in Section 1.7. The Warranty Department may also be contacted for Warranty Service Reports, claim forms, or any other questions concerning warranties or warranty service.

1.4 PART NUMBER BREAKDOWN

The following is a breakdown of the part number used to identify this transceiver.

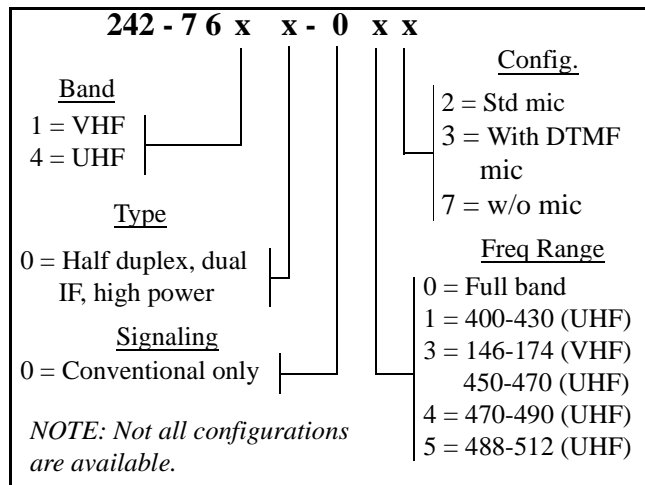

1.5 TRANSCEIVER IDENTIFICATION

The transceiver identification number is printed on a label that is attached to the chassis. The following information is contained in the identification number:

Model From P.N.	Revision Letter	Manufacture Date		Warranty Plant	Warranty Number
76xx	0	A	23 8	J	12345
8th Digit of P.N.	Week No. of Year		J = Japan Last Digit of Year		

1.6 ACCESSORIES

The accessories available for this transceiver are listed in Table 1-1.

1.7 FACTORY CUSTOMER SERVICE

The Customer Service Department of EFJohnson provides customer assistance on technical problems and the availability of local and factory repair facilities. Regular Customer Service hours are 7:30 AM. -

5:30 PM. Central Time, Monday - Friday. The Customer Service Department can be reached using one of the following telephone numbers:

Toll-Free: (800) 328-3911

(From within continental United States only)

International: (507) 835-6911

FAX: (507) 835-6969

E-Mail: First Initial/Last Name@efjohnson.com

(You need to know the name of the person you want to reach. Example: jsmith@efjohnson.com)

NOTE: Emergency 24-hour technical support is also available at the 800 and preceding numbers during off hours, holidays, and weekends.

When your call is answered at EFJohnson, you will hear a brief message informing you of numbers that can be entered to reach various departments. This number may be entered during or after the message using a tone-type telephone. If you have a pulse-type telephone, wait until the message is finished and an operator will come on the line to assist you. When you enter some numbers, another number is requested to further categorize the type of information you need.

You may also contact the Customer Service Department by mail. Please include all information that may be helpful in solving your problem. The mailing address is as follows:

EFJohnson
 Customer Service Department
 299 Johnson Avenue
 P.O. Box 1249
 Waseca, MN 56093-0514

1.8 FACTORY RETURNS

Repair service is normally available through local authorized EFJohnson Land Mobile Radio Service Centers. If local service is not available, the equipment can be returned to the factory for repair. However, it is recommended that you contact the Customer Service Department before returning equipment because a service representative may be able to suggest a solution

Table 1-1 75xx Accessories

Accessory	Part No.
Mounting bracket	585-7600-040
DC cable assembly	585-7600-029
Mounting screws and fuses	585-7600-041
Microphone hanger	023-3514-001
Mic hanger ground wire	023-7171-911
Function name stickers	585-7600-042
Microphone, standard	585-7600-020
Microphone, DTMF	585-7600-022
2-Tone/5-tone module kit	585-7600-026
5", 4.7-ohm, 15W external speaker	250-0151-010
Compact speaker	585-7600-023
Accessory/data cable (DB-9 connector)	585-7600-027
Programming Accessories	
Programming software, 3-1/2 disk	585-7600-030
Programming cable, computer-adapter	585-7500-031
Adapter cable, prog cable-xcvr	585-7600-031
Replication (cloning) cable	597-2002-200
DB-9 M to DB-25 F adapter	515-9000-015

to the problem so that return of the equipment would not be necessary.

Be sure to fill out a Factory Repair Request Form #271 for each unit to be repaired, whether it is in or out of warranty. These forms are available free of charge by calling Customer Service (see Section 1.7) or by requesting them when you send a unit in for repair. Clearly describe the difficulty experienced in the space provided and also note any prior physical damage to the equipment. Then include a form in the shipping container with each unit. Your telephone number and contact name are important because there are times when the technicians have specific questions that need to be answered in order to completely identify and repair a problem.

When returning equipment for repair, it is also a good idea to use a PO number or some other reference number on your paperwork in case you need to call the repair lab about your unit. These numbers are referenced on the repair order and it makes it easier and faster to locate your unit in the lab.

Return Authorization (RA) numbers are not necessary unless you have been given one by the Field Service Department. RA numbers are required for exchange units or if the Field Service Department wants to be aware of a specific problem. If you have been given an RA number, reference this number on the Factory Repair Request Form sent with the unit. The repair lab will then contact the Field Service Department when the unit arrives.

1.9 REPLACEMENT PARTS

Replacement parts can be ordered directly from the Service Parts Department. To order parts by phone, dial the toll-free number as described in Section 1.7. When ordering, please supply the part number and quantity of each part ordered. EFJohnson dealers also need to give their account number. If there is uncertainty about the part number, include the desig-

nator (C512, for example) and the model number of the equipment the part is from.

You may also send your order by mail or FAX. The mailing address is as follows and the FAX number is shown in Section 1.7.

EFJohnson
Service Parts Department
299 Johnson Avenue
P.O. Box 1249
Waseca, MN 56093-0514

1.10 INTERNET HOME PAGE

EFJohnson has a site on the World Wide Web that can be accessed for information on the company and such things as products, systems, and regulations. The address is <http://www.efjohnson.com>.

This page intentionally left blank.

7610 (VHF) AND 7640 (UHF) MOBILE SPECIFICATIONS

The following are general specifications intended for use in testing and servicing this transceiver. For current advertised specifications, refer to the specification sheet available from your sales representative. Values are typical and are subject to change without notice.

GENERAL

Frequency Range	VHF: 146-174 MHz UHF: 400-430 MHz, 450-470 MHz, 470-490 MHz, or 488-512 MHz (some performance degradation from 488-490 MHz with 488-512 MHz models)
Operating Modes	Conventional (non-trunked), Tone and digital Call Guard® squelch
Channels	32 maximum (2 banks x 16 channels available)
Transmit/Receive Separation	Any frequency within the range
Channel Spacing (dual IF Models)	VHF - 12.5 kHz (narrow band) and 30 kHz (wideband) UHF - 12.5 kHz (narrow band) and 25 kHz (wideband)
Maximum Deviation	12.5/15 kHz channel spacing - 2.5 kHz maximum 25 kHz channel spacing - 5.0 kHz maximum
Frequency Stability	5.0 PPM (VHF), 2.5 PPM (UHF) from -22° to +140° F (-30° to +60° C)
Dimensions (w/o controls)	1.6" H x 5.5" W x 6.7" D (4.1 cm x 13.9 cm x 17.0 cm)
Weight	2 lb. 11 oz. (1.22 kg)
Supply Voltage	13.6 volts DC nominal (12-volt, negative ground vehicle electrical system)
Current Drain (maximum)	Standby - 200 mA standby Receive (rated audio out) - 700 mA Medium Tx Power - 6.0 A (VHF), 7.0 A (UHF) High Tx Power - 15 A max/10 A typ (VHF), 11 A max/8 A typ (UHF)
FCC Compliance	Parts 15 and 90

RECEIVER

Sensitivity (12 dB SINAD)	0.25 μ V
Selectivity	70 dB at 25 kHz, 60 dB at 12.5 kHz
Spurious and Image Rejection	70 dB
Intermodulation	65 dB
Hum and Noise	46 dB at 25 kHz, 40 dB at 12.5 kHz
Maximum Frequency Spread	Any spread within the range
Audio Power Output	3.5 W into 4-ohm load
Audio Distortion	Less than 10% at 1 kHz with 60% deviation
Audio Response	+2, -8 dB at 6 dB per octave de-emphasis
RF Input Impedance	50 ohms

TRANSMITTER

RF Power Output	VHF: 45W (high), 25W (low 1), 4.5W (low 2) UHF: 35W (high), 20W (low 1), 3.5W (low 2)
Spurious and Harmonic Emissions	70 dB
FM Hum and Noise	46 dB at 25 kHz, 40 dB at 12.5 kHz
Audio Modulation	12.5 kHz - 11K0F3E, 25 kHz - 16K0F3E
Audio Distortion	Less than 5% at 1 kHz with 40% modulation
Audio Frequency Response	+2, -8 dB at 6 dB per octave pre-emphasis
Maximum Frequency Spread	Any spread within the band
RF Output Impedance	50 ohms
Duty Cycle	20% TIA

NOTES

SECTION 2 INSTALLATION AND DISASSEMBLY

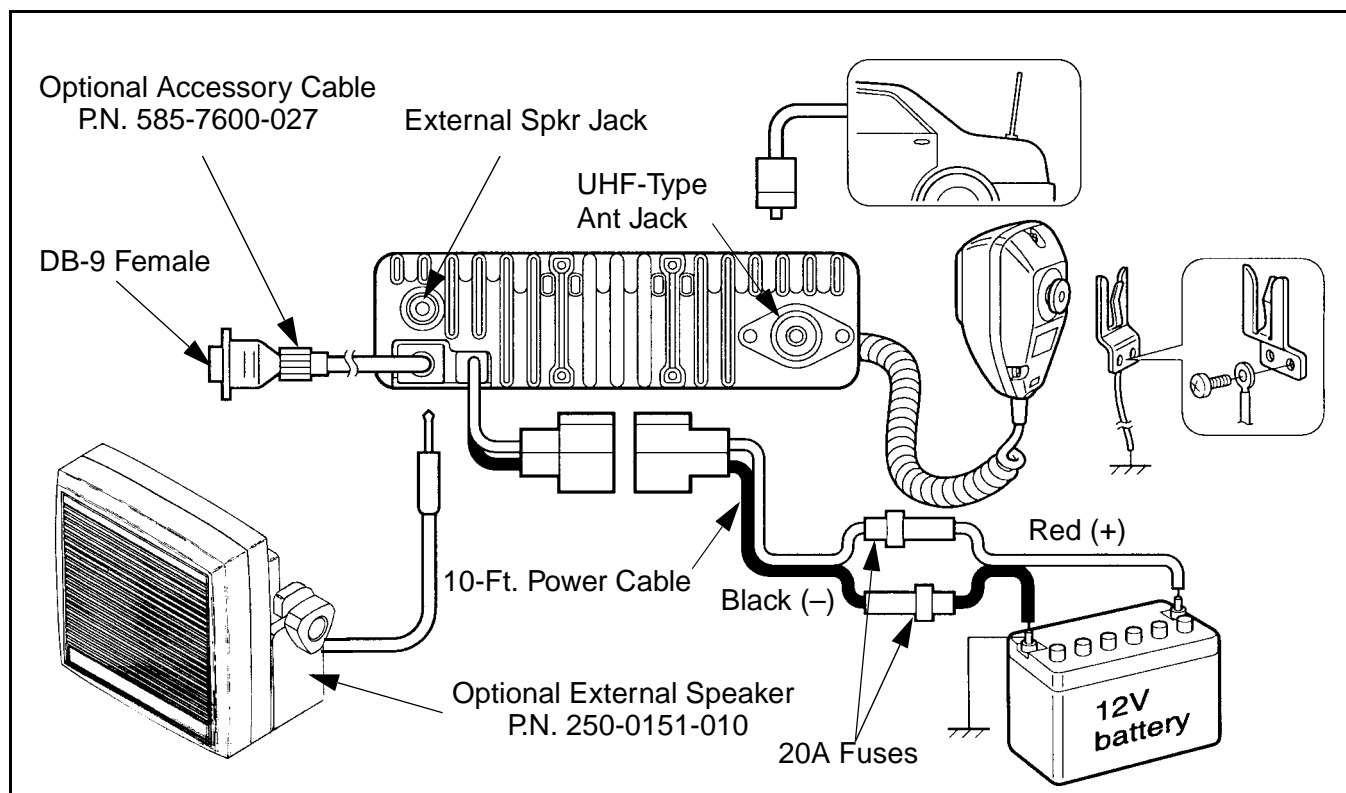

Figure 2-1 Installation Components

2.1 GENERAL

2.1.1 SCOPE OF INSTRUCTIONS

Since each installation is somewhat unique, the following installation instructions are intended only as a general guide to installing this transceiver.

2.1.2 PERFORMANCE TESTS

Although each transceiver is carefully tested at the factory before shipment, it is good practice to verify proper operation before it is placed in service. Important checks are receiver sensitivity and transmitter frequency, deviation, and power output.

2.1.3 TRANSCEIVER PROGRAMMING

The transceiver needs to be programmed before it is placed in service. Programming instructions are located in Section 4. Transceivers normally contain

factory test channels and other test parameters when they are shipped. The included labels should be attached to the option keys to indicate the function.

2.1.4 POWER SOURCE

This transceiver must be connected to a nominal 12 VDC, negative ground vehicle electrical system (negative battery terminal connected directly to the chassis). If the vehicle has some other type of electrical system, a suitable voltage converter is required.

2.2 TRANSCEIVER INSTALLATION

2.2.1 SELECTING MOUNTING LOCATION

This transceiver is designed for mounting in a location within convenient reach of the operator such as the dash, console, or floor. Since the mounting location can affect safe operation of the vehicle, observe the following precautions:

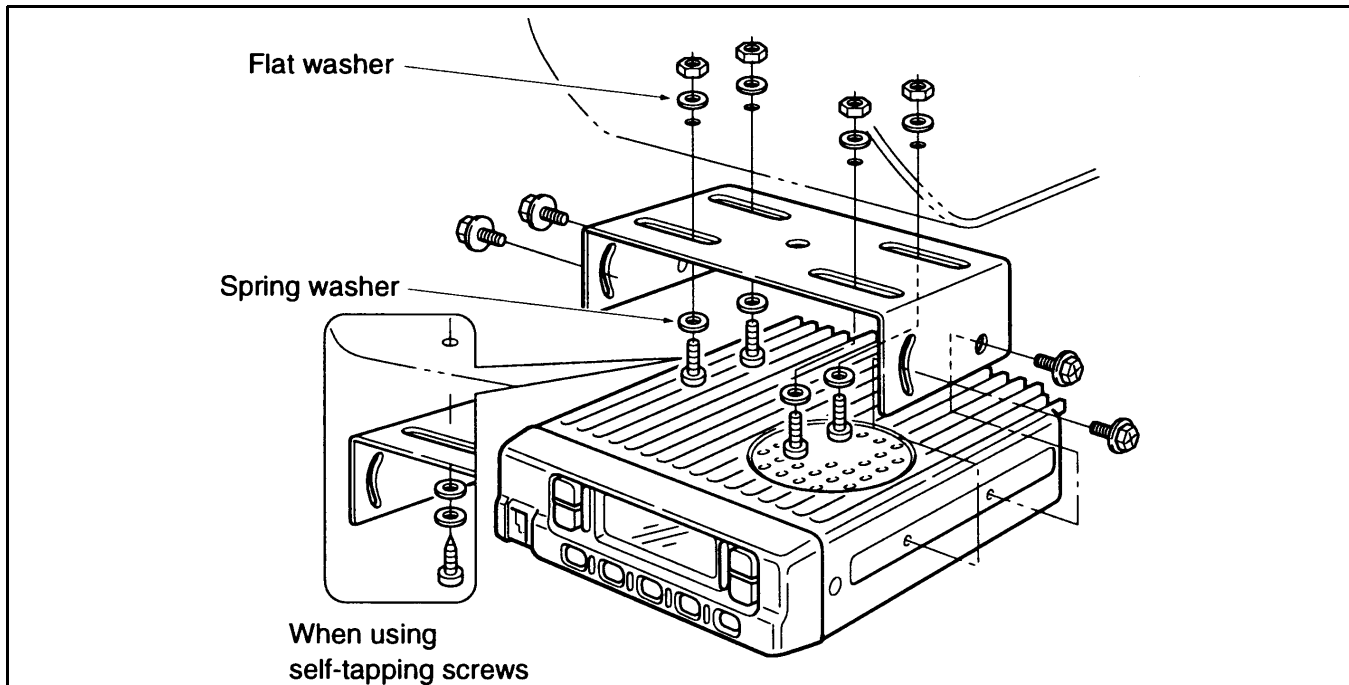

Figure 2-2 Mounting Bracket Installation

WARNING

- Do not mount the transceiver where it may interfere with the operation of vehicle controls.
- Do not mount the transceiver where the user cannot easily reach the controls and view the display.
- Do not mount the transceiver where it may cause additional injury in case of an accident.
- Air bags inflate with great force. Therefore, do not mount this transceiver in the deployment area of an air bag. In addition, do not place other objects in the deployment area or other locations where they could unintentionally move into the deployment area.

2.2.2 INSTALLING MOUNTING BRACKET

Check the area behind the intended mounting location for wiring, brake and gas lines, or other components that could be damaged when the mounting screws are installed. Then install the bracket and transceiver as shown in Figure 2-2. Both standard and self-tapping screws are included for installing the bracket.

2.2.3 INSTALLING MICROPHONE HANGER

Install the included microphone hanger in a convenient location. For proper operation of functions such as monitoring and scanning, the hanger may need to be connected to chassis ground. If required, ground the hanger using the included grounding wire.

2.3 POWER CABLE INSTALLATION

2.3.1 GENERAL

It is recommended that both wires of the power cable be connected directly to the vehicle battery. Connection of either wire to other points may result in increased interference from the vehicle's electrical system. If noise is still a problem, try installing a noise filter.

2.3.2 CABLE INSTALLATION

1. Before starting power cable installation, it is good practice to remove the negative cable from the battery to prevent damage from accidental short circuits.

2. Route the red and black wires from the transceiver to the battery. Connect the red wire to the positive (+) terminal and the black wire to the negative (-) terminal.
3. Plug the cable into the pigtail coming from the transceiver and reconnect the negative battery cable.
4. Install the antenna according to the manufacturer's instructions. The transceiver has a standard UHF connector. Check VSWR. Reflected power should be less than 4% of forward power (VSWR less than 1.5 to 1).

input that can be used to control the backlight (see Section 3.3.9). This cable is installed as shown in Figure 2-3.

This cable has a standard DB-9 female connector for interfacing to external equipment. The pin numbering and functions are as follows:

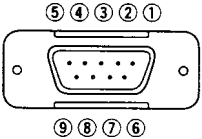
DB-9 Female Connector Outside View	
	
DB-9 Pin	Function
1	LCD backlight control in
2	AF out
3	Detected AF out
4	Modulation in
5	PTT control in
6	Horn drive control out
7	AF ground
8	Detected AF ground
9	Modulation ground

2.3.3 POWER CABLE FUSES

Each power cable wire is protected by a 20-ampere fuse. These fuses are inspected and changed as shown below. If a fuse blows, locate the cause if possible and replace it with one of the same rating.

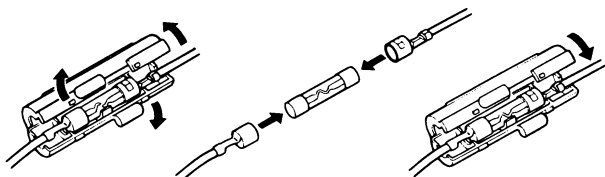

Changing 20-Ampere Power Cable Fuses

2.4 USING AN EXTERNAL SPEAKER

An external speaker can be plugged into the external speaker jack on the back of the transceiver. This speaker should have an impedance of 4-8 ohms and a power handling capability of at least 3.5 watts. The internal speaker is automatically disabled when a speaker is plugged into this jack. The external speaker jack is a standard 1/8-inch, two-conductor phone jack.

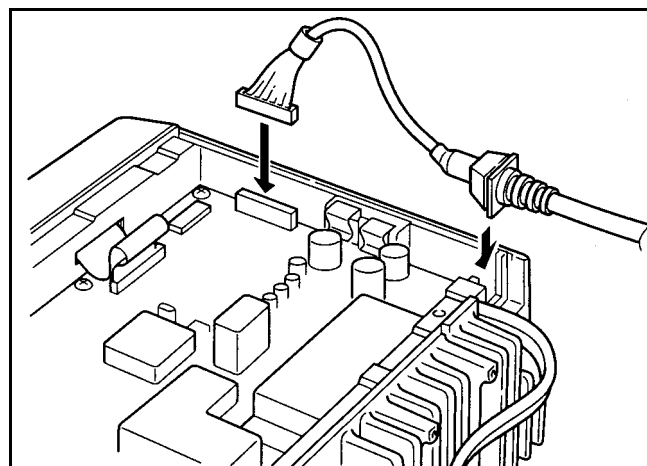

Figure 2-3 Accessory Cable Installation

2.5 ACCESSORY CABLE INSTALLATION

Optional Accessory Cable, Part No. 585-7600-027, can be used for connecting accessories such as a horn alert or modem to the transceiver. It also has an

2.6 TRANSCEIVER DISASSEMBLY

Removing Bottom Cover and Front Panel

1. Remove the bottom cover by removing four screws (A) as shown in Figure 2-4.
2. Remove the front panel by removing two screws (B).

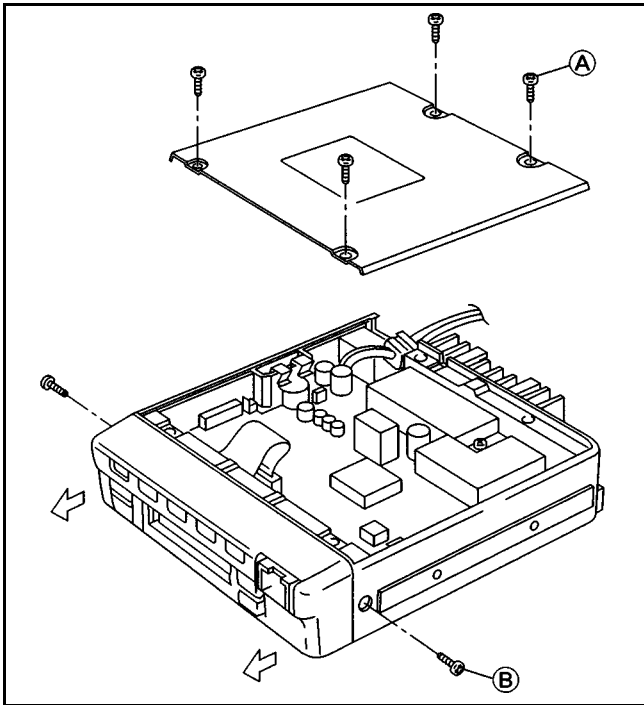

Figure 2-4 Cover and Front Panel Removal

Removing PC Board

3. Remove ten screws (C) and two clips (D) as shown in Figure 2-5.
4. Remove shield (E).
5. Unsolder the antenna connector at three points (F).
6. Lift the front of the PC board assembly as shown in Figure 2-6 and pull it out.

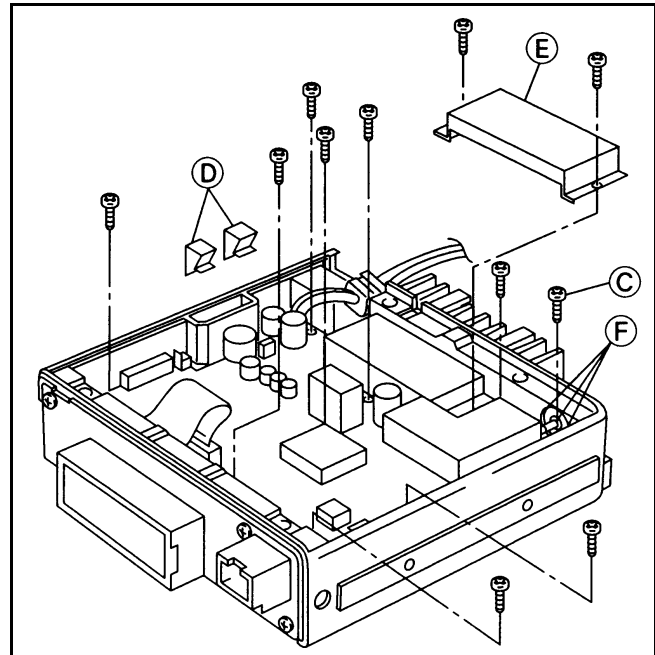

Figure 2-5 PC Board Screws

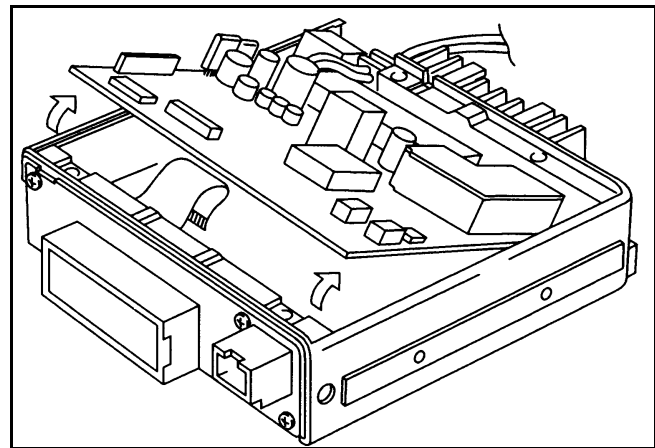

Figure 2-6 Removing PC Board

2.7 2-TONE/5-TONE MODULE INSTALLATION

2.7.1 INSTALLATION PROCEDURE

1. Turn power off and disconnect the power cable.
2. Remove the bottom cover by removing the four screws (A) shown in Figure 2-5.
3. Install the module as shown in Figure 2-7. The included foam pad is not used with this transceiver.

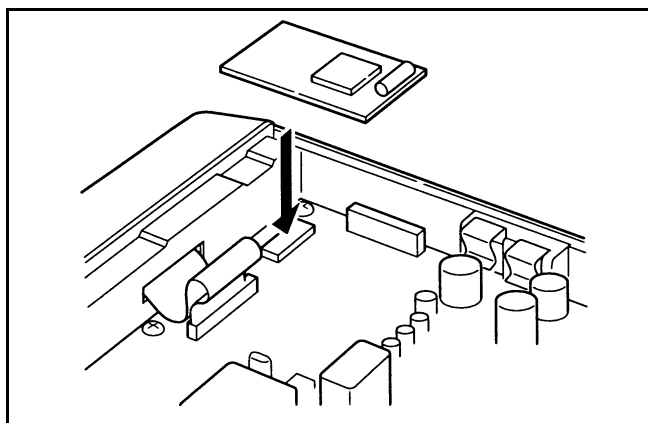

Figure 2-7 2/5-Tone Module Installation

2.7.2 2-TONE PROGRAMMING

Program the transceiver for operation with a two-tone decoder as described in Section 4. Screens that need to be programmed with two-tone decoder information are as follows. Refer to on-line help for more information on parameters in these screens (press F1 with parameter selected).

Model Menu - “LMR” must be selected (see Section 4.4.6).

Screen Menu - Select “2Tone Code CH” and program the information in the screen (see Table 4-6).

Screen Menu - Select “Memory Channel” and program the information under “2Tone Dec” for each channel on which the decoder will be used (see Table 4-1).

Screen Menu - Select “Key & Display Assign” and program an option key or the microphone hanger for the monitor function so that the decoder can be re-activated when the call is complete (see Table 4-2).

2.7.3 5-TONE PROGRAMMING

Program the transceiver for operation with a five-tone module as described in Section 4. Screens that need to be programmed with five-tone decoder information are as follows. Refer to on-line help for information on parameters in these screens (press F1 with parameter selected).

Model Menu - “PMR” must be selected (see Section 4.4.6).

Select the following in the Screen Menu:

- “Rx Code CH” and program the information in the screen (see Section 4.5.2).
- “Tx Code CH” and program the information in the screen (see Section 4.5.2).
- “User Tone” and program the information in the screen (see Section 4.5.2).
- “Memory CH” and program the parameters in this screen that are related to 5-tone operation on the channel (see Figure 4-2).

NOTE: If performing the deviation adjustment in the next section, the long tone must be turned on in RPT/STN/ID on the Memory Channel screen.

- “Key & Display Assign” and program Tx Code and Call switches for use in transmitting 5-tone codes.

Setting 5-Tone Deviation

The only adjustment on the 2/5-tone module is a potentiometer for setting the transmit tone deviation for 5-tone operation. This control is factory preset and should not require readjustment in the field. However, if adjustment is required, proceed as follows:

1. Monitor the transmit signal with a communications monitor. Set it for HPF = Off, LPF = 20 kHz, De-emphasis = Off, and Level = (P-P)/2.
2. Select a channel near the center of the band and turn a long tone on (see preceding "NOTE") by pressing the appropriate front panel key.
 - 25 kHz Channel Spacing - ± 3.5 kHz
 - 20 kHz Channel Spacing - ± 2.8 kHz
 - 12.5 kHz Channel Spacing - ± 1.7 kHz
3. Adjust potentiometer R18 (DEV) on the module for the following deviation:
 - 25 kHz Channel Spacing - ± 3.0 to 5.0 kHz
 - 20 kHz Channel Spacing - ± 2.4 to 4.0 kHz
 - 12.5 kHz Channel Spacing - ± 1.5 to 2.5 kHz
4. Check channels on each end of the operating band to make sure deviation is within the following limits. If not, repeat preceding adjustment.

NOTE: It is recommended that scanning not be used with these options because it may cause part or all of the tone burst to be missed.

SECTION 3 OPERATION

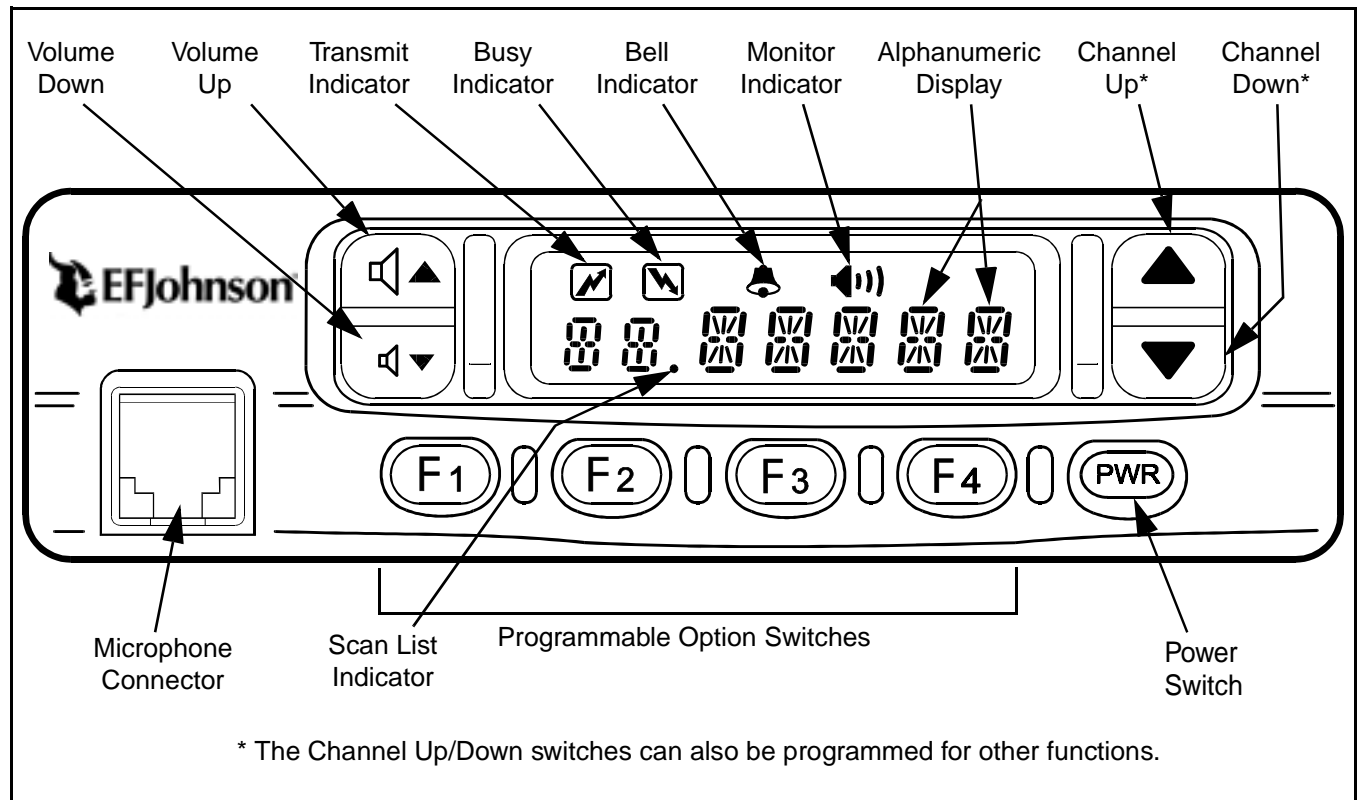

Figure 3-1 7600 Front Panel

3.1 FEATURES



- Up to 32 channels programmable
- Multi-tone (CTCSS) and/or Multi-code (CDCSS) Call Guard® squelch programmable
- VHF and UHF, wideband and narrowband models available
- Up to 45 watts VHF and 35 watts UHF transmitter power output
- Seven-character alphanumeric display with back-light
- Six programmable option keys
- Busy indicator
- Normal and priority scan to ensure that calls are not missed
- Up to five different user programmable scan lists selectable
- Bank select available (up to two banks with sixteen channels each)
- User selectable power output available
- DTMF microphone optional
- 2-tone/5-tone signaling optional



NOTE: Some of the preceding features are available only if programmed.

3.2 CONTROLS AND DISPLAY

3.2.1 FRONT PANEL CONTROLS

Power Switch () - Press this switch to turn power on and press and hold it to turn power off. The transceiver may be programmed so that a password must be entered to allow operation. Refer to Section 3.3.2 for more information.

Volume Up/Down Keys ( ) - Adjust the volume level up or down in up to 32 steps. The minimum selectable volume level can be set as described in Section 3.3.3.

Up/Down Keys ( ) - These keys may be programmed to select the next higher or lower channel or for other functions. Refer to the descriptions in Section 3.5 for more information.

Microphone Connector - Connection point for the microphone. Do not connect microphones other than standard microphone P.N. 589-7600-020 and DTMF microphone P.N. 589-7600-022 to this transceiver. The pin assignments could be different and damage to the microphone or transceiver may result.

F1/F2/F3/F4 - These keys can be programmed to control any of the functions described in Section 3.5. Place the applicable included label on the switch to indicate its function.

3.2.2 DISPLAY

Transmit Indicator () - Indicates that the transmitter is keyed or the 5-tone code is being sent (if applicable). If this indicator is flashing, the internal temperature is high and the transmitter power output is being cut back. Normal operation automatically resumes when the temperature returns to the normal range.

Busy Indicator () - Indicates the currently selected channel is busy (see Section 3.4.4).

Bell Indicator () - Appears or flashes when a 5-tone call is detected that the transceiver is programmed to receive.

Monitor Indicator () - Indicates that the monitor mode is enabled. This mode disables coded squelch control so that all messages occurring on the channel are heard. Refer Section 3.4.4 for more information.

Display - This seven-character display indicates the selected channel, status information, and error conditions. If information in this display begins flashing, an error condition is indicated. Two possible causes are a defective antenna or a battery voltage below 8 VDC.

3.2.3 BACK PANEL

External Speaker Jack - Miniature phone jack for connecting an optional 4-8 ohm external speaker. The internal speaker is automatically disabled when a speaker is plugged into this jack.

Antenna Jack - UHF-type jack for connecting the antenna.

DC Power Cable - Connects the transceiver to a nominal 12 VDC, negative ground vehicle power source. Refer to Section 2-1 for more information.

Accessory Cable - This optional cable is used to connect accessories such as a horn alert and modem to the transceiver. Refer to Section 2-1 for more information.

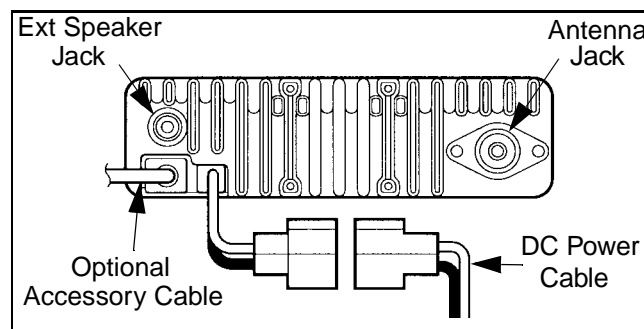

Transceiver Back Panel

3.3 BASIC OPERATION





3.3.1 TURNING POWER ON AND OFF

When power is turned on by pressing the POWER switch, a tone sounds and an opening message is displayed if programmed. The transceiver is

then ready to be used. To turn power off, press and hold the POWER switch until power turns off.



3.3.2 ENTERING A PASSWORD

The transceiver may be programmed so that a password must be entered before the transceiver can be used. When power is then turned on, "PWORD" is displayed and the four-digit passcode must be entered. This code is entered using the F1-F4 and channel down () keys. The number entered by each key is as follows. The numbers in a block are detected as the

Key					
Number	0	1	2	3	4
Entered	5	6	7	8	9

same. For example, "1234" is the same as "6789". If the "PWORD" indication does not turn off after entering four digits, you may have entered an incorrect number. Cycle transceiver power and try again.



3.3.3 VOLUME LEVEL ADJUSTMENT

The volume can be adjusted in up to 32 steps by pressing the volume up/down keys ( ). A graph in the alphanumeric display indicates the current volume level. If equipped with a **MONI** option switch, you may be able to press (or press and hold) that switch to enable audio for use as a reference level.

The minimum selectable volume level can be set by the power-on menu described in Section 3.3.4. Select this mode and then press F1 to display "AFMIN". Then press the volume up/down keys to select the desired minimum level. The current level is indicated by the bar graph, or receiver noise can be enabled as described in Section 3.3.6.



3.3.4 POWER-ON MENU

The power-on menu is a special menu that can be selected at power on to control various functions. Proceed as follows:



1. Select the power-on menu by turning power on with the up and down   keys pressed.
2. The F1-F4 keys now control the following functions. Press the switch once to select the function



and then again to return to the normal channel display.

- F1** - Minimum volume level (see Section 3.3.3)
- F2** - Key beep on-off (see Section 3.5.4)
- F3** - Backlight on-off (see Section 3.5.2)
- F4** - Squelch adjust (see description which follows)

3. To return the F1-F4 keys to the programmed functions, turn transceiver power off and on again without   pressed.





3.3.5 CHANNEL SELECTION

Channel Scrolling - If the   keys are programmed as **CH UP** or **CH DN** keys, they can be pressed to scroll up or down through the programmed channels.

Direct Selection - The F1-F4 and   keys can be programmed to directly select a specific channel. These keys are then labeled **CH 1** to **CH 4**.

3.3.6 ADJUSTING SQUELCH LEVEL

The squelch level is adjusted by programming or selecting the power-on menu just described. Proceed as follows to use the power-on menu:

1. Select a non-busy channel. Then select the power-on menu by turning power on with the up and down   keys pressed.
2. Press the F4 option key to select the squelch adjust mode indicated by "SQ xx".
3. Press the down  key until noise is heard from the speaker (adjust the volume if necessary). Then press the up  key until the noise just mutes (the "SQ xx" number indicates the relative squelch level).
4. Reselect normal operation by turning power off and on without the up and down keys pressed.

NOTE: If weak messages are not heard or unsquelching occurs when no messages are present, slight readjustment up or down may be required.

3.3.7 BANK SELECT

Two banks of up to 16 channels each can be programmed. Only the channels in the current bank are then selectable. This would allow, for example, groups of channels to be programmed for operation in different cities.

The **BANK** key is pressed to switch between banks, and the current bank is indicated briefly in the display as “BANK 1” or “BANK 2”. If bank select is not used, a single block of up to 32 channels can be programmed.

3.3.8 AUTOMATIC SCAN ENABLE

The transceiver can be programmed so that scanning is automatically enabled whenever power is turned on or the microphone is placed on-hook. Refer to the scan description in Section 3.6 for more information.

3.3.9 BACKLIGHT ON-OFF

The following backlight modes can be selected by the **LITE** option switch or by pressing F3 in the power-on menu described in Section 3.3.4.

LI ON - On continuously

LI OF - Always off

LI AT - Controlled by the voltage applied to pin 1 of the DB9 connector on the optional accessory cable (see “Light” in Table 4-2).

3.3.10 BEEP ON-OFF

The key beep which sounds when keys are pressed can be enabled and disabled by pressing the **BEEP** option switch or pressing F2 in the power-on menu described in Section 3.3.4. Either “BP ON” or “BP OF” is displayed to indicate the current mode.

3.4 RECEIVING AND PLACING CALLS

3.4.1 INTRODUCTION

The two calls which can be placed and received are mobile-to-mobile and telephone calls. With telephone calls, the telephone number can be dialed using

a microphone with a telephone keypad, or up to seven telephone numbers also may be preprogrammed and then selected by pressing the **DTMF** key (see description in Section 3.5.7).

3.4.2 RECEIVING A CALL



1. Turn transceiver power on and set the volume level as described starting in Section 3.3.1.
2. Select or scan the channel or channels on which you want to receive the call. Refer to Section 3.6 for more information on scanning.
3. When the message is received, take the microphone off-hook and respond. Press the microphone push-to-talk (PTT) switch to talk and release it to listen.
4. When the conversation is finished, place the microphone back on-hook. The microphone hanger may control features such as scanning and monitoring that are described later.

3.4.3 PLACING A CALL

1. Turn transceiver power on and set the volume level as described starting with Section 3.3.1.
2. Select the channel on which the call will be made as described in Section 3.4.
3. Regulations require that the channel be monitored before transmitting to make sure that it is not being used by anyone else. If you were to transmit while someone was talking, you would probably disrupt their conversation. Refer to “Monitoring Before Transmitting” description which follows for more information.
4. If the channel is not busy, press the microphone PTT switch to talk and release it to listen.
5. When the conversation is finished, place the microphone back on-hook.

3.4.4 MONITORING BEFORE TRANSMITTING

Use one of the following methods to monitor the channel before transmitting a message:

- Note if the busy indicator () on the front panel is being displayed. If it is not, the channel is not busy and a message can be transmitted.
- Taking the microphone off-hook disables coded squelch control if it is programmed for the monitor function. Take the microphone off-hook and the  indication should be displayed. If no messages are heard, the channel is not busy and a message can be transmitted.
- If the monitor () option switch is programmed, pressing it disables coded squelch control similar to taking the microphone off-hook. If no messages are then heard, the channel is not busy and a message can be transmitted. Press the switch again to disable monitoring.
- If the Transmit Disable On Busy feature is programmed on the channel, the transmitter is automatically disabled if the channel is busy. This is indicated by the display flashing and a rapid beeping when the PTT switch is pressed.

3.4.5 TIME-OUT TIMER

The time-out timer disables the transmitter if it is keyed continuously for longer than the programmed time. If the transmitter is disabled by this feature, the transmit indicator () turns off and the display flashes and a beeping tone is produced until the PTT switch is released.

One use of this feature is to prevent a channel from being kept busy for an extended period by an accidentally keyed transmitter. It can also prevent possible damage to the transceiver caused by transmitting for an excessively long period.

There is also a penalty timer that may be programmed to prevent further transmissions for the programmed time after the transmitter is disabled.

3.5 PROGRAMMABLE FUNCTIONS

3.5.1 INTRODUCTION



The F1-F4 and   keys on the front panel can be programmed for the functions shown in

Table 3-1 Option Key Programmable Functions































Function	Key Label	Description Section No.
Backlight On-Off		3.3.9
Bank Select		3.3.7
Beep on-off		3.3.10
Call Guard Tone Select		3.5.7
Channel Select	     	3.3.5
DTMF Number Select		3.5.7
Emergency Switch		3.5.8
Lock enable/disable		3.5.9
Monitor Mode Select		3.4.4
Output Power Select	  	3.5.11
Priority Channel Select	 	3.6.3
Receive Attenuate		3.5.13
Scan Select		3.6
Scan List Programming		3.6.2
Talk-Around Select		3.5.16
2-Tone, 5-Tone Calling	     	3.5.18
Wide/Narrow Band Select		3.5.19

Table 3-1. A sheet of labels is included with the transceiver, and the applicable label should be placed on the key to indicate its function. Refer to the section listed in the table for a description of the function.

3.5.2 BACKLIGHT ON-OFF

Refer to Section 3.3.9.

3.5.3 BANK SELECT

Refer to Section 3.3.7.

3.5.4 BEEP ON-OFF

Refer to Section 3.3.10.

3.5.5 CALL GUARD TONE SELECT

If the transceiver has a **[TONE]** key, the Call Guard (CTCSS) tone can be selected. This allows calls to be placed to different mobiles or groups of mobiles and received on different groups than is normal for the channel. Proceed as follows:

1. Press the **[TONE]** key and “TON--x” is displayed.
2. Press the channel up/down (**[▲]** **[▼]**) keys to select the desired tone (“TON--1” to “TON--9”).
3. Press the **[TONE]** key again to exit this mode. Calls are then placed on the current channel and other channels using the new code until it is changed.
4. To reselect the standard Call Guard squelch tone programmed for the channel, select “TON--M” using the same procedure.

3.5.6 CHANNEL SELECT

Refer to Section 3.3.5.

3.5.7 DTMF NUMBER SELECT

If the transceiver has a **[DTMF]** key, up to seven preprogrammed telephone numbers can be transmitted. Proceed as follows:

1. Press the **[DTMF]** key and the currently selected number is indicated as “DTMF x”.
2. Press the channel up/down keys (**[▲]** **[▼]**) to select a different number.
3. To transmit the selected number on the current channel, press and hold the **[DTMF]** key.

NOTE: The DTMF 6 number is used for emergency calls and the DTMF 7 number is used for automatic logging. Therefore, if these features are used, the number may not be available for regular calls.

3.5.8 EMERGENCY KEY

Press and hold the **[EMER]** key to transmit an emergency call. To cancel this call before it is transmitted, press and hold this key again. Once emergency

transmission begins, the call cannot be canceled. Programming determines the channel on which the call is transmitted and also if it is transmitted once or repeatedly until a control code is received.

3.5.9 LOCK KEY

Press and hold the **[LOCK]** key to lock all programmable keys except **[CALL]** **[MONI]** and **[EMER]**. Either “LK ON” or “LK OF” is displayed to indicate the current condition. If a locked key is pressed, all that happens is “LOCK” is displayed.

3.5.10 MONITOR MODE SELECT

Refer to Section 3.4.4.

3.5.11 OUTPUT POWER SELECT

The **[HIGH]** **[LOW1]** and **[LOW2]** keys can be used to temporarily or permanently override the programmed power output for the channel. The programming of the “RF Power Selection” parameter in Table 4-2 determines operation. Pressing the key once selects the level on the key and pressing it again selects the programmed level.

3.5.12 PRIORITY CHANNEL SELECT

Pressing **[PRI A]** selects the priority A channel and pressing **[PRI B]** selects the priority B channel. The **[PRI A]** key can also be programmed so that pressing and holding the key makes the current channel the priority A channel. Refer to Section 3.6.3 for more information.

3.5.13 RECEIVE ATTENUATE

Pressing the **[ATT]** key turns receive signal attenuation on and off. Either “AT ON” or “AT OF” is displayed to indicate the current mode. The attenuator can be turned on if nearby strong RF signals such as commercial radio stations or pager transmitters are causing distortion of the receive signal.

3.5.14 SCAN SELECT

Pressing the **[SCAN]** key turns the channel scan feature on and off. Refer to Section 3.6 for more information.

3.5.15 SCAN LIST PROGRAMMING

Pressing the **[TAG]** key changes the scan list status of the current channel. Refer to the scan list description in Section 3.6.2 for more information.

3.5.16 TALK-AROUND SELECT

The talk-around mode causes transmissions to occur on the receive frequency to permit direct mobile-to-mobile communication when a repeater is being used. The talk-around mode is turned on and off by pressing the **[TA]** key. Either "AR ON" or "AR OF" is briefly displayed to indicate the current mode. Changing the channel or turning power off causes talk-around to revert to the off condition.

3.5.17 2-TONE CALLING FEATURES

If the optional 2-tone signaling option is used, pressing the **[CALL]** key transmits the 2-tone codes on the selected channel or on a non-busy channel if pressed while scanning.

3.5.18 5-TONE CALLING FEATURES

If the optional 5-tone signaling option is used, the following keys may be programmed to control various functions.

[CALL] **[CAL A]** **[CAL B]** - Transmit the 5-tone call. Depending on your signaling system, call transmission may be necessary before you call another station. The CAL A and CAL B keys may be programmed when selective Individual/Group calls are used.

[TX CH] - Selects the 5-tone code to be transmitted. To change the contents of the station code, push and hold this key and then press the **[▲]** **[▼]** keys.

[CODE] - Selects the transmit code directory.

[MR CH] - Recalls last five codes received. Press and hold to erase all codes. To scroll, press **[▲]** **[▼]**.

3.5.19 WIDE/NARROW BAND SELECT

Pressing the **[W/N]** key switches the receiver between narrowband and wideband operation. The

display briefly indicates "WIDE" or "NARROW" to indicate the current mode. Each channel can also be programmed for wide or narrow band operation, and this switch toggles that setting. However, the change is only temporary because the programmed condition is reselected if the channel is changed or power is cycled.

3.6 CHANNEL SCAN

3.6.1 INTRODUCTION

The channel scan feature monitors the channels in the current scan list. When a message is detected that the transceiver is programmed to receive, scanning stops and the message is received. Shortly after the message is complete, scanning resumes (after the resume timer counts down). The selected channel changes to that of the call.

If the microphone is taken off-hook or the transmitter is keyed while scanning, scanning resumes when the auto reset timer selected for the channel counts down. Scanning does restart if this timer is disabled or if the Scan A key is programmed with power-on scan disabled (see Tables 4-2 and 4-5).

Scanning is turned on and off by the **[SCAN]** key. The transceiver also may be programmed so that scanning automatically turns on whenever power is turned on or the microphone is placed on-hook. The microphone must be on-hook for scanning to occur.

The decimal point in the display flashes when the scan mode is enabled. Then when scanning is actually occurring, either the scan list identification (see next section) or the rapidly cycling channel identification is displayed as the channels are scanned. Programming determines which occurs (see Table 4-5).

3.6.2 SCAN LISTS

Up to five scan lists can be selected by pressing and holding the **[SCAN]** key until the scan list identification appears and then pressing the **[▲]** **[▼]** keys. Press the **[SCAN]** key again to exit this mode (this also occurs automatically in about 30 seconds) and again to enable scanning (if desired).

The scan lists are user programmable if the **TAG** key is available. Pressing this key changes the status of the displayed channel in the current scan list only. The display indicates “SC ON” if the channel was just added to the scan list and “SC OF” if it was just deleted. In addition, the scan list status is indicated by the decimal point in the display. This indicator is on when the displayed channel is scanned. The decimal point flashes when scanning is occurring.

The scan list status of a channel can be changed while scanning only when listening to a message on the channel. The current status of all the lists is stored in memory. Therefore, the status of the various scan lists does not change when power is turned off.

3.6.3 PRIORITY CHANNEL SAMPLING

Priority channel sampling ensures that messages on priority channels are not missed while listening to

messages on other channels. If priority sampling is used, a priority A channel is designated by programming. If the **PRI A** key is available, pressing that key selects the priority A channel. This key also may be programmed so that if it is pressed and held, the priority A channel changes to the current channel.

Sampling of the priority A channel occurs only when scanning is enabled. It does not occur while transmitting. When the priority channel is sampled while listening to a message on another channel, a series of “ticks” are heard. These ticks are brief interruptions of the audio signal that occur while the transceiver changes channels to check the priority channel.

Another priority channel also can be programmed that can be quickly selected by the **PRI B** key. This channel is programmed only to allow quick selection and is not sampled while listening to a non-priority channel.

SECTION 4 PROGRAMMING

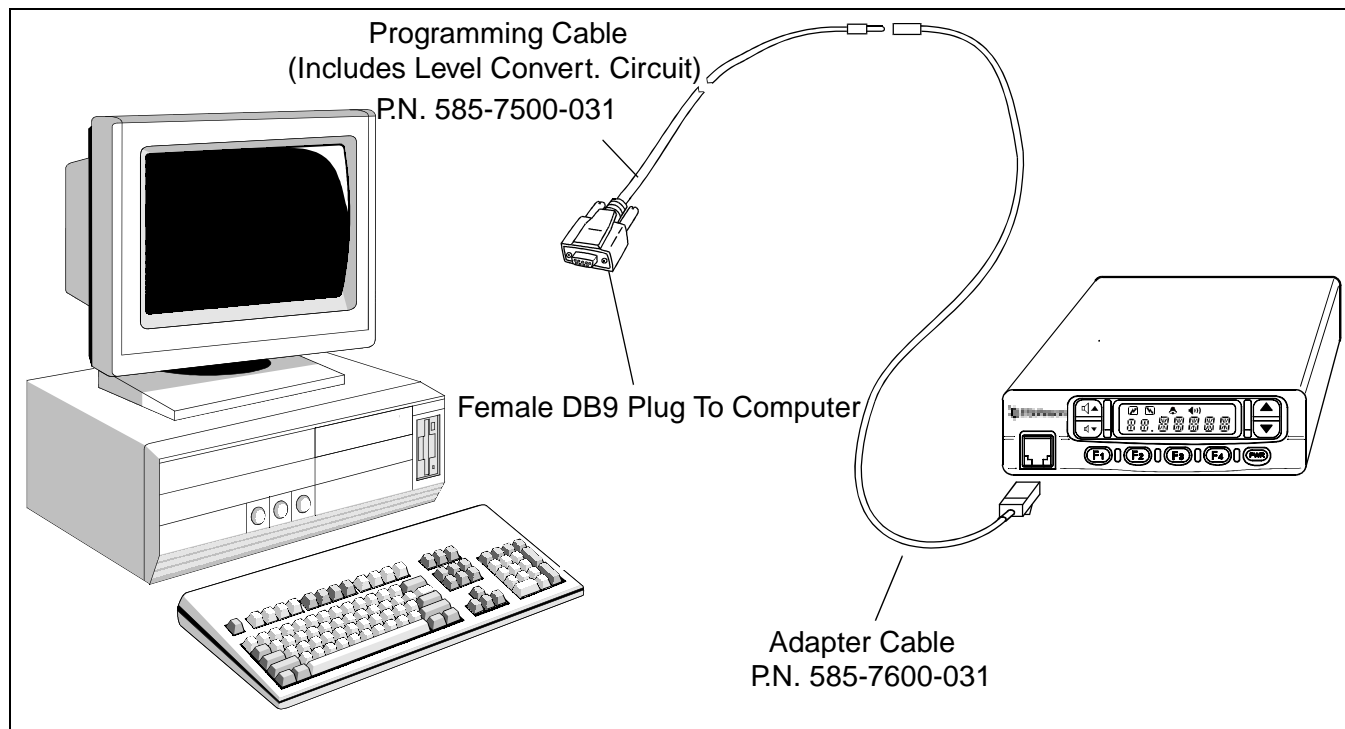

Figure 4-1 Programming Setup

4.1 GENERAL

4.1.1 PROGRAMMING SETUP

The following items are required to program this transceiver. The part numbers of the programming cable and software are shown in Table 1-1. A printer is also recommended for making a hard copy record of the information programmed into the transceiver. The programming setup is shown above.

- IBM® PC AT or PS/2 compatible computer with one available serial port
- MS-DOS® version 5.02 or higher or equivalent
- E.F. Johnson programming cable (includes required level converter circuit) and adapter cable
- E.F. Johnson programming software

4.1.2 PROGRAMMING CABLES

Programming Cable, Part No. 585-7500-031, and Adapter Cable, Part No. 585-7600-031, are required to

connect the computer to the transceiver. The programming cable has a female DB9 connector which plugs into the serial port of the computer. In this connector is a level converter circuit which converts the RS-232 levels of the computer to the logic levels required by the transceiver. The other end of the cable plugs into the adapter cable which adapts the miniature phone plug to the modular-style microphone connector on the transceiver. Turn transceiver power on after these cables are connected.

4.1.3 PROGRAMMING SOFTWARE

The programming software is distributed on a 3-1/2" 1.44 M diskette. This diskette includes the main executable program RP7600.EXE and several ancillary files it requires to run. These files total approximately 430k in size. Also included on this disk is the ADJUST program used to tune the transceiver. This program and other files it requires to run total about 180k in size and are located in a separate subdirectory

on the disk called ADJ. The use of this program is described in Section 5.

These are DOS programs, so Windows® 3.x, 95, or NT are not required to run them. If the program does not run properly in Windows, run it in the DOS mode.

Before you use the program, the files on the diskette should be copied to your hard disk or a programming disk. Do not use the distribution disk for programming or transceiver tuning because it should be kept as a backup in case something happens to the program on the working disk.

4.2 STARTING THE PROGRAM

Proceed as follows:

1. Start the computer in the DOS mode. If the program is not installed on a hard drive, insert the programming disk in drive A.
2. Make the directory of the program the current directory. Then start the program by typing RP7600 (Enter).
3. The Memory Channel screen described in Section 4.4.3 is then displayed. Set or modify the data as desired. Make sure to scroll right using the → key so the right-most screen parameters can be programmed.

4.3 SPECIAL KEYS AND FUNCTIONS

- Information on the various parameters is available in the form of help screens. To display information on the currently highlighted function or setting, press F1.
- Pressing ALT or ESC selects the menu on top or returns to the previous screen.
- ↑ ↓ keys or highlighted character keys move the cursor.

- The Space or backspace key toggle the setting.
- Use the File menu to save the data and exit the program.

4.4 MENU FLOW

4.4.1 INTRODUCTION

The menu bar along the top of the screen is used to select the various menus that are used to program this transceiver. Press the ALT or ESC key to enable this menu bar. Then to move horizontally to select a menu, use the arrow (← →) keys or type the highlighted letter in the title. Then to display the menu and highlight the desired item, use the arrow (↓ ↑) keys and then press ENTER to select it. The following describes each of the menus that can be selected.

4.4.2 FILE MENU



Load - Loads data from a previously saved data file. To display the directory, press (Enter) again.

Save - Saves the current data to the specified file. The extension “.ICF” is automatically added to the file name.

Delete - Deletes the current file.

Dos - Allows you to go to the DOS mode to perform a function in DOS such as copying a file. To return to the previous screen, type EXIT.

Exit - Quits the program and exits to DOS.

4.4.3 SCREEN MENU

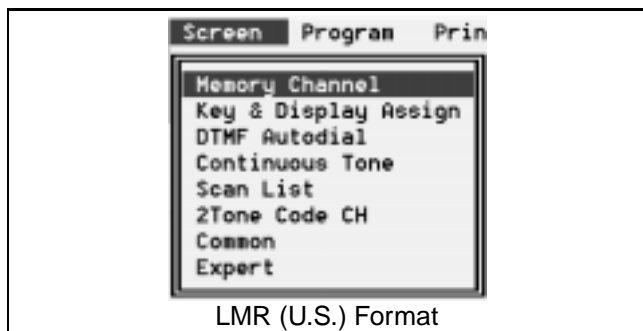

NOTE: The Screen menu for PMR (European) models is slightly different than the LMR version shown above. Refer to Section 4.5 for more information on PMR models.

Memory Channel - Displays the screen shown in Table 4-1 which is used to program channel parameters such as frequency, Call Guard (CTCSS/DCTS) coding, and power output. The screen in Table 4-1 is for LMR models; refer to Section 4.5 for information on the PMR version.

Key and Display Assign - Displays the screen shown in Table 4-2 which assigns functions to the programmable keys.

DTMF Autodial - Displays the screen shown in Table 4-3 which programs five DTMF code channels (pre-stored telephone or other numbers). Up to 24 characters can be programmed in each location.

Continuous Tone - Displays the screen shown in Table 4-4 which programs nine user selectable Call Guard (CTCSS) tones.

Scan List - Displays the screen shown in Table 4-5 which programs various parameters for each scan list.

2-Tone Code Channel - Displays the screen shown in Table 4-6 which programs transceiver operation with a 2-tone option. The optional 2/5-Tone Decoder Kit, Part No. 585-7500-026, is required to use the 2-tone function. This screen is displayed with LMR models only (see Section 4.4.6).

Common - Displays the screen shown in Table 4-7 which programs miscellaneous information such as various timer settings.

Expert - Displays the screen shown in Table 4-8 which programs various timers and other information. Normally, the default value in this screen should not be changed.

4.4.4 PROGRAM MENU

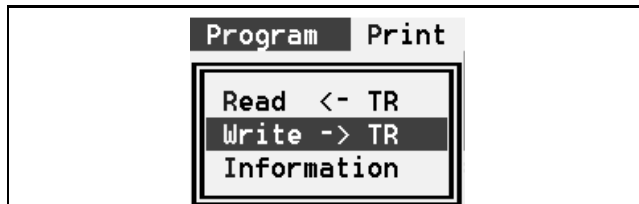

Read ← TR - Reads the data programmed in the connected transceiver.

Write → TR - Programs the connected transceiver with the current data.

Information - Displays information on the connected transceiver such as the model, revision, and the “Program Comment” programmed in the Common screen (see Table 4-7).

4.4.5 PRINT MENU

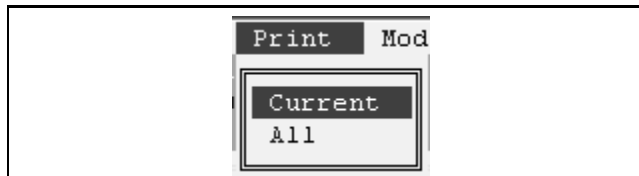

Current - Prints the currently displayed data.

All - Prints all data for the selected file.

4.4.6 MODEL MENU

LMR - Selects LMR (U.S.A.) models. Selecting this model displays unique parameters in various screens for programming a 2-tone option. The differences are

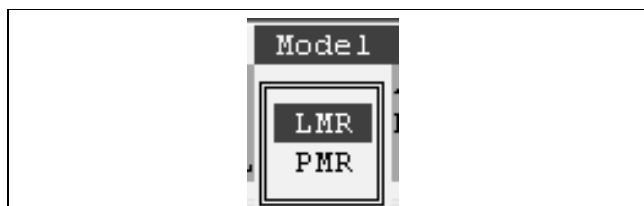

Refer to Section 4.5 for more information on PMR models.

4.4.7 SETUP MENU

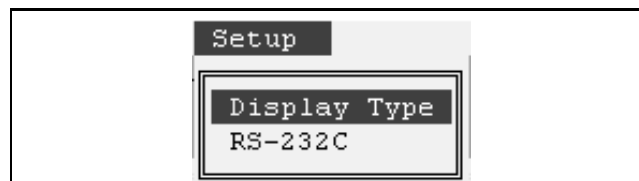

in the Screen menu (see Section 4.4.3), Memory Channel screen (see Table 4-1), and DTMF Autodial screen (see Table 4-3).

PMR - Selects PMR (European) models. Selecting this model displays unique parameters for programming a 5-tone option. As with the LMR selection, unique parameters are displayed in the Screen menu and Memory Channel and DTMF Autodial screens.

Display Type - Select the color or monochrome 1 or 2 display modes.

RS-232C - Selects the computer serial port being used to connect the computer to the transceiver.

Table 4-1 Memory Channel Screen Description (LMR Models)

Parameter	Description												
<div style="display: flex; justify-content: space-between;"> File Screen Program Print Model Setup Alt:Menu F8:Copy CH F8:Copy CH </div> <div style="display: flex; justify-content: space-between;"> 585-7600-030 Rev.1.0 for EFJohnson(R)7600 Series LMR Ent:Inp/Se1 Ins:Insert CH F9:Paste CH F9:Paste CH </div> <div style="display: flex; justify-content: space-between;"> Del:Delete CH </div>													
CH No.	CH Atr	Frequency (MHz) RX	TX	CTCSS/DTCS RX	TX	Text	TOT	RF PWR	Lock -out	Scan 12345	Auto Reset	2Tone	Log IN/OFF
1	A	151.62500n	<-			Grp 01		H		12345	Tim-B		
2	E	151.49000n	<-	88.5	<-	Grp 02		L1		(12345)	Tim-B		
3	B	158.58000	<-	91.5	<-	Grp 03		L2		12__5	Tim-B		
4		162.40000	Inhibit					H		(____)	Tim-B		
5													
6													
7													
8													
9													
10													
11													
12													
13													
14													
15													
16													
												F1:Help	

NOTE: To display this part of the screen, scroll over using the → arrow key.

Bank Select

Up to 32 channels or two banks of 16 channels can be programmed. To program the channels as two banks, first program the “MR-CH Bank/Free” parameter in the Key and Display Assign screen for “Bank” as described in Table 4-2. In addition, a “Bank” option switch must be programmed in this screen to select banks. To switch between banks when programming channels, press the PgUp/PgDn keys.

Table 4-1 Memory Channel Screen Description (LMR Models) (Continued)

Parameter	Description
Ch Atr (Channel Attribute)	<p>Press (Enter) to display the menu which selects one of the following choices:</p> <p>A: Priority A - The channel is selected when the Prio A key is pressed, and it is monitored during priority scan. In addition, the microphone hanger can be programmed so that this channel is automatically selected whenever an off-hook condition occurs (see Table 4-2).</p> <p>B: Priority B - The channel is quick selected when the Prio B key is pressed. It is not monitored during priority scan.</p> <p>E: Emergency Channel - Transmission occurs on the channel when the Emergency switch is pressed.</p> <p>Emergency Off - Deletes the emergency designation on current channel if applicable. If no emergency channel is designated, transmission occurs on the currently selected channel.</p> <p>SmarTrunk II™ On/Off - Toggles the SmarTrunk function on and off on the bank. This function is not available with this transceiver.</p> <p>Channel Insert - Inserts a blank channel by pushing the other channel information down one line.</p> <p>Channel Delete - Deletes the programming information on the current line and moves the channel information below it up one line.</p> <p>Return - Exits the menu and returns to the main screen.</p>
Frequency (Rx/Tx)	<p>Enter the desired frequency for the channel. Enter a frequency within the frequency range of the transceiver: VHF = 136-155 or 146-174 MHz, UHF = 400-430, 450-470, 470-490, or 488-512 MHz. Channel steps in multiples of 5.0, 6.25, or 7.5 kHz only. If no receive frequency is entered, no other data can be programmed on the line. Other special functions associated with frequency are as follows:</p> <p>Rx Freq - Press the backspace key to toggle between wide and narrowband. Narrowband is indicated by “n” to the right of the frequency. Press the spacebar to toggle receive inhibit on and off indicated by “i” to the left of the frequency. This limits the channel to priority or emergency use only (it is not available as a regular channel).</p> <p>Tx Freq - To enter the same frequency as the receive frequency, enter nothing or “=”. The “←” symbol means same as receive frequency. Enter a space to disable transmitting on the channel (“Inhibit” is then displayed). F8 and F9 can be used to cut and paste frequencies. Press (Enter) when the desired frequency has been entered.</p>
CTCSS/DTCS (Rx/Tx)	<p>Enters the receive and transmit tone (CTCSS) Call Guard® frequency or digital (DTCS) Call Guard code. Press (Enter) to display the tone selection table. Select a tone by scrolling to it and pressing (Enter). Press the spacebar or backspace key to increase or decrease the entered frequency. The “←” symbol means same as receive code.</p> <p>The length of the CTCSS reverse burst can be set by the “CTCSS Reverse Burst” parameter on the Common Screen (see Table 4-7). A non-standard CTCSS tone from 60.1 to 300.1 Hz can be specified on the Expert screen and then selected by “USER”. If a CTCSS tone is selected by the TONE option switch, it overrides the channel programming until “TON--M” is reselected.</p> <p>Digital codes <u>must</u> always be entered directly (there is no table) and tone frequencies <u>can</u> be entered directly. Be sure to enter the tone decimal point or the number is interpreted as a digital code. To toggle the polarity of digital codes, press the spacebar or backspace key. The N or I indicates Normal or Inverted polarity. In addition, the polarity of digital Call Guard signaling for all channels is set on the Expert screen.</p>
Text	<p>Programs the 7-character alpha tag that is displayed when a channel is selected. If no text is programmed, the channel number is displayed as CH-xx. Allowable characters are A-Z (upper or lower case), 0-9, ' * , + \$ ' () - / < = > ? @ [\] _ { } ~. However, some characters, especially lower case letters, may be difficult to see. The tx up arrow is displayed by “:”, and the rx down arrow by “;”. Special characters may be programmed in the Expert screen (see Table 4-8) and used for the positions 3-7 only (positions 1 and 2 can display only regular characters). To enter a special character, press PgUp/PgDn to scroll through and select characters A-P.</p>
TOT (Time-Out Timer)	<p>Disables the transmitter on that channel if it is keyed continuously for longer than the programmed time. The times for this timer and other related functions are programmed in the Common Screen (see Table 4-7).</p>

Table 4-1 Memory Channel Screen Description (LMR Models) (Continued)

Parameter	Description
RF PWR	Programs the RF power output for the channel (High, Low1, Low2). This setting can be temporarily or permanently overridden by the HIGH, LOW1, or LOW2 power option switch if it is programmed (see Table 4-2).
Lockout	<p>Transmit Disable On Busy. The following conditions can be programmed:</p> <p>Off - No restrictions; the transmitter can be keyed even while receiving a signal.</p> <p>Busy - Transmitting is inhibited if the channel is busy (carrier present).</p> <p>Repeater 1 - Transmission is permitted only when (1) receiving a signal on the programmed Call Guard tone or code (CTCSS/ DCTS) or (2) when no carrier is being detected.</p> <p>Repeater 2 - Transmission is permitted when (1) receiving any Call Guard tone or code (CTCSS/DCTS) or (2) when no carrier is being detected.</p> <p><i>NOTE: If an attempt is made to transmit in a lockout condition, transmitting is inhibited for the "Lockout Penalty Time" programmed on Common screen (see Table 4-7).</i></p>
Scan	Assigns the channel to up to five scan lists and also programs if the scan list status can be changed by the scan list programming key (TAG). Press the spacebar to enter or delete all lists or press 1-5 to toggle the status of a list. Press the backspace key to toggle the inhibit status. Scan list programming is inhibited when parentheses are displayed around the numbers (or underline characters).
Auto Reset	If PWR ON Scan is enabled in the Scan screen (see Table 4-5), this selects the time delay before scanning resumes after a call is complete (the signal disappears) or a key is pressed. Either Timer A or Timer B can be selected. These timers are programmed in the Common Screen (see Table 4-7). Auto reset can be turned off by setting the timer to "Off" (0).
2-Tone	Enables 2-tone operation on the channel and specifies the 2-tone code used. The 2-tone codes are programmed in the 2-Tone Code Ch screen (see Table 4-6). This requires the optional 2/5-tone module.
Log On/Off	<p>Specifies if the DTMF ID code is transmitted when the PTT switch is pressed and released. The DTMF code is specified on the Log/ID line of the DTMF Autodial screen (Table 4-3). In the Common screen, if "TOT Timer ID Out" is "Yes", this ID is also transmitted just before the transmitter is disabled by the time-out timer. The following conditions can be programmed:</p> <p>OFF (blank) - No ID code is transmitted.</p> <p>Log In - The ID code is transmitted when the PTT switch is pressed.</p> <p>Log Off - The ID code is transmitted when the PTT switch is released.</p> <p>Both - The ID code is transmitted when the PTT switch is pressed and again when it is released.</p>

Table 4-2 Key and Display Assign Screen Description

Key & Display Assign	
Key Assign (Up)	CH Up
(Down)	CH Down
(F1)	Scan A Start/Stop
(F2)	Scan Add/Del(Tag)
(F3)	Light
(F4)	Moni
Hanger Action	Moni Scan PrioA
Beep ON/OFF	OFF
Light	ON
RF PWR Selection	MR CH Individual
MR-CH Bank/Free	Free
Opening Text	Mobile1

KEY ASSIGN PARAMETERS

The ▲ ▼ and F1-F4 option keys can be programmed for the following functions. Press the (Enter) key and then PgUp/PgDn to display and then select the desired function.

Parameter	Key Label	Description
Null	---	No function (key disabled).
CH Up CH Down	CH UP CH DN	Scroll up or down through the programmed channels. Holding the key down causes the function to repeat.
MR-CH 1 MR-CH 2 MR-CH 3 MR-CH 4	CH 1 CH 2 CH 3 CH 4	Directly selects Channels 1, 2, 3, or 4, respectively.
Bank	BANK	Toggles the current bank between Bank 1 and Bank 2. This key can be programmed only if the “MR-CH Bank/Free” parameter in this screen is programmed “Bank”.
Scan A Scan B Start/Stop	SCAN	Pressing this key toggles scanning on and off. In addition, pressing and holding the key enables the scan list select mode. The current scan list is indicated, and it is changed by pressing the up/down ▲ ▼ keys. Either the Scan A or Scan B mode or both can be programmed. Operation is as follows: Scan A Power-On Scan “Off” (see Table 4-5) - It starts and stops scanning with no auto restart. If the transmitter is keyed during scanning, the scan mode is exited. Power-On Scan “On” - It stops scanning only until the Auto Reset Timer expires (see Table 4-7). If the transmitter is keyed during scanning, scan automatically resumes when the Auto Reset Timer expires. Scan B Power-On Scan “Off” or “On” - It starts and stops scanning with auto restart. If the transmitter is keyed during scanning, scan automatically resumes when the Auto Reset Timer expires.
Scan Add/ Delete	TAG	Scan list programming key. Pressing this key changes the scan list status of the current channel in the current scan list (see Section 3.6.2).
Prio A Prio A (Re) Prio B	PRI A PRI A PRI B	Pressing a Prio A key selects the Priority A channel, and pressing a Prio B key selects the Priority B channel. Pressing a Prio A (Rewrite) key also selects the Priority A channel. In addition, if it is held, the current channel is made the Priority A channel. Priority channel sampling is programmed in the Scan List screen (see Table 4-5).
Moni (Audi)	MONI	Toggles the monitor mode on and off. This mode deactivates the Call Guard (CTCSS/DTCSS) or 2-tone mute functions (see Section 3.4.4). Pressing and holding this key unquelsches the receiver for as long as it is held.

Table 4-2 Key and Display Assign Screen Description (Continued)



Parameter	Key Label	Description
RF ATT	ATT	Toggles the receive attenuate function on and off (see Section 3.5.13).
Lock	LOCK	Locks/unlocks all programmable keys except CALL, MONI, and EMER to prevent them from being accidentally pressed (see Section 3.5.9).
Beep	BEEP	Toggles the key beep function on and off (see Section 3.3.10).
Light	LITE	Turns the LCD backlight on and off (see Section 3.3.9).
Bank Up		Selects the other bank of sixteen channels if applicable.
High Low 1 Low 2	HIGH LOW1 LOW2	Changes the power output for the current channel to the level programmed of the key. Pressing the key again reselects the preprogrammed power level for the channel. The change may be temporary or permanent for that channel depending on the programming of the "RF PWR Selection" parameter later in this screen (see description which follows).
C. Tone CH Ent	TONE	(Continuous Tone Memory Channel) This key selects the continuous tone mode which allows the Call Guard (CTCSS) tone to be selected from the front panel (see Section 3.5.5). These tones are programmed by the Continuous Tone screen described in Table 4-4.
Talk Around	TA	Toggles the talk-around mode on and off (see Section 3.5.16).
Wide/ Narrow	W/N	Temporarily toggles between the wide and narrow band modes (see Section 3.5.19). When the channel is changed or power is cycled, the wide/narrow mode programmed for the channel frequency specified in the memory Channel screen is again selected.
DTMF Autodial	DTMF	Pressing this key enables the DTMF autodial mode. After pressing this key, the number to be dialed is selected by the up/down   keys. Then press and hold this key to transmit the number (see Section 3.5.7). The available DTMF numbers are programmed by the DTMF Autodial screen described in Table 4-3.
Emergency Single Repeat	EMER	Pressing this key transmits an emergency call. If "Single" is programmed, it is transmitted only once; if "Repeat" is programmed, it is transmitted repeatedly with LMR models, or until the proper 5-tone code is received with PMR models. The emergency channel is specified by the CH Atr parameter on the Memory Channel screen described in Table 4-1. A DTMF code is transmitted if it is entered on the "Emergency" line of the DTMF Autodial screen (see Table 4-3). Additional emergency parameters are programmed in the Expert screen described in Table 4-8.
OPTx Out OPTx Mom Out	OPT1 OPT2 OPT3	A "OPT1-OPT3 Out" key switches the respective pin of the 30-pin option connector high or low (this connector is located inside the transceiver, and is used, for example, by the optional 2/5-tone module). A "OPT1-OPT3 Momentary Out" key produces a high or low pulse on the respective pin of this 30-pin connector.
Call	CALL	When equipped with the optional 2/5-tone module, transmits the 2-tone or 5-tone code.
Call A/B	CALL	PMR mode w/5-tone option only. Transmits code using channel 30 (A) or 29 (B).
Tx Code/ CH Up/Dn	TX CH	PMR mode w/5-tone option only. Selects transmit 5-tone code.
ID MR Select	ID MR	PMR mode w/5-tone option only. Recalls and erases stored codes that have been received
Trunking Group Switch	GRP	This switch is for a SmarTrunk function, so it is not available with this transceiver.
OTHER MENU PARAMETERS		
Hanger Action		Any or none of the following hanger functions can be programmed: Monitor - Disables CTCSS/DCTS Call Guard signaling on off-hook and re-enables it when back on-hook. Scan - Automatically enables scanning when placed on-hook. Prio A - Automatically selects the priority A channel when taken off-hook.
Beep On/ Off		Enables or disables the key press beep. This programming can be overridden by the power-on menu (see Section 3.3.4) or BEEP key (see Section 3.3.10).

Table 4-2 Key and Display Assign Screen Description (Continued)

Parameter	Description
Light	Enables or disables the display and key backlight. This programming can be overridden by the power-on menu (see Section 3.3.4) or LITE key (see Section 3.3.9). The “Auto” configuration allows it to be controlled by pin 1 of the DB9 connector on the optional accessory cable. The on condition is selected by 0 volts (low) and off by 12 volts (high).
RF Power Selection	This can be programmed for one of the following configurations: MR CH Individual - The power output selected by the HIGH, LOW1, LOW2 keys (see preceding description) is only temporary. Power returns to the level programmed for the channel when the channel is changed or transceiver power is cycled. Override - The power output selected by above power keys overrides the channel programming. The selected level is permanent on the channel (changing the channel or cycling power does not change the selected power level). Pressing the key again on the channel reselects the preprogrammed level.
MR-CH Bank/Free	Free - Select if banks are not used. One block of up to 32 channels is programmed. Bank - Select if channels are to be programmed as two banks with up to 16 channels each. The BANK option switch must be programmed to select the banks (see Section 3.3.7).
Opening Text	If text is entered, it is displayed and a tone sounds for 2 seconds when power is turned on. If no text is programmed, no tone sounds and no message is displayed. The characters and other information described for “TEXT” in Table 4-1 also applies to this text.

Table 4-3 DTMF Autodial Screen Description

	
<p>This screen is used to program the DTMF autodial codes that can be transmitted by pressing the DTMF key (see Table 4-2). Each location can contain up to 16 characters. Allowable characters are 0-9, A-D, *, and #. Press the INS key to toggle between the insert and overwrite modes. To clear a location, press the spacebar and then (Enter). Press ALT or ESC to cancel the entered codes before input. The code on the “Emergency” line is transmitted when the Emergency key is pressed (see Table 4-2). Likewise, the code on the “Log/ID” line is transmitted when the Log/ID channel parameter is enabled (see Table 4-1) and when the time-out timer expires (see Table 4-7). With PMR models, “4” and “5” are displayed in place of “Emergency” and “Log/ID”.</p>	
Parameter	Description
DTMF Timer	Sets the time interval in seconds for each code emission and interval.
1st Timer	Sets the tone period in seconds for the first DTMF code. This period is affected by the scanning period and power saver function delays of receiving transceivers.
[*] [#] Timer	Sets the tone period in seconds for the * character (same as “E”) and # (same as “F”). These codes can be used for control codes on some systems. <i>NOTE: When these special codes are used for the first code, the “1st Timer” has priority over this setting.</i>

Table 4-4 Continuous Tone Screen Description

Continuous Tone		
No.	RX	TX
Tone 1	123.0	<-
2	177.3	<-
3	88.5	123.0
4	124N	<-
5	167N	<-
6		
7		
8		
9		

Description

The continuous tones programmed in this screen are selected by pressing the C.Tone CH Ent function key (see Table 4-2) and then pressing the up/down ▲ ▼ keys. This allows the user to select the continuous tone being transmitted and received on the current channel. To transmit or receive using the codes programmed for the channel in the channel screen (see Table 4-1), select “TON--M” using the ▲ ▼ keys.

Table 4-5 Scan Function Screen Description

Scan Mode List / Text	
List 1	M2(Prio-A) Pri Scn ON
2	M3(Prio-A) PriScn ON
3	M1(Normal) Std Scn ON
4	M1(Normal) Std Scn ON
5	Scn Off ON

Stop Timer	5.000
Resume Timer	3.000
Power ON Scan	OFF
Auto CH Call	OFF

Parameter	Description
	This screen is used to configure each of the up to five scan lists that can be selected. Channels are assigned to a scan list in the Memory Channel screen described in Table 4-1 and by the TAG key described in Table 4-2. Scanning is turned on and off and a specific scan mode is selected by the SCAN key also described in Table 4-2. Scanning may be enabled at power on (see following) and by placing the microphone on-hook (see “Hanger Action” in Table 4-2).
Scan Mode	The following conditions are programmable: Scan Off - Deactivates that scan list so that it cannot be selected. M1 (Normal) - Selects normal (non-priority) scanning from the lowest to highest channel. M2 (Prio A) - Selects scanning from the lowest to highest channel while checking the Priority A channel. If scanning is turned off while receiving a message in the scan mode, the transceiver switches to that channel. M 3 (Prio A) - Same as Mode 2 except that if scanning is turned off while receiving a message, the Priority A channel is selected.
Text	Programs the text that is displayed while scanning with that scan list selected. If “OFF” is programmed, the text is not displayed. Instead, the alpha tag (or channel number) programmed for each channel is displayed as the channel is scanned. The characters and other information described for “TEXT” in Table 4-1 also applies to this text.

Table 4-5 Scan Function Screen Description (Continued)

Parameter	Description
Stop Timer	When Mode 2 or 3 above is programmed (priority scanning), this sets how often in seconds the priority channel is checked while receiving a message on some other channel.
Resume Timer	This sets the scan resume delay in seconds. This is the time that elapses before scanning resumes after a message is received.
PWR ON Scan	If this function is programmed "On", scanning starts automatically when transceiver power is turned on. The "Hanger Action" parameter in Table 4-2 should also be programmed for "Scan" if power-on scan is used. If scanning halts to transmit a message, the timer selected for Auto Reset parameter in the channel screen (see Table 4-1) determines the delay before scanning resumes. See also Scan A/B function in Key Assign screen (Table 4-2), "Scan" column in 2-Tone Code CH screen (Table 4-6), "Timer A/B" in Common screen (Table 4-7), and "Fast/Slow Scan Timer" in Expert screen (Table 4-8).
Auto CH Call	The parameter is displayed only in the PMR (European) mode, and is used with the 5-tone option. If "On" is programmed, pressing the CALL key (1) starts scanning, (2) detects a non-busy channel, and (3) transmits the 5-tone codes.

Table 4-6 2-Tone Code Channel Screen Description

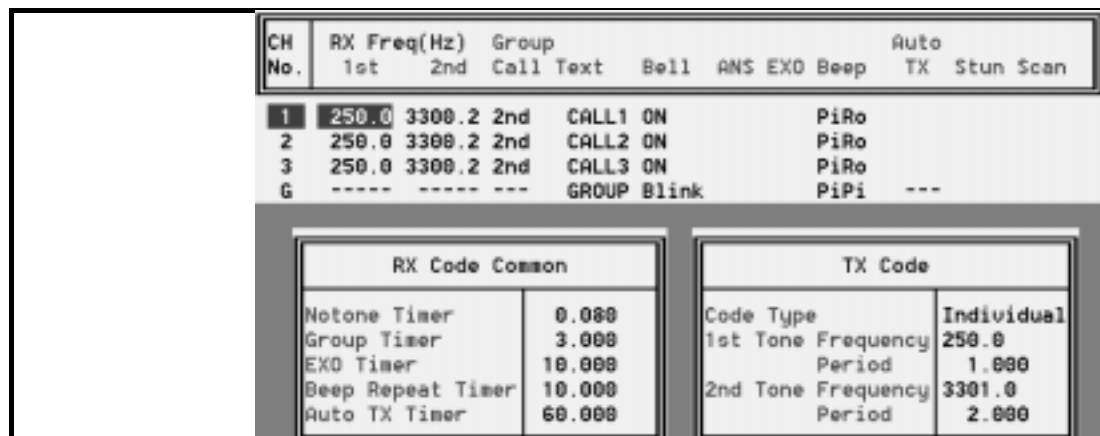
Parameter	Description
 <p>The screenshot shows a channel list with columns: CH No., RX Freq(1st/2nd), Group, Call Text, Bell, ANS, EXO, Beep, and Auto TX/Scan. Channel 1 is selected. Below are two sub-screens: 'RX Code Common' with settings for Notone Timer (0.000), Group Timer (3.000), EXO Timer (10.000), Beep Repeat Timer (10.000), and Auto TX Timer (60.000); and 'TX Code' with settings for Code Type, 1st Tone Frequency (250.0), 1st Tone Period (1.000), 2nd Tone Frequency (3301.0), and 2nd Tone Period (2.000).</p>	
Rx Freq 1st/2nd	Sets the frequencies for the first and second tones from 250-3300 Hz. The closest tone is selected.
Group Call	Programs if the 1st or 2nd tone is used for the group code.
Text	Programs the text that is displayed when a matched 2-tone is received. The characters and other information described for "TEXT" in Table 4-1 also applies to this text.
Bell	Selects the bell indicator condition when receiving a matched 2-tone. The following conditions can be programmed: Null - The bell indicator condition is not changed, even when a matched code is received. Off - The bell indicator goes off. On - The bell indicator appears until a key is pressed. Blink - The bell indicator blinks until a key is pressed.
ANS	Turns the Answer Back function on and off. This function transmits a 1 kHz single tone for 2 seconds when receiving a matched 2-tone code.
EXO	"On" activates an external alert such as a horn or buzzer when a matching 2-tone code is received. The activation time is set by "EXO Timer" in the Rx Code Common screen (see below). The optional accessory cable is required to utilize this feature.

NOTE: Optional 2/5-Tone Module, P.N. 585-7500-026, is required to utilize the two-tone feature.

Table 4-6 2-Tone Code Channel Screen Description (Continued)

Parameter	Description
Beep	Emits (or turns off) the following beeps when receiving a matched 2-tone: Null - Beep emission (or non-emission) is retained even when receiving a matched 2-tone. Off - Repeater beep emission is turned off. Pi (Single) - One high beep once. PiPi (Single) - Two high beeps once. PiRo (Single) - One high and one low beep three times. Pi (Repeat) - One high beep repeated at selected intervals. PiPi (Repeat) - Two high beeps repeated at selected intervals.
Auto Tx	Sets the transceiver to the transmit condition (by activating the microphone PTT) when receiving a matched 2-tone code. This transmit time can be set in the Auto Tx Timer parameter in the Rx Code Common screen (see below).
Stun	When a matched 2-tone is received, the transceiver is set to the following condition that is programmed: Off - The transceiver can be used continuously. Kill - The transceiver cannot be used. Reprogramming is required to re-activate the transceiver. Stun - The power-on password prompt is displayed. To use the transceiver, the correct password must be entered. See also "User Password" and "Pwr On Password" in Common screen (Table 4-7). Password entry is required regardless of the Pwr On Password setting.
Scan	When a matched 2-tone is received, scan is set to the following condition that is programmed: Null - Scan condition is not affected. Cancel - Scan is cancelled. Start - Scan is started. See also "Scan" key in Table 4-2 and "Power On Scan" in Table 4-5.
Parameter	Description
Rx Code Common Screen	
Notone Timer	This item sets the acceptable period between 2 tones. When received tones are interrupted for longer than this setting, the transceiver does not detect the code.
Group Timer	Programs the 2-tone decoding period in seconds. When the received tone is longer than this setting, the transceiver detects the tone as a group code.
EXO Timer	When the EXO function is programmed "On" (see EXO above), the horn drive out pin of the optional accessory cable is grounded for this period when receiving a matched 2-tone code.
Beep Repeat Timer	When "Repeat" is selected for the above "Beep" parameter, beeps are repeated at this period in seconds.
Auto Tx Timer	When the Auto TX function above is programmed "On", the transceiver transmits for this set period when receiving a matched 2-tone code.
Tx Code Screen	
Code Type	Selects the "Individual" or "Group" code type.
1st/2nd Tone Frequency	Sets the frequencies for the first and second tones from 250-3300 Hz. The closest tone is selected.
1st/2nd Tone Period	Sets the period of the first and second tones.

Table 4-7 Common Screen Description

Common 1		Common 2	
User Password	1234	PWR ON Password	OFF
Clone Comment (1)	Acme Gravel	Dealer Passcode	159357
(2)	Mobile 1	Set Mode Access	Enable
AF min Level	0	Transceiver Data Out	Inhibit
SQL Level	0		
RX AF Switch(Low cut)	OFF		
Auto Reset Timer A	30.000		
Auto Reset Timer B	OFF		
Inactive Timer	-----		
TOT Timer	30.000		
Penalty Timer	20.000		
ID Out (DTMF)	OFF		
Beep	OFF		
Lockout Penalty Timer	5.000		
CTCSS Reverse Burst	0.300		

Parameter	Description
User Password	Programs the password that must be entered at power on if the following “PWR ON Password” parameter is “On” or to cancel the “STUN” condition described in Table 4-6. Any four-digit number from 0000-9999 can be programmed. The password is entered as described in Section 3.3.2.
Program Comment	Allows a comment to be programmed in the file for use in quickly identifying the contents of a transceiver. When a transceiver is connected to the computer, the comment can be checked without reading all programmed data by selecting “Information” in the Program menu (see Section 4.4.4).
AF Min Level	Sets the minimum audio level that can be selected by the user. The level can be set in 32 steps with 0 the lowest level. This setting can be overridden by pressing the F1 in the power-on menu (see Section 3.3.4).
SQL Level	Sets the squelch level in up to 255 steps (0 sets the maximum unsquelched level). This adjustment can be more accurately made by pressing F4 in the power-on menu (see Section 3.3.4).
Rx AF Switch	This parameter can be used to disable the high-pass filter that removes the Call Guard (CTCSS/DTCS) signal from the audio. It should be programmed “On” if Call Guard squelch is used.
Auto Reset Timer A/B	These timer settings are used by the “Auto Reset” parameter in the channel screen (see Table 4-1). These times set the delay in returning to the mute mode or “Power On Scan” after receiving a message or pressing a key. To disable the Auto Reset function, set one of these timers to “Off” (0) and select it in the channel screen.
Inactive Timer	This feature is available with the PMR (European) mode only. It sets the time in seconds to return to the “Inaudible” mode after the “Audible” mode is selected. To turn off the inactive timer function, do not assign “Inactive” in the channel screen.
TOT Timer	Programs the time-out timer time in seconds. If the transmitter is keyed continuously for longer than this time, the transmitter is disabled. The time-out timer is enabled or disabled for each channel by the TOT parameter in the channel screen (see Table 4-1).
TOT Penalty Timer	This programs the time in seconds that the transmitter is disabled by the time-out timer. The transmitter cannot be keyed again until this time expires.
TOT ID Out	If this parameter is enabled, an DTMF ID code is automatically transmitted just before the time-out timer disables the transmitter. This ID code is set on the Log/ID line of the DTMF Autodial screen (see Table 4-3).
TOT Beep	If this parameter is enabled, warning beeps are transmitted 10 seconds before time out occurs.
Lockout Penalty Timer	This is the time that the transmitter is disabled if the user attempts to transmit while in the lockout (Transmit Disable On Busy) condition. Transmitting is disabled for the Lockout Penalty Time even if the lockout condition is cleared. The lockout feature is programmed on the channel screen (see Table 4-1).
CTCSS Reverse Burst	If CTCSS (tone Call Guard) signaling is programmed on the channel, this sets the length of the reverse burst that is transmitted when the PTT switch is released. The reverse burst prevents the “squelch tail” (noise burst) in the transceiver receiving the signal.

Table 4-7 Common Screen Description (Continued)

Parameter	Description
Power On Password	This turns the password function on and off. When it is turned on, "PWoRd" is displayed when power is turned on and a four-digit password must be entered to enable the transceiver (see Section 3.3.2). The password is programmed in "User Password" above. If the STUN function disables the transceiver (see Table 4-6), password input is required even if this parameter is programmed "Off".
Dealer Passcode	Specifies the six-digit code that must be entered to access the following dealer set mode.
Set Mode Access	This enables/disables the Dealer Set Mode which allows one transceiver to clone another with identical information. If the transceiver will not be used for cloning, the dealer set mode is not used and this parameter should be programmed "Inhibit".
Transceiver Data Out	Enables or inhibits the downloading of transceiver programming data using the programming software or when programming one transceiver with another (cloning). This prevents the unauthorized duplication of programming data. This does not inhibit overwriting of programming data, so reprogramming is still possible with this enabled.

Table 4-8 Expert Screen Description

Parameter	Description
	
Fast Scan Timer	Sets the period in seconds that each channel not programmed for CTCSS/DTCS (Call Guard) squelch is scanned. <i>NOTE: An appropriate time is set by default and if a time less than the default is programmed, busy channels may not be detected.</i>
Slow Scan Timer	Sets the period in seconds that each channel programmed for CTCSS/DTCS (Call Guard) squelch is scanned. <i>NOTE: An appropriate time is set by default and if a time less than the default is programmed, busy channels may not be detected.</i>
Tx DTCS Inverse	Selecting "Inverse" selects the opposite transmit digital DTCS (Call Guard) code polarity specified for the channel (see Table 4-1) and selecting "Normal" does not change that setting. For example, if the channel is programmed "I" (inverse), selecting "Inverse" here results in "Normal" DTCS. For DTCS signaling to work properly, the polarity of the code in the transmitting and receiving transceivers must be the same.
Rx DTCS Inverse	Functions the same as the preceding "Tx DTCS Inverse" parameter to change the receive DTCS polarity.
User CTCSS Freq.	A non-standard CTCSS (Call Guard) tone from 60.1-300.1 Hz can be programmed. It is then selected by programming "USER" for the CTCSS code in the channel screen (see Table 4-1).

Table 4-8 Expert Screen Description (Continued)

Parameter	Description
Emer Sw On Timer	Sets the period in seconds that the Emergency function key must be pressed to activate the emergency function. An emergency call is initiated by pressing the Emergency key for longer than this time.
Emer Sw Off Timer	Sets the period in seconds that the Emergency function switch must be pressed to cancel an emergency call. This must be done before the call is transmitted because once it is transmitted, it cannot be canceled.
Emer Start/Repeat	Programs the delay and interval period in seconds for emergency calls. When the emergency switch is pressed and held, the emergency call is transmitted after this delay period. If the Emergency Repeat function key is programmed (see Table 4-2), the transceiver then transmits repeatedly at this interval until an "Emergency Cancel" code is received.
Rx EXO	Sets the condition of the horn output (pin 6) of the optional accessory cable in the receive mode. OFF = Horn drive control out, ON = Send (to ground when signal is received). One use of the "ON" condition may be for some type of simplified repeater system.
Rx EXO PTT	When Rx EXO is programmed "On", pin 6 of the optional accessory cable is grounded for this period when receiving a signal. Normally this parameter is set to "0".
EXPTT Delay Timer	Sets the period that the transmitter stays on after the receive signal disappears.
Tone Mute EXPTT	Enables or disables the CTCSS/DTCS (Call Guard) function with an external PTT signal. "On" disables and "Off" enables CTCSS/DTCS.
Low Beep Frequency	Sets the low beep tone frequency for 400 - 2998 Hz. The nearest available frequency is automatically selected.
High Beep Frequency	Sets the high beep tone frequency for 400 - 2998 Hz. The nearest available frequency is automatically selected.
Character Editor	Special characters can be designed using this function by enabling the available 14 segments in any combination desired. The special characters created then can be entered when programming the "Text" parameters in the various screens. Up to 16 characters can be programmed and stored in locations A-P. To enter a special character when programming text, press the PgUp or PgDn keys to scroll through and select the desired character. Special characters can be displayed in positions 3-7 (1 and 2 must be standard characters).

4.5 UNIQUE PMR (EUROPEAN) SCREENS

4.5.1 GENERAL

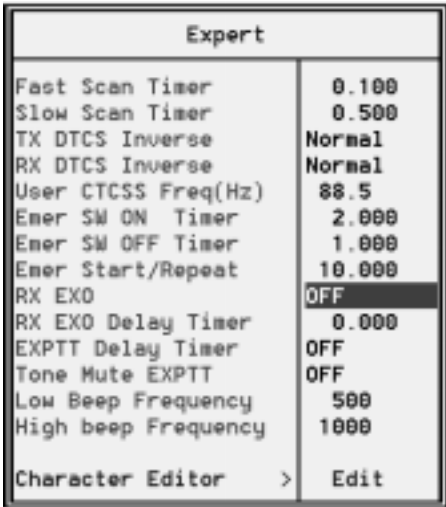
Selecting LMR or PMR in the Model menu (see Section 4.4.6) affects what parameters are displayed in some screens and also what additional screens are displayed. Basically, selecting the LMR (U.S.A.) model displays parameters for the 2-tone option, and selecting PMR (European) displays parameters for the 5-tone option.

NOTE: Optional 2/5-Tone Kit, Part No. 585-7500-026, is required to have the 5-tone function.

4.5.2 UNIQUE PMR SCREENS

The following menus and screens are different for LMR and PMR models:

Screen Menu - The LMR menu is described in Section 4.4.3, and the PMR version is shown below.

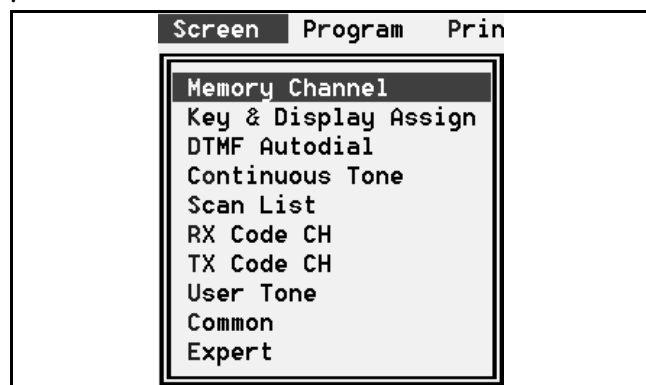

Memory Channel Screen - The LMR version of this screen is shown in Table 4-1, and the PMR version is shown in Figure 4-2. Refer to on-line help for information on unique PMR parameters (press F1 with the parameter highlighted).

The following screens selected in the preceding Screen menu are unique to PMR models. Refer to on-line help for information on parameters in these screens.

Rx Code Channel - This screen is shown below and it programs the receive 5-tone code information.

CH No.	RX Code	Text or ID-Deco	Bell	Emer Cancel	ABC	EXD	Beep	Auto TX	Aud Mode	Stun	Scan
1	01111	CALL1	ON				PIRo		Aud		
2	22222	CALL2	ON				PIRo		Aud		
3	33333	CALL3	ON				PIRo		Aud		
4	44444	CALL4	ON				PIRo		Aud		
5	55555	CALL5	ON				PIRo		Aud		
6	66666	CALL6	ON				PIRo		Aud		
7	77777	CALL7	ON				PIRo		Aud		
8	88888	CALL8	ON				PIRo		Aud		
9	-----	GROUP	Blink		---		PIP1		Aud		
Link R Timer		0.000		EXD Timer		10.000					
Compare Digit		12345__		Beep Repeat Timer		10.000					
ID Decode Timer		1.000		Auto TX Timer		60.000					

Tx Code Channel - This screen is shown below and it programs the transmit 5-tone code information.

CH No.	Tx Code	Input Digit	Text	Up-Data	ABC	Aud Sel	Tx Code Common	
1	01111	___45__	ON	ON			Long Tone Timer	0.700
2	22222	___45__	ON	ON			Link R Timer	0.000
3	33333	___45__	ON	ON			Link 1 Timer	0.000
4	44444	___45__	ON	ON			Link 2 Timer	0.000
5	55555	___45__	ON	ON			Lead out Delay Timer	0.100
6	66666	___45__	ON	ON			ABC Decode Timer	1.600
7	77777	___45__	ON	ON			Displayed Digit	12345__
8	88888	___45__	ON	ON			Special Tone (Group) A	
9	88888	___45__	ON	ON			Special Tone (Repeat) E	
10	00000	___45__	ON	ON			Special Tone (Link2) F	
11	00000	___45__	ON	ON			PTT Call at Inaudible	OFF
12	00000	___45__	ON	ON				
13	00000	___45__	ON	ON				
14	00000	___45__	ON	ON				
15	00000	___45__	ON	ON				
16	00000	___45__	ON	ON				

User Tone Format - This screen is shown below and it programs special tone frequencies and the 5-tone format information.



Tone No.	User Tone			Common Data			
	Encode	Decode Low	High	Format	Period	Notone Timer	Tone Length
0	1991	1941	2024	USER	0.100	0.160	0.155
1	1124	1100	1140	CCR	0.100	0.160	0.155
2	1197	1171	1222	ZUE11	0.070	0.100	0.110
3	1275	1249	1301	ZUE12	0.070	0.100	0.110
4	1350	1320	1386	SZUE1	0.070	0.100	0.110
5	1440	1417	1477	EEA	0.040	0.060	0.064
6	1540	1509	1571	EEA2	0.040	0.060	0.064
7	1639	1605	1673	SAPL	0.100	0.160	0.155
8	1747	1712	1795	ETA	0.033	0.060	0.055
9	1850	1822	1900				
A	2401	2352	2454				
B	930	911	950				
C	2246	2200	2291				
D	931	971	1012				
E	2109	2064	2154				

4.6 CLONING (PROGRAMMING ONE TRANSCEIVER WITH ANOTHER)

One transceiver can be used to program another with identical data. Replication Cable, Part No. 597-2002-200 is required to connect the transceivers together (see Table 1-1). The master (source) transceiver must have the following Common screen (see Table 4-7) parameters programmed to perform cloning:

- **Transmit Data Out = Enabled.** If this parameter is not enabled, the transceiver does not go into the clone mode. The programming of this parameter does not affect the ability to receive data. Therefore, it can be in either mode in the slave (target) transceiver.
- **Set Mode Access = Enabled.** This must be programmed to allow the Dealer Set mode to be accessed so that cloning can be enabled.
- **Dealer Passcode.** This six-digit code must be known to enable the Dealer Set mode.

Proceed as follows to program one transceiver with another:

1. Select the Dealer Set mode in the Master (source) transceiver by turning power on with the F1 and up  key pressed.
2. The display then indicates "DEALR" which is the prompt to enter the six-digit Dealer Passcode. Enter this code using the F1-F4 and down  key. The numbers represented by each key are as follows. When the correct number is entered, "SETMODE" is displayed. If six digits have been entered and this is not displayed, an incorrect number may have been entered. Repeat starting with step 1. Refer to Section 3.3.2 for more information.

Key	F1	F2	F3	F4	
Number Entered	0	1	2	3	4
	5	6	7	8	9

3. Press the F4 key to select the clone mode. The display should indicate "CLONE".

4. Connect the master transceiver to the slave (target) transceiver by plugging the cloning cable into the microphone jack of each.
5. Turn the slave transceiver on. Then momentarily press the POWER switch of the master transceiver to begin the data transfer.
6. When cloning is complete, CLONE is displayed by the master and CLONE OK by the slave.
7. To clone another transceiver, repeat this procedure starting with step 4.
8. To return both the transceivers to normal operation, reconnect the microphone and cycle power.

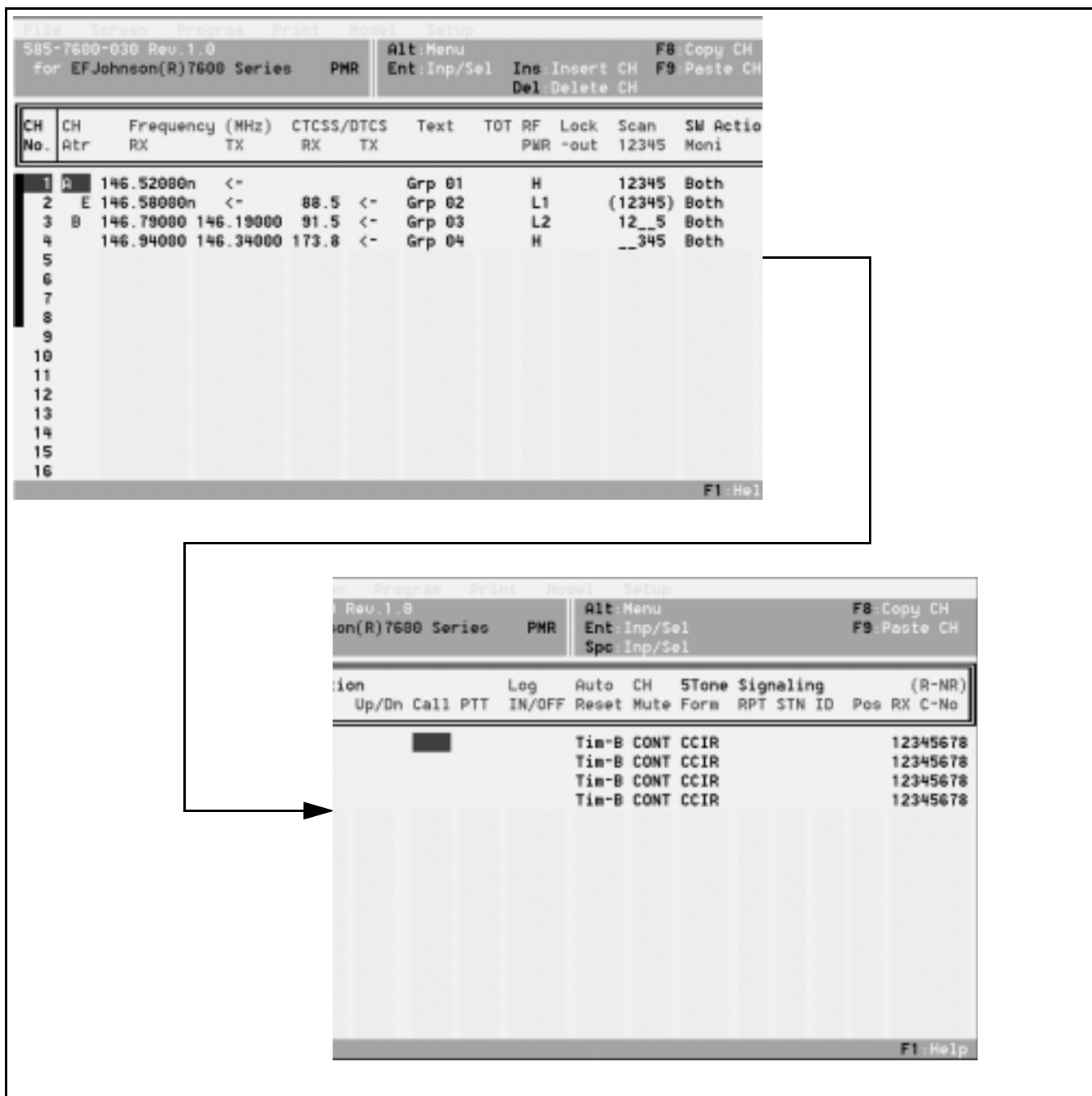

Figure 4-2 Memory Channel Screen (PMR Models)

This page intentionally left blank.

SECTION 5A VHF (7610) CIRCUIT DESCRIPTION

NOTE: A VHF transceiver block diagram is located on page 8-1.

5.1 VHF RECEIVER CIRCUIT

5.1.1 ANTENNA SWITCHING CIRCUIT

The antenna switching circuit functions as a low-pass filter while receiving and a resonator circuit while transmitting. This prevents the transmit signal from entering the receiver in the transmit mode.

Received signals enter the antenna connector and pass through a low-pass filter consisting of L1-L3, C1-C3, C8-C10, and C11-C13. The filtered signal is then fed through a quarter-wave type antenna switching circuit formed by D13, D14, and L13 and applied to the receiver RF circuit.

5.1.2 RF CIRCUIT

The RF circuit amplifies the frequencies that are within the receive band range and attenuates out-of-band signals.

The signal from the antenna switching circuit passes through attenuator D13/D14. The attenuator circuit functions only when the attenuator function is assigned to a programmable key. It is enabled to minimize RF amplifier distortion caused by excessively strong receive signals.

When the attenuator function is turned on, CPU IC1, pin 32 switches the voltage level of the "RF ATT" line from high to low and then controls the attenuator switch Q35. The D13/D14 current then increases and D13/D14 act as an attenuator.

This signal is then applied to a two-stage tunable bandpass filter controlled by D16 and D17. The filtered signals are amplified by RF amplifier Q12 and applied to another two-stage bandpass filter controlled by D18-D21. These filters attenuate unwanted signals. The filtered signal is then applied to the first mixer Q13.

The tunable bandpass filters controlled by D16-D21 employ varactor diodes to tune them to the center

frequency of the RF passband. This gives a wide bandwidth receiver good image response rejection. The diodes are controlled by the CPU IC1 via level controller IC5.

5.1.3 FIRST MIXER AND FIRST IF CIRCUITS

The first mixer circuit converts the received signal to a fixed frequency first IF signal of 31.050 MHz. The RF signal from the bandpass filter is applied to the first mixer Q13. This signal is mixed with the first LO signal from VCO Q7/Q8 and buffers Q6-Q4 to produce the IF signal.

The 31.050 MHz first IF signal then passes through a pair of crystal filters (FI1A/B) which suppress out-of-band signals. The filtered signal is then amplified by first IF amplifier Q14 and applied to second IF circuit IC3.

5.1.4 SECOND IF AND DEMODULATOR CIRCUITS

The second mixer circuit converts the 31.050 MHz first IF signal to a 450 kHz second IF signal. A double-conversion superheterodyne receiver like this improves the image rejection ratio and provides a stable receiver gain.

FM IF system IC3 contains second mixer, limiter amplifier, quadrature detector, active filter and noise amplifier circuits (see Figure 5-1). The first IF signal from IF amplifier Q14 is applied to IC3, pin 16 which is the input to the second mixer section. The 31.050 MHz first IF signal is mixed with the 30.600 MHz second LO signal to produce the 450 kHz second IF signal. The PLL reference frequency of 15.300 MHz is doubled to produce the 30.600 MHz second LO signal.

The second IF signal is fed out of IC3 on pin 3 and applied to ceramic filters FI3 and FI4 with narrow band operation or only FI4 with wideband operation (bypassing FI3). It is then fed back into IC3 on pin 5 and applied to the limiter amplifier and quadrature detector. The quadrature detector demodulates the audio signal contained in the second IF signal. Components connected to pins 10 and 11 including X3

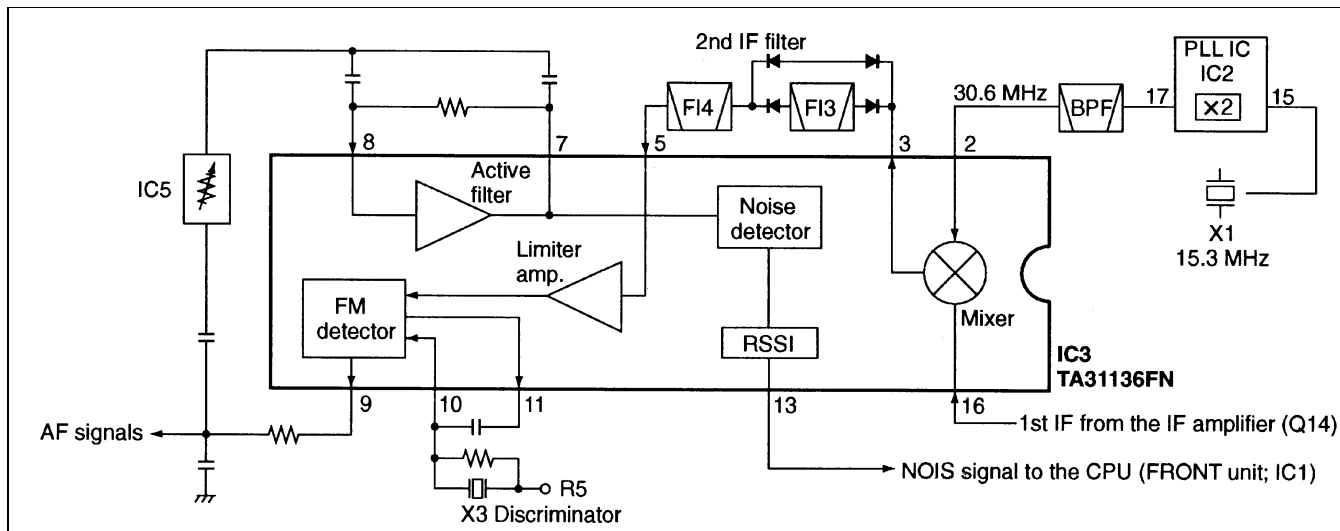

Figure 5-1 Second IF System IC3 (VHF)

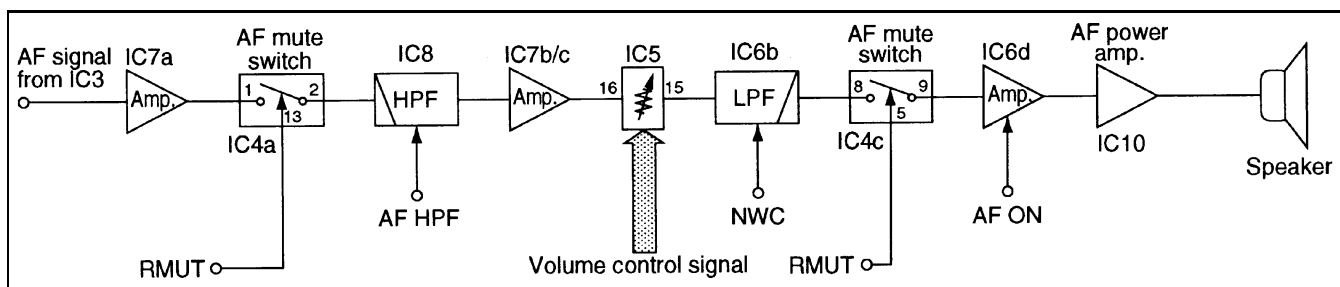

Figure 5-2 Audio Switching and Amplifier Circuit (VHF)

are part of the quadrature detector. The audio signal is fed out on pin 9 (IC3) and applied to the AF amplifier circuit.

5.1.5 AUDIO AMPLIFIER CIRCUIT

The AF (audio frequency) amplifier circuit provides drive to the speaker (a block diagram is shown in Figure 5-2). The audio signal from IC3, pin 9 is applied to AF amplifier IC7A and then fed to pin 1 of AF switching circuit IC4. The switched output signal on IC4, pin 2 is then applied to high-pass filter IC8A/B. The cut-off frequency of this filter is controlled by the "AFHPF" line. When "AFHPF" is high, the cut-off frequency is shifted higher to attenuate the Call Guard (CTCSS or DTCS) signals.

The filtered output signal on IC8, pin 7 is applied to limiter IC7b and buffer IC7c. De-emphasis is pro-

vided by R145 and C182. The audio signal is then applied to pin 16 of level controller IC5. This device allows the CPU to control the speaker volume level. The level controlled signal is fed out of IC5 on pin 15 and applied to low-pass filter IC6b. It is then applied to AF switching circuit IC4 on pin 8, and the switched output is on pin 9. This signal is buffered by IC6d and then amplified by AF amplifier IC10 to provide drive to the speaker.

5.1.6 RECEIVER MUTE CIRCUIT

Noise Squelch

The noise squelch circuit turns off the audio signal when no RF signal is being received. The squelch circuit is controlled by the amount of noise present in the audio signal.

Part of the AF signal from pin 9 of FM IF circuit IC3 is applied to pin 24 of level controller IC5. This device allows the CPU to control the squelch threshold level. The level-controlled output signal on pin 23 is applied to IC3, pin 8 which is the input of an internal filter (see Figure 5-1). Noise frequencies of about 10 kHz are passed and then fed out on pin 7 and also applied to an internal noise detector.

The detected noise signal is rectified and fed out on pin 13 without smoothing. The noise signal (NOIS) is then applied to pin 19 of CPU IC1. The CPU analyzes the noise condition and outputs the RMUT signal via I/O expander IC11. This signal controls AF mute switches IC4a and c (see Figure 5-2).

Call Guard (CTCSS/DTCS) Operation

The tone Call Guard squelch circuit detects AF signals and opens the squelch only when receiving a signal containing a matching subaudible tone or code (CTCSS or DTCS). When tone squelch is in use and a signal with a mismatched or no subaudible tone is received, the tone squelch circuit mutes the AF signals even when noise squelch is open.

A portion of the audio signal from amplifier IC7a passes through low-pass filter Q5 in the front unit to remove voice signals. It is then applied to CPU IC1 on pin 97 via the "CTCIN" line. The CPU detects the CTCSS or DTCS signaling and controls the AF mute switch via I/O expander IC11.

5.2 VHF TRANSMITTER CIRCUIT

5.2.1 MICROPHONE AMPLIFIER CIRCUIT

The microphone amplifier circuit amplifies the microphone audio signal to the level required by the modulation circuit and also provides pre-emphasis.

The microphone audio signal is amplified by IC7d, with R172 and C295 on the output providing pre-emphasis. The microphone audio signal is then fed to switch IC4 on pin 4 and the switched output signal is on pin 3. This signal is then applied to high-pass filter IC8a/b which attenuates frequencies in the Call Guard (CTCSS/DTCS) range. This is the same filter used for receive audio filtering.

The signal is then fed to IC7b and IC7c which provide buffering and amplification. Deviation limiting is then provided by level controller IC5. The input to this device is pin 16 and the output is pin 15. The signal is then fed to splatter filter IC6b and switch IC4. The input is on pin 11 and the output is on pin 10. The modulation signal is then applied to the PLL circuit as "MOD".

Narrow band/wideband switch Q21 is connected to the input of the splatter filter IC6b and switched by the "NWC" signal from the I/O expander IC11. When "NWC" is high, Q21 shifts the filter cut-off frequency for narrow band deviation selection.

5.2.2 MODULATION CIRCUIT

The microphone audio signal modulates the frequency of VCO Q7/Q8. The "MOD" signal from switch IC4, pin 10 changes the reactance of diode D9 which frequency modulates the VCO frequency. The modulated VCO signal is amplified by buffer amplifiers Q6, Q5, and Q4 and applied to the transmit driver circuit.

5.2.3 TRANSMIT DRIVER CIRCUIT

The transmit driver circuit amplifies the VCO oscillating signal to the level required by the power amplifier module. The RF signal from buffer amplifier Q4 passes through the T/R switch D5 and is amplified by the buffer-amplifiers Q3 and Q2 and driver Q1. The signal is then applied to the power amplifier module IC1.

5.2.4 POWER AMPLIFIER MODULE

The power amplifier module amplifies the driver signal to the output power level. The RF signal from the driver Q1 is applied to the power module which produces 45 watts of output power at the antenna jack.

The amplified signal is fed through antenna switching circuit D3 and D4, a low-pass filter and APC detector, and is then applied to the antenna jack. The collector voltage of driver Q1 and the control voltage on pin 2 of the power module IC1 come from APC transistors Q17 and Q18. Transmit switch Q23 turns off Q17 and Q18 when the transmitter is disabled.

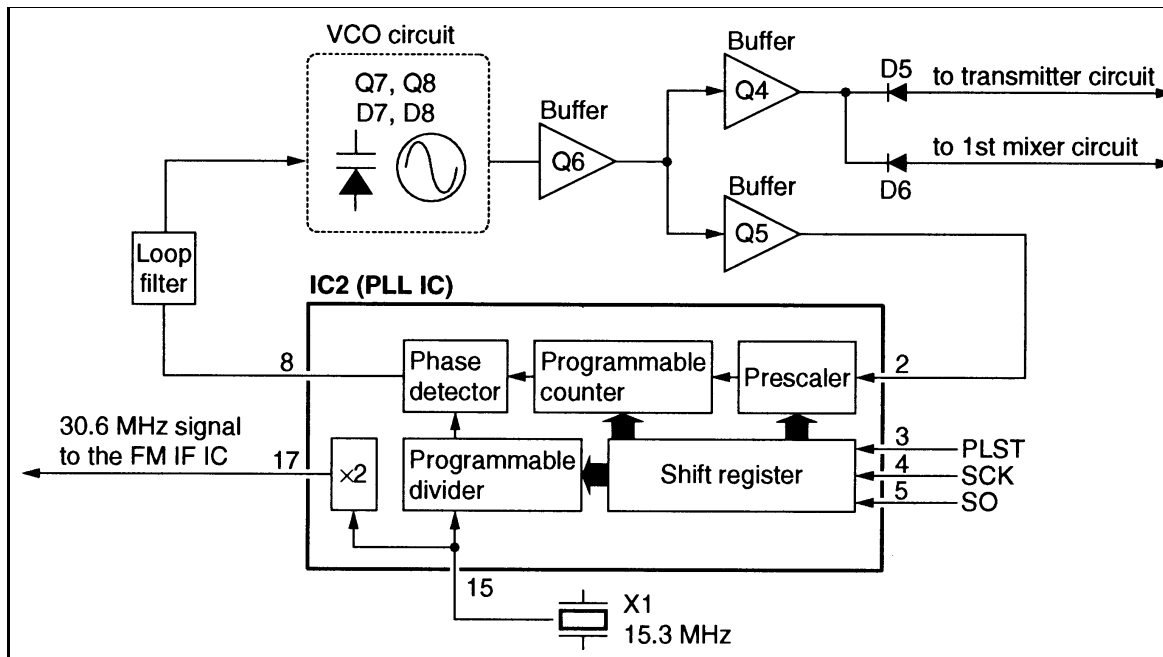

Figure 5-3 PLL Circuit (VHF)

5.2.5 APC CIRCUIT

The APC (Automatic Power Control) circuit protects the power amplifier from damage caused by a mismatched antenna load, and provides a stable power output.

Detector D2 detects forward signals, and D1 detects reverse signals. The combined voltage is at minimum level when a matched antenna load of 50 ohms is present and then increases as it becomes mismatched. The detected voltage is applied to pin 9 of inverse amplifier IC6c. Power setting voltage T4 is applied to the other input (pin 10) as a reference.

When antenna impedance is mismatched, the detected voltage exceeds the power setting voltage. The output voltage on pin 8 then decreases which turns Q18 off slightly. Q17 then turns off slightly and lowers the voltage applied to the collector of Q1 and the power control input of IC1. This reduces the output power produced by these devices.

5.3 VHF PLL CIRCUIT

5.3.1 PLL CIRCUIT

The PLL (Phase-Locked-Loop) circuit provides a stable (± 5 PPM) receive first injection and transmit frequency. The PLL circuit consists of PLL circuit IC2, a loop filter, and reference oscillator. A block diagram of the PLL circuit is shown in Figure 5-3.

The signal from VCO (Voltage-Controlled Oscillator) Q7/Q8 is buffered by Q6 and Q5 and then applied to pin 2 of IC2. The prescaler in IC2 divides the VCO signal down so that it is within the frequency range of the programmable counter.

A reference frequency generated by reference oscillator and controlled by crystal X1 is applied to pin 15 of IC1. This signal is divided down by a programmable divider and provides the reference input to the phase detector. When the VCO is oscillating at the correct frequency, the VCO-derived input to the phase detector is the same frequency as the reference input.

The phase detector determines the phase difference between these signals and then produces output pulses on pin 8 which are filtered by the loop filter. This filter consists of R43-R45, C60, and C61. The output of this filter is the DC control voltage applied to the VCO. The phase detector increases or decreases this control voltage to change the VCO frequency.

5.3.2 VCO CIRCUIT

The VCO signal is amplified by buffer amplifiers Q6 and Q4 and is then applied to T/R switch D5 and D6. The VCO receive injection signal is applied to first mixer Q13 via bandpass filter L23, L24, and C116-C118. Likewise, the VCO transmit signal is applied to driver Q1 via buffer amplifiers Q2 and Q3. Part of the Q6 output signal is fed back to PLL IC2 as described in the preceding section.

5.4 VHF IC PIN DESCRIPTIONS

5.4.1 VHF POWER SUPPLY

Line	Description
VCC	Unswitched input voltage to the transceiver.
HV	VCC supply voltage switched by Q25 and Q26. When the [POWER] switch is pressed, the CPU outputs the "PWON" control signal to this circuit to turn the HV supply on.
CPU5V	Common 5V supply for the CPU produced from the VCC supply by CPU5V regulator IC9. The circuit outputs this voltage regardless of the transceiver on-off condition.
8V	Common 8V supply produced from the HV supply by 8V regulator Q36.
5V	Common 5V supply produced from the VCC supply by 5V regulator Q29/Q30.
R5	Receive 5V supply produced by R5 regulator Q27 using the "T5C" signal from I/O expander IC11.
T5	Transmit 5V supply controlled by T5 regulator Q28 using the "T5C" signal from I/O expander IC11.

5.4.2 VHF CPU IC1 PORT ALLOCATION

Pin No.	Port Name	Description
1	VIN	Input port for overvoltage detection from the vehicle power source.
12	SCK	Outputs clock signal to EEPROM IC3, PLL IC2 (main unit) and expanders IC5, IC11 (main unit), etc.
13	SI	Input port for the data signal from EEPROM IC3, etc.
14	SO	Outputs data signal to EEPROM IC3, PLL IC2 (main unit) and expanders IC5, IC11 (main unit).
16	CLIN	Input port for cloning signal.
17	CLOUT	Output port for cloning signal.
18	POSW	Input for the POWER switch. Low = POWER switch pushed.
19	NOIS	NOIS signal input port from the FM IF IC3 (main unit) for noise squelch operation.
26	PTT	Input port for the PTT switch. Low = PTT switch pushed.
32	RFATT	Outputs RF attenuator control signal to the attenuator switch (Q35 on main unit). Low = Attenuator function on.
36	UNLK	Input port for PLL unlock signal from the PLL IC2 (main unit). High = unlock.
37	PWON	Outputs control signal for the power switching circuit (Q25 on main unit) and 5V regulator Q29, Q30 (main unit).
38	DIM	Outputs control signal for LCD backlight. Low = LCD backlight on.
39	EXTPTT	Input port for the PTT switch from external connector J3 (main unit). Low = External PTT switch on.
40	DIM	Input port for the LCD backlight control signal from external connector J3 (main unit). Low = External dimmer switch on.
41	PLST	Outputs strobe signals for PLL IC2 (main unit).
42	DAST	Outputs strobe signals for level controller IC5 (main unit).
43	EXST	Outputs strobe signals for the I/O expander IC11 (main unit).
45, 46	KS1, KS2	Output ports for the key matrix.
47-50	KR3-KR10	Input ports for the key matrix.

Pin No.	Port Name	Description
51	BM	Outputs control signal for beep mute circuit Q10. High = Beep muted.
52-54	CTDA0-CTDA2	Output port for CTCSS/DTCS signals.
55	HANG	Input port for the microphone hanger detection signal. Low = Microphone on hook.
90	MTONE	Output port for beep audio while receiving and 2/5 tone signals while transmitting.
91	TONED	Outputs DTMF signals.
94-96	OPV3-OPV1	Input port for option connector J2 state (main unit).
97	CTCIN	Input port for the CTCSS/DTCS IN decode signals.
98	SD	Input port for S-meter signal.
99	LVIN	Input port for PLL lock voltage.
100	TEMP	Input port for the transceiver's internal temperature.

5.4.3 VHF I/O EXPANDER IC5 (MAIN UNIT)

Pin No.	Port Name	Description
2, 3, 10	T1-T3	Output tunable bandpass filter control signals.
11	T4	Output port for tunable bandpass filter control signal while receiving and power control signal while transmitting.
14	REF	Output port for reference frequency control voltage.

5.4.4 VHF PORT EXPANDER IC11 (MAIN UNIT)

Pin No.	Port Name	Description
4	T5C	Outputs control signal for T5 and R5 regulator circuits Q27, Q28 (main unit). High = Transmitting.
5	TMUT	Outputs Tx mute switch Q19, Q23 (main unit) control signal. High = Tx muted.
6	RM	Outputs AF mute switch IC4 (main unit) control signal for the receiver circuit. High = No receive audio is emitted.
7	MM	Outputs MIC mute control signal. High = DTMF signals are output, etc.
11	HORNO	Outputs external device control signal. High = Matched 2/5-tone signals are received.
12	AFON	Outputs control signal for the AF amplifier regulator circuit. High = Squelch is open, etc.
13	AFHPF	Outputs AF filter control signal. High = Filter out CTCSS or DTCS frequency.
14	NWC	Outputs receive/transmit passband width control signal. High = Narrow bandwidth is selected.

SECTION 5B UHF (7640) CIRCUIT DESCRIPTION

NOTE: The UHF transceiver block diagram is located on page 8-6.

5.5 UHF RECEIVER CIRCUIT

5.5.1 ANTENNA SWITCHING CIRCUIT

The antenna switching circuit functions as a low-pass filter while receiving and a resonator circuit while transmitting. This prevents the transmit signal from entering the receiver in the transmit mode.

Received signals enter the antenna connector and pass through a low-pass filter consisting of L1-L3, C1, C2, and C9-C12. The filtered signal is then fed through a quarter-wave type antenna switching circuit formed by D4, D5, and L15 and applied to the receiver RF circuit.

5.5.2 RF CIRCUIT

The RF circuit amplifies the frequencies that are within the receive band range and attenuates out-of-band signals.

The signal from the antenna switching circuit passes through attenuator D4/D5. The attenuator circuit functions only when the attenuator function is assigned to a programmable key. It is enabled to minimize RF amplifier distortion caused by excessively strong receive signals.

When the attenuator function is turned on, CPU IC1, pin 32 switches the voltage level of the "RF ATT" line from high to low and then controls the attenuator switch Q1. The D4/D5 current then increases and D4/D5 act as an attenuator.

This signal is then applied to a two-stage tunable bandpass filter controlled by D7 and D8. The filtered signals are amplified by RF amplifier Q2 and applied to another two-stage bandpass filter controlled by D9 and D10. These filters attenuate unwanted signals. The filtered signal is then applied to the first mixer Q3.

The tunable bandpass filters controlled by D7-D10 employ varactor diodes to tune them to the center frequency of the RF passband. This gives a wide bandwidth receiver good image response rejection. The diodes are controlled by the CPU IC1 via level controller IC12.

5.5.3 FIRST MIXER AND FIRST IF CIRCUITS

The first mixer circuit converts the received signal to a fixed frequency first IF signal of 46.350 MHz. The RF signal from the bandpass filter is applied to the first mixer Q3. This signal is mixed with the first LO signal from VCO Q23 and buffers Q28 and Q30 to produce the IF signal.

The 46.350 MHz first IF signal then passes through a pair of crystal filters (FI1A/B) which suppress out-of-band signals. The filtered signal is then amplified by first IF amplifier Q4 and applied to second IF system IC1.

5.5.4 SECOND IF AND DEMODULATOR CIRCUITS

The second mixer circuit converts the 46.350 MHz first IF signal to a 450 kHz second IF signal. A double-conversion superheterodyne receiver like this improves the image rejection ratio and provides a stable receiver gain.

FM IF system IC1 contains second mixer, limiter amplifier, quadrature detector, active filter and noise amplifier circuits (see Figure 5-4). The first IF signal from IF amplifier Q4 is applied to IC1, pin 16 which is the input to the second mixer section. The 46.350 MHz first IF signal is mixed with the 45.900 MHz second LO signal to produce the 450 kHz second IF signal. The PLL reference frequency of 15.300 MHz is tripled to produce the 45.900 MHz second LO signal.

The second IF signal is fed out of IC1 on pin 3 and applied to ceramic filters FI2 and FI3 with narrow band operation or only FI2 with wideband operation (bypassing FI3). It is then fed back into IC1 on pin 5

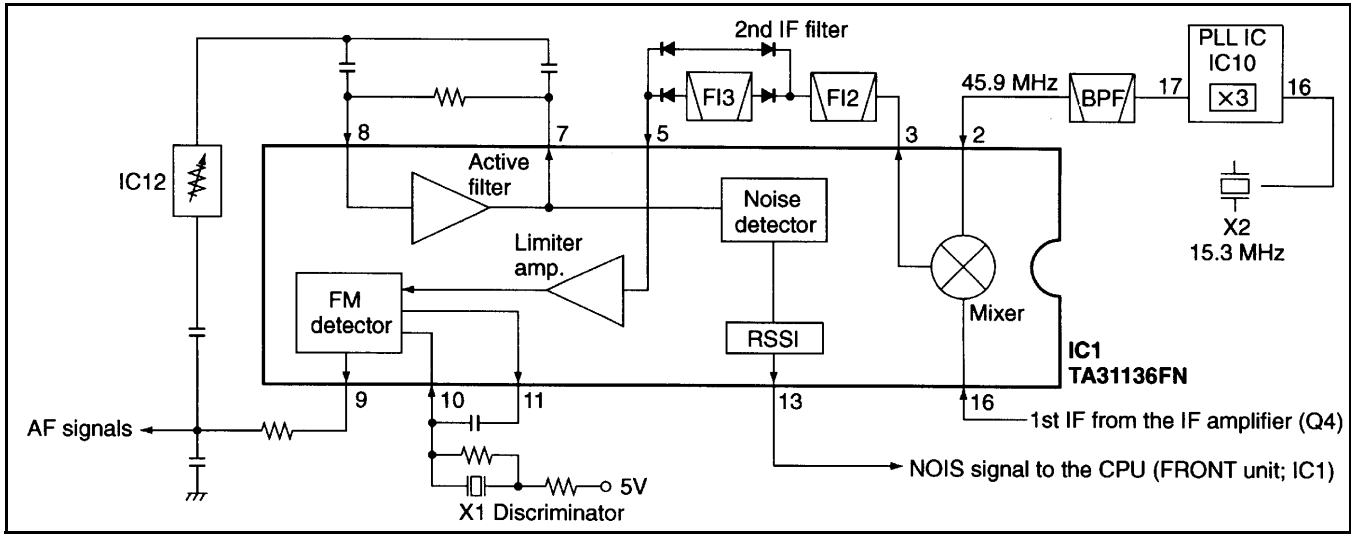

Figure 5-4 Second IF System IC1 (UHF)

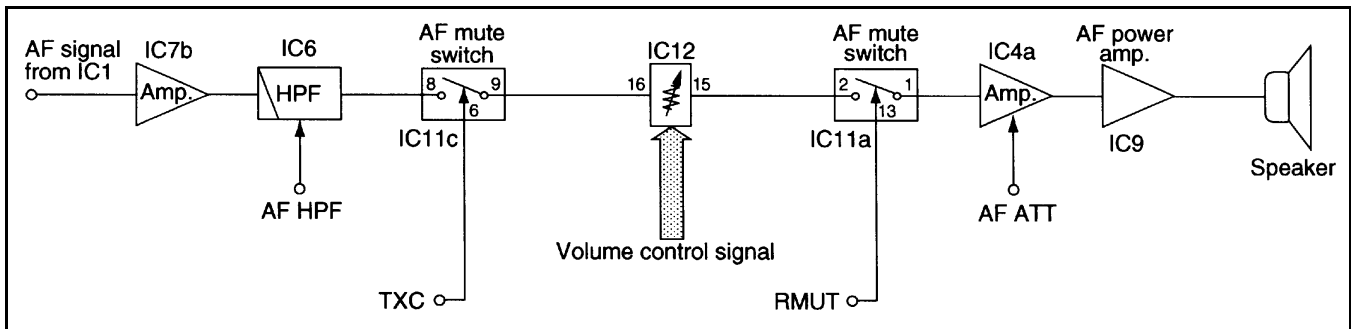

Figure 5-5 Audio Switching and Amplifier Circuit (UHF)

and applied to the limiter amplifier and quadrature detector. The quadrature detector demodulates the audio signal contained in the second IF signal. Components connected to pins 10 and 11 including X1 are part of the quadrature detector. The audio signal is fed out on pin 9 (IC1) and applied to the AF amplifier circuit.

5.5.5 AUDIO AMPLIFIER CIRCUIT

The AF (audio frequency) amplifier circuit provides drive to the speaker (see block diagram in Figure 5-5). The audio signal from IC1, pin 9 is applied to AF amplifier IC7b and then fed to high-pass filter IC6c/IC6d. The cut-off frequency of this filter is controlled by the “AFHPF” line. When “AFHPF” is high, the cut-off frequency is shifted higher to attenuate the Call Guard (CTCSS or DTCS) signals.

The filtered output signal on IC6d, pin 14 is applied to pin 8 of AF switching circuit IC11. The switched output signal on IC11, pin 9 is then applied to pin 16 of level controller IC12. This device allows the CPU to control the speaker volume level. The volume controlled output on pin 15 is then applied to pin 2 of AF switching circuit IC11. The switched output on pin 1 is applied to pin 4 of de-emphasis circuit IC4a. The signal is then amplified by IC9 to provide drive to the speaker.

5.5.6 RECEIVER MUTE CIRCUIT

Noise Squelch

The noise squelch circuit turns off the audio signal when no RF signal is being received. The squelch circuit is controlled by the amount of noise present in the audio signal.

Part of the AF signal from pin 9 of FM IF circuit IC1 is applied to pin 24 of level controller IC12. This device allows the CPU to control the squelch threshold level. The level-controlled output signal on pin 23 is applied to IC1, pin 8 which is the input of an internal filter (see Figure 5-4). Noise frequencies are passed and then fed out on pin 7 and also applied to an internal noise detector.

The detected noise signals are rectified and fed out on pin 13 without smoothing. The noise signal (NOIS) is then applied to pin 19 of CPU IC1. The CPU analyzes the noise condition and outputs the RMUT signal via I/O expander IC13. This signal controls AF mute switch IC11a (see Figure 5-5).

Call Guard (CTCSS/DTCS) Operation

The tone Call Guard squelch circuit detects AF signals and opens the squelch only when receiving a signal containing a matching subaudible tone or code (CTCSS or DTCS). When tone squelch is in use and a signal with a mismatched or no subaudible tone is received, the tone squelch circuit mutes the AF signals even when noise squelch is open.

A portion of the audio signal from amplifier IC7b passes through low-pass filter Q5 in the front unit to remove voice signals. It is then applied to CPU IC1 on pin 97 via the "CTCIN" line. The CPU detects the CTCSS or DTCS signaling and controls the AF mute switch via I/O I/O expander IC13.

5.6 UHF TRANSMITTER CIRCUIT

5.6.1 MICROPHONE AMPLIFIER CIRCUIT

The microphone amplifier circuit amplifies the microphone audio signal to the level required by the modulation circuit and also provides pre-emphasis.

The microphone audio signal is amplified by IC8b and limited by IC8a. Pre-emphasis is provided by R152 and C180. The signal is then fed to splatter filter IC7a and then to pin 11 of switching circuit IC11.

The output signal from IC11 on pin 10 is fed to pin 16 of level controller IC12. This device provides deviation control and is also used in the receive mode to provide volume control. The level controlled output on pin 15 is fed to pin 3 of switching circuit IC11. The switched output (MOD) on pin 4 is then applied to the PLL circuit (D21) where it frequency modulates the transmit signal.

Narrow band/wideband switch Q35 is connected to the input of the splatter filter IC7a and switched by the "NWC" signal from the I/O expander IC13. When "NWC" is high, Q35 shifts the filter cut-off frequency for narrow band deviation selection.

5.6.2 MODULATION CIRCUIT

The microphone audio signal modulates the frequency of transmit VCO Q25. The "MOD" signal from switch IC11, pin 4 changes the reactance of diode D21 and this modulates the frequency of transmit VCO Q25. The modulated VCO signal is amplified by buffer amplifiers Q28 and Q30 and applied to the transmit driver circuit (Q21).

5.6.3 TRANSMIT DRIVER CIRCUIT

The transmit driver circuit amplifies the VCO oscillating signal to the level required by the power amplifier module. The RF signal from buffer amplifier Q30 passes through the T/R switch D18 and is amplified by the buffer amplifiers Q21, Q20, and driver Q19. The signal is then applied to the power amplifier module IC5.

5.6.4 POWER AMPLIFIER MODULE

The power amplifier module amplifies the driver signal to the output power level. The RF signal from the driver Q19 is applied to the power module which produces 35 watts of output power at the antenna jack.

The amplified signal is fed through antenna switching circuit D3, a low-pass filter and APC detector, and is then applied to the antenna jack. The collector voltage of driver Q19 and the control voltage on pin 2 of the power module IC5 come from APC transistors Q17 and Q18. Transmit switch Q16 turns off Q17 and Q18 when the transmitter is disabled.

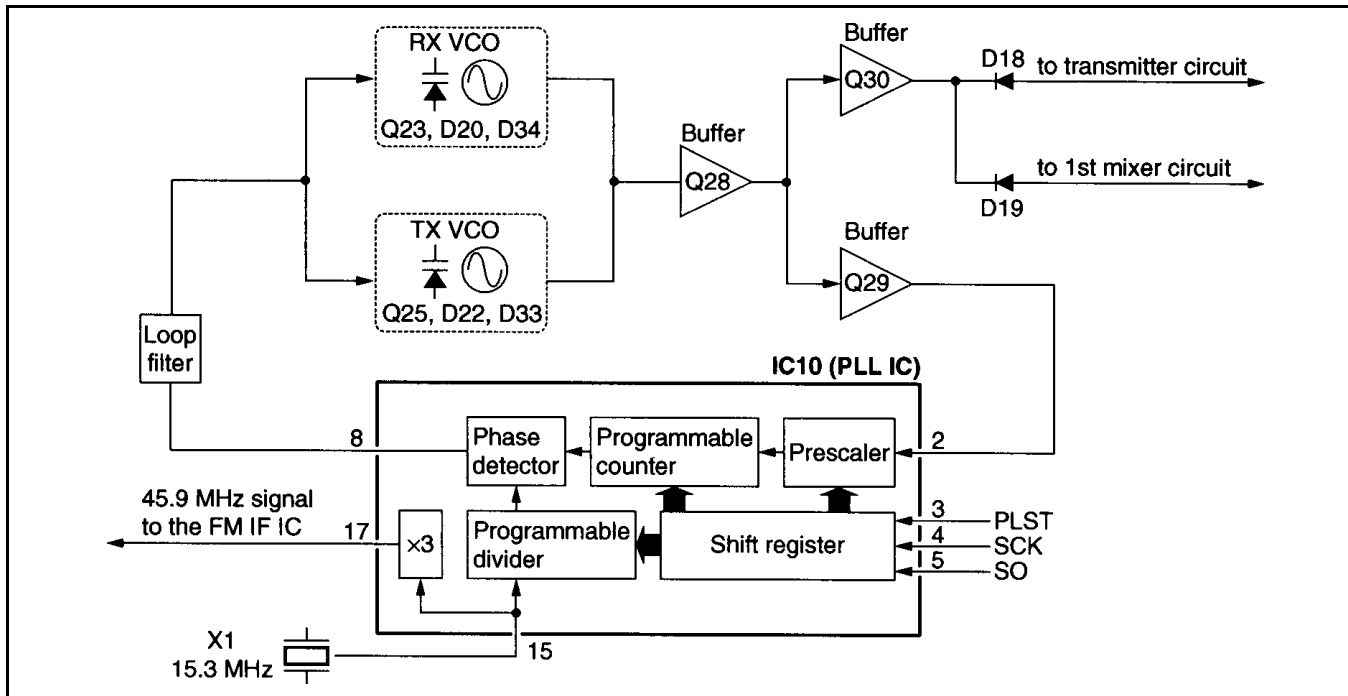

Figure 5-6 PLL Circuit (UHF)

5.6.5 APC CIRCUIT

The APC (Automatic Power Control) circuit protects the power amplifier from damage caused by a mismatched antenna load, and provides a stable power output.

One diode in D1 detects forward signals and the other detects reverse signals. The combined voltage is at minimum level when a matched antenna load of 50 ohms is present and then increases as it becomes mismatched. The detected voltage is applied to pin 6 of inverse amplifier IC4b. Power setting voltage T4 is applied to the other input (pin 5) as a reference.

When antenna impedance is mismatched, the detected voltage exceeds the power setting voltage. The output voltage on pin 7 then decreases which turns Q17 off slightly. Transistor Q18 then turns off slightly and lowers the voltage applied to the collector of Q19 and the power control input of IC5. This reduces the output power produced by these devices.

5.7 UHF PLL CIRCUIT

5.7.1 PLL CIRCUIT

The PLL (Phase-Locked-Loop) circuit provides a stable (± 2.5 PPM) receive first injection and transmit frequency. The PLL circuit consists of PLL circuit IC2, a loop filter, and reference oscillator. A block diagram of the PLL circuit is shown in Figure 5-6.

The signal from VCOs (Voltage-Controlled Oscillator) Q23 and Q25 is buffered by Q28 and Q29 and then applied to pin 2 of IC10. The prescaler in IC10 divides the VCO signal down so that it is within the frequency range of the programmable counter.

A reference frequency generated by reference oscillator X2 is applied to pin 15 of IC1. This signal is divided down by a programmable divider and provides the reference input to the phase detector. When the VCO is oscillating at the correct frequency, the VCO-derived input to the phase detector is the same frequency as the reference input.

The phase detector determines the phase difference between these signals and then produces output pulses on pin 8 which are filtered by the loop filter. This filter consists of Q34, R180, R181, and C202-C204. The output of this filter is the DC control voltage applied to the VCO. The phase detector increases or decreases this control voltage to change the VCO frequency.

5.7.2 VCO CIRCUIT

Separate receive and transmit VCOs are used. The receive VCO consists of Q23/D20/D34 and the transmit VCO consists of Q25/D22/D33. The signal from these VCOs is amplified by buffer amplifiers Q28 and Q29 and is then applied to T/R switch D18 and D19. The VCO receive injection signal is applied to first mixer Q3, and the VCO transmit signal is applied to driver Q21. Part of the Q28 output signal is amplified by Q29 and fed back to PLL IC10, pin 2 as described in the preceding section.

5.7.3 UHF POWER SUPPLY

Line	Description
VCC	Unswitched input voltage to the transceiver.
HV	VCC supply voltage switched by Q14 and Q15. When the [POWER] switch is pressed, the CPU outputs the "PWON" control signal to this circuit to turn the HV supply on.
CPU5V	Common 5V supply for the CPU produced from the VCC supply by CPU5V regulator IC3. The circuit outputs this voltage regardless of the transceiver on-off condition.
8V	Common 8V supply produced from the HV supply by 8V regulator IC2.
5V	Common 5V supply produced from the HV supply by 5V regulator Q12/Q13.
R8	Receive 8V supply produced by R8 regulator Q10/Q11 using the "TXC" signal from I/O expander IC13.
T8	Transmit 8V supply controlled by T8 regulator Q8/Q9 using the "TMUT" signal from I/O expander IC13.

5.7.4 UHF CPU IC1 PORT ALLOCATION

Pin No.	Port Name	Description
1	VIN	Input port for overvoltage detection from the vehicle power source.
12	SCK	Outputs clock signal to EEPROM IC3, PLL IC10 (main unit) and expanders IC12, IC13 (main unit), etc.
13	SI	Input port for the data signal from EEPROM IC3, etc.
14	SO	Outputs data signal to EEPROM IC3, PLL IC10 (main unit) and expanders IC12, IC13 (main unit).
16	CLIN	Input port for cloning signal.
17	CLOUT	Output port for cloning signal.
18	POSW	Input for the POWER switch. Low = POWER switch pushed.
19	NOIS	NOIS signal input port from the FM IF IC1 (main unit) for noise squelch operation.
26	PTT	Input port for the PTT switch. Low = PTT switch pushed.
32	RFATT	Outputs RF attenuator control signal to the attenuator switch (Q1 on main unit). Low = Attenuator function on.
36	UNLK	Input port for PLL unlock signal from the PLL IC10 (main unit). High = unlock.
37	PWON	Outputs control signal for the power switching circuit (Q14/Q15 on main unit).
38	DIM	Outputs control signal for LCD backlight. Low = LCD backlight on.
39	EXTPTT	Input port for the PTT switch from external connector J5 (main unit). Low = External PTT switch on.
40	DIM	Input port for the LCD backlight control signal from external connector J5 (main unit). Low = External dimmer switch on.
41	PLST	Outputs strobe signals for PLL IC10 (main unit).
42	DAST	Outputs strobe signals for level controller IC12 (main unit).
43	EXST	Outputs strobe signals for the I/O expander IC13 (main unit).
45, 46	KS1, KS2	Output ports for the key matrix.
47-50	KR3-KR10	Input ports for the key matrix

Pin No.	Port Name	Description
51	BM	Outputs control signal for beep mute circuit Q10. High = Beep muted.
52-54	CTDA0-CTDA2	Output port for CTCSS/DTCS signals.
55	HANG	Input port for the microphone hanger detection signal. Low = Microphone on hook.
90	MTONE	Output port for beep audio while receiving and 2/5 tone signals while transmitting.
91	TONED	Outputs DTMF signals.
94-96	OPV3-OPV1	Input port for option connector J4 state (main unit).
97	CTCIN	Input port for the CTCSS/DTCS IN decode signals.
98	SD	Input port for S-meter signal.
99	LVIN	Input port for PLL lock voltage.
100	TEMP	Input port for the transceiver's internal temperature.

5.7.5 UHF I/O EXPANDER IC12 (MAIN UNIT)

Pin No.	Port Name	Description
2, 3, 10	T1-T3	Output tunable bandpass filter control signals.
11	T4	Output port for tunable bandpass filter control signal while receiving and power control signal while transmitting.
14	REF	Output port for reference frequency control voltage.

5.7.6 UHF PORT EXPANDER IC13 (MAIN UNIT)

Pin No.	Port Name	Description
4	TXC	Outputs control signal for R8 regulator Q10/Q11 (main unit). High = Transmit mode.
5	TMUT	Outputs control signal for T8 regulator Q8/Q9 (main unit). High = Transmitter off.
6	RM	Outputs AF mute switch IC11(main unit) control signal for the receiver circuit. High = No receive audio is emitted.
7	MM	Outputs MIC mute control signal. High = DTMF signals are output, etc.
11	HORNO	Outputs external device control signal. High = Matched 2/5-tone signals are received.
12	AFON	Outputs control signal for the AF amplifier regulator circuit. High = Squelch is open, etc.
13	AFHPF	Outputs AF filter control signal. High = Filter out CTCSS or DTCS frequency.
14	NWC	Outputs receive/transmit passband width control signal. High = Narrow bandwidth is selected.

SECTION 6 ADJUSTMENT PROCEDURE

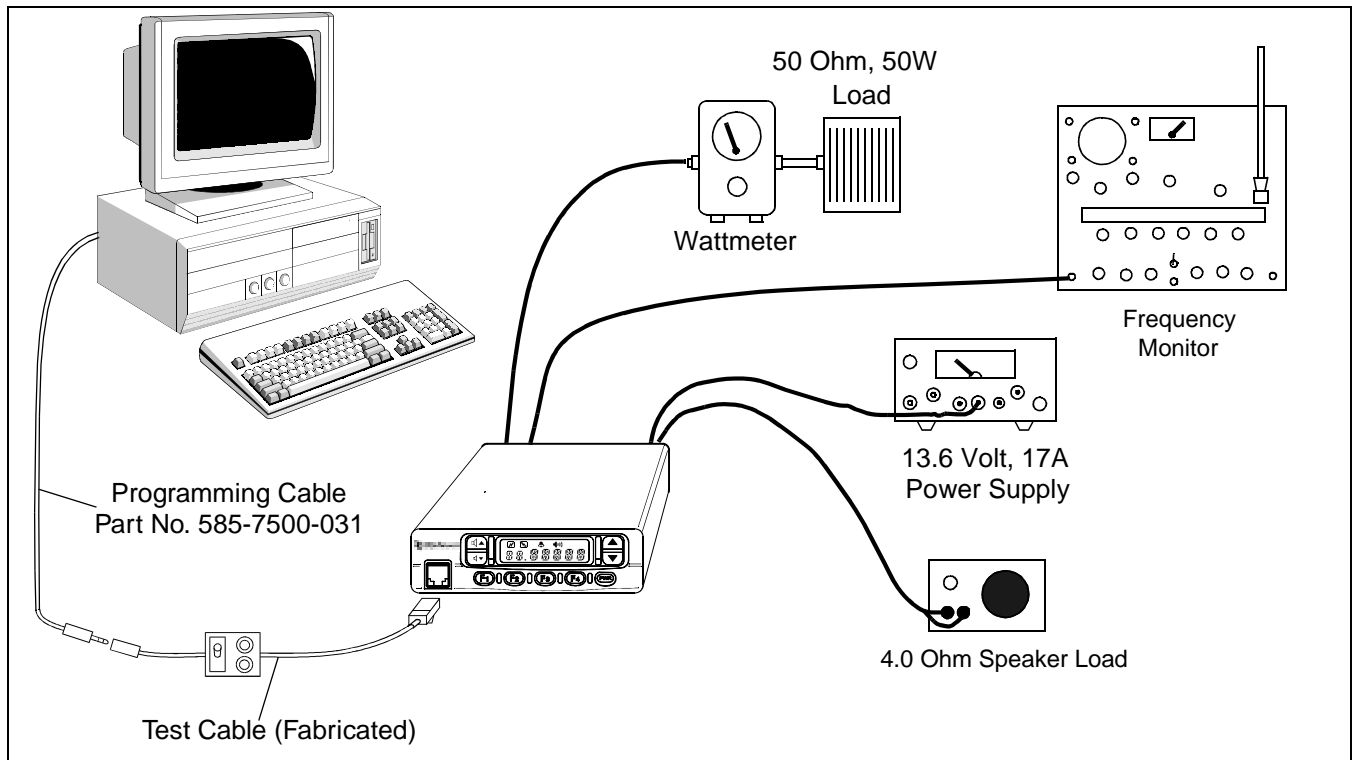

Figure 6-1 Test Setup

6.1 GENERAL

6.1.1 SUGGESTED TEST EQUIPMENT

The equipment that should be used to adjust this transceiver is listed in the following table.

Equipment	Grade and Range	
DC power supply	Output voltage	13.6 VDC
	Current capacity	15A
RF power meter	Measuring range	1-50 W
	Freq range	146-512 MHz
	Impedance	50 ohms
	SWR	Less than 1.2:1
Frequency counter	Freq range	0.1-500 MHz
	Freq accuracy	± 1 ppm or better
	Sensitivity	100 mV or better

Equipment	Grade and Range	
FM deviation meter	Freq range	DC-520 MHz
	Measuring range	0 to ± 10 kHz
Audio generator	Freq range	67-3000 Hz
	Output level	1-500 mV
Attenuator	Power atten.	50 or 60 dB
	Capacity	50W
Standard Signal Generator (SSG)	Freq range	146-520 MHz
	Output level	0.1 μ V-32 mV (-127 to -17 dBm)
DC voltmeter	Input impedance	50k Ω /V DC or better
Oscilloscope	Freq range	DC-20 MHz
	Measuring range	0.01-20V
AC millivoltmeter	Measuring range	10 mV - 10V
External Speaker	Input Impedance	4 Ω
	Power Capacity	5 watts min.

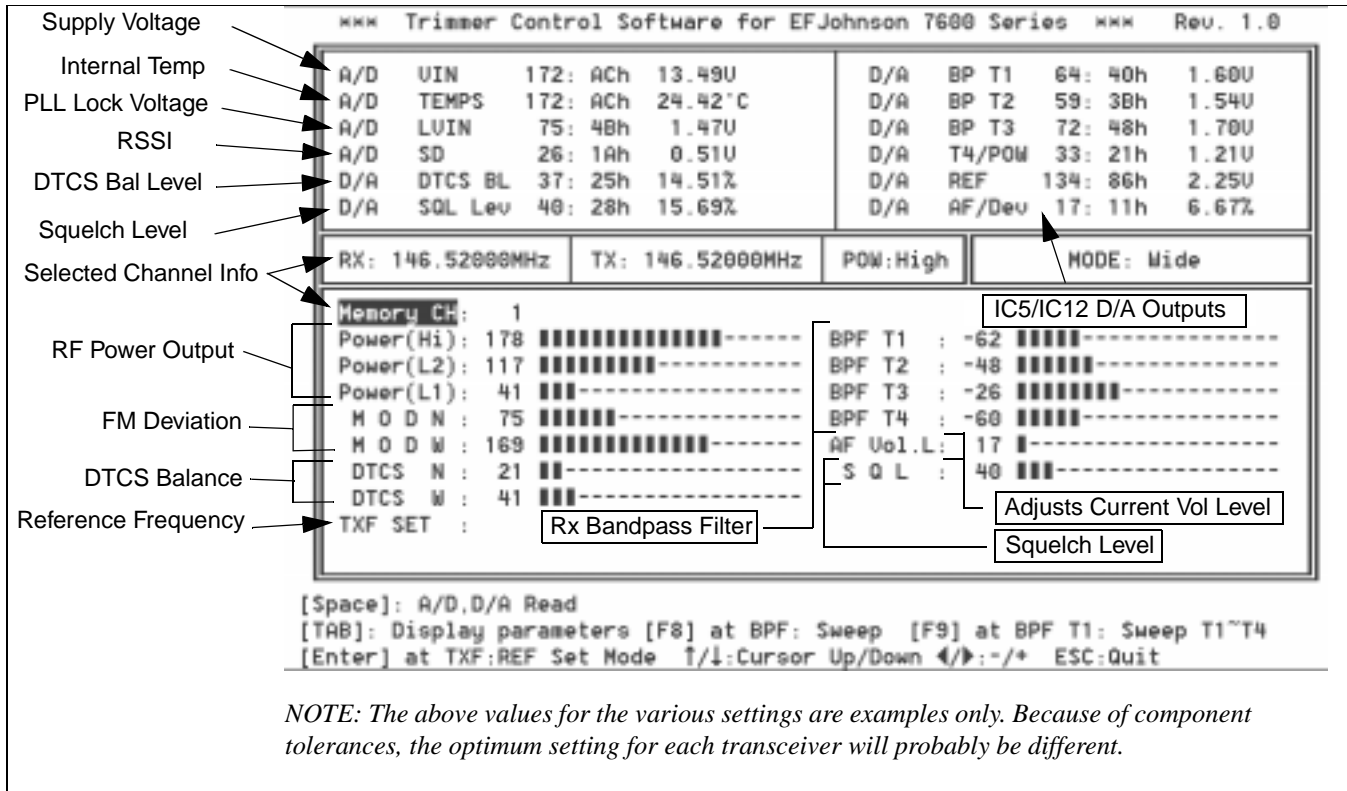

Figure 6-2 Screen Display Example

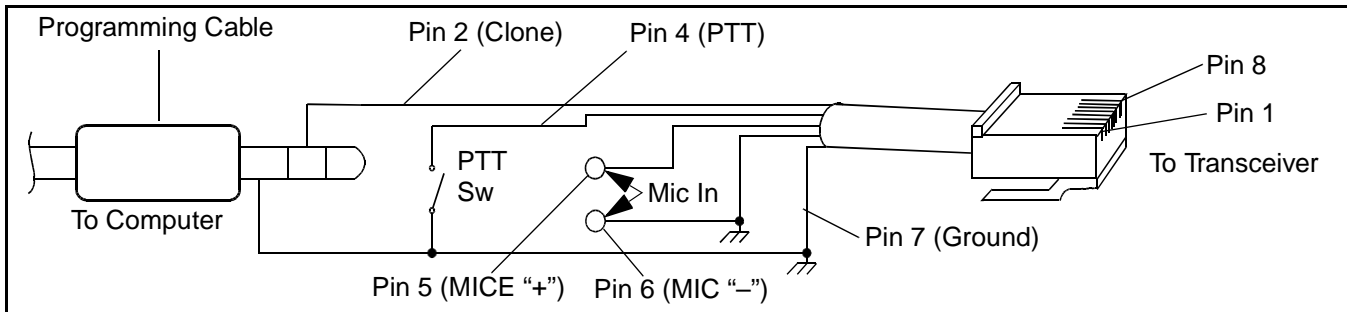

Figure 6-3 Test Cable Schematic

6.1.2 TEST CHANNELS

NOTE: Before programming the test channels, download the current programming data in the transceiver and save it to a disk file so that it can be reloaded after the adjustments are complete.

Test channels at the low, middle (VHF only), and high ends of the operating band, and High, Low1, and Low2 RF output power are required to perform the adjustments in this section. These test channels are listed in Tables 6-1 and 6-2, and they must be programmed as regular channels using the programming

software described in Section 4. There are no fixed test channels or test modes selectable with this transceiver.

6.1.3 TEST CABLE

The test cable shown Figure 6-3 in must be fabricated to perform transceiver alignment. This cable is used in place of the adapter cable shown in Figure 4-1. It is required because in addition to connecting the computer to the microphone jack, a transmit audio and keying (PTT) signal must be applied to that jack. If desired, Replication Cable, Part No. 597-2002-200, can be modified to provide the 8-pin modular-style connector required for this test cable.

Table 6-1 VHF Test Frequencies

Test Channel	Tx/Rx Freq (MHz)	Power	Call Guard Squelch	Bandwidth [1]
1	174.050	Low1	None	Narrow or wide
2	146.050	Low1	None	Narrow or wide
3	160.050	High	None	Narrow or wide
4	160.050	Low2	None	Narrow or wide
5	160.050	Low1	None	Narrow or wide
6	160.050	Low1	007N DTCS	Narrow or wide
7 [1]	160.050	Low1	None	Alternate
8 [1]	160.050	Low1	007 DTCS	Alternate

[1] If the transceiver operates on only narrow or wide band channels, program only channels 1-6, and program them for the type of channels used (narrow or wide band). If the transceiver operates on both wide and narrow band channels, program additional channels 7 and 8 for the other type of operation.

Table 6-2 UHF Test Frequencies

Test Channel	Model (see Section 1.4)				Power	Call Guard Squelch	Bandwidth [1]
	400-430 MHz	450-470 MHz	470-490 MHz	488-512 MHz			
1	400.050	450.050	470.050	490.050	Low1	None	Narrow or wide
2	430.050	470.050	490.050	512.050	Low1	None	Narrow or wide
3	400.050	450.050	470.050	490.050	High	None	Narrow or wide
4	400.050	450.050	470.050	490.050	Low2	None	Narrow or wide
5	400.050	450.050	470.050	490.050	Low1	007N DTCS	Narrow or wide
6 [1]	400.050	450.050	470.050	490.050	Low1	None	Alternate
7 [1]	400.050	450.050	470.050	490.050	Low1	007N DTCS	Alternate

[1] If the transceiver operates on only narrow or wide band channels, program only channels 1-5, and program them for the type of channels used (narrow or wide band). If the transceiver operates on both wide and narrow band channels, program additional channels 6 and 7 for the other type of operation.

6.1.4 COMPUTER-AIDED TUNING

To make most adjustments described in the following information, the computer setup used for programming (see Section 4) and special Adjust software are required. The Adjust software is included on the disk with the programming software in a separate subdirectory called ADJ. To set up the transceiver for use with this equipment, proceed as follows:

1. Copy the Adjust software to the hard disk or a programming disk as described in Section 4.1.3
2. Turn transceiver power on and connect the computer to the transceiver microphone jack using the programming cable and fabricated test cable described in the preceding section (see Figure 6-1).

3. Start the computer in the DOS mode. Make the current directory the ADJ subdirectory and start the program by typing the following:

ADJUST /X /Y

X = A - VHF (normal crystal), B - UHF (TCXO)
Y = 1 - Serial port 1, 2 - Serial port 2

For example, if tuning a VHF transceiver and the programming cable is connected to serial port 2 of the computer, type ADJUST /A /2 (ENTER).

4. The tune data in the connected transceiver is then downloaded and the adjustment screen shown in Figure 6-2 is displayed. The information displayed

VHF ADJUSTMENTS

in the upper part of the screen is for the currently selected channel.

5. To move the cursor between the parameters on the left side of the bar graph, press the $\uparrow\downarrow$ arrow keys. To change a parameter, press the $\leftarrow\rightarrow$, PgUp/PgDn, backspace, or spacebar keys. Refer to the individual adjustment descriptions for more information on the functions performed using this screen.

6.1.5 REPROGRAMMING IF EEPROM IS REPLACED OR ERROR OCCURS

When EEPROM IC3 is replaced or if the transceiver displays an error message and beeps, the following operation must be performed before making any adjustments.

1. Using the programming software, read (download) the data programmed in an exact same version of the transceiver. Refer to Section 4.4.4 for more information on reading data.

2. Select the MODEL menu and press the down arrow (\downarrow) key. Type "RESERVE" and press (ENTER). The "Reserved" indicator should begin flashing in the upper right corner of the screen.
3. Connect the computer to the transceiver that had the EEPROM replaced or is displaying the error (see Figure 4-1). Write the current data to that transceiver.

6.2 PRELIMINARY SETUP

1. Preprogram the transceiver with test channels as described in Section 6.1.2.
2. Connect the computer test setup using the test cable described in Sections 6.1.3 and 6.1.4. Start the program as described.
3. Connect a DC power supply and a 50-ohm, 50-watt antenna load to the transceiver (see Section 6.1.1).

VHF ADJUSTMENTS**6.3 PLL ADJUSTMENT (VHF MODELS)**

1. Remove the bottom cover by removing four screws. Connect a DC voltmeter to check point CP1 shown in Figure 6-4.
2. Select the channel on the high end of the band (Test Ch. 1 - 174.050 MHz). This is done by pressing the $\uparrow\downarrow$ arrow keys to highlight "Memory CH" and then pressing the adjust keys ($\leftarrow\rightarrow$, PgUp/PgDn, or spacebar/backspace) to select the channel.
3. Key the transmitter using the switch on the test cable and the meter reading should be 4.3 volts. If this voltage is significantly different, adjust L14 (it may be necessary to remove the VCO shield).
4. Unkey the transmitter and the meter reading in the receive mode should be 3.3 – 4.3 volts.

5. Select the channel on the low end of the band (Test Ch. 2 - 146.050 MHz). The meter reading should be 0.9 – 1.9 volt in both the transmit and receive modes. Replace the bottom cover.

6.4 TRANSMITTER ADJUSTMENTS (VHF MODELS)**6.4.1 REFERENCE FREQUENCY**

1. Select the channel on the high end of the band (Test Ch. 1 - 174.050 MHz).
2. Scroll down to "TXF SET" on the screen and press (Enter). Monitor the transmit signal with a frequency counter and key the transmitter using the test cable switch.
3. Adjust for the displayed frequency by pressing the computer adjust keys. Unkey the transmitter.

VHF ADJUSTMENTS (CONT'D)

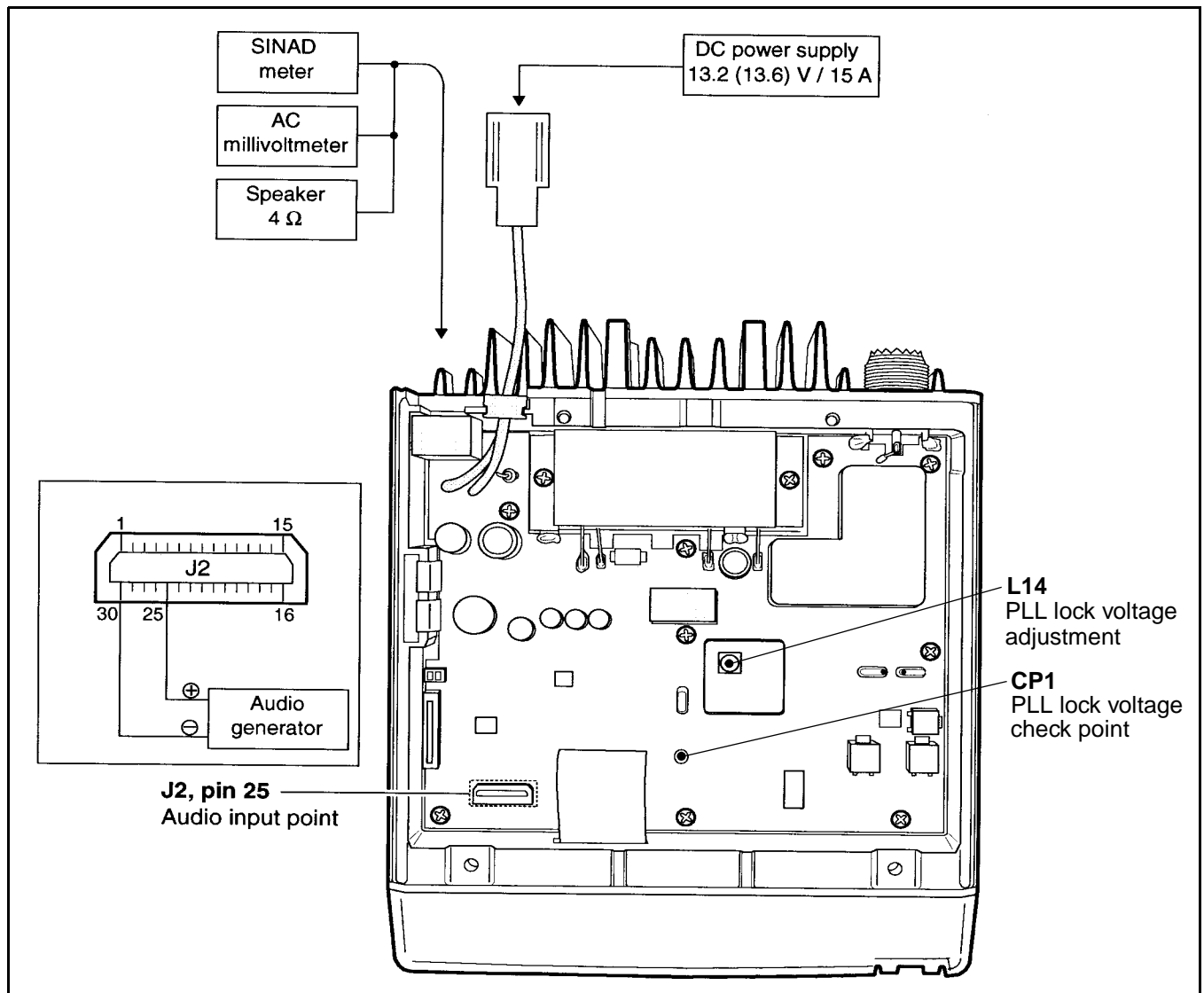

Figure 6-4 VHF Adjustment Points

4. Press (Enter) again to select the second adjust channel. Key the transmitter and adjust for the displayed frequency. Unkey the transmitter and press (Enter) again to exit this function.

puter adjust keys to set the following power. Unkey the transmitter. Repeat for the Low2 (Test Ch. 4) and Low1 (Test Ch. 5) power levels.

High Power = 45 watts (Test Ch. 3)

Low2 Power = 25 watts (Test Ch. 4)

Low1 Power = 4.5 watts (Test Ch. 5)

6.4.2 OUTPUT POWER ADJUST

1. Select the high power channel in the middle of the band (Test Ch. 3 - 160.050 MHz). Connect a power meter to the antenna jack.
2. Scroll to "Power (Hi)" on the screen and key the transmitter using the test cable switch. Use the com-

6.4.3 FM DEVIATION ADJUST

1. Connect an audio generator to the microphone audio input of the test cable (pin 5 shown in Figure 6-3). Set the generator output for 1 kHz at 40 mV rms.

VHF ADJUSTMENTS (CONT'D)

2. Select the low power channel in the middle of the band (Test Ch. 5 - 160.050 MHz). On the computer screen, scroll to "MOD N" if setting narrow band deviation or "MOD W" if setting wideband deviation.
3. Monitor the transmit deviation with a communications monitor set as follows: HPF = Off, LPF = 20 kHz, De-Emphasis = Off, Detector = (P-P)/2.
4. Key the transmitter using the test cable switch and set the following maximum deviation by pressing the adjust keys (←/→, PgUp/PgDn, or spacebar/backspace). Unkey the transmitter.

Wideband (30 kHz) Models - 4.2 kHz

Narrow Band (12.5 kHz) Models - 2.1 kHz

5. If the transceiver operates on both narrow and wide band channels, select Test Ch. 7 and also adjust the deviation on that channel (see note in Table 6-1).

6.4.4 DTCS WAVEFORM ADJUST

1. Select a channel in the middle of the band programmed for DTCS (Test Ch. 8 - 160.050 MHz). On the computer screen, scroll to "DTCS N" if setting a narrow band channel or "DTCS W" if setting a wideband channel.
2. Key the transmitter and view the demodulated signal on the CRT of a communications monitor.
3. Press the adjust keys on the computer so that the waveform appears as follows:

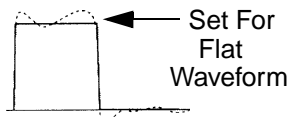

4. If the transceiver operates on both narrow and wide band channels, select Test Ch. 8 and also set the waveform on that channel (see note in Table 6-1).

6.5 RECEIVER ADJUSTMENTS (VHF MODELS)

6.5.1 BANDPASS FILTER ADJUST

1. Select the channel on the low end of the band (Test Ch. 2 - 146.050 MHz).

2. Connect an RF signal generator to the antenna jack. Set the output for the channel frequency at a level of $3.2 \mu\text{V}$ (-97 dBm), modulated with 1 kHz at the following deviation:

Wideband (30 kHz) Models - 3.5 kHz

Narrowband (12.5 kHz) Models - 1.75 kHz

3. Adjust the filters automatically or manually as follows:

Automatic Adjustment Method 1

(Adjusts all filters)

- a. Select "BPF T1" on the screen and adjust for "0". Repeat for T2 – T4. Reselect "BPF T1".
- b. Press the F9 key and all filters are automatically adjusted for peak levels.

Automatic Adjustment Method 2

(Adjusts only one filter at a time)

- a. Select "BPF T1" and press F8 to automatically adjust it for a peak level.
- b. Repeat for the other three filters.

Manual Adjustment

- a. Connect a SINAD meter with a 4-ohm load to the external speaker jack (see Figure 6-4).
- b. Select "BPF T1" and press the adjust keys (←/→, PgUp/PgDn, or spacebar/backspace) to obtain minimum distortion.
- c. Repeat for the other three filters.

6.5.2 SQUELCH ADJUST

NOTE: The squelch level can also be set from the front panel as described in Section 3.3.6.

1. Select the channel on the low end of the operating band (Test Ch. 2 - 146.050 MHz).
2. Connect a SINAD meter with a 4-ohm load to the external speaker jack.

VHF ADJUSTMENTS (CONT'D)

- Connect an RF signal generator to the antenna jack. Set it to the channel frequency with an output modulated with 1 kHz at the following deviation:

Wideband (30 kHz) Models - 3.5 kHz
Narrowband (12.5 kHz) Models - 1.75 kHz

- Scroll to "SQL" on the computer screen and press the adjust keys to lower the displayed number so that the receiver unsquelches (the 1 kHz tone is heard). Also adjust the volume if necessary.
- Adjust the signal generator output to obtain 8 dB SINAD.
- Press the computer adjust keys to increase the displayed number to the point where the receiver squelches. Then slowly adjust the number downward again until the receiver just unsquelches.

6.5.3 BEEP TONE LEVEL

This adjustment sets the volume of the beep tone that is heard when keys are pressed and at other times (if it is enabled). The computer setup used in the preceding steps is not required for this adjustment. Proceed as follows:

Proceed as follows:

- Unplug any cable that may be plugged into the microphone jack and locate R60 inside this jack. (see Figure 6-5).
- Repeatedly press a front panel switch to enable the beep tone and adjust R60 for the desired level.

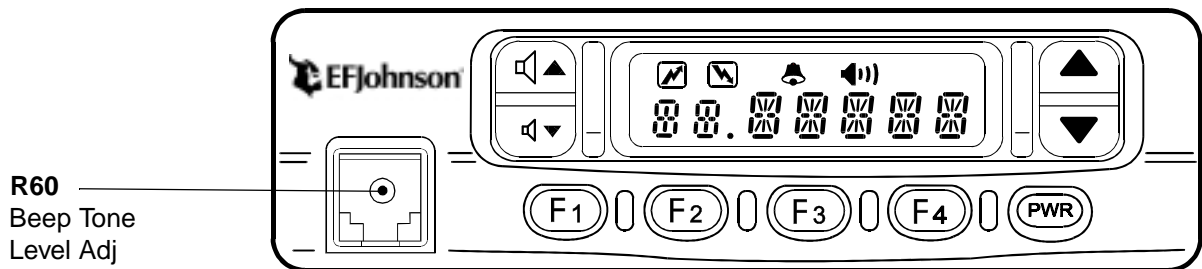

Figure 6-5 Beep Tone Level Adjustment

UHF ADJUSTMENTS

NOTE: Perform the preliminary setup described in Section 6.2 before proceeding with these adjustments.

6.6 PLL ADJUSTMENT (UHF MODELS)

1. Remove the bottom cover by removing four screws. Connect a DC voltmeter to check point CP1 shown in Figure 6-6.
2. Select the channel at the low end of the band (Test Ch. 1). This is done by pressing the $\uparrow\downarrow$ arrow keys to highlight "Memory CH" and then pressing the adjust keys (\leftarrow/\rightarrow , PgUp/PgDn, or spacebar/backspace) to select the channel.
3. In the receive mode, the meter reading should be 1.5 volts. If this voltage is significantly different, adjust L23 (it may be necessary to remove the shield).
4. Key the transmitter using the switch on the test cable and the meter reading also should be 1.5 volts. If this voltage is significantly different, adjust L26.
5. Unkey the transmitter and select the channel on the high end of the band (Test Ch. 2). The meter reading in the receive and transmit modes should be 3.5 – 5.5 volts. Replace the bottom cover.

6.7 TRANSMITTER ADJUSTMENTS (UHF MODELS)

6.7.1 REFERENCE FREQUENCY

1. Select the low power channel on the high end of the band (Test Ch. 2).
2. Scroll down to "TXF SET" on the screen and press (Enter). Monitor the transmit signal with a frequency counter and key the transmitter using the test cable switch.
3. Adjust for the displayed frequency by pressing the computer adjust keys. Unkey the transmitter.
4. Press (Enter) again to select the second adjust channel. Key the transmitter and adjust for the displayed

frequency. Unkey the transmitter and press (Enter) again to exit this function.

6.7.2 OUTPUT POWER ADJUST

1. Select the high power channel at the low end of the band (Test Ch. 3). Connect a power meter to the antenna jack.
2. Scroll to "Power (Hi)" on the screen and key the transmitter using the test cable switch. Use the computer adjust keys to set the following power. Unkey the transmitter. Repeat for the Low2 (Test Ch. 4) and Low1 (Test Ch. 5) power levels.

High Power = 35 watts

Low2 Power = 20 watts

Low1 Power = 3.5 watts

6.7.3 FM DEVIATION ADJUST

1. Connect an audio generator to the microphone audio input of the test cable (pin 5 shown in Figure 6-3). Set the generator output for 1 kHz at 40 mV rms.
2. Select the low power channel at the low end of the band (Test Ch. 1). On the computer screen, scroll to "MOD N" if setting narrow band deviation or "MOD W" if setting wideband deviation.
3. Monitor the transmit deviation with a communications monitor set as follows: HPF = Off, LPF = 20 kHz, De-Emphasis = Off, Detector = (P-P)/2.
4. Key the transmitter using the test cable switch and set the following maximum deviation by pressing the adjust keys (\leftarrow/\rightarrow , PgUp/PgDn, or spacebar/backspace). Unkey the transmitter.

Wideband (30 kHz) Models - 4.2 kHz

Narrow Band (12.5 kHz) Models - 2.1 kHz

5. If the transceiver operates on both narrow and wide band channels, select Test Ch. 6 and also adjust the deviation on that channel (see note in Table 6-2).

UHF ADJUSTMENTS (CONT'D)

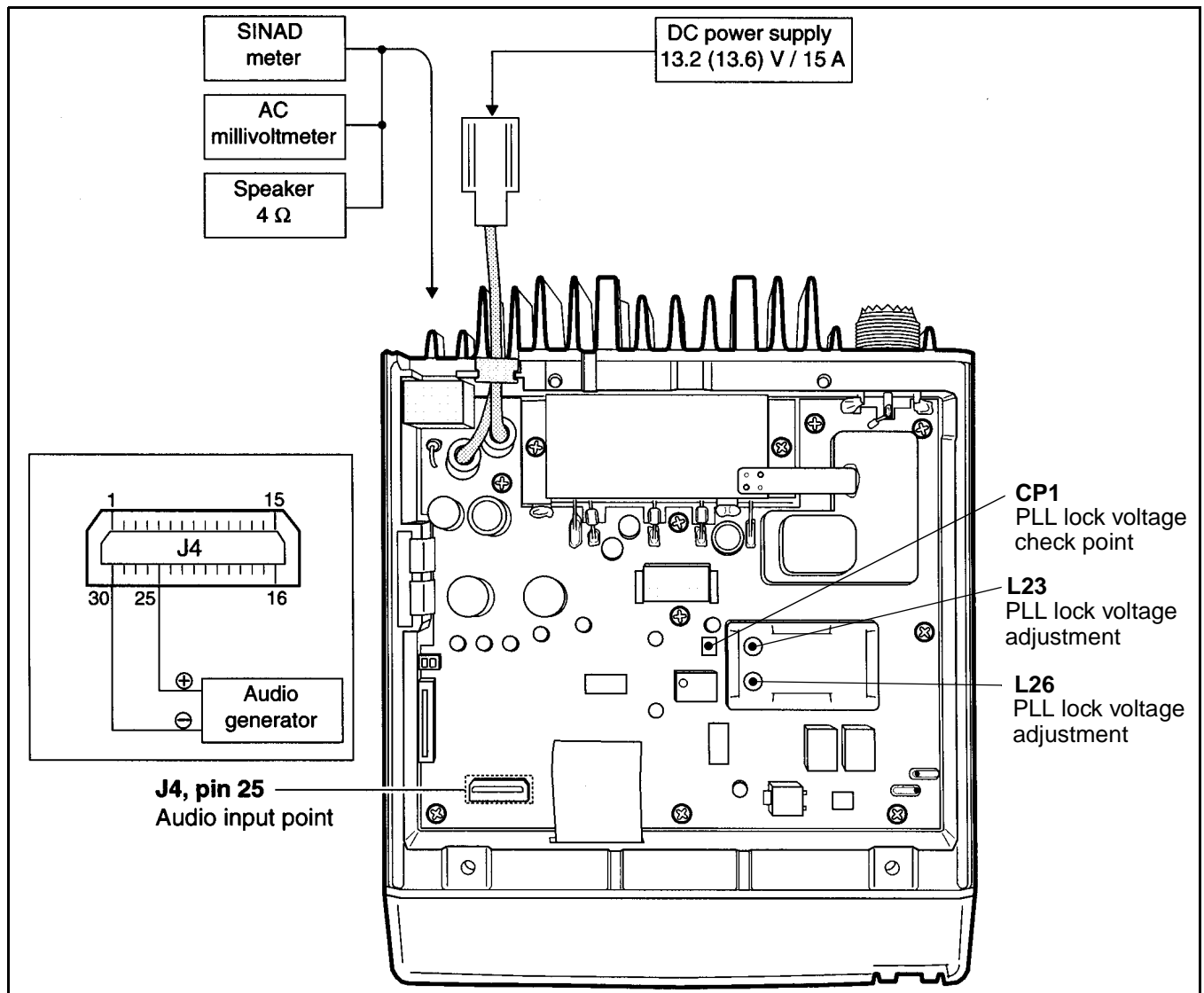
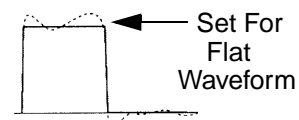

Figure 6-6 UHF Adjustment Points

6.7.4 DTCS WAVEFORM ADJUST

1. Select the channel on the low end of the programmed for DTCS code 007N (Test Ch. 5).
2. On the computer screen, scroll to "DTCS N" if setting a narrow band channel or "DTCS W" if setting a wideband channel.
3. Key the transmitter and view the demodulated signal on the CRT of a communications monitor.

4. Press the adjust keys on the computer so that the waveform appears as follows:



5. If the transceiver operates on both narrow and wide band channels, select Test Ch. 7 and also set the waveform on that channel (see note in Table 6-2).

UHF ADJUSTMENTS (CONT'D)

6.8 RECEIVER ADJUSTMENTS (UHF MODELS)

6.8.1 BANDPASS FILTER ADJUST

1. Select the channel on the low end of the band (Test Ch. 1).
2. Connect an RF signal generator to the antenna jack. Set the output for the channel frequency at a level of 3.2 μ V (-97 dBm), modulated with 1 kHz at the following deviation:

Wideband (25 kHz) Models - 3.5 kHz

Narrowband (12.5 kHz) Models - 1.75 kHz

3. Adjust the filters automatically or manually as follows:

Automatic Adjustment Method 1

(Adjusts all filters)

- a. Select "BPF T1" on the screen and adjust for "0". Repeat for T2 – T4. Reselect "BPF T1".
- b. Press the F9 key and all filters are automatically adjusted for peak levels.

Automatic Adjustment Method 2

(Adjusts only one filter at a time)

- a. Select "BPF T1" and press F8 to automatically adjust it for a peak level.
- b. Repeat for the other three filters.

Manual Adjustment

- a. Connect a SINAD meter with a 4-ohm load to the external speaker jack (see Figure 6-6).
- b. Select "BPF T1" and press the adjust keys (\leftarrow/\rightarrow , PgUp/PgDn, or spacebar/backspace) to obtain minimum distortion.
- c. Repeat for the other three filters.

6.8.2 SQUELCH ADJUST

NOTE: The squelch level can also be set from the front panel as described in Section 3.3.6.

1. Select the channel on the low end of the operating band (Test Ch. 2). channel with LB models and the 150.050 MHz channel with HB models.
2. Connect a SINAD meter with a 4-ohm load to the external speaker jack.
3. Connect an RF signal generator to the antenna jack. Set it to the channel frequency with an output modulated with 1 kHz at the following deviation:

Wideband (30 kHz) Models - 3.5 kHz

Narrowband (12.5 kHz) Models - 1.75 kHz

4. Scroll to "SQL" on the computer screen and press the adjust keys to lower the displayed number so that the receiver unsquelches (the 1 kHz tone is heard). Also adjust the volume if necessary.
5. Adjust the signal generator output to obtain 8 dB SINAD.
6. Press the computer adjust keys to increase the displayed number to the point where the receiver squelches. Then slowly adjust the number downward again until the receiver just unsquelches.

6.8.3 BEEP TONE LEVEL

This adjustment sets the volume of the beep tone that is heard when keys are pressed and at other times (if it is enabled). The computer setup used in the preceding steps is not required for this adjustment. Proceed as follows:

1. Unplug any cable that may be plugged into the microphone jack and locate R60 inside this jack. (see Figure 6-5).
2. Repeatedly press a front panel switch to enable the beep tone and adjust R60 for the desired level.

SECTION 7 PARTS LIST

7610 (VHF) Main Unit

Ref No.	Description	Part No.
7610 (VHF) MAIN UNIT		
C001	Ceram GRM42-6 CK 020C 500PT	022-3906-795
C003	Ceram GRM42-6 CH 180J 500PT	022-3906-799
C004	Ceram C1608 CH 1H 471J-T-A	022-3906-252
C005	Ceramic GRM40 CK 0R5C 50PT	022-3906-813
C007	Ceramic C1608 CH 1H 471J-T-A	022-3906-252
C009	Ceram GRM42-6 CH 080D 500PT	022-3906-819
C010	Ceram GRM42-6 CH 120J 500PT	022-3906-796
C011	Ceram GRM42-6 CH 150J 500PT	022-3906-797
C013	Ceram GRM42-6 CH 180J 500PT	022-3906-799
C015	Cera GRM42-6 W5R 102K 500PT	022-3906-800
C016	Ceramic C1608 CH 1H 471J-T-A	022-3906-252
C017	Ceramic C1608 JB 1H 102K-T-A	022-3906-060
C018	Ceramic C1608 CH 1H 471J-T-A	022-3906-252
C019	Ceramic C1608 JB 1H 102K-T-A	022-3906-060
C020	Ceram GRM42-6 CH 180J 500PT	022-3906-799
C022	Ceram GRM42-6 CH 180J 500PT	022-3906-799
C023	Ceramic C1608 CH 1H 120J-T-A	022-3906-066
C024	Ceramic C1608 CH 1H 270J-T-A	022-3906-069
C025	Ceramic C1608 CH 1H 120J-T-A	022-3906-066
C026	Ceramic C1608 JB 1H 102K-T-A	022-3906-060
C027	Ceramic C1608 JB 1H 102K-T-A	022-3906-060
C028	Ceramic C1608 CH 1H 471J-T-A	022-3906-252
C029	Ceramic C1608 CH 1H 180J-T-A	022-3906-068
C030	Ceramic C1608 JB 1H 102K-T-A	022-3906-060
C031	Ceramic C1608 CH 1H 471J-T-A	022-3906-252
C032	Ceramic C1608 JB 1H 102K-T-A	022-3906-060
C033	Ceramic C1608 CH 1H 080D-T-A	022-3906-597
C035	Ceramic C1608 JB 1H 102K-T-A	022-3906-060
C036	Ceramic C1608 CH 1H 470J-T-A	022-3906-600
C037	Ceramic C1608 JB 1H 102K-T-A	022-3906-060
C038	Ceramic C1608 JB 1H 102K-T-A	022-3906-060
C039	Ceramic C1608 CH 1H 100D-T-A	022-3906-598
C040	Ceramic C1608 JB 1H 102K-T-A	022-3906-060
C041	Ceramic C1608 CH 1H 180J-T-A	022-3906-068
C042	Ceramic C1608 JB 1H 102K-T-A	022-3906-060
C043	Ceramic C1608 CH 1H 120J-T-A	022-3906-066
C044	Ceramic C1608 JB 1H 102K-T-A	022-3906-060
C045	Ceramic C1608 CH 1H 050B-T-A	022-3906-610
C046	Ceramic C1608 CH 1H 220J-T-A	022-3906-065

Ref No.	Description	Part No.
C047	Ceramic C1608 JB 1H 102K-T-A	022-3906-060
C048	Ceramic C1608 CH 1H 0R5B-T-A	022-3906-084
C049	Ceramic C1608 JB 1H 102K-T-A	022-3906-060
C050	Ceramic C1608 JB 1H 102K-T-A	022-3906-060
C051	Ceramic C1608 JB 1H 102K-T-A	022-3906-060
C052	Ceramic C1608 CH 1H 020B-T-A	022-3906-086
C053	Ceramic C1608 CH 1H 1R5B-T-A	022-3906-087
C054	Ceramic C1608 UJ 1H 560J-T-A	022-3906-814
C055	Ceramic C1608 UJ 1H 330J-T-A	022-3906-816
C056	Ceramic C1608 JB 1H 102K-T-A	022-3906-060
C057	Ceramic C1608 JB 1H 102K-T-A	022-3906-060
C058	Ceramic C1608 JB 1H 102K-T-A	022-3906-060
C059	Ceramic C1608 JB 1C 104KT-N	022-3906-614
C060	Tantalum ECST1AY225R	022-3906-626
C061	Tantalum ECST1CY684R	022-3906-633
C062	Ceramic C1608 JB 1H 102K-T-A	022-3906-060
C063	Tantalum ECST0JY106R	022-3906-627
C064	Ceramic C1608 JB 1H 102K-T-A	022-3906-060
C065	Ceramic C1608 JB 1H 102K-T-A	022-3906-060
C066	Ceramic C1608 JB 1H 102K-T-A	022-3906-060
C067	Ceramic C1608 JB 1H 102K-T-A	022-3906-060
C068	Ceramic C1608 JB 1E 103K-T-A	022-3906-063
C069	Ceramic C1608 JB 1H 102K-T-A	022-3906-060
C070	Ceramic C1608 CH 1H 470J-T-A	022-3906-600
C071	Ceramic C1608 CH 1H 470J-T-A	022-3906-600
C072	Ceramic C1608 CH 1H 470J-T-A	022-3906-600
C073	Ceramic C1608 JB 1H 102K-T-A	022-3906-060
C074	Ceramic C1608 CH 1H 090D-T-A	022-3906-348
C075	Ceramic C1608 CH 1H 090D-T-A	022-3906-348
C079	Ceramic C1608 CH 1H 560J-T-A	022-3906-601
C080	Ceramic C1608 CH 1H 120J-T-A	022-3906-066
C082	Ceramic C1608 CH 1H 330J-T-A	022-3906-070
C085	Tantalum ECST1AY225R	022-3906-626
C086	Ceramic C1608 JB 1H 102K-T-A	022-3906-060
C087	Ceram GRM42-6 CH 180J 500PT	022-3906-799
C088	Ceram GRM42-6 CH 220J 500PT	022-3906-818
C089	Ceramic C1608 CH 1H 070D-T-A	022-3906-596
C090	Ceramic C1608 CH 1H 040B-T-A	022-3906-609
C091	Ceramic C1608 CH 1H 1R5B-T-A	022-3906-087
C092	Ceramic C1608 CH 1H 101J-T-A	022-3906-072
C093	Ceramic C1608 CH 1H 010B-T-A	022-3906-085
C095	Ceramic C1608 JB 1H 102K-T-A	022-3906-060

7610 (VHF) Main Unit

Ref No.	Description	Part No.
C096	Ceramic C1608 JB 1H 102K-T-A	022-3906-060
C097	Ceramic C1608 CH 1H 101J-T-A	022-3906-072
C098	Ceramic C1608 CH 1H 060B-T-A	022-3906-615
C099	Ceramic C1608 CH 1H 1R5B-T-A	022-3906-087
C100	Ceramic C1608 JB 1H 102K-T-A	022-3906-060
C101	Ceramic C1608 JB 1H 102K-T-A	022-3906-060
C102	Ceramic C1608 JB 1E 103K-T-A	022-3906-063
C103	Ceramic C1608 JB 1H 102K-T-A	022-3906-060
C104	Ceramic C1608 JB 1H 102K-T-A	022-3906-060
C105	Ceramic C1608 CH 1H 040B-T-A	022-3906-609
C106	Ceramic C1608 CH 1H 101J-T-A	022-3906-072
C107	Ceramic C1608 CH 1H 010B-T-A	022-3906-085
C109	Ceramic C1608 JB 1H 102K-T-A	022-3906-060
C110	Ceramic C1608 JB 1H 102K-T-A	022-3906-060
C111	Ceramic C1608 CH 1H 101J-T-A	022-3906-072
C112	Ceramic C1608 CH 1H 080D-T-A	022-3906-597
C113	Ceramic C1608 CH 1H 050B-T-A	022-3906-610
C115	Ceramic C1608 JB 1H 102K-T-A	022-3906-060
C116	Ceramic C1608 CH 1H 150J-T-A	022-3906-067
C117	Ceramic C1608 CH 1H 560J-T-A	022-3906-601
C118	Ceramic C1608 CH 1H 150J-T-A	022-3906-067
C119	Ceramic C1608 JB 1E 103K-T-A	022-3906-063
C120	Ceramic C1608 JB 1H 102K-T-A	022-3906-060
C121	Ceramic C1608 CH 1H 680J-T-A	022-3906-798
C122	Ceramic C1608 JB 1H 102K-T-A	022-3906-060
C123	Ceramic C1608 JB 1E 103K-T-A	022-3906-063
C124	Ceramic C1608 JB 1H 102K-T-A	022-3906-060
C126	Ceramic C1608 CH 1H 110J-T-A	022-3906-613
C127	Ceramic C1608 JB 1E 103K-T-A	022-3906-063
C128	Ceramic C1608 JB 1E 103K-T-A	022-3906-063
C129	Ceramic C1608 JB 1E 103K-T-A	022-3906-063
C130	Ceramic C1608 JB 1E 103K-T-A	022-3906-063
C131	Ceramic C1608 CH 1H 101J-T-A	022-3906-072
C132	Ceramic C1608 JB 1H 102K-T-A	022-3906-060
C133	Ceramic C1608 JB 1C 333K-T-A	022-3906-351
C134	Ceramic C1608 JB 1H 102K-T-A	022-3906-060
C135	Ceramic C1608 JB 1E 103K-T-A	022-3906-063
C136	Ceramic C2012 JF 1C 105Z-T-A	022-3906-078
C137	Ceramic C1608 JB 1C 104KT-N	022-3906-614
C138	Ceramic C1608 CH 1H 221J-T-A	022-3906-603
C139	Ceramic C1608 CH 1H 221J-T-A	022-3906-603
C140	Ceramic C1608 CH 1H 100D-T-A	022-3906-598
C141	Ceramic C1608 CH 1H 180J-T-A	022-3906-068
C142	Ceramic C1608 CH 1H 040B-T-A	022-3906-609
C143	Ceramic C1608 CH 1H 120J-T-A	022-3906-066
C144	Ceramic C1608 CH 1H 150J-T-A	022-3906-067

Ref No.	Description	Part No.
C145	Ceramic C1608 CH 1H 100D-T-A	022-3906-598
C146	Ceramic C1608 JB 1E 103K-T-A	022-3906-063
C147	Ceramic C1608 JB 1E 103K-T-A	022-3906-063
C148	Ceramic C1608 JB 1C 104KT-N	022-3906-614
C149	Ceramic C1608 JB 1C 104KT-N	022-3906-614
C150	Ceramic C1608 JB 1H 102K-T-A	022-3906-060
C151	Ceramic C1608 JB 1H 102K-T-A	022-3906-060
C152	Ceramic C1608 JB 1H 102K-T-A	022-3906-060
C153	Ceramic C1608 JB 1H 102K-T-A	022-3906-060
C154	Ceramic C1608 CH 1H 471J-T-A	022-3906-252
C155	Ceramic C1608 JB 1H 102K-T-A	022-3906-060
C156	Tantalum ECST1AY225R	022-3906-626
C157	Ceramic C1608 JB 1H 102K-T-A	022-3906-060
C159	Ceramic C1608 JB 1E 103K-T-A	022-3906-063
C160	Ceramic C1608 JB 1H 102K-T-A	022-3906-060
C161	Ceramic C1608 JB 1C 104KT-N	022-3906-614
C162	Ceramic C1608 JB 1E 103K-T-A	022-3906-063
C163	Ceramic C2012 JB 1A 105M-T-A	022-3906-801
C164	Ceramic C1608 JB 1C 223K-T-A	022-3906-079
C165	Ceramic C1608 JB 1E 103K-T-A	022-3906-063
C166	Tantalum ECST1AY225R	022-3906-626
C167	Ceramic C1608 JB 1E 103K-T-A	022-3906-063
C168	Ceramic C1608 JB 1C 104KT-N	022-3906-614
C169	Ceramic C1608 JB 1E 103K-T-A	022-3906-063
C170	Ceramic C1608 JB 1E 103K-T-A	022-3906-063
C171	Ceramic C1608 JB 1H 102K-T-A	022-3906-060
C172	Ceramic C1608 CH 1H 201J-T-A	022-3906-802
C173	Ceramic C1608 JB 1H 102K-T-A	022-3906-060
C174	Ceramic C1608 JB 1E 103K-T-A	022-3906-063
C175	Ceramic C1608 JB 1E 103K-T-A	022-3906-063
C176	Ceramic C1608 JB 1E 103K-T-A	022-3906-063
C177	Ceramic C1608 JB 1E 103K-T-A	022-3906-063
C178	Ceramic C1608 JB 1H 102K-T-A	022-3906-060
C179	Ceramic C1608 JB 1H 102K-T-A	022-3906-060
C180	Ceramic C1608 JB 1H 102K-T-A	022-3906-060
C181	Ceramic C1608 JB 1H 102K-T-A	022-3906-060
C182	Tantalum ECST0JY106R	022-3906-627
C183	Ceramic C1608 JB 1E 103K-T-A	022-3906-063
C184	Tantalum ECST1AY225R	022-3906-626
C185	Ceramic C1608 JB 1C 104KT-N	022-3906-614
C186	Ceramic C1608 JB 1C 104KT-N	022-3906-614
C187	Ceramic C1608 JB 1E 103K-T-A	022-3906-063
C188	Ceramic C1608 JB 1C 473K-T-A	022-3906-080
C189	Ceramic C1608 JB 1E 103K-T-A	022-3906-063
C190	Ceramic C1608 JB 1E 103K-T-A	022-3906-063
C191	Ceramic C1608 JB 1E 103K-T-A	022-3906-063

7610 (VHF) Main Unit

Ref No.	Description	Part No.	Ref No.	Description	Part No.
C192	Ceramic C1608 JB 1E 103K-T-A	022-3906-063	C242	Ceramic C1608 CH 1H 470J-T-A	022-3906-600
C194	Tantalum ECST1AY225R	022-3906-626	C243	Ceramic C1608 CH 1H 470J-T-A	022-3906-600
C196	Ceramic C1608 JB 1C 104KT-N	022-3906-614	C244	Ceramic C1608 CH 1H 470J-T-A	022-3906-600
C197	Ceramic C1608 JB 1C 104KT-N	022-3906-614	C245	Ceramic C1608 CH 1H 470J-T-A	022-3906-600
C198	Ceramic C1608 CH 1H 150J-T-A	022-3906-067	C246	Ceramic C1608 CH 1H 470J-T-A	022-3906-600
C199	Ceramic C1608 JB 1C 104KT-N	022-3906-614	C248	Ceramic C1608 CH 1H 470J-T-A	022-3906-600
C200	Ceramic C1608 JB 1A 224K-T-N	022-3906-804	C249	Ceramic C1608 CH 1H 470J-T-A	022-3906-600
C201	Tantalum ECST0JY106R	022-3906-627	C250	Ceramic C1608 CH 1H 470J-T-A	022-3906-600
C202	Ceramic C1608 JB 1H 102K-T-A	022-3906-060	C251	Ceramic C1608 CH 1H 470J-T-A	022-3906-600
C203	Ceramic C1608 JB 1E 103K-T-A	022-3906-063	C252	Ceramic C1608 CH 1H 470J-T-A	022-3906-600
C204	Electrolytic ECEV1EA221P	022-3906-805	C253	Ceramic C1608 CH 1H 470J-T-A	022-3906-600
C205	Ceramic C1608 JB 1C 104KT-N	022-3906-614	C254	Ceramic C1608 CH 1H 470J-T-A	022-3906-600
C206	Electrolytic ECEV1AA471UP	022-3906-806	C255	Ceramic C1608 CH 1H 470J-T-A	022-3906-600
C207	Electrolytic ECEV1CA220SR	022-3906-620	C256	Ceramic C1608 CH 1H 470J-T-A	022-3906-600
C208	Ceramic C1608 JB 1H 102K-T-A	022-3906-060	C257	Ceramic C1608 CH 1H 470J-T-A	022-3906-600
C209	Electrolytic ECEV1CA220SR	022-3906-620	C258	Ceramic C1608 CH 1H 470J-T-A	022-3906-600
C210	Ceramic C1608 JB 1H 102K-T-A	022-3906-060	C259	Ceramic C1608 CH 1H 470J-T-A	022-3906-600
C211	Electrolytic ECEV1CA220SR	022-3906-620	C260	Ceramic C1608 CH 1H 470J-T-A	022-3906-600
C212	Ceramic C1608 JB 1H 102K-T-A	022-3906-060	C261	Ceramic C1608 CH 1H 470J-T-A	022-3906-600
C213	Ceramic C1608 JB 1H 102K-T-A	022-3906-060	C262	Ceramic C1608 CH 1H 470J-T-A	022-3906-600
C215	Tantalum ECST0JY106R	022-3906-627	C263	Ceramic C1608 CH 1H 470J-T-A	022-3906-600
C216	Electrolytic ECEV0JA101SP	022-3906-621	C264	Ceramic C1608 CH 1H 470J-T-A	022-3906-600
C217	Ceramic C1608 JB 1E 103K-T-A	022-3906-063	C265	Ceramic C1608 CH 1H 470J-T-A	022-3906-600
C218	Ceramic C1608 JB 1E 103K-T-A	022-3906-063	C266	Ceramic C1608 CH 1H 470J-T-A	022-3906-600
C219	Ceramic C1608 JB 1H 102K-T-A	022-3906-060	C267	Ceramic C1608 CH 1H 470J-T-A	022-3906-600
C220	Electrolytic 25 MV 470 HC	022-3906-808	C268	Ceramic C1608 CH 1H 470J-T-A	022-3906-600
C221	Ceramic C1608 JB 1H 102K-T-A	022-3906-060	C269	Ceramic C1608 CH 1H 470J-T-A	022-3906-600
C222	Ceramic C1608 CH 1H 471J-T-A	022-3906-252	C270	Ceramic C1608 CH 1H 470J-T-A	022-3906-600
C223	Ceramic C1608 CH 1H 470J-T-A	022-3906-600	C271	Ceramic C1608 JB 1H 102K-T-A	022-3906-060
C224	Ceramic C1608 JB 1H 102K-T-A	022-3906-060	C272	Ceramic C1608 JB 1H 102K-T-A	022-3906-060
C225	Ceramic C1608 JB 1H 102K-T-A	022-3906-060	C273	Ceramic C1608 JB 1H 102K-T-A	022-3906-060
C226	Ceramic C1608 JB 1H 102K-T-A	022-3906-060	C274	Ceramic C1608 CH 1H 471J-T-A	022-3906-252
C227	Ceramic C1608 JB 1H 102K-T-A	022-3906-060	C275	Ceramic C1608 CH 1H 470J-T-A	022-3906-600
C228	Ceramic C1608 JB 1H 102K-T-A	022-3906-060	C276	Tantalum TESVD2 1V 685M-12R	022-3906-809
C229	Tantalum ECST1CY105R	022-3906-625	C277	Ceramic C1608 JB 1H 102K-T-A	022-3906-060
C230	Ceramic C1608 JB 1C 104KT-N	022-3906-614	C278	Ceramic C1608 JB 1H 102K-T-A	022-3906-060
C231	Ceramic C1608 JB 1H 102K-T-A	022-3906-060	C279	Ceramic C1608 CH 1H 471J-T-A	022-3906-252
C232	Ceramic C1608 JB 1H 102K-T-A	022-3906-060	C280	Ceramic C1608 CH 1H 470J-T-A	022-3906-600
C233	Ceramic C1608 JB 1H 102K-T-A	022-3906-060	C281	Ceramic C1608 JB 1H 102K-T-A	022-3906-060
C234	Ceramic C1608 JB 1H 102K-T-A	022-3906-060	C282	Tantalum ECST1AY106R	022-3906-765
C235	Ceramic C1608 JB 1H 102K-T-A	022-3906-060	C283	Ceramic C1608 JB 1H 182K-T-A	022-3906-089
C236	Ceramic C1608 JB 1H 102K-T-A	022-3906-060	C284	Ceramic C1608 CH 1H 391J-T-A	022-3906-091
C237	Ceramic C1608 JB 1H 102K-T-A	022-3906-060	C285	Ceramic C1608 CH 1H 470J-T-A	022-3906-600
C238	Ceramic C1608 JB 1H 102K-T-A	022-3906-060	C286	Ceramic C1608 JB 1H 102K-T-A	022-3906-060
C240	Ceramic C1608 CH 1H 470J-T-A	022-3906-600	C287	Ceramic C1608 CH 1H 101J-T-A	022-3906-072
C241	Ceramic C1608 CH 1H 470J-T-A	022-3906-600	C288	Ceramic C1608 JB 1E 103K-T-A	022-3906-063

7610 (VHF) Main Unit

Ref No.	Description	Part No.
C290	Ceramic C1608 JB 1E 103K-T-A	022-3906-063
C291	Ceramic C1608 CH 1H 470J-T-A	022-3906-600
C292	Ceramic C1608 CH 1H 470J-T-A	022-3906-600
C293	Ceramic C1608 JB 1C 104KT-N	022-3906-614
C294	Ceramic C1608 JB 1E 103K-T-A	022-3906-063
C295	Ceramic C1608 JB 1H 102K-T-A	022-3906-060
C296	Ceramic C1608 JB 1H 102K-T-A	022-3906-060
C297	Electrolytic 16 MV 470 HC	022-3906-811
C298	Tantalum ECST0JY106R	022-3906-627
C299	Ceramic C1608 JB 1H 102K-T-A	022-3906-060
D001	Diode 1SS375-TL	022-3906-584
D002	Diode 1SS375-TL	022-3906-584
D003	Diode MI407	022-3906-822
D005	Diode MA77 (TW)	022-3906-047
D006	Diode MA77 (TW)	022-3906-047
D007	Varicap HVU350TRF	022-3906-578
D008	Varicap HVU350TRF	022-3906-578
D009	Diode MA77 (TW)	022-3906-047
D010	Diode MA77 (TW)	022-3906-047
D011	Diode MA111 (TX)	022-3906-585
D012	Varicap HVU17TRF	022-3906-580
D013	Diode MI809-T11	022-3906-043
D014	Diode MI809-T11	022-3906-043
D015	Diode 1SS352 (TPH3)	022-3906-820
D016	Varicap HVU350TRF	022-3906-578
D017	Varicap HVU350TRF	022-3906-578
D018	Varicap HVU350TRF	022-3906-578
D019	Varicap HVU350TRF	022-3906-578
D020	Varicap HVU350TRF	022-3906-578
D021	Varicap HVU350TRF	022-3906-578
D022	Diode DAN202U T107	022-3906-558
D023	Diode DAN202U T107	022-3906-558
D024	Diode MA111 (TX)	022-3906-585
D025	Diode MA111 (TX)	022-3906-585
D026	Diode DAN202U T107	022-3906-558
D027	Diode DSA3A1	022-3906-821
D028	Diode MA111 (TX)	022-3906-585
D029	Diode DA221 TL	022-3906-331
D030	Zener MA8082-M (TX)	022-3906-823
D031	Diode DA204U T107	022-3906-582
D032	Zener RD20E B2	022-3906-824
D033	Diode DAN202U T107	022-3906-558
FI1	XTAL FL-285 (31.050 MHz)	022-3906-826
FI3	Ceramic SFPC450G-TC01	022-3906-827

Ref No.	Description	Part No.
FI4	Ceramic SFPC450E-TC01	022-3906-828
IC001	IC M68702H	022-3906-792
IC002	μPD3140GS-E1 (DS8)	022-3906-554
IC003	TA31136FN (D,EL)	022-3906-302
IC004	BU4066BCFV-E1	022-3906-555
IC005	M62363FP-650C	022-3906-832
IC006	NJM2902V-TE1	022-3906-553
IC007	NJM2902V-TE1	022-3906-553
IC008	NJM2904V-TE1	022-3906-016
IC009	S-81250PG-PD-T1	022-3906-559
IC010	LA4425A	022-3906-830
IC011	BU4094BCFV-E1	022-3906-831
J1	Connector FH12-40S-0.5SV	022-3906-782
J2	Connector AXN330C038P	022-3906-681
J3	Connector B11B-ZR-SM3-TF	022-3906-834
J4	Connector PI28A-02M	022-3901-444
J5	Connector HSJ0807-01-010	022-3906-835
J6	Connector B2B-ZR-SM3-TF	022-3906-836
L02	Coil LA-243	022-3906-840
L03	Coil LA-253	022-3906-837
L04	Coil LW-25	022-3906-842
L05	Coil LA-253	022-3906-837
L06	Coil ELJNC 47NK-F	022-3906-845
L07	Coil ELJNC 47NK-F	022-3906-845
L08	Coil ELJNC 47NK-F	022-3906-845
L09	Coil ELJNC R10K-F	022-3906-849
L1	Coil LA-253	022-3906-837
L11	Coil ELJRE R10G-F	022-3906-674
L12	Coil ELJRE R10G-F	022-3906-674
L13	Coil ELJRE R10G-F	022-3906-674
L14	Coil MC152-E558CN-100024	022-3906-663
L15	Coil NL 322522T-2R7J-3	022-3906-651
L16	Coil ELJRE 82NG-F	022-3906-675
L17	Coil 36CS-656LZ-09K=P3	022-3906-838
L18	Coil 36CS-656LZ-09K=P3	022-3906-838
L19	Coil LQN1H 54NK04	022-3906-676
L20	Coil LQN1H 54NK04	022-3906-676
L21	Coil LQN 1A 33NJ04	022-3906-647
L22	Coil LQN 1A 33NJ04	022-3906-647
L23	Coil ELJRE 47NG-F	022-3906-494
L24	Coil ELJRE R10G-F	022-3906-674
L25	Coil MLF1608D R47K-T	022-3906-662
L26	Coil MLF1608A 1R0K-T	022-3906-656

7610 (VHF) Main Unit

Ref No.	Description	Part No.
L27	Coil MLF1608A 1R0K-T	022-3906-656
MP1	1922 VCO case	022-3906-714
MP2	1922 VCO cover	022-3906-713
MP3	2055 Filter case	022-3906-880
MP4	2055 Filter cover	022-3906-881
MP5	PA holder	022-3906-882
MP6	Rubber sheet (AD)	022-3906-883
Q01	Transistor 2SC4703-T1 SE	022-3906-850
Q02	Transistor 2SC4215-O (TE85R)	022-3906-563
Q03	Transistor 2SC4215-O (TE85R)	022-3906-563
Q04	Transistor 2SC4215-O (TE85R)	022-3906-563
Q05	Transistor 2SC4215-O (TE85R)	022-3906-563
Q06	Transistor 2SC4215-O (TE85R)	022-3906-563
Q07	Transistor 2SC4226-T2 R25	022-3906-499
Q08	Transistor 2SC4226-T2 R25	022-3906-499
Q09	Transistor DTC144EU T107	022-3906-038
Q10	Transistor 2SC4081 T107 R	022-3901-343
Q11	FET 2SK880-Y (TE85R)	022-3906-567
Q12	FET 3SK239XR-TL	022-3906-325
Q13	FET 3SK166-2-T7	022-3906-570
Q14	Transistor 2SC2714-Y (TE85R)	022-3906-562
Q15	Transistor 2SC4081 T107 R	022-3901-343
Q16	Transistor DTA144EU T107	022-3901-353
Q17	Transistor 2SB1143 S	022-3906-851
Q18	Transistor 2SC4081 T107 R	022-3901-343
Q19	Transistor DTC144EU T107	022-3906-038
Q20	Transistor DTC363EK T147	022-3906-852
Q21	Transistor DTC144EU T107	022-3906-038
Q22	Transistor DTC144EU T107	022-3906-038
Q23	Transistor DTC144EU T107	022-3906-038
Q24	Transistor DTC144EU T107	022-3906-038
Q25	Transistor DTC114EU T107	022-3906-853
Q26	Transistor 2SB1124S-TD	022-3906-854
Q27	Transistor 2SA1588-GR (TE85R)	022-3906-561
Q28	Transistor 2SA1588-GR (TE85R)	022-3906-561
Q29	Transistor 2SB1201-S-TL	022-3906-855
Q30	Transistor XP6501- (TX).AB	022-3906-573
Q31	Transistor DTC144EU T107	022-3906-038
Q32	Transistor DTC114EU T107	022-3906-853
Q33	Transistor DTC114EU T107	022-3906-853
Q34	FET 2SJ144-Y (TE85R)	022-3906-858
Q35	Transistor DTA144EU T107	022-3901-353
Q36	Transistor 2SD1664 T100Q	022-3906-859
Q37	Transistor DTC144WU T107	022-3906-860

Ref No.	Description	Part No.
Q38	Transistor 2SD1664 T100Q	022-3906-859
Q39	Transistor DTC144EU T107	022-3906-038
Q40	Transistor 2SC4081 T107	022-3901-343
R001	Res MCR10EZHZJ 82 k ohm (823)	022-3906-862
R002	Res ERJ3GEYJ 470 V (47 ohm)	022-3906-141
R003	Res ERJ3GEYJ 470 V (47 ohm)	022-3906-141
R004	Res ERJ3GEYJ 101 V (100 ohm)	022-3906-143
R005	Res ERJ3GEYJ 182 V (1.8 k ohm)	022-3906-156
R006	Res MCR18EZHZJ 22 ohm (220)	022-3906-870
R007	Res MCR18EZHZJ 33 ohm (330)	022-3906-875
R009	Res MCR50JZHZJ 56 ohm (560)	022-3906-876
R010	Res MCR10EZHZJ 5.6 ohm (5R6)	022-3906-863
R011	Res MCR10EZHZJ 5.6 ohm (5R6)	022-3906-863
R012	Res ERJ3GEYJ 561 V (560 ohm)	022-3906-151
R013	Res ERJ3GEYJ 222 V (2.2 k ohm)	022-3906-157
R014	Res ERJ3GEYJ 220 V (22 ohm)	022-3906-685
R015	Res ERJ3GEYJ 101 V (100 ohm)	022-3906-143
R016	Res ERJ3GEYJ 822 V (8.2 k ohm)	022-3906-256
R017	Res ERJ3GEYJ 182 V (1.8 k ohm)	022-3906-156
R018	Res ERJ3GEYJ 101 V (100 ohm)	022-3906-143
R019	Res ERJ3GEYJ 151 V (150 ohm)	022-3906-145
R020	Res ERJ3GEYJ 153 V (15 k ohm)	022-3906-165
R021	Res ERJ3GEYJ 562 V (5.6 k ohm)	022-3906-161
R022	Res ERJ3GEYJ 101 V (100 ohm)	022-3906-143
R023	Res ERJ3GEYJ 472 V (4.7 k ohm)	022-3906-160
R024	Res ERJ3GEYJ 101 V (100 ohm)	022-3906-143
R025	Res ERJ3GEYJ 472 V (4.7 k ohm)	022-3906-160
R026	Res ERJ3GEYJ 391 V (390 ohm)	022-3906-149
R027	Res ERJ3GEYJ 393 V (39 k ohm)	022-3906-170
R028	Res ERJ3GEYJ 471 V (470 ohm)	022-3906-150
R029	Res ERJ3GEYJ 683 V (68 k ohm)	022-3906-173
R030	Res ERJ3GEYJ 681 V (680 ohm)	022-3906-152
R031	Res ERJ3GEYJ 683 V (68 k ohm)	022-3906-173
R032	Res ERJ3GEYJ 101 V (100 ohm)	022-3906-143
R033	Res ERJ3GEYJ 471 V (470 ohm)	022-3906-150
R034	Res ERJ3GEYJ 822 V (8.2 k ohm)	022-3906-256
R035	Res ERJ3GEYJ 221 V (220 ohm)	022-3906-288
R036	Res ERJ3GEYJ 822 V (8.2 k ohm)	022-3906-256
R037	Res ERJ3GEYJ 102 V (1 k ohm)	022-3906-154
R038	Res ERJ3GEYJ 102 V (1 k ohm)	022-3906-154
R039	Res ERJ3GEYJ 473 V (47 k ohm)	022-3906-171
R040	Res ERJ3GEYJ 472 V (4.7 k ohm)	022-3906-160
R041	Res ERJ3GEYJ 102 V (1 k ohm)	022-3906-154
R042	Res ERJ3GEYJ 561 V (560 ohm)	022-3906-151
R043	Res ERJ3GEYJ 222 V (2.2 k ohm)	022-3906-157

7610 (VHF) Main Unit

Ref No.	Description	Part No.
R044	Res ERJ3GEYJ 100 V (10 ohm)	022-3906-138
R045	Res ERJ3GEYJ 222 V (2.2 k ohm)	022-3906-157
R046	Res ERJ3GEYJ 103 V (10 k ohm)	022-3906-163
R047	Res ERJ3GEYJ 102 V (1 k ohm)	022-3906-154
R048	Res ERJ3GEYJ 473 V (47 k ohm)	022-3906-171
R049	S ARRAY EXB-V8V 102JV	022-3906-700
R050	Res ERJ3GEYJ 101 V (100 ohm)	022-3906-143
R051	Res ERJ3GEYJ 101 V (100 ohm)	022-3906-143
R054	Res ERJ3GEYJ 473 V (47 k ohm)	022-3906-171
R055	Res RR0816R-753-D (75 k ohm)	022-3906-867
R059	Res ERJ3GEYJ 223 V (22 k ohm)	022-3906-167
R060	Res ERJ3GEYJ 153 V (15 k ohm)	022-3906-165
R061	Res ERJ3GEYJ 104 V (100 k ohm)	022-3906-175
R062	Res ERJ3GEYJ 104 V (100 k ohm)	022-3906-175
R063	Res ERJ3GEYJ 105 V (1 M ohm)	022-3906-184
R064	Res ERJ3GEYJ 105 V (1 M ohm)	022-3906-184
R066	Res ERJ3GEYJ 104 V (100 k ohm)	022-3906-175
R067	Res ERJ3GEYJ 103 V (10 k ohm)	022-3906-163
R069	Res ERJ3GEYJ 470 V (47 ohm)	022-3906-141
R071	Res ERJ3GEYJ 101 V (100 ohm)	022-3906-143
R072	Res ERJ3GEYJ 104 V (100 k ohm)	022-3906-175
R073	Res ERJ3GEYJ 104 V (100 k ohm)	022-3906-175
R074	Res ERJ3GEYJ 104 V (100 k ohm)	022-3906-175
R075	Res ERJ3GEYJ 105 V (1 M ohm)	022-3906-184
R076	Res ERJ3GEYJ 105 V (1 M ohm)	022-3906-184
R077	Res ERJ3GEYJ 101 V (100 ohm)	022-3906-143
R078	Res ERJ3GEYJ 472 V (4.7 k ohm)	022-3906-160
R081	Res ERJ3GEYJ 104 V (100 k ohm)	022-3906-175
R083	Res ERJ3GEYJ 103 V (10 k ohm)	022-3906-163
R084	Res ERJ3GEYJ 101 V (100 ohm)	022-3906-143
R086	Res ERJ3GEYJ 221 V (220 ohm)	022-3906-288
R087	Res ERJ3GEYJ 821 V (820 ohm)	022-3906-153
R089	Res ERJ3GEYJ 561 V (560 ohm)	022-3906-151
R090	Res ERJ3GEYJ 152 V (1.5 k ohm)	022-3906-155
R091	Res ERJ3GEYJ 104 V (100 k ohm)	022-3906-175
R092	Res ERJ3GEYJ 471 V (470 ohm)	022-3906-150
R093	Res ERJ3GEYJ 103 V (10 k ohm)	022-3906-163
R095	Res ERJ3GEYJ 152 V (1.5 k ohm)	022-3906-155
R096	Res ERJ3GEYJ 182 V (1.8 k ohm)	022-3906-156
R097	Res ERJ3GEYJ 471 V (470 ohm)	022-3906-150
R098	Res ERJ3GEYJ 104 V (100 k ohm)	022-3906-175
R099	Res ERJ3GEYJ 332 V (3.3 k ohm)	022-3906-159
R100	Res ERJ3GEYJ 334 V (330 k ohm)	022-3906-180
R101	Res ERJ3GEYJ 391 V (390 ohm)	022-3906-149
R102	Res ERJ3GEYJ 152 V (1.5 k ohm)	022-3906-155
R104	Res ERJ3GEYJ 100 V (10 ohm)	022-3906-138

Ref No.	Description	Part No.
R105	Res ERJ3GEYJ 153 V (15 k ohm)	022-3906-165
R106	Res ERJ3GEYJ 153 V (15 k ohm)	022-3906-165
R107	Res ERJ3GEYJ 223 V (22 k ohm)	022-3906-167
R108	Res ERJ3GEYJ 223 V (22 k ohm)	022-3906-167
R109	Res ERJ3GEYJ 103 V (10 k ohm)	022-3906-163
R110	Res ERJ3GEYJ 473 V (47 k ohm)	022-3906-171
R111	Res ERJ3GEYJ 101 V (100 ohm)	022-3906-143
R112	Res ERJ3GEYJ 101 V (100 ohm)	022-3906-143
R113	Res ERJ3GEYJ 392 V (3.9 k ohm)	022-3906-391
R114	Res MCR50JZHJ 680 ohm (681)	022-3906-865
R115	Res ERJ3GEYJ 103 V (10 k ohm)	022-3906-163
R116	Res ERJ3GEYJ 472 V (4.7 k ohm)	022-3906-160
R117	Res ERJ3GEYJ 154 V (150 k ohm)	022-3906-392
R118	Res ERJ3GEYJ 153 V (15 k ohm)	022-3906-165
R119	Res RR0816R-104-D (100 k ohm)	022-3906-395
R120	Res ERJ3GEYJ 472 V (4.7 k ohm)	022-
R121	Res RR0816R-304-D (300 k ohm)	022-3906-866
R122	Res RR0816R-753-D (75 k ohm)	022-3906-867
R123	Res ERJ3GEYJ 682 V (6.8 k ohm)	022-3906-162
R124	Res ERJ3GEYJ 104 V (100 k ohm)	022-3906-175
R125	Res ERJ3GEYJ 100 V (10 ohm)	022-3906-138
R126	Res ERJ3GEYJ 103 V (10 k ohm)	022-3906-163
R127	Res ERJ3GEYJ 104 V (100 k ohm)	022-3906-175
R128	Res ERJ3GEYJ 104 V (100 k ohm)	022-3906-175
R129	Res ERJ3GEYJ 561 V (560 ohm)	022-3906-151
R130	Res ERJ3GEYJ 103 V (10 k ohm)	022-3906-163
R131	Res ERJ3GEYJ 683 V (68 k ohm)	022-3906-173
R133	Res ERJ3GEYJ 473 V (47 k ohm)	022-3906-171
R134	Res ERJ3GEYJ 472 V (4.7 k ohm)	022-3906-160
R135	Res ERJ3GEYJ 273 V (27 k ohm)	022-3906-168
R136	Res ERJ3GEYJ 683 V (68 k ohm)	022-3906-173
R137	Res ERJ3GEYJ 105 V (1 M ohm)	022-3906-184
R139	Res ERJ3GEYJ 105 V (1 M ohm)	022-3906-184
R140	Res ERJ3GEYJ 101 V (100 ohm)	022-3906-143
R141	Res RR0816R-104-D (100 k ohm)	022-3906-395
R142	Res RR0816R-104-D (100 k ohm)	022-3906-395
R143	Res RR0816R-104-D (100 k ohm)	022-3906-395
R145	Res ERJ3GEYJ 103 V (10 k ohm)	022-3906-163
R146	Res ERJ3GEYJ 683 V (68 k ohm)	022-3906-173
R147	Res ERJ3GEYJ 184 V (180 k ohm)	022-3906-177
R148	Res ERJ3GEYJ 563 V (56 k ohm)	022-3906-172
R149	Res ERJ3GEYJ 184 V (180 k ohm)	022-3906-177
R150	Res ERJ3GEYJ 224 V (220 k ohm)	022-3906-178
R151	Res ERJ3GEYJ 103 V (10 k ohm)	022-3906-163
R152	Res ERJ3GEYJ 103 V (10 k ohm)	022-3906-163
R153	Res ERJ3GEYJ 103 V (10 k ohm)	022-3906-163

7610 (VHF) Main Unit

Ref No.	Description	Part No.
R154	Res ERJ3GEYJ 104 V (100 k ohm)	022-3906-175
R155	Res ERJ3GEYJ 103 V (10 k ohm)	022-3906-163
R156	Res ERJ3GEYJ 684 V (680 k ohm)	022-3906-183
R157	Res ERJ3GEYJ 123 V (12 k ohm)	022-3906-164
R158	Res ERJ3GEYJ 684 V (680 k ohm)	022-3906-183
R159	Res ERJ3GEYJ 103 V (10 k ohm)	022-3906-163
R160	Res ERJ3GEYJ 153 V (15 k ohm)	022-3906-165
R161	Res ERJ3GEYJ 474 V (470 k ohm)	022-3906-181
R162	Res ERJ3GEYJ 683 V (68 k ohm)	022-3906-173
R163	Res ERJ3GEYJ 105 V (1 M ohm)	022-3906-184
R164	Res ERJ3GEYJ 472 V (4.7 k ohm)	022-3906-160
R165	Res ERJ3GEYJ 473 V (47 k ohm)	022-3906-171
R166	Res ERJ3GEYJ 124 V (120 k ohm)	022-3906-176
R167	Res ERJ3GEYJ 472 V (4.7 k ohm)	022-3906-160
R168	Res ERJ3GEYJ 105 V (1 M ohm)	022-3906-184
R169	Res ERJ3GEYJ 222 V (2.2 k ohm)	022-3906-157
R170	Res ERJ3GEYJ 105 V (1 M ohm)	022-3906-184
R171	Res ERJ3GEYJ 105 V (1 M ohm)	022-3906-184
R172	Res ERJ3GEYJ 153 V (15 k ohm)	022-3906-165
R174	Res ERJ3GEYJ 684 V (680 k ohm)	022-3906-183
R175	Res ERJ3GEYJ 103 V (10 k ohm)	022-3906-163
R176	Res ERJ3GEYJ 684 V (680 k ohm)	022-3906-183
R177	Res ERJ3GEYJ 473 V (47 k ohm)	022-3906-171
R178	Res ERJ3GEYJ 333 V (33 k ohm)	022-3906-169
R179	Res ERJ3GEYJ 154 V (150 k ohm)	022-3906-392
R180	Res ERJ3GEYJ 393 V (39 k ohm)	022-3906-170
R181	Res ERJ3GEYJ 472 V (4.7 k ohm)	022-3906-160
R182	Res ERJ3GEYJ 473 V (47 k ohm)	022-3906-171
R183	Res ERJ3GEYJ 104 V (100 k ohm)	022-3906-175
R184	Res ERJ3GEYJ 104 V (100 k ohm)	022-3906-175
R185	Thermistor NTCCF2012 4AH 473KC-T	022-3906-403
R186	Res RR0816R-104-D (100 k ohm)	022-3906-395
R187	Res ERJ3GEYJ 105 V (1 M ohm)	022-3906-184
R188	Res ERJ3GEYJ 105 V (1 M ohm)	022-3906-184
R189	Res ERJ3GEYJ 105 V (1 M ohm)	022-3906-184
R190	Res ERJ3GEYJ 104 V (100 k ohm)	022-3906-175
R191	Res ERJ3GEYJ 104 V (100 k ohm)	022-3906-175
R192	Res ERJ3GEYJ 104 V (100 k ohm)	022-3906-175
R193	Res ERJ3GEYJ 222 V (2.2 k ohm)	022-3906-157
R194	Res ERJ3GEYJ 103 V (10 k ohm)	022-3906-163
R195	Res ERJ3GEYJ 103 V (10 k ohm)	022-3906-163
R196	Res ERJ3GEYJ 473 V (47 k ohm)	022-3906-171
R197	Res MCR50JZHJ 1 k ohm (102)	022-3906-868
R198	Res ERJ3GEYJ 473 V (47 k ohm)	022-3906-171
R199	Res ERJ3GEYJ 472 V (4.7 k ohm)	022-3906-160

Ref No.	Description	Part No.
R200	Res ERJ3GEYJ 473 V (47 k ohm)	022-3906-171
R201	Res ERJ3GEYJ 102 V (1 k ohm)	022-3906-154
R202	Res ERJ3GEYJ 103 V (10 k ohm)	022-3906-163
R203	Res ERJ3GEYJ 472 V (4.7 k ohm)	022-3906-160
R204	Res ERJ3GEYJ 102 V (1 k ohm)	022-3906-154
R205	Res RR0816R-304-D (300 k ohm)	022-3906-866
R206	Res RR0816R-104-D (100 k ohm)	022-3906-395
R207	Res ERJ3GEYJ 104 V (100 k ohm)	022-3906-175
R208	Res ERJ3GEYJ 105 V (1 M ohm)	022-3906-184
R209	Res ERJ3GEYJ 105 V (1 M ohm)	022-3906-184
R210	Res ERJ3GEYJ 105 V (1 M ohm)	022-3906-184
R211	Res ERJ3GEYJ 222 V (2.2 k ohm)	022-3906-157
R212	Array EXB-V8V 102JV	022-3906-700
R213	Array EXB-V8V 102JV	022-3906-700
R214	Array EXB-V8V 102JV	022-3906-700
R215	Array EXB-V8V 102JV	022-3906-700
R216	Array EXB-V8V 102JV	022-3906-700
R217	Array EXB-V8V 102JV	022-3906-700
R218	Array EXB-V8V 102JV	022-3906-700
R219	Array EXB-V8V 102JV	022-3906-700
R220	Res ERJ3GEYJ 101 V (100 ohm)	022-3906-143
R221	Res MCR18EZHZ 22 ohm (220)	022-3906-870
R222	Res ERJ3GEYJ 473 V (47 k ohm)	022-3906-171
R223	Res ERJ3GEYJ 333 V (33 k ohm)	022-3906-169
R226	Res ERJ3GEYJ 184 V (180 k ohm)	022-3906-177
R227	Res ERJ3GEYJ 684 V (680 k ohm)	022-3906-183
R228	Res ERJ3GEYJ 183 V (18 k ohm)	022-3906-166
R229	Res ERJ3GEYJ 473 V (47 k ohm)	022-3906-171
R230	Res ERJ3GEYJ 222 V (2.2 k ohm)	022-3906-157
R232	Res ERJ3GEYJ 474 V (470 k ohm)	022-3906-181
R233	Res ERJ3GEYJ 102 V (1 k ohm)	022-3906-154
R234	Res ERJ3GEYJ 104 V (100 k ohm)	022-3906-175
R235	Res ERJ3GEYJ 103 V (10 k ohm)	022-3906-163
R236	Res ERJ3GEYJ 104 V (100 k ohm)	022-3906-175
R237	Res ERJ3GEYJ 102 V (1 k ohm)	022-3906-154
R238	Res ERJ3GEYJ 183 V (18 k ohm)	022-3906-166
R240	Res ERJ3GEYJ 682 V (6.8 k ohm)	022-3906-162
R241	Res ERJ3GEYJ 104 V (100 k ohm)	022-3906-175
R242	Res ERJ3GEYJ 471 V (470 ohm)	022-3906-150
R243	Res MCR18EZHZ 68 ohm (680)	022-3906-871
R245	Res ERJ3GEYJ 103 V (10 k ohm)	022-3906-163
R246	Res ERJ3GEYJ 561 V (560 ohm)	022-3906-151
R247	Res ERJ3GEYJ 473 V (47 k ohm)	022-3906-171
R248	Res RR0816R-334-D (330 k ohm)	022-3906-691
R249	Res ERJ3GEYJ 103 V (10 k ohm)	022-3906-163
R251	S Posistor PTH9C32BB471Q-T	022-3906-872

7610 (VHF) Main Unit

Ref No.	Description	Part No.
R252	Res ERJ3GEYJ 153 V (15 k ohm)	022-3906-165
W1	Jumper ERDS2T0	022-3906-877
W6	Jumper ERJ3GE JPW V	022-3906-185
W7	Cable OPC-453	022-3906-878
X1	Crystal CR-575 (15.3 MHz)	022-3906-879
X3	Discriminator CDBCA450CX24	022-3906-642

Ref No.	Description	Part No.
7640 (UHF) MAIN UNIT		
C001	Cer GRM42-6 CH 070D 500PT 400-470 MHz)	022-3906-803
	Cer GRM42-6 CH 060D 500PT (470-512 MHz)	022-3906-900
C002	Cer GRM42-6 CH 070D 500PT 400-470 MHz)	022-3906-803
	Cer GRM42-6 CH 060D 500PT (470-512 MHz)	022-3906-900
C003	Ceramic C1608 JB 1H 102K-T-A	022-3906-060
C005	Ceramic C1608 JB 1H 102K-T-A	022-3906-060
C006	Ceramic C1608 JB 1H 102K-T-A	022-3906-060
C007	Ceramic C1608 CH 1H 070D-T-A	022-3906-596
C008	Ceramic C1608 JB 1H 102K-T-A	022-3906-060
C009	Cer GRM42-6 CH 070D 500PT (400-470 MHz)	022-3906-803
	Cer GRM42-6 CH 060D 500PT (470-490 MHz)	022-3906-900
	Cer GRM42-6 CH 040D 500PT (490-512 MHz)	022-3906-910
C010	Cer GRM42-6 CH 090D 500PT (400-470 MHz)	022-3906-901
	Ceramic GRM42-6 CH 100D 500PT (470-490 MHz)	022-3906-902
C011	Ceramic GRM42-6 CK 020C 500PT (400-430 MHz only)	022-3906-795
	Ceramic GRM42-6 CK 010C 500PT (other bands)	022-3906-904
C012	Ceramic GRM42-6 CJ 030C 500PT (470-490 MHz)	022-3906-905
	Ceramic GRM42-6 CH 050C 500PT (other bands)	022-3906-906
C013	Ceramic HM60SJ SL 470J 500V	022-3906-907

7640 (UHF) Main Unit

Ref No.	Description	Part No.
C014	Ceramic GRM42-6 CH 040C 500PT (400-470 MHz)	022-3906-910
	Ceramic GRM42-6 CJ 030C 500PT (470-512 MHz)	022-3906-905
C015	Ceramic C1608 CH 1H 470J-T-A	022-3906-600
C016	Ceramic C1608 JB 1H 471K-T-A	022-3906-059
C017	Ceramic GRM42-6 CK 020C 500PT (490-512 MHz only)	022-3906-795
	Ceramic GRM42-6 CH 080D 500PT (other bands)	022-3906-819
C018	Ceramic C1608 CH 1H 2R5B-T-A	022-3906-071
C019	Ceramic C1608 JB 1H 102K-T-A	022-3906-060
C020	Ceramic C1608 CH 1H 1R5B-T-A	022-3906-087
C021	Ceramic C1608 CH 1H 470J-T-A	022-3906-600
C022	Ceramic C1608 CH 1H 060B-T-A (400-430 MHz)	022-3906-615
	Ceramic C1608 CH 1H 040B-T-A (470-490 MHz)	022-3906-609
	Ceramic C1608 CH 1H 050B-T-A (450-470 MHz, 490-512 MHz)	022-3906-610
C023	Ceramic C1608 CH 1H 020B-T-A (400-430 MHz)	022-3906-086
	Ceramic C1608 CH 1H 1R5B-T-A (450-490 MHz)	022-3906-087
C024	Ceramic C1608 CH 1H 010B-T-A (400-430 MHz only)	022-3906-085
	Ceramic C1608 CH 1H 0R5B-T-A (other bands)	022-3906-084
C025	Ceramic C1608 CH 1H 0R75B-T-A (490-512 MHz only)	022-3906-490
	Ceramic C1608 CH 1H 010B-T-A (other bands)	022-3906-085
C026	Ceramic C1608 CH 1H 070D-T-A (400-430 MHz)	022-3906-596
	Ceramic C1608 CH 1H 060B-T-A (450-470 MHz)	022-3906-615
	Ceramic C1608 CH 1H 050B-T-A (470-512 MHz)	022-3906-610
C027	Ceramic C1608 CH 1H 470J-T-A	022-3906-600
C028	Ceramic C1608 CH 1H 1R5B-T-A (400-430 MHz only)	022-3906-087
	Ceramic C1608 CH 1H 0R5B-T-A (450-490 MHz)	022-3906-084
C029	Ceramic C1608 CH 1H 2R5B-T-A (490-512 MHz only)	022-3906-071
	Ceramic C1608 CH 1H 040B-T-A (other bands)	022-3906-609
C030	Ceramic C1608 JB 1H 102K-T-A	022-3906-060

7640 (UHF) Main Unit

Ref No.	Description	Part No.
C031	Ceramic C1608 JB 1H 102K-T-A	022-3906-060
C032	Ceramic C1608 CH 1H 2R5B-T-A (400-430 MHz)	022-3906-071
	Ceramic C1608 CH 1H 1R5B-T-A (450-470 MHz)	022-3906-087
	Ceramic C1608 CH 1H 020B-T-A (470-490 MHz)	022-3906-086
	Ceramic C1608 CH 1H 010B-T-A (490-512 MHz)	022-3906-085
C033	Ceramic C1608 CH 1H 470J-T-A	022-3906-600
C034	Ceramic C1608 CH 1H 070D-T-A (400-430 MHz)	022-3906-596
	Ceramic C1608 CH 1H 060B-T-A (450-470 MHz)	022-3906-615
	Ceramic C1608 CH 1H 040B-T-A (470-512 MHz)	022-3906-609
C035	Ceramic C1608 CH 1H 470J-T-A	022-3906-600
C036	Ceramic C1608 CH 1H 0R5B-T-A	022-3906-084
C037	Ceramic C1608 CH 1H 010B-T-A (400-430 MHz only)	022-3906-085
	Ceramic C1608 CH 1H 0R3B-T-A (other bands)	022-3906-468
C038	Ceramic C1608 CH 1H 2R5B-T-A (400-430 MHz)	022-3906-071
	Ceramic C1608 CH 1H 1R5B-T-A (450-490 MHz)	022-3906-087
	Ceramic C1608 CH 1H 0R5B-T-A (490-512 MHz)	022-3906-084
C039	Ceramic C1608 CH 1H 070D-T-A (400-430 MHz)	022-3906-596
	Ceramic C1608 CH 1H 060B-T-A (450-470 MHz)	022-3906-615
	Ceramic C1608 CH 1H 050B-T-A (other bands)	022-3906-610
C040	Ceramic C1608 CH 1H 470J-T-A	022-3906-600
C041	Ceramic C1608 CH 1H 010B-T-A	022-3906-085
C042	Ceramic C1608 CH 1H 030B-T-A	022-3906-489
C043	Ceramic C1608 JB 1H 102K-T-A	022-3906-060
C044	Ceramic C1608 JB 1H 102K-T-A	022-3906-060
C045	Ceramic C1608 CH 1H 680J-T-A	022-3906-798
C046	Ceramic C1608 JB 1H 102K-T-A	022-3906-060
C047	Ceramic C1608 CH 1H 120J-T-A	022-3906-066
C048	Ceramic C1608 JB 1H 102K-T-A	022-3906-060
C049	Ceramic C1608 JB 1H 102K-T-A	022-3906-060
C050	Ceramic C1608 CH 1H 680J-T-A	022-3906-798
C051	Ceramic C1608 CH 1H 101J-T-A	022-3906-072
C052	Ceramic C1608 CH 1H 101J-T-A	022-3906-072
C054	Ceramic C1608 JB 1H 102K-T-A	022-3906-060

Ref No.	Description	Part No.
C055	Ceramic C1608 JB 1H 102K-T-A	022-3906-060
C056	Ceramic C1608 JB 1H 102K-T-A	022-3906-060
C057	Tantalum ECST0JY475R	022-3906-629
C058	Ceramic C1608 JB 1H 102K-T-A	022-3906-060
C059	Ceramic C1608 JB 1H 102K-T-A	022-3906-060
C060	Ceramic C1608 JB 1E 103K-T-A	022-3906-063
C061	Ceramic C1608 CH 1H 271J-T-A	022-3906-525
C062	Ceramic C1608 CH 1H 271J-T-A	022-3906-525
C063	Ceramic C1608 JB 1C 104KT-N	022-3906-614
C064	Ceramic C1608 JB 1C 104KT-N	022-3906-614
C065	Ceramic C1608 JB 1E 103K-T-A	022-3906-063
C066	Ceramic C1608 JB 1E 103K-T-A	022-3906-063
C067	Ceramic C1608 CH 1H 470J-T-A	022-3906-600
C068	Electrolytic ECEV1CA100SR	022-3906-617
C069	Tantalum ECST1CY475R	022-3906-921
C070	Ceramic C1608 CH 1H 470J-T-A	022-3906-600
C071	Electrolytic ECEV1CA100SR	022-3906-617
C072	Tantalum ECST1EY105R	022-3906-632
C073	Ceramic C2012 JF 1E 104Z-T-A	022-3906-922
C074	Electrolytic ECEV1EA221P	022-3906-805
C075	Electrolytic ECEV1CA100SR	022-3906-617
C076	Ceramic C1608 JF 1C 104Z-T-A	022-3906-076
C077	Ceramic C1608 JB 1H 102K-T-A	022-3906-060
C078	Electrolytic ECEV1CA100SR	022-3906-617
C079	Electrolytic ECEV1CA100SR	022-3906-617
C080	Ceramic C1608 JF 1C 104Z-T-A	022-3906-076
C081	Ceramic C2012 JF 1E 104Z-T-A	022-3906-922
C082	Ceramic C1608 JB 1E 103K-T-A	022-3906-063
C083	Ceramic C2012 JF 1E 104Z-T-A	022-3906-922
C084	Electrolytic 25 MV 470 HC	022-3906-807
C085	Ceramic C1608 JB 1H 102K-T-A	022-3906-060
C086	Ceramic C1608 CH 1H 470J-T-A	022-3906-600
C087	Ceramic C1608 CH 1H 470J-T-A	022-3906-600
C088	Ceramic C1608 JB 1C 223K-T-A	022-3906-079
C089	Ceramic C1608 JB 1H 102K-T-A	022-3906-060
C090	Ceramic C1608 JF 1C 104Z-T-A	022-3906-076
C091	Electrolytic ECEV 1CA 4R7NR (16V 4.7)	022-3906-916
C092	Electrolytic ECEV1CA100SR	022-3906-617
C093	Ceramic HM60SJ CH 060D 500V (400-430 MHz)	022-3906-930
	Ceramic HM60SJ CH 050D 500V (490-512 MHz)	022-3906-929
	Ceramic HM60SJ CH 040C 500V (other bands)	022-3906-928

7640 (UHF) Main Unit

Ref No.	Description	Part No.
C094	Ceramic HM60SJ CH 030D 500V (400-430 MHz)	022-3906-932
	Ceramic HM60SJ CH 060D 500V (450-470 MHz)	022-3906-930
	Ceramic HM60SJ CH 040C 500V (470-490 MHz)	022-3906-928
	Ceramic HM60SJ CK 020C 500V (490-512 MHz)	022-3906-931
C095	Electrolytic ECEV1EA220SP	022-3906-903
C096	Ceramic C1608 JB 1H 102K-T-A	022-3906-060
C097	Ceramic C1608 CH 1H 470J-T-A	022-3906-600
C098	Ceramic C1608 JB 1H 102K-T-A	022-3906-060
C099	Ceramic C1608 CH 1H 470J-T-A	022-3906-600
C100	Electrolytic ECEV1EA220SP	022-3906-903
C101	Ceramic C1608 CH 1H 050B-T-A	022-3906-610
C102	Ceramic C1608 CH 1H 080D-T-A (490-512 MHz)	022-3906-597
	Ceramic C1608 CH 1H 080D-T-A (other bands)	022-3906-597
C103	Ceramic C1608 CH 1H 060B-T-A	022-3906-615
C104	Ceramic C1608 JB 1H 471K-T-A	022-3906-059
C105	Ceramic C1608 JB 1H 471K-T-A	022-3906-059
C106	Ceramic C1608 CH 1H 070D-T-A	022-3906-596
C107	Ceramic C1608 JB 1H 471K-T-A	022-3906-059
C108	Ceramic C1608 CH 1H 080D-T-A (490-512 MHz)	022-3906-597
	Ceramic C1608 CH 1H 100D-T-A (other bands)	022-3906-598
C109	Ceramic C1608 CH 1H 050B-T-A (490-512 MHz)	022-3906-610
	Ceramic C1608 CH 1H 060B-T-A (other bands)	022-3906-615
C110	Ceramic C1608 JB 1H 102K-T-A	022-3906-060
C111	Ceramic C1608 JB 1H 102K-T-A	022-3906-060
C112	Ceramic C1608 JB 1H 102K-T-A	022-3906-060
C113	Ceramic C1608 CH 1H 070D-T-A	022-3906-596
C115	Ceramic C1608 JB 1H 102K-T-A	022-3906-060
C116	Ceramic C1608 JB 1H 102K-T-A	022-3906-060
C117	Ceramic C1608 CH 1H 470J-T-A	022-3906-600
C118	Ceramic C1608 JB 1H 471K-T-A	022-3906-059
C119	Ceramic C1608 JB 1H 102K-T-A	022-3906-060
C120	Ceramic C1608 JB 1H 471K-T-A	022-3906-059
C121	Ceramic C1608 CH 1H 100D-T-A	022-3906-598
C126	Ceramic C1608 JB 1C 473K-T-A	022-3906-080
C127	Ceramic C1608 JB 1C 473K-T-A	022-3906-080
C128	Ceramic C1608 JB 1C 473K-T-A	022-3906-080
C129	Ceramic C1608 JB 1C 473K-T-A	022-3906-080

Ref No.	Description	Part No.
C130	Ceramic C1608 JB 1C 473K-T-A	022-3906-080
C131	Ceramic C1608 JB 1H 471K-T-A	022-3906-059
C132	Ceramic C2012 JB 1A 564K-T-A	022-3906-075
C133	Ceramic C1608 JF 1C 104Z-T-A	022-3906-076
C134	Ceramic C1608 JB 1H 102K-T-A	022-3906-060
C135	Tantalum ECST1AY225R	022-3906-626
C137	Ceramic C1608 JB 1H 471K-T-A	022-3906-059
C138	Ceramic C1608 JB 1H 102K-T-A	022-3906-060
C139	Ceramic C1608 UJ 1H 080D-T-A (400-430 MHz)	022-3906-908
	Ceramic C1608 UJ 1H 060D-T-A (450-470 MHz)	022-3906-606
	Ceramic C1608 UJ 1H 040D-T-A (470-512 MHz)	022-3906-604
C141	Ceramic C1608 UJ 1H 180J-T-A (400-430 MHz)	022-3906-794
	Ceramic C1608 UJ 1H 150J-T-A (450-490 MHz)	022-3906-074
	Ceramic C1608 UJ 1H 120J-T-A (490-512 MHz)	022-3906-793
C142	Ceramic C1608 CH 1H 100D-T-A (400-430 MHz)	022-3906-598
	Ceramic C1608 CH 1H 060B-T-A (450-470 MHz)	022-3906-615
	Ceramic C1608 CH 1H 050B-T-A (470-490 MHz)	022-3906-610
	Ceramic C1608 CH 1H 030B-T-A (490-512 MHz)	022-3906-489
C143	Ceramic C1608 CH 1H 120J-T-A (400-430 MHz)	022-3906-066
	Ceramic C1608 CH 1H 080D-T-A (450-470 MHz)	022-3906-597
	Ceramic C1608 CH 1H 060B-T-A (470-490 MHz)	022-3906-615
	Ceramic C1608 CH 1H 050B-T-A (490-512 MHz)	022-3906-610
C144	Ceramic C1608 JB 1H 102K-T-A	022-3906-060
C145	Ceramic C1608 CH 1H 470J-T-A	022-3906-600
C146	Ceramic C1608 CH 1H 0R5B-T-A	022-3906-084
C147	Ceramic C1608 CH 1H 010B-T-A	022-3906-085
C148	Ceramic C1608 UJ 1H 050C-T-A (400-430, 470-490 MHz)	022-3906-605
	Ceramic C1608 UJ 1H 040C-T-A (450-470, 490-512 MHz)	022-3906-604
C149	Ceramic C1608 CH 1H 010B-T-A (470-490 MHz)	022-3906-085
	Ceramic C1608 CH 1H 3R5B-T-A (490-512 MHz)	022-3906-353

7640 (UHF) Main Unit

Ref No.	Description	Part No.
C150	Ceramic C1608 UJ 1H 100D-T-A (400-430 MHz)	022-3906-912
	Ceramic C1608 UJ 1H 080D-T-A (450-470 MHz)	022-3906-908
	Ceramic C1608 UJ 1H 150J-T-A (470-490 MHz)	022-3906-074
	Ceramic C1608 UJ 1H 040C-T-A (490-512 MHz)	022-3906-604
C151	Ceramic C1608 CH 1H 050B-T-A (400-430 MHz)	022-3906-610
	Ceramic C1608 CH 1H 020B-T-A (450-470 MHz)	022-3906-086
	Ceramic C1608 CH 1H 080D-T-A (470-490 MHz)	022-3906-597
	Ceramic C1608 CH 1H 030B-T-A (490-512 MHz)	022-3906-489
C152	Ceramic C1608 CH 1H 080D-T-A (400-430, 470-490 MHz)	022-3906-597
	Ceramic C1608 CH 1H 040B-T-A (450-470 MHz)	022-3906-609
	Ceramic C1608 CH 1H 030B-T-A (490-512 MHz)	022-3906-489
C153	Ceramic C1608 JB 1H 102K-T-A	022-3906-060
C154	Ceramic C1608 CH 1H 470J-T-A	022-3906-600
C155	Ceramic C1608 CH 1H 0R5B-T-A	022-3906-084
C156	Ceramic C1608 JB 1H 471K-T-A	022-3906-059
C157	Ceramic C1608 JB 1H 471K-T-A	022-3906-059
C158	Ceramic C1608 CH 1H 120J-T-A	022-3906-066
C159	Ceramic C1608 CH 1H 020B-T-A	022-3906-086
C160	Ceramic C1608 CH 1H 070D-T-A	022-3906-596
C161	Ceramic C1608 JB 1H 471K-T-A	022-3906-059
C162	Ceramic C1608 CH 1H 060B-T-A	022-3906-615
C163	Ceramic C1608 JB 1H 102K-T-A	022-3906-060
C164	Ceramic C1608 CH 1H 060B-T-A	022-3906-615
C165	Ceramic C1608 CH 1H 060B-T-A	022-3906-615
C166	Ceramic C1608 JB 1H 102K-T-A	022-3906-060
C167	Electrolytic ECEV1CA100SR	022-3906-617
C169	Ceramic C1608 CH 1H 120J-T-A	022-3906-066
C170	Ceramic C1608 CH 1H 050B-T-A	022-3906-610
C171	Ceramic C1608 CH 1H 040B-T-A	022-3906-609
C172	Ceramic C1608 CH 1H 050B-T-A	022-3906-610
C173	Ceramic C1608 CH 1H 120J-T-A	022-3906-066
C174	Ceramic C1608 JB 1C 104KT-N	022-3906-614
C175	Ceramic C1608 JB 1C 104KT-N	022-3906-614
C176	Tantalum ECST1CY225R	022-3906-815
C177	Ceramic C1608 JB 1H 102K-T-A	022-3906-060
C178	Ceramic C1608 CH 1H 470J-T-A	022-3906-600

Ref No.	Description	Part No.
C179	Ceramic C1608 JF 1C 104Z-T-A	022-3906-076
C180	Ceramic C1608 JB 1H 392K-T-A	022-3906-612
C183	Ceramic C1608 JF 1C 104Z-T-A	022-3906-076
C184	Ceramic C1608 CH 1H 220J-T-A	022-3906-065
C185	Ceramic C1608 JB 1C 104KT-N	022-3906-614
C186	Ceramic C1608 JB 1C 104KT-N	022-3906-614
C187	Ceramic C1608 JB 1C 104KT-N	022-3906-614
C188	Tantalum ECST0JY475R	022-3906-629
C189	Ceramic C1608 JB 1C 104KT-N	022-3906-614
C190	Ceramic C1608 JF 1C 104Z-T-A	022-3906-076
C191	Ceramic C1608 JB 1C 123K-T-A	022-3906-350
C193	Ceramic C1608 JB 1C 104KT-N	022-3906-614
C194	Electrolytic ECEV1EA221P	022-3906-805
C195	Electrolytic ECEV1AA471UP	022-3906-810
C196	Ceramic C1608 JB 1H 102K-T-A	022-3906-060
C197	Ceramic C1608 JB 1H 102K-T-A	022-3906-060
C198	Electrolytic ECEV1CA100SR	022-3906-617
C199	Ceramic C1608 JB 1H 102K-T-A	022-3906-060
C200	Ceramic C1608 JB 1H 102K-T-A	022-3906-060
C201	Tantalum ECST1VY104R	022-3906-630
C202	Ceramic C1608 JB 1C 223K-T-A	022-3906-079
C203	Tantalum ECST1VY474R	022-3906-914
C204	Tantalum ECST1VY474R	022-3906-914
C205	Ceramic C1608 JB 1H 102K-T-A	022-3906-060
C206	Electrolytic ECEV1CA100SR	022-3906-617
C207	Ceramic C1608 JB 1H 471K-T-A	022-3906-059
C208	Ceramic C1608 JB 1H 472K-T-A	022-3906-062
C209	Ceramic C1608 JB 1H 102K-T-A	022-3906-060
C210	Tantalum ECST1AY225R	022-3906-626
C211	Ceramic C1608 JF 1C 104Z-T-A	022-3906-076
C212	Electrolytic ECEV 1CA 4R7NR (16V 4.7)	022-3906-916
C213	Ceramic C1608 JB 1H 102K-T-A	022-3906-060
C214	Ceramic C1608 CH 1H 080D-T-A	022-3906-597
C215	Ceramic C1608 CH 1H 080D-T-A	022-3906-597
C216	Ceramic C1608 CH 1H 220J-T-A	022-3906-065
C217	Ceramic C1608 CH 1H 220J-T-A	022-3906-065
C218	Ceramic C1608 CH 1H 220J-T-A	022-3906-065
C219	Ceramic C1608 JB 1H 102K-T-A	022-3906-060
C221	Ceramic C1608 JB 1H 272K-T-A	022-3901-393
C222	Ceramic C1608 CH 1H 180J-T-A	022-3906-068
C223	Ceramic C1608 CH 1H 120J-T-A	022-3906-066
C225	Ceramic C1608 JB 1E 103K-T-A	022-3906-063
C226	Ceramic C1608 JB 1E 103K-T-A	022-3906-063
C227	Ceramic C1608 JB 1E 103K-T-A	022-3906-063
C228	Ceramic C1608 JB 1H 102K-T-A	022-3906-060

7640 (UHF) Main Unit

Ref No.	Description	Part No.
C229	Ceramic C1608 JB 1H 102K-T-A	022-3906-060
C230	Ceramic C1608 JB 1H 102K-T-A	022-3906-060
C231	Ceramic C1608 JB 1H 102K-T-A	022-3906-060
C232	Ceramic C1608 JB 1E 103K-T-A	022-3906-063
C233	Ceramic C1608 JB 1H 102K-T-A	022-3906-060
C234	Ceramic C1608 JB 1H 102K-T-A	022-3906-060
C235	Ceramic C1608 JB 1H 102K-T-A	022-3906-060
C236	Ceramic C1608 JB 1C 104KT-N	022-3906-614
C237	Ceramic C3216 JB 1C 105M-T-A	022-3906-917
C238	Electrolytic ECEV1CA100SR	022-3906-617
C239	Ceramic C1608 JB 1H 102K-T-A	022-3906-060
C240	Ceramic C1608 JB 1H 102K-T-A	022-3906-060
C241	Ceramic C1608 CH 1H 470J-T-A	022-3906-600
C242	Ceramic C1608 CH 1H 470J-T-A	022-3906-600
C243	Ceramic C1608 CH 1H 470J-T-A	022-3906-600
C244	Ceramic C1608 CH 1H 470J-T-A	022-3906-600
C245	Ceramic C1608 CH 1H 470J-T-A	022-3906-600
C246	Ceramic C1608 CH 1H 470J-T-A	022-3906-600
C247	Ceramic C1608 CH 1H 470J-T-A	022-3906-600
C248	Ceramic C1608 CH 1H 470J-T-A	022-3906-600
C249	Ceramic C1608 CH 1H 470J-T-A	022-3906-600
C250	Ceramic C1608 CH 1H 470J-T-A	022-3906-600
C251	Ceramic C1608 CH 1H 470J-T-A	022-3906-600
C252	Ceramic C1608 CH 1H 470J-T-A	022-3906-600
C253	Ceramic C1608 CH 1H 470J-T-A	022-3906-600
C254	Ceramic C1608 CH 1H 470J-T-A	022-3906-600
C255	Ceramic C1608 CH 1H 470J-T-A	022-3906-600
C256	Ceramic C1608 CH 1H 470J-T-A	022-3906-600
C257	Ceramic C1608 CH 1H 470J-T-A	022-3906-600
C258	Ceramic C1608 CH 1H 470J-T-A	022-3906-600
C259	Ceramic C1608 CH 1H 470J-T-A	022-3906-600
C260	Ceramic C1608 CH 1H 470J-T-A	022-3906-600
C261	Ceramic C1608 CH 1H 470J-T-A	022-3906-600
C262	Ceramic C1608 CH 1H 470J-T-A	022-3906-600
C263	Ceramic C1608 CH 1H 470J-T-A	022-3906-600
C264	Ceramic C1608 CH 1H 100D-T-A	022-3906-598
C265	Ceramic C1608 CH 1H 470J-T-A	022-3906-600
C266	Ceramic C1608 CH 1H 470J-T-A	022-3906-600
C267	Ceramic C1608 CH 1H 470J-T-A	022-3906-600
C268	Ceramic C1608 CH 1H 470J-T-A	022-3906-600
C269	Ceramic C1608 CH 1H 470J-T-A	022-3906-600
C270	Ceramic C1608 CH 1H 470J-T-A	022-3906-600
C271	Ceramic C1608 CH 1H 470J-T-A	022-3906-600
C272	Ceramic C1608 CH 1H 470J-T-A	022-3906-600
C273	Ceramic C1608 CH 1H 470J-T-A	022-3906-600
C274	Ceramic C1608 CH 1H 470J-T-A	022-3906-600

Ref No.	Description	Part No.
C275	Ceramic C1608 CH 1H 470J-T-A	022-3906-600
C276	Ceramic C1608 CH 1H 470J-T-A	022-3906-600
C277	Ceramic C1608 CH 1H 470J-T-A	022-3906-600
C278	Ceramic C1608 CH 1H 470J-T-A	022-3906-600
C279	Ceramic C1608 CH 1H 470J-T-A	022-3906-600
C281	Ceramic C1608 JB 1C 104KT-N	022-3906-614
C282	Electrolytic ECEV0JA220SR	022-3906-623
C283	Ceramic C1608 JB 1H 471K-T-A	022-3906-059
C284	Ceramic C1608 CH 1H 470J-T-A	022-3906-600
C285	Ceramic C1608 JB 1H 102K-T-A	022-3906-060
C286	Ceramic C1608 CH 1H 470J-T-A	022-3906-600
C287	Ceramic C1608 CH 1H 470J-T-A	022-3906-600
C288	Ceramic C1608 JB 1H 102K-T-A	022-3906-060
C289	Ceramic C1608 JB 1H 102K-T-A	022-3906-060
C291	Ceramic C1608 JB 1C 104KT-N	022-3906-614
C292	Ceramic C1608 JB 1C 473K-T-A	022-3906-080
C293	Ceramic C1608 JB 1H 102K-T-A	022-3906-060
C295	Ceramic C1608 JF 1C 104Z-T-A	022-3906-076
C296	Ceramic C1608 JF 1C 104Z-T-A	022-3906-076
C297	Ceramic C1608 CH 1H 470J-T-A	022-3906-600
C298	Ceramic C1608 CH 1H 470J-T-A	022-3906-600
C299	Ceramic C1608 CH 1H 470J-T-A	022-3906-600
C300	Ceramic C1608 CH 1H 040B-T-A	022-3906-609
C301	Ceramic C1608 CH 1H 040B-T-A	022-3906-609
C302	Ceramic C1608 JB 1H 102K-T-A	022-3906-060
C303	Ceramic C1608 JB 1H 102K-T-A	022-3906-060
C304	Ceramic C1608 CH 1H 120J-T-A	022-3906-066
C306	Ceramic C1608 CH 1H 470J-T-A	022-3906-600
C307	Tantalum ECST0JY475R	022-3906-629
C308	Ceramic C1608 CH 1H 010B-T-A	022-3906-085
C309	Ceramic C1608 CH 1H 470J-T-A	022-3906-600
C310	Ceramic C1608 CH 1H 470J-T-A	022-3906-600
C311	Ceramic C1608 CH 1H 470J-T-A	022-3906-600
C312	Ceramic C1608 CH 1H 470J-T-A	022-3906-600
C313	Ceramic C1608 CH 1H 470J-T-A	022-3906-600
C314	Ceramic C1608 CH 1H 470J-T-A	022-3906-600
C315	Ceramic C1608 CH 1H 470J-T-A	022-3906-600
C316	Ceramic C1608 CH 1H 470J-T-A	022-3906-600
C317	Ceramic C1608 CH 1H 470J-T-A	022-3906-600
C318	Ceramic C1608 CH 1H 100D-T-A	022-3906-598
C319	Ceramic C1608 JB 1H 472K-T-A	022-3906-062
C321	Ceramic C1608 CH 1H 470J-T-A	022-3906-600
C322	Ceramic C1608 JF 1C 224Z-T-A	022-3906-918
C323	Ceramic C1608 CH 1H 100D-T-A	022-3906-598
C324	Ceramic C1608 CH 1H 470J-T-A	022-3906-600
C325	Ceramic C1608 CH 1H 470J-T-A	022-3906-600

7640 (UHF) Main Unit

Ref No.	Description	Part No.	Ref No.	Description	Part No.
C326	Ceramic C1608 CH 1H 470J-T-A	022-3906-600	D23	Diode MA111 (TX)	022-3906-585
C327	Ceramic C1608 CH 1H 470J-T-A	022-3906-600	D24	Diode DAN202U T107	022-3906-558
C328	Ceramic C1608 CH 1H 470J-T-A	022-3906-600	D25	Diode MA111 (TX)	022-3906-585
C329	Ceramic C1608 CH 1H 470J-T-A	022-3906-600	D27	Diode MA111 (TX)	022-3906-585
C330	Ceramic C1608 CH 1H 470J-T-A	022-3906-600	D28	Zener RD20E B2	022-3906-774
C331	Ceramic C1608 JB 1H 471K-T-A	022-3906-059	D29	Diode DAN202U T107	022-3906-558
C332	Ceramic C1608 CH 1H 470J-T-A	022-3906-600	D30	Diode MA111 (TX)	022-3906-585
C333	Ceramic C1608 CH 1H 470J-T-A	022-3906-600	D31	Diode DAN202U T107	022-3906-558
C334	Ceramic C1608 CH 1H 470J-T-A	022-3906-600	D32	Diode MA111 (TX)	022-3906-585
C335	Ceramic C1608 CH 1H 470J-T-A	022-3906-600	D33	Varicap HVU350TRF	022-3906-578
C336	Ceramic C1608 CH 1H 470J-T-A	022-3906-600	D34	Varicap HVU350TRF	022-3906-578
C337	Tantalum TEMSVB2 1V 225M-8L	022-3906-812	EP2	Bead HF70BB4.5X5X1.6	022-3906-938
C338	Ceramic C1608 CH 1H 070D-T-A (except 490-512 MHz)	022-3906-596	EP3	Bead HF70BB9X5X4.5	022-3906-844
C339	Ceramic C1608 JB 1H 102K-T-A	022-3906-060	FI1	Crystal FL-287 (46.350 MHz)	022-3906-939
C340	Ceramic C1608 JB 1H 102K-T-A	022-3906-060	FI2	Ceramic CFWM450E	022-3906-590
C341	Ceramic C1608 JB 1H 102K-T-A	022-3906-060	FI3	Ceramic CFWM450G	022-3906-591
C342	Ceramic C1608 JB 1H 102K-T-A	022-3906-060	IC01	TA31136FN (D,EL)	022-3906-302
C343	Ceramic C1608 JB 1H 102K-T-A	022-3906-060	IC02	TA7808F (TE16L)	022-3906-942
C344	Ceramic C1608 JB 1H 102K-T-A	022-3906-060	IC03	AN78L05M- (E1)	022-3906-943
C345	Ceramic C1608 JB 1H 102K-T-A	022-3906-060	IC04	NJM2904M-T1	022-3906-944
C346	Ceramic C1608 JB 1H 102K-T-A	022-3906-060	IC05	SC1236 (400-430 MHz)	022-3906-945
C347	Ceramic C1608 JB 1H 102K-T-A	022-3906-060		SC1237 (450-470 MHz)	022-3906-946
C348	Ceramic C1608 JF 1C 224Z-T-A	022-3906-918		SC1325 (470-490 MHz)	022-3906-947
C349	Ceramic C1608 JF 1C 224Z-T-A	022-3906-918		SC1326 (490-512 MHz)	022-3906-948
D01	Diode MA713 (TX)	022-3906-936	IC06	NJM2902M-T1	022-3906-749
D03	Diode UM9401F	022-3906-937	IC07	NJM2904M-T1	022-3906-944
D04	Diode MI809-T11	022-3906-043	IC08	NJM2904M-T1	022-3906-944
D05	Diode MA77 (TW)	022-3906-047	IC09	LA4425A	022-3906-830
D06	Diode 1SS352 (TPH3)	022-3906-776	IC10	uPD3140GS-E1 (DS8)	022-3906-554
D07	Varicap HVU350TRF	022-3906-578	IC11	BU4066BCF-T1	022-3906-940
D08	Varicap HVU350TRF	022-3906-578	IC12	M62363FP-650C	022-3906-832
D09	Varicap HVU350TRF	022-3906-578	IC13	BU4094BCF-T1	022-3906-941
D10	Varicap HVU350TRF	022-3906-578	J01	Connector HSJ0807-01-010	022-3906-835
D12	Diode DAN202U T107	022-3906-558	J02	Connector PI28A-02M	022-3901-444
D13	Diode DAN202U T107	022-3906-558	J03	Connector FH12-40S-0.5SV	022-3906-843
D14	Diode 1SS302 (TE85R)	022-3906-777	J04	Connector AXN330C038P	022-3906-681
D15	Diode 1SS302 (TE85R)	022-3906-777	J05	Connector B11B-ZR-SM3-TF	022-3906-834
D16	DIODE DSA3A1	022-3906-821	J06	Connector B2B-ZR-SM3-TF	022-3906-841
D17	Diode DA221 TL	022-3906-331	L01	Coil LA-382 (490-512 MHz only)	022-3906-952
D18	Diode MA77 (TW)	022-3906-047		Coil LA-232 (other bands)	022-3906-951
D19	Diode MA77 (TW)	022-3906-047			
D20	Varicap HVU350TRF	022-3906-578			
D21	Varicap IT365-01-T8A	022-3906-579			
D22	Varicap HVU350TRF	022-3906-578			

7640 (UHF) Main Unit

Ref No.	Description	Part No.
L02	Coil LA-382 (490-512 MHz only)	022-3906-952
	Coil LA-232 (other bands)	022-3906-951
L03	Coil LA-382	022-3906-952
L04	Coil 33CS-Y655LY-02M=P3 (490-512 MHz only)	022-3906-972
	Coil 33CS-Y655LY-03K=P3 (other bands)	022-3906-670
L05	Coil 33CS-Y655LY-03K=P3	022-3906-670
L06	Coil LW-25	022-3906-842
L07	Coil LQN 1A 15NJ04	022-3906-829
L08	Coil LQN 1A 15NJ04	022-3906-829
L09	Coil ELJFC 4R7M-F	022-3906-973
L10	Coil LQN 1A 15NJ04	022-3906-829
L11	Coil LQN 1A 15NJ04	022-3906-829
L12	Coil ELJRE 39NG-F	022-3906-953
L13	Coil ELJNC R12K-F	022-3906-954
L14	Coil ELJNC 56NK-F	022-3906-955
L15	Coil ELJNC R18K-F	022-3906-956
L16	Coil LA-232 (490-512 MHz)	022-3906-951
	Coil LA-242 (other bands)	022-3906-958
L17	Coil ELJRE 18NG-F	022-3906-959
L18	Coil ELJRE 22NG-F	022-3906-495
L19	Coil ELJRE 15NG-F	022-3906-668
L20	Coil ELJRE 18NG-F	022-3906-962
L21	Coil ELJRE 18NG-F (490-512 MHz only)	022-3906-962
	Coil ELJRE 22NG-F (other bands)	022-3906-495
L22	Coil ELJNC R56K-F	022-3906-833
L23	Coil MC152-E558ANA-100051=P3	022-3906-655
L24	Coil ELJFC 1R0K-F	022-3906-964
L25	Coil ELJNC R18K-F	022-3906-956
L26	Coil MC152-E558ANA-100051=P3 (400-470 MHz)	022-3906-655
L26	Coil MC152-E558ANA-100050 (470-512 MHz)	022-3906-657
L27	Coil ELJFC 1R0K-F	022-3906-964
L28	Coil ELJRE 27NG-F	022-3906-967
L30	Coil ELJRE 27NG-F	022-3906-967
L31	Coil ELJRE 18NG-F	022-3906-962
L32	Coil ELJNC R56K-F	022-3906-833
L33	Coil ELJNC R56K-F	022-3906-833
L34	Coil ELJRE 18NG-F	022-3906-962
MP01	1705 VCO case-1	022-3906-974
MP02	1705 VCO cover-1	022-3906-975
MP03	2055 Filter case	022-3906-880

Ref No.	Description	Part No.
MP04	2055 Filter cover (A)	022-3906-873
MP05	194 Shield plate	022-3906-976
MP06	599 Shield plate	022-3906-869
MP07	2056 Sponge	022-3906-886
MP08	2056 M-holder	022-3906-887
MP09	Rubber sheet (AK)-1	022-3906-889
MP10	Sponge (FL)	022-3906-885
MP11	2056 Sponge	022-3906-886
MP12	2056 M-plate	022-3906-884
MP13	2056 Sponge (400-430 MHz only)	022-3906-886
Q01	Transistor DTA144EU T107	022-3901-353
Q02	S.FET 3SK272-(TX)	022-3906-769
Q03	S.FET 3SK241-R (TX)	022-3906-571
Q04	Transistor 2SC4215-O (TE85R)	022-3906-563
Q05	Transistor 2SC4081 T107 R	022-3901-343
Q07	Transistor DTA144EU T107	022-3901-353
Q08	Transistor 2SD1664 T100Q	022-3906-859
Q09	Transistor DTC114EU T107	022-3906-771
Q10	Transistor 2SD1664 T100Q	022-3906-859
Q11	Transistor DTC114EU T107	022-3906-771
Q12	Transistor 2SB1132 T100 R	022-3906-318
Q13	Transistor XP6501-(TX).AB	022-3906-573
Q14	FET 2SJ377 (TE16R)	022-3906-977
Q15	Transistor DTC114EU T107	022-3906-771
Q16	Transistor DTC144EU T107	022-3906-038
Q17	Transistor 2SC4081 T107 R	022-3901-343
Q18	Transistor 2SB1143 S	022-3906-851
Q19	Transistor 2SC4703-T1 SE	022-3906-850
Q20	Transistor 2SC5107-O (TE85R)	022-3906-566
Q21	Transistor 2SC5107-O (TE85R)	022-3906-566
Q22	Transistor 2SC4081 T107 R	022-3901-343
Q23	Transistor 2SC5110-O (TE85R)	022-3906-978
Q24	Transistor DTC114EU T107	022-3906-771
Q25	Transistor 2SC5110-O (TE85R)	022-3906-978
Q26	Transistor DTC114EU T107	022-3906-771
Q27	Transistor DTC144EU T107	022-3906-038
Q28	Transistor 2SC5107-O (TE85R)	022-3906-566
Q29	Transistor 2SC5107-O (TE85R)	022-3906-566
Q30	Transistor 2SC5110-O (TE85R)	022-3906-978
Q31	Transistor 2SC4081 T107 R	022-3901-343
Q32	Transistor DTC144EU T107	022-3906-038
Q33	FET 2SK880-GR (TE85R)	022-3906-981
Q34	FET 2SK536-TA	022-3906-982
Q35	Transistor 2SC4081 T107 R	022-3901-343
Q36	Transistor DTC144EU T107	022-3906-038

7640 (UHF) Main Unit

Ref No.	Description	Part No.
Q37	Transistor DTC144EU T107	022-3906-038
Q38	Transistor DTC144EU T107	022-3906-038
Q39	Transistor DTC144EU T107	022-3906-038
Q40	FET 2SJ144-GR (TE85R)	022-3906-773
Q41	Transistor DTC363EK T147	022-3906-772
Q42	Transistor DTC144EU T107	022-3906-038
Q44	Transistor DTC144EU T107	022-3906-038
Q45	Transistor DTA144EU T107	022-3901-353
Q46	Transistor DTA144EU T107	022-3901-353
R001	Res MCR10EZHZ 100 k ohm (104)	022-3906-983
R002	Res ERJ3GEYJ 1R0 V (1 ohm)	022-3906-688
R003	Res ERJ3GEYJ 101 V (100 ohm)	022-3906-143
R004	Res MCR10EZHZ 47 ohm (470)	022-3901-781
R005	Res ERJ3GEYJ 101 V (100 ohm)	022-3906-143
R006	Res ERJ3GEYJ 101 V (100 ohm)	022-3906-143
R007	Res MCR10EZHZ 47 ohm (470)	022-3901-781
R008	Res MCR50JZHJ 220 ohm (221)	022-3906-995
R009	Res MCR50JZHJ 220 ohm (221)	022-3906-995
R010	Res ERJ3GEYJ 472 V (4.7 k ohm)	022-3906-160
R011	Res ERJ3GEYJ 224 V (220 k ohm)	022-3906-178
R012	Res ERJ3GEYJ 103 V (10 k ohm)	022-3906-163
R013	Res ERJ3GEYJ 224 V (220 k ohm)	022-3906-178
R014	Res ERJ3GEYJ 103 V (10 k ohm)	022-3906-163
R015	Res ERJ3GEYJ 473 V (47 k ohm)	022-3906-171
R016	Res ERJ3GEYJ 473 V (47 k ohm)	022-3906-171
R017	Res ERJ3GEYJ 104 V (100 k ohm)	022-3906-175
R018	Res ERJ3GEYJ 680 V (68 ohm)	022-3906-985
R019	Res ERJ3GEYJ 100 V (10 ohm)	022-3906-138
R020	Res ERJ3GEYJ 222 V (2.2 k ohm)	022-3906-157
R021	Res ERJ3GEYJ 224 V (220 k ohm)	022-3906-178
R022	Res ERJ3GEYJ 103 V (10 k ohm)	022-3906-163
R023	Res ERJ3GEYJ 224 V (220 k ohm)	022-3906-178
R024	Res ERJ3GEYJ 103 V (10 k ohm)	022-3906-163
R025	Res ERJ3GEYJ 104 V (100 k ohm)	022-3906-175
R027	Res ERJ3GEYJ 271 V (270 ohm)	022-3906-147
R028	Res ERJ3GEYJ 180 V (18 ohm)	022-3906-140
R029	Res ERJ3GEYJ 271 V (270 ohm)	022-3906-147
R030	Res ERJ3GEYJ 680 V (68 ohm)	022-3906-985
R031	Res ERJ3GEYJ 220 V (22 ohm)	022-3906-685
R032	Res ERJ3GEYJ 101 V (100 ohm)	022-3906-143
R033	Res ERJ3GEYJ 331 V (330 ohm)	022-3906-389
R034	Res ERJ3GEYJ 331 V (330 ohm)	022-3906-389
R035	Res ERJ3GEYJ 124 V (120 k ohm)	022-3906-176
R036	Res ERJ3GEYJ 101 V (100 ohm)	022-3906-143
R037	Res ERJ3GEYJ 122 V (1.2 k ohm)	022-3906-390

Ref No.	Description	Part No.
R038	Res ERJ3GEYJ 473 V (47 k ohm)	022-3906-171
R039	Res ERJ3GEYJ 473 V (47 k ohm)	022-3906-171
R040	Res ERJ3GEYJ 222 V (2.2 k ohm)	022-3906-157
R041	Res ERJ3GEYJ 471 V (470 ohm)	022-3906-150
R042	Res ERJ3GEYJ 104 V (100 k ohm)	022-3906-175
R044	Res ERJ3GEYJ 821 V (820 ohm)	022-3906-153
R045	Res ERJ3GEYJ 334 V (330 k ohm)	022-3906-180
R046	Res ERJ3GEYJ 104 V (100 k ohm)	022-3906-175
R047	Res ERJ3GEYJ 470 V (47 ohm)	022-3906-141
R048	Res ERJ3GEYJ 152 V (1.5 k ohm)	022-3906-155
R049	Res ERJ3GEYJ 153 V (15 k ohm)	022-3906-165
R050	Res ERJ3GEYJ 223 V (22 k ohm)	022-3906-167
R051	Res ERJ3GEYJ 123 V (12 k ohm)	022-3906-164
R052	Res ERJ3GEYJ 223 V (22 k ohm)	022-3906-167
R053	Res ERJ3GEYJ 153 V (15 k ohm)	022-3906-165
R054	Res MCR10EZHZ 4.7 k ohm (472)	022-3906-988
R055	Res MCR10EZHZ 4.7 k ohm (472)	022-3906-988
R056	Res MCR10EZHZ 4.7 k ohm (472)	022-3906-988
R057	Res MCR10EZHZ 4.7 k ohm (472)	022-3906-988
R058	Res ERJ3GEYJ 472 V (4.7 k ohm)	022-3906-160
R059	Res ERJ3GEYJ 103 V (10 k ohm)	022-3906-163
R060	Res ERJ3GEYJ 471 V (470 ohm)	022-3906-150
R061	Res ERJ3GEYJ 223 V (22 k ohm) (490-512 MHz only)	022-3906-167
	Res ERJ3GEYJ 183 V (18 k ohm) (other bands)	022-3906-166
R062	Res ERJ3GEYJ 183 V (18 k ohm)	022-3906-166
R063	Res ERJ3GEYJ 105 V (1 M ohm)	022-3906-184
R064	Res ERJ3GEYJ 154 V (150 k ohm)	022-3906-392
R065	Res ERJ3GEYJ 683 V (68 k ohm)	022-3906-173
R066	Res ERJ3GEYJ 683 V (68 k ohm)	022-3906-173
R067	Res ERJ3GEYJ 472 V (4.7 k ohm)	022-3906-160
R068	Res ERJ3GEYJ 122 V (1.2 k ohm)	022-3906-390
R069	Res ERJ3GEYJ 151 V (150 ohm)	022-3906-145
R070	Res MCR10EZHZ 2.2 ohm (2R2)	022-3906-847
R071	Res MCR10EZHZ 22 ohm (220) (490-512 MHz only)	022-3906-848
	Res MCR10EZHZ 33 ohm (330) (other bands)	022-3906-992
R072	Res MCR10EZHZ 27 ohm (270) (490-512 MHz only)	022-3906-993
	Res MCR10EZHZ 33 ohm (330) (other bands)	022-3906-992
R073	Res ERJ3GEYJ 222 V (2.2 k ohm)	022-3906-157

7640 (UHF) Main Unit

Ref No.	Description	Part No.
R074	Res ERJ3GEYJ 221 V (220 ohm)	022-3906-288
R075	Res ERJ3GEYJ 101 V (100 ohm)	022-3906-143
R076	Res ERJ3GEYJ 220 V (22 ohm)	022-3906-685
R077	Res ERJ3GEYJ 332 V (3.3 k ohm)	022-3906-159
R078	Res ERJ3GEYJ 152 V (1.5 k ohm)	022-3906-155
R079	Res ERJ3GEYJ 220 V (22 ohm)	022-3906-685
R080	Res ERJ3GEYJ 221 V (220 ohm)	022-3906-288
R081	Res ERJ3GEYJ 472 V (4.7 k ohm)	022-3906-160
R082	Res ERJ3GEYJ 272 V (2.7 k ohm)	022-3906-158
R083	Res ERJ3GEYJ 472 V (4.7 k ohm)	022-3906-160
R084	Res ERJ3GEYJ 102 V (1 k ohm)	022-3906-154
R085	Res ERJ3GEYJ 103 V (10 k ohm)	022-3906-163
R086	Res ERJ3GEYJ 102 V (1 k ohm)	022-3906-154
R087	Res ERJ3GEYJ 103 V (10 k ohm)	022-3906-163
R094	Res ERJ3GEYJ 152 V (1.5 k ohm)	022-3906-155
R095	Res ERJ3GEYJ 473 V (47 k ohm)	022-3906-171
R096	Res ERJ3GEYF 913 V (91 k ohm)	022-3906-997
R097	Res ERJ3GEYJ 473 V (47 k ohm)	022-3906-171
R098	Res ERJ3GEYJ 473 V (47 k ohm)	022-3906-171
R099	Res ERJ3GEYJ 222 V (2.2 k ohm)	022-3906-157
R100	Res RR0816R-363-D (36 k ohm)	022-3906-984
R101	Res ERJ3EKF 4121V (4.12 k ohm)	022-3906-857
R102	Res ERJ3GEYJ 1R0 V (1 ohm)	022-3906-688
R103	Res ERJ3GEYJ 224 V (220 k ohm)	022-3906-178
R104	Res ERJ3GEYJ 223 V (22 k ohm)	022-3906-167
R105	Res ERJ3GEYJ 223 V (22 k ohm)	022-3906-167
R106	Res ERJ3GEYJ 274 V (270 k ohm)	022-3906-179
R107	Res ERJ3GEYJ 101 V (100 ohm)	022-3906-143
R108	Res ERJ3GEYJ 123 V (12 k ohm)	022-3906-164
R109	Res ERJ3GEYJ 103 V (10 k ohm)	022-3906-163
R110	Thermistor NTCCF2012 4AH 473KC-T	022-3906-403
R111	Res RR0816R-104-D (100 k ohm)	022-3906-395
R112	Res RR0816R-304-D (300 k ohm)	022-3906-861
R113	Res RR0816R-104-D (100 k ohm)	022-3906-395
R114	Res ERJ3GEYJ 100 V (10 ohm)	022-3906-138
R115	Res ERJ3GEYJ 682 V (6.8 k ohm)	022-3906-162
R116	Res ERJ3GEYJ 682 V (6.8 k ohm)	022-3906-162
R117	Res ERJ3GEYJ 1R0 V (1 ohm)	022-3906-688
R118	Res ERJ3GEYJ 102 V (1 k ohm)	022-3906-154
R119	Res ERJ3GEYJ 272 V (2.7 k ohm) (450-470 MHz)	022-3906-158
	Res ERJ3GEYJ 332 V (3.3 k ohm) (other bands)	022-3906-159
R120	Res ERJ3GEYJ 104 V (100 k ohm)	022-3906-175
R121	Res ERJ3GEYJ 470 V (47 ohm)	022-3906-141

Ref No.	Description	Part No.
R122	Res ERJ3GEYJ 103 V (10 k ohm)	022-3906-163
R123	Res ERJ3GEYJ 472 V (4.7 k ohm)	022-3906-160
R124	Res ERJ3GEYJ 472 V (4.7 k ohm)	022-3906-160
R125	Res ERJ3GEYJ 100 V (10 ohm)	022-3906-138
R126	Res ERJ3GEYJ 561 V (560 ohm)	022-3906-151
R127	Res ERJ3GEYJ 472 V (4.7 k ohm)	022-3906-160
R128	Res ERJ3GEYJ 100 V (10 ohm)	022-3906-138
R129	Res ERJ3GEYJ 100 V (10 ohm)	022-3906-138
R130	Res ERJ3GEYJ 154 V (150 k ohm)	022-3906-392
R131	Res ERJ3GEYJ 221 V (220 ohm)	022-3906-288
R132	Res ERJ3GEYJ 184 V (180 k ohm)	022-3906-177
R133	Res ERJ3GEYJ 100 V (10 ohm)	022-3906-138
R134	Res ERJ3GEYJ 472 V (4.7 k ohm)	022-3906-160
R135	Res ERJ3GEYJ 472 V (4.7 k ohm)	022-3906-160
R136	Res ERJ3GEYJ 221 V (220 ohm)	022-3906-288
R137	Res ERJ3GEYJ 472 V (4.7 k ohm)	022-3906-160
R138	Res ERJ3GEYJ 271 V (270 ohm)	022-3906-147
R139	Res ERJ3GEYJ 180 V (18 ohm)	022-3906-140
R140	Res ERJ3GEYJ 271 V (270 ohm)	022-3906-147
R141	Res ERJ3GEYJ 103 V (10 k ohm)	022-3906-163
R142	Res ERJ3GEYJ 103 V (10 k ohm)	022-3906-163
R143	Res ERJ3GEYJ 102 V (1 k ohm)	022-3906-154
R144	Res ERJ3GEYJ 223 V (22 k ohm)	022-3906-167
R145	Res RR0816R-753-D (75 k ohm)	022-3906-867
R146	Res ERJ3GEYJ 823 V (82 k ohm)	022-3906-174
R147	Res ERJ3GEYJ 103 V (10 k ohm)	022-3906-163
R148	Res ERJ3GEYJ 104 V (100 k ohm)	022-3906-175
R150	Res ERJ3GEYJ 101 V (100 ohm)	022-3906-143
R151	Res ERJ3GEYJ 224 V (220 k ohm)	022-3906-178
R152	Res ERJ3GEYJ 562 V (5.6 k ohm)	022-3906-161
R153	Res ERJ3GEYJ 104 V (100 k ohm)	022-3906-175
R154	Res ERJ3GEYJ 101 V (100 ohm)	022-3906-143
R155	Res ERJ3GEYJ 103 V (10 k ohm)	022-3906-163
R156	Res ERJ3GEYJ 563 V (56 k ohm)	022-3906-172
R157	Res ERJ3GEYJ 125 V (1.2 M ohm)	022-3906-856
R158	Res ERJ3GEYJ 153 V (15 k ohm)	022-3906-165
R159	Res ERJ3GEYJ 333 V (33 k ohm)	022-3906-169
R160	Res ERJ3GEYJ 473 V (47 k ohm)	022-3906-171
R161	Res ERJ3GEYJ 474 V (470 k ohm)	022-3906-181
R162	Res ERJ3GEYJ 474 V (470 k ohm)	022-3906-181
R163	Res ERJ3GEYJ 103 V (10 k ohm)	022-3906-163
R164	Res ERJ3GEYJ 473 V (47 k ohm)	022-3906-171
R165	Res ERJ3GEYJ 103 V (10 k ohm)	022-3906-163
R166	Res ERJ3GEYJ 103 V (10 k ohm)	022-3906-163
R167	Res ERJ3GEYJ 101 V (100 ohm)	022-3906-143

7640 (UHF) Main Unit

Ref No.	Description	Part No.
R168	Res ERJ3GEYJ 104 V (100 k ohm)	022-3906-175
R169	Res ERJ3GEYJ 102 V (1 k ohm)	022-3906-154
R170	Res ERJ3GEYJ 682 V (6.8 k ohm)	022-3906-162
R172	Res ERJ3GEYJ 103 V (10 k ohm)	022-3906-163
R173	Res ERJ3GEYJ 103 V (10 k ohm)	022-3906-163
R174	Res ERJ3GEYJ 471 V (470 ohm)	022-3906-150
R175	Res ERJ3GEYJ 103 V (10 k ohm)	022-3906-163
R176	Res ERJ3GEYJ 105 V (1 M ohm)	022-3906-184
R177	Res ERJ3GEYJ 683 V (68 k ohm)	022-3906-173
R178	Res ERJ3GEYJ 104 V (100 k ohm)	022-3906-175
R179	Res ERJ3GEYJ 102 V (1 k ohm)	022-3906-154
R180	Res ERJ3GEYJ 103 V (10 k ohm)	022-3906-163
R181	Res ERJ3GEYJ 102 V (1 k ohm)	022-3906-154
R182	Res ERJ3GEYJ 100 V (10 ohm)	022-3906-138
R184	Res ERJ3GEYJ 272 V (2.7 k ohm)	022-3906-158
R185	Res ERJ3GEYJ 101 V (100 ohm)	022-3906-143
R186	Res ERJ3GEYJ 104 V (100 k ohm)	022-3906-175
R187	Res ERJ3GEYJ 102 V (1 k ohm)	022-3906-154
R188	Res ERJ3GEYJ 102 V (1 k ohm)	022-3906-154
R189	Res ERJ3GEYJ 102 V (1 k ohm)	022-3906-154
R190	Res ERJ3GEYJ 102 V (1 k ohm)	022-3906-154
R191	Res ERJ3GEYJ 560 V (56 ohm)	022-3906-142
R193	Res ERJ3GEYJ 474 V (470 k ohm)	022-3906-181
R194	Res ERJ3GEYJ 184 V (180 k ohm)	022-3906-177
R195	Res ERJ3GEYJ 224 V (220 k ohm)	022-3906-178
R198	Res ERJ3GEYJ 103 V (10 k ohm)	022-3906-163
R199	Res ERJ3GEYJ 471 V (470 ohm)	022-3906-150
R204	Res ERJ3GEYJ 103 V (10 k ohm)	022-3906-163
R205	Res ERJ3GEYJ 103 V (10 k ohm)	022-3906-163
R206	Res ERJ3GEYJ 104 V (100 k ohm)	022-3906-175
R207	Res ERJ3GEYJ 102 V (1 k ohm)	022-3906-154
R208	Res ERJ3GEYJ 103 V (10 k ohm)	022-3906-163
R209	Res ERJ3GEYJ 104 V (100 k ohm)	022-3906-175
R210	Res ERJ3GEYJ 105 V (1 M ohm)	022-3906-184
R211	Res ERJ3GEYJ 104 V (100 k ohm)	022-3906-175
R212	Res ERJ3GEYJ 105 V (1 M ohm)	022-3906-184
R213	Res ERJ3GEYJ 104 V (100 k ohm)	022-3906-175
R214	Res ERJ3GEYJ 104 V (100 k ohm)	022-3906-175
R215	Res ERJ3GEYJ 104 V (100 k ohm)	022-3906-175
R216	Res ERJ3GEYJ 105 V (1 M ohm)	022-3906-184
R217	Res ERJ3GEYJ 105 V (1 M ohm)	022-3906-184
R218	Res ERJ3GEYJ 105 V (1 M ohm)	022-3906-184
R219	Res ERJ3GEYJ 102 V (1 k ohm)	022-3906-154
R220	Res ERJ3GEYJ 102 V (1 k ohm)	022-3906-154
R221	Res ERJ3GEYJ 102 V (1 k ohm)	022-3906-154
R222	Res ERJ3GEYJ 102 V (1 k ohm)	022-3906-154

Ref No.	Description	Part No.
R223	Res ERJ3GEYJ 102 V (1 k ohm)	022-3906-154
R224	Res ERJ3GEYJ 102 V (1 k ohm)	022-3906-154
R225	Res ERJ3GEYJ 102 V (1 k ohm)	022-3906-154
R226	Res ERJ3GEYJ 102 V (1 k ohm)	022-3906-154
R227	Res ERJ3GEYJ 102 V (1 k ohm)	022-3906-154
R228	Res ERJ3GEYJ 102 V (1 k ohm)	022-3906-154
R229	Res ERJ3GEYJ 102 V (1 k ohm)	022-3906-154
R230	Res ERJ3GEYJ 102 V (1 k ohm)	022-3906-154
R231	Res ERJ3GEYJ 102 V (1 k ohm)	022-3906-154
R232	Res ERJ3GEYJ 102 V (1 k ohm)	022-3906-154
R233	Res ERJ3GEYJ 102 V (1 k ohm)	022-3906-154
R234	Res ERJ3GEYJ 102 V (1 k ohm)	022-3906-154
R235	Res ERJ3GEYJ 102 V (1 k ohm)	022-3906-154
R236	Res ERJ3GEYJ 102 V (1 k ohm)	022-3906-154
R237	Res ERJ3GEYJ 102 V (1 k ohm)	022-3906-154
R238	Res ERJ3GEYJ 102 V (1 k ohm)	022-3906-154
R239	Res ERJ3GEYJ 102 V (1 k ohm)	022-3906-154
R240	Res ERJ3GEYJ 102 V (1 k ohm)	022-3906-154
R241	Res ERJ3GEYJ 102 V (1 k ohm)	022-3906-154
R242	Res ERJ3GEYJ 102 V (1 k ohm)	022-3906-154
R243	Res ERJ3GEYJ 102 V (1 k ohm)	022-3906-154
R245	Res ERJ3GEYJ 102 V (1 k ohm)	022-3906-154
R246	Res ERJ3GEYJ 102 V (1 k ohm)	022-3906-154
R247	Res ERJ3GEYJ 102 V (1 k ohm)	022-3906-154
R248	Res ERJ3GEYJ 102 V (1 k ohm)	022-3906-154
R249	Res ERJ3GEYJ 102 V (1 k ohm)	022-3906-154
R250	Res ERJ3GEYJ 102 V (1 k ohm)	022-3906-154
R251	Res ERJ3GEYJ 102 V (1 k ohm)	022-3906-154
R252	Res ERJ3GEYJ 102 V (1 k ohm)	022-3906-154
R254	Res ERJ3GEYJ 474 V (470 k ohm)	022-3906-181
R255	Res ERJ3GEYJ 103 V (10 k ohm)	022-3906-163
R257	Res ERJ3GEYJ 470 V (47 ohm)	022-3906-141
R258	Res ERJ3GEYJ 473 V (47 k ohm)	022-3906-171
R259	Res ERJ3GEYJ 223 V (22 k ohm)	022-3906-167
R260	Res ERJ3GEYJ 822 V (8.2 k ohm) (470-490 MHz only)	022-3906-256
	Res ERJ3GEYJ 123 V (12 k ohm) (other bands)	022-3906-164
R261	Res ERJ3GEYJ 104 V (100 k ohm)	022-3906-175
R264	Res ERJ3GEYJ 103 V (10 k ohm)	022-3906-163
R265	Res ERJ3GEYJ 103 V (10 k ohm)	022-3906-163
R266	Res ERJ3GEYJ 103 V (10 k ohm)	022-3906-163
R267	Res ERJ3GEYJ 274 V (270 k ohm)	022-3906-179
R268	Res ERJ3GEYJ 103 V (10 k ohm)	022-3906-163
R269	Res ERJ3GEYJ 393 V (39 k ohm)	022-3906-170
R270	Res ERJ3GEYJ 105 V (1 M ohm)	022-3906-184

PARTS LIST

7640 (UHF) Main Unit

Ref No.	Description	Part No.
R271	Res ERJ3GEYJ 103 V (10 k ohm)	022-3906-163
R272	Res ERJ3GEYJ 102 V (1 k ohm)	022-3906-154
R273	Res ERJ3GEYJ 824 V (820 k ohm)	022-3906-986
R274	Res ERJ3GEYJ 102 V (1 k ohm)	022-3906-154
R275	Res ERJ3GEYJ 102 V (1 k ohm)	022-3906-154
R276	Res ERJ3GEYJ 100 V (10 ohm)	022-3906-138
R277	Res ERJ3GEYJ 471 V (470 ohm)	022-3906-150
R278	Res ERJ3GEYJ 103 V (10 k ohm)	022-3906-163
R279	Res ERJ3GEYJ 823 V (82 k ohm)	022-3906-174
W02	Jumper ERDS2T0	022-3906-877
W06	Cable OPC-453	022-3906-878
W07	Jumper ERJ3GE JPW V	022-3906-185
W08	Jumper ERJ3GE JPW V	022-3906-185
W09	Jumper ERJ3GE JPW V	022-3906-185
W10	Jumper MCR10EZJ JPW (000)	022-3906-846
W11	Jumper MJP-0.4-T	022-3906-695
W12	Jumper MJP-0.4-T	022-3906-695
W13	Jumper ERJ3GE JPW V	022-3906-185
W14	Jumper ERJ3GE JPW V	022-3906-185
W15	Jumper ERJ3GE JPW V	022-3906-185
W16	Jumper ERJ3GE JPW V	022-3906-185
X1	Discriminator CDBCA450CX24	022-3906-642
X2	Crystal CR-601 (15.300 MHz)	022-3906-998

Front Unit (All Models)

Ref No.	Description	Part No.
C15	Ceram C1608 JB 1H 102K-T-A	022-3906-060
C16	Ceram C1608 JB 1H 102K-T-A	022-3906-060
C17	Ceram C1608 JB 1H 102K-T-A	022-3906-060
C18	Ceram C1608 CH 1H 470J-T-A	022-3906-600
C19	Ceram C1608 CH 1H 050B-T-A	022-3906-610
C20	Ceram C1608 CH 1H 200J-T-A	022-3906-611
C21	Ceram C1608 JB 1E 103K-T-A	022-3906-063
C22	Ceram C1608 CH 1H 470J-T-A	022-3906-600
C23	Ceram C1608 CH 1H 470J-T-A	022-3906-600
C24	Ceram C1608 CH 1H 470J-T-A	022-3906-600
C25	Ceram C1608 CH 1H 470J-T-A	022-3906-600
C26	Ceram C1608 CH 1H 470J-T-A	022-3906-600
C27	Ceram C1608 CH 1H 470J-T-A	022-3906-600
C28	Ceram C1608 JB 1H 102K-T-A	022-3906-060
C29	Ceram C1608 JB 1H 102K-T-A	022-3906-060
C30	Ceram C1608 JB 1H 471K-T-A	022-3906-059
C32	Ceram C1608 JB 1H 102K-T-A	022-3906-060
C33	Ceram C1608 JB 1H 102K-T-A	022-3906-060
C34	Ceram C1608 CH 1H 470J-T-A	022-3906-600
C35	Ceram C1608 JB 1H 102K-T-A	022-3906-060
C36	Ceram C1608 JB 1E 103K-T-A	022-3906-063
C37	Tantalum ECST1AY106R	022-3906-765
C38	Ceram C1608 JB 1C 223K-T-A	022-3906-079
C39	Ceram C1608 JB 1C 104KT-N	022-3906-614
C40	Ceram C1608 JB 1C 473K-T-A	022-3906-080
C41	Ceram C1608 JB 1C 333K-T-A	022-3906-351
C42	Ceram C1608 JB 1C 104KT-N	022-3906-614
C43	Ceram C1608 JB 1E 103K-T-A	022-3906-063
C44	Ceram C1608 JB 1E 103K-T-A	022-3906-063
C45	Ceram C1608 JB 1E 103K-T-A	022-3906-063
C46	Ceram C1608 CH 1H 470J-T-A	022-3906-600
C47	Ceram C1608 CH 1H 470J-T-A	022-3906-600
C48	Ceram C1608 CH 1H 470J-T-A	022-3906-600
C49	Ceram C1608 CH 1H 470J-T-A	022-3906-600
C50	Ceram C1608 CH 1H 470J-T-A	022-3906-600
C52	Ceram C1608 CH 1H 470J-T-A	022-3906-600
C56	Ceram C1608 CH 1H 470J-T-A	022-3906-600
C57	Ceram C1608 CH 1H 470J-T-A	022-3906-600
C58	Ceram C1608 CH 1H 470J-T-A	022-3906-600
C59	Ceram C1608 CH 1H 470J-T-A	022-3906-600
C60	Ceram C1608 CH 1H 470J-T-A	022-3906-600
C61	Ceram C1608 CH 1H 470J-T-A	022-3906-600
C62	Ceram C1608 CH 1H 470J-T-A	022-3906-600
C63	Ceram C1608 CH 1H 470J-T-A	022-3906-600
C64	Ceram C1608 CH 1H 470J-T-A	022-3906-600

Ref No.	Description	Part No.
FRONT UNIT (VHF AND UHF MODELS)		
C01	Ceram C1608 JB 1E 103K-T-A	022-3906-063
C02	Ceram C1608 JB 1E 103K-T-A	022-3906-063
C03	Ceram C1608 JB 1E 103K-T-A	022-3906-063
C04	Ceram C1608 JB 1E 103K-T-A	022-3906-063
C05	Ceram C1608 JB 1E 103K-T-A	022-3906-063
C06	Ceram C1608 JB 1E 103K-T-A	022-3906-063
C07	Ceram C1608 JB 1E 103K-T-A	022-3906-063
C08	Ceram C1608 JB 1E 103K-T-A	022-3906-063
C09	Tantalum ECST0JY106R	022-3906-627
C10	Ceram C1608 JB 1E 103K-T-A	022-3906-063
C11	Ceram C1608 JB 1H 102K-T-A	022-3906-060
C12	Ceram C1608 JB 1E 103K-T-A	022-3906-063
C13	Ceram C1608 JB 1H 102K-T-A	022-3906-060
C14	Tantalum ECST1EY474R	022-3906-624

Front Unit (All Models)

Ref No.	Description	Part No.
C65	Ceram C1608 CH 1H 470J-T-A	022-3906-600
C66	Ceram C1608 CH 1H 470J-T-A	022-3906-600
C67	Ceram C1608 JB 1H 102K-T-A	022-3906-060
C69	Ceram C1608 JB 1H 102K-T-A	022-3906-060
C70	Ceram C1608 CH 1H 470J-T-A	022-3906-600
C71	Ceram C1608 CH 1H 470J-T-A	022-3906-600
C73	Ceram C1608 CH 1H 470J-T-A	022-3906-600
C74	Ceram C1608 CH 1H 470J-T-A	022-3906-600
C77	Ceram C1608 CH 1H 470J-T-A	022-3906-600
C78	Ceram C1608 CH 1H 470J-T-A	022-3906-600
C79	Ceram C1608 CH 1H 470J-T-A	022-3906-600
C80	Ceram C1608 CH 1H 470J-T-A	022-3906-600
C82	Ceram C1608 JB 1C 104KT-N	022-3906-614
D1	Diode MA111 (TX)	022-3906-585
D2	Diode DA204U T107	022-3906-582
D3	Diode DA204U T107	022-3906-582
D4	Diode DA204U T107	022-3906-582
D5	Diode MA77 (TW)	022-3906-047
D6	Zener MA8051-M (TX)	022-3906-766
DS01	LCD LD-HU10140J	022-3906-767
DS02	LED SML-311YTT86	022-3906-768
DS03	LED SML-311YTT86	022-3906-768
DS04	LED SML-311YTT86	022-3906-768
DS05	LED SML-311YTT86	022-3906-768
DS06	LED SML-311YTT86	022-3906-768
DS07	LED SML-311YTT86	022-3906-768
DS08	LED SML-311YTT86	022-3906-768
DS09	LED SML-311YTT86	022-3906-768
DS10	LED SML-311YTT86	022-3906-768
DS11	LED SML-311YTT86	022-3906-768
EP2	LCD contact SRCN-2055-SP-N-W	022-3906-779
IC1	HD6433875A63H	022-3906-780
IC2	S.IC S-80742SL-A6-T1	022-3906-551
IC3	S.IC 25LC160T-I/SN	022-3906-556
J1	Connector 95003-2881	022-3906-781
J2	Connector FH12-40S-0.5SV	022-3906-782
L1	Coil NL 322522T-1R0J	022-3906-783
L3	Coil NL 322522T-470J	022-3906-784
MP1	2055 LCD reflector	022-3906-790

Ref No.	Description	Part No.
MP2	2055 LCD holder	022-3906-791
Q01	Transistor 2SC4081 T107 R	022-3901-343
Q10	Transistor DTC144TU T107	022-3906-572
Q03	Transistor DTA143ZU T107	022-3906-785
Q04	Transistor DTC144TU T107	022-3906-572
Q05	Transistor XP4601 (TX)	022-3906-328
Q06	Transistor 2SC4081 T107 R	022-3901-343
Q07	Transistor 2SC4081 T107 R	022-3901-343
R01	Res ERJ3GEYJ 103 V (10 k ohm)	022-3906-163
R02	Res ERJ3GEYJ 104 V (100 k ohm)	022-3906-175
R03	Res ERJ3GEYJ 224 V (220 k ohm)	022-3906-178
R04	Res ERJ3GEYJ 104 V (100 k ohm)	022-3906-175
R05	Res ERJ3GEYJ 123 V (12 k ohm)	022-3906-164
R06	Res ERJ3GEYJ 123 V (12 k ohm)	022-3906-164
R07	Res ERJ3GEYJ 105 V (1 M ohm)	022-3906-184
R08	Res ERJ3GEYJ 100 V (10 ohm)	022-3906-138
R11	Res ERJ3GEYJ 821 V (820 ohm)	022-3906-153
R12	Res ERJ3GEYJ 391 V (390 ohm)	022-3906-149
R14	Res ERJ3GEYJ 391 V (390 ohm)	022-3906-149
R15	Res ERJ3GEYJ 222 V (2.2 k ohm)	022-3906-157
R16	Res ERJ3GEYJ 222 V (2.2 k ohm)	022-3906-157
R17	Array EXB-V8V 102JV	022-3906-700
R18	Res ERJ3GEYJ 471 V (470 ohm)	022-3906-150
R19	Res ERJ3GEYJ 471 V (470 ohm)	022-3906-150
R20	Res ERJ3GEYJ 102 V (1 k ohm)	022-3906-154
R21	Res ERJ3GEYJ 102 V (1 k ohm)	022-3906-154
R22	Res ERJ3GEYJ 100 V (10 ohm)	022-3906-138
R24	Res ERJ3GEYJ 184 V (180 k ohm)	022-3906-177
R25	Res ERJ3GEYJ 563 V (56 k ohm)	022-3906-172
R26	Res ERJ3GEYJ 392 V (3.9 k ohm)	022-3906-391
R27	Res ERJ3GEYJ 393 V (39 k ohm)	022-3906-170
R28	Res ERJ3GEYJ 102 V (1 k ohm)	022-3906-154
R29	Res ERJ3GEYJ 102 V (1 k ohm)	022-3906-154
R30	Res ERJ3GEYJ 103 V (10 k ohm)	022-3906-163
R31	Res ERJ3GEYJ 103 V (10 k ohm)	022-3906-163
R32	Res ERJ3GEYJ 223 V (22 k ohm)	022-3906-167
R33	Res ERJ3GEYJ 683 V (68 k ohm)	022-3906-173
R34	Res ERJ3GEYJ 273 V (27 k ohm)	022-3906-168
R35	Res ERJ3GEYJ 103 V (10 k ohm)	022-3906-163
R36	Res ERJ3GEYJ 123 V (12 k ohm)	022-3906-164
R37	Res ERJ3GEYJ 123 V (12 k ohm)	022-3906-164
R38	Res ERJ3GEYJ 473 V (47 k ohm)	022-3906-171
R39	Res ERJ3GEYJ 104 V (100 k ohm)	022-3906-175
R40	Res ERJ3GEYJ 104 V (100 k ohm)	022-3906-175

PARTS LIST

Front Unit (All Models)

Ref No.	Description	Part No.
R41	Res ERJ3GEYJ 274 V (270 k ohm)	022-3906-179
R42	Res ERJ3GEYJ 334 V (330 k ohm)	022-3906-180
R43	Res ERJ3GEYJ 123 V (12 k ohm)	022-3906-164
R44	Array EXB-V8V 102JV	022-3906-700
R45	Array EXB-V8V 102JV	022-3906-700
R46	Array EXB-V8V 102JV	022-3906-700
R47	Array EXB-V8V 102JV	022-3906-700
R48	Array EXB-V8V 102JV	022-3906-700
R49	Res ERJ3GEYJ 101 V (100 ohm)	022-3906-143
R50	Res ERJ3GEYJ 104 V (100 k ohm)	022-3906-175
R51	Res ERJ3GEYJ 102 V (1 k ohm)	022-3906-154
R52	Res ERJ3GEYJ 102 V (1 k ohm)	022-3906-154
R53	Res ERJ3GEYJ 102 V (1 k ohm)	022-3906-154
R54	Res ERJ3GEYJ 102 V (1 k ohm)	022-3906-154
R55	Res ERJ3GEYJ 104 V (100 k ohm)	022-3906-175
R56	Res ERJ3GEYJ 562 V (5.6 k ohm)	022-3906-161
R57	Res ERJ3GEYJ 153 V (15 k ohm)	022-3906-165
R58	Res ERJ3GEYJ 473 V (47 k ohm)	022-3906-171
R59	Res ERJ3GEYJ 102 V (1 k ohm)	022-3906-154
R60	Trimmer RV-150 (RH03A3A14X0FC) 103	022-3906-786
R61	Res ERJ3GEYJ 104 V (100 k ohm)	022-3906-175
R62	Res ERJ3GEYJ 102 V (1 k ohm)	022-3906-154
R63	Res ERJ3GEYJ 102 V (1 k ohm)	022-3906-154
R64	Res ERJ3GEYJ 102 V (1 k ohm)	022-3906-154
R65	Res ERJ3GEYJ 104 V (100 k ohm)	022-3906-175
R66	Res ERJ3GEYJ 104 V (100 k ohm)	022-3906-175
R67	Res ERJ3GEYJ 104 V (100 k ohm)	022-3906-175
R68	Res ERJ3GEYJ 473 V (47 k ohm)	022-3906-171
R69	Res ERJ3GEYJ 104 V (100 k ohm)	022-3906-175
R70	Res ERJ3GEYJ 473 V (47 k ohm)	022-3906-171
W1	Jumper MCR10EZJ JPW (000)	022-3906-787
W2	Jumper ERJ3GE JPW V	022-3906-185
W3	Cable OPC-741	022-3906-788
X1	Crystal CR-590 (6.8015 MHz)	022-3906-789

Chassis Parts

Ref No.	Description	Part No.
7610 (VHF) CHASSIS PARTS		
J1	Connector MR-DS-E 01	022-3906-750
MP1	2055 Chassis	022-3906-751
MP2	2055 Front panel	022-3906-755
MP3	2055 Front key (A)	022-3906-756
MP4	2055 Cover	022-3906-757
MP5	2055 M-Plate	022-3906-758
MP6	Rubber sheet (AK)-1	022-3906-759
MP7	PH BT M3 X 8 NI-ZU	022-3906-760
MP8	2055 Speaker plate	022-3906-761
MP9	2055 Speaker net-1	022-3906-762
MP11	1126 TR-A clip	022-3906-752
MP12	Sponge (FL)	022-3906-753
MP13	Rubber sheet (AM)	022-3906-754
SP1	Speaker VS-57-0837A	022-3906-763
WS1	P1CH	022-3906-764

Ref No.	Description	Part No.
7640 (UHF) CHASSIS PARTS		
J1	Connector MR-DS-E 01	022-3906-750
MP1	2055 Chassis	022-3906-751
MP2	2055 Cover	022-3906-757
MP3	2055 Front panel	022-3906-755
MP4	2055 Front key (A)	022-3906-756
MP7	PH BT M3 X 8 NI-ZU	022-3906-760
MP8	2055 Speaker plate	022-3906-761
MP9	2055 Speaker net-1	022-3906-762
MP11	1126 TR-A clip	022-3906-752
MP12	Rubber sheet (AM)	022-3906-754
SP1	Speaker VS-57-0837A	022-3906-763
WS1	P1CH	022-3906-764

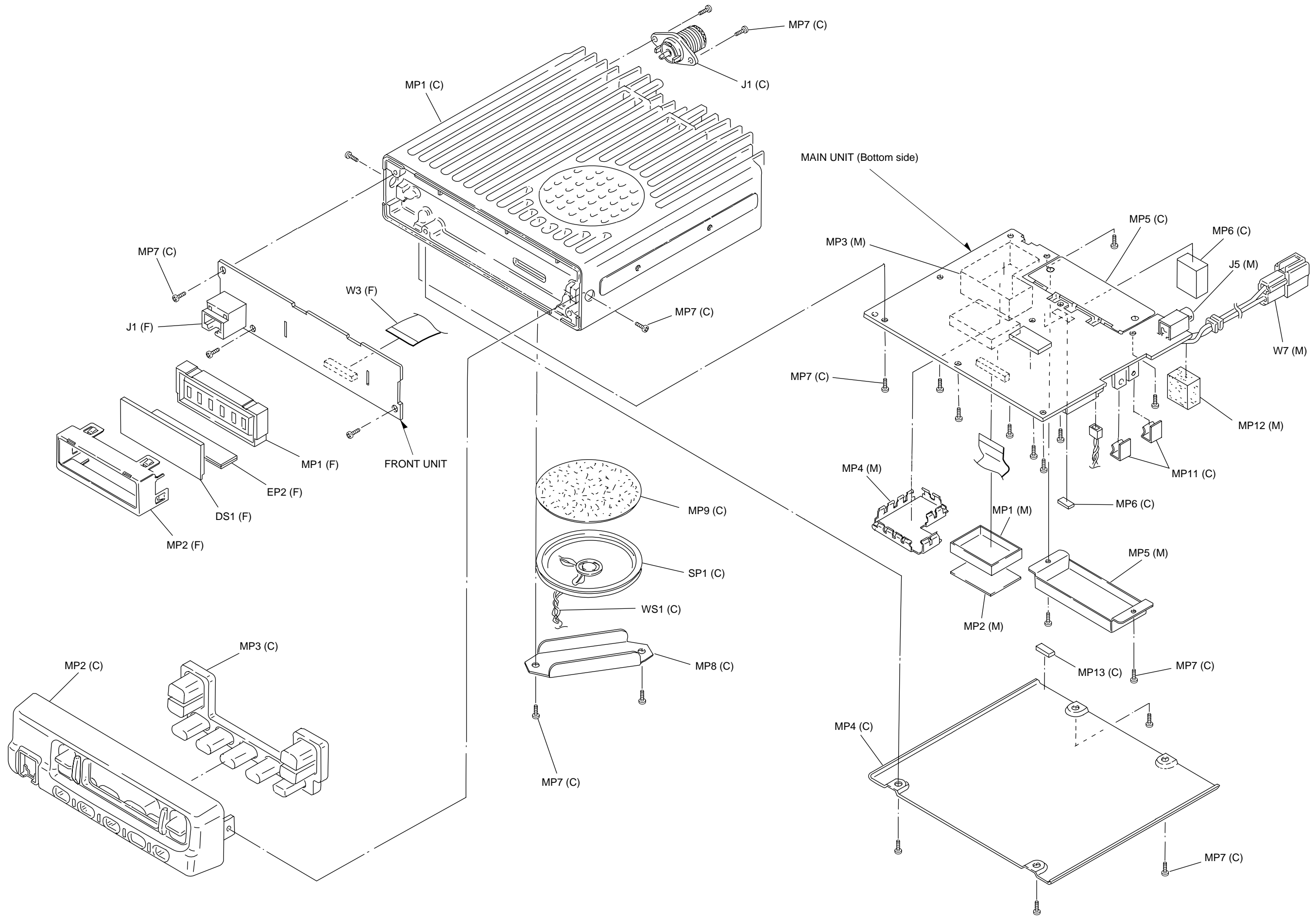

VHF (7610) EXPLODED VIEW

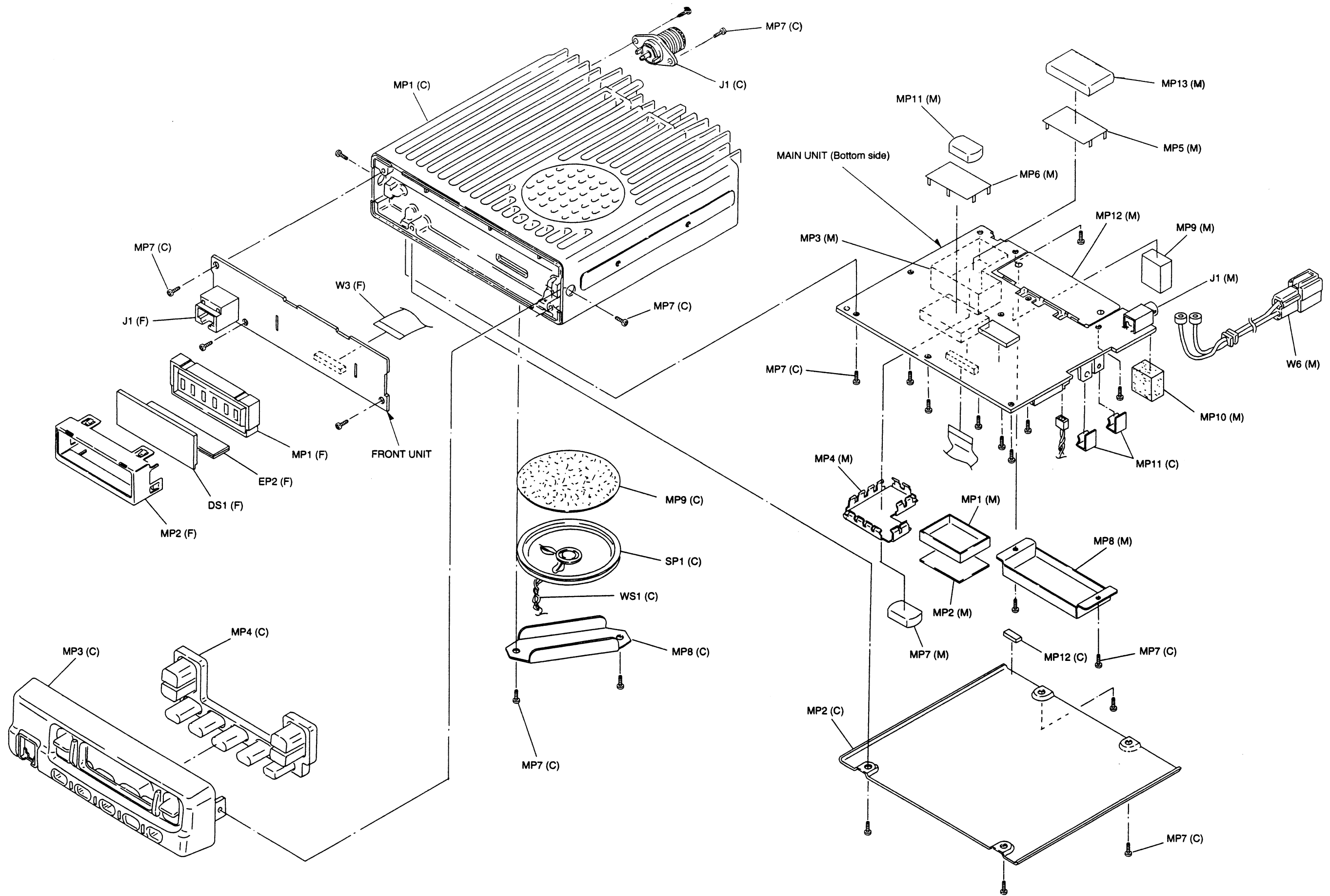

Unit abbreviations (F): FRONT UNIT (M): MAIN UNIT (C): CHASSIS PARTS

UHF (7640) EXPLODED VIEW

← **FOLDOUT (VHF Exploded View)**

November 1998
Part No. 001-7600-001

Download from www.Somanuals.com. All Manuals Search And Download.

SECTION 8 - SCHEMATIC DIAGRAMS AND COMPONENT LAYOUTS

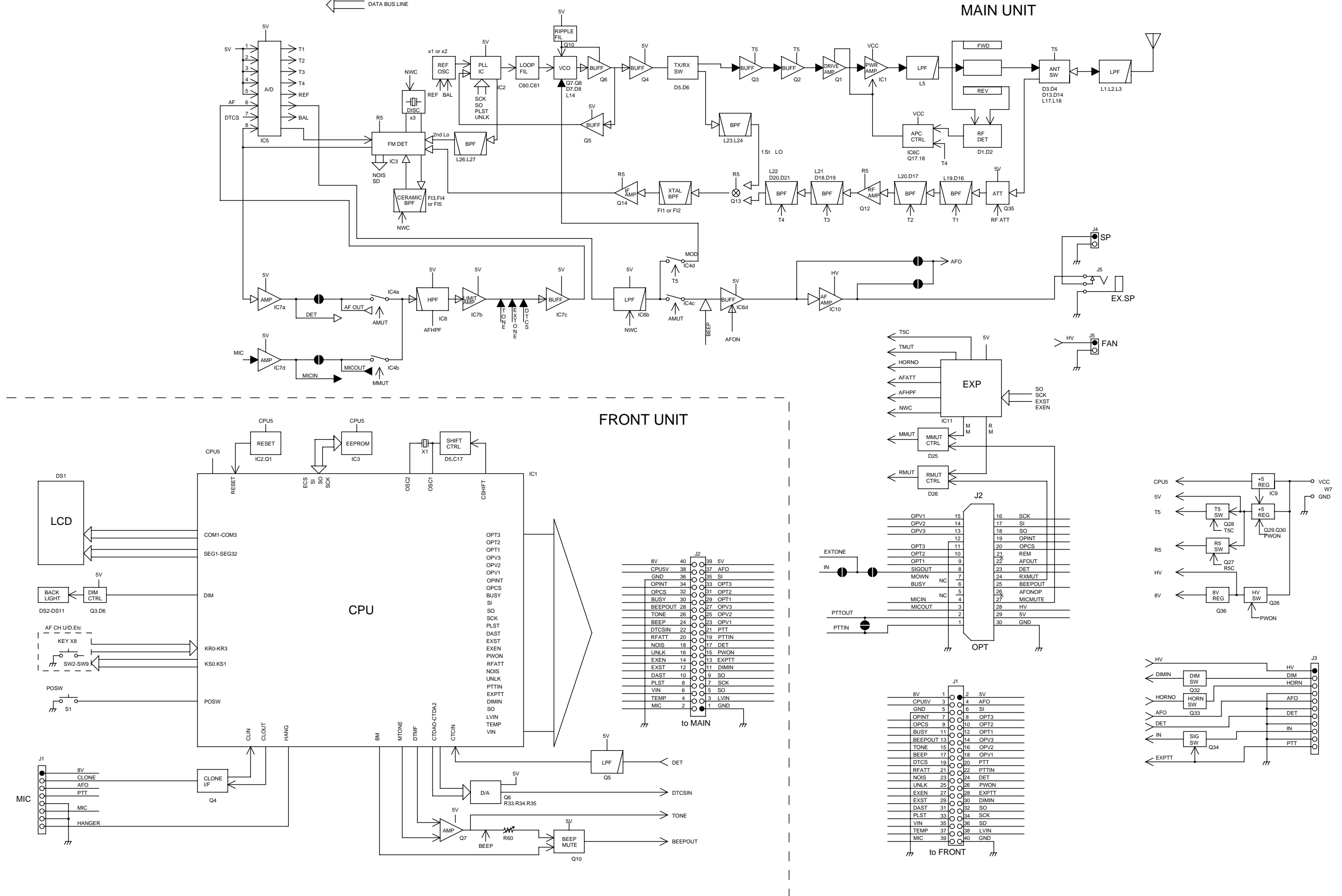
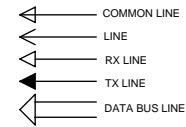

VHF (7610) Transistor Basing Diagrams

• TRANSISTORS AND FET'S

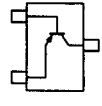
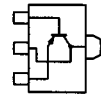
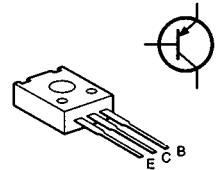
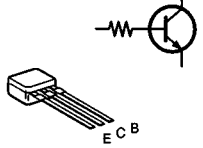
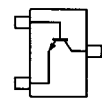
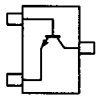
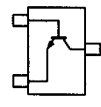
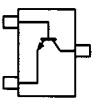
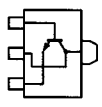
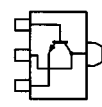
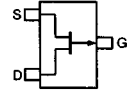
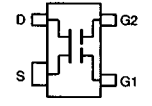
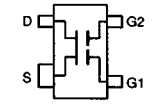
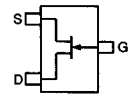
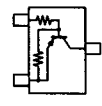
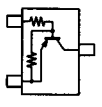
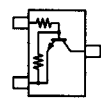
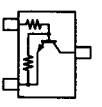
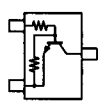
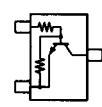
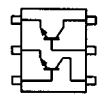
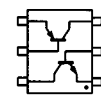
2SA1588 GR (Symbol: ZG) 	2SB1124 S (Symbol: BG) 	2SB1143 S 	2SB1201 S (Symbol: B1201) 	2SC2714 Y (Symbol: QY) 
2SC4081 R (Symbol: BR) 	2SC4215 O (Symbol: QO) 	2SC4226 R25 (Symbol: R25) 	2SC4703 (Symbol: SE) 	2SD1664 (Symbol: DA) 
2SJ144 Y (Symbol: VY) 	2SK166 2 (Symbol: K) 	3SK1239 XR (Symbol: XR) 	2SK1880 Y (Symbol: XY) 	DTA143ZU (Symbol: 113) 
DTA144EU (Symbol: 16) 	DTC114EU (Symbol: 24) 	DTC144TU (Symbol: 06) 	DTC144WU (Symbol: 86) 	DTC363EK (Symbol: H27) 
XP6501 (Symbol: 5N) 	XP4601 (Symbol: 5C) 			

VHF (7610) Diode Basing Diagrams

• DIODES

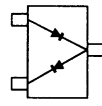
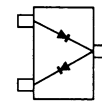
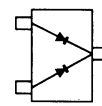
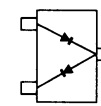
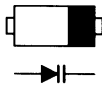
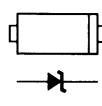
1SS375 (Symbol: FH) 	DA221 (Symbol: K) 	DAN202U (Symbol: N) 	DAN204U (Symbol: K) 	HVU17TRF (Symbol: E) 
MA8051 M (TX) (Symbol: 5-1) 				

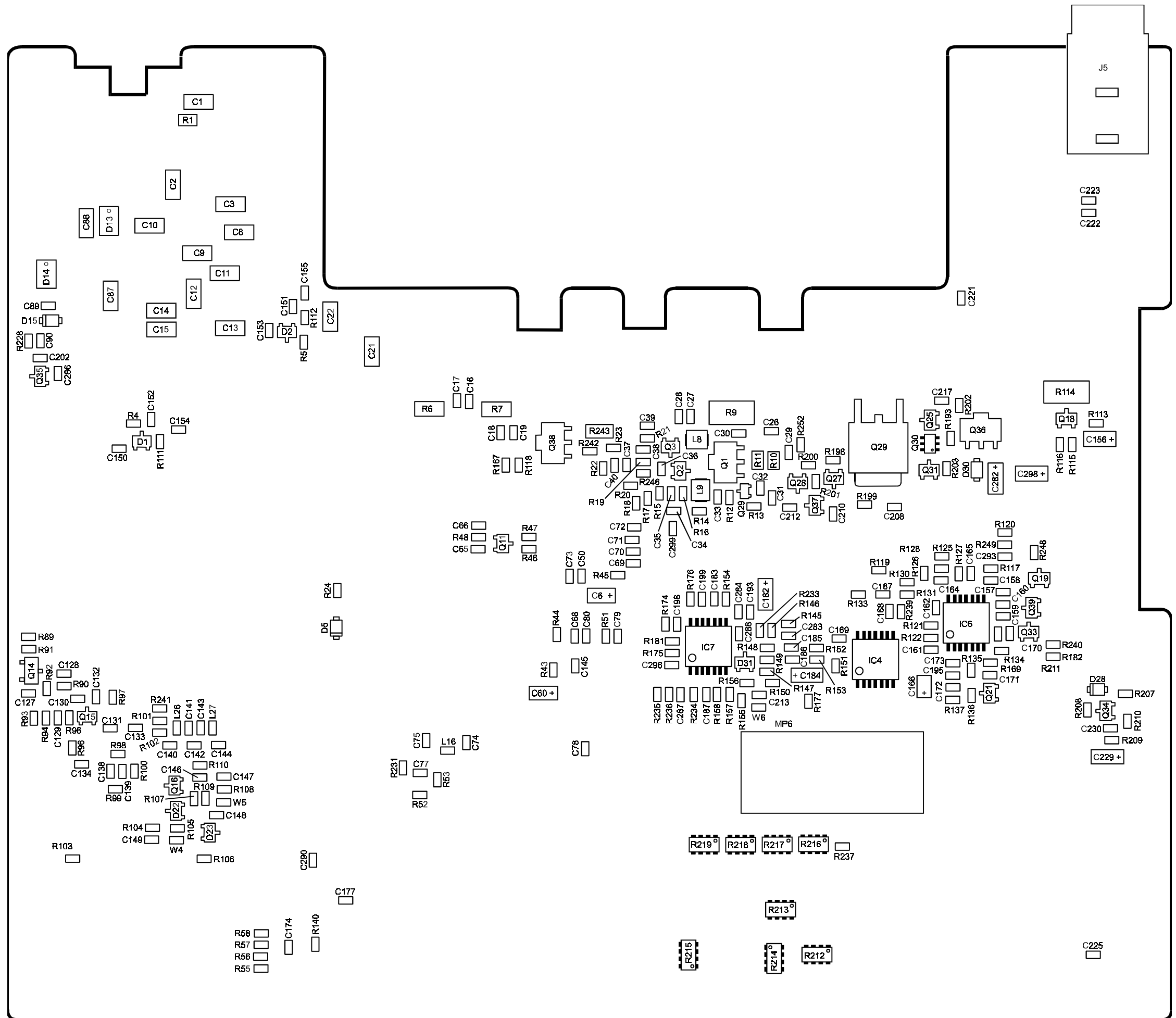

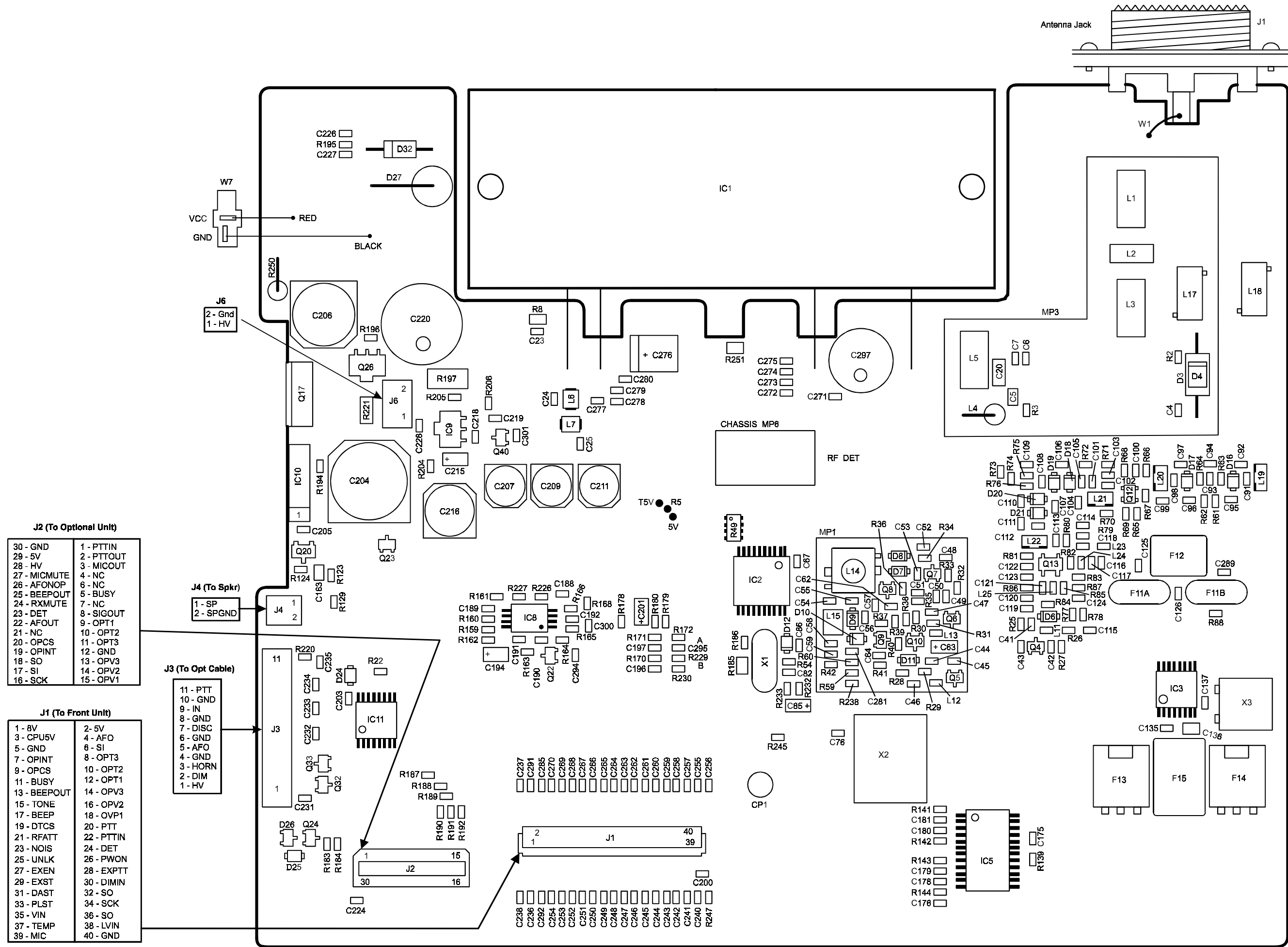

J2 (To Optional Unit)

30 - GND	1 - PTTIN
29 - 5V	2 - PTTOUT
28 - HV	3 - MICOUT
27 - MICMUTE	4 - NC
26 - AFONOP	6 - NC
25 - BEEPOUT	5 - BUSY
24 - RXMUTE	7 - NC
23 - DET	8 - SIGOUT
22 - AFOUT	9 - OPT1
21 - NC	10 - OPT2
20 - OPCS	11 - OPT3
19 - OPINT	12 - GND
18 - SO	13 - OPV3
17 - SI	14 - OPV2
16 - SCK	15 - OPV1

J1 (To Front Unit)

1 - 8V	2 - 5V
3 - CPU5V	4 - AFO
5 - GND	6 - SI
7 - OPINT	8 - OPT3
9 - OPCS	10 - OPT2
11 - BUSY	12 - OPT1
13 - BEEPOUT	14 - OPV3
15 - TONE	16 - OPV2
17 - BEEP	18 - OVP1
19 - DTCS	20 - PTT
21 - RFATT	22 - PTTIN
23 - NOIS	24 - DET
25 - UNLK	26 - PWON
27 - EXEN	28 - EXPPT
29 - EXST	30 - DIMIN
31 - DAST	32 - SO
33 - PLST	34 - SCK
35 - VIN	36 - SO
37 - TEMP	38 - LVIN
39 - MIC	40 - GND

J3 (To Opt Cable)

11 - PTT
10 - GND
9 - IN
8 - GND
7 - DISC
6 - GND
5 - AFO
4 - GND
3 - HORN
2 - DIM
1 - HV

J4 (To Spkr)

1 - SP
2 - SPGND

J6

2 - Gnd
1 - HV

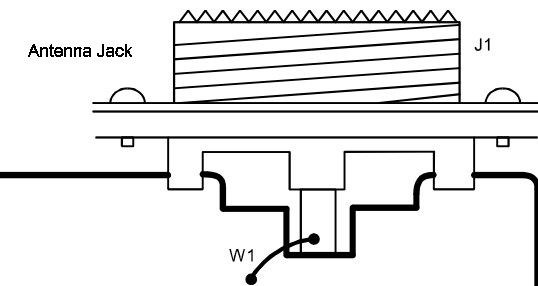
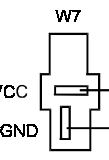

VHF (7610) MAIN BOARD TOP VIEW

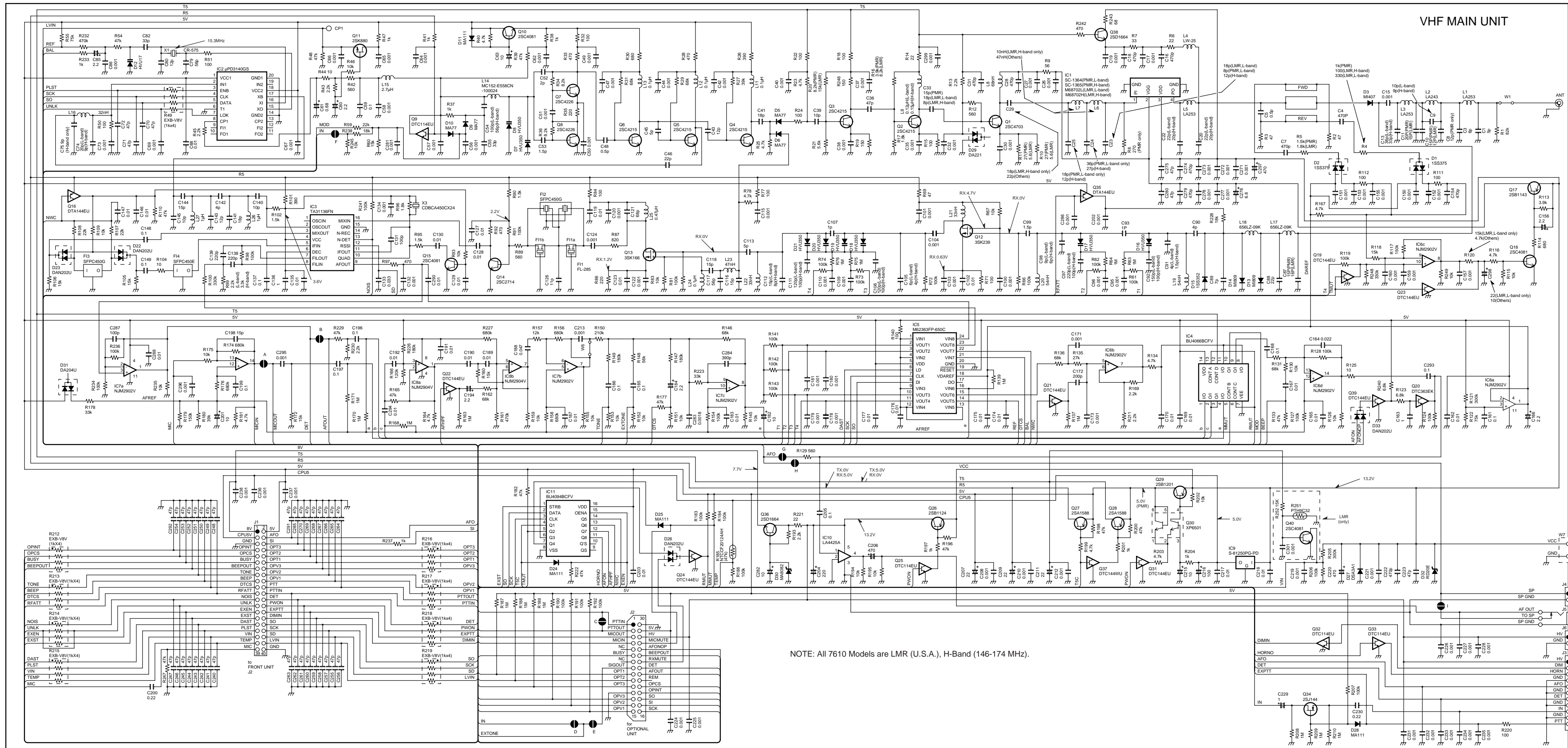

NOTE: All 7610 Models are LMR (U.S.A.), H-Band (146-174 MHz).

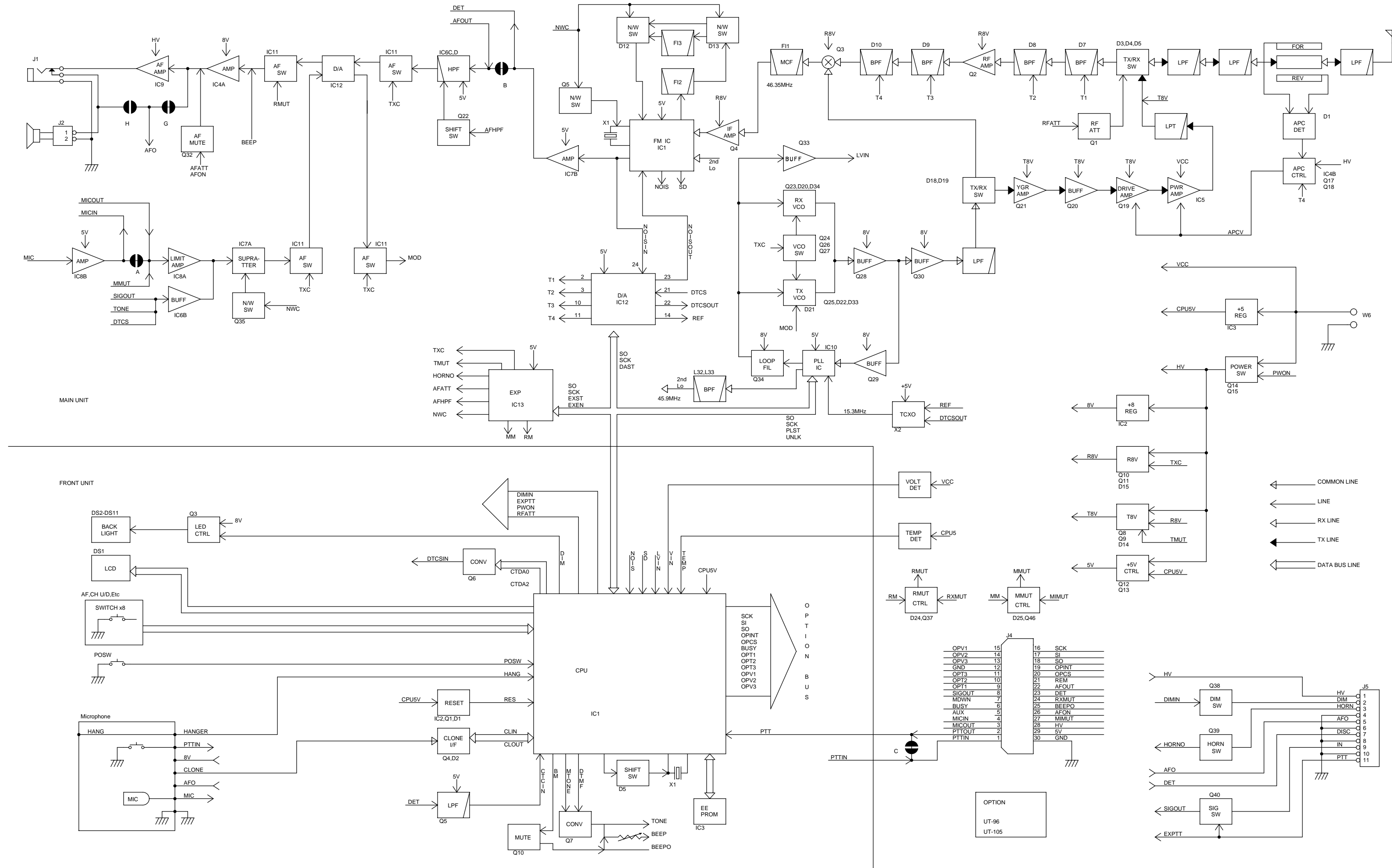

UHF (7640) BLOCK DIAGRAM

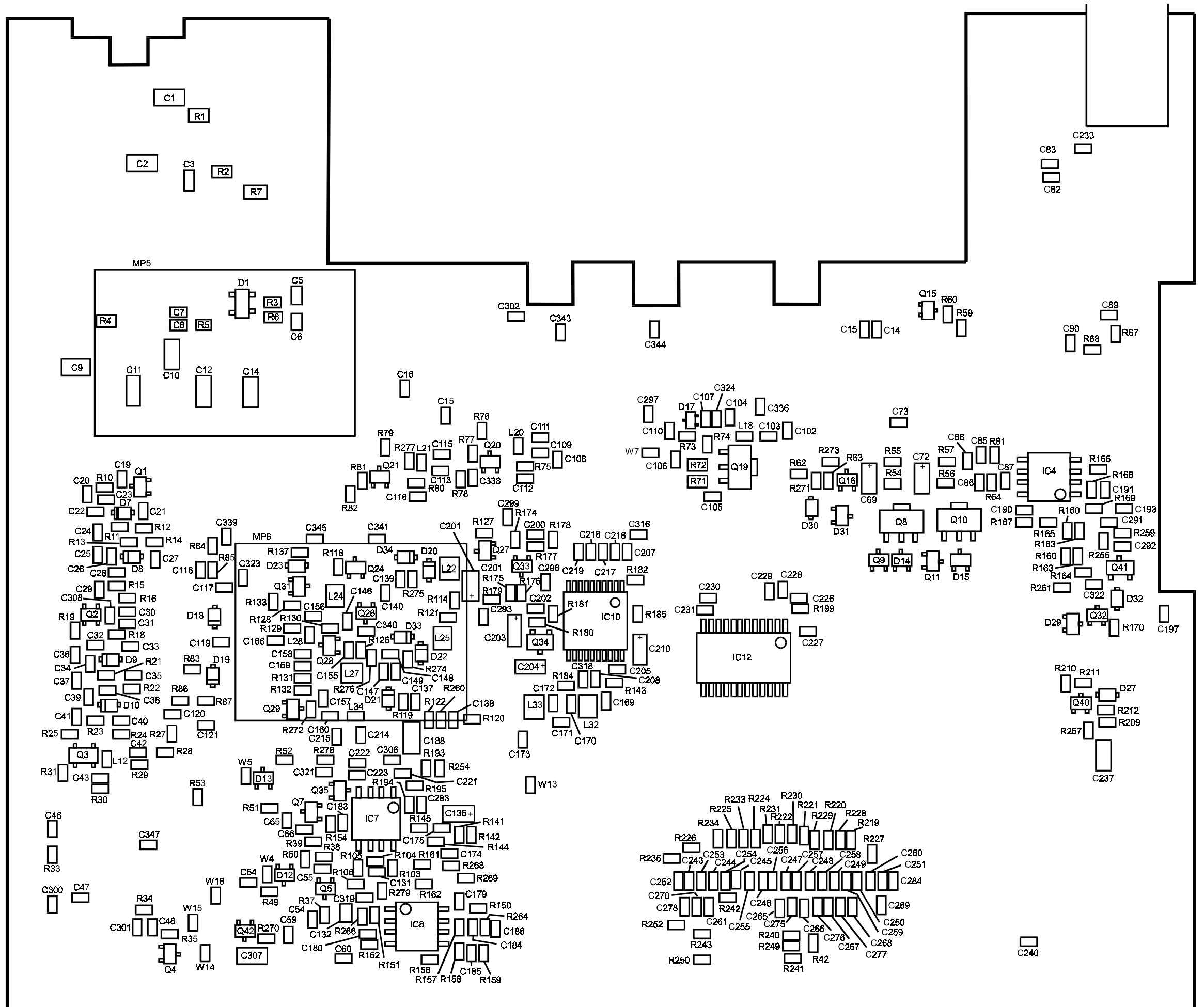

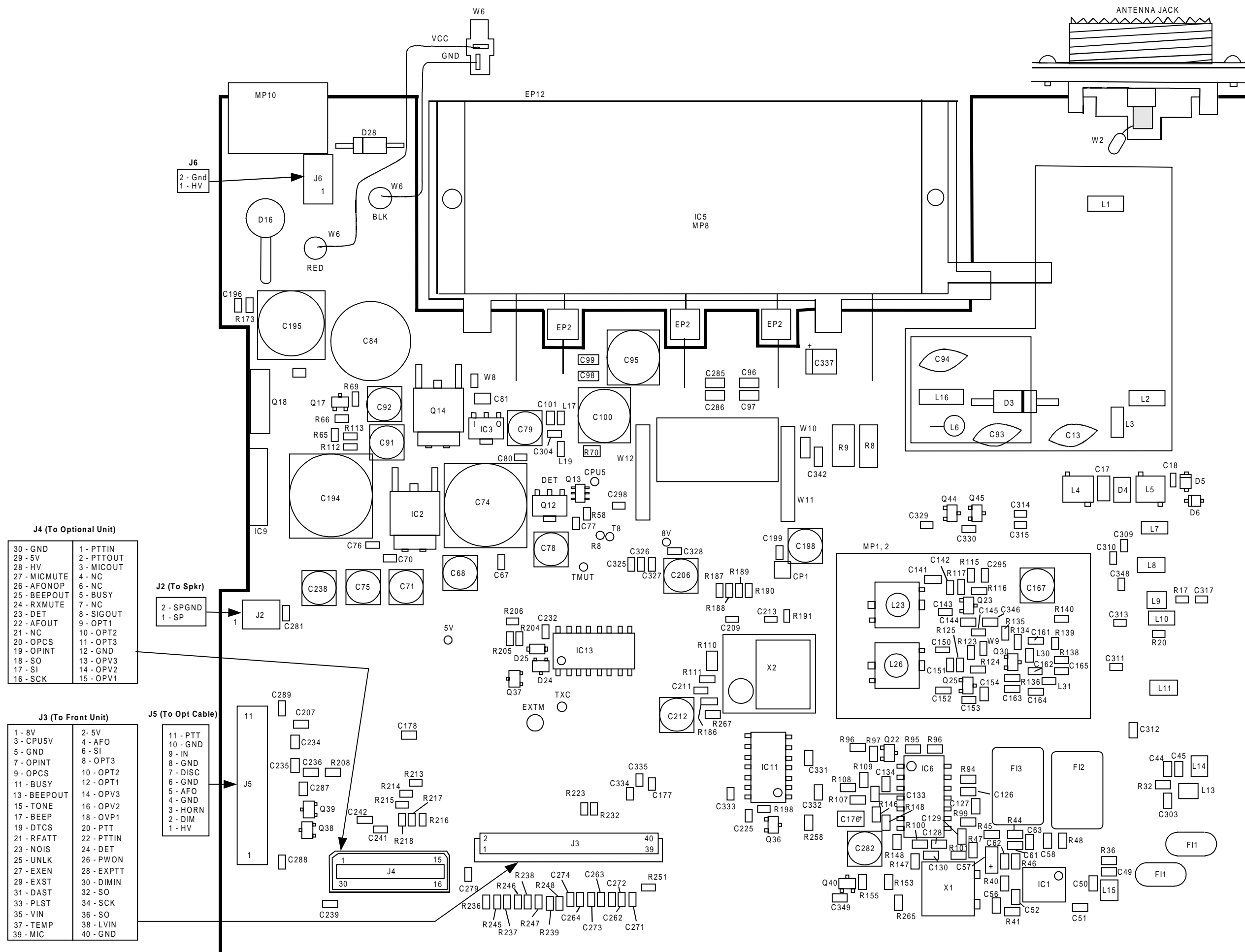

J4 (To Optional Unit)

30 - GND	1 - PTTIN
29 - 5V	2 - PTTOUT
28 - HV	3 - MICOUT
27 - MICMUTE	4 - NC
26 - AFONOP	6 - NC
25 - BEEPOUT	5 - BUSY
24 - RXMUTE	7 - NC
23 - DET	8 - SIGOUT
22 - AFOUT	9 - OPT1
21 - NC	10 - OPT2
20 - OPCS	11 - OPT3
19 - OPINT	12 - GND
18 - SO	13 - OPV3
17 - SI	14 - OPV2
16 - SCK	15 - OPV1

J3 (To Front Unit)

1 - 8V	2 - 5V
3 - CPU5V	4 - AFO
5 - GND	6 - SI
7 - OPINT	8 - OPT3
9 - OPCS	10 - OPT2
11 - BUSY	12 - OPT1
13 - BEEPOUT	14 - OPV3
15 - TONE	16 - OPV2
17 - BEEP	18 - OVP1
19 - DTCS	20 - PTT
21 - RFATT	22 - PTTIN
23 - NOIS	24 - DET
25 - UNLK	26 - PWON
27 - EXEN	28 - EXPTT
29 - EXST	30 - DIMIN
31 - DAST	32 - SO
33 - PLST	34 - SCK
35 - VIN	36 - SO
37 - TEMP	38 - LVIN
39 - MIC	40 - GND

J5 (To Opt Cable)

11 - PTT
10 - GND
9 - IN
8 - GND
7 - DISC
6 - GND
5 - AFO
4 - GND
3 - HORN
2 - DIM
1 - HV

UHF (7640) MAIN BOARD TOP VIEW

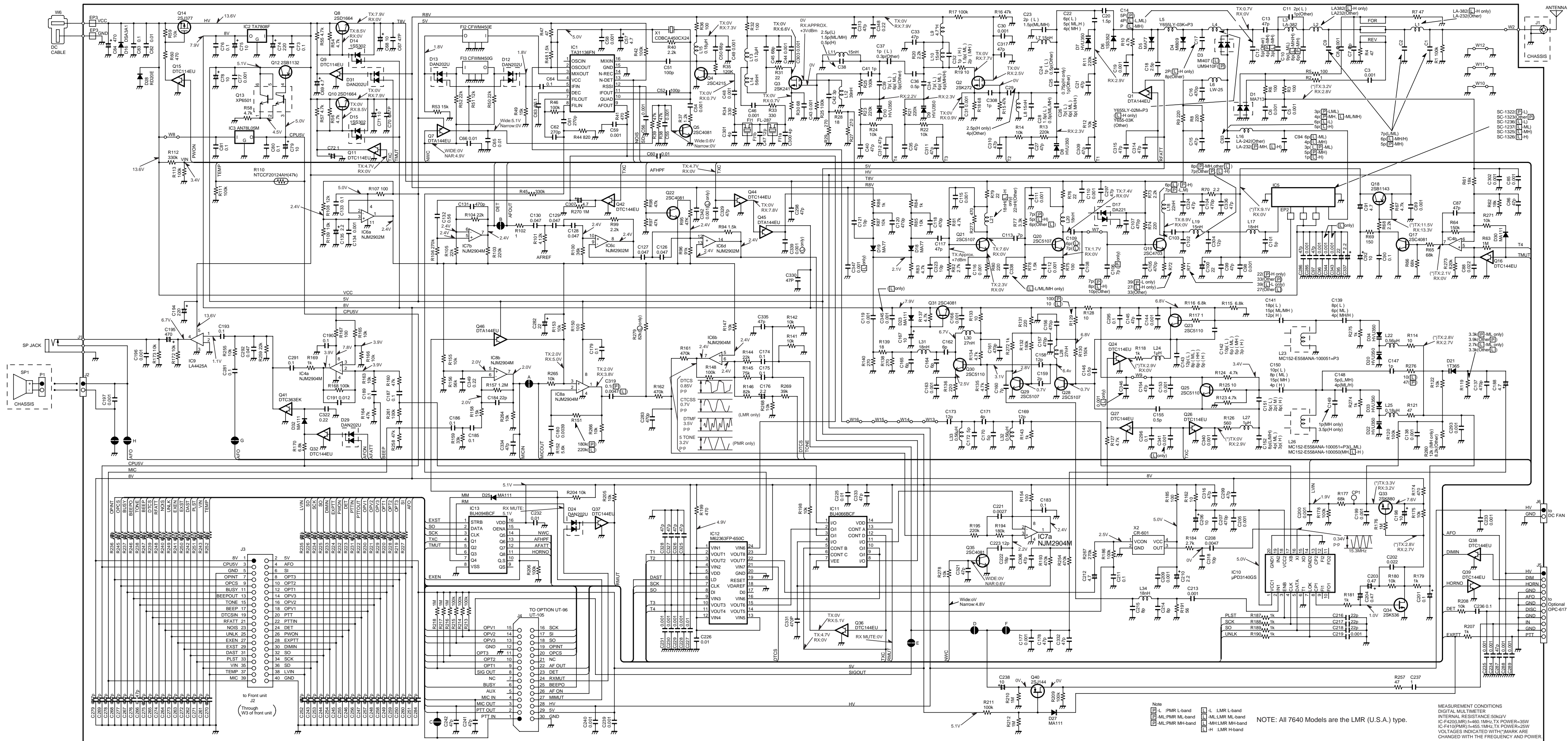

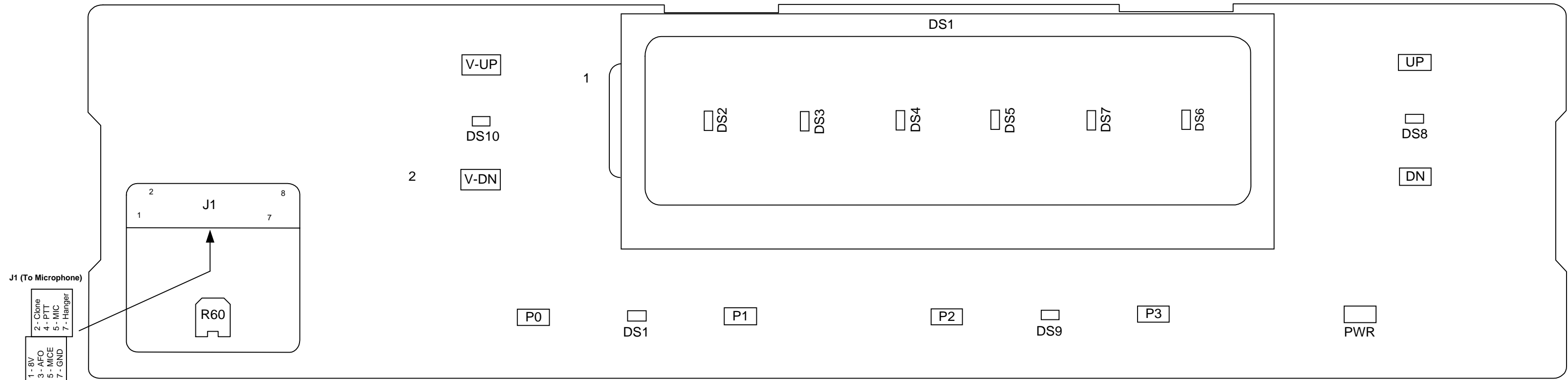

VHF/UHF FRONT UNIT BOARD TOP VIEW

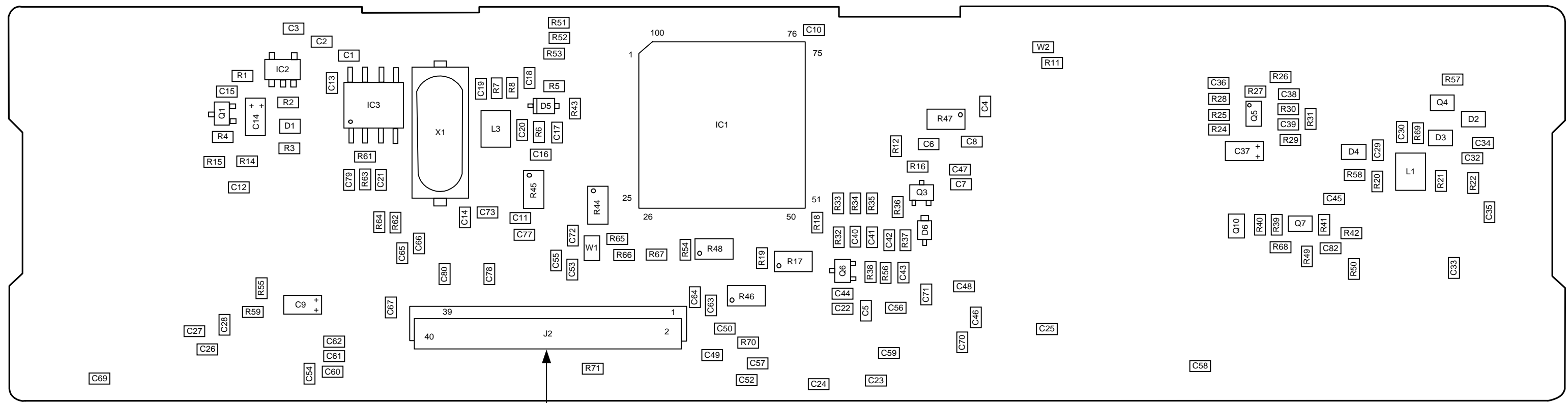

J2 (To Main Unit)

1 - GND	2 - MIC
3 - LVIN	4 - TEMP
5 - SO	6 - VIN
7 - SOCK	8 - PLST
9 - SO	10 - DAST
11 - DIMMIN	12 - EXST
13 - EXPTT	14 - EXEN
15 - P/ON	16 - UNLK
17 - DETN	18 - NOIS
19 - DETN	20 - RFANT
21 - PTTN	22 - RFAS
22 - BESS	23 - BESS
25 - OP/1	26 - TONE
26 - OP/2	28 - BEFBOUT
29 - OP/3	30 - BUSY
31 - OP/4	32 - OPCS
33 - OP/5	34 - OPINT
35 - SI	36 - GND
37 - AFO	38 - CPUSV
39 - 5V	40 - 8V

VHF/UHF FRONT UNIT BOARD BOTTOM VIEW

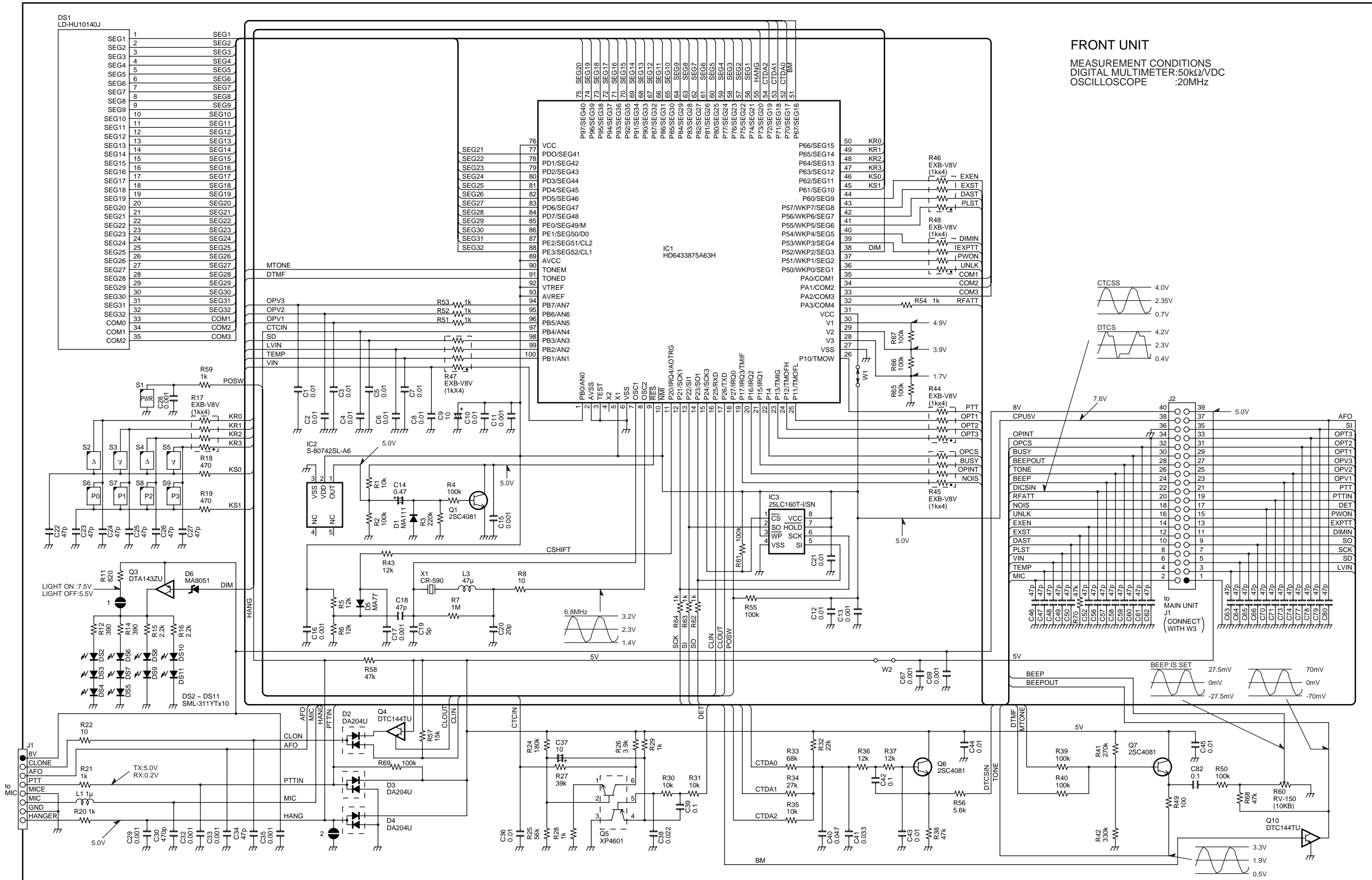

FRONT UNIT
 MEASUREMENT CONDITIONS
 DIGITAL MULTIMETER: 50kΩ/VDC
 OSCILLOSCOPE : 20MHz

UHF (7640) Transistor Basing Diagrams

• TRANSISTORS AND FET'S

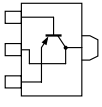
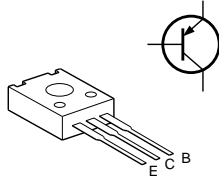
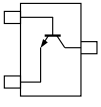
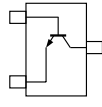
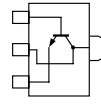
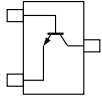
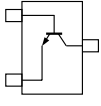
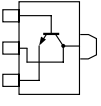
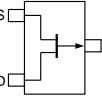
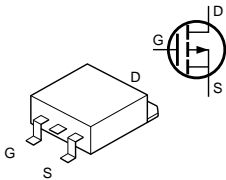
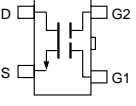
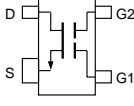
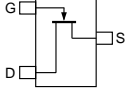
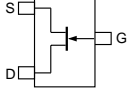
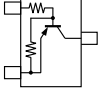
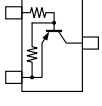
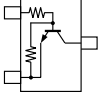
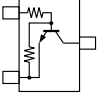
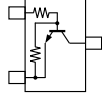
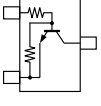
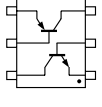
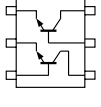
2SB1132 R (Symbol: BARB) 	2SB1143 S 	2SC4081 R (Symbol: BR) 	2SC4215 O (Symbol: QO) 	2SC4703 SE (Symbol: SE) 
2SC5107 O (Symbol: MF) 	2SC5110 O (Symbol: MGO) 	2SD1664 Q (Symbol: DA) 	2SJ144 GR (Symbol: VG) 	2SJ377 (Symbol: 4L) 
2SK241 R (TX) 	2SK272 (Symbol: K) 	2SK536 (Symbol: BJ) 	2SK880 GR (Symbol: XG) 	DTA143ZU (Symbol: 113) 
DTA144EU (Symbol: 16) 	DTC114EU (Symbol: 24) 	DTC144EU (Symbol: 26) 	DTC144TU (Symbol: 06) 	DTC363EK (Symbol: H27) 
XP4601 (Symbol: 5C) 	XP6501 (Symbol: 5N) 			

UHF (7640) Diode Basing Diagrams

• DIODES

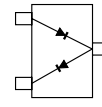
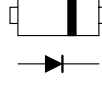
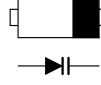
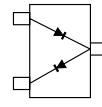
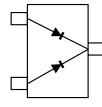
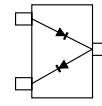
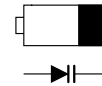
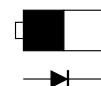
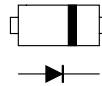
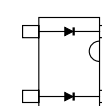
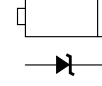
1SS302 (Symbol: C3) 	1SS352 (Symbol: C1) 	1T365 (Symbol: pink line) 	DA221 (Symbol: K) 	DAN202U (Symbol: N) 
DAN204U (Symbol: K) 	HVU350 (Symbol: 4) 	MA77 (Symbol: 4B) 	MA111 (Symbol: 1B) 	MA713 (Symbol: MIN) 
MA8051 M (TX) (Symbol: 5-1) 				

Free Manuals Download Website

<http://myh66.com>

<http://usermanuals.us>

<http://www.somanuals.com>

<http://www.4manuals.cc>

<http://www.manual-lib.com>

<http://www.404manual.com>

<http://www.luxmanual.com>

<http://aubethermostatmanual.com>

Golf course search by state

<http://golfingnear.com>

Email search by domain

<http://emailbydomain.com>

Auto manuals search

<http://auto.somanuals.com>

TV manuals search

<http://tv.somanuals.com>