



3/8" RATCHET WRENCH

MODEL EGA200

OWNERS MANUAL



www.eaglecompressor.com
1-800-551-2406

READ THE ENTIRE MANUAL BEFORE PUTTING THIS TOOL IN SERVICE

Limited Air Tool Warranty

Eagle warrants air tools of its own manufacture against defects in workmanship and materials under normal use and service for twelve(12) months from date of purchase by original purchaser. Parts are covered by this warranty for ninety(90) days from date of purchase.

The following expandable items are warranted against defects in workmanship and materials for ninety(90) days from date of purchase: sockets, screw driver bits and accessories, sanding and back-up pads, impact mechanism, chisels and their retainers, cutting and grinding accessories and any other expandable items not specifically mentioned.

Normal wear and tear, service or maintenance items such as O-rings, springs, gaskets, packing or seals, fluid needles and nozzles, motor vanes or blades, collets, chucks or any such item not specifically mentioned are covered for ninety(90) days from date of purchase warranty only.

Eagle will, at its sole discretion, repair or replace the tool or parts that have failed within the warranty period. If repairs are considered, they will be scheduled in the normal course of the workflow at its service centre.

Not covered under this warranty:

- Indirect or consequential loss or damage or expenses resulting from the failure or malfunction of this tool.
- Accidents or failures resulting from owners neglect, abuse or failure to operate and maintain the tool in accordance with the instructions provided in the owner's manual.
- Tampering, removal or alterations of safety devices will void this warranty.
- Blemishes or cosmetic defects which do not effect the tool's operation.
- Tools used industrially, commercially or in rental applications.

To claim warranty the owner/purchasers must provide proof of purchase and maintenance records, and when requested ship or deliver at owner/purchasers expense and cost to Eagle's factory or service centre



Wear hearing protection.
Wear eye protection.
Wear respiratory protection.

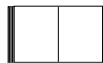

Read the instruction manual

TABLE OF CONTENTS

Limited Warranty	2
Description.....	3
Inspection	3
Safety Instructions	3
Before Using This Air Tool	5
Operating Instructions	5
Troubleshooting.....	5
Parts Breakdown	6
Tool Specifications.....	7

DESCRIPTION

Eagle Air tools are manufactured in accordance with our strict specifications and designed to be used in light duty professional or serious DIY applications. When used in accordance with warnings and instructions given in this manual, and when properly applied and maintained they should give you many years of productive and trouble free service.

This tool is NOT designed for professional, production or industrial use, when used in these applications its life expectancy will be significantly shortened and the warranty will be void.

INSPECTION

Upon receipt of your new tool, carefully check for any shipping damage. If your new tool is damaged in shipping you need to file a claim with the carrier at once, and before contacting Eagle's customer service department.

Also carefully check to make sure all accessories (if included) are with the tool. Make sure any loose bolts, fittings etc. are tightened before you put this tool into service.

SAFETY INSTRUCTIONS

You should operate this air tool only if you have read this entire manual, and understand its content, and you are familiar with safety and proper use when operating this equipment. This air tool is part of a high pressure compressed air system, the following safety precautions must be followed at all times.



Wear hearing protection.
Wear eye protection.
Wear respiratory protection.

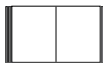

Read the instruction manual

SAFETY INSTRUCTIONS

1)	Always wear protective goggles or safety glasses, hearing protection, protective gloves and footwear.
2)	Air tools can create dust when drilling, grinding, sanding or cutting. This dust can contain substances known to cause cancer, birth defect, etc. Also wear proper breathing protection.
3)	Do not wear loose clothing or jewelry, and ensure long hair is protected with a proper cover.
4)	Do not exceed the maximum operating pressure of this tool or any component in the air delivery system.
5)	Do not depress the trigger when connecting this tool to the air supply system. Always disconnect the tool from the air supply system when changing attachments.
6)	Only use attachments specifically designed for use with air tools. Hand tool sockets can shatter and cause serious injury. Do not use worn or damaged attachments. Make sure attachments are securely attached to the air tool.
7)	Do not point the air tool at yourself or any other person.
8)	Never use Oxygen or combustible gases to operate this tool. Use only lubricated compressed air regulated to the recommended operating pressure for this tool.
9)	Disconnect this tool from its air supply before attempting to install or change attachments or before attempting any service. Also disconnect the air tool from the compressed air system when not in use.
10)	Excessive use of this tool can cause injury due to vibration and fatigue. Do not use this tool in awkward positions, and avoid repetitive work motions. When feeling discomfort, numbness, fatigue, tingling or pain stop work immediately and seek medical treatment and advice.
11)	Inspect air hoses, and discard if in worn, weak or damaged condition. Make sure all air connections are tight and secure.
12)	Keep hands away from moving parts
13)	Consider working conditions and environment. Do not operate this tool around hazardous gases or flammable gases. Keep your work area neat and tidy and make sure the work area is well lit.
14)	Always use clamping devices to hold all work securely in place, never use hands or other body parts for holding work. Both hands must be used to operate this air tool, enabling control and safety.
15)	Do not use this air tool if intoxicated, if you are using drugs or medication causing drowsiness or if you are tired.
16)	Do not leave this air tool unattended, and disconnect from the air delivery system when not in use. Children must be supervised in the proximity of any air tool or work area.
17)	Follow air supply manufacturer's recommendation for connection of regulators, filters and other accessories. Do not install quick couplers directly on air tool, it puts unnecessary strain on the air inlet threads, instead install a short length of air hose to the tool. Do not over tighten fitting connecting to the air tool; this could cause the housing to crack. Use Teflon tape or pipe sealant carefully to prevent excess from entering the air tool.



Wear hearing protection.
Wear eye protection.
Wear respiratory protection.

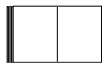

Read the instruction manual

BEFORE USING THIS AIR TOOL

To ensure long life be sure to oil the tool daily. Pour 4 drops of Eagle air tool (SEA 20 non detergent) oil into the air inlet, and then run the tool for a few seconds to clean.

If tool is an impact wrench fitted with a "Zirc" grease fitting:

The hammer mechanism of this tool also needs to be greased from time to time (depending on usage). The tool is equipped with grease fitting for this purpose; use this connection to re-grease the tool using Eagle impact wrench grease.

PLEASE USE EAGLE SEA 20 NON DETERGENT OIL

OPERATING INSTRUCTIONS

This ratchet is designed to speed up productivity, not for high torque applications such as head bolts, lug nuts, etc. **DO NOT USE THIS RATCHET UNDER POWER TO BREAK FASTENERS LOOSE.** Loosen fasteners by hand without depressing throttle. Once loose depress throttle. Always perform final torque tightening by hand.

This ratchet is rated to 3/8" bolt size. Rating will decrease for U-bolts, long cap screws, spring fasteners and rusted or corroded fasteners. All these factors absorb power and reduce torque capability.

Use the simplest socket to wrench hook-up. Any additional extensions, U-joints or adapters will absorb power and reduce torque capability.

Forward/Reverse Lever - Select "F" for forward (clockwise) or "R" for reverse (counter clockwise) operation. Do not attempt to change direction while tool is running.

If fastener bogs, slows or binds the tool (or, if the fastener fails to move in 5 seconds), use a large size impact wrench with a higher torque rating. Overloading this tool will cause premature wear and/or permanent damage to internal and external drive parts and will void warranty.

TROUBLESHOOTING

SYMPTOMS	CAUSE	REMEDY
Air tool does not run or runs slow.	Lack of lubrication.	Lubricate as per instructions.
	Dirt in tool.	Clean with mixture of 50/50 tool oil/solvent. Lubricate after cleaning.
	Insufficient air pressure.	Check regulator and air supply for leaks. Check compressor to make sure it operates at correct pressure. Make sure air hose is properly sized and that multiple hoses are not connected to same outlet. Check air hose for leaks and repair.
	Rotor blades worn or motor bearing worn or dirty.	Replace blades, inspect clean or replace bearing.
IMPACT WRENCH does not impact or impacts slowly.	See causes (above).	See remedies (above).
	Broken or worn impact mechanism.	Inspect and repair as required.



Wear hearing protection.
Wear eye protection.
Wear respiratory protection.

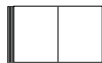

Read the instruction manual

PARTS BREAKDOWN

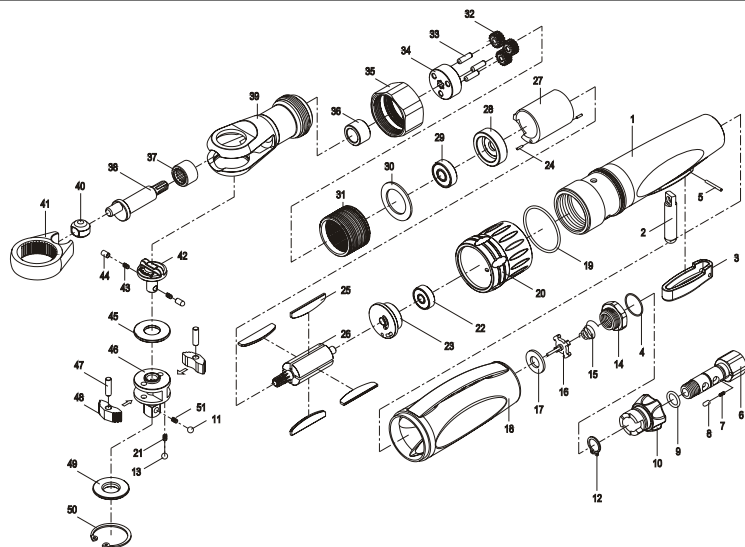

INDEX	PART	DESCRIPTION	QTY
1	75001	Housing	1
2	75002	Valve Stem	1
3	75003	Throttle Lever	1
4	75004	O-Ring	1
5	75005	Trigger Pin	1
6	75006	Air Inlet	1
7	86021	Spring	1
8	86022	Lock Pin	1
9	16012	O-Ring	1
10	75010	Air Regulator	1
11	15043	Steel Ball	1
12	75012	O-Ring	2
13	15041	Steel Ball	1
14	75014	Inlet Adaptor	1
15	75015	Valve Spring	1
16	75016	Throttle Valve	1
17	75017	Valve Seat	1
18	75018	Plastic Grip	1



Wear hearing protection.
Wear eye protection.
Wear respiratory protection.

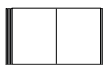

Read the instruction manual

19	75019	O-Ring	1
20	75020	Exhaust Deflector	1
21	15040	Spring	2
22	15030	Ball Bearing	4
23	15029	Rear End Plate	1
24	15031	Dowel Pin	1
25	15026	Rotor Blade	4
26	15025	Rotor	1
27	1524	Cylinder	1
28	15027	Front End Plate	1
29	15028	Ball Bearing	1
30	45013	Washer	1
31	15012	Thread Ring Gear	1
32	15014	Plate Gear	3
33	15014	Gear Pin	3
34	15015	Gear Plate	1
35	15016	Clamp Nut	1
36	15013-01	Bushing	1
37	15020	Needle Bearing	1
38	15021	Crank Shaft	1
39	45019	Ratchet Housing	1
40	45021	Drive Bushing	1
41	45024	Ratchet Yoke	1
42	15023-01	Reverse Button	1
43	45038-01	Spring	2
44	15034	Lock Pin	2
45	45034	Washer	1
46	45052	Anvil	1
47	45020	Pin	2
48	45037	Ratchet Pawl	2
49	45038	Thrust Washer	1
50	15039	Retainer Ring	1
51	15044	Spring	1

Bolt Capacity3/8"
 Max torque (FT/LBS)..... 60
 Air pressure (PSI) (Tool in use at full throttle)..... 90
 Average air consumption (CFM).....4.0
 Free speed (RPM).....180
 Air inlet (NPT).....1/4"
 Hose size (ID).....3/8"



Wear hearing protection.
 Wear eye protection.
 Wear respiratory protection.

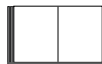

Read the instruction manual



Eagle Air Compressors Ltd.
manufactures and distributes
top of the line, high quality

AIR COMPRESSORS
AIR COMPRESSOR PARTS
AIR POWERED ACCESSORIES



1-800-551-2406
www.eaglecompressor.com

Free Manuals Download Website

<http://myh66.com>

<http://usermanuals.us>

<http://www.somanuals.com>

<http://www.4manuals.cc>

<http://www.manual-lib.com>

<http://www.404manual.com>

<http://www.luxmanual.com>

<http://aubethermostatmanual.com>

Golf course search by state

<http://golfingnear.com>

Email search by domain

<http://emailbydomain.com>

Auto manuals search

<http://auto.somanuals.com>

TV manuals search

<http://tv.somanuals.com>