

---

## TNT Series Amplifiers Owners Manual

---



### MODELS:

T500W/2

T1000W/2

T2000W/4

T2000WD/1

TD5X



Earthquake Sound reserves the right to amend details of the specifications without notice.  
Copyright © Earthquake Sound Corporation  
Earthquake Sound Corporation • 2727 McCone Avenue Hayward CA, 94545 • Tel 510-732-1000



## TABLE OF CONTENTS

Our Thank You.....	2
Cautions and Advisories.....	2
Signal Sensing Feature.....	3
Specifications.....	4 - 5
Adjustments and Installation:	
<b>T500W/2</b> (2-Channel Class A/B).....	6 - 7
<b>T1000W/2</b> (2-Channel Class A/B).....	8 - 9
<b>T2000W/4</b> (4-Channel Class A/B).....	10 - 11
<b>T2000WD/1</b> (Mono Class D).....	12 - 13
<b>TD5X</b> (Full Range + Mono Class D).....	14 - 15

## THANK YOU

Thank you for choosing Earthquake Sound's line of TNT amplifier: the best way to enhance your factory mobile audio system. With proper installation and responsible listening, your amplifier(s) will give you years of near perfect sound reproduction.

We strongly recommend you to have your new amplifier(s) installed by an authorized Earthquake Sound dealer. Installation professionals employed by your dealer have the correct tools and knowledge to install your amplifier(s) neatly and successfully. Also, when your new products are installed by an authorized dealer, your product will include a FIVE (5) YEAR LIMITED WARRANTY. If you choose to perform your own installation, your warranty will be subject to limitations. Dealer policies on handling warranty requests may vary from one dealer to the next.

Please read the warranty information in its entirety and use good judgment when making these vital decisions.

**CAUTION:** Earthquake Amplifiers are capable of generating high sound pressure levels. You should exercise caution when operating these amplifier systems. Long term exposures to high levels of sound pressure will cause permanent damage to your hearing. Sound pressure levels exceeding 85dB can be dangerous with constant exposure. Set your audio system to a comfortable loudness level. Earthquake Sound Corporation does not assume liability for damages resulting from the direct use of Earthquake amplifiers or other Earthquake products and urges users to play their music at moderate listening levels.

SOUND LEVEL DBA	DURATION IN HOURS
90	8
92	6
95	4
97	3
100	2
102	1 - 1 1/2
105	1
110	1/2
115	1/4 or less

THE CHART (ON THE SIDE) SHOWS THE U.S. GOVERNMENTS OCCUPATIONAL SAFETY AND HEALTH ADMINISTRATION (OSHA) REGULATIONS WHICH WERE IN EFFECT AT THE TIME OF THIS PUBLICATION FOR PERMISSIBLE NOISE EXPOSURE, PER 29CFR1910.95, TABLE G-16.

## SIGNAL SENSING FEATURE - AUTO ON/REMOTE ON

This TNT amplifier features the new, improved and more powerful circuitry. Better yet, Earthquake Sound has added a special **AUTO SIGNAL SENSING Feature** which allows installers to turn on the amplifier without using the remote wire.

By simply connecting the RCA or Speaker level inputs to the amplifier, it will turn on automatically when it senses an audio signal. This feature makes upgrading the sound system in many of the latest model vehicles easier for installers as it eliminates the need to connect a remote turn on wire to the amplifier.

Before you proceed, please note the following:

- This feature may not be compatible with all latest model vehicles.
- If your vehicle is going to be parked for over 4 weeks, then you should disconnect the main fuse of the amplifier.
- Be sure to follow the connection instructions and illustrations below.

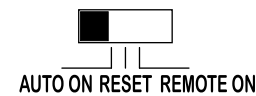

### AUTO ON

When the switch is on **AUTO ON**, the amplifier will automatically detect an incoming signal when the stereo is turned on. If the amplifier does not detect any signal after 20 minutes, the amplifier will automatically turn off.

The proper power and remote wire connection when using the **AUTO SIGNAL SENSING** is illustrated below.

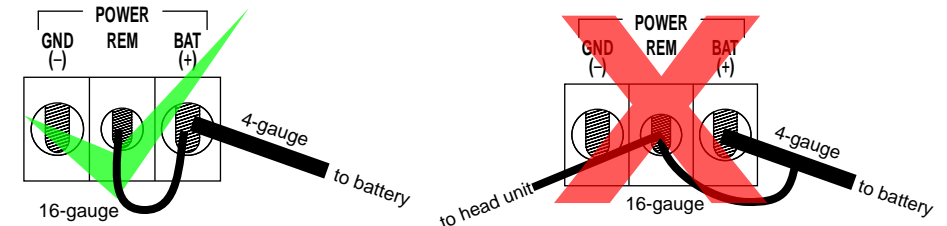

**DO NOT** connect the remote wire to the head unit as this will damage your sound system.

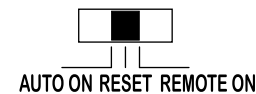

### RESET

In case the system goes into protection, simply turn off the audio source, lower the volume and slide the switch to **RESET** then back to **AUTO ON** position.



### REMOTE ON

When the switch is on **REMOTE ON**, the amplifier relies on the remote wire to detect the signal and turn the amplifier on or off.

**NOTE:** RCA outputs must be inserted in CH1/2 for the amplifier to detect any incoming signal.

## SPECIFICATIONS

Model	T500W/2	T1000W/2	T2000W/4	T2000WD/1	TD5X
Class	A/B	A/B	A/B	D	D
Number of Channels	2	2	4	1 Mono	4 Full Range + 1 Mono
Max Power Output	800 Watts	1400 Watts	2000 Watts	2000 Watts	3000 Watts
Max Power 4-Ohm Bridged	1 x 400	1 x 700	2 x 250	1 x 1000 @ 2V <sup>^</sup>	2 x 100 @ 4V <sup>^</sup> 1 x 300 @ 4V <sup>^</sup>
Max Power 4-Ohm Stereo	2 x 150	2 x 300	4 x 100	1 x 600 @ 4V <sup>^</sup>	4 x 100 @ 4V <sup>^</sup> 1 x 600 @ 2V <sup>^</sup>
THD @ 4-Ohm THD @ 2-Ohm	> 0.01% > 0.05%	> 0.01% > 0.05%	> 0.01% > 0.05%	> 0.01% > 0.016%	> 0.01% > 0.016%
Channel Separation	> 60 dB		> 60 dB		
Crossover Frequency, LPF Crossover Frequency, HPF Crossover Frequency, SUB	50 - 250 Hz 50 - 250 Hz N/A	50 - 250 Hz 50 - 250 Hz N/A	50 - 250 Hz 50 - 250 Hz N/A	N/A N/A 50 - 300 Hz	40 - 400 Hz 40 - 400 Hz 40 - 160 Hz
Bass Boost	0 - 18 dB	0 - 18 dB	0 - 18 dB	0 - 10 dB	N/A
Fuse	1 x 30 Amp	2 x 25 Amp	2 x 20 Amp	2 x 30 Amp	3 x 25 Amp
Signal-to-Noise Ratio	95 dB Below Rated Power		95 dB Below Rated Power		
Dimensions (H x W x D)	2-1/4" x 9-3/4" x 9"	2-1/4" x 9-3/4" x 13-5/16"	2-1/4" x 9-3/4" x 13-3/8"	2-1/4" x 9-3/4" x 11"	2-1/4" x 9-3/4" x 16-3/8"
Net Weight	4.25 lbs	6.4 lbs	6.5 lbs	6 lbs	9 lbs

\* Dimensions include plugs, terminals and mounting feet.

^ Minimum impedance is 4V<sup>^</sup>

Please refer to the warranty guidelines provided with the amplifier. It is recommended that you keep a copy of your sales receipt and note your serial number here for future reference.

SERIAL NUMBER

# T500W/2

**HIGH LEVEL INPUT:** Speaker level inputs with a range of 0.5V to 17V RMS.

**LEVEL ADJUST:** Allows the amplifier to deliver a controlled maximum sound level into selected channel(s) when the volume is turned to max. This acts as a volume limiter for the system, preventing you from over driving the speakers or subwoofers.

**MODE SELECTOR:** This feature tells the amplifier to run in either HIGH PASS, FULL RANGE or LOWPASS MODE

**2-WAY 12dB/Oct VARIABLE XOVER:** Control the corresponding channels cutoff frequencies. This feature is disabled when in FULL RANGE

RCA line through to cascade another amplifier. No Xover point.

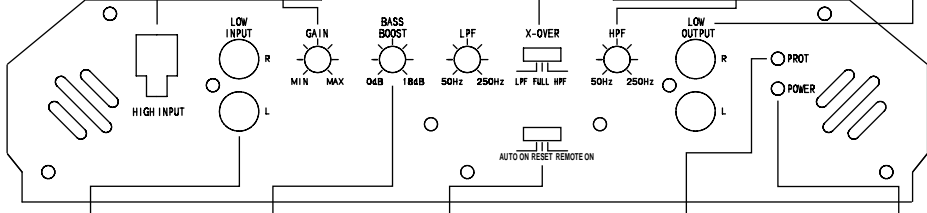

**LOW LEVEL INPUTS:** Low level inputs with a range of 0.2V to 5V RMS. This is where the front and rear RCA outputs from your head unit or other devices are inserted.

**BASS BOOST:** 0 - 18dB Bass Boost for use with subwoofers.

**AUTO SIGNAL SENSING:** Please refer to page 3 for explanation of this feature.

**PROTECTION (PROT) LED:** If LED comes on then you have an issue that requires service. Turn off the amplifier and call Earthquake for further assistance. See warranty for details.

**POWER LED:** When LED is on, it indicates that the amplifier is ON and functioning properly.

XOVER KNOB SETTING	50Hz	90Hz	125Hz	170Hz	210Hz	250Hz
<b>VARIXR</b>						

WARNING	GAIN KNOB SETTING					
	MAX INPUT VOLTAGE BEFORE CLIPPING	MIN	9	12	3	MAX
	RCA LEVEL	7.0V	4.0V	2.5V	1V	200mV
	SPEAKER LEVEL	17.0V	10.0V	5.0V	1V	300mV

**WARNING**  
The gain knob is not a volume control. It is designed to match the input level of the amp to the output level of the source unit. Over driving "clipping" the input stage of the amp will cause damage to the amplifier (please refer to table for setting).

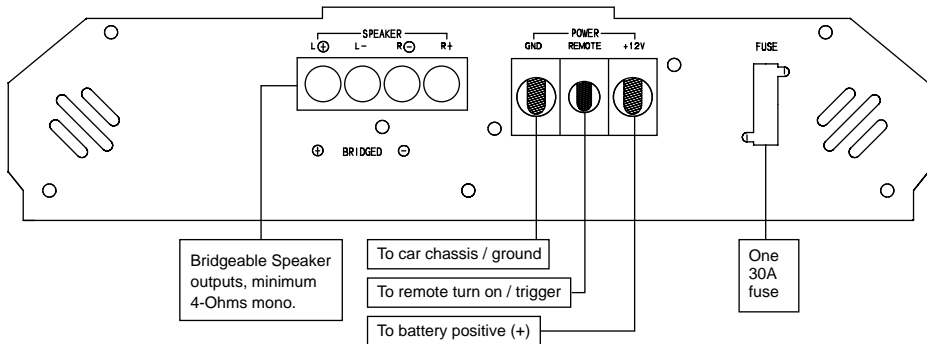

## FRONT STEREO IMAGES

Set Xover knob to MINIMUM and set Xover switch to high-pass.

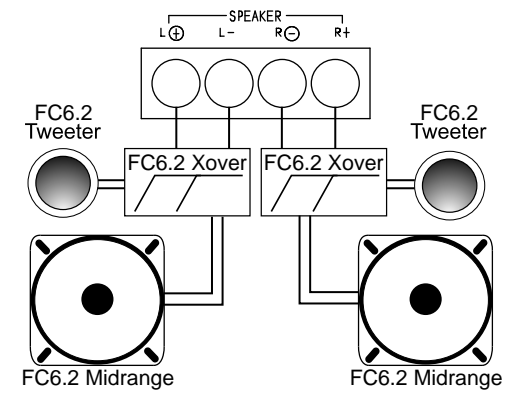
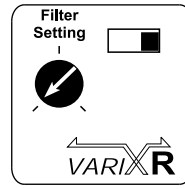

## REAR FILL STAGING

Set Xover switch to FULL

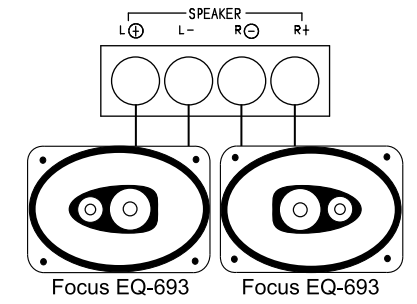
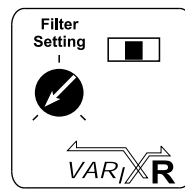

## BASS APPLICATIONS

Set Xover knob to 2 O'clock, & set Xover switch to low-pass.

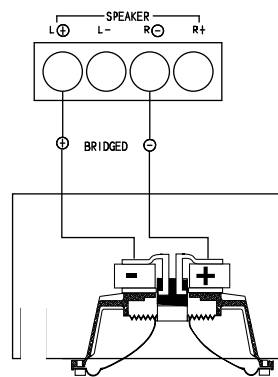
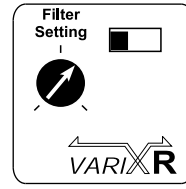

Bass reflex enclosure using 10", 12" or 15" subwoofers with single 4-ohm voice coils.

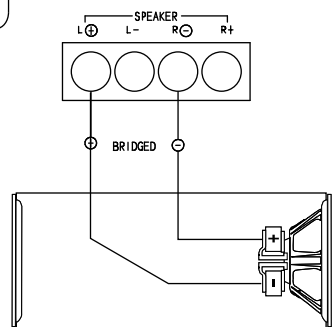

K-10, ten-inch bass tube, in mono application (4 Ohms minimum)

# T1000W/2

**HIGH LEVEL INPUT:** Speaker level inputs with a range of 0.5V to 17V RMS.

**LEVEL ADJUST:** Allows the amplifier to deliver a controlled maximum sound level into selected channel(s) when the volume is turned to max. This acts as a volume limiter for the system, preventing you from over driving the speakers or subwoofers.

**MODE SELECTOR:** This feature tells the amplifier to run in either HIGH PASS, FULL RANGE or LOW PASS MODE

**2-WAY 12dB/Oct VARIABLE XOVER:** Control the corresponding channels cutoff frequencies. This feature is disabled when in FULL RANGE

RCA line through to cascade another amplifier. No Xover point.

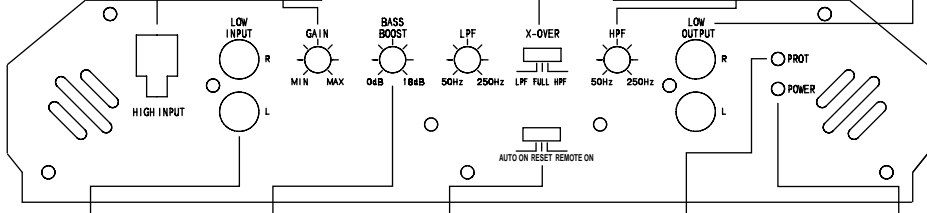

**LOW LEVEL INPUTS:** Low level inputs with a range of 0.2V to 5V RMS. This is where the front and rear RCA outputs from your head unit or other devices are inserted.

**BASS BOOST:** 0 - 18dB Bass Boost for use with subwoofers.

**AUTO SIGNAL SENSING:** Please refer to page 3 for explanation of this feature.

**PROTECTION (PROT) LED:** If LED comes on then you have an issue that requires service. Turn off the amplifier and call Earthquake for further assistance. See warranty for details.

**POWER LED:** When LED is on, it indicates that the amplifier is ON and functioning properly.

XOVER KNOB SETTING						
T1000W/2	50Hz	90Hz	125Hz	170Hz	210Hz	250Hz

WARNING	GAIN KNOB SETTING					
	MAX INPUT VOLTAGE BEFORE CLIPPING	MIN	9	12	3	MAX
	RCA LEVEL	7.0V	4.0V	2.5V	1V	200mV
	SPEAKER LEVEL	17.0V	10.0V	5.0V	1V	300mV

**WARNING**  
The gain knob is not a volume control. It is designed to match the input level of the amp to the output level of the source unit. Over driving "clipping" the input stage of the amp will cause damage to the amplifier (please refer to table for setting).

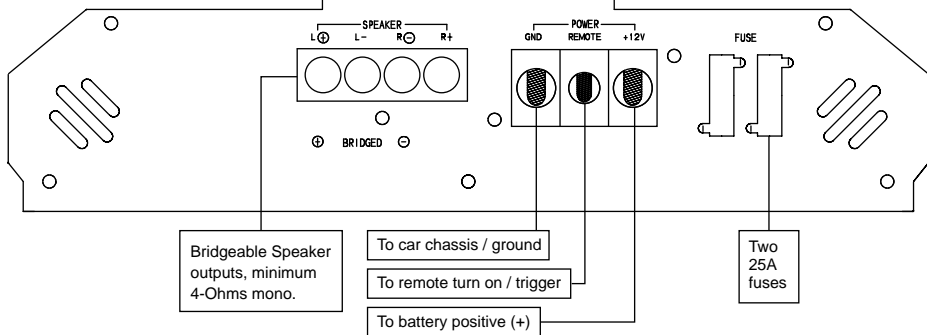

## FRONT STEREO IMAGES

Set Xover knob to MINIMUM and set Xover switch to high-pass.

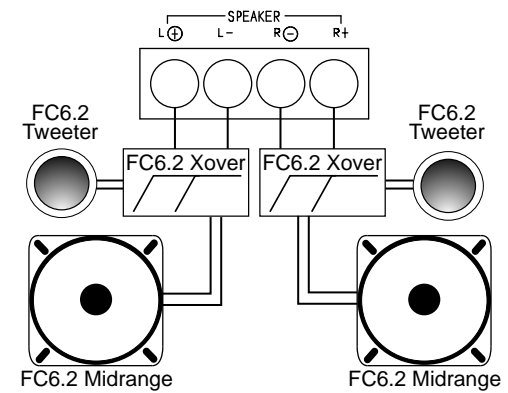
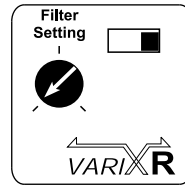

## REAR FILL STAGING

Set Xover switch to FULL

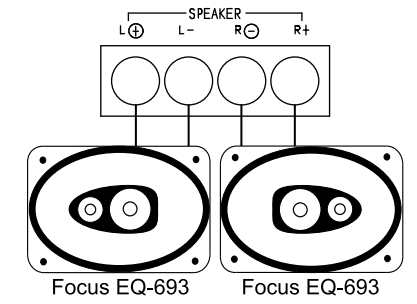
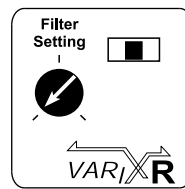

## BASS APPLICATIONS

Set Xover knob to 2 O'clock, & set Xover switch to low-pass.

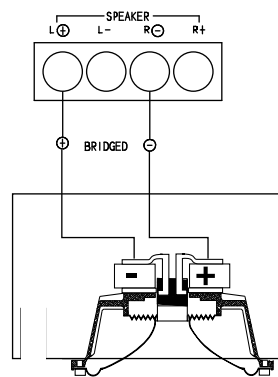
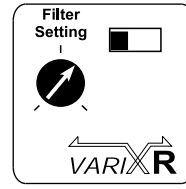

Bass reflex enclosure using 10", 12" or 15" subwoofers with single 4-ohm voice coils.

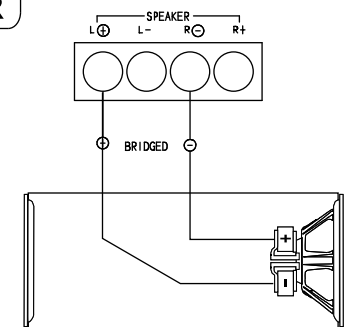

K-10, ten-inch bass tube, in mono application (4 Ohms minimum)

# T2000W/4

This information applies to both channels 1/2 and 3/4

**HIGH LEVEL INPUT:**  
Speaker level inputs with a range of 0.5V to 17V RMS.

**LEVEL ADJUST:**  
Allows the amplifier to deliver a controlled maximum sound level into selected channel(s) when the volume is turned to max. This acts as a volume limiter for the system, preventing you from over driving the speakers or subwoofers.

**MODE SELECTOR:**  
This feature tells the amplifier to run in either HIGH PASS, FULL RANGE or LOW PASS MODE

**2-WAY 12dB/Oct VARIABLE XOVER:**  
Control the corresponding channels cutoff frequencies. This feature is disabled when in FULL RANGE

**RCA line through to cascade another amplifier.**  
No Xover point.

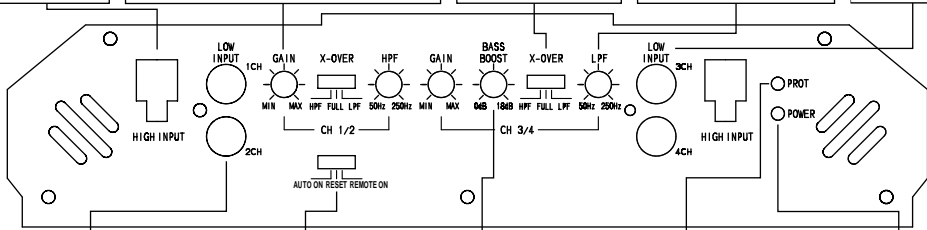

**LOW LEVEL INPUTS:**  
Low level inputs with a range of 0.2V to 7V RMS. This is where the front and rear RCA outputs from your head unit or other devices are inserted.

**AUTO SIGNAL SENSING:**  
Please refer to page 3 for explanation of this feature.

**BASS BOOST:**  
0 - 18dB Bass Boost for use with subwoofers.

**PROTECTION (PROT) LED:**  
If LED comes on then you have an issue that requires service. Turn off the amplifier and call Earthquake for further assistance. See warranty for details.

**POWER LED:**  
When LED is on, it indicates that the amplifier is ON and functioning properly.

XOVER KNOB SETTING	50Hz	90Hz	125Hz	170Hz	210Hz	250Hz
T2000W/4						

WARNING	GAIN KNOB SETTING					
	MAX INPUT VOLTAGE BEFORE CLIPPING	MIN	9	12	3	MAX
	RCA LEVEL	7.0V	4.0V	2.5V	1V	200mV
	SPEAKER LEVEL	17.0V	10.0V	5.0V	1V	300mV

The gain knob is not a volume control. It is designed to match the input level of the amp to the output level of the source unit. Over driving "clipping" the input stage of the amp will cause damage to the amplifier (please refer to table for setting).

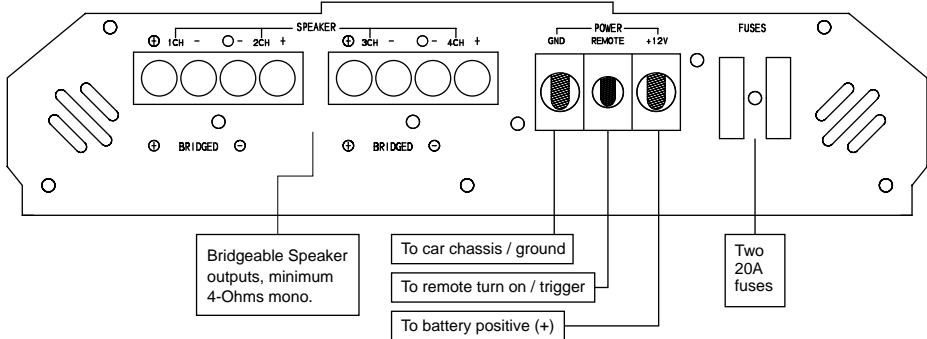

Bridgeable Speaker outputs, minimum 4-Ohms mono.

To car chassis / ground  
To remote turn on / trigger  
To battery positive (+)

Two 20A fuses

## FRONT STEREO IMAGES CHANNELS 1/2

Set Xover knob to MINIMUM and set Xover switch to high-pass.

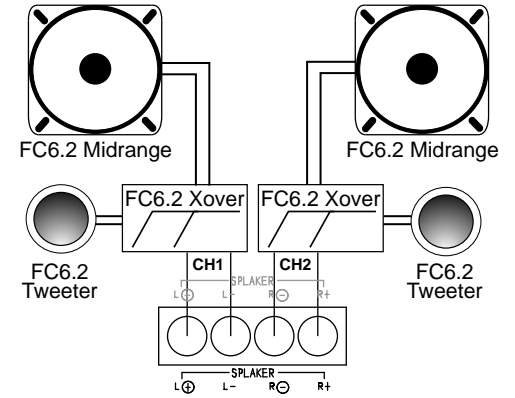
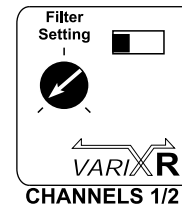

## REAR FILL STAGING CHANNELS 3/4

Set Xover switch to FULL

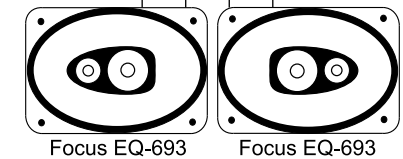
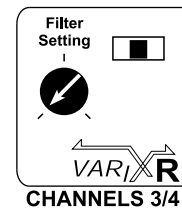

## FRONT STEREO IMAGES CHANNELS 1/2

Set Xover knob to MINIMUM and set Xover switch to high-pass.

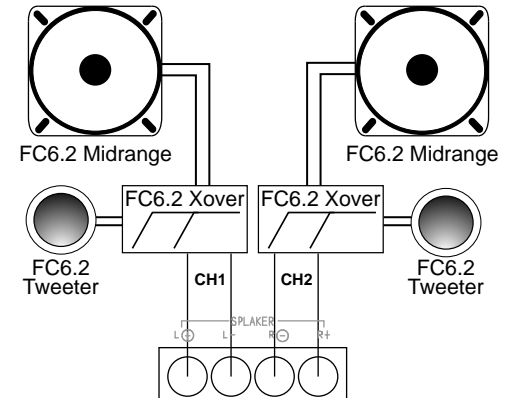
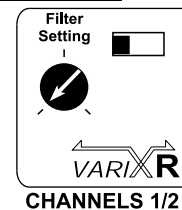

## BASS APPLICATIONS - CHANNELS 3/4 mono

Set Xover knob to 2 O'clock, & set Xover switch to low-pass.

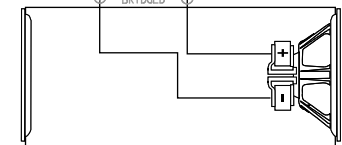
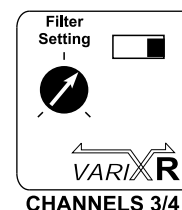

K-10, ten-inch bass tube, in mono application (4 Ohms minimum)

# T2000WD/1

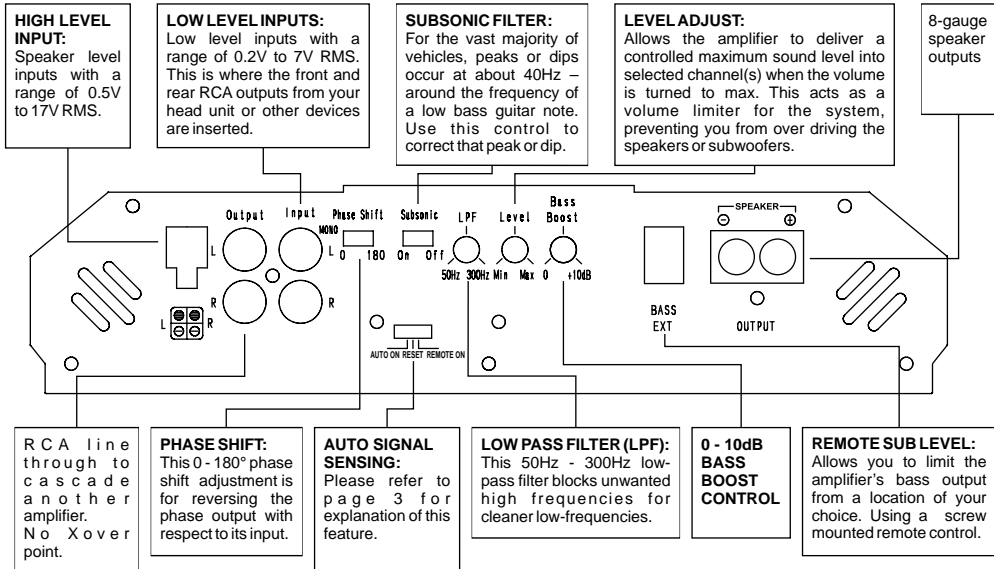

**VARX R**

SUB XOVER SETTING						
T2000WD/1	50Hz	70Hz	150Hz	210Hz	240Hz	300Hz

**WARNING**  
The gain knob is not a volume control. It is designed to match the input level of the amp to the output level of the source unit. Over driving "clipping" the input stage of the amp will cause damage to the amplifier (please refer to table for setting).

	GAIN KNOB SETTING				
MAX INPUT VOLTAGE BEFORE CLIPPING					
	MIN	9	12	3	MAX
RCA LEVEL	7.0V	4.0V	2.5V	1V	200mV
SPEAKER LEVEL	17.0V	10.0V	5.0V	1V	300mV

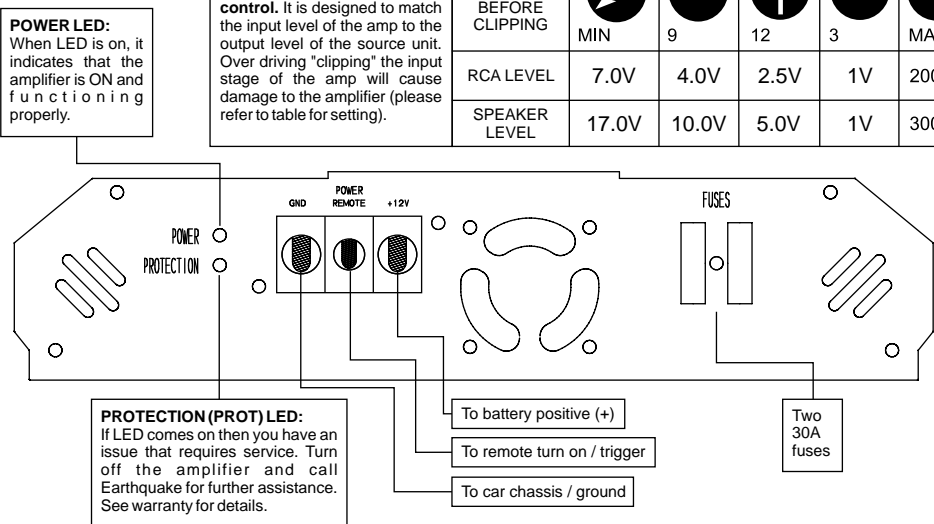

- \* Test the alternator output. Factory alternators will produce 60-80 amperes at best. Wear and heat will reduce the output by 40%.
- \* Alternator ground (-) must be reinforced, use 4-gauge cable instead of the factory 8-gauge.
- \* Alternator positive (+) to battery (+) must be reinforced. Use 4-gauge cables.
- \* Check your battery condition. Batteries degrade after a while.
- \* Battery (+) to amplifier (+) must be a 4-gauge cable.
- \* Ground amplifier to chassis using 4-gauge cable, keep the cable short (Maximum 2-feet).
- \* Use 1 farad capacitor to compensate for surges in demand.
- \* We recommend the use of one (1) auxiliary battery.

## Two Single 4-Ohm Subwoofers @ 2-Ohm

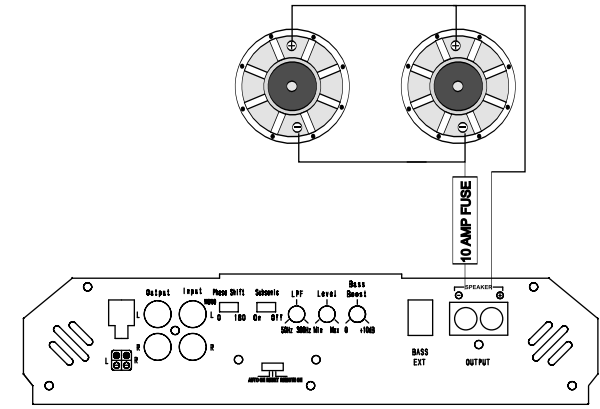

USE TWO 30-AMPERE FUSES TO PROTECT THE AMPLIFIER

## One Dual 4-Ohm Subwoofer @ 4-Ohm

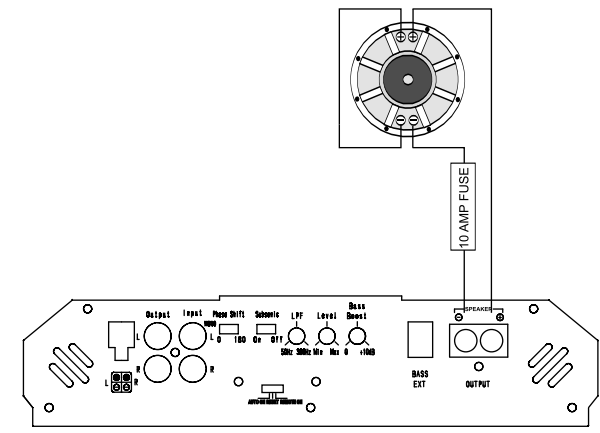

# TD5X

This information applies to both channels 1/2 and 3/4

**SUB INPUT:**  
This is your subwoofer channel where the sub RCA outputs from your head unit are inserted.

**SUB XOVER:**  
The 0-18dB/Oct Xover provides control over the device cutoff frequency.

**MODE SELECTOR:**  
This feature tells the amplifier to run in either HIGH PASS, FULL RANGE or LOW PASS MODE

**LEVEL ADJUST:**  
Control the max output of each channel. The LEVEL control sets its respective channel regardless of how many inputs in use.

**VARIABLE XOVER:**  
Control the corresponding channels' cutoff frequencies. This feature is disabled when in FULL RANGE.

**LOW INPUTS:**  
These are CH1/2(FRONT) & 3/4(REAR) low inputs with a range of 0.2V to 7V RMS. This is where the front and rear RCA outputs from your head unit are inserted.

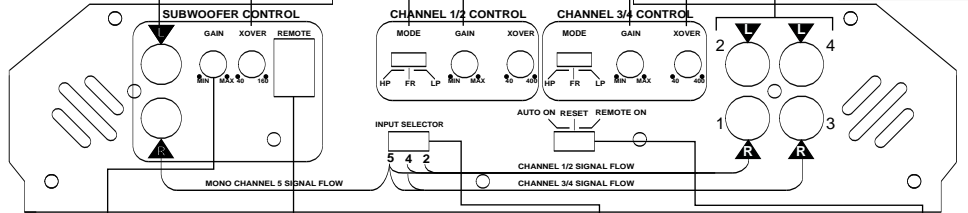

**LEVEL ADJUST:**  
Allows the amplifier to deliver a controlled maximum sound level into selected channel(s) when the volume is turned to max. This acts as a volume limiter for the system, preventing you from over driving the speakers or subwoofers.

**REMOTE SUB LEVEL:**  
Allows you to adjust amps bass output intensity remotely.

**INPUT SELECTOR:**  
This tells the amp to play all channels even if only one pair of RCAs is connected. EXAMPLE: If the head unit only has one pair of RCA outputs then you must plug them into the CH1/2 connections and set the switch to 2. This tells the amp that you are using one set of RCAs and it needs to play all five channels regardless. If you have four RCAs, then set it to 4 and so on.

**AUTO SIGNAL SENSING:**  
Please refer to page 3 for explanation of this feature.

VARIXR					
SUB XOVER SETTING					
TD5X	40Hz	100Hz	180Hz	280Hz	360Hz

### WARNING

The gain knob is not a volume control. It is designed to match the input level of the amp to the output level of the source unit. Over driving "clipping" the input stage of the amp will cause damage to the amplifier (please refer to table for setting).

GAIN KNOB SETTING					
MAX INPUT VOLTAGE BEFORE CLIPPING					
RCA LEVEL	7.0V	4.0V	2.5V	1V	200mV

**PROTECTION (PROT) LED:**  
If LED comes on then you have an issue that requires service. Turn off the amplifier and call Earthquake for further assistance. See warranty for details.

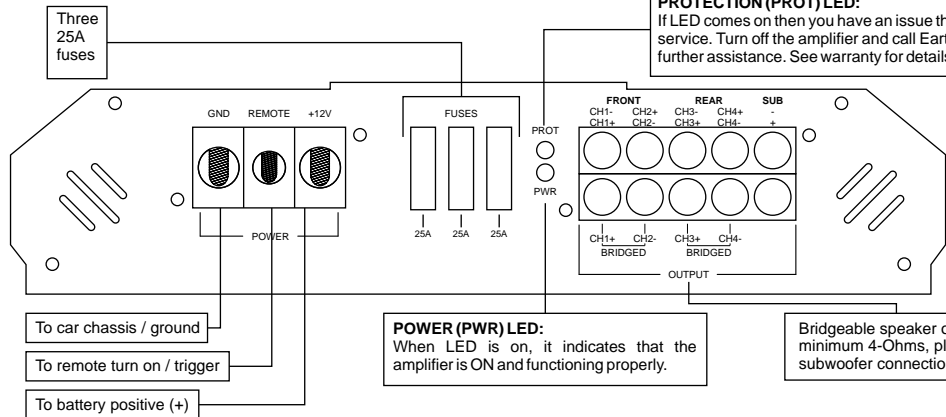

**POWER (PWR) LED:**  
When LED is on, it indicates that the amplifier is ON and functioning properly.

Bridgeable speaker outputs, minimum 4-Ohms, plus subwoofer connection.

### FRONT STEREO IMAGES CHANNELS 1/2

Set Xover to desired setting and set Mode switch to HIGH (high-pass). Level adjustment should be dialed in by ear. Keep it at MIN and slowly work your way up.

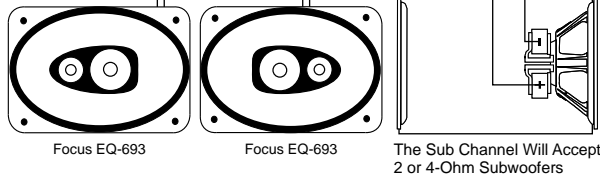
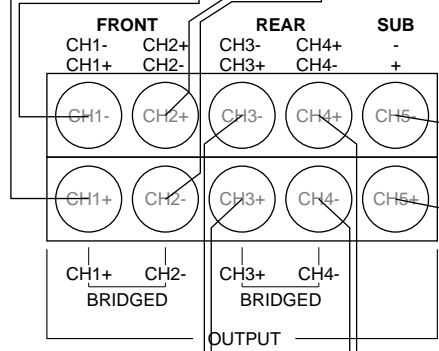
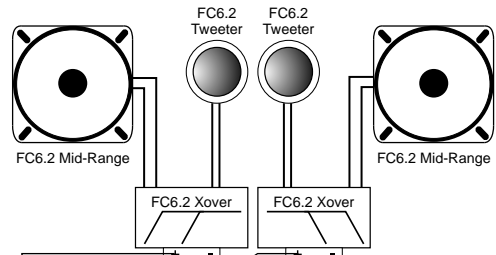
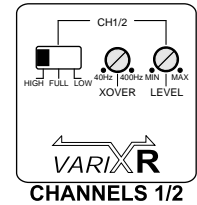

### REAR FILL STAGING CHANNELS 3/4

Set Xover switch to FULL (full range)

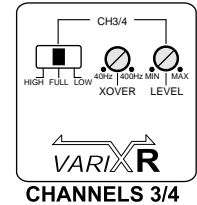



## Free Manuals Download Website

<http://myh66.com>

<http://usermanuals.us>

<http://www.somanuals.com>

<http://www.4manuals.cc>

<http://www.manual-lib.com>

<http://www.404manual.com>

<http://www.luxmanual.com>

<http://aubethermostatmanual.com>

Golf course search by state

<http://golfingnear.com>

Email search by domain

<http://emailbydomain.com>

Auto manuals search

<http://auto.somanuals.com>

TV manuals search

<http://tv.somanuals.com>