



**Intelligent Technologies**

**QCPort System Install Manual**

November 2005  
Supercedes November 2004

## Important Notice – Please Read

The product discussed in this literature is subject to terms and conditions outlined in appropriate Cutler-Hammer selling policies. The sole source governing the rights and remedies of any purchaser of this equipment is the relevant Cutler-Hammer selling policy.

**NO WARRANTIES, EXPRESS OR IMPLIED, INCLUDING WARRANTIES OF FITNESS FOR A PARTICULAR PURPOSE OR MERCHANTABILITY, OR WARRANTIES ARISING FROM COURSE OF DEALING OR USAGE OF TRADE, ARE MADE REGARDING THE INFORMATION, RECOMMENDATIONS AND DESCRIPTIONS CONTAINED HEREIN. In no event will Cutler-Hammer be responsible to the purchaser or user in contract, in tort (including negligence), strict liability or otherwise for any special, indirect, incidental or consequential damage or loss whatsoever, including but not limited to damage or loss of use of equipment, plant or power system, cost of capital, loss of power, additional expenses in the use of existing power facilities, or claims against the purchaser or user by its customers resulting from the use of the information, recommendations and descriptions contained herein.**

## Important User Information

Due to the variety of uses for the products described in this publication, those responsible for the application and use of this control equipment must satisfy themselves that all necessary steps have been taken to assure that each application and use meets all performance and safety requirements, including any applicable laws, regulations, codes, and standards.

Only qualified persons, as defined in the National Electric Code, who are familiar with the installation, maintenance, and operation of these products and the equipment onto which they are to be installed, as well as applicable local, state, and national regulations and industry standards and accepted practices regarding safety of personnel and the equipment safety, should be permitted to install, maintain, or operate this system. These instructions are provided only as a general guide to such qualified persons and are not all-inclusive. They do not cover every application or circumstance that may arise in the installation, maintenance, or operation of this equipment. Users are advised to comply with all local, state, and national regulations and industry standards and accepted practices regarding safety of personnel and equipment safety.

The illustrations, charts, sample programs and layout examples shown in this guide are intended solely for example. Since there are many variables and requirements associated with any particular installation, Cutler-Hammer does not assume responsibility or liability (including intellectual property liability) for actual use based upon the examples shown in this publication.

Reproduction of the contents of this copyrighted publication, in whole or in part, without written permission of Cutler-Hammer is prohibited.

Throughout this manual, various types of notices are provided to alert you to possible injury to people or damage to equipment under specific circumstances. These will help you:

- Identify a hazard
- Avoid the hazard
- Recognize the consequences

These include “Attention” and “Important” notices; please note the following examples.

|  |
|--|
|  <b>Warning</b>                                     |
| Identifies information about practices or circumstances that can lead to personal injury or death, property damage or economic loss. |

|  |
|--|
|  <b>Warning</b>                 |
| Identifies information that is especially important for successful application and understanding of the product. |

### National Electric Code

|  |
|--|
|  <b>Warning</b>   |
| Do not install or perform maintenance on the QCPort system while the system is energized. Death or severe personal injury, as well as damage to other equipment, can result from contact with energized equipment. Verify that no voltage is present before proceeding with installation or maintenance. |

Much of the information provided in this manual is representative of the capability of a QCPort system and its associated components. The National Electric Code (NEC), in the United States, and the Canadian Electric Code (CE Code), in Canada, places limitations on configurations and the maximum allowable power/current that can be provided.

The instructions and examples in this manual are based on Class 2 power supplies.

|  |
|--|
|  <b>Warning</b>   |
| Be sure that all national and local codes are thoroughly researched and adhered to during the planning and installation of your QCPort system. |

## Table of Contents

|   |           |
|---|-----------|
| <b>INTERCONNECTIVITY USING QCPORT.....</b>                                  | <b>6</b>  |
| INTRODUCING QCPORT .....  | 6         |
| QCPORT PHYSICAL CHARACTERISTICS .....                                       | 6         |
| EXAMPLES OF QCPORT USE.....   | 7         |
| One Device Using QCPort .....   | 7         |
| Multiple Peripherals on One Device Using QCPort .....                       | 8         |
| Multiple Devices Being Controlled And Monitored Remotely Using QCPort ..... | 9         |
| <b>QCPORT OPERATING MODES .....</b>   | <b>10</b> |
| Overview .....  | 10        |
| Understanding Master-Slave .....  | 10        |
| Understanding Peer .....  | 10        |
| <b>OVERVIEW OF QCPORT INTERCONNECT SYSTEM.....</b>                          | <b>11</b> |
| DEVICE CONNECTION IN A QCPORT SYSTEM .....                                  | 11        |
| QCPort Backplane .....  | 11        |
| QCPort Interconnect Cable .....   | 12        |
| DAISY CHAIN .....   | 14        |
| TRUNK DROP.....   | 14        |
| PHYSICAL PLACEMENT .....  | 15        |
| USING BIASING RESISTORS.....  | 16        |
| APPLICATION EXAMPLE .....   | 17        |
| <b>PLANNING A QCPORT INTERCONNECT SYSTEM.....</b>                           | <b>18</b> |
| GUIDELINES FOR SUPPLYING POWER.....   | 18        |
| <i>IT</i> . Power Supplies .....  | 18        |
| Other Power Supplies .....  | 18        |
| POWER RATINGS .....   | 18        |
| QCPort Interconnect Cable Rating .....                                      | 18        |
| LOCATING A POWER SUPPLY .....   | 19        |
| 1 Power Supply .....  | 20        |
| GROUNDING THE INTERCONNECT SYSTEM .....                                     | 20        |
| <b>SIZING A POWER SUPPLY .....</b>  | <b>21</b> |
| SUPPLYING POWER .....   | 21        |
| ADJUSTING THE CONFIGURATION.....  | 21        |
| SIZING CALCULATION .....  | 22        |
| USING THE SIZING CALCULATION.....   | 23        |
| Example 1 End Connected Power Supply .....                                  | 23        |
| Example 2 End Connected Power Supply .....                                  | 23        |
| Example 3 Middle Connected Power Supply .....                               | 24        |
| <b>TROUBLESHOOTING AND MAINTENANCE.....</b>                                 | <b>25</b> |
| <b>APPENDIX A: USING LONG RUN CABLES .....</b>                              | <b>26</b> |
| <b>TECHNICAL SUPPORT .....</b>  | <b>28</b> |

## Table of Figures

|  |    |
|--|----|
| Figure 1: Example of One Device Using QCPort                           | 7  |
| Figure 2: Example of Multiple Peripherals on One Device Using QCPort   | 8  |
| Figure 3: Example of Remote Connection Using QCPort                    | 9  |
| Figure 4: QCPort Backplane Connector                                   | 11 |
| Figure 5: 6 Pin QCPort Linear Connector                                | 11 |
| Figure 6: QCPort Interconnect Cable                                    | 12 |
| Figure 7: QCPort Powered Interconnect Cable Wiring                     | 12 |
| Figure 8: Long Run Cable Connection                                    | 13 |
| Figure 9: Daisy Chain Topology   | 14 |
| Figure 10: QCPort Biasing Resistor Options                             | 16 |
| Figure 11: Distributed Motor Control Panel                             | 17 |
| Figure 12: 1 Power Supply  | 20 |
| Figure 13: Example of Long Run Cable: One Power Supply (End-Connected) | 26 |

## **Interconnectivity Using QCPort**

### **Introducing QCPort**

The interface demands on control devices continues to increase at a rapid pace. An intelligent control device requires connection to configuration and monitoring tools, operator interfaces, and other peripheral devices, as well as the option to connect to a variety of industrial fieldbusses. At the same time, the intelligent devices continue to shrink in size and cost, forcing distribution of the field connections that once were native on the devices.

QCPort is a flexible interface port that integrates the many connectivity needs of the intelligent device into a single device port for the means of control, setup, and configuration. The integration of these capabilities provides interface options that are powerful and cost effective. In addition to the interface functionality of QCPort, care has been taken to insure that systems that connect via QCPort are simple to configure, connect, and maintain.

### **QCPort Physical Characteristics**

In an effort to use existing proven technology, QCPort uses the RS485 physical layer. This physical layer is common to many industrial communication interfaces and has a long and proven track record within industrial applications. QCPort is a four-wire system where there is an A and B for signal and a +DC and Ground for device power. Depending on the type of device interconnect and the distance between devices, there are many choices for the type of interconnect physical media; these choices will be discussed further in the manual.

## Examples of QCPort Use

### One Device Using QCPort

In many applications, the QCPort will be used as the connection between a motor controller and the user interface/configuration keypad. The following figure contains a one-to-one solution, where the user interface is powered from the motor controller's QCPort. A separate power supply is not required for the user interface. In this example, the user interface is connected to Channel 0 of the motor controller. Channel 0 is specifically used for connection to the user interface and operator stations.

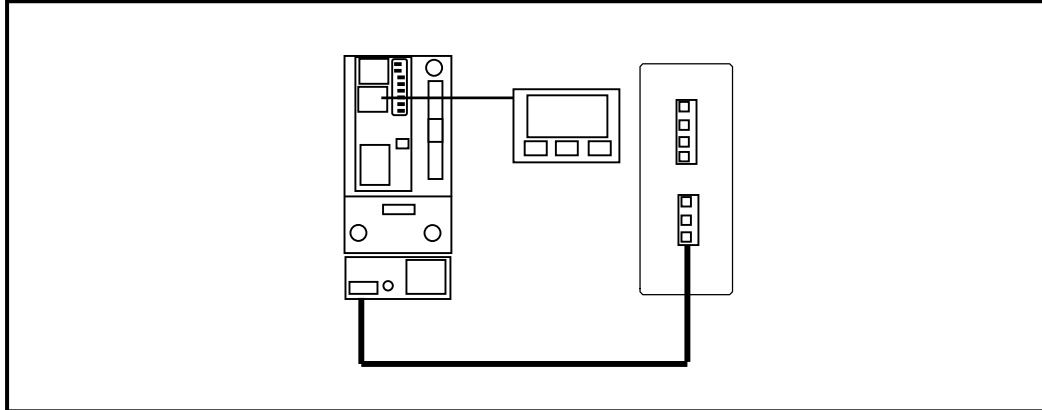

**Figure 1: Example of One Device Using QCPort**

The interconnect supplied with the operator interface connects the operator interface to the motor controller. This connection provides for 24V DC and communication; the operator interface is powered from the motor controller. Configuration of the operator interface or the motor controller for this application is not required for communication to be established. The user can then use the operator interface to configure the motor controller parameters, operate the motor controller, and monitor the operation of the motor controller.

The information contained within this manual does not include instructions for setup or operation of the motor controller or operator interface. For instructions on how to apply the operator interface, refer to the manual for that device.

### Multiple Peripherals on One Device Using QCPort

QCPort has been designed to support multiple devices connected to one motor controller, without the motor controller having prior knowledge of the connected device. Devices that can be connected to a motor controller include user interface products and IO products. Once again, the devices are connected to Channel 0 of the motor controller.

The figure below illustrates an application example that includes a user interface and IO modules. The input module is used to apply a hard-wired HOA while the output module is used to annunciate the motor controller status and trip conditions. The mapping of the data between the motor controller and the IO devices does not require a tool and is seamless to the user.

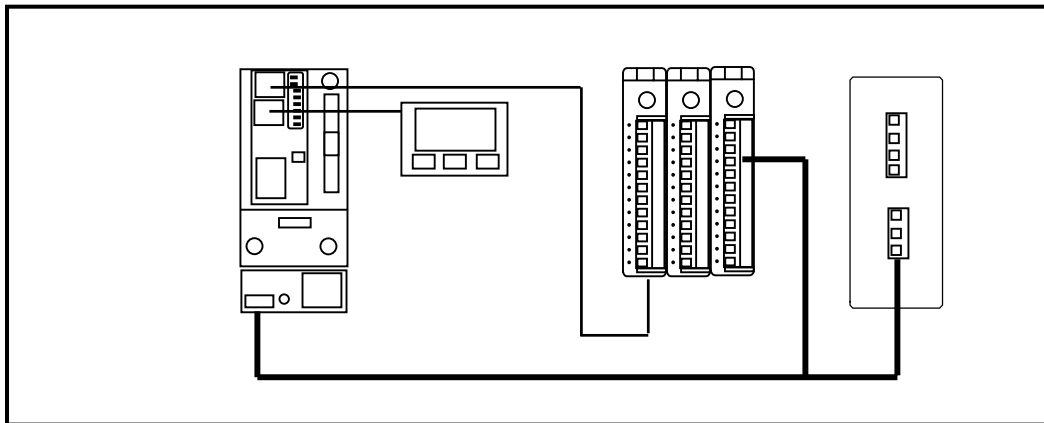

**Figure 2: Example of Multiple Peripherals on One Device Using QCPort**

When multiple devices are connected to one motor controller, the user has to be aware of the power demand of all of the peripherals. Verify the power requirement of this system by adding up the power demands of the peripherals to see if they exceed the power capacity of the motor controller. If the power capacity of the motor controller is exceeded, a power supply is required for QCPort. To help size the power supply, consult “Locating a Power Supply” later in the manual.



### Multiple Devices Being Controlled And Monitored Remotely Using QCPort

When an industrial fieldbus adapter is used within a system, the adapter will act as a subscanner presenting the QCPort devices as IO to the industrial fieldbus. This allows the QCPort devices to be monitored, controlled, and configured from a remote location. For this type of application, a power supply will be required; it can be the same power supply that is used for the motor controllers.

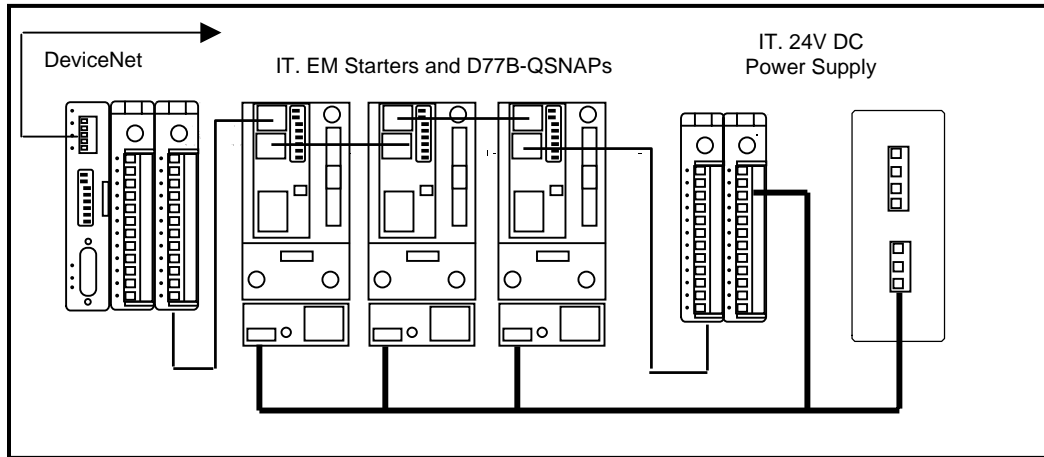

**Figure 3: Example of Remote Connection Using QCPort**

Since a power supply sizing is required, refer to “Locating a Power Supply” later in this manual. Along with the power supply sizing, physical media restrictions must be followed. This includes the length of the interconnects, type of interconnects, and the power capabilities for the interconnects.

This type of application requires some configuration. The Group IDs for the QCPort devices need to be set to unique IDs, the adapter requires an address configuration, and then the mapping feature needs to be invoked to map the QCPort data to the industrial fieldbus. None of these configuration requirements require a software tool. If advanced configuration of the QCPort devices is required, then a software tool or a QCPort user interface will be required. For information on configuration of the QCPort devices, refer to the user manual for those devices.

## QCPort Operating Modes

### Overview

The QCPort system is capable of two operating modes:

- Master-Slave
- Peer

When the system is intended to be used in a master-slave setting there is no configuration necessary other than setting the address (group ID) of each device to a unique address

Peer devices require a configuration setting for normal operation. Devices that will communicate peer are the S811 soft start and the user display (DIM).

### Understanding Master-Slave

Master-Slave is when a single device (master) is responsible for scheduling all communication to the remainder of the devices (slaves). In most cases, this will be limited to IO applications where a Network Adapter is controlling the IO and motor control devices. A slave only communicates when it is communicated to; thus eliminating collisions. Since there are no unscheduled communications in a Master-Slave system, the scan time of a QCPort system will be deterministic.

An example of a Master-Slave system can be found in Figure 3: Example of Remote Connection Using QCPort.

### Understanding Peer

Peer communication is when devices broadcast their messages on event transitions or a time base to a specific device or groups of devices. Unlike Master-Slave, this mode has no master scheduler in the system, and all devices produce data on an internal schedule or when an event occurs (e.g., input transition, fault). In this mode, there is collision detection to detect if a message is damaged by two devices talking at the same time. If this occurs, then the devices both stand off (at different stand off times) for a period of time and attempt to re-transmit the message.

An example of a Peer-to-Peer system can be found in Figure 2: Example of Multiple Peripherals on One Device Using QCPort.

## Overview of QCPort Interconnect System

### Device Connection in a QCPort System

Devices are connected into a QCPort system using one of the following connection types—either a backplane or interconnect cabling. Both of the connection types provide for communication and power.

The entire QCPort system, using QCPort pre-manufactured interconnects, cannot exceed 100 feet [30 meters] in total length. For systems that require longer runs, the long run interconnect is used. Using the long run interconnect, the system length is increased to 500 feet [150 meters] @ 460Kbaud and 1000 feet [300 meters] @ 230Kbaud. In this case, special care has to be taken to size the power supply correctly for the distance.

### QCPort Backplane

The QCPort backplane provides a convenient way to connect the Network Adapter and IO devices that are located in close proximity to one another. The QCPort backplane mounts within a DIN rail, allowing the receptacles on the back of the Network Adapter and IO products to plug into them. This auto connection eliminates the need for any customer communication or power wiring between devices, while providing hot insertion and removal without affecting other devices.

The QCPort backplane provides the data signals and the 24V DC to power all devices that are connected. The QCPort backplane is limited to a maximum current carrying capacity of 6 amps.

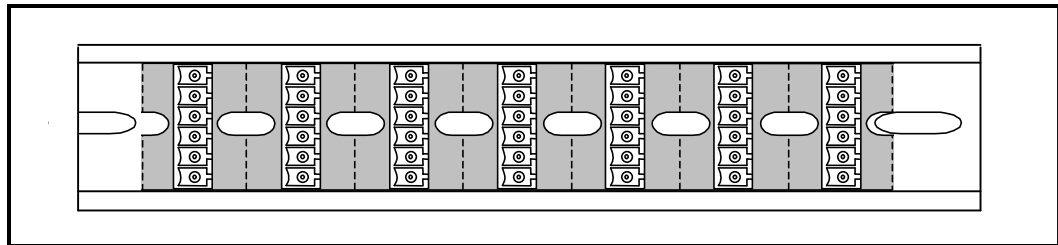

**Figure 4: QCPort Backplane Connector**

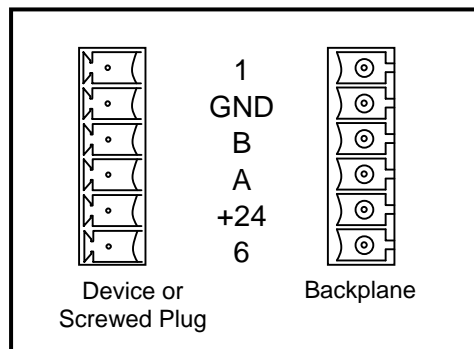
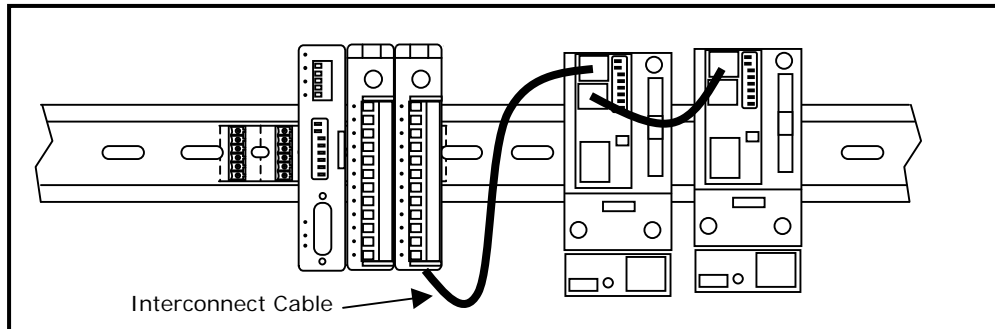

**Figure 5: 6 Pin QCPort Linear Connector**

### QCPort Interconnect Cable

QCPort Interconnect cable provides a convenient way to connect QCPort devices that are not mounted directly next to one another or where a Backplane could be used. The QCPort Interconnect cable is ordered from the factory at preconfigured standard lengths.

QCPort devices provide two QCPort interconnect cable plug connections that are in parallel, so that the devices can be daisy chained together. The QCPort Interconnect cable provides the data signals and 24V DC power. The QCPort powered interconnect Cable is limited to a maximum current carrying capacity of 1.0 amps.



**Figure 6: QCPort Interconnect Cable**

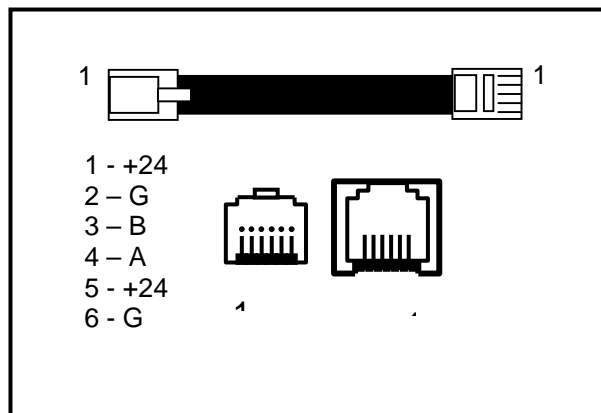

**Figure 7: QCPort Powered Interconnect Cable Wiring**

## Long Run Cable

In applications that require connections between devices that are greater than 10 feet [3 meters] apart, or greater current carrying capacity is needed than the interconnect cable supports, a “long run” cable should be used. This cable provides data and 24V DC power connections up to 1000 feet [300 meters].

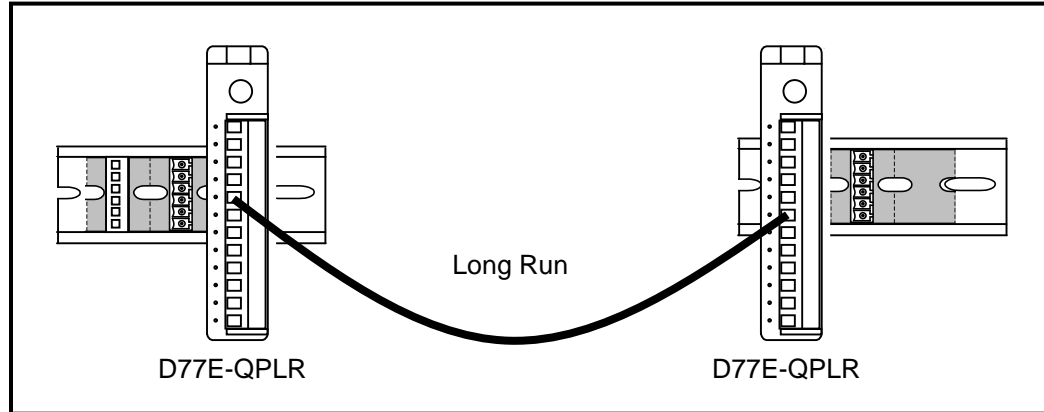

**Figure 8: Long Run Cable Connection**

## Long Run Cable Recommended Manufacturers

**Table 1: Manufacturers and Part Numbers for Long Run Cables**

| Manufacturer | Part Number             |
|--------------|-------------------------|
| Belden       | 82842 (Plenum Rated)    |
| Belden       | 9842 (Non-Plenum Rated) |
| Alpha        | 8807P (Plenum Rated)    |
| Alpha        | 6413 (Non-Plenum Rated) |

## Long Run Interconnect Cable Rating

The long run rating is 4A. Due to cable resistance, voltage drops may limit your application to less. Details are provided later in this chapter.

**Table 2: RJ Interconnect Maximum Current**

| Long Run Interconnect Cable | Allowable Current |
|-----------------------------|-------------------|
| 20 ft [6 meters]            | 4 A               |
| 60 ft [18 meters]           | 3.2 A             |
| 100 ft [30 meters]          | 2.5 A             |
| 500 ft [150 meters]         | 0.5 A             |
| 1000 ft [300 meters]        | 0.2 A             |

## Planning a QCPort Topology

QCPort is a RS485 based system and allows only two topologies; they are daisy chain and trunk drop. Connecting QCPort in a star is not allowed since it will produce unreliable communication.

### Daisy Chain

A daisy chain topology consists of a single wire that connects devices. This single wire enters and exits the device at one point (two connectors). Devices that can be connected in this topology have two QCPort connectors on them and/or a QCPort backplane connector. The two QCPort connectors are in parallel with each other so the connection is virtually one wire between devices.

When designing a system using daisy chain, there are two rules to be aware of. First, the complete QCPort system cannot be greater than 100 feet [30 meters], and second, the longest wire distance between devices, using the pre-manufactured QCPort Interconnect Cables, is 10 feet [3 meters]. When distances longer than 10 feet [3 meters] are required between devices, there are other methods that include using a long run cable and connectors.

Methods of connection include using QCPort Interconnect Cable, QCPort Backplane, Long Run, or any combination of the three. For more information on connection methods, see "Device Connection in a QCPort System on page 11.

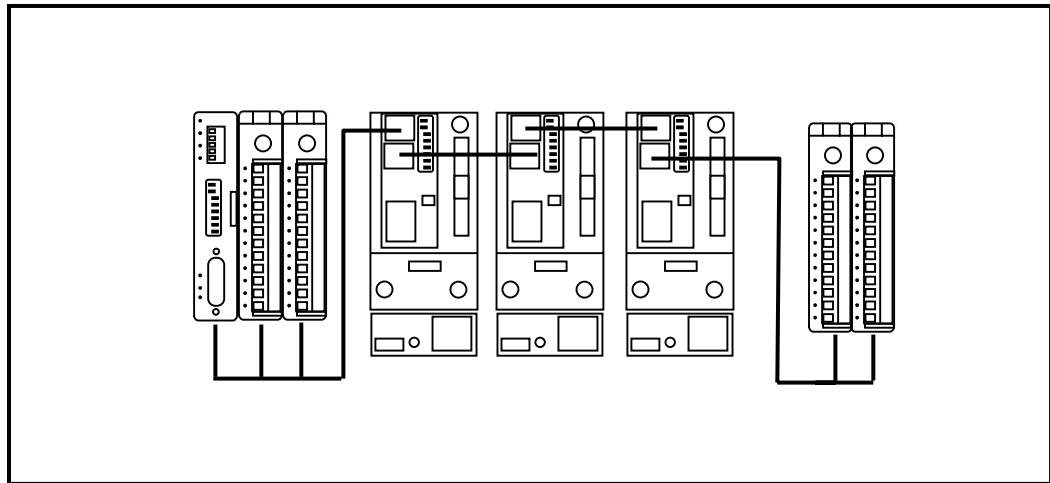

**Figure 9: Daisy Chain Topology**

### Trunk Drop

A trunk drop topology consists of a single wire, the trunk, with multiple drops coming off the trunk. The trunk can be the Backplane or long run cable where the drops are then connected to the trunk. When the trunk is a Backplane, the drops will connect using QCPort Interconnect cables from the devices on the Backplane. When the trunk is a long run cable, a D77E-QPLR (biasing resistor and power tap) is used to change the long run into either a Backplane or QCPort Interconnect cable connection. The biasing resistor portion of the D77E-QPLR is capable of being switched on or off. When used as a drop point in a long run cable application, the biasing resistor will most likely be switched off.

The rules to be aware of when designing a Trunk Drop system are that the maximum drop cannot exceed 1 foot [0.3 meter], and that the sum of the drops cannot exceed 20 feet [6 meters].

Methods of connection include using QCPort Interconnect Cable, QCPort Backplane, Long Run, or any combination of the three.

### **Physical Placement**

When planning the connection, care should be taken as to the physically placement of the devices. Considerations include:

- Grouping IO to utilize the Backplane.
- Grouping devices that only use the QCPort Interconnect cable.
- Changing media as little as possible.

For most applications, it will be possible to require only one change in media.

## Using Biasing Resistors

Depending on the type of QCPort system being implemented, biasing resistors may or may not be required. For Figure 1 and Figure 2 under the “Interconnectivity Using QCPort” section (One Device Using QCPort), a single biasing resistor is required when the total length of the system is less than 3 feet [1 meter].

When connecting a Network Adapter to IO and motor controllers, as in Figure 3 Multiple Devices Being Controlled And Monitored Remotely Using QCPort, biasing resistors are required on the end furthest from the network Adapter. A biasing resistor is not required on the one end that the Network Adapter is located since the Network Adapter has a biasing resistor integral.

When a biasing resistor is required, use part # D77E-TERRJ or D77E-QPLR. These biasing resistors connect between A and B and require 24V DC present on QCPort to be functional. The D77E-QPLR has three connections to QCPort. They are through the RJ connectors at the bottom, the Backplane connector on the back, and then through the front connector at the A and B terminals. The D77E-TERRJ has only one way to connect to QCPort, which is through the RJ connectors. There are two connectors that are in parallel with each other so it is not important which way the biasing resistor is orientated.

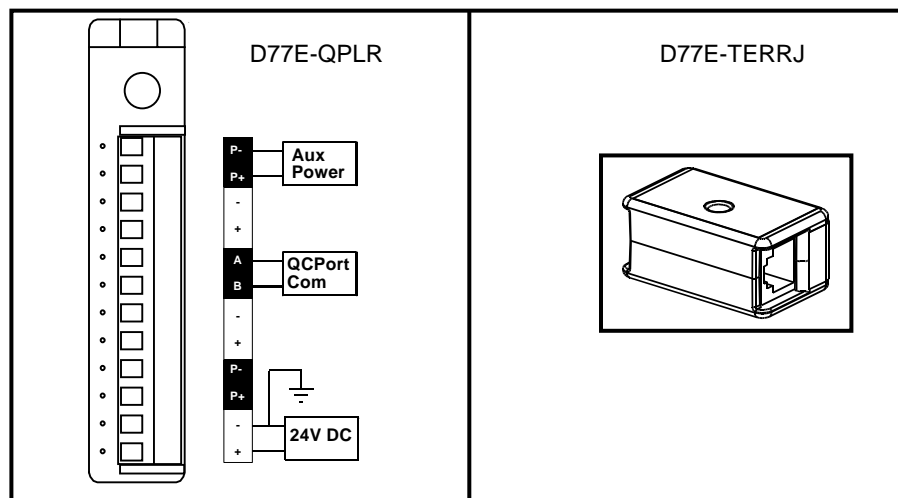

**Figure 10: QCPort Biasing Resistor Options**



## Application Example

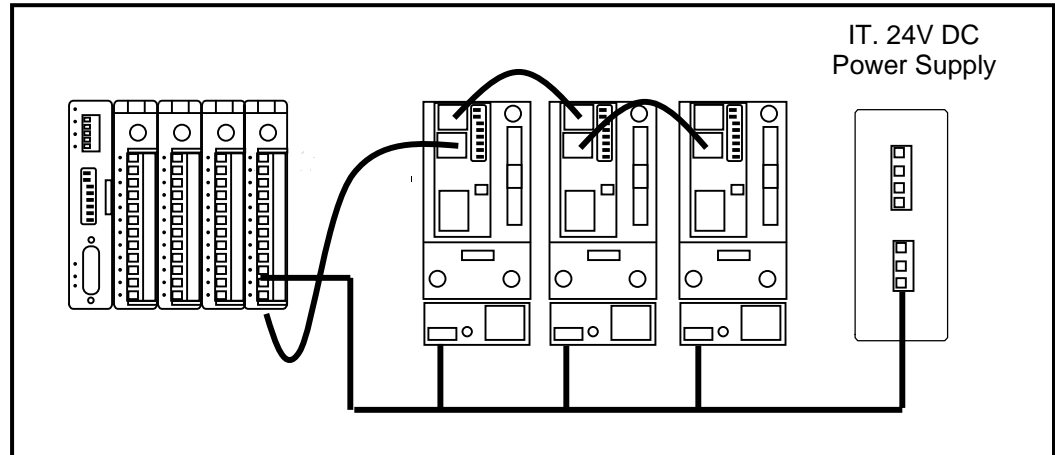

**Figure 11: Distributed Motor Control Panel**

In this Distributed Motor Panel application example, there are two types of interconnect media being used. The IO and Network Adapter use the Backplane Interconnect while the motor starters use the QCPort Interconnect cables. In this example, the QCPort power is supplied through the D77E-QPLR biasing resistor (last module), and the change from the backplane to the QCPort Interconnect cable is performed there as well.

When powering the QCPort system, the power supply that provides power to the starters is the same power supply that provides power to the QCPort system. It is important to size the power supply for the load of the starters and the QCPort load in this application. Another configuration would include an Automation power supply for the QCPort components only, and a separate power supply for the IT starters.

All the devices within this example can and will work as designed using one power supply. For reasons of isolation, a separate DeviceNet power supply would be required to power the DeviceNet products.

## Planning a QCPort Interconnect System

### Guidelines for Supplying Power

Use the following guidelines to protect your devices and achieve the best results when supplying power to the QCPort interconnect system.

#### *IT*. Power Supplies

The *IT*. family of products includes power supplies that meet the needs of the QCPort devices and motor control. The same power supply that is used for the *IT*. motor controller line is applicable to the QCPort system.

#### Other Power Supplies

When selecting a power supply from another vendor, use the following guidelines:

- Use power supplies rated at 24V
- Select a power supply that provides sufficient current for all attached nodes.  
**Note:** In the U.S. and Canada, be sure to adhere to NEC and CE Code limits respectively.
- Use a power supply that has its own current limit protection.
- Make sure you derate the supply for temperature using the manufacturer's guidelines.
- Provide fuse protection for each segment of the cable system; any section leading away from a power supply must have protection (can be part of the power tap).

### Power Ratings

The power capabilities of the QCPort interconnect system include:

- Power supplies rated at 24V DC.
- Long Run cables rated for 4 A steady state.
- Interconnect Cables rated for 1.0 A steady state.
- Backplane rated for 6 A steady state.

#### Notice

Check your national and local codes for additional information. In the United States and Canada, the QCPort cable system must be installed as a Class 2 circuit. This requires limiting the current to 4 A.

### QCPort Interconnect Cable Rating

The QCPort Interconnect rating is 1.0 A, but the allowable current depends on the length of the run. The maximum current decreases as the QCPort Interconnect cable length increases, as indicated in the table below.

**Table 3: RJ Interconnect Maximum Current**

| QCPort Interconnect Cable | Allowable Current |
|---------------------------|-------------------|
| 10 [25] inch [cm]         | 1.0 A             |
| 3 [1] feet [meter]        | 1.0 A             |
| 6 [2] feet [meter]        | 1.0 A             |
| 10 [3] feet [meter]       | 1.0 A             |

The voltage range between +24 and G must be between 18 and 28V DC.

### Locating a Power Supply

The QCPort interconnect system allows several options for supplying power, as outlined in this section. To determine which option meets your needs, consider the distribution of the loads, power supply location, and the number of power supplies used. Power supplies must be 24 volts.

#### Notice

In the United States and Canada, the power supply must also be Class 2.



#### Warning

Whenever two or more power supplies are connected to the same segment, the ground for the system must be referenced to only one point.

## 1 Power Supply

Locate the power supply at the end, middle, or anywhere along the cable, as illustrated in the following figure.

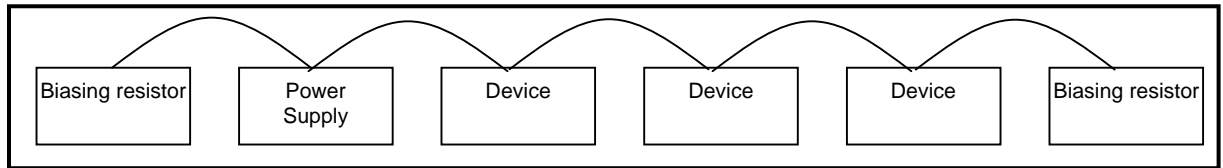

**Figure 12: 1 Power Supply**

## Grounding the Interconnect System

You must ground the QCPort system at only one location.



### **Warning**

If you use more than one power supply, all of them should be attached to the same earth ground.

Ground the G conductor at only one place at the power supply that is closest to the physical center of the QCPort system to maximize the performance and minimize the effect of outside noise.

To ground QCPort:

- Connect the G wire to earth ground using a 1 in (0.25 mm) copper braid or a #8 AWG wire up to 10 ft (3 m) maximum in length.
- Use the same wire to connect the power tap to earth ground.

## Sizing a Power Supply

It is important to verify that the power supply is properly sized for the load and the length of the QCPort system. To calculate if the placement and the size of the power supplies are adequate, refer to the examples in the Using the Sizing Calculation on page 23.

## Supplying Power

Follow these guidelines to protect your nodes and to achieve the best results when supplying power to the QCPort cable system.

- Use power supplies rated at 24V.
- Select a power supply that provides sufficient current for all attached nodes.
- Make sure you derate the power tap and the power supply for the expected temperature using the manufacturer's guidelines.
- Use a power supply that has its own current limit protection.

## Adjusting the Configuration

When the sections have a voltage drop less than 4.65V, your configuration will operate properly. Ideally, the voltage drops for each section should be within 10%. If one section has a substantially greater voltage drop than the other, you should attempt to balance the load of the cable system by moving the power supply or nodes. Some ways to make your system operational include the following:

- Shorten the overall length of the cable system.
- Move the power supply in the direction of the overloaded section.
- Move devices from the overloaded section to another section.
- Move higher current loads as close to the supply as possible.
- Add a second power supply to the cable system.
- Break the QCPort system into two separate networks to reduce the number of nodes on each.

### Sizing Calculation

A power supply that is not end connected creates two sections of cable. Because of this, each section needs to be evaluated separately. The equation sums the calculated drop for each device and compares it to 4.65V.

$$\text{SUM } \{[(L_n \times R_c) + (N_t \times (0.005))] \times I_n\} \leq 4.65V$$

| Term  | Definition  | Term    | Definition   |
|-------|---|---------|--|
| $L_n$ | L = The distance (ft) between the device and the power supply, excluding the drop line distance.<br>n = The number of the device being evaluated, starting with 1 for the device closest to the power supply and increasing by 1 for the next device.   | (0.005) | The nominal-contact resistance used for every connection to the trunk line.  |
| $R_c$ | Long Run<br>0.021 (ohm/ft)<br>QCPort Interconnect<br>0.105 (ohm/ft)   | 4.65V   | The maximum voltage drop allowed. This is the total cable system voltage drop of 5.00V minus 0.35V reserved for drop line voltage drop.  |
| $N_t$ | The number of taps between the device being evaluated and the power supply. For example: <ul style="list-style-type: none"> <li>When a device is the first one closest to the power supply, this number is 1.</li> <li>When a node has one device between it and the power supply, this number is 2.</li> <li>When 10 devices exist between the evaluated node and the power supply, this number is 11.</li> </ul> For a device attached as a drop from a device, the currents for the trunk and drop device should be summed and used with the equation only once. | $I_n$   | I = The current drawn from the cable system by the device. For currents within 90% of the maximum, use the nominal device current. Otherwise, use the maximum rated current of the device.<br>For a device attached as a drop from a device, the currents for the trunk and drop device should be summed and counted as one tap.<br>n = The number of devices being evaluated, starting with 1 for the device closest to the power supply and increasing by 1 for the next device. |

## Using the Sizing Calculation

The following examples use the sizing calculation to determine if the power supply is placed correctly in the system and if the power supply is large enough for the application.

### Example 1 End Connected Power Supply

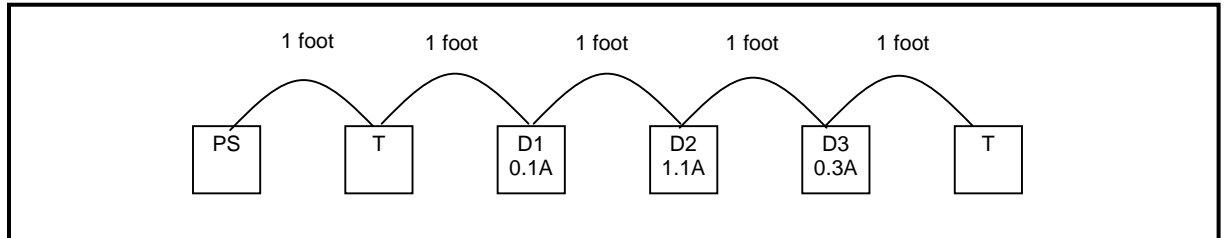

1. Sum up all the currents (QCPort Interconnect system)

$$= 0.1 + 1.1 + 0.3 = 1.5A \text{ (too much for Interconnect)}$$

The supply will have to be relocated.

### Example 2 End Connected Power Supply

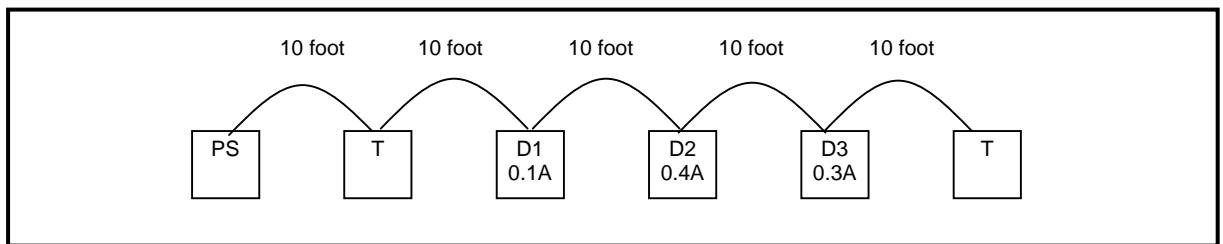

1. Sum up the currents (QCPort Interconnect system)

$$= 0.1 + 0.4 + 0.3 = 0.8 \text{ A (OK since 10 feet allows 1.0A)}$$

2. Find the voltages for each node using the equation for Long Run.

$$SUM \{ [(L_n \times (0.105)) + (N_t \times (0.005))] \times I_n \} \leq 4.65V$$

$$\text{Device 1 } [(20 \times (0.105)) + (1 \times (0.005))] \times 0.1 = 0.21V$$

$$\text{Device 2 } [(30 \times (0.105)) + (2 \times (0.005))] \times 0.4 = 1.26V$$

$$\text{Device 3 } [(40 \times (0.105)) + (3 \times (0.005))] \times 0.3 = 1.26V$$

3. Add each Devices voltage together to find the total voltage.

$$0.21 + 1.26 + 1.26 = 2.73V \text{ (OK)}$$

### Results

Since the total voltage does not exceed 4.65V, the system will operate properly.

**Example 3 Middle Connected Power Supply**

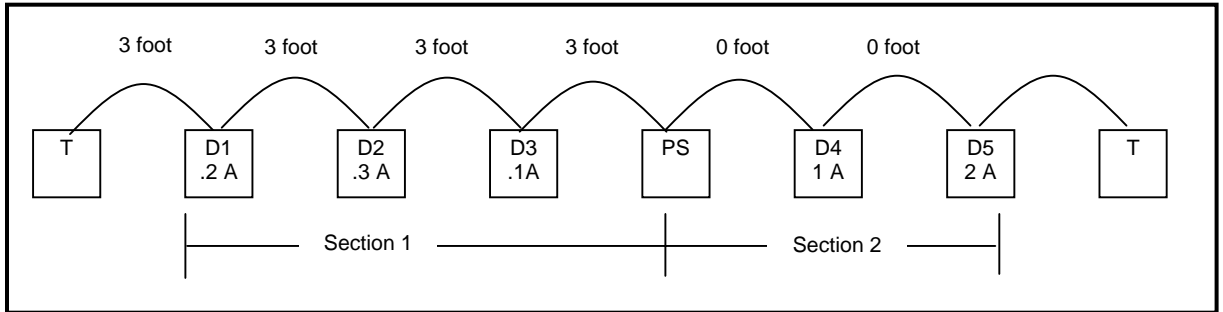

2. Sum up the currents per section

Section 1 (QCPort Interconnect) = 0.2 + 0.3 + 0.1 = 0.6 A (OK)

Section 2 (Backplane) = 1.0 + 2.0 = 3.0 A (OK)

Find the voltages for each device using the equation for Long Run.

$$SUM \{ [(L_n \times (0.105)) + (N_t \times (0.005))] \times I_n \} \leq 4.65V$$

**Device 1**  $[(9 \times (0.105)) + (3 \times (0.005))] \times 0.2 = 0.19V$

**Device 2**  $[(6 \times (0.105)) + (2 \times (0.005))] \times 0.3 = 0.19V$

**Device 3**  $[(3 \times (0.105)) + (1 \times (0.005))] \times 0.1 = 0.03V$

**Device 4**  $[(0 \times (0.105)) + (1 \times (0.005))] \times 1.0 = 0.00V$

**Device 5**  $[(0 \times (0.105)) + (2 \times (0.005))] \times 2.0 = 0.02V$

Add each Devices voltage together to find the total voltage per section.

Section 1 – 0.19+0.19+0.03 = **0.41V** (OK)

Section 2 – 0.00+0.02 = **0.02V** (OK)

**Results**

Since the total voltage does not exceed 4.65V in either section, the system will operate properly.



## Troubleshooting and Maintenance

Refer to the selected device manuals for more detailed hints on troubleshooting.

## Appendix A: Using Long Run Cables

When devices require locating further than 100 feet [30 meters] from one another, the physical media changes from QCPort Interconnects to Long Run cables. This cable is better rated for current carrying capacity and for the RS485 communication.

When connecting between Long Run and a QCPort device, the D77E-QPLR is required to change the physical media. The D77E-QPLR provides for screw lugs for connection to industrial RS485 cable.

### Example of Long Run Cable: One Power Supply (End-Connected)

The following example uses the full calculation method to determine the configuration for one end-connected power supply on a thick cable trunk line.

- Device 1 and Device 2 cause the same voltage drop, but Device 2 is twice as far from the power supply and draws half as much current.
- Device 4 draws the least amount of current, but it is farthest from the power supply and causes the greatest incremental voltage drop.

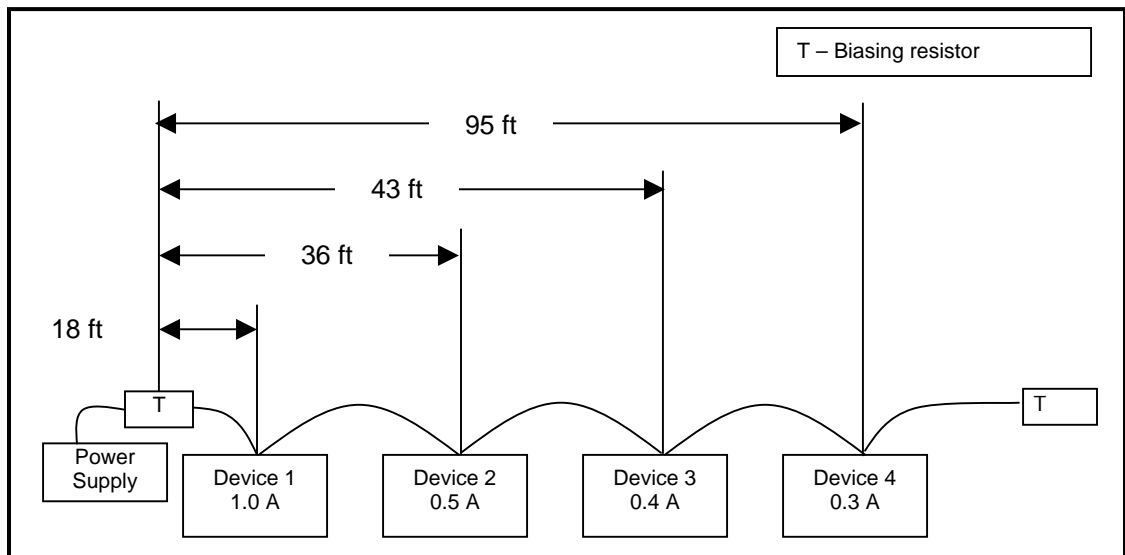

Figure 13: Example of Long Run Cable: One Power Supply (End-Connected)

1. Find the voltages for each node using the equation for Long Run.

$$SUM \{[(L n \times (0.0045)) + (N t \times (0.005))] \times I n\} \leq 4.65V$$

$$\text{Device 1 } [(18 \times (0.021)) + (1 \times (0.005))] \times 1.0 = \mathbf{0.383V}$$

$$\text{Device 2 } [(36 \times (0.021)) + (2 \times (0.005))] \times 0.5 = \mathbf{0.383V}$$

$$\text{Device 3 } [(43 \times (0.021)) + (3 \times (0.005))] \times 0.4 = \mathbf{0.367V}$$

$$\text{Device 4 } [(95 \times (0.021)) + (4 \times (0.005))] \times 0.3 = \mathbf{0.604V}$$

2. Add each Devices voltage together to find the total voltage.

$$0.383V + 0.383V + 0.367V + 0.604V = \mathbf{1.737V}$$

### Results

Since the total voltage does not exceed 4.65V, the system will operate properly.

## Technical Support

**For additional information on this product,  
Please call our Customer Support Center at:**

**1-800-356-1243**

**For service or start-up assistance  
24 hours/day, 7 days/week,  
please call:**

**1-800-498-2678**

## Company Information

Eaton Electrical Inc. is a global leader in electrical control, power distribution and industrial automation products and services. Thorough advanced product development, world-class manufacturing methods, and global engineering services and support, Eaton Electrical® provides customer-driven solutions under band names such as Cutler-Hammer®, Durant®, Heinemann®, Holec® and MEM®, which globally serve the changing needs of the industrial, utility, light commercial, residential and OEM markets. For more information visit [www.eatonelectrical.com](http://www.eatonelectrical.com).

Eaton Corporation is a global diversified industrial manufacturer with 2003 sales of \$8.1 billion that is a leader in fluid power systems, electrical power quality, distribution, and control; automotive engine air management and fuel economy; and intelligent drivetrain systems for fuel economy and safety in trucks. Eaton has 51,000 employees and sell products in more than 50 controls. For more information visit [www.eaton.com](http://www.eaton.com).

Eaton Electrical  
1000 Cherrington Parkway  
Moon Township, PA 15108-4312  
USA  
Tel: 1-800-525-2000  
[www.eatonelectrical.com](http://www.eatonelectrical.com)

©2004 Eaton Corporation  
All Rights Reserved  
Printed in USA  
Publication No MN05001002E  
November 2005



## Free Manuals Download Website

<http://myh66.com>

<http://usermanuals.us>

<http://www.somanuals.com>

<http://www.4manuals.cc>

<http://www.manual-lib.com>

<http://www.404manual.com>

<http://www.luxmanual.com>

<http://aubethermostatmanual.com>

Golf course search by state

<http://golfingnear.com>

Email search by domain

<http://emailbydomain.com>

Auto manuals search

<http://auto.somanuals.com>

TV manuals search

<http://tv.somanuals.com>