



Powerware

**Powerware® 9315 UPS
200–300 kVA
Operation Manual**

IMPORTANT SAFETY INSTRUCTIONS SAVE THESE INSTRUCTIONS

This manual contains important instructions that you should follow during installation and maintenance of the UPS and batteries. Please read all instructions before operating the equipment and save this manual for future reference.

Consignes de sécurité

**CONSIGNES DE SÉCURITÉ IMPORTANTES
CONSERVER CES INSTRUCTIONS
CE MANUEL CONTIENT DES CONSIGNES DE SÉCURITÉ IMPORTANTES**

Class A EMC Statements

FCC Part 15

NOTE This equipment has been tested and found to comply with the limits for a Class A digital device, pursuant to part 15 of the FCC Rules. These limits are designed to provide reasonable protection against harmful interference when the equipment is operated in a commercial environment. This equipment generates, uses, and can radiate radio frequency energy and, if not installed and used in accordance with the instruction manual, may cause harmful interference to radio communications. Operation of this equipment in a residential area is likely to cause harmful interference in which case the user will be required to correct the interference at his own expense.

WARNING



This is a product for restricted sales distribution to informed partners. Installation restrictions or additional measures may be needed to prevent disturbances.

Powerware and X-Slot are registered trademarks and ConnectUPS is a trademark of Eaton Electrical Inc. Modbus is a registered trademark of Modicon.

©Copyright 2004-2006 Eaton Corporation, Raleigh, NC, USA. All rights reserved. No part of this document may be reproduced in any way without the express written approval of Eaton Corporation.

Table of Contents

| | | |
|----------|--|------------|
| 1 | Introduction | 1-1 |
| 1.1 | Conventions Used in This Manual | 1-1 |
| 1.2 | For More Information | 1-2 |
| 1.3 | Getting Help | 1-2 |
| 2 | Getting Started | 2-1 |
| 2.1 | Safety Warnings | 2-1 |
| 2.2 | Typical Powerware 9315 UPS System | 2-2 |
| 2.3 | Looking Inside the UPS | 2-3 |
| 2.4 | UPS Standard Features | 2-4 |
| 2.4.1 | Monitor Panel | 2-4 |
| 2.4.2 | Control Panel | 2-4 |
| 2.4.3 | Communication Bays | 2-4 |
| 2.4.4 | Input Filter | 2-4 |
| 2.4.5 | Emergency Load Off | 2-5 |
| 2.4.6 | Automatic Battery Charge Current Limit | 2-5 |
| 2.4.7 | Installation Features | 2-5 |
| 2.5 | Options and Accessories | 2-5 |
| 2.5.1 | Battery | 2-5 |
| 2.5.2 | External Battery Disconnect | 2-5 |
| 2.5.3 | Power Distribution Module (LV models only) | 2-6 |
| 2.5.4 | Upgrade Capability | 2-6 |
| 2.5.5 | Remote Monitor Panel | 2-6 |
| 2.5.6 | Relay Interface Module | 2-6 |
| 2.5.7 | Input Isolation Transformer | 2-6 |
| 2.5.8 | 5% Input Filter | 2-6 |
| 2.5.9 | Output Transformer | 2-7 |
| 2.5.10 | Modem | 2-7 |
| 2.5.11 | Customer Convenience Outlet | 2-7 |
| 2.6 | Symbols, Controls, and Indicators | 2-8 |
| 3 | Understanding UPS Operation | 3-1 |
| 3.1 | Normal Mode | 3-1 |
| 3.2 | Bypass Mode | 3-3 |
| 3.3 | Battery Mode | 3-4 |
| 3.4 | Monitoring and Controlling UPS Operation | 3-5 |

| | | |
|----------|--|------------|
| 4 | Starting and Stopping the UPS | 4-1 |
| 4.1 | Using the Control Panel | 4-1 |
| 4.1.1 | To Place the UPS in Normal Mode | 4-2 |
| 4.1.2 | To Shut Down the UPS from Normal Mode | 4-3 |
| 4.1.3 | To Start the UPS in Bypass Mode | 4-3 |
| 4.1.4 | To Shut Down Power to the Critical Load While in Bypass Mode | 4-3 |
| 5 | Using the Monitor Panel | 5-1 |
| 5.1 | Using the LCD Screen | 5-2 |
| 5.2 | Using the Buttons | 5-3 |
| 5.3 | Adjusting the Contrast | 5-3 |
| 5.4 | Using the Load Off Button | 5-3 |
| 5.5 | Reading the Status Indicators | 5-4 |
| 5.6 | Using the Menu Options | 5-4 |
| 6 | Using Features and Options | 6-1 |
| 6.1 | Building Alarm Monitoring | 6-1 |
| 6.2 | Summary Alarm Contacts | 6-2 |
| 6.3 | Remote Monitor Panel | 6-3 |
| 6.4 | Battery Cabinets | 6-5 |
| 6.5 | External Battery Disconnect | 6-5 |
| 6.6 | Relay Interface Module | 6-6 |
| 6.7 | Supervisory Contact Module | 6-7 |
| 7 | Communication | 7-1 |
| 7.1 | Locating the Communication Bays | 7-1 |
| 7.2 | X-Slot Cards | 7-2 |
| 7.3 | LanSafe Power Management Software | 7-3 |
| 7.4 | Connecting Equipment to a Serial Port | 7-3 |
| 7.5 | Configuring the Serial Ports | 7-6 |
| 7.5.1 | Mode | 7-7 |
| 7.5.2 | Rate | 7-7 |
| 7.5.3 | Data/Stop | 7-8 |
| 7.5.4 | Handshaking | 7-8 |
| 7.5.4.1 | Disabled (No Handshaking) | 7-8 |
| 7.5.4.2 | XON/XOFF | 7-8 |
| 7.5.5 | Save | 7-8 |
| 7.5.6 | Default Settings | 7-8 |

| | | |
|-----------|--|-------------|
| 7.6 | Terminal Mode | 7-9 |
| 7.6.1 | Printing Selected Information | 7-9 |
| 7.6.2 | Entire Log – [Ctrl]+[P] | 7-10 |
| 7.6.3 | Meters Printout – [Ctrl]+[M] | 7-11 |
| 7.6.4 | System Information Printout – [Ctrl]+[A] | 7-12 |
| 7.6.5 | Battery Test Printout – [Ctrl]+[B] | 7-12 |
| 7.7 | System Configuration | 7-13 |
| 7.7.1 | System Configuration Mode Main Menu | 7-13 |
| 7.7.2 | Program Building Alarms | 7-13 |
| 7.7.3 | Enable/Disable Default Functions | 7-14 |
| 7.7.4 | Customize Alarm Messages | 7-15 |
| 7.7.5 | Program Unit Name | 7-16 |
| 7.7.6 | Adjust Output Voltage | 7-16 |
| 7.7.7 | Change Password | 7-16 |
| 7.7.8 | Battery Test Setup | 7-17 |
| 7.7.9 | Modify Low Battery Time | 7-18 |
| 7.8 | Calibration Mode | 7-18 |
| 7.9 | Computer Mode | 7-18 |
| 7.10 | Remote Monitor Mode | 7-18 |
| 7.11 | Remote Notification | 7-19 |
| 8 | Maintaining the UPS System | 8-1 |
| 8.1 | Important Safety Instructions | 8-1 |
| 8.2 | Performing Preventive Maintenance | 8-2 |
| 8.3 | Maintenance Training | 8-3 |
| 9 | Product Specifications | 9-1 |
| 10 | Responding to System Events | 10-1 |
| 10.1 | System Event Horns | 10-1 |
| 10.2 | System Event Lights | 10-1 |
| 10.3 | System Event Messages | 10-1 |
| 11 | Using the LOAD OFF Button | 11-1 |
| 11.1 | Using the LOAD OFF Button | 11-1 |
| 11.2 | Resetting the UPS System after Load Off | 11-2 |
| | Warranty | W-1 |

List of Figures

| | |
|---|------|
| Figure 2-1. Typical Powerware 9315 UPS System | 2-2 |
| Figure 2-2. Main Elements of the UPS System | 2-3 |
| Figure 3-1. Path of Current Through the UPS in Normal Mode | 3-2 |
| Figure 3-2. Path of Current Through the UPS in Bypass Mode | 3-3 |
| Figure 3-3. Path of Current Through the UPS in Battery Mode | 3-4 |
| Figure 3-4. Location of the Monitor Panel and the Control Panel | 3-5 |
| Figure 4-1. UPS Control Panel | 4-1 |
| Figure 5-1. UPS Monitor Panel | 5-1 |
| Figure 5-2. Parts of the LCD Screen (Typical for Powerware 9315 300 480/480V UPS) | 5-2 |
| Figure 5-3. System Meters Screen (Typical for Powerware 9315 300 480/480V UPS) | 5-5 |
| Figure 5-4. Load Amps Meters Screen | 5-6 |
| Figure 5-5. Event History Log Screen | 5-7 |
| Figure 5-6. Active System Events Screen | 5-8 |
| Figure 5-7. Unit Statistics Screen | 5-9 |
| Figure 5-8. Mimic Screen | 5-10 |
| Figure 5-9. Time Setup Screen | 5-11 |
| Figure 5-10. Setup Serial Port 1 Screen | 5-12 |
| Figure 6-1. External Connections for Building Alarm Monitoring | 6-1 |
| Figure 6-2. Summary Alarm Contacts | 6-2 |
| Figure 6-3. Remote Monitor Panel | 6-3 |
| Figure 6-4. Relay Interface Module | 6-6 |
| Figure 6-5. Supervisory Contact Module | 6-7 |
| Figure 7-1. Location of Communication Bays on the UPS (Powerware 9315 300) | 7-2 |
| Figure 7-2. Optional X-Slot Cards | 7-3 |
| Figure 7-3. Port 1 (DB-9) Pin Assignments | 7-4 |
| Figure 7-4. Port 2 (DB-25) Pin Assignments | 7-4 |
| Figure 7-5. Setup Serial Port 1 Screen | 7-6 |
| Figure 7-6. Event History Log | 7-10 |
| Figure 7-7. System Meters | 7-11 |
| Figure 7-8. Battery Test Log | 7-12 |

Chapter 1 | Introduction

The Powerware® 9315 uninterruptible power supply (UPS) online power protection prevents loss of valuable electronic information, minimizes equipment downtime, and/or minimizes the adverse effect on equipment production due to unexpected power problems.

The Powerware 9315 UPS continually monitors incoming electrical power and removes the surges, spikes, sags, and other irregularities that are inherent in commercial utility power. Working with your building's electrical system, the UPS supplies clean, consistent power that your sensitive electronic equipment requires for reliable operation. During brownouts, blackouts, and other power interruptions, one or more optional battery cabinets can provide emergency power to safeguard your operation.

The UPS functions automatically and require very little attention during normal operation. However, you should read and understand the procedures described in this manual to ensure trouble-free operation. In particular, you should be thoroughly familiar with the Load Off procedure described in Chapter 11, "Using the LOAD OFF Button."

1.1 Conventions Used in This Manual

This manual uses these type conventions:

- ▶ **Bold type** highlights important concepts in discussions, key terms in procedures, and menu options, or represents a command or option that you type or enter at a prompt.
- ▶ *Italic type* highlights notes and new terms where they are defined.
- ▶ `Screen type` represents information that appears on the screen or LCD.

| Icon | Description |
|---|--|
|  | Information notes call attention to important features or instructions. |
| [Keys] | Brackets are used when referring to a specific key, such as [Enter] or [Ctrl]. |

In this manual, the term *UPS* refers only to the UPS cabinet and its internal elements. The term *UPS system* refers to the entire power protection system – the UPS cabinet, battery strings, and options or accessories installed.

1.2 For More Information

Refer to the **Powerware 9315 UPS (200–300 kVA) Installation Manual** for the following additional information:

- ▶ How to prepare your site and plan for installation
- ▶ Detailed step-by-step procedures for installing each component of your system
- ▶ Detailed illustrations of cabinets and optional accessories, including dimensions and connection points

Visit www.powerware.com or contact your Eaton service representative for information on how to obtain copies of this manual.

1.3 Getting Help

If help is needed with any of the following:

- ▶ Scheduling initial startup
- ▶ Regional locations and telephone numbers
- ▶ A question about any of the information in this manual
- ▶ A question this manual does not answer

Please call the Eaton Help Desk for Powerware products at:

| | |
|----------------------|---|
| In the United States | 1-800-843-9433 or 1-919-870-3028 |
| In Canada | 1-800-461-9166 |
| All other countries | Call your service representative |

Chapter 2 | Getting Started

2.1 Safety Warnings

IMPORTANT SAFETY INSTRUCTIONS SAVE THESE INSTRUCTIONS

This manual contains important instructions that you should follow during installation and maintenance of the UPS and batteries. Please read all instructions before operating the equipment and save this manual for future reference.

DANGER



This UPS contains **LETHAL VOLTAGES**. All repairs and service should be performed by **AUTHORIZED SERVICE PERSONNEL ONLY**. There are **NO USER SERVICEABLE PARTS** inside the UPS.

WARNING



- ▶ This UPS contains its own energy source (batteries). The output receptacles may carry live voltage even when the UPS is not connected to an AC supply.
- ▶ Do not remove or unplug the input cord when the UPS is turned on. This removes the safety ground from the UPS and the equipment connected to the UPS.
- ▶ To reduce the risk of fire or electric shock, install this UPS in a temperature and humidity controlled, indoor environment, free of conductive contaminants. Ambient temperature must not exceed 40°C (104°F). Do not operate near water or excessive humidity (95% max).
- ▶ Ensure all power is disconnected before performing installation or service.

CAUTION



- ▶ Batteries can present a risk of electrical shock or burn from high short-circuit current. Observe proper precautions. Servicing should be performed by qualified service personnel knowledgeable of batteries and required precautions. Keep unauthorized personnel away from batteries.
- ▶ Proper disposal of batteries is required. Refer to your local codes for disposal requirements.
- ▶ Never dispose of batteries in a fire. Batteries may explode when exposed to flame.
- ▶ Keep the UPS doors closed to ensure proper cooling airflow and to protect personnel from dangerous voltages inside the unit.
- ▶ Do not operate the UPS system close to gas or electric heat sources.
- ▶ The operating environment should be maintained within the parameters stated in this manual.
- ▶ The UPS system is not intended for outdoor use.

- ▶ Keep surroundings uncluttered, clean, and free from excess moisture.
- ▶ Observe all DANGER, CAUTION, and WARNING notices affixed to the inside and outside of the equipment.

2.2 Typical Powerware 9315 UPS System

Each component of the UPS system is housed in a free-standing cabinet designed for industrial or computer room applications. The cabinets match in style and color, and have safety shields behind the doors for hazardous voltage protection. Figure 2-1 shows a typical Powerware 9315 UPS system.

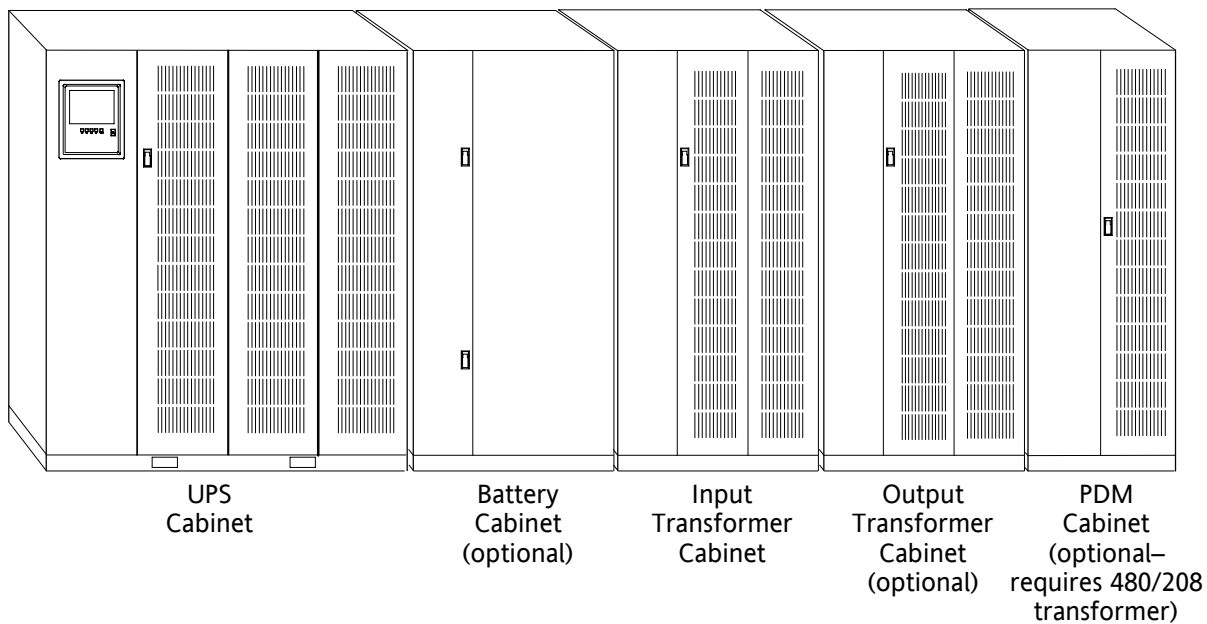

Figure 2-1. Typical Powerware 9315 UPS System

Each cabinet of the UPS system is shipped separately. As shown in Figure 2-1, you can combine a UPS with any of the options described in this manual to meet your system needs. The UPS and options are described in detail later in this manual. The following descriptions provide a brief overview of standard UPS features and available enhancements.



NOTE *You should read this manual and have thorough knowledge of UPS operation before attempting to operate any of the UPS switches, controls, or optional components.*

2.3 Looking Inside the UPS

The Powerware 9315 is a continuous-duty, solid-state UPS that supports the following equipment: process control, data processing, telecommunications/PBX, research, and medical. The Powerware 9315 maintains power to the critical loads during commercial electrical power brownout, blackout, overvoltage, undervoltage, and out-of-tolerance frequency conditions.

The power required by your equipment is called the critical load. The UPS supplies the critical load with conditioned power that is synchronized with your utility power. Figure 2-2 shows the main elements of the UPS.

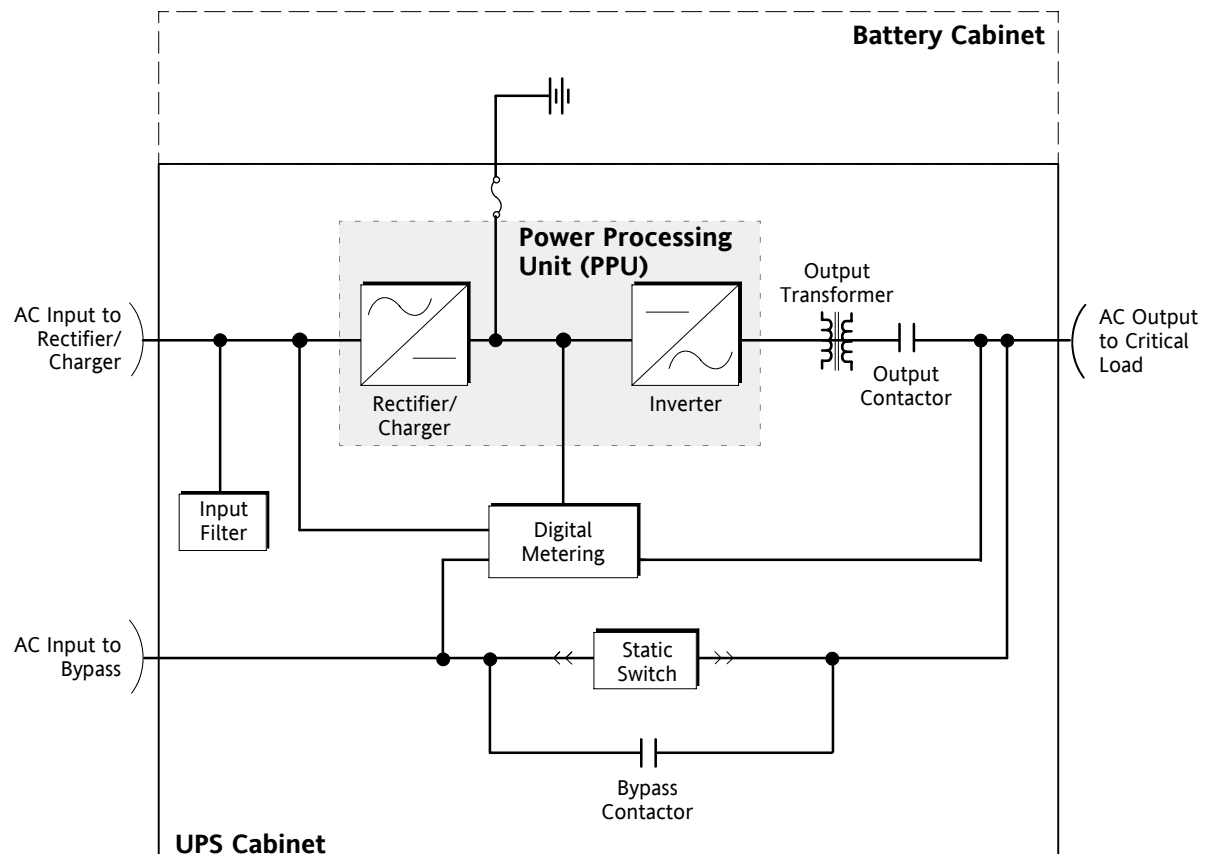

Figure 2-2. Main Elements of the UPS System

If utility power is interrupted or falls outside the parameters specified in Chapter 9, “Product Specifications,” the UPS uses a backup battery supply to maintain power to the critical load for a specified period of time or until the utility power returns. For extended power outages, the backup battery supply allows you to either transfer to an alternative power system (such as a generator) or shut down the critical load in an orderly manner.

The operation of the UPS system is described in greater detail in Chapter 3, “Understanding UPS Operation.” Chapter 9, “Product Specifications,” outlines the storage and operating specifications for the UPS and optional battery.

2.4 UPS Standard Features

The UPS has many standard features that provide cost-effective and consistently reliable power protection:

2.4.1 Monitor Panel

The Monitor Panel on the front of the UPS contains an LCD screen to display the current status of the UPS. You can view a statistical history and log of UPS events and display a real-time graphic representation of power flowing through the UPS components. Backlit status indicators show the operating mode of the UPS and alert you to system events. The emergency LOAD OFF button is also located on the monitor panel and is described in Chapter 5, “Using the Monitor Panel.”

2.4.2 Control Panel

The Control Panel inside the right door of the UPS contains the operator controls to start and stop the UPS, change the operating mode, and reset the LOAD OFF button. The Control Panel is described in “Using the Control Panel” on page 4-1.

2.4.3 Communication Bays

- ▶ **X-Slot® Communication Bay** – The Communications Bay allows internal, UPS-powered communication with optional X-Slot cards. The X-Slot cards support several protocols such as SNMP, HTTP, and Modbus®. See Chapter 7, “Communication” for additional information.
- ▶ **Computer Interface** – Serial communication ports are standard on all UPSs, and are electrically isolated from the UPS. You can use these ports to link the UPS to the features described in Chapter 7, “Communication.”
- ▶ **Summary Alarm Contacts** – Alarm contacts are provided for connection to equipment at your facility such as a light, an audible alarm, or a computer terminal. The equipment you connect to these contacts alerts you to a UPS alarm. This feature is described further in Chapter 6, “Using Features and Options.”
- ▶ **Building Alarm Monitoring** – You can connect your facility’s alarm system contacts to six inputs in the UPS. The UPS uses these inputs to monitor your building alarms in addition to the UPS status. This feature is described further in Chapter 6, “Using Features and Options.”

2.4.4 Input Filter

Your UPS may be equipped with an input filter. An input filter yields power factor correction that allows you to save on the initial installation and operating costs. The filter also reduces input harmonic current distortion and minimizes upstream interference that can damage sensitive hardware components.

2.4.5 Emergency Load Off

A LOAD OFF button is provided for situations where you must immediately remove all power to the critical load. The button is located on the front of the UPS for quick access and is covered with a clear plastic shield to prevent inadvertent operation. The shield must be raised before pressing the button. The LOAD OFF button is described in detail in Chapter 11, “Using the LOAD OFF Button.”

2.4.6 Automatic Battery Charge Current Limit

A preset limit restricts battery charging current to protect batteries from damage due to high current charging. Charging at high currents can overheat and damage batteries.

2.4.7 Installation Features

Power wiring can be routed through the top or bottom of each UPS cabinet. External sensing and monitoring control wire must be installed in accordance with Class 2 wiring methods. Bottom entry is provided for Class 2 wiring.

2.5 Options and Accessories

Contact a Powerware sales representative for information about any of these available options:

2.5.1 Battery

You can enhance the protection provided by the UPS with one or more backup battery supplies equipped with sealed lead-acid, maintenance-free batteries in a matching cabinet. Each battery cabinet contains individual modular battery trays and a battery circuit breaker. Several battery capacities are available.

The UPS battery cabinets can be paralleled; you can increase the battery backup time by adding battery cabinets to your UPS system. The Powerware 9315 can support up to four battery cabinets.

2.5.2 External Battery Disconnect

An optional DC circuit breaker, enclosed in a wall-mounted box adjacent to the UPS, provides a manual means of disconnecting a battery that is located remotely from the UPS. This option is described further in Chapter 6, “Using Features and Options.”

2.5.3 Power Distribution Module (LV models only)

An optional output Power Distribution Module (PDM) is available to distribute the output power of the UPS to the critical load. The PDM cabinet has one or two panels, each containing up to 42 poles for breaker switches. This arrangement provides flexibility for the needs of your facility. Each panel is controlled by one 225A feeder breaker. The PDM is enclosed in a separate cabinet that matches the UPS. This option requires a 480 to 208V transformer.

2.5.4 Upgrade Capability

The UPS is available in various output power ratings in both 50 and 60 Hz models. If your power requirements increase, you can upgrade the UPS system to provide more output power with minimum impact on your facility.

2.5.5 Remote Monitor Panel

An optional Remote Monitor Panel (RMP) contains backlit status indicators and a local horn, allowing you to monitor the operational status and alarm condition of the UPS from virtually any location within your facility. You can install multiple RMPs at remote locations to increase your monitoring capabilities. This option is described further in Chapter 6, “Using Features and Options.”

2.5.6 Relay Interface Module

An optional Relay Interface Module (RIM) uses relay contact closures to indicate the operating status and alarm condition of the UPS system. The module uses a serial interface line and may support up to eight critical loads. This option is described further in Chapter 6, “Using Features and Options.”

2.5.7 Input Isolation Transformer

Optional 480/480, 208/480, or 600/480 Vac input isolation transformers provide an isolated input to the rectifier for applications that require a DC link that is not ground referenced or for applications requiring an input of 208 or 600 Vac. The transformers are contained in separate cabinets.

2.5.8 5% Input Filter

An optional 480/480 Vac 5% input filter reduces input harmonic current distortion and minimizes upstream interference that can damage sensitive hardware components. The filter is contained in a separate cabinet.

2.5.9 Output Transformer

An optional 480/208 Vac output auto transformer provides a 208 Vac output for applications that require 208 Vac. The transformer is contained in a separate cabinet.

2.5.10 Modem

An optional modem is available for use with the UPS Remote Notification feature described in “Remote Notification” on page 7-19. Refer to the manual supplied with the modem for operating instructions.

2.5.11 Customer Convenience Outlet

An uninterruptible 120 Vac, 0.2A, fuse-protected convenience outlet is provided to supply power to the optional modem. It is located adjacent to the Communication Panel.

2.6 Symbols, Controls, and Indicators

These symbols may appear on the UPS system or on labels inside the UPS. They are accepted by most international safety agents. Everyone in your organization who works with your UPS should understand the meaning of these symbols:



ON - The principal power switch is in the On position.



OFF - The principal power switch is in the Off position.



PHASE - The word "phase."



RISK OF ELECTRIC SHOCK - Indicates that a risk of electric shock is present and the associated warning should be observed.



CAUTION: REFER TO OPERATOR'S MANUAL - Refer to your operator's manual for additional information, such as important operating and maintenance instructions.



This symbol indicates that you should not discard the UPS or the UPS batteries in the trash. The UPS may contain sealed, lead-acid batteries. Batteries must be recycled.



This symbol indicates that you should not discard waste electrical or electronic equipment (WEEE) in the trash. For proper disposal, contact your local recycling/reuse or hazardous waste center.

Chapter 3 | Understanding UPS Operation

The UPS functions automatically to supply AC electrical power to the critical load. The UPS always operates in one of three modes:

- ▶ In Normal mode, the critical load is supplied by the inverter, which derives its power from rectified utility AC power. In this mode, the rectifier also provides charging current for the battery.
- ▶ In Bypass mode, the critical load is directly supported by utility power.
- ▶ In Battery mode, the battery cabinet provides DC power, which maintains inverter operation. The battery supports the critical load.

The UPS continually monitors itself and the incoming utility power, and automatically switches between these modes as required, with no operator intervention. The sophisticated detection and switching logic inside the UPS ensures that operating mode changes are automatic and transparent to the critical load. The UPS switches operating modes in response to these system events:

- ▶ A command is an intervention that is externally initiated by an operator or by some site action. A command causes the UPS to switch operating modes; it usually does not require any further action by you.
- ▶ A notice is a minor system event that may or may not require your attention.
- ▶ An alarm is a system event that requires immediate operator intervention.

System events, alarm horns, and indicator lights are described in Chapter 10, “Responding to System Events.”

3.1 Normal Mode

In Normal mode, utility AC power is supplied to the rectifier. The rectifier supplies DC power to the inverter, which then supplies the critical load with AC power. The rectifier also provides charging power to the battery. The battery charge condition is monitored by the UPS and reported by a status indicator on the Monitor Panel. The message “System Normal” appears in the status area of the LCD screen.

Figure 3-1 shows the path of electrical power through the UPS system when the UPS is operating in Normal mode.

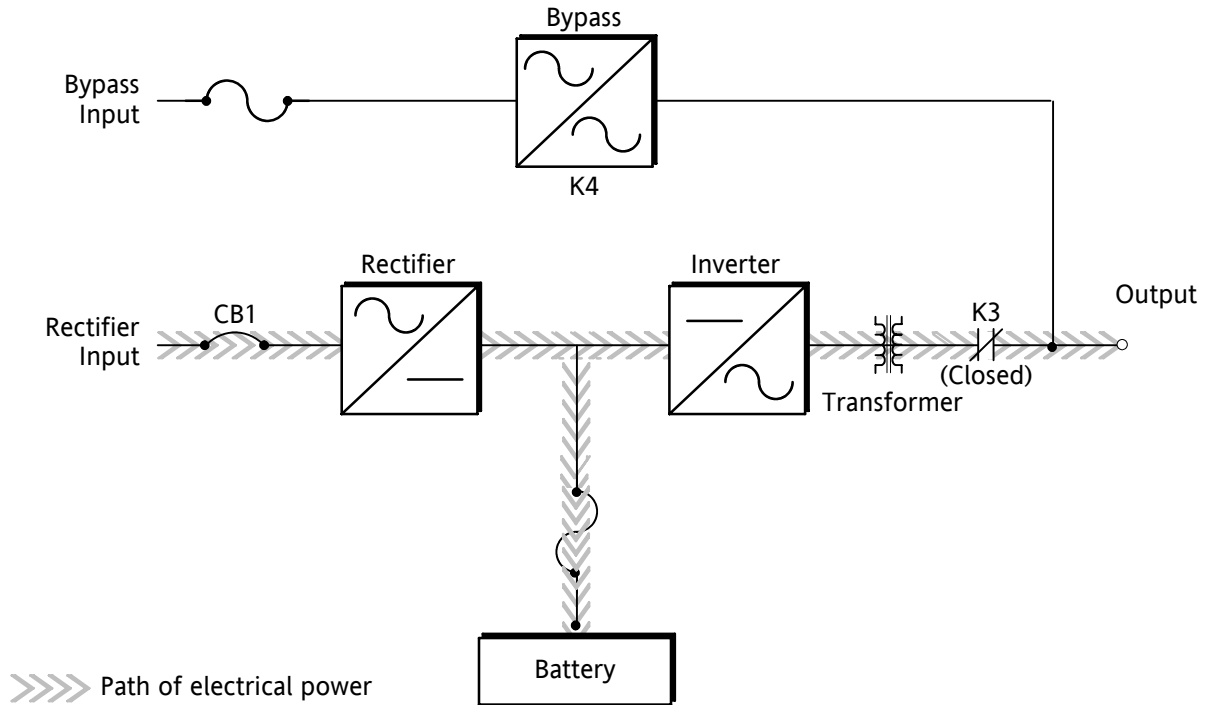

Figure 3-1. Path of Current Through the UPS in Normal Mode

If the utility AC power is interrupted or is out of specification, the UPS automatically switches to Battery mode to support the critical load with no interruption. When utility power returns, the UPS returns to Normal mode.

If the UPS system becomes overloaded, the UPS switches to Bypass mode. The UPS automatically returns to Normal mode when the error condition is cleared and system operation is restored within specified limits.

If the UPS suffers an internal failure, it switches automatically to Bypass mode and remains in that mode until the failure is corrected and the UPS is back in service.

3.2 Bypass Mode

The UPS automatically switches to Bypass mode if it detects an overload, load fault, or internal failure. The bypass source supplies the commercial AC power to the load directly.



CAUTION

The critical load is not protected while the UPS is in Bypass mode.

Figure 3-2 shows the path of electrical power through the UPS system when the UPS is operating in Bypass mode.

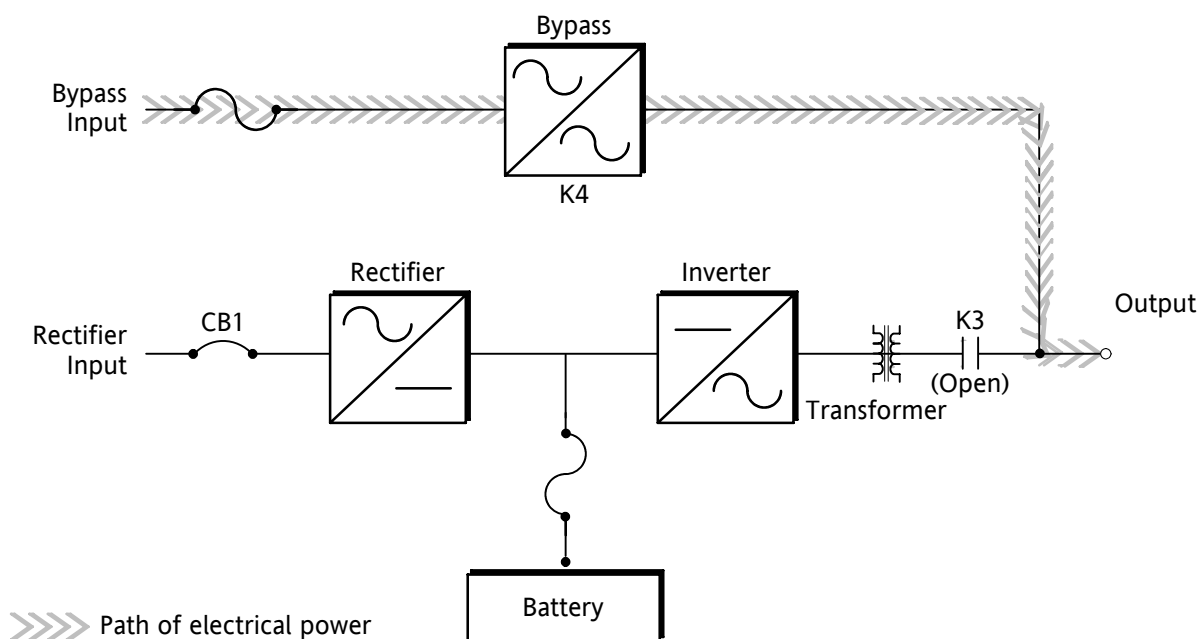

Figure 3-2. Path of Current Through the UPS in Bypass Mode

You can transfer the UPS from Normal mode to Bypass mode manually. However, the UPS switches automatically to Bypass mode whenever the inverter can no longer supply the critical load. If the UPS transfers to Bypass mode from Normal mode due to any reason other than operator intervention, the UPS automatically attempts to transfer back to Normal mode (up to three times within a 10-minute period). The fourth transfer will lock the critical load on the bypass source and requires operator intervention to transfer.

Bypass mode is a normal operating mode, and not an alarm condition. However, if the UPS is unable to return to Normal mode following an automatic transfer to Bypass mode, an alarm condition is recorded.

3.3 Battery Mode

The UPS transfers to Battery mode automatically if a utility power outage occurs, or if the utility power does not conform to specified parameters. In Battery mode, the battery provides emergency DC power that the inverter converts to AC power. When the UPS switches to Battery mode, the alarm indications depend on the cause and condition of the battery charge. The length of time the system can operate in Battery mode depends on load configuration and the battery charge.

Figure 3-3 shows the path of electrical power through the UPS when operating in Battery mode.

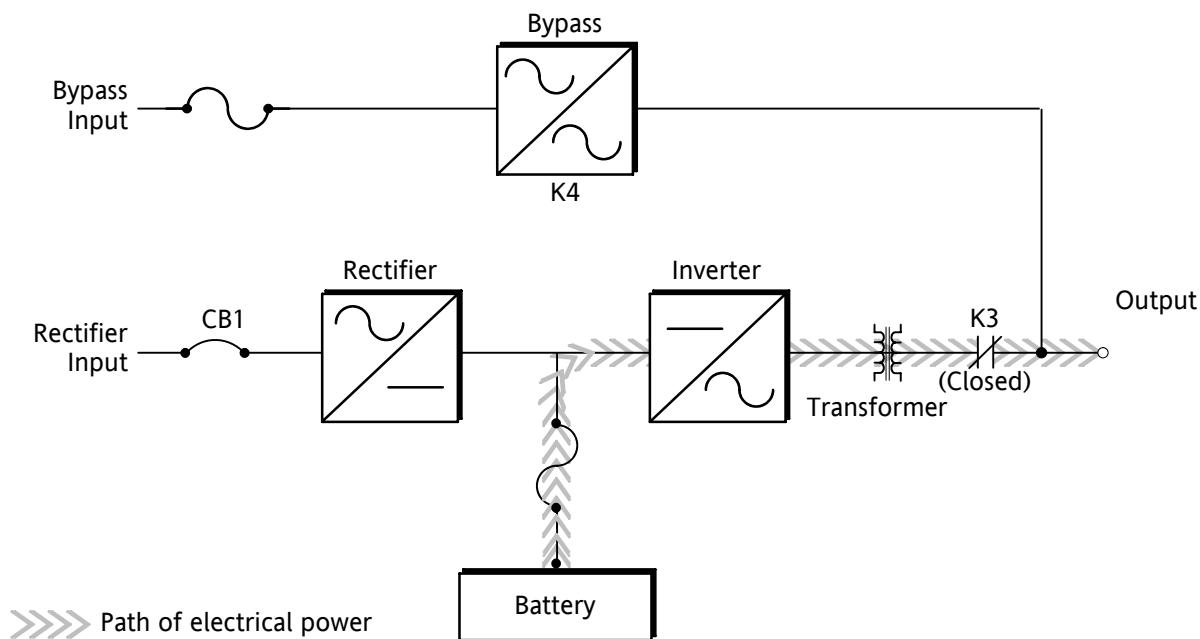

Figure 3-3. Path of Current Through the UPS in Battery Mode

When the discharging battery voltage reaches the lower limit of UPS operation capability, the critical load transfers to Bypass mode if it is available. If Bypass input is not available, a “Shutdown Imminent” warning occurs. The warning time before critical load loss occurs is approximately two minutes, depending on load configuration and the battery charge.

If incoming power returns to within specified parameters, the UPS automatically returns to Normal mode and alarm indications clear. However, the process of returning to Normal mode is not instantaneous. The rectifier gradually draws increasing power from the incoming utility until Normal mode is achieved.

3.4 Monitoring and Controlling UPS Operation

After you start the UPS, no operator intervention is necessary except for periodic checks of the UPS status. Manual operation is required only during routine maintenance or service. Use the Monitor Panel and the Control Panel to monitor and control the UPS. Figure 3-4 shows the location of these two panels on the front of the UPS.

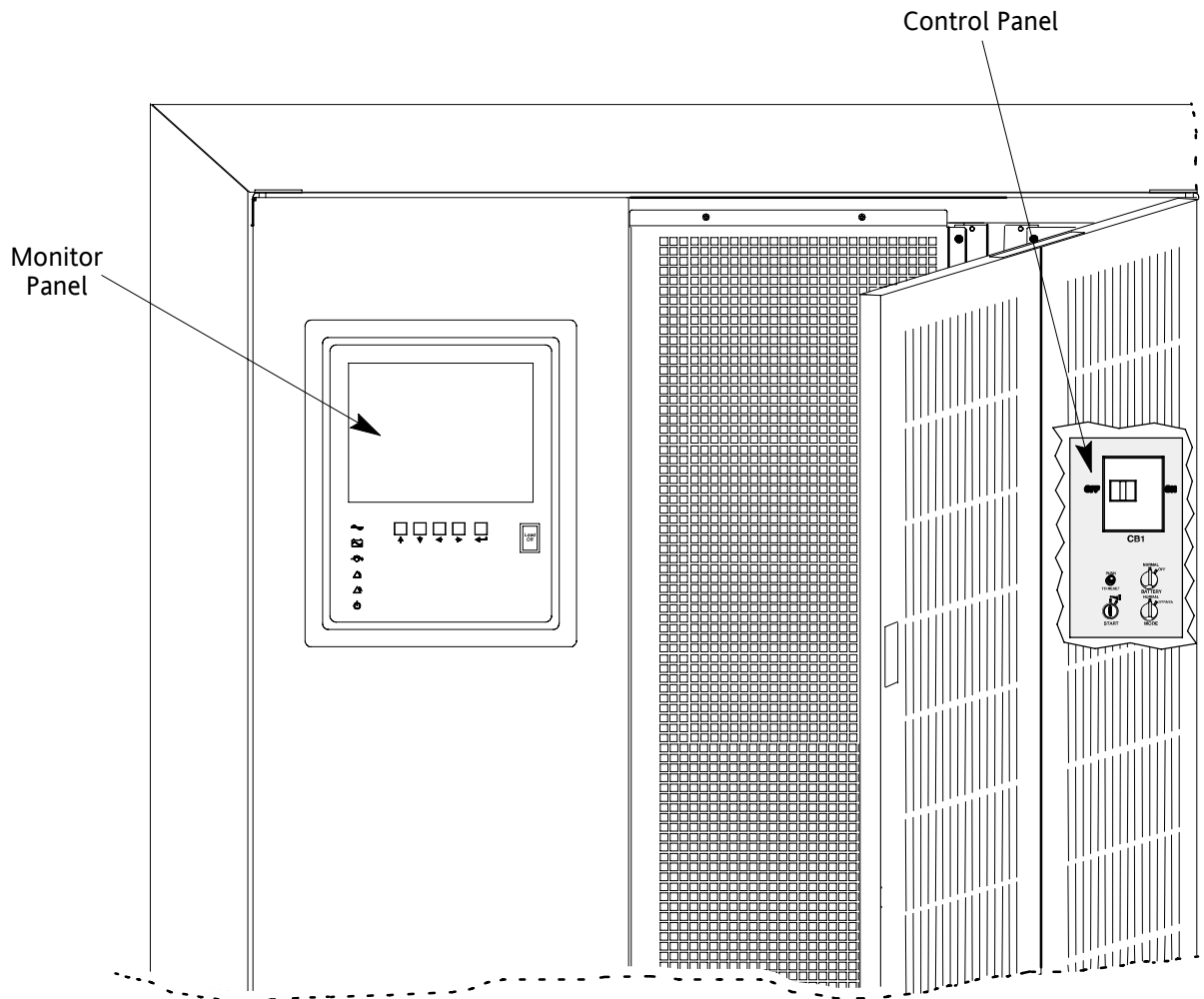

Figure 3-4. Location of the Monitor Panel and the Control Panel

The Monitor Panel on the left front of the UPS continually indicates the present mode of UPS operation. This panel contains an LCD screen, backlit status indicators, and the LOAD OFF button. Use the LCD screen on the Monitor Panel to view performance meters or graphic representations of UPS operation. The Monitor Panel is described in detail in Chapter 5, “Using the Monitor Panel.” A quick reference label describing how to use the Monitor Panel is located inside the UPS above the Control Panel.

Open the right front door of the UPS to view the Control Panel containing various controls and switches. These control power to and from the UPS, and allow you to change the UPS mode manually. The Control Panel is discussed in “Using the Control Panel” on page 4-1.

This page intentionally left blank.

Chapter 4 | Starting and Stopping the UPS

This chapter describes how to use the Control Panel to start and stop the UPS.



NOTE Before starting the UPS, ensure all installation tasks are complete and a preliminary startup has been performed by authorized service personnel. The preliminary startup verifies all electrical interconnections to ensure the installation was successful and the UPS system operates properly.

4.1 Using the Control Panel

The Control Panel is inside the right-hand door of the UPS cabinet (see Figure 4-1). Although the Control Panel appears easy to use, you should read these instructions and thoroughly understand how the controls work before attempting to use them.



CAUTION

Incorrect use of the power controls on the Control Panel can cause a loss of power to the protected equipment.

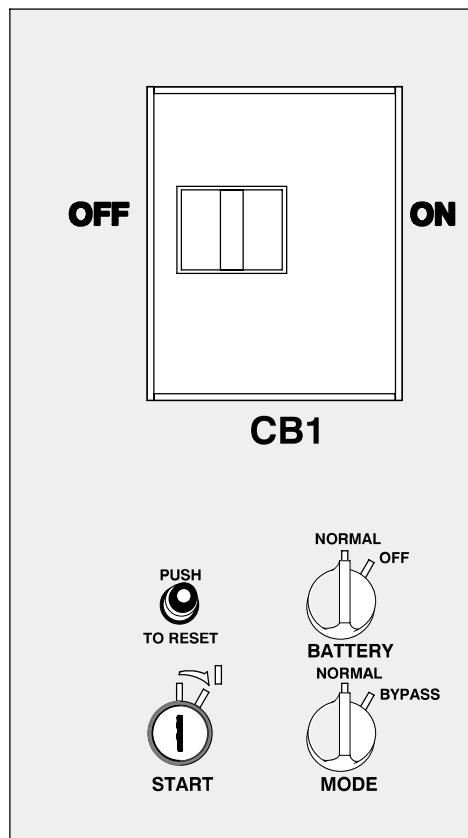

Figure 4-1. UPS Control Panel

The following describes the switches on the Control Panel (see Figure 4-1):

- ▶ The MODE switch is a two-position rotary switch that controls the manual transfer of the UPS to and from Bypass mode. The MODE switch is used to:
 - Place the critical load in Bypass mode when the UPS is operating in Normal mode and the bypass source is within acceptable limits. If the transfer does not occur within two seconds, an alarm sounds.
 - Prevent transfer to Normal mode when the UPS is in Bypass mode.
 - Shut down the power processing unit (inverter and rectifier) of the UPS.
- ▶ The BATTERY switch is a two-position rotary switch that allows you to manually shunt trip the battery breakers in remote cabinets.
- ▶ The circuit breaker (CB1) switch controls the operation of the rectifier and inverter. If CB1 is on (closed), the rectifier turns on when the START switch is activated and the proper voltage is at the input terminals.
- ▶ The PUSH TO RESET button is described in “Resetting the UPS System after Load Off” on page 11-2.
- ▶ The START switch activates the power controls on the Control Panel. The START switch is center-biased (the key will rest only in the upright position). Its operation is similar to that of an automobile ignition switch. After setting the operator controls, you turn the START switch to the right momentarily to activate the controls. When you release it, it returns to the upright position.

The following sections describe how to operate these controls to start, stop, or change the operating mode of the UPS.

4.1.1 To Place the UPS in Normal Mode

1. Close the Input Power Feeder breaker.
2. Verify that the Load Off PUSH TO RESET button is pressed in.
3. Turn the BATTERY switch to NORMAL.
4. Turn the MODE switch to NORMAL.
5. Move the CB1 switch to ON.
6. Turn the START switch to the right momentarily.

The rectifier turns on, then the inverter turns on. The UPS display and alarm alert you to close the battery breaker.

7. Close the battery breaker(s).

When the inverter reaches full voltage, it turns on and supplies power to the critical load. It takes less than one minute for the UPS to achieve Normal mode.

If a bypass source is available when you turn the START switch on, the critical load is immediately supplied by the bypass source in Bypass mode until the inverter turns on and the UPS transfers to Normal mode. The status indicators on the Monitor Panel indicate when the UPS is in Bypass mode or Normal mode as appropriate.

4.1.2 To Shut Down the UPS from Normal Mode

1. Turn the MODE switch to BYPASS.

The UPS switches to Bypass mode. If the bypass source is not available, the power processor remains on and an alarm sounds.

2. When the transfer is complete (the LCD screen reads “On Bypass”), move the CB1 switch to OFF.

The bypass source supplies the critical load and the power processor de-energizes. The Bypass mode indicator illuminates on the Monitor Panel.

4.1.3 To Start the UPS in Bypass Mode

If the PPU of the UPS is not available and you need to energize the critical load right away, you can energize the critical load without the benefit of backup. To turn the UPS on in Bypass mode:

1. Turn the MODE switch to BYPASS. (The remaining switches can be in any position.)
2. Turn the START switch to the right momentarily.

Power to the critical load is supplied by the bypass source. No backup is available.

4.1.4 To Shut Down Power to the Critical Load While in Bypass Mode

To perform maintenance or service on the critical load, you must shut it down first:

1. Turn off all equipment that is being powered through the UPS.
2. Press the LOAD OFF button on the Monitor Panel.

This page intentionally left blank.

Chapter 5 | Using the Monitor Panel

This chapter describes the Monitor Panel and how to monitor and control UPS operation. The Monitor Panel is a black rectangular area on the front of the UPS (see Figure 5-1).

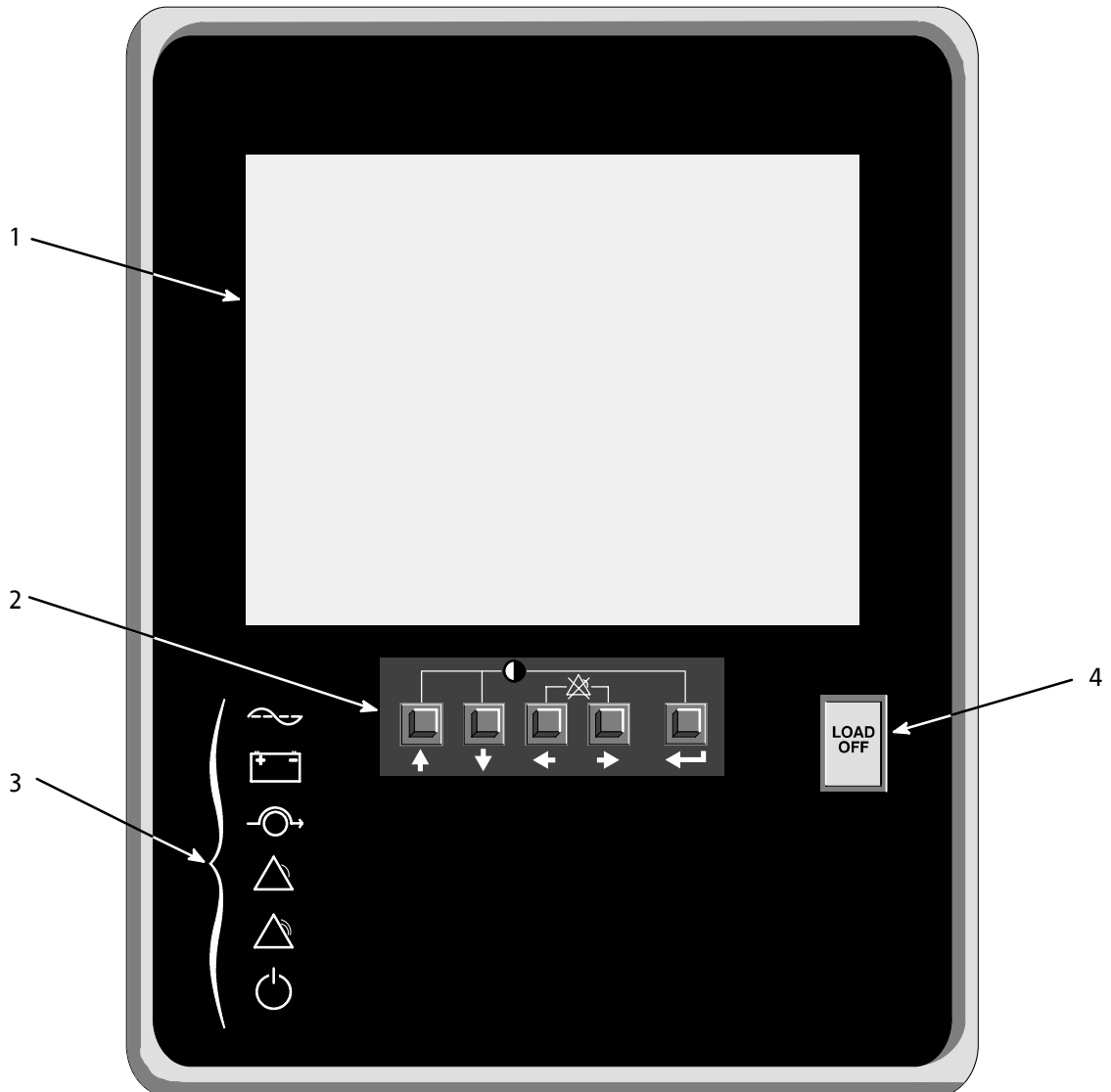

Figure 5-1. UPS Monitor Panel

The Monitor Panel contains a flat liquid crystal display (LCD) screen (1), a horizontal row of buttons (2), a vertical column of backlit status indicators (3), and the red LOAD OFF button (4). A quick reference label describing how to use the Monitor Panel is located inside the UPS above the Control Panel. The following sections describe the Monitor Panel in detail.

5.1 Using the LCD Screen

The LCD screen at the top of the Monitor Panel provides an operator interface with the UPS. Figure 5-2 identifies the display fields discussed in the following sections.

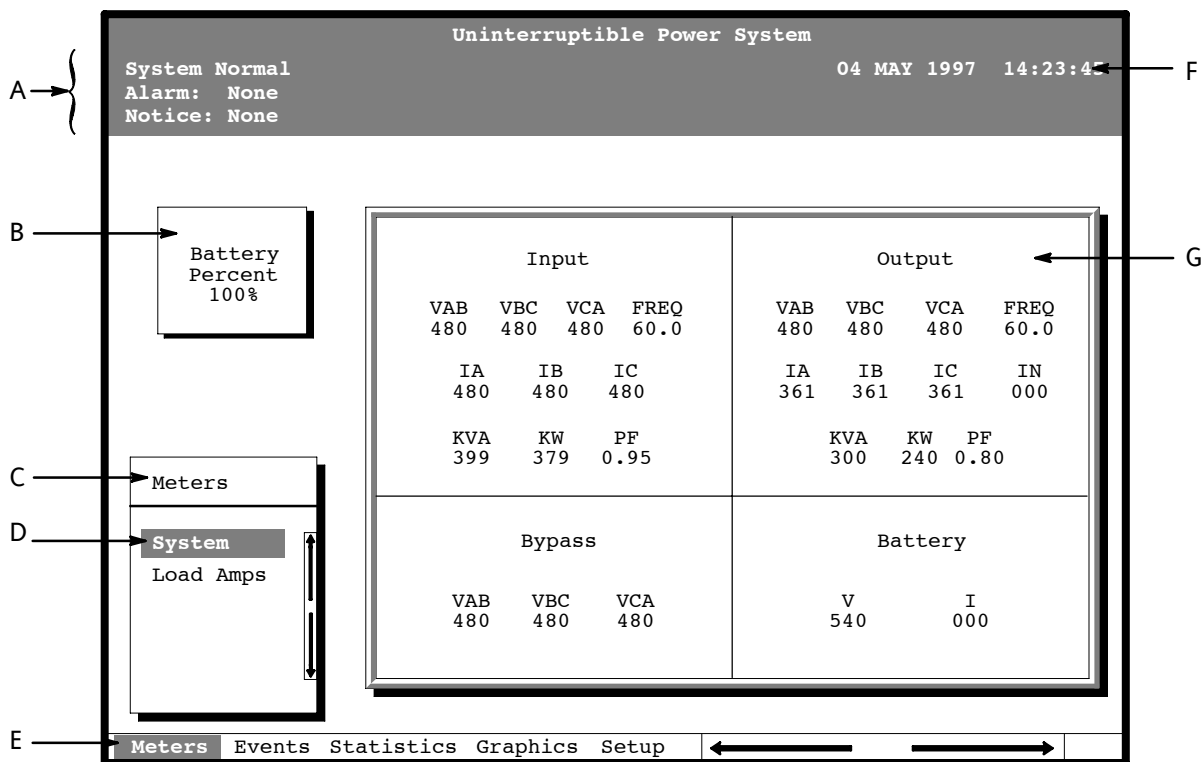

Figure 5-2. Parts of the LCD Screen (Typical for Powerware 9315 300 480/480V UPS)

-
- A The UPS status area contains three lines that display the current state of the UPS. The first line shows the present operational mode of the UPS. The second line shows the highest level of the current active alarms, and the third line shows any notices the UPS has posted. (For more information about alarms and notices, see Chapter 10, "Responding to System Events.")
-
- B The battery charge box shows the percentage of battery capacity available.
-
- C The menu box shows the currently selected menu and lists the options available on that menu. The title at the top of the menu box is also shown below on the menu bar (E). Press the \uparrow and \downarrow buttons to scroll up and down through the options in the menu box.
-
- D The currently selected option is highlighted in the menu box. Press the \uparrow and \downarrow buttons to move the highlight up or down. The data in the information area (G) changes accordingly.
-
- E The menu bar lists the titles of the menus. The title of the menu currently displayed in the menu box is highlighted. When you press the \leftarrow and \rightarrow buttons to move the highlight left or right, the data in the menu box and the information area change accordingly.
-
- F The timestamp shows the current date and time. This date and time are recorded in the Event Log when a notice or alarm is activated.
-
- G The information area contains data about UPS status and operations. Select a menu option to display statistics or graphics.
-





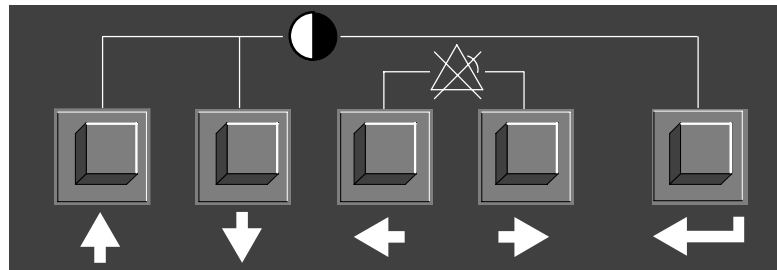

You can use the LCD screen and the buttons beneath it to:

- ▶ Monitor UPS operation
- ▶ Look at a log of UPS events (alarms, notices, and commands)



5.2 Using the Buttons

The buttons below the LCD screen are labeled with arrows indicating their functions:



- ▶ Press the  and  buttons to move through the options in a menu, or to scroll through the list of alarms and notices in the event log.
- ▶ Press the  and  buttons to move through the menu titles on the menu bar. Press them simultaneously to silence the horn, or to test the lamps behind the status indicators.
- ▶ Press the  button to toggle the use of the  and  buttons between the menu box and the information area.

5.3 Adjusting the Contrast

Use the buttons to adjust the contrast on the LCD screen. Hold down the  button, then press the  button to increase the contrast or the  button to decrease the contrast.

5.4 Using the Load Off Button

The LOAD OFF button is red and covered by a clear plastic shield. In an emergency, you can press this button to cut off utility power to the power processing unit of the UPS and to the critical load. For more information, see Chapter 11, “Using the LOAD OFF Button.”









CAUTION

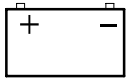



All power to the critical load is lost when you press the LOAD OFF button. You should use the LOAD OFF button only when you want to de-energize the critical load.

5.5 Reading the Status Indicators

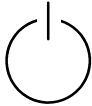
The six symbols on the left side of the monitor panel are status indicators. They are backlit by colored light emitting diodes (LEDs), and they work in conjunction with the alarm horn to let you know the operating status of the UPS.

| Indicator Symbol | Indicator Name | Description |
|---|----------------|--|
|  | Normal | This green symbol is lit when the UPS is operating in Normal mode. The PPU is supplying power to the critical load. |
|  | Battery | This yellow symbol is lit when the UPS is operating in Battery mode. Because Battery mode is a normal condition of the UPS, the Normal indicator also remains lit. |
|  | Bypass | This yellow symbol is lit when the UPS is operating in Bypass mode. The critical load is supported by the bypass source. The Normal indicator is not lit when the system is in Bypass mode. |
|  | Notice | This yellow symbol is lit when the system needs attention. The LCD screen shows all active notices. Some notices may be accompanied by an audible horn. To silence the horn, press the  and  buttons simultaneously. The Notice indicator may be lit along with other indicators. |
|  | Alarm | This red symbol is lit when a situation requires immediate attention. The LCD screen shows the highest priority active alarms. All alarms are accompanied by an audible horn. To silence the horn, press the  and  buttons simultaneously. The Alarm indicator may be lit along with other indicators. |
|  | Standby | This yellow symbol is lit when electricity is present in the PPU of the UPS and the Normal indicator is not lit. During normal startup, this indicator illuminates until the the UPS transfers to Normal mode, at which point the Normal indicator is lit. During normal shutdown, the Standby indicator is lit until all energy in the UPS is dissipated and shutdown is complete. |

For more information about audible horns, see “System Event Horns” on page 10-1.

To test the LEDs behind the status indicators, press the  and  buttons simultaneously for three seconds. All the indicators should illuminate while you hold down these buttons. If any indicator does not illuminate, its LED may need to be replaced. Contact your Eaton service representative if you have a problem with the indicator LEDs.

5.6 Using the Menu Options

The UPS menus allow you to display data in the information area to help you monitor and control UPS operation. The following menus and options are available:

- ▶ **Meters** - Displays UPS performance meters for the system or critical load.
- ▶ **Events** - Displays the list of Active System Events and a historical log of system events.
- ▶ **Statistics** - Displays statistical information about UPS operations for the battery, load, or line.

- ▶ **Graphics** - Displays a real-time graphic representation of the flow of current through the internal UPS components.
- ▶ **Setup** - Allows you to configure the UPS communication port and set the date and time for the timestamp.

Figure 5-3 shows the LCD screen as it appears when you first start the UPS. The Meters menu is displayed in the menu box, with the System option highlighted. In the information area, the system meters show their current readings.

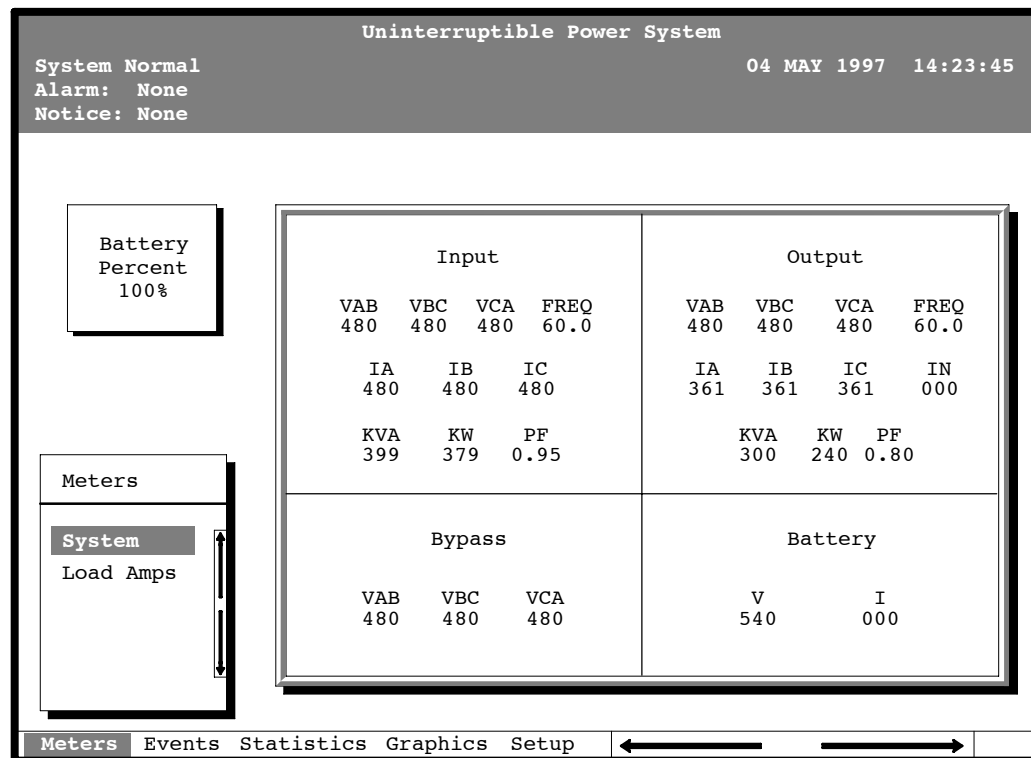

Figure 5-3. System Meters Screen (Typical for Powerware 9315 300 480/480V UPS)

The Input area shows the phase-to-phase voltage, frequency, and phase current of the incoming utility, followed by the kVA, KW, and power factor measurements. The output area shows the same information for the power being output by the UPS.

The Bypass area shows the phase-to-phase voltage of the bypass source. The Battery area displays the DC voltage (V) and the DC current (I).

Select **Load Amps** from the Meters menu to see a real-time bar graph of the output current of the UPS. The graph shows the current for each phase.

Figure 5-4 shows the Load Amps Meters screen.

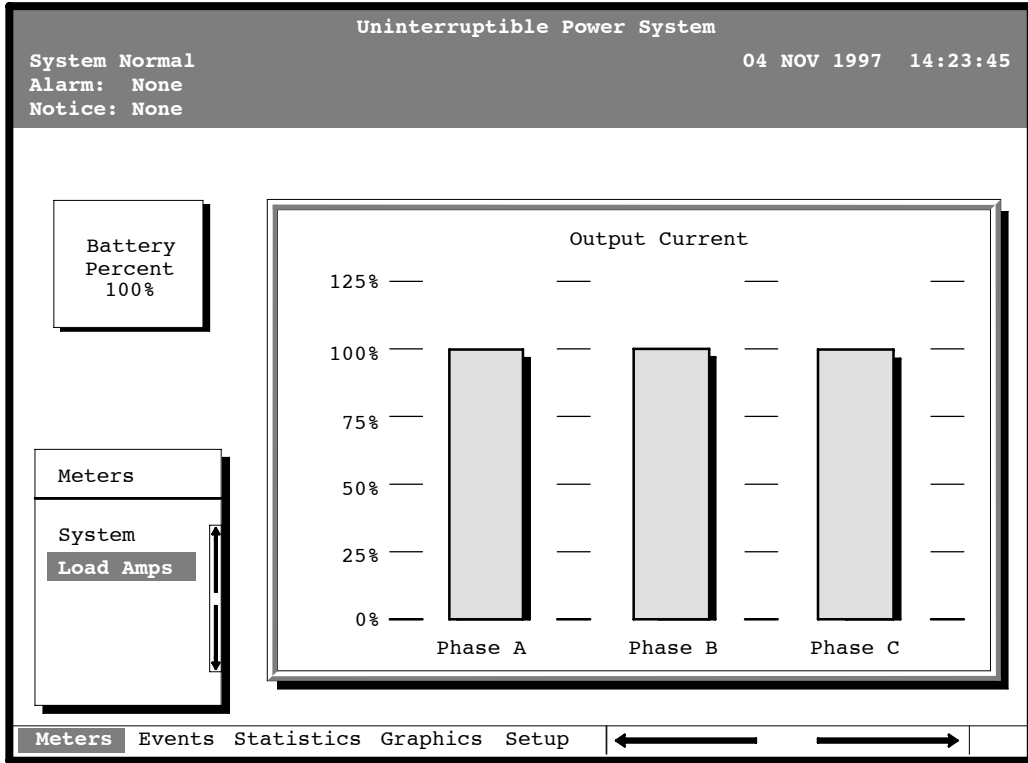

Figure 5-4. Load Amps Meters Screen

Select **History** from the Events menu to display the Event History Log. The Event History Log lists up to 400 system events in chronological order, with the most recent event listed last. The end of the log appears when you display the screen, and you must scroll upward to view older event listings.

Figure 5-5 shows the Event History Log screen.

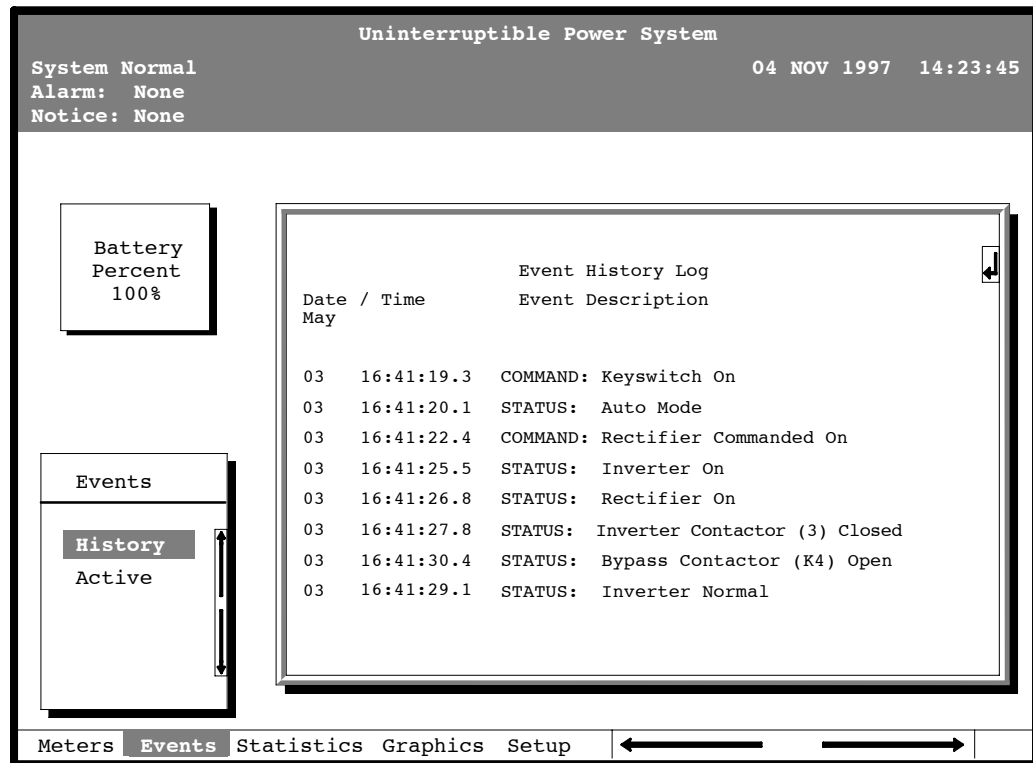

Figure 5-5. Event History Log Screen

A small return arrow (\leftarrow) appears in the upper right corner of the information area of the Event History Log screen. This arrow is a reminder that you can press the \leftarrow button on the Monitor Panel to toggle the scroll bar between the menu box and the information area. When the scroll bar is in the information area, the return arrow is in the menu box. When the scroll bar is in the menu box, the return arrow is in the information area.

When the scroll bar is in the information area, you can press the \uparrow and \downarrow buttons to scroll through the Event History log.

Select **Active** from the Events menu to display a listing of all system events that are currently active. The most recent system event is listed first. As events clear, they are removed from the Active System Events listing.

Figure 5-6 shows the Active System Events screen.

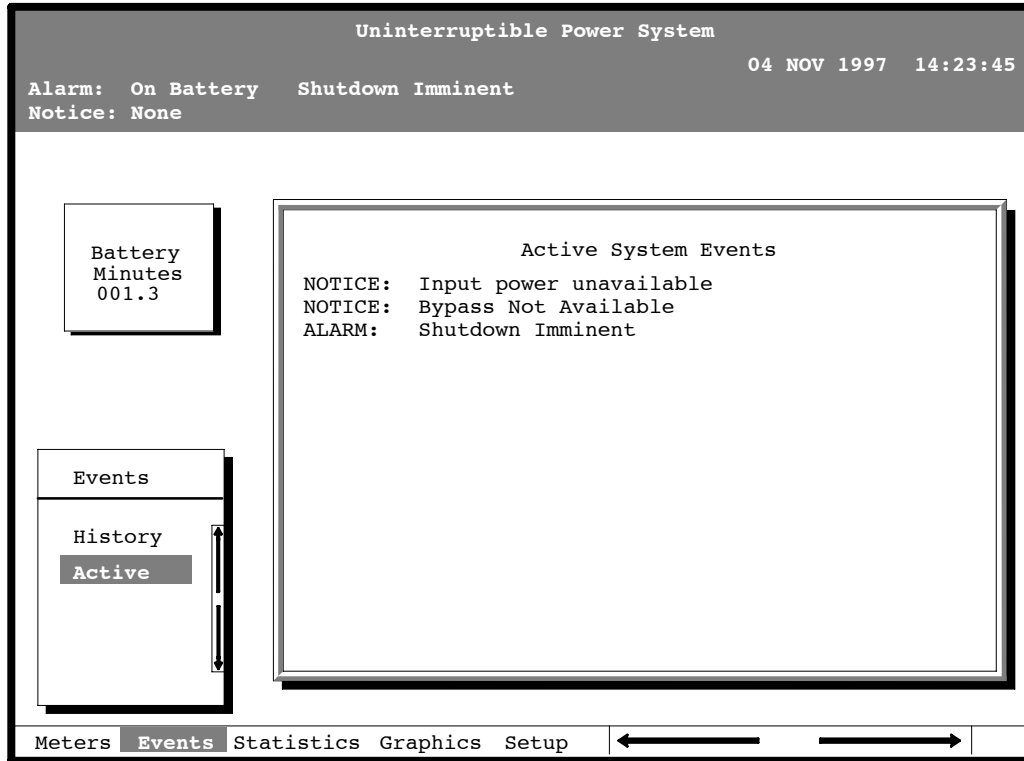

Figure 5-6. Active System Events Screen

Select **Unit** from the Statistics menu to display a listing of statistics about UPS operation.

Figure 5-7 shows the Unit Statistics screen.

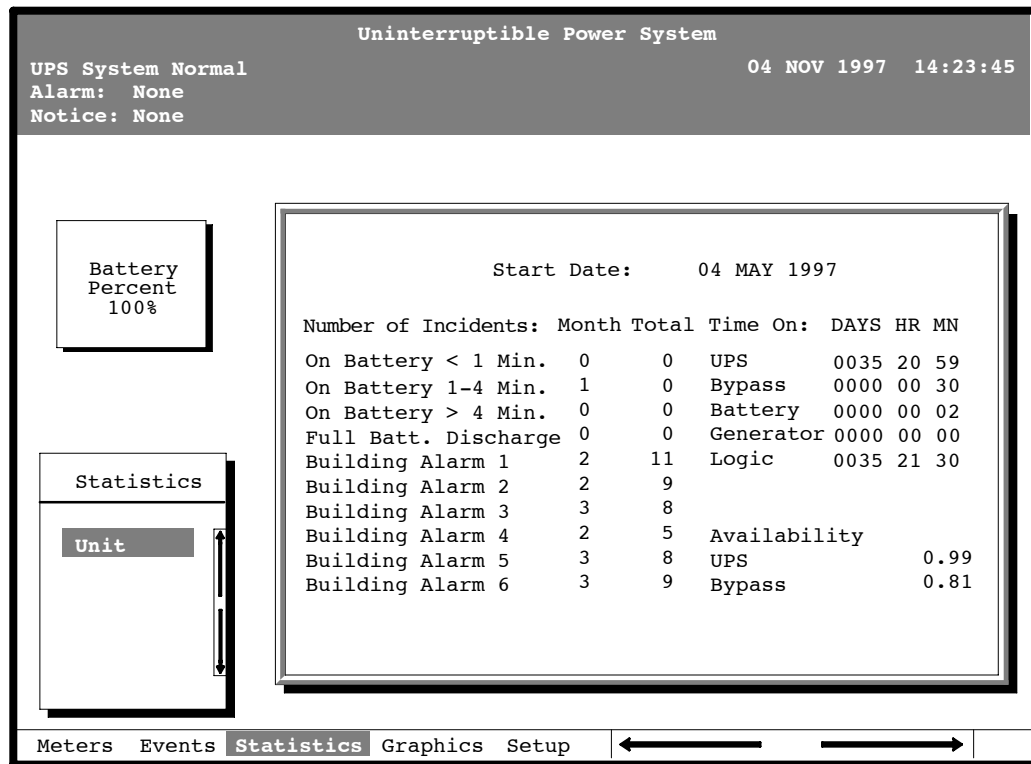

Figure 5-7. Unit Statistics Screen

The left column shows the number of UPS incidents for the current month and total from the start date shown at the top of the screen. The top right column shows the time that the UPS was on bypass, battery, or generator, and the amount of time the UPS logic has been functioning since the start date. The lower right column shows the percent of availability of the UPS and the bypass source.

Select **Mimic** from the Graphics menu to display a real-time graphical representation of the flow of current through the UPS.

Figure 5-8 shows the Mimic screen.

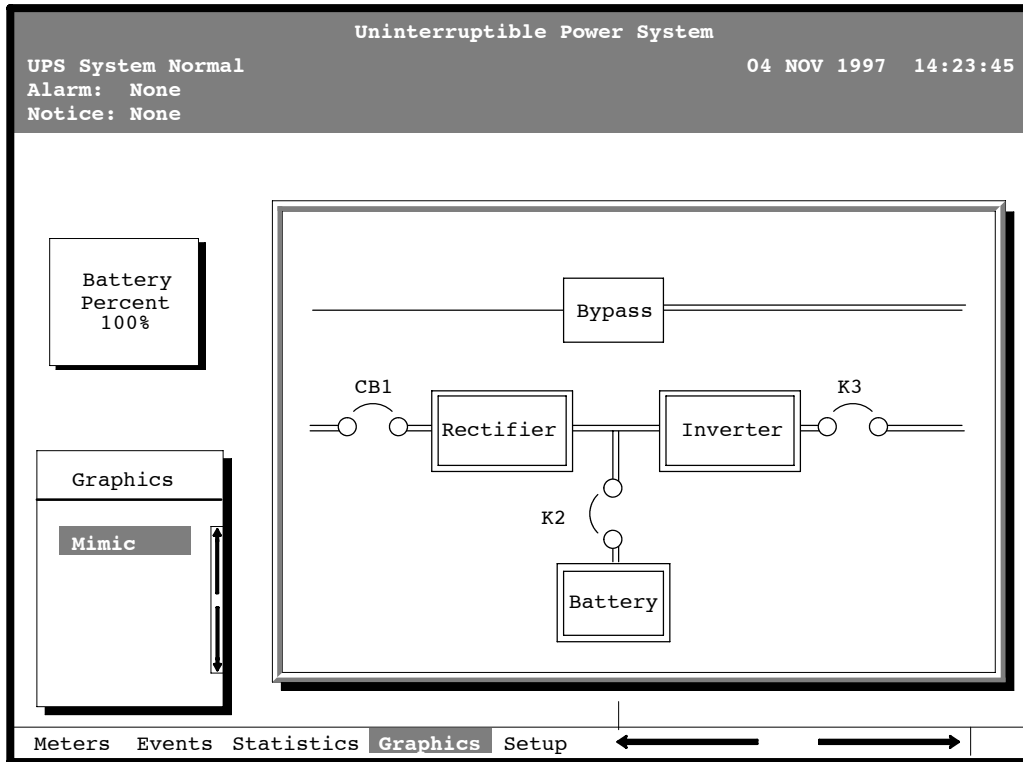

Figure 5-8. Mimic Screen

The Mimic screen shows the internal components of the UPS cabinet. The flow of current through the components is highlighted.

Select **Time** from the Setup menu to display the Time Setup screen. The Time Setup screen allows you to set the internal timestamp of the UPS. The timestamp is used for logging events in the Event History Log. Figure 5-9 shows the Time Setup screen.

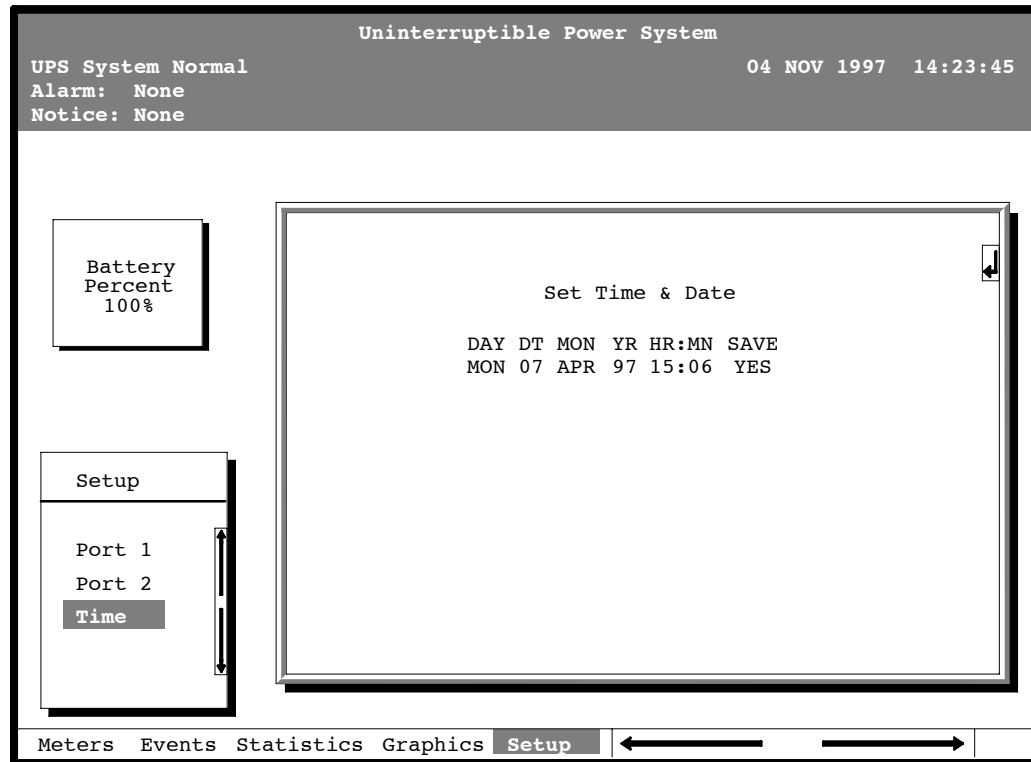

Figure 5-9. Time Setup Screen

The small return arrow (↵) appears in the upper right corner of the Time Setup screen. This arrow is a reminder that you can press the ↵ button on the Monitor Panel to toggle the buttons between the menu box and the information area. When the scroll bar is in the information area, the return arrow is in the menu box. When the scroll bar is in the menu box, the return arrow is in the information area.

When the scroll bar appears in the information area, you can use the buttons to change the timestamp settings. To change a setting in the timestamp, press the ⇐ and ⇒ buttons to highlight the setting you want to change. To increase the setting (make it a higher value), press the ⬆ button. To decrease the setting (make it a lower value), press the ⬇ button. If you want to save the settings upon exit from this screen, be sure the SAVE field is set to YES.

Select **Port 1** or **Port 2** from the Setup menu to display one of the Port Setup screens. The Port Setup screens allow you to specify settings for the two serial communication ports on the UPS. Figure 5-10 shows the Setup Serial Port 1 screen.



NOTE *The X-Slot communication bay is connected internally to the DB-25 port by default; the DB-25 is disabled for other uses. Contact your Eaton service representative to purchase, install, and set up an external modem or an internal X-Slot Modem Card.*

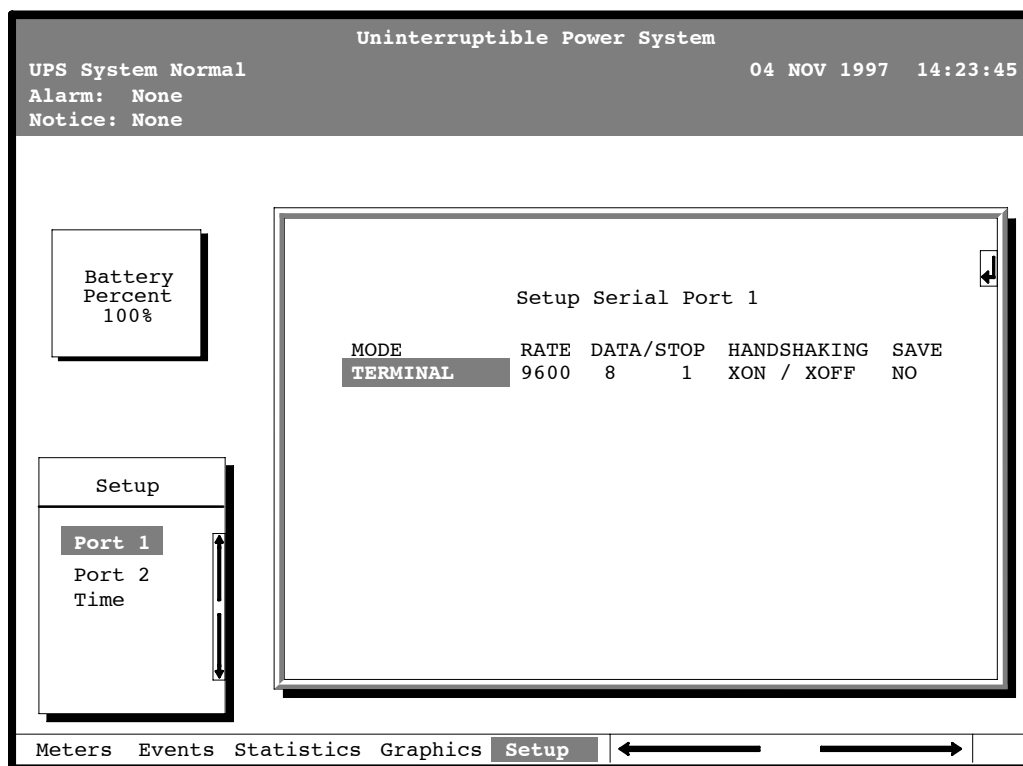

Figure 5-10. Setup Serial Port 1 Screen

The small return arrow (↵) appears in the upper right corner of the Port Setup screen. This arrow is a reminder that you can press the ↵ button on the Monitor Panel to toggle the buttons between the menu box and the information area. When the scroll bar is in the information area, the return arrow is in the menu box. When the scroll bar is in the menu box, the return arrow is in the information area.

When the scroll bar appears in the information area, you can use the buttons to change the port configuration. To change a setting, press the ← and → buttons to move the highlight to the setting you want to change. To scroll through the available options for that setting, press the ↑ or ↓ button. To save the settings upon exit from this screen, be sure the SAVE field is set to YES.

The setup screens for Port 1 and Port 2 are identical. For detailed information about configuring the serial ports, see Chapter 7, “Communication.”

Chapter 6 | Using Features and Options

You can add available options and accessories to enhance the performance of your UPS system. This chapter provides detailed descriptions of some of the features and options introduced earlier in this manual.

6.1 Building Alarm Monitoring

This standard feature lets you connect the UPS to your building alarms, such as smoke detectors or overtemperature alarms. The terminals for external connections are located inside the UPS on the customer interface panel (see Figure 6-1).

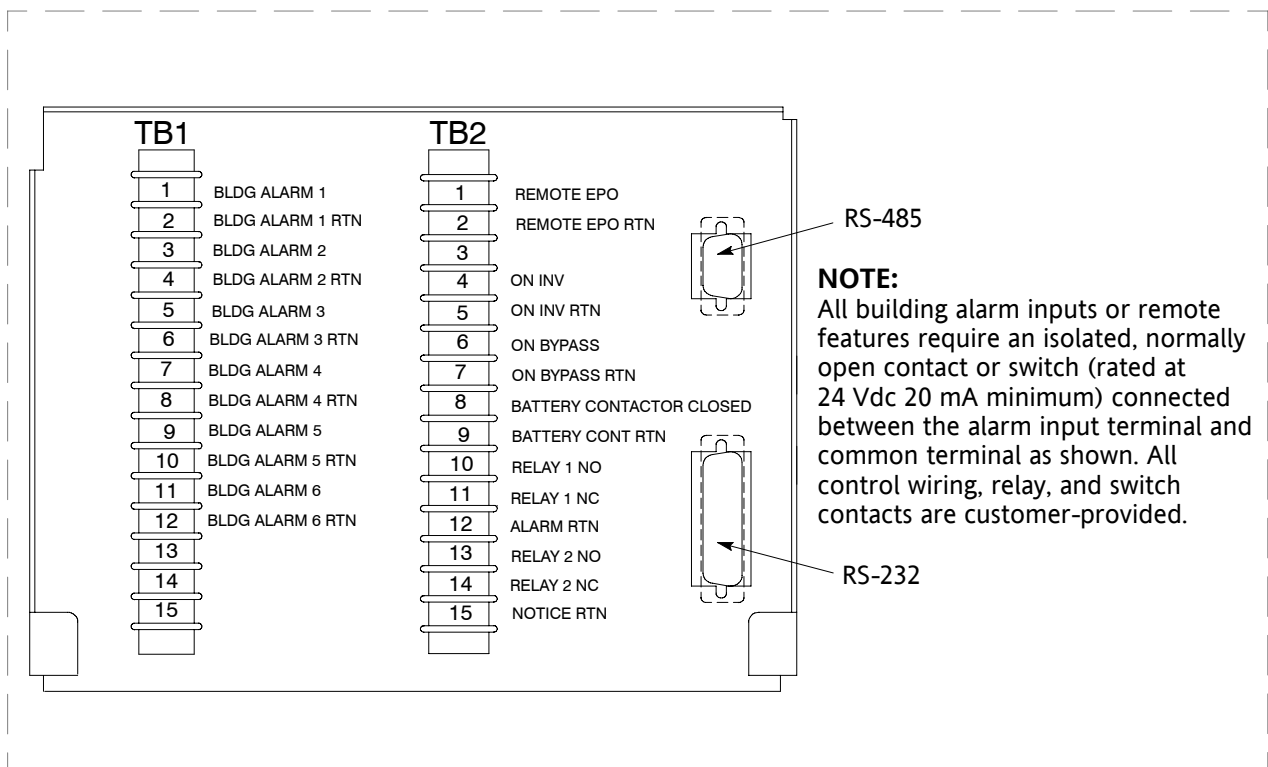

Figure 6-1. External Connections for Building Alarm Monitoring

Regardless of how you assign the building alarms, they display as Building Alarm 1, Building Alarm 2, Building Alarm 3, etc., on the LCD screen of the Monitor Panel. You should use twisted-pair wires for each alarm input and common.

6.2 Summary Alarm Contacts

Two summary alarm contacts are provided as a standard feature on the UPS. The alarm contacts (one notice and one alarm) are located inside the UPS on the customer interface panel (see Figure 6-2).

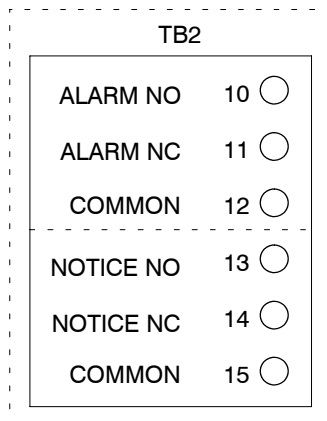

Figure 6-2. Summary Alarm Contacts

You can specify that each contact be either normally closed (NC) or normally open (NO). If the state of the contact changes from the state you specify as normal, an alarm is issued. You can connect these contacts to equipment at your facility (such as a light or an alarm bell) to let you know when an alarm is active on the UPS. This feature is useful if the UPS is located in a remote area where the UPS alarm horn may not be heard immediately.



CAUTION

Contacts should not be operated in excess of 30 Vac or 42.4V peak AC or DC @ 1A maximum.

6.3 Remote Monitor Panel

As an option, you can install RMPs to monitor the operation of the UPS system from virtually any location within your facility, up to 500 ft from the UPS. Each RMP contains backlit status indicators and a local horn. You can flush-mount or surface-mount an RMP on a desktop, wall, or wherever you have a serial interface line. A maximum of two monitoring accessories (RMPs, Relay Interface Modules, or Supervisory Contact Modules) can be installed. See Table 6-1 for the number of accessories permitted. Figure 6-3 shows an RMP.

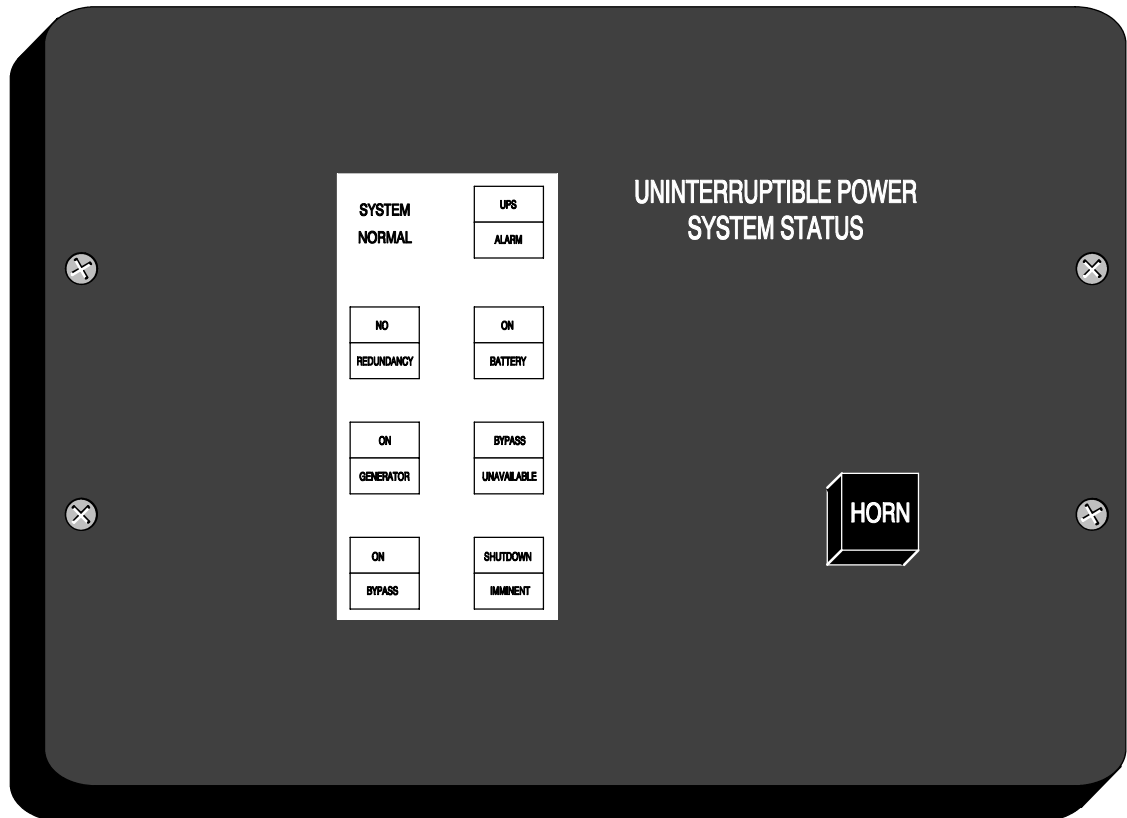

Figure 6-3. Remote Monitor Panel

Table 6-1. Optional Monitoring Accessories

| Number and Type of Accessories Permitted | | |
|--|------------------------|----------------------------|
| Remote Monitor Panel | Relay Interface Module | Supervisory Contact Module |
| 2 | — | — |
| — | 2 | — |
| — | — | 2 |
| 1 | 1 | — |
| 1 | — | 1 |
| — | 1 | 1 |

The RMP contains a local horn and the following backlit status indicators:

SYSTEM NORMAL

The UPS is energized (either with utility power or battery backup) and is supplying conditioned power to the critical load.

NO REDUNDANCY

This indicator applies only to parallel systems when one cabinet is not functioning. This feature is not available on this system.

ON GENERATOR

This alarm means that the UPS input and bypass are being supplied by the power from the generator, instead of from the utility power.

ON BYPASS

The bypass source is supplying the critical load. Usually this means that the UPS is not energized. The load is not protected in Bypass mode, and a horn sounds after 30 seconds.

UPS ALARM

The UPS system is issuing an alarm. Conditions that affect the current UPS mode are indicated by the indicators and horn on the UPS.

ON BATTERY

The UPS battery backup is supplying the critical load. The utility power is either interrupted or out of specification. The SYSTEM NORMAL indicator is also lit.

BYPASS UNAVAILABLE

The UPS system is in Normal mode, but a bypass source is not within specification. A horn sounds after 30 seconds.

SHUTDOWN IMMINENT

The UPS is preparing to shut down because the UPS is in Battery mode and the DC voltage is approaching its low limit. This indicator is accompanied by a horn.

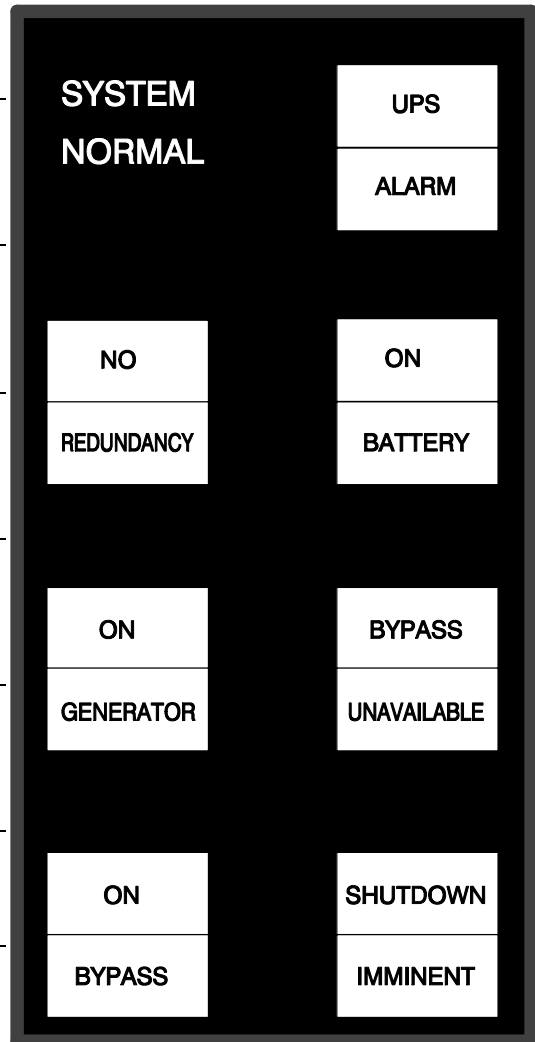

6.4 Battery Cabinets

You can enhance the protection time provided by your UPS by adding one or more battery cabinets. The battery cabinets provided by the UPS manufacturer are equipped with sealed lead-acid, maintenance-free batteries in a cabinet that matches the UPS. Each battery cabinet contains a battery circuit breaker. Several battery capacities are available.

The UPS battery cabinets can be paralleled. With this capability, you can increase your battery backup time by adding battery cabinets to your UPS system. The Powerware 9315 can support up to four battery cabinets.

6.5 External Battery Disconnect

A breaker is located inside each battery cabinet supplied by the UPS manufacturer. However, due to space limitations, your battery cabinets may not be located in the same area as your UPS. An optional external DC circuit breaker provides a manual means of disconnecting a battery that is located remotely from the UPS. The circuit breaker is enclosed in a wall-mounted box. You can install it anywhere between the remote DC supply and the UPS, according to national and local codes.

The breaker switch should be set to ON for normal UPS operation when DC power is available at the UPS. When service personnel are performing maintenance on the UPS or battery cabinet, the switch should be set to OFF.



NOTE *There is no DC disconnect device within the UPS.*

NOTE *The DC input to the UPS is protected by internal fuses F21 and F22.*

NOTE *The UPS DC disconnect trip signal from TB4, points 1 and 2 (shunt trip) or TB4, points 1 and 3 (UV trip) must be connected to the DC source disconnect device(s).*

6.6 Relay Interface Module

An optional RIM uses relay contact closures to indicate the operating status and alarm condition of the UPS system. A maximum of two monitoring accessories (RMPs, RIMs, or SCMs) can be installed. See Table 6-1 on page 6-4 for the number of accessories permitted. Figure 6-4 shows the RIM with its four 15-pin connectors labeled J1 through J4.

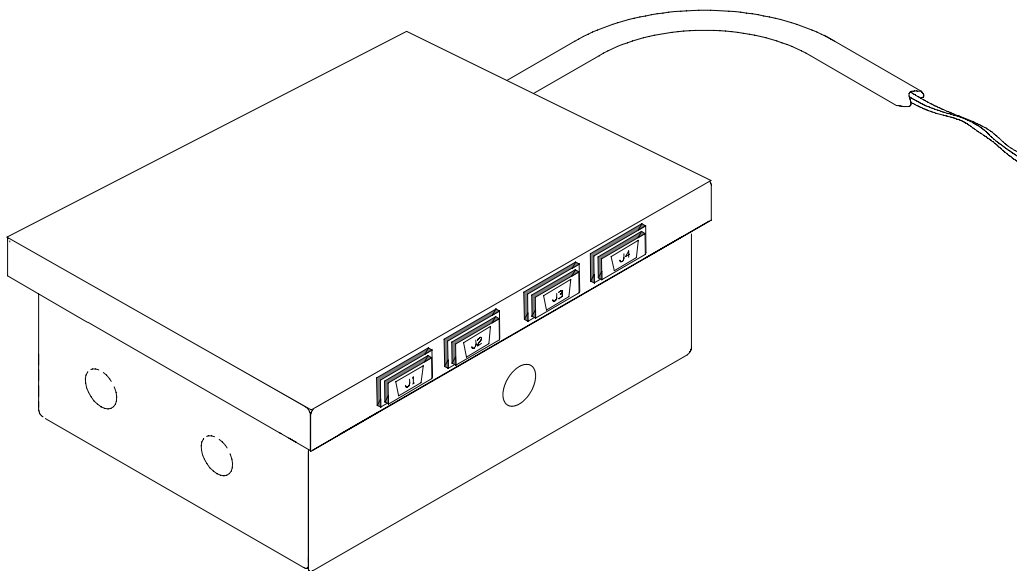

Figure 6-4. Relay Interface Module

The RIM can provide the following signals:

| | | |
|-----------------|---------------|--|
| UPS AVAILABLE | Pins 1 and 12 | Contacts are closed when the UPS is operating in Normal mode or ready to supply the load. |
| UPS OFF LINE | Pins 3 and 13 | Contacts are open when the UPS is offline. Contacts are closed when the UPS is operating in Normal mode. |
| BATTERY WEAK | Pins 5 and 14 | Contacts are closed when approximately two minutes of battery time is remaining, before the critical load is lost. |
| UTILITY FAILURE | Pins 6 and 15 | Contacts are closed when Utility Failure is detected. |

6.7 Supervisory Contact Module

An optional SCM establishes an interface between the UPS manufacturer's equipment and the customer's monitor. This interface allows the customer to monitor operational status of the UPS equipment. A maximum of two monitoring accessories (RMPs, RIMs, or SCMs) can be installed. See Table 6-1 on page 6-4 for the number of accessories permitted. Figure 6-5 shows the SCM, input connections on TB1, and output connections on TB2.

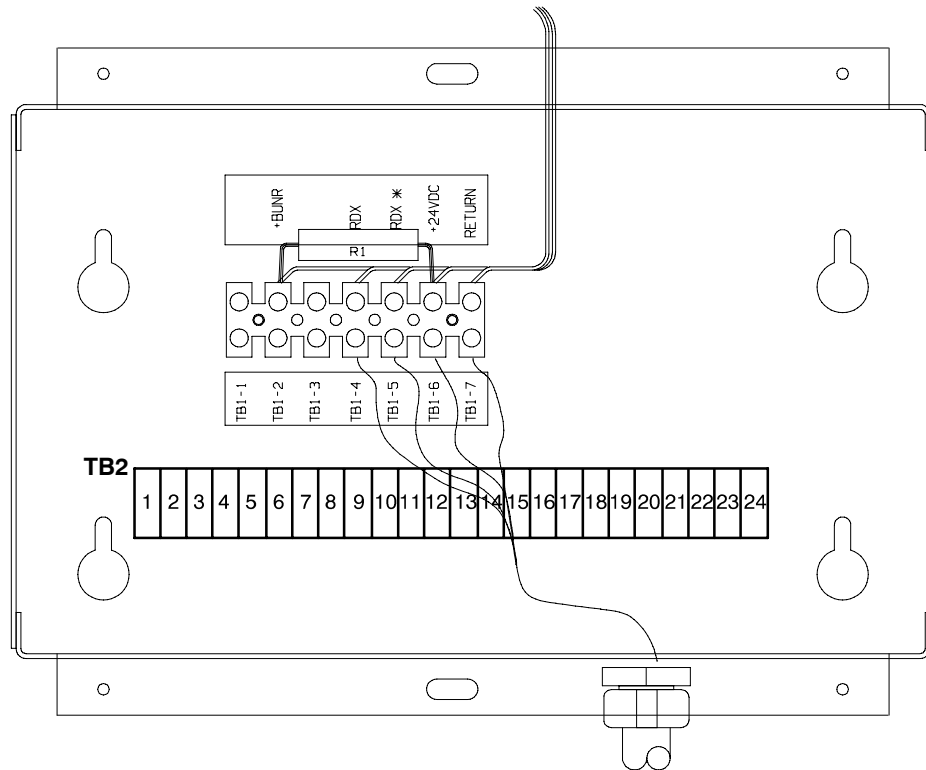

Figure 6-5. Supervisory Contact Module

The SCM provides signals for the following indications:

| | |
|----------------------|-----------------------|
| SYSTEM NORMAL | TB2-1 through TB2-3 |
| NO REDUNDANCY | TB2-4 through TB2-6 |
| ON GENERATOR | TB2-7 through TB2-9 |
| BYPASS NOT AVAILABLE | TB2-10 through TB2-12 |
| ON BATTERY | TB2-13 through TB2-15 |
| UPS ALARM | TB2-16 through TB2-18 |
| ON BYPASS | TB2-19 through TB2-21 |
| SHUTDOWN IMMINENT | TB2-22 through TB2-24 |

Refer to “Installing a Supervisory Contact Module” in the *Powerware 9315 UPS (200–300 kVA) Installation Manual* for TB2 contact configurations.

This page intentionally left blank.

Chapter 7 | Communication

This chapter describes the communication features of the Powerware 9315 UPS and provides information about connecting hardware and using Terminal mode.

7.1 Locating the Communication Bays

The Communication Panel inside the UPS contains a DB-9 and DB-25 serial port. The DB-9 port provides a computer interface to a Remote Monitor Panel, Relay Interface Module, or Supervisory Contact Module. The Communication Panel also contains terminals (TB1 and TB2) for connecting your equipment to the UPS.

The X-Slot communication bay, used for optional X-Slot cards, allows the UPS to communicate in a variety of networking environments and with different types of devices.



NOTE *The X-Slot communication bay is connected internally to the DB-25 port by default; the DB-25 is disabled for other uses. Contact your Eaton service representative to purchase, install, and set up an external modem or an internal X-Slot Modem Card.*

Figure 7-1 shows the location of these items inside the UPS.

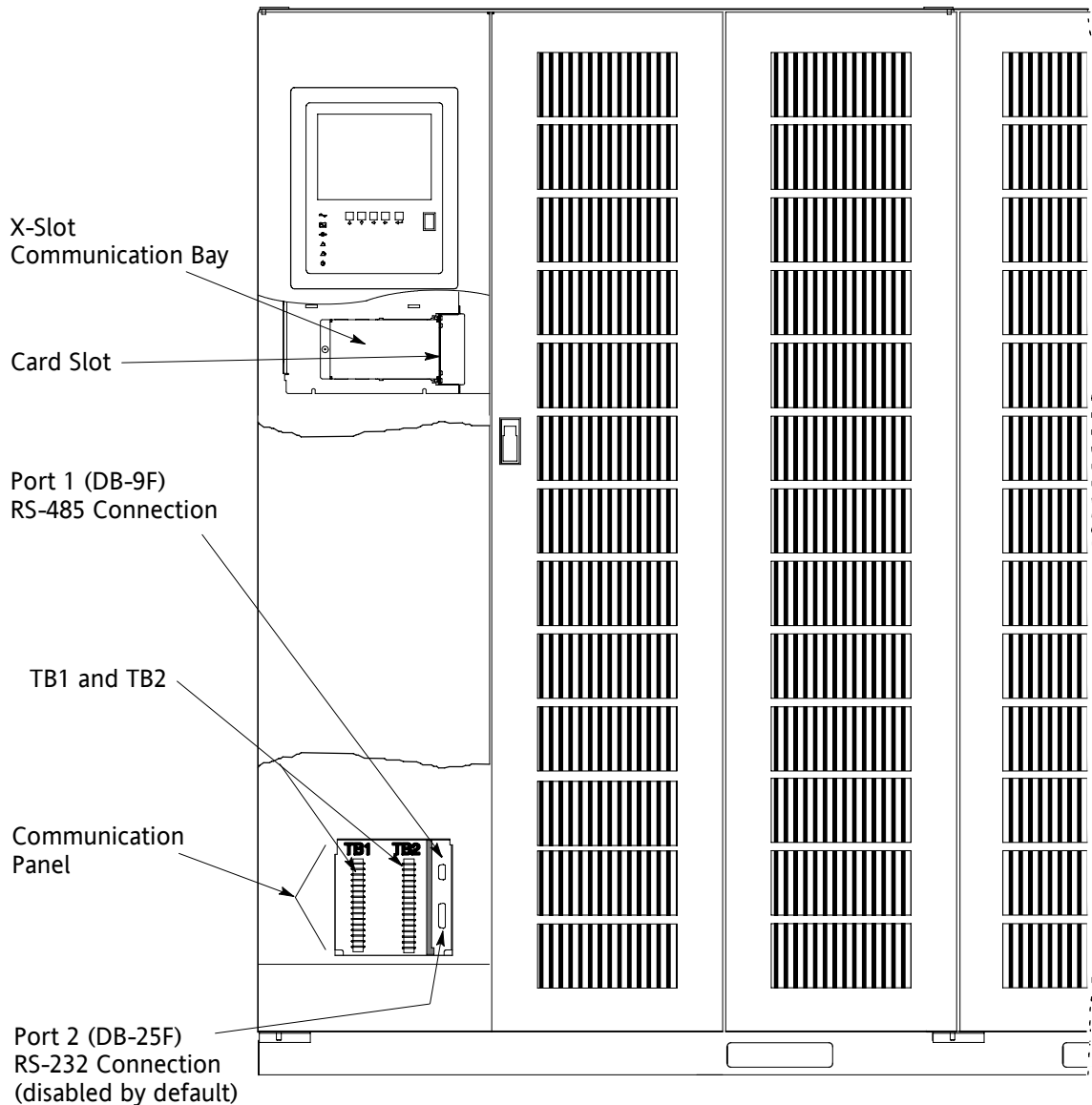

Figure 7-1. Location of Communication Bays on the UPS (Powerware 9315 300)

7.2 X-Slot Cards

The Powerware 9315 is factory-installed with an X-Slot communication bay, and is compatible with the following cards:

- ▶ **ConnectUPS™-X Web/SNMP Card** - provides remote monitoring through a Web browser interface, e-mail, and a network management system using SNMP; connects to a twisted-pair Ethernet (10/100BaseT) network. It has a built-in switching hub that allows three additional network devices to be connected to the network without the requirement of additional network drops. This card is provided as standard equipment with the UPS.
- ▶ **Modbus Card** - provides direct integration of UPS information (meters and status) to a building management system (BMS) using the Modbus RTU protocol.

- ▶ ConnectUPS SNMP Card - has Ethernet, modem, and SNMP capabilities.
- ▶ Modem Card - provides “out-of-band” remote notification and monitoring using modem communication directly to cell phones and pagers.
- ▶ Multi-Server Card - has six serial communication ports that can communicate simultaneously with other computers using LanSafe Power Management Software (provided on the Powerware Software Suite CD).
- ▶ Single-Port Card - connects to the Powerware Expansion Chassis to enable multiple communication options.

LAN and telephone drops, for use with X-Slot connectivity cards, must be provided by facility planners or the customer.

For installation and setup of an X-Slot card, please contact Powerware (see page 1-2). Refer to the manual supplied with the X-Slot card for user instructions.

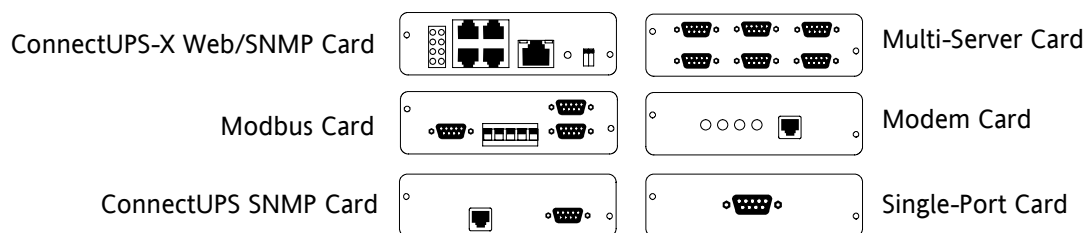

Figure 7-2. Optional X-Slot Cards

7.3 LanSafe Power Management Software

Each Powerware 9315 UPS ships with LanSafe Power Management Software. To begin installing LanSafe software, see the instructions accompanying the Powerware Software Suite CD.

LanSafe software uses an RS-232 serial link to communicate with the UPS, and it provides you with up-to-date graphics of UPS power and system data and power flow. It also gives you a complete record of critical power events, and it notifies you of important UPS or power information. With custom views for monitoring status and metering information, various user groups can select the most useful view for their specific needs.

7.4 Connecting Equipment to a Serial Port

You can connect a wide variety of terminals, printers, and computers to each port, and configure the UPS as the Data Communication Equipment (DCE). Set up the remote equipment using the appropriate parameters for the mode you select. The following section provides more information about configuration.

The cables you use for connection depend on the equipment you are connecting to the UPS. Cables should be no longer than 16m (50 ft). The connectors for Port 1 and Port 2 on the Communication Panel in the UPS are female, so the cables should be male. Figure 7-3 shows the pin assignments for Port 1, and Table 7-1 describes them. Figure 7-4 shows the pin assignments for Port 2, and Table 7-2 describes them.

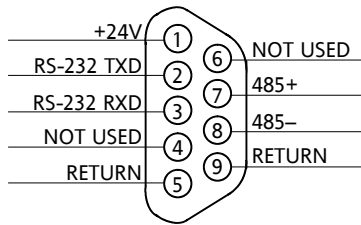

Figure 7-3. Port 1 (DB-9) Pin Assignments

Table 7-1. Pin Assignments for Port 1 (DB-9)

| Pin Number | Symbol | Function | Comments |
|------------|--------|---------------|-----------------|
| 1 | +24V | +24 Volts DC | |
| 2 | TXD | Transmit Data | Input to UPS |
| 3 | RXD | Receive Data | Output from UPS |
| 5 | RTN | Return | |
| 7 | 485+ | RS-485 + Data | |
| 8 | 485- | RS-485 - Data | |
| 9 | RTN | Return | |



NOTE *The X-Slot communication bay is connected internally to the DB-25 port by default; the DB-25 is disabled for other uses. Contact your Eaton service representative to purchase, install, and set up an external modem or an internal X-Slot Modem Card.*

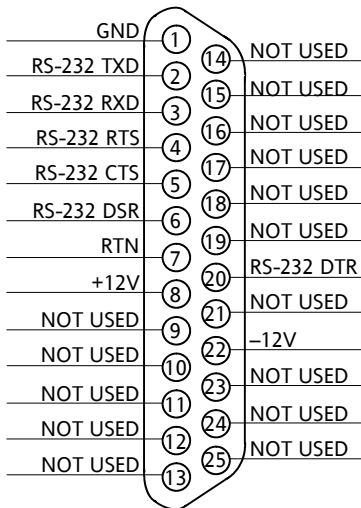

Figure 7-4. Port 2 (DB-25) Pin Assignments

Table 7-2. Pin Assignments for Port 2 (DB-25)

| Pin Number | Symbol | Function | Comments |
|------------|--------|---------------------|--|
| 1 | GND | Chassis Ground | |
| 2 | TXD | Transmit Data | Input to UPS |
| 3 | RXD | Receive Data | Output from UPS |
| 4 | RTS | Request to Send | Input to UPS |
| 5 | CTS | Clear to Send | Output from UPS |
| 6 | DSR | Data Set Ready | Output from UPS |
| 7 | RTN | Return | |
| 8 | +12V | +12 Volts | Output from UPS - always true |
| 20 | DTR | Data Terminal Ready | Input to UPS - typically not used by UPS |
| 22 | -12V | -12 Volts | Output from UPS - always true |

NOTE Pins 5 and 6 are tied together internally.

7.5 Configuring the Serial Ports

You must configure the port for communication using the LCD screen and buttons on the UPS Monitor Panel.

Select **Port 1** from the Setup menu to display one of the Setup Port screens. The screens for Port 1 and Port 2 are identical, and allow you to specify settings for the two serial communication ports. Figure 7-5 shows the Setup Serial Port 1 screen.



NOTE You should configure only Port 1 unless field service has performed a wiring change for Port 2.

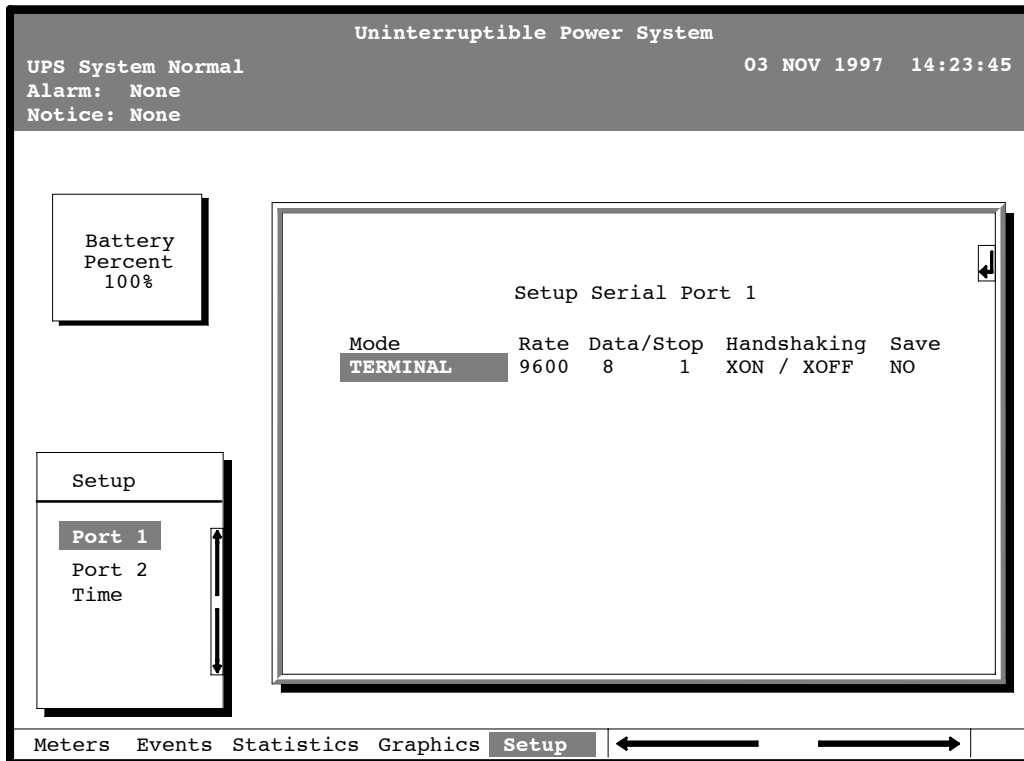

Figure 7-5. Setup Serial Port 1 Screen

A small return arrow (←) appears in the upper right corner of the Setup Port screen. This arrow is a reminder that you can press the ← button on the Monitor Panel to toggle the buttons between the menu box and the information area.

If the scroll bar is in the menu box, press the ← button to toggle to the information area. The first setting (Mode) is highlighted. Press the ← or → button to move the highlight to the setting you want to change. To scroll through the available options for that setting, press the ↑ or ↓ button.

To save the settings upon exit from this screen, be sure the Save field is set to YES.

Table 7-3 shows which options are available for each port. The sections that follow describe the configuration settings you can change.

Table 7-3. Available Options for Each Communication Port

| Port 1 | Port 2 | Options |
|--------|--------|--|
| X | X | Terminal Mode |
| | X | Calibration Mode |
| X | X | System Configuration Mode |
| | X | Computer Mode |
| X | | Remote Monitor Mode |
| X | X | Baud rate of 300, 1200, 2400, 4800, 9600, or 19200 |
| X | X | Data size/stop bits of 8/1 or 8/2 |
| | X | Data size/stop bits of 7/1 or 7/2 |
| X | X | Disabled handshaking |
| X | X | XON/XOFF handshaking |

NOTE You should change Port 2 options only if field service has performed a wiring change.

7.5.1 Mode

The operational mode of the port. Each communication port operates in one of the following modes:

| | |
|---------------------------|--|
| Terminal Mode | System events are logged immediately as they occur. |
| System Configuration Mode | Allows you to set building alarms, battery tests, etc. (Check with your sales or service representative for availability.) |
| Calibration Mode | Used only by service personnel. |
| Computer Mode | Provides a proprietary Binary Computer Mode (BCM) Interface. |
| Remote Monitor Mode | Sends all system event information to an RMP, RIM, or SCM. Available for Port 1 only. |

Port 1 and Port 2 cannot be in the same mode simultaneously; they must always be operating in different modes. The modes are described later in this chapter.

7.5.2 Rate

The baud rate of the equipment connected to this port. The baud rate determines the speed of data transferred between the UPS and the connected equipment. For Remote Monitor mode, the baud rate must be set to 300. All other modes should operate at the highest baud rate available with the connected equipment. 300 baud is not recommended for any mode except Remote Monitor.

You can select a baud rate of 300, 1200, 2400, 4800, 9600, or 19200.

7.5.3 Data/Stop

The data size and stop bits of the equipment connected to this port. These settings determine the number of bits transmitted per ASCII character. The data size and stop bits you specify depend on the configuration of your equipment.

For Port 1, the data size must be set to 8, with 1 or 2 stop bits. Settings of 7 data bits/1 stop bit and 7 data bits/2 stop bits are available for Port 2.



NOTE *When connecting a computer running a terminal emulation program, you should set your equipment to NO PARITY.*

7.5.4 Handshaking

This setting controls handshaking. You can select XON/XOFF or Disabled for this setting.

7.5.4.1 Disabled (No Handshaking)

If handshaking is disabled, the UPS transmits and receives data via the serial port, ignoring all inputs from handshaking lines.

7.5.4.2 XON/XOFF

If handshaking is enabled, the UPS uses special characters (XON and XOFF) to handshake with the host terminal. The XON character is defined to be ASCII value 11 hex, and the XOFF character is defined to be ASCII value 13 hex. Upon receiving an XOFF command, the UPS halts transmission until an XON command is received. In the same way, if the terminal receives an XOFF command, the UPS expects the terminal to halt transmission until the UPS sends an XON command.

7.5.5 Save

Set to YES to save any changes to configuration settings upon exit from the Setup screen. Set to NO if you do not want to save any changes.

7.5.6 Default Settings

The following are the default configuration settings for the serial communication ports:

| | | | | |
|--------|----------------|-----------|-----|----------------------|
| Port 1 | Remote Monitor | 300 baud | 8/1 | Handshaking Disabled |
| Port 2 | Terminal | 9600 baud | 8/1 | Handshaking Disabled |

Each communication port on the UPS operates in one of five modes, which you select when configuring the port using the Setup Port screen.

7.6 Terminal Mode

In this mode, system events are continually logged through the serial port to the device connected to the port. Port 2 operates by default in Terminal mode.

The printed log entries contain a time and date stamp and the alarm text message. Terminal mode uses this format for printing alarm entries:

```
MMM DD HH:MM:SS.hh KYWD MESSAGE **** <CR> <LF>
```

| <i>Symbol</i> | <i>Description</i> |
|---------------|---|
| MMM | Month (3 letters) |
| DD | Day (2 digits) |
| HH | Hour (2 digits) |
| MM | Minute (2 digits) |
| SS | Second (2 digits) |
| hh | Hundredths of Second (2 digits) |
| KYWD MESSAGE | Keyword (ALARM, NOTICE, COMMAND, or STATUS) |
| **** | System Diagnostic Information |
| <CR> | Carriage Return Character (ASCII 13) |
| <LF> | Line Feed (ASCII 10) |

An alarm message is prefixed by the word “CLEAR” whenever an alarm is entered into the Event History Log with a cleared status.

7.6.1 Printing Selected Information

If a port is operating in Terminal mode and is connected to a computer, you can use key combinations at any time to print only selected information:

| | |
|------------|--|
| [Ctrl]+[P] | Prints the entire log with a header |
| [Ctrl]+[M] | Prints the current system meters with a header |
| [Ctrl]+[A] | Prints all system information |
| [Ctrl]+[B] | Prints the Battery Test Log |

To use a key combination, hold down the Control key and press the letter key.

7.6.2 Entire Log – [Ctrl]+[P]

This key sequence prints the entire Event History Log of the UPS at the time the data is requested. The printout begins with the oldest alarm entry in the queue and ends with the most recent. Any alarms that occur while the Event History Log is printing are included in chronological order.

The Event History Log lists up to 400 system events in chronological order with the most recent event listed last. Figure 7-6 shows a sample Event History Log printout.

```

                                Uninterruptible Power System

UPS System Normal                03 NOV 1997   14:23:45
Alarm:  None
Notice: None

                                Event History Log

                                Event Description

MAY 12 16:41:19.3 COMMAND: Keyswitch On      0421
      12 16:41:29.1 STATUS: Auto Mode        1000
      12 16:41:42.4 COMMAND: Rectifier Commanded On 2030
      12 16:42:05.5 STATUS: Inverter On      2202
      12 16:42:46.8 STATUS: Rectifier On
      12 16:43:15.8 STATUS: Inverter Contactor (3) Closed
      12 16:43:42.4 STATUS: Bypass Contactor (K4) Open
      12 16:44:29.1 STATUS: Inverter Normal 4001      32

JUN 04 12:16:35.9 NOTICE: Room High Temperature

```

Figure 7-6. Event History Log

7.6.3 Meters Printout – [Ctrl]+[M]

This key sequence prints the current readings of the UPS system meters. The input area shows the phase-to-phase voltage, frequency, and phase current of the incoming utility, followed by the kVA, kW, and power factor measurements. The output area shows the same information for the power being output by the UPS. The Bypass area shows the phase-to-phase voltage of the bypass source. The Battery area displays the DC voltage (V) and the DC current (I). Figure 7-7 shows a sample Meters printout.

```

Uninterruptible Power System

UPS System Normal           03 JAN 1997  14:22:49
Alarm:  None
Notice: None

      Input                      Output
VAB VBC VCA FREQ      VAB VBC VCA FREQ
480 480 480 60.0      480 480 480 60.0

  IA  IB  IC          IA  IB  IC  IN
 480 480 480        361 361 361  0

  KVA  KW  PF          KVA  KW  PF
 399  379 0.95        300 240 0.80

      Bypass                      Battery
VAB VBC VCA          V  +  I
480 480 480        540  +  0

```

Figure 7-7. System Meters

7.6.4 System Information Printout – [Ctrl]+[A]

This key sequence prints a listing of all available serial data. This printout contains the information shown on the Event History Log and System Meters screens of the UPS (both Figure 7-6 and Figure 7-7).

7.6.5 Battery Test Printout – [Ctrl]+[B]

This key sequence prints the Battery Test Log. The log consists of a history of the last 30 battery tests that were run and the results of those tests. The most recent test appears at the bottom of the log. Figure 7-8 shows a sample of the Battery Test Log.

| Uninterruptible Power System | | | | | |
|------------------------------|-------|--------|----------------------|--|--|
| UPS # 1 | | | | | |
| UPS System Normal | | | 12 NOV 1997 15:39:31 | | |
| Alarm: None | | | | | |
| Notice: None | | | | | |
| Battery Test Log | | | | | |
| Date/Time | Volts | Health | Data | | |
| AUG 14 23:45 | 498.0 | 1.00 | 0000 | | |
| SEP 11 23:45 | 498.0 | 1.00 | 0000 | | |
| OCT 9 23:45 | 498.0 | 1.00 | 0000 | | |
| NOV 13 23:45 | 498.0 | 0.99 | 0000 | | |
| DEC 11 23:45 | 498.0 | 0.99 | 0000 | | |
| JAN 8 23:45 | 498.0 | 0.98 | 0000 | | |
| FEB 12 23:45 | 498.0 | 0.98 | 0000 | | |
| MAR 12 23:41 | 000.0 | 0.00 | 0003 | | |
| APR 9 23:45 | 496.2 | 0.98 | 0000 | | |

Figure 7-8. Battery Test Log

The Date/Time field is the date and time of the battery test.

The Volts field is a measured value of the battery voltage during the test. This field displays 000.0 if the test did not run to completion.

The Health field is a relative measurement of the battery condition. This number can be used to chart the condition of the batteries. If a sudden change of this number occurs relative to the previous test results, it is an indication that the batteries may need attention. This display is 0.00 if the test does not run to completion.

The Data field is a value to be used by your field service engineer to gain more information about the battery tests.

If the battery test does not complete, the Volts and Health field reads zero and the UPS Event History Log reports either Battery Test Failed, Battery Test Aborted (Load), or Battery Test Aborted (Utility). If the test ran to completion, Battery Passed Test appears in the UPS Event History Log.

7.7 System Configuration

The System Configuration mode allows you to modify special functions in your UPS. These functions include programming of building alarms, customizing building alarm messages, adjusting the nominal output voltage, and scheduling battery tests. The menus provided and their function are described in this section.

7.7.1 System Configuration Mode Main Menu

When the System Configuration mode is selected with a terminal attached, you are prompted to enter the password for this mode:

Please Enter Password:

The default password is **EXIDE1**. You may modify this password using the change password function in the following menu. When the valid password is entered, the main menu appears:

Program Mode Main Menu

1. Program Building Alarms
2. Program Unit Name
3. Adjust Output Voltage
4. Change Password
5. Battery Test Setup
6. Modify Low Battery Time
7. Exit Program Mode

Enter Selection:

7.7.2 Program Building Alarms

This menu provides access to all the functions available in the system configuration mode. If **1** is entered at the prompt, you can program the building alarm functions:

Program Building Alarms

1. Enable/Disable Default Functions
2. Customize Alarm Messages
3. Return to Main Menu

Enter Selection:

7.7.3 Enable/Disable Default Functions

From this menu you may either enable the building alarms for general functions or special functions such as On Generator, Go To Bypass, and Go To UPS. You may also customize the alarm messages from this menu. When **1** is selected from this menu, the following menu is displayed:

```

Enable/Disable Default Functions
1. Enable/Disable Go To Bypass
2. Enable/Disable Go To UPS
3. Enable/Disable On Generator
4. Enable/Disable Building Alarm
5. Return to Program Building Alarms Menu
Enter Selection:

```

If you select entry **1-3** from this menu, the following menu appears:

```

Enable/Disable (Function)
Enabled Building Alarm Number(s)
1 4
Enter E# to Enable Building Alarm Number #
Enter D# to Disable Building Alarm Number #
Enter <CR> for No Change
Enter Selection:

```

Where (*Function*) indicates the function the building alarm is being programmed for. The line following the Enabled Building Alarm Number(s) label indicates which building alarms are currently enabled for the function. (In this example, Building Alarms 1 and 4 are enabled.) A building alarm can only be programmed for one special function at a time from these menus. Enabling a building alarm for a special function automatically enables the alarm. If you disable a special function, the building alarm is also disabled.

If you select entry **4** from this menu, the following menu appears:

```

Enable/Disable Building Alarm
Enabled Building Alarm Number(s)
1 4
Enter E# to Enable Building Alarm Number #
Enter D# to Disable Building Alarm Number #
Enter <CR> for No Change
Enter Selection:

```

The line following the Enabled Building Alarm Number(s) label indicates which building alarms are currently enabled. (In this example, Building Alarms 1 and 4 are enabled.)

7.7.4 Customize Alarm Messages

If **Customize Alarm Messages** is selected from the Program Building Alarm menu, you can select a custom message for a building alarm or disable a previously enabled building alarm custom message. When this entry is selected, the following menu is displayed:

```
Customize Alarm Messages
Enabled on Building Alarm Number(s)
2 3
Enter Building Alarm Number:
```

This example indicates that there are custom messages enabled for Building Alarms 2 and 3. When a building alarm number is entered, the message being used by the software is displayed (either a custom message or the default message indicated by the list of enabled custom messages). If **1** was entered at the prompt, the following text appears:

```
Building Alarm Active Message: Building Alarm 1 (default
message)
Enter New Message or <CR> for No Change:
```

At this level you can enter a custom message, 30 characters maximum, to display when Building Alarm 1 is activated. If a custom message is entered to activate the building alarm, a custom message should also be entered to deactivate. After the message or a carriage return is entered, the following is displayed:

```
Building Alarm Clear Message: Clear Building Alarm 1
(default message)
Enter New Message or <CR> for No Change:
```

At this prompt, the user should enter the custom message for the building alarm deactivation state. When a message or a carriage return is entered, the following text appears:

```
Enter E to Enable Custom Message
Enter D to Disable Custom Message
Enter <CR> for No Change
Enter Selection:
```

If an **E** is entered at the prompt, the custom messages are used for the building alarm. If a **D** is entered, the default messages are used for the building alarm.

7.7.5 Program Unit Name

If **Program Unit Name** is selected from the main menu, the following is displayed:

```

Program Unit Name
Unit Name:
Enter New Name or <CR> No Change:

```



NOTE *Unit Name is 45 characters maximum.*

The current unit name is displayed on the second line of the display and in the headers of prints from Terminal mode. If a change is desired, the new unit name should be entered at the prompt. The unit name is 45 characters maximum and includes spaces and any punctuation. If the user wants to center the text portion of the name, the appropriate number of leading spaces should be included when entered.

7.7.6 Adjust Output Voltage

If **Adjust Output Voltage** is selected from the main menu, the following menu is displayed:

```

Adjust Output Voltage
Output Voltage Setup:  480
Output Voltage Range: 456 - 504
Enter Desired Output Voltage Setup:

```

The output voltage desired can then be entered or a carriage return for no change. Only values within the range are accepted.

7.7.7 Change Password

If **Change Password** is selected from the main menu, the following menu is displayed:

```

Change Password
Enter New Password:
Verify New Password:

```



NOTE *Password must be six characters in length.*

<CR> to return with no change.

The password changes if the user enters and verifies the password. The entry must be six characters.

7.7.8 Battery Test Setup

If **Battery Test Setup** is selected from the main menu, the following menu is displayed:

```
Battery Test Setup
1. Setup One-time Delayed Battery Test
2. Setup Monthly Battery Test
3. Setup Quarterly Battery Test
4. Cancel Pending Battery Test
5. Display Next Scheduled Battery Test
6. Return to Main Menu
Enter Selection:
```

This menu allows you to schedule, review schedule, or cancel pending battery tests. The following menu is displayed when 1-3 is selected:

```
Enter Starting Month (1-12):
Enter Day of Week, Sunday = 1, (1-7):
Enter Week of Month (1-5):
Enter Hour of Test (0-23):
Enter Minute of Test (0-59):
```



NOTE Press <ENTER> after each entry.

```
<CR> with no entry will return to Battery Test Setup
Menu.
```

Enter the information at the prompt with a carriage return to schedule the battery test.

If entry **4** is selected from the Battery Test Setup menu, you are prompted to enter “Y” to cancel all pending tests. This selection cancels only pending tests and does not stop a test currently in progress.

If entry **5** is selected from the Battery Test Setup menu, and if a Battery Test is scheduled, the following menu is displayed:

```
Next Battery Test Scheduled
WK DAY MON HR:MN
4 FRI MAR 15:34
```



NOTE Press <ENTER> to return to the Battery Test Setup Menu.

If entry **5** is selected and there are no tests scheduled, the following text appears:

```
No Battery Test Scheduled
Enter <CR> to return to Battery Test Setup Menu
```



NOTE The UPS performs only one battery test in any 24-hour period.

7.7.9 Modify Low Battery Time

This menu allows you to modify the low battery time warning. When selected, the following menu is displayed:

```

Modify Low Battery Time
Low Battery Time (Minutes):  004
Enter New Low Battery Time:

```



NOTE *Low Battery Time should be no greater than 999. Press <ENTER> to return with no change.*

Enter the new time desired to change the warning level.

7.8 Calibration Mode

Calibration mode is used by factory and field service personnel to calibrate system meters. Factory test engineers calibrate the UPS meters prior to shipping so the UPS arrives at your site correctly calibrated. After use, field service personnel may need to use Calibration mode to recalibrate one or more meter settings.



NOTE *Calibration mode is for use by service personnel ONLY. To prevent inadvertent modification, this mode can be accessed only by trained personnel.*

7.9 Computer Mode

This mode provides a computer interface which gives your system compatibility with system monitoring and network products. For a list of products available, contact your sales representative.

7.10 Remote Monitor Mode

This mode provides the interface for the RMP, RIM, or SCM described earlier.

7.11 Remote Notification



NOTE *The X-Slot communication bay is connected internally to the DB-25 port by default; the DB-25 is disabled for other uses. Contact your Eaton service representative to purchase, install, and set up an external modem or an internal X-Slot Modem Card.*

NOTE *Refer to the service documentation for detailed Remote Notification information.*

For connection and setup of a modem or to enable Remote Notify features within the UPS, please contact Powerware (see page 1-2).

Remote Notification provides the UPS with the capability to use a standard off-the-shelf PC modem as a telephone interface. The features provided by this option are as follows:

- ▶ Call a remote terminal or pager based on programmable events and alarms.
- ▶ Four separate, programmable notification groups (phone numbers).
- ▶ Automatic answering (user-configurable) for access to the Terminal mode of the UPS.
- ▶ Remote and local ability to clear Call Out alarms and events.
- ▶ Error detection and correction for misconfigured and disconnected modems.

Remote Notification provides the user with the option of receiving alarms and notices at a remote location. Using the Terminal mode, the user calls the UPS to perform basic monitoring. In the event of a UPS alarm or notice, the user is notified at the remote location. The UPS calls through the modem to the user's computer or pager and leaves a message.

Remote Notification is an extension of the Terminal mode with the additional support algorithms necessary to control an external modem. Connection to the UPS is made when a user calls the UPS on the phone. The user has exactly the same capabilities as if using a terminal connected directly to the UPS RS-232 port.

Remote Notification differs from the basic Terminal mode with the addition the following functions:

- ▶ Call Answer – The Call Answer function allows the user to call into the UPS from a remote location and enter Terminal mode.
- ▶ Call Out – The Call Out function allows the UPS to be configured to call either a remote computer or numeric paging service over the phone line. Call Out allows the UPS to call a remote computer and leave a one-line descriptive message of the alarm or notice condition. Numeric paging support allows the UPS to call a paging service and send numeric messages.
- ▶ Housekeeping – The Housekeeping function maintains the link between the UPS and modem.

This page intentionally left blank.

Chapter 8 | Maintaining the UPS System



WARNING

Only qualified service personnel (such as a licensed electrician) should perform the battery installation and maintenance. Risk of electrical shock.

The components inside the UPS cabinet are secured to a sturdy metal frame that is supported by the UPS magnetics. This design allows authorized service personnel to remove repairable components with very little disassembly. All repairable parts and assemblies are located in the front of the UPS, allowing all routine maintenance and servicing to be performed with front panel access.

You must schedule periodic performance checks of your UPS to keep it running properly. Regular routine checks of operation and system parameters will enable your UPS system to function efficiently for many trouble-free years.

8.1 Important Safety Instructions

Remember that your UPS is designed to supply power **EVEN WHEN DISCONNECTED FROM THE UTILITY POWER**. The UPS interior is unsafe until the DC power source is disconnected and the electrolytic capacitors are discharged. After disconnecting the utility power and the DC power, authorized service personnel should wait at least five minutes before attempting internal access to the UPS system.



WARNING

- ▶ Batteries can present a risk of electrical shock or burn from high short-circuit current. The following precautions should be observed: 1) Remove watches, rings, or other metal objects; 2) Use tools with insulated handles; 3) Do not lay tools or metal parts on top of batteries.
- ▶ **ELECTRIC ENERGY HAZARD.** Do not attempt to alter any battery wiring or connectors. Attempting to alter wiring can cause injury.
- ▶ Replace batteries with the same number and type of batteries as originally installed in the UPS.
- ▶ **LETHAL VOLTAGE PRESENT.** This UPS should not be operated with the cabinet doors open or protective panels removed. Do not make any assumptions about the electrical state of any cabinet in the UPS system.
- ▶ If the battery cabinet requiring service was not provided by the UPS manufacturer, refer to the battery cabinet manufacturer's operating manual for instructions on battery cabinet installation and maintenance, or contact your Eaton service representative.

WARNING



- ▶ Do not dispose of the battery or batteries in a fire. Batteries may explode. Proper disposal of batteries is required. Refer to your local codes for disposal requirements.
- ▶ Do not open or mutilate the battery or batteries. Released electrolyte is harmful to the skin and eyes. It may be toxic.

CAUTION



Do not discard the UPS or the UPS batteries in the trash. This product contains sealed, lead-acid batteries and must be disposed of properly. For more information, contact your local recycling or hazardous waste center.

AVERTISSEMENT!



Une batterie peut présenter un risque de choc électrique, de brûlure, ou d'incendie. Suivre les précautions qui s'imposent.

- ▶ Pour le remplacement, utiliser le même nombre et modèle des batteries.
- ▶ L'élimination des batteries est réglementée. Consulter les codes locaux à cet effet.

8.2 Performing Preventive Maintenance

The UPS requires very little preventive maintenance. However, the UPS should be inspected periodically to verify that it is operating normally and that the batteries are in good condition.

Perform the following checks DAILY:

- ▶ Check the area surrounding the UPS. Ensure the area is not cluttered, allowing free access to the UPS.
- ▶ Ensure the air intakes (vents on the front doors) and exhaust opening (on top of the UPS cabinet) are not blocked.
- ▶ Ensure the operating environment is within the parameters specified in Chapter 9, "Product Specifications."
- ▶ Ensure the UPS is in Normal mode (Normal status indicator is lit). If an alarm lamp is lit or the Normal status indicator is not lit, contact your Eaton service representative.

Perform the following checks MONTHLY:

- ▶ Ensure all status indicator lamps are operative. (Press the \uparrow and \downarrow buttons simultaneously to test the lamps.)
- ▶ Monitor system parameters as described in Chapter 5, "Using the Monitor Panel."
- ▶ Check the air filters (located behind the front doors) and replace them as necessary (the filter size is 16" × 20" × 1").
- ▶ Record the results of your checks and any corrective actions in a suitable log.

ANNUAL maintenance - Annual preventive maintenance should be performed only by authorized service personnel familiar with maintenance and servicing of the UPS system. Contact your nearest field service office for more information about service offerings.

BATTERY maintenance - Contact your nearest field service office for battery maintenance. Battery replacement and maintenance should be performed only by authorized service personnel.

8.3 Maintenance Training

A basic training course, available from Powerware, gives you a competent working knowledge of UPS operation and teaches you how to perform first level corrective maintenance. For more information about training and other services, contact the Eaton Help Desk for Powerware products (see page 1-2).

This page intentionally left blank.

Chapter 9 | Product Specifications

The UPS systems are housed in freestanding, double-front cabinets with safety shields behind the doors. The UPS systems are available in 50/60 Hz with various output power ratings. Smaller models within a system may be upgraded in the field to larger models:

Table 9-1. Model Numbers

| System | Models | Notes |
|--------------------|-----------------|-----------------------------|
| Powerware 9315 300 | 225 and 300 kVA | 60 Hz only |
| Powerware 9315 250 | 200 and 250 kVA | 50/60 Hz (400V models only) |
| Powerware 9315 225 | 225 kVA | 60 Hz only |
| Powerware 9315 200 | 200 kVA | 50/60 Hz (400V models only) |

The following sections detail the input, output, environmental, and battery specifications for the UPS.

Table 9-2. System Input

| | |
|---|---|
| Operating Input Voltage (Nominal +10/–15%) | 480 Vac for operation from 408 Vac to 528 Vac (60 Hz only) 400 Vac for operation from 340 Vac to 440 Vac (50/60 Hz only) 600 Vac for operation from 510 Vac to 660 Vac (60 Hz only) |
| Operating Input Frequency Range | ± 3 Hz of nominal (50 Hz or 60 Hz) |
| Operating Input Current | <p>Battery Charge 125% of full load for overload + battery charge Actual load + 25% of full load for battery charge with 0.8 pF output units</p> <p>115% of full load for overload + battery charge Actual load + 15% of full load for battery charge with 0.9 pF output units</p> <p>Reduced for Generator Adjustable, set to 102%</p> |
| Input Current Harmonic Content | 10% THD at full load (with input filter option installed) |
| Power Walk-In | Adjustable 3–60 second rectifier ramp-up to full utility load |
| Power Factor | Minimum 0.95 |
| Line Surges | 6 kV OC, 3 kA SC per ANSI 62.41 and IEC 801-4 |

Table 9-3. System Output

| | |
|---|--|
| Rectifier/Charger Capacity | 125% |
| DC Filtering | Ripple voltage less than 0.5% peak to peak |
| UPS Output Capacity | 100% rated current |
| Output Voltage Regulation | 1% (10% to 100% load) |
| Output Voltage Adjustment (Nominal +/-5%) | 208 Vac nominal, adjustable from 198 Vac to 218 Vac (60 Hz only) 480 Vac nominal, adjustable from 456 Vac to 504 Vac (60 Hz only) 600 Vac nominal, adjustable from 570 Vac to 630 Vac (60 Hz only) 400 Vac nominal, adjustable from 380 Vac to 420 Vac (50/60 Hz) |
| Output Voltage Harmonic Content | 3% max THD, 2% max single (linear load) |
| Output Voltage Balance | 3% for 100% maximum load imbalance |
| Output Voltage Phase Displacement | 3° for 100% maximum load imbalance |
| Output Transients | ± 5% for 100% load step or removal |
| Frequency Regulation | ± 0.01 Hz free running |
| Synchronous to Bypass | Bypass within voltage limits of +5%, -8% of output setting; bypass within ±0.5 Hz |
| Frequency Slew Rate | 1 Hz per second maximum (adjustable) |
| Overload Capability | 125% for 10 minutes 150% for 10 seconds |
| Maximum Output Capability | 300% peak for 10 cycles without bypass |

Table 9-4. Environmental Specifications

| | |
|---|---|
| Operating Temperature | 0 to 40°C without derating. However, operating at or near 40°C will adversely affect battery life (refer to your battery specifications for more information). The recommended operating temperature is 25°C. |
| Operating Altitude | Maximum 1500m (5000 ft) at 40°C without derating |
| Storage Temperature | -20 to +70°C (prolonged storage above 40°C will cause rapid battery self-discharge) |
| Relative Humidity (operating and storage) | 95% maximum noncondensing |
| Acoustical Noise | 65 dBA at a 1m distance |
| EMI Suppression | Meets FCC Regulation 47, Part 15, Subpart J, for class A devices |
| Electrostatic Discharge (ESD) Immunity | Meets IEC 801-2 specifications. Withstands up to 25 kV without damage and with no disturbance or adverse effect to the critical load. |

These specifications are for batteries supplied by the UPS manufacturer in line-up-and-match cabinets:

Table 9-5. Battery Specifications

| | |
|--------------------------------|--|
| Battery Type | Sealed, maintenance-free, high rate discharge, lead-acid cells |
| Nominal Battery String Voltage | 480 Vdc (240 cells) for Powerware 9315 225 and Powerware 9315 300 420 Vdc (210 cells) for Powerware 9315 200 and Powerware 9315 250 |
| Float Charging | 2.25 Vdc per cell (540 Vdc based on 240 cells) (470 Vdc based on 210 cells) |
| Equalizing Charge | 2.40 Vdc per cell, set to 2.25 Vdc at factory |
| Battery Charge Current Limit | Limited to 25% of full, regardless of actual load on inverter |

This page intentionally left blank.

When the UPS system is running in Normal mode, it continually monitors itself and the incoming utility power. In Battery or Bypass modes, the UPS may issue alarms to let you know exactly what event caused the change from Normal mode. System events can be indicated by horns, lights on the UPS, or both.

Select **Active** from the Events menu on the LCD screen to look at the Active System Events screen. This screen shows any currently active alarms, notices, or commands.

10.1 System Event Horns

The system event horn beeps according to the type of event it is signifying:

- ▶ When the UPS detects an alarm that requires your attention, the horn beeps at ½-second intervals.
- ▶ When a notice occurs, the horn beeps at 2-second intervals.

10.2 System Event Lights

The status indicators on the UPS Monitor Panel work in conjunction with the event horn to let you know when the UPS is operating in any mode other than Normal. Only the Normal indicator is visible during normal UPS operation. The others light to indicate alarms or events. When an alarm occurs, you should first check these indicators to see what type of event has taken place. (For descriptions of the status indicators, see “Reading the Status Indicators” on page 5-4.)

10.3 System Event Messages

When a system event occurs, a message is added to the Event History Log. A message may also appear on the Monitor Panel of the UPS. The Event History Log contains all system event messages, whether or not they were displayed on the Monitor Panel.

| INVERTER MESSAGES - ALARMS | INVERTER MESSAGES - NOTICES |
|--|--|
| Inverter DC Over Voltage Clear Inverter DC Over Voltage | Bypass AC Over Voltage Clear Bypass AC Over Voltage |
| Inverter AC Over Voltage Clear Inverter AC Over Voltage | Bypass AC Under Voltage Clear Bypass AC Under Voltage |
| Inverter AC Under Voltage Clear Inverter AC Under Voltage | Bypass Over Frequency Clear Bypass Over Frequency |
| Inverter Over Frequency Clear Inverter Over Frequency | Bypass Under Frequency Clear Bypass Under Frequency |
| Inverter Under Frequency Clear Inverter Under Frequency | Battery DC Under Voltage Clear Battery DC Under Voltage |

| INVERTER MESSAGES - ALARMS | INVERTER MESSAGES - NOTICES |
|---|---|
| Over Temperature Shutdown | Battery Not Charged Clear Battery Not Charged |
| 100% Overload Shutdown | Bypass is Not Available Bypass is Available |
| 125% Overload Shutdown | Input Breaker Open |
| Bypass Cont. (K2) Failure | Inv. Logic Power Failure Clear Inv. Logic Pwr Fail. |
| Bypass Cont. (K4) Failure | Phase A Current Limit Phase B Current Limit Phase C Current Limit |
| Bypass Control Failure | Load Transferred to Bypass |
| Inverter Cont. (K3) Failure | |
| Inverter Failure | |
| Load Off | |
| Inverter Cont. (K3) Open | |
| Bypass Cont. (K4) Failure | |
| Bypass Mode Normal Mode | Inverter On Inverter Off |
| Keyswitch On | Bypass Contactor (K2) Closed Bypass Contactor (K2) Open |
| Inverter Commanded On Inverter Commanded Off | Total Battery Discharge |
| | Bypass Contactor (K4) Closed Bypass Contactor (K4) Opened |
| | Input Breaker (CB1) Closed Input Breaker (CB1) Opened |
| | Inverter Contactor (K3) Closed Inverter Contactor (K3) Opened |
| | Inverter Shutdown |
| | Inverter Normal |
| | Load Transferred to Bypass |
| | Auto Mode |

| RECTIFIER MESSAGES - ALARMS | RECTIFIER MESSAGES - NOTICES |
|--|--|
| Rectifier DC Over Voltage Clear Rectifier DC Over Voltage | Input AC Over Voltage Clear Input AC Over Voltage |
| Rectifier DC Under Voltage Clear Rectifier DC Under Voltage | Input AC Under Voltage Clear Input AC Under Voltage |
| Rectifier Over Temperature Clear Rectifier Over Temperature | Input AC Over Frequency Clear Input AC Over Frequency |
| Rct. Over Temperature Warning Clear Rct. Over Temp. Warning | Input AC Under Frequency Clear Input AC Under Frequency |
| Rct. Temp. Sensor Failure Clear Rct. Temp. Sensor Failure | Rct. Logic Pwr Supply OV Clear Rct. Logic Pwr Sply OV |
| Rectifier Failure | Rct. Logic Pwr Supply UV Clear Rct. Logic Pwr Sply UV |
| Rectifier Alarm | Rectifier DC Too Low |
| | Input Voltage Transient |
| | Rct. Logic Pwr Fail. Clear Rct. Logic Pwr Fail. |
| | Battery Current Limit Clear Battery Current Limit |
| | DC Too High |
| RECTIFIER MESSAGES - COMMANDS | RECTIFIER STATUS MESSAGES |
| Rectifier Commanded On Rectifier Commanded Off | Rectifier On Rectifier Off |
| | Rectifier Shutdown |

| MONITOR PANEL ALARMS | MONITOR PANEL NOTICES |
|--|--|
| Load Over 100% Clear Load Over 100% | Output AC Over Voltage Clear Output AC Over Voltage |
| Overload 100% Clear Overload 100% | Output AC Under Voltage Clear Output AC Under Voltage |
| Overload 125% Clear Overload 125% | Output Over Freq. Clear Output Over Freq. |
| Power Supply Failure Clear Power Supply Fail. | Output Under Frequency Clear Output Under Frequency |
| Fan Failure Clear Fan Failure | 3W AC Over Voltage Clear 3W AC Over Voltage |
| | 3W AC Under Voltage Clear 3W AC Under Voltage |
| | 3W Over Frequency Clear 3W Over Frequency |
| | 3W Under Frequency Clear 3W Under Frequency |
| | Power Fail Clear Power Fail |
| | Power Off Switch |
| | Building Alarm 1 Clear Building Alarm 1 |
| | Building Alarm 2 Clear Building Alarm 2 |
| | Building Alarm 3 Clear Building Alarm 3 |
| | Building Alarm 4 Clear Building Alarm 4 |
| | Building Alarm 5 Clear Building Alarm 5 |
| | Building Alarm 6 Clear Building Alarm 6 |
| | Rectifier Network Down Rectifier Network Clear |
| | Inverter Network Down Inverter Network Clear |
| | Monitor Network Down Monitor Network Clear |

Chapter 11 | Using the LOAD OFF Button

Load Off is initiated by the covered, red LOAD OFF button on the Monitor Panel. This button is protected by a clear plastic shield to prevent accidental activation. In an emergency, you can press this button to instantaneously open the input breaker and interrupt UPS output. The UPS is cut off from utility power, and the critical load is de-energized. All power to the critical load is lost. The UPS (including Bypass) remains locked off until you reset the LOAD OFF button.

WARNING



All power to the critical load is lost when you press this button. You should use this feature only in an emergency or when you want to de-energize the critical load.

To restart the UPS after pressing the LOAD OFF button, follow the procedure “Resetting the UPS System after Load Off” on page 11-2 before starting the UPS.



NOTE *The Remote Emergency Load Off option functions the same way as the LOAD OFF button on the Monitor Panel.*

11.1 Using the LOAD OFF Button

1. Raise the clear plastic shield covering the red LOAD OFF button on the Monitor Panel.
2. Press the LOAD OFF button.

The breaker and contactors open (you can hear them opening). The CB1 switch trips, and the Load Off PUSH TO RESET button on the UPS Control Panel pops out. The UPS system shuts down.

WARNING



Power is present inside the UPS cabinet until the upstream input feeder circuit breaker is opened.

11.2 Resetting the UPS System after Load Off



CAUTION

Do not attempt to restart the system after Load Off until the cause of the emergency has been identified and cleared.

The Load Off PUSH TO RESET button is a small white button on the UPS Control Panel. The PUSH TO RESET button pops out and the CB1 switch trips when the LOAD OFF button on the Monitor Panel is activated.

To reset the UPS system:

1. Press the Load Off PUSH TO RESET button until it clicks in and remains recessed.
2. Move the CB1 switch from the center (tripped) position to OFF. The switch should be difficult to move from the TRIPPED position.
3. The UPS system is now reset. To restart the UPS system, follow the procedure in Chapter 4, “Starting and Stopping the UPS.”

Warranty

LIMITED FACTORY WARRANTY FOR THREE-PHASE POWERWARE® PRODUCTS

WARRANTOR: The warrantor for the limited warranties set forth herein is Eaton Electrical Inc., a Delaware Corporation (“Eaton”).

LIMITED WARRANTY: This limited warranty (this “Warranty”) applies only to the original end-user (the “End-User”) of the Powerware Three-Phase UPS Products (the “Product”) and cannot be transferred. This Warranty applies even in the event that the Product is initially sold by Eaton for resale to an End-User.

LIMITED WARRANTY PERIOD: The period covered by this Warranty for Product installed [and currently located] in the fifty (50) United States and the District of Columbia is twelve (12) months from the date of Product start-up or eighteen (18) months from the date of Product shipment, whichever occurs first, for parts coverage and 90 days from the date of Product start-up for labor coverage. The period covered by this Warranty for Product installed [and currently located] outside of the fifty (50) United States and the District of Columbia is twelve (12) months from the date of Product start-up or eighteen (18) months from the date of Product shipment, whichever occurs first, for parts coverage.

WHAT THIS LIMITED WARRANTY COVERS: The warrantor warrants that the Powerware three-phase UPS electronics, Eaton-built accessories, and Powerware-built battery cabinets (individually and collectively, the “Warranted Items”) are free from defects in material and workmanship. If, in the opinion of Eaton, a Warranted Item is defective and the defect is within the terms of this Warranty, Eaton’s sole obligation will be to repair or replace such defective item (including by providing service, parts, and labor, as applicable), at the option of Eaton. The Warranted Item will be repaired or replaced onsite at the End-User’s location or such other location as determined by Eaton. Any parts that are replaced may be new or reconditioned. All parts replaced by Eaton shall become the property of Eaton.

WHAT THIS LIMITED WARRANTY DOES NOT COVER: This Warranty does not cover any defects or damages caused by: (a) failure to properly store the Product before installation, including the “trickle charge” of batteries no later than the date indicated on the packaging; (b) shipping and delivery of the Product if shipping is FOB Factory; (c) neglect, accident, abuse, misuse, misapplication, incorrect installation; (d) repair or alteration not authorized in writing by Eaton personnel or performed by an authorized Eaton Customer Service Engineer or Agent; or (e) improper testing, operation, maintenance, adjustment, or any modification of any kind not authorized in writing by Eaton personnel or performed by an authorized Eaton Customer Service Engineer or Agent.

This Warranty is not valid: (a) unless an authorized Eaton Customer Service Engineer (in the USA) or Agent (outside of the USA) performs startup and commissioning of the Product; (b) if the Product is moved to a new location by someone other than an authorized Eaton Customer Service Engineer (in the USA) or Agent (outside of the USA); or (c) if the Product’s serial numbers have been removed or are illegible. Any Warranted Items repaired or replaced pursuant to this Warranty will be warranted for the remaining portion of the original Warranty subject to all the terms thereof. Labor warranty is not provided for Product located outside of the fifty (50) United States or the District of Columbia. **Any equipment, parts, or materials included in the Product and not manufactured by Eaton are warranted solely by the manufacturer of such equipment, parts, or materials and are not included as part of this Warranty. Batteries are not warranted by Eaton.**

THIS WARRANTY IS THE END-USER’S SOLE REMEDY AND IS EXPRESSLY IN LIEU OF, AND THERE ARE NO OTHER EXPRESSED OR IMPLIED GUARANTEES OR WARRANTIES (INCLUDING ANY IMPLIED WARRANTY OF MERCHANTABILITY OR FITNESS FOR ANY PURPOSE, WHICH ARE EXPRESSLY DISCLAIMED).

LIMITATION OF LIABILITY: In no event shall Eaton be liable for any indirect, incidental, special, or consequential damages of any kind or type whatsoever, or based on any claim or cause of action, however denominated. Eaton shall not be responsible for failure to provide service or parts due to causes beyond Eaton’s reasonable control. In no case will Eaton’s liability under this Warranty exceed the replacement value of the Warranted Items.

END-USER’S OBLIGATIONS: In order to receive the benefits of this Warranty, the End-User must use the Product in a normal way, follow the Product’s operation and maintenance manual, and protect against further damage to the Product if there is a covered defect.

OTHER LIMITATIONS: Eaton’s obligations under this Warranty are expressly conditioned upon receipt by Eaton of all payments due to it (including interest charges, if any). During such time as Eaton has not received payment of any amount due to it for the Product, in accordance with the contract terms under which the Product is sold, Eaton shall have no obligation under this Warranty. Also during such time, the period of this Warranty shall continue to run and the expiration of this Warranty shall not be extended upon payment of any overdue or unpaid amounts.

COSTS NOT RELATED TO WARRANTY: The End-User shall be invoiced for, and shall pay for, all services not expressly provided for by the terms of this Warranty, including without limitation site calls involving an inspection that determines no corrective maintenance is required. Any costs for replacement equipment, installation, materials, freight charges, travel expenses, or labor of Eaton representatives outside the terms of this Warranty will be borne by the End-User.

OBTAINING WARRANTY SERVICE: In the USA, call the Eaton Customer Reliability Center 7x24 at 800-843-9433. Outside of the USA, call your local Eaton sales or service representative, or call the Eaton Customer Reliability Center in the USA at 919-870-3028. For comments or questions about this Limited Factory Warranty, write to the Customer Quality Representative, 3301 Spring Forest Road, Raleigh, North Carolina 27616 USA.

This page intentionally left blank.



164201036 F

Free Manuals Download Website

<http://myh66.com>

<http://usermanuals.us>

<http://www.somanuals.com>

<http://www.4manuals.cc>

<http://www.manual-lib.com>

<http://www.404manual.com>

<http://www.luxmanual.com>

<http://aubethermostatmanual.com>

Golf course search by state

<http://golfingnear.com>

Email search by domain

<http://emailbydomain.com>

Auto manuals search

<http://auto.somanuals.com>

TV manuals search

<http://tv.somanuals.com>