



# POWER BLOWER

## *Operator's Manual*

**MODEL Type 1E**

**PB-2100**

**Serial Number 001001 & Up**



### **WARNING**



The engine exhaust from this product contains chemicals known to the State of California to cause cancer, birth defects or other reproductive harm.

### **WARNING DANGER**

Read rules for safe operation and all instructions carefully. ECHO provides this Operator's Manual which must be read and understood for proper and safe operation.

**WARNING**  **DANGER**

Read rules for safe operation and instructions carefully. ECHO provides this Operator's Manual which must be read and understood for proper and safe operation.

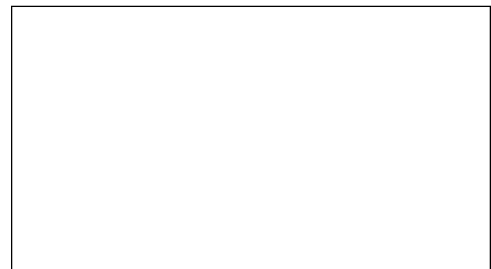

## **TABLE OF CONTENTS**

Introduction

## MANUAL SAFETY SYMBOLS AND IMPORTANT INFORMATION

Throughout this manual and on the product itself, you will find safety alerts and helpful, information messages preceded by symbols or key words. The following is an explanation of those symbols and key words and what they mean to you.



This symbol accompanied by the words **WARNING** and **DANGER** calls attention to an act or condition that can lead to serious personal injury to operator and bystanders.



The circle with the slash symbol means whatever is shown within the circle is prohibited.



**IMPORTANT**



**NOTE**

**IMPORTANT** The enclosed message provides information necessary for the protection of the unit.

**NOTE** This enclosed message provides tips for use, care and maintenance of the unit.

## SAFETY

### GENERAL DESCRIPTION





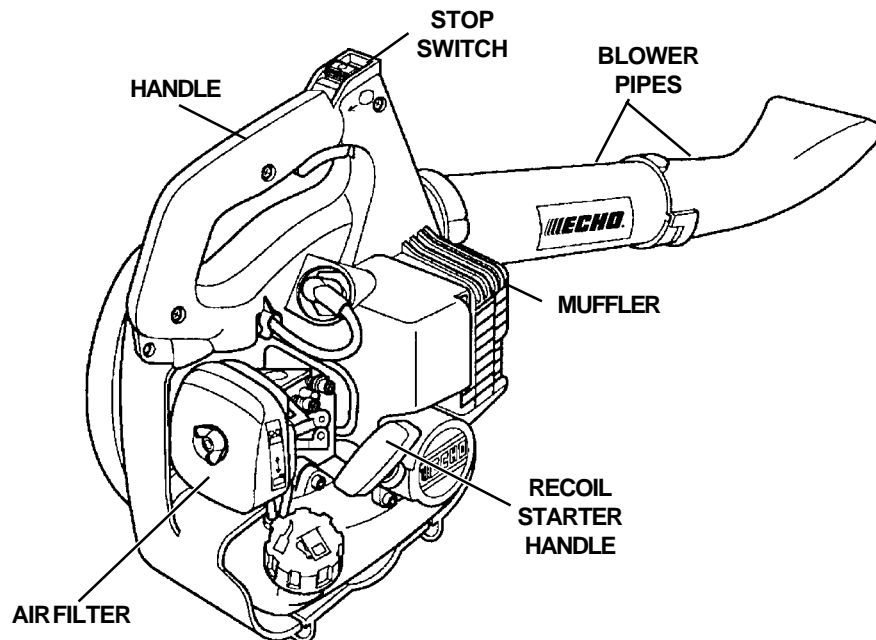

#### **IMPORTANT**

See Description and Specification sections and Decals in this section for full description and illustration of power head, and blower assembly.





## INTERNATIONAL SYMBOLS

Symbol form/shape	Symbol description/application	Symbol form/shape	Symbol description/application
	"WARNING, SEE OPERATOR'S MANUAL"		Hot Surface
	Wear eyes, ears and head protection		Fuel and oil mixture
	Finger Severing		Emergency stop

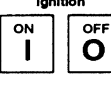
Symbol form/shape	Symbol description/application	Symbol form/shape	Symbol description/application
<b>H</b>	Carburetor adjustment - High speed mixture		Primer Bulb
<b>T</b>	Carburetor adjustment - Idle speed	<b>Ignition</b> 	Ignition ON/OFF
<b>L</b>	Carburetor adjustment - Low speed mixture		

## EQUIPMENT

Before operation a complete check of the unit must be performed:

- Check unit for loose/missing nuts, bolts and screws. Tighten and/or replace as needed.
- Inspect fuel lines, tank and area around carburetor for fuel leaks. **DO NOT** operate unit if leaks are found.

### *Spark Arrestor Muffler*

- The spark arrestor muffler controls the exhaust noise and prevents hot, glowing particles of carbon from leaving the muffler. Make sure the spark arrestor screen is in good repair and properly seated in the muffler. (Refer to Exhaust System Maintenance pg. 19.)

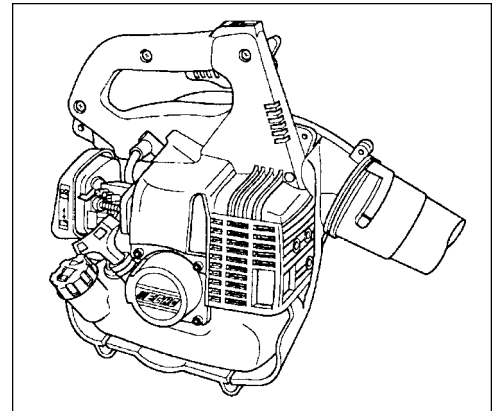

### *Parts*

- Do not use blower if any part is missing or damaged.
- Have repairs done only by an authorized ECHO Service dealer.
- Do not use any attachment, accessory or replacement part unless it is recommended in this Operator's Manual.

**ATTACHMENTS  
AND  
ACCESSORIES**

## FUEL

### WARNING DANGER

Fuel is **VERY** flammable. Use extreme care when mixing, storing or handling or serious personal injury may result.

- Use an approved fuel container.
- **DO NOT** smoke near fuel.
- **DO NOT** allow flames or sparks near fuel.
- Fuel tanks/cans may be under pressure. Always loosen fuel caps slowly allowing pressure to equalize.
- **NEVER** refuel a unit when the engine is **HOT!**
- **NEVER** refuel a unit with the engine running.
- **DO NOT** fill fuel tanks indoors. **ALWAYS** fill fuel tanks outdoors over bare ground.
- Securely tighten fuel cap after refueling.
- Inspect for fuel leakage. If fuel leakage is found, do not start or operate unit until leakage is repaired.



### After Refueling:

- Wipe any spilled fuel from the unit.
- Move at least 3M (10 ft.) from refueling location before starting the engine.

### After use:

- DO NOT store a unit with fuel in its tank. Leaks can occur. Return unused fuel to an approved fuel storage container.

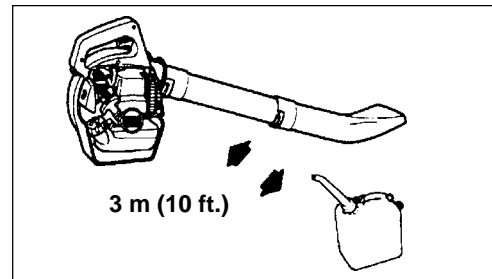

## PERSONAL CONDITION & SAFETY EQUIPMENT

### WARNING DANGER

Power Blower users risk injury to themselves and others if the power blower is used improperly and or safety precautions are not followed. Proper clothing and safety gear must be worn when operating a blower.

### *Physical Condition --*

Your judgment and physical dexterity may not be good:

- if you are tired or sick,
- if you are taking medication,
- if you have taken alcohol or drugs.

Operate unit only if you are physically and mentally well.



### *Eye Protection --*

Wear eye protection meeting ANSI Z87.1 or CE requirements whenever you operate the blower/Shred 'N' Vac.



### *Hand Protection --*

Wear no-slip, heavy duty work gloves to improve your grip on the blower/shred 'n' vac handle. Gloves also reduce the transmission of machine vibration to your hands.

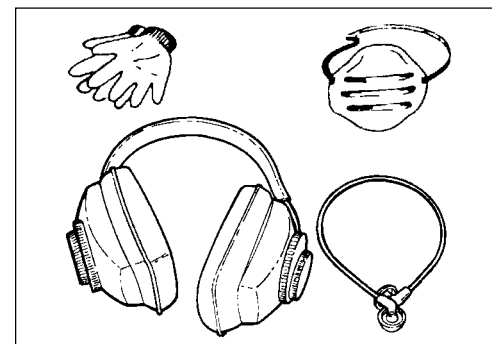

### *Breathing Protection --*

Wear a face mask to protect against dust.

### *Hearing Protection --*

ECHO recommends wearing hearing protection whenever unit is used.

## **Proper Clothing --**

Wear snug fitting, durable clothing.

- Pants should have long legs, shirts with long sleeves.
- **DO NOT WEAR SHORTS,**
- **DO NOT WEAR TIES, SCARVES, JEWELRY.**

Wear sturdy work shoes or boots with non-skid soles;

- **DO NOT WEAR OPEN TOED SHOES,**
- **DO NOT OPERATE UNIT BAREFOOTED.**



## **Hot Humid Weather --**

Heavy protective clothing can increase operator fatigue which may lead to heat stroke. Schedule heavy work for early morning or late afternoon hours when temperatures are cooler.

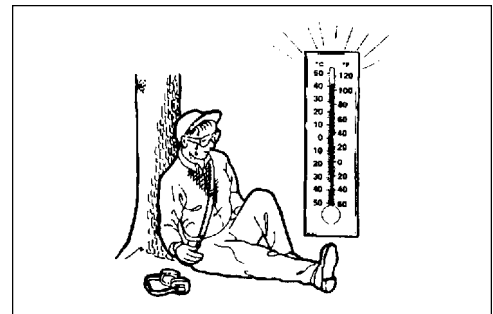

## **SAFE OPERATION**

### **Determine Operation Area --**

- Provide all operators of this equipment with the Operator's Manual, and instructions for safe operation.
- Do not operate this product indoors or in inadequately ventilated areas.
- Review area to be cleared. Look for potential hazards that could contribute to unsafe conditions.
- Spectators and fellow workers must be warned, and children and animals prevented from coming nearer than 15M (50 ft.) while the blower is in use.
- Take wind conditions into account: avoid open doors and windows.

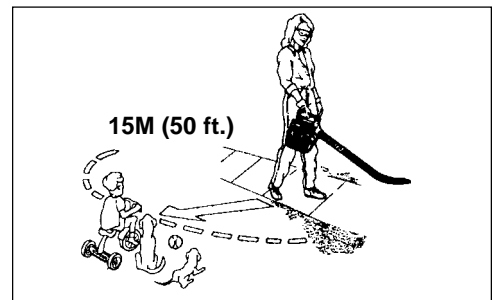

### **Use Proper Clothing & Equipment**

- Before starting the unit, equip yourself and any other person working within the 15M (50 ft.) Safety Zone with the required Protective Equipment and clothing.
- Start unit on ground with throttle at idle. Check that blower pipe is not blocked by the ground or by any objects.
- Do not point blower at people or animals.

### **Keep A Firm Grip**

- Hold handle with fingers together encircling the handle.

### **Keep A Solid Stance**

- Maintain footing and balance at all times. Do not stand on slippery, uneven or unstable surfaces. Do not work in odd positions or on ladders. Do not overreach.
- Do not perform Maintenance or Assembly procedures with engine running.

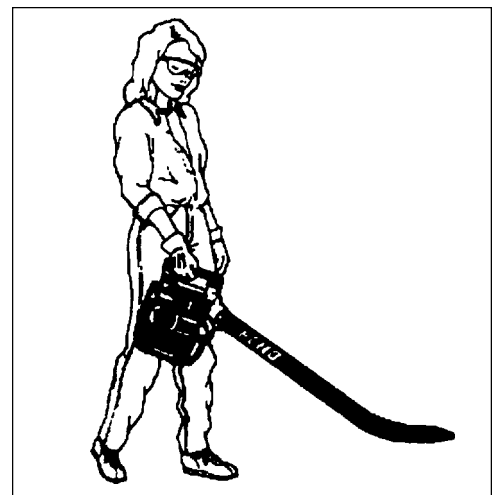

## Noise Control

- Follow local noise regulations on sound levels and hours of operations. Use only during appropriate hours.
- Never use a higher speed setting than necessary to perform a task. The higher the engine speed the louder the blower noise.
- Be a good neighbor.

## Avoid Hot Surfaces

- During operation, the exhaust area may become very hot, too hot to touch. Avoid contact during and immediately after operation.

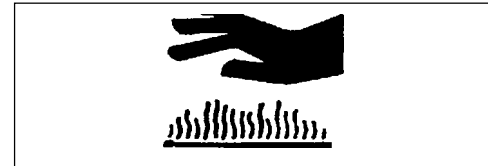
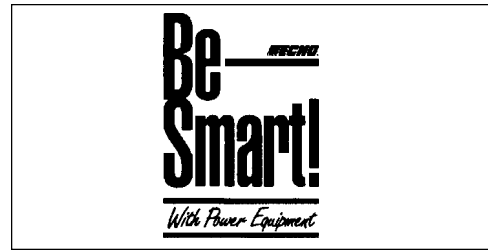

## EXTENDED OPERATION/EXTREME CONDITIONS

### Vibration and Cold --

It is believed that a condition called Raynaud's Phenomenon, which affects the fingers of certain individuals may be brought about by exposure to vibration and cold. Exposure to vibration and cold may cause tingling and burning sensations followed by loss of color and numbness in the fingers. The following precautions are strongly recommended because the minimum exposure which might trigger the ailment is unknown.

- Keep your body warm, especially the head, neck, feet, ankles, hands and wrists.
- Maintain good blood circulation by performing vigorous arm exercises during frequent work breaks and also by not smoking.
- Limit the hours of operation. Try to fill each day with jobs where operating the blower or other hand-held power equipment is not required.
- If you experience discomfort, redness and swelling of the fingers followed by whitening and loss of feeling, consult your physician before further exposing yourself to cold and vibration.

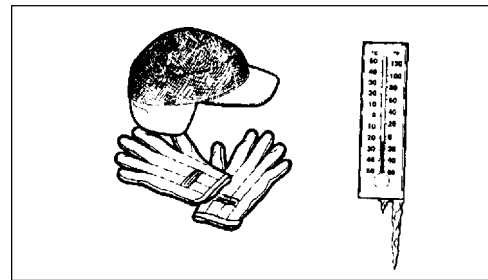

### Repetitive Stress Injuries --

It is believed that overusing the muscles and tendons of the fingers, hands, arms and shoulders may cause soreness, swelling, numbness, weakness and extreme pain in those areas. Certain repetitive hand activities may put you at a high risk for developing a Repetitive Stress Injury (RSI). An extreme RSI condition is Carpal Tunnel Syndrome (CTS), which could occur when your wrist swells and squeezes a vital nerve that runs through the area. Some believe that prolonged exposure to vibration may contribute to CTS. CTS can cause severe pain for months or even years. To reduce the risk of RSI/CTS, do the following:

- Avoid using your wrist in a bent, extended or twisted position. Instead try to maintain a straight wrist position. Also, when grasping, use your whole hand, not just the thumb and index finger.
- Take periodic breaks to minimize repetition and rest your hands.
- Reduce the speed & force in which you do the repetitive movement.
- Do exercises to strengthen the hand and arm muscles.
- Immediately stop using all power equipment and consult a doctor if you feel tingling, numbness or pain in the fingers, hands, wrists or arms. The sooner RSI/CTS is diagnosed, the more likely permanent nerve and muscle damage can be prevented.

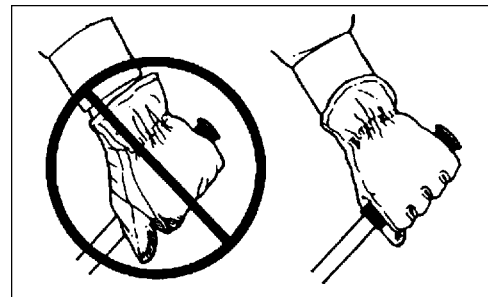



## DESCRIPTION

After opening the carton, check for damage. Immediately notify your retailer or ECHO Dealer of damaged or missing parts. Use the contents list to check for missing parts.

## EMISSION CONTROL

The emission control system for this engine is EM (Engine Modification).

**IMPORTANT ENGINE INFORMATION**  
ENGINE FAMILY : TEH021UB24RA  
DISPLACEMENT : 21.2cc  
THIS ENGINE MEETS U.S. EPA PHI AND 1995 - 1999 CALIFORNIA EMISSION REGULATIONS FOR ULGE ENGINES. REFER TO OWNER'S MANUAL FOR MAINTENANCE SPECIFICATIONS AND ADJUSTMENTS.



**Emission Control Label** located on the engine. (EXAMPLE ONLY, information on label varies by engine FAMILY).

## CONTENTS

- 1- Power Head
- 1- Blower Pipe Assembly
- 1- Plastic Bag
  - 1- Operator's Manual
  - 1- Warranty Registration Card
  - 1- ECHO Emissions and Warranty Statement
- 1- Bottle 2-Stroke Engine Oil

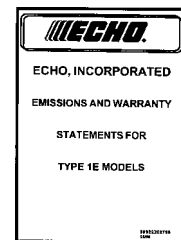
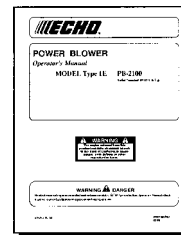

ECHO LIMITED WARRANTY REGISTRATION CARD / TARJETA DE DESCRIPCION DE GARANTIA LIMITADA	
<p>Please Print/Por Favor Escriba Claro y Legible la Informacion                      (Complete in English or Spanish or both) (Completar en Inglés o Español o en ambos)</p>	
<p>Product/Producto: <input type="text"/></p>	
<p>Purchase/Compra: <input type="text"/></p>	<p>Date of Purchase/Fecha de Compra: <input type="text"/></p>
<p>Name/Nombre Where Purchased: <input type="text"/></p>	<p>Dealer/Revendedor (Name and Address): <input type="text"/></p>
<p>Model Number/Numero del Modelo: <input type="text"/></p>	<p>Serial No./Numero de Serie: <input type="text"/></p>
<p>Engine Registration/Registro del Motor: <input type="text"/></p>	<p>Dealer Registration/Registro del Distribuidor: <input type="text"/></p>
<p>Registration, your purchase of this product is subject to the warranty rules of the state of purchase. Read and verify your owner's manual for more information.</p>	
<p>Do not void the seal.</p>	
<p>A. Primary seal of product integrity is the registration. (El sellado primario de integridad del producto es el registro.)                      1) Registration 2) Labeling 3) Professional Dealer seal</p>	
<p>B. Subsequent seal information stated with product? (¿Se indica información de sellado posterior con el producto?)                      1) Operator's Manual 2) Safety glasses                      3) Sealant 4) Spacers</p>	
<p>C. Have you received the ECHO Customer Service Safety Video? (¿Ha visto el video de seguridad para obtener un general video gratuito de mantenimiento?)                      1) Yes 2) No</p>	
<p>TO RECEIVE A COPY OF THE ECHO SAFETY VIDEO, CONTACT WITH THE ECHO CUSTOMER SERVICE SAFETY DEPARTMENT.                      PARA OBTENER UNA COPIA DEL VIDEO DE SEGURIDAD, CONTACTAR CON EL DEPARTAMENTO DE SERVICIO AL CLIENTE DE ECHO INCORPORATED. CONTACTAR CON EL DEPARTAMENTO DE SERVICIO AL CLIENTE DE ECHO INCORPORATED. ECHO INCORPORATED, 10775 WOODBURN DRIVE, LAKE OZCROFT, INDIANAPOLIS, IN 46226.</p>	

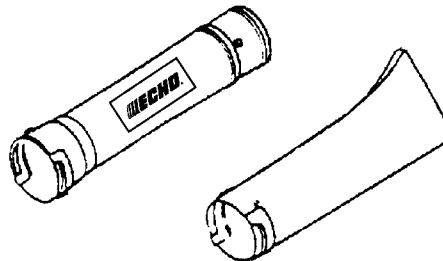
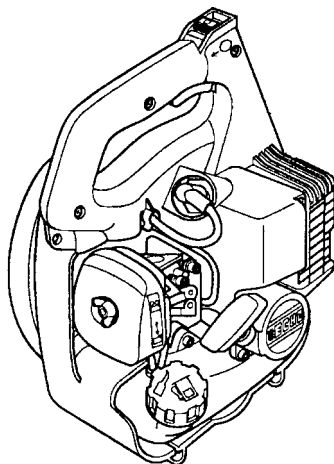

**Important:** This Spark Ignition System complies with Canadian ICES-002

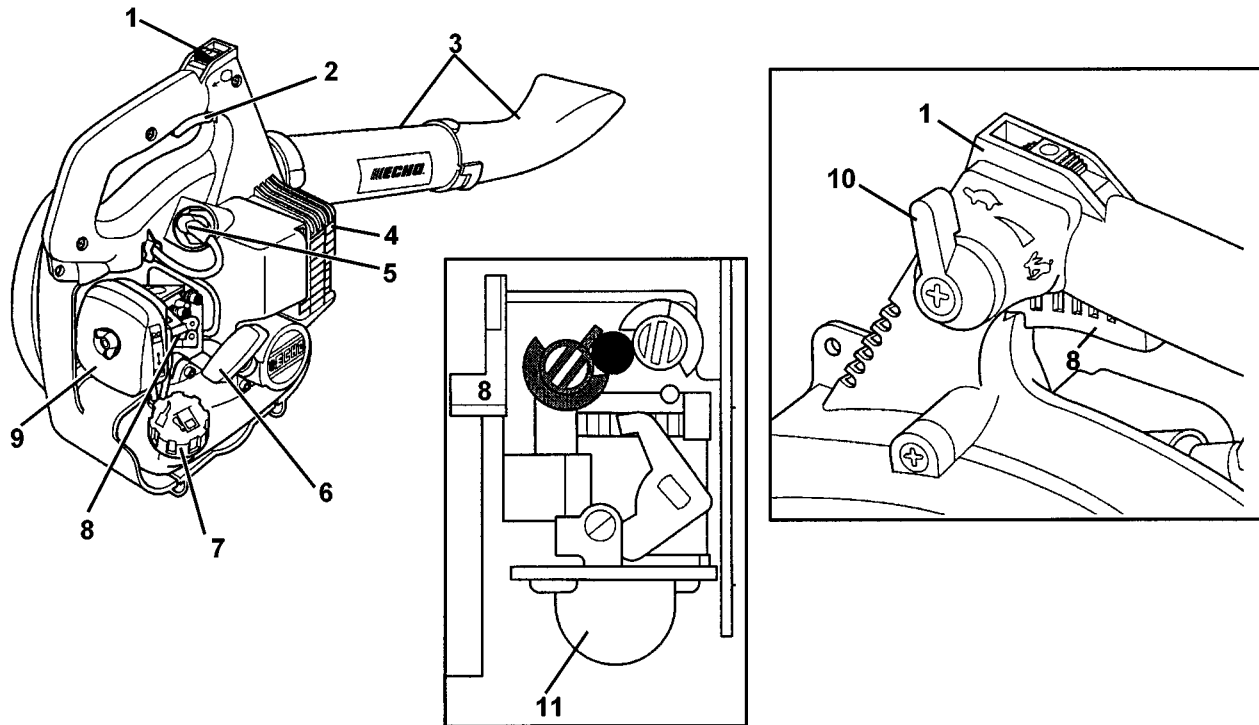

1. **STOP SWITCH** - "SLIDE SWITCH" mounted on top of handle. Push **forward** to **start** and **run**. Slide **back** to stop.
2. **THROTTLE TRIGGER** - Spring loaded to return to idle when released. During acceleration, press trigger gradually for best operating technique.
3. **BLOWER PIPES** - Twist lock design.
4. **MUFFLER/SPARK ARRESTOR** - The muffler controls the exhaust noise while the spark arrestor prevents hot, glowing particles of carbon from leaving the muffler where they could possibly start a fire.
5. **SPARK PLUG** - Provides spark to ignite fuel mixture.
6. **RECOIL STARTER HANDLE** - Pull handle slowly until starter engages, then quickly and firmly. When engine starts, return handle slowly. **DO NOT** let handle snap back or damage to unit will occur.
7. **FUEL TANK CAP** - Covers and seals fuel tank.
8. **CHOKE** - The choke control is located on the top of the air filter case. Pull choke knob up to close the choke for cold starting. Push knob down for the "RUN" position.
9. **AIR CLEANER** - Contains replaceable felt element.
10. **THROTTLE POSITION KNOB** - Pull back to increase engine speed. Friction washers maintain throttle lever setting.
11. **PRIMER BULB** - Before starting and after filling the fuel tank, pump primer bulb 10 times or until a steady stream of fresh fuel without air bubbles is visible through the "clear" fuel return line.

## SPECIFICATIONS

<b>MODEL</b>	<b>PB-210</b>
Length	330 mm (13.0 in.) w/o blower attachment
Width	215 mm (8.46 in.)
Height	340 mm (13.37 in.)
Weight (dry)	4.0 kg (8.4 lb.)
Engine Type	Air cooled, two-stroke, single cylinder gasoline engine
Displacement	21.2 cc (1.29 cu. in.)
Bore	32.2 mm (1.268 in.)
Stroke	26.0 mm (1.024 in.)
Carburetor	Zama Diaphragm, model C1U w/primer bulb
Ignition System	Flywheel Magneto, capacitor discharge ignition type
Spark Plug	NGK BPM-7Y Gap 0.65 mm (0.026 in.)
Exhaust System	Spark Arrestor Muffle
Fuel	Mixed (Gasoline and Two-stroke Oil)
Fuel/Oil Ratio	50:1 ECHO High Performance, two-stroke air cooled engine oil
Gasoline	89 Octane unleaded. DO NOT use fuel containing methyl alcohol, more than 10% ethyl alcohol or 15% MTBE
Oil	50:1 ECHO High Performance, two-stroke air cooled engine oil
Fuel Tank Capacity	0.5 lit. (17.0 US fl. oz.)
Recoil Starter System	Automatic Recoil Starter Centrifugal Type
Wide Open Throttle Speed (RPM)	7400
Idle Speed (RPM)	2500 - 300
Maximum Air Volume	305 cu. ft./min.
Maximum Air Speed w/pipes (MPH)	145

Specifications, descriptions and illustrative material in this literature are as accurate as known at the time of publication, but are subject to change without notice. Illustrations may include optional equipment and accessories, and may not include all standard equipment.

## ASSEMBLY

### WARNING DANGER

Never perform maintenance or assembly procedures with engine running or serious personal injury may result.

## INSTALL BLOWER PIPES

1. Align grooves in straight pipe with pegs on blower housing and slide pipe onto housing.
2. Turn straight pipe clockwise to lock it into place.

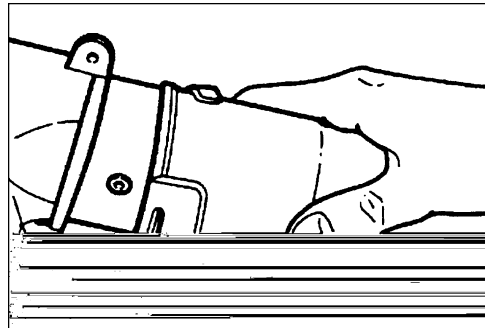

## PRE-OPERATION

### FUEL

#### *Fuel Requirements --*

**Gasoline** - Use 89 Octane [ $\frac{R+M}{2}$ ] gasoline known to be good quality. Gasoline may contain up to 10% Ethanol (grain alcohol) or 15% MTBE (methyl tertiary-butyl ether). Gasoline containing methanol (wood alcohol) is **NOT** approved.

**Two-Stroke Oil** - A two-stroke engine oil meeting ISO-L-EGD Standard (ISO/CD 13738), must be used. Echo brand Premium 50:1 oil meets this standard. Engine problems due to inadequate lubrication caused by failure to use an ISO-L-EGD approved oil, such as Echo Premium 50:1 Two-stroke Oil, will void the two-stroke engine warranty. (Emission related parts only are covered for two years, regardless of two-stroke oil used, per the statement listed in the EPA Phase I/California Emission Defect Warranty Explanation.)

**Mixing** - Follow directions on the oil container.

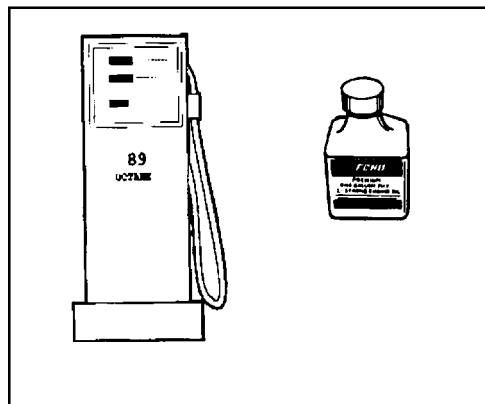

## Handling Fuel --

### WARNING DANGER

Fuel is **VERY** flammable. Use extreme care when mixing, storing or handling or serious personal injury may result.

- Use an approved fuel container.
- **DO NOT** smoke near fuel.
- **DO NOT** allow flames or sparks near fuel.
- Fuel tanks/cans may be under pressure. Always loosen fuel caps slowly allowing pressure to equalize.
- **NEVER** refuel a unit when the engine is **HOT!**
- **NEVER** refuel a unit with the engine running.
- **DO NOT** fill fuel tanks indoors. **ALWAYS** fill fuel tanks outdoors over bare ground.
- Securely tighten fuel cap after refueling.
- Inspect for fuel leakage. If fuel leakage is found, do not start or operate unit until leakage is repaired.



### After Refueling -

- Wipe any spilled fuel from the unit.
- Move at least 3M. (10 ft.) from refueling location before starting.

### After use -

- **DO NOT** store a unit with fuel in its tank. Leaks can occur. Return unused fuel to an approved fuel storage container.

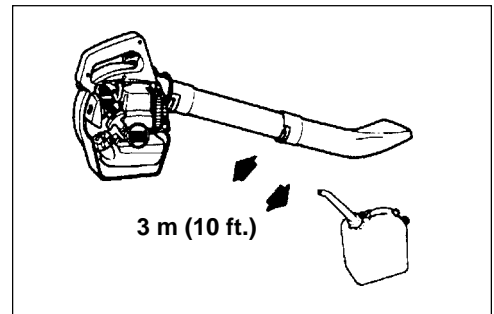

### Storage -

Fuel storage laws vary by locality. Contact your local government for the laws affecting your area. As a precaution, store fuel in an approved, air tight container. Store in a well ventilated, unoccupied building, away from sparks and flames.

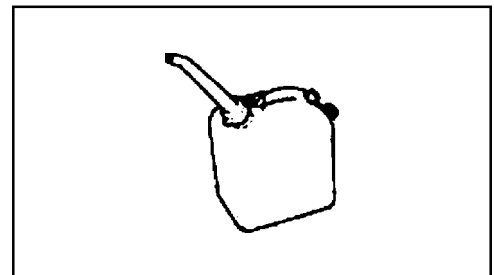

### IMPORTANT

Stored fuel ages. Do not mix more fuel than you expect to use in thirty (30) days, ninety (90) days when a fuel stabilizer is added.

Stored two-stroke fuel may separate. **ALWAYS** shake fuel container thoroughly before each use.

S	M	T	W	T	F	S
1	2	3	4	5	6	7
8	9	10	11	12	13	14
15	16	17	18	19	20	21
22	23	24	25	26	27	28
29	30	31				

## OPERATION

### WARNING DANGER

Do not operate this product indoors or in inadequately ventilated areas. Engine exhaust contains poisonous emissions which can cause serious injury or death.

- Provide all operators of this equipment with the Operator's Manual and instructions for safe operation.
- Before starting the unit, equip yourself and any other person working within the 15M (50 ft.) Safety Zone with the required Protective Equipment and clothing.

### IMPORTANT

Check unit for loose nuts, bolts and screws daily.

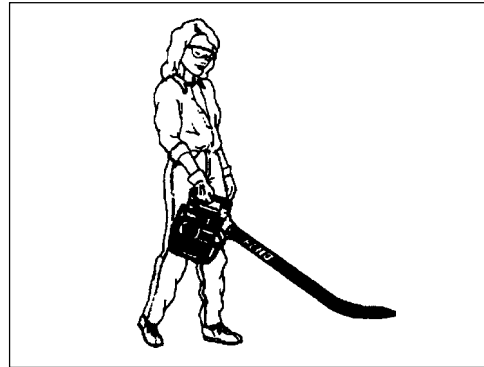

## STARTING COLD ENGINE

1. *Stop Switch - Start/Run.*  
Move stop switch button (A) forward away from the STOP position.
2. *Close Choke - Cold Start.*  
Move choke (C) to "Cold Start" Position.
3. *Primer Bulb - Prime.*  
Pump primer bulb (B) 10 times. Fuel will be visible and flow freely in the clear fuel tank return line.

### IMPORTANT

Recoil starter: Use short pulls - only 1/2-2/3 of rope for starting. Do not allow the rope to snap back in. Always hold the unit firmly.

4. Lay the blower on a flat clear area. Firmly grasp throttle grip with left hand and rapidly pull starter handle/rope (D) until engine fires.
5. After engine fires, move choke lever to "Run" position and pull starter handle/rope (D) until engine starts and runs. Allow unit to warm up at idle for several minutes.

### NOTE

If engine does not start with choke in "Run" position after 4 pulls, repeat instructions.

6. After engine warm up, gradually depress throttle trigger to increase engine RPM to operating speed.

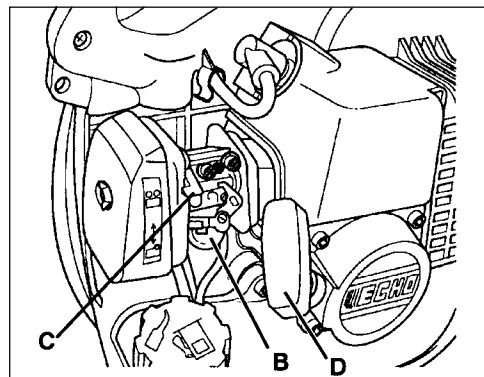
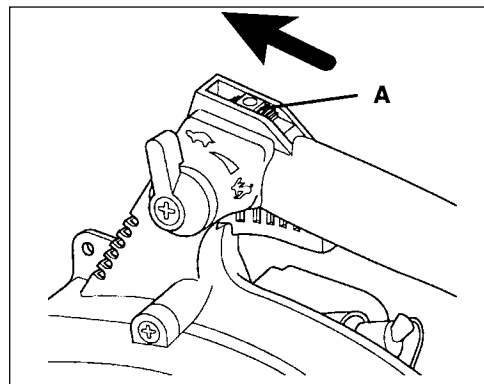

## STARTING WARM ENGINE

1. *Stop Switch - Start/Run.* Move stop switch button (A) away from the STOP position.
2. *Start - Pull Rope.* Lay the blower on a flat clear area and pull the starter handle (D) until the engine fires.

### NOTE

If engine does not start after 4 pulls, use Cold Start Procedure.

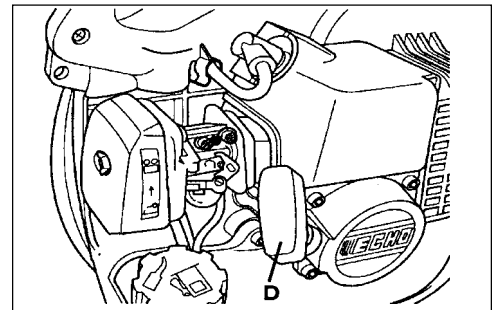
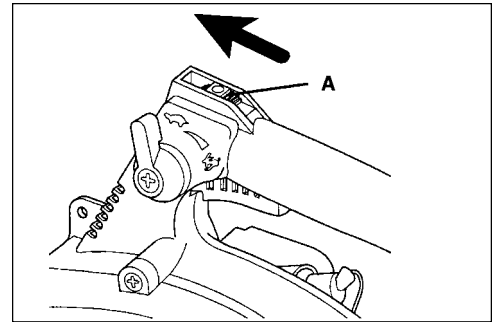

## STOPPING ENGINE

1. Release throttle trigger (E) and allow engine to idle for a minute.
2. Move stop switch (A) to "STOP" position.

### WARNING DANGER

If engine does not stop when stop switch is moved to STOP position, close choke - COLD START position - to stall engine. Have your ECHO dealer repair stop switch before using blower again.

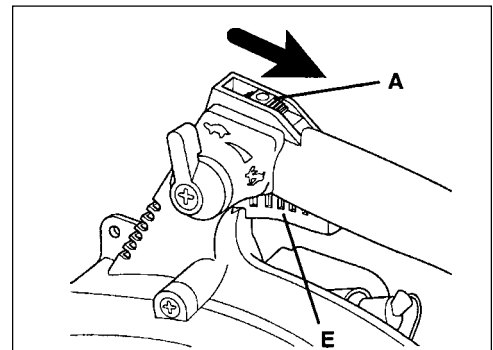

## OPERATING BLOWER

### WARNING DANGER

Always wear safety glasses, hearing protection and a face filter mask or serious personal injury may result.

Do not point the blower pipe in the direction of people or pets.

Read the Safety Section carefully.

### IMPORTANT

To avoid engine damage due to over revving, do not block blower pipe.



1. Use only during appropriate hours.
2. Make sure bevel at end of pipe faces outward.
3. Allow the engine to warm up at a fast idle for a few minutes.
4. Set engine speed with throttle position knob (F).

**NOTE**

The PB-2100 can be run at any speed between 2500 RPM to 7400 RPM once the engine has broken in (approximately after 3 fuel tanks).

**NOTE**

Use lower speed to blow dry leaves from a lawn or flower bed. Additional speed may be necessary to clean grass and leaves from walks, patios and drives or to move gravel, dirt, snow, bottles or cans from a driveway, street, parking lot or stadium.

**NOTE**

Never use a higher speed setting than necessary to perform a task. Remember, the higher the engine speed, the louder the blower noise. Minimize dust by using blower at lower speeds. Keep debris on your property.  
Be Smart - be a good neighbor.

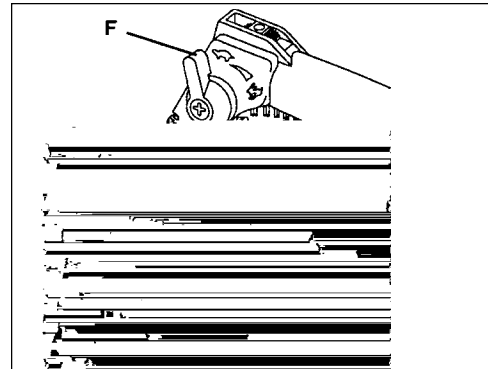

## MAINTENANCE

Your ECHO blower is designed to provide many hours of trouble free service. Regular scheduled maintenance will help your blower achieve that goal. If you are unsure or are not equipped with the necessary tools, you may want to take your unit to an ECHO Service Dealer for maintenance. To help you decide whether you want to DO-IT-YOURSELF or have the ECHO Dealer do it, each maintenance task has been graded. If the task is not listed, see your ECHO Dealer for repairs.

### SKILL LEVEL

- Level 1** = Easy to do. Most required tools come with unit.
- Level 2** = Moderate difficulty. Some specialized tools may be required.
- Level 3** = Experience required. Specialized tools are required.

ECHO offers **REPOWER** Maintenance Kits and Parts to make your maintenance job easier. Just below each task heading are listed the various part numbers required for that task. See your ECHO dealer for these parts.



## MAINTENANCE INTERVALS

Component/System	Maintenance Procedure	Before Use	Every Refuel	Daily or Every 4 Hours	3 Months or 100 Hours	6 Months or 300 Hours	Yearly or 600 Hours	Date Maintenance Performed
Air Filter	Inspect/Replace	I		I	R			
Fuel Strainer	Clean/Replace				I		R	
Fuel Line	Inspect/Replace	I	I		I		R	
Carburetor	Inspect/Rebuild/Replace					I	R(1)	
Choke System	Inspect/Clean/Replace		I					
Cooling System	Inspect/Clean	I		I				
Muffler Spark Arrestor	Inspect/Clean				I			
Recoil Starter Rope	Inspect/Clean	I						
Fuel Leaks	Inspect/Replace	I					I	
Spark Plug	Clean/Replace				I	R		
Ignition System	Clean/Replace	<b>No Maintenance required for coil and flywheel</b>						
Screws/Nuts/Bolts	Inspect/Tighten/Replace	I						

**I = Inspect, R = Replace**

### IMPORTANT

Time intervals shown are maximum. Actual use and your experience will determine the frequency of required maintenance.

(1) Replacement will be required for Commercial use after 600 hours. For Consumer use, cleaning every 6 months is required. Cleaning includes Rebuild Kits.

## AIR FILTER

### Level 1.

*Tools required:* Cleaning brush, 25-50mm (1in.-2in.) medium bristle paint brush.

*Parts required:* 90008 REPOWER AIR & FUEL FILTER KIT.

1. Close choke (Cold Start Position). This prevents dirt from entering the carburetor throat when the air filter is removed. Brush accumulated dirt from the air cleaner area.
2. Remove the air cleaner cover. Clean and inspect the element for damage. If element is fuel soaked and very dirty, replace.
3. If element can be cleaned and reused, be certain it:
  - still fits the cavity in the air cleaner cover.
  - is installed with the original side out.

### NOTE

Carburetor adjustment may be needed after air filter cleaning/replacement.

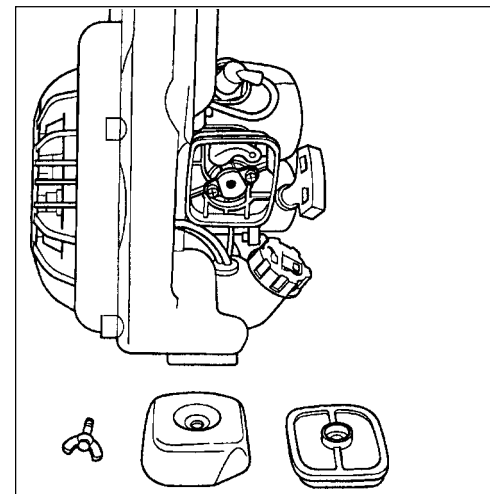
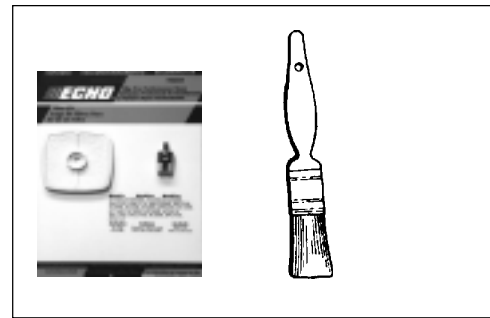

## FUEL FILTER

### Level 1.

*Tools required:* Fuel line hook. 203-254mm (8in.-10in.) length of wire with one end bent into a hook. Clean rag, funnel, and an approved fuel container.

*Parts required:* 90008 REPOWER AIR & FUEL FILTER KIT.

### WARNING DANGER

Fuel is **VERY** flammable. Use extreme care when mixing, storing or handling.

1. Use a clean rag to remove loose dirt from around fuel cap and empty fuel tank.
2. Use the "fuel line hook" to pull the fuel line and filter from the tank.
3. Remove the filter from the line and install the new filter.

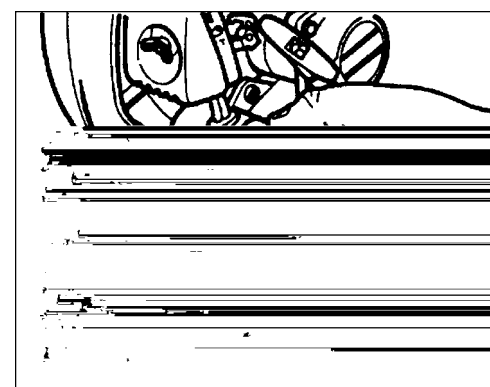
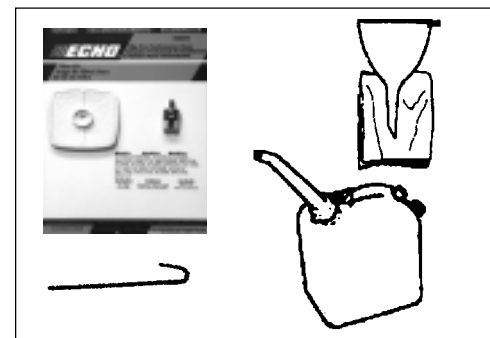

## SPARK PLUG

### Level 2.

*Tools Required:* 3/4" Spark Plug deep socket, Feeler gauge. Preferably a wire gauge.

*Parts Required:* Spark Plug, NGKBPM-7Y, P/N 99944500071

1. Remove spark plug and check for fouling, worn and rounded center electrode.
2. Clean the plug or replace with a new one. DO NOT sand blast to clean. Remaining sand will damage engine.
3. Adjust spark plug gap by bending outer electrode.
4. Tighten spark plug to 145-155 kg/cm (125-135 in. lb.).

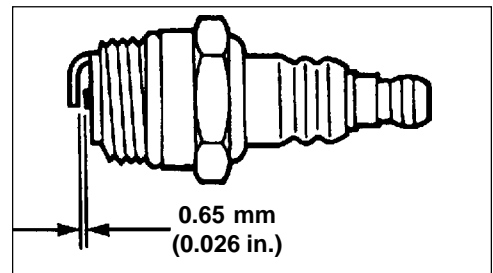
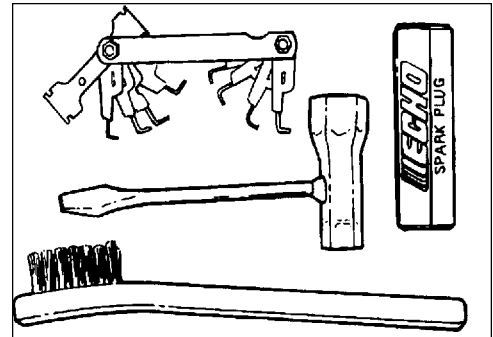

## COOLING SYSTEM CLEANING

### Level 3.

*Tools required:* 3/4" Spark Plug deep socket, Cross-Head Screwdriver, Pointed Wood Stick, Cleaning Brush, 25mm - 50mm (1in. -2in).

*Parts Required:* None if you are careful.

#### **IMPORTANT**

To prevent overheating and engine seizure, cooling air comes through the grille and is pushed by a cooling fan through the cylinder fin area to an opening in the front of the engine cover, taking away combustion heat. The grille and cylinder fins must be kept clean of grass, dust and any debris. Engine failure due to lack of this "Normal Maintenance" is not covered by warranty.

### Cleaning Grill

Remove accumulated debris from crankcase intake grille above the fuel tank.

### Cleaning Cylinder Fins

1. Remove spark plug.
2. Remove engine cover (seven screws) and clean cylinder fins to allow cooling air to pass freely.

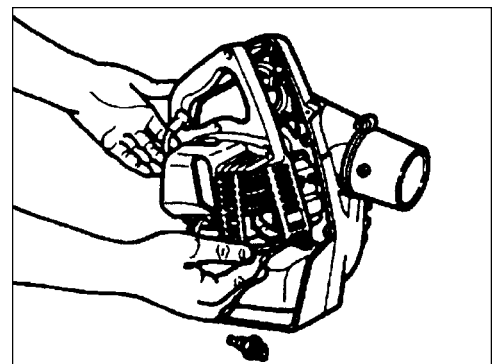
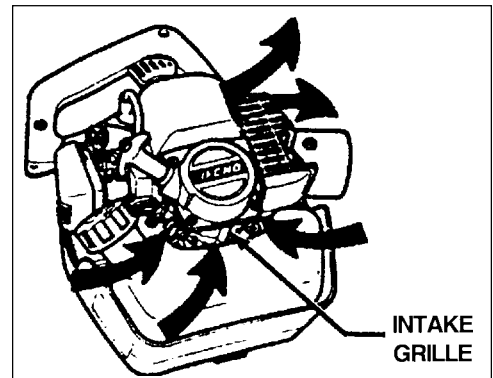
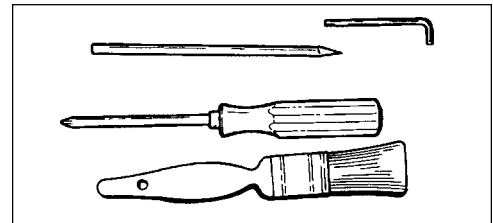

## EXHAUST SYSTEM

### Spark Arrestor Screen

#### Level 2.

*Tools Required:* Cross Head Screwdriver. 20mm (3/4in.) spark plug deep socket. Soft metal brush. Wooden carbon scraper.

*Parts Required:* Spark arrestor screen P/N 14586240630, gasket P/N 14586642031.

1. Remove spark plug and engine cover see "Cooling System Cleaning " page 19.
2. Place piston at Top Dead Center (TDC) to prevent carbon/dirt from entering cylinder.
3. Remove spark arrestor cover (A), exhaust diffuser (B), gasket (C) and spark arrestor screen (D) from muffler. Replace screen if plugged with carbon deposits.
4. Install spark arrestor screen, gasket, diffuser and cover.
5. Be sure gasket seals muffler spark arrestor screen to muffler.
6. Install engine cover and spark plug.

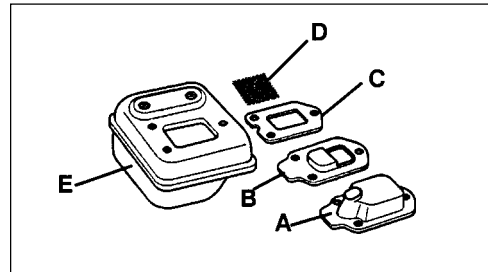
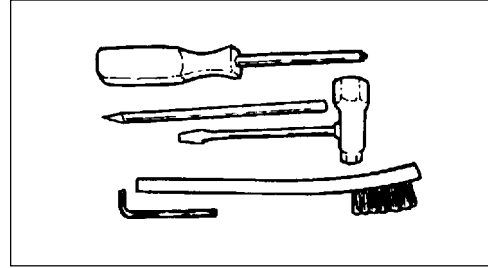

## ADJUSTING CARBURETOR - GENERAL

### Emission Models (With Limiter Caps)

#### Level 2.

*Tools required:* Screwdriver, tachometer (Echo P/N 99051130017).

*Parts required:* none.

#### NOTE

Every unit is run at the factory and the carburetor is set in compliance with EPA Phase 1 and California Emission Regulations. In addition, the carburetor is equipped with HI and LO needle adjustment limiters that prevent settings outside acceptable limits.

### Adjustment Screws

- |                    |   |
|--------------------|---|
| Idle Speed (A)     | Control throttle opening at idle.   |
| Low (LO) Speed (B) | Controls amount of fuel at low speed and supplementary fuel for smooth progression from idle to high speed. |
| Hi (HI) Speed (C)  | Controls amount of fuel at full throttle  |

### Before Adjustment

Check that:

- Air filter is clean and properly installed.
- Spark arrestor screen is free of carbon
- Blower pipes are installed

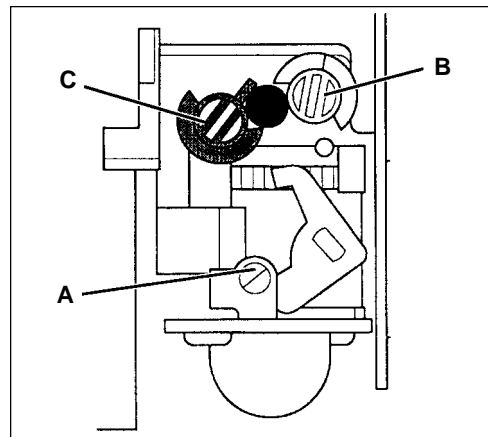
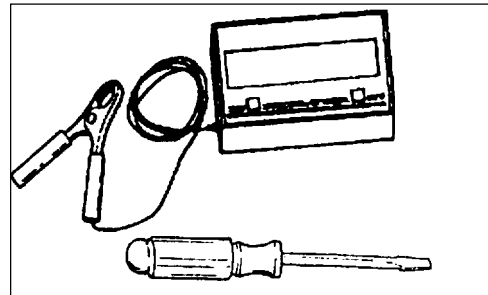

## Initial Adjustment

1. With engine off, turn HI speed screw (C) counterclockwise to stop.
2. Turn LO speed screw (B) midway between stops.
3. Turn idle screw (A) until tip of screw just touches throttle plate; then turn three (3) turns clockwise.

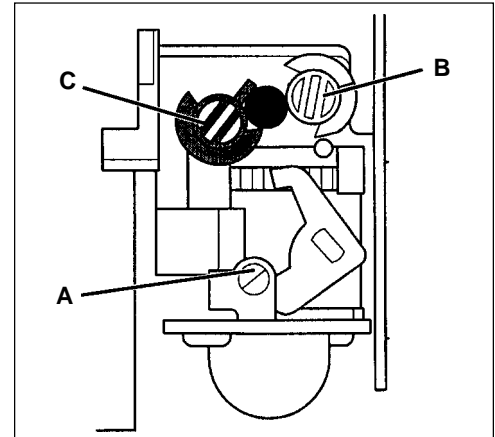

## Final Adjustment

1. Start engine, run at idle for one minute.
2. Complete warm up by running at full throttle for 5 minutes, operating choke twice to clear air from carburetor chambers.
3. Run at idle and accelerate to check for smooth transition from idle to high speed; if engine hesitates, turn LO speed screw (B) counterclockwise 1/8th of a turn at a time until acceleration is smooth.
4. Adjust idle screw (A) to 3000 R.P.M., using tachometer.
5. Check HI speed RPM at W.O.T. (Wide Open Throttle). HI speed RPM should be set to the specifications found on Page 11 "Specifications" of this manual.
6. Check idle speed and reset if necessary. If a tachometer is available, idle speed should be set to the specifications found on page 11 "Specifications" of this manual.

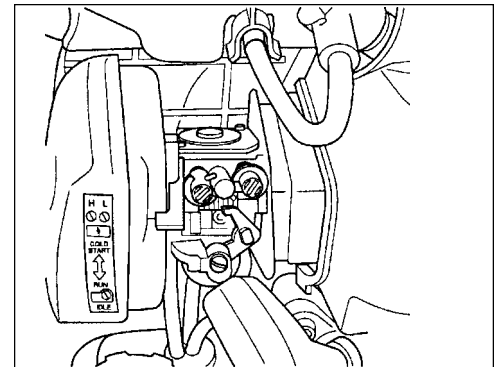

## TROUBLESHOOTING

Problem				
Engine - starts hard				
Engine - does not start			Cause	Remedy
Engine Cranks	Fuel at carburetor	No fuel at carburetor	Fuel strainer clogged Fuel line clogged Carburetor	Clean Clean See your ECHO dealer
	Fuel at cylinder	No fuel at cylinder	Carburetor	See your ECHO dealer
		Muffler wet with fuel	Fuel Mixture is too rich	Open choke Clean/replace air filter Adjust carburetor See your ECHO dealer
	Spark at end of plug wire	No spark at end of plug wire	Stop switch off Electrical problem Interlock switch	Turn switch on See your ECHO dealer See your ECHO dealer
	Spark at plug	No spark at plug	Spark gap incorrect Covered with carbon Fouled with fuel Spark plug defective	Adjust 0.65mm (0.026in.) Clean or replace Clean or replace Replace plug
Engine does not crank			Internal engine problem	See your ECHO dealer
Engine runs	Dies or accelerates poorly		Air filter dirty Fuel filter dirty Fuel vent plugged Spark plug Carburetor Cooling system plugged Exhaust port/spark arrestor screen plugged	Clean or replace Replace Replace Clean and adjust/replace Adjust Clean Clean
Engine runs properly	Blower does not work, is weak or uneven		Blower Pipe clogged, loose or damaged	Unclog Tighten Replace

## STORAGE

### *Long Term Storage (Over 30 Days)*

Do not store your unit for a prolonged period of time (30 days or longer) without performing protective storage maintenance which includes the following:

1. Store unit in a dry, dust free place, out of the reach of children.

**WARNING**  **DANGER**

Do not store in enclosure where fuel fumes may accumulate or reach an open flame or spark or serious personal injury may result.

2. Place the stop switch (A) in the "STOP" position.
3. Remove accumulation of grease, oil, dirt and debris from exterior of unit.
4. Perform all periodic lubrication and services that are required.
5. Tighten all screws and nuts.
6. **Drain** the fuel tank **completely** and pull the recoil starter handle several times to remove fuel from the carburetor.
7. Remove the spark plug and pour 7 cc (1/4 oz.) (1/2 tablespoon) of fresh, clean ECHO 2-stroke engine oil into the cylinder through the spark plug hole.
  - A. Place a clean cloth over the spark plug hole.
  - B. Pull the recoil starter handle 2-3 times to distribute the oil inside the engine.
  - C. Observe the piston location through the spark plug hole. Pull the recoil starter handle slowly until the piston reaches the top of its travel and leave it there.
8. Install the spark plug (do not connect ignition cable).
9. Remove blower pipe assembly from unit.

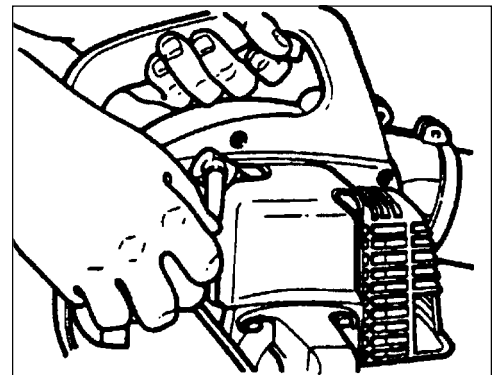
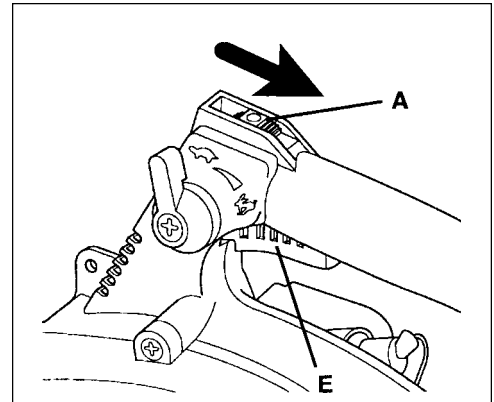

# SERVICING INFORMATION

## PARTS

Genuine ECHO Parts and ECHO Re Power Parts and Assemblies for your ECHO products are available only from an Authorized ECHO Dealer. When you do need to buy parts **always** have the Model Number, Type number and Serial Number of the unit with you. You can find all three numbers on the engine housing. For future reference, write them in the space provided below.

Model No. \_\_\_\_\_ Type No. \_\_\_\_\_ SN. \_\_\_\_\_

## SERVICE

Service of this product during the warranty period must be performed by an Authorized ECHO Service Dealer. For the name and address of the Authorized ECHO Service Dealer nearest you, ask your retailer or call: 1-800-432-ECHO (3246). When presenting your unit for Warranty service/repairs, proof of purchase is required.

## ECHO CONSUMER SUPPORT

If you require assistance or have questions concerning the application, operation or maintenance of this product you may call the ECHO Consumer Support Department at 1-800-673-1558 from 8:00 am to 5:00 pm (Central Standard Time) Monday through Friday. Before calling, please know the model and serial number of your unit to help your Consumer Support Representative.

## WARRANTY CARD

This card is our means of registering all original owners of ECHO equipment. The card plus proof of purchase provides you the assurance that authorized warranty work will be done. It also provides a direct link between you and ECHO if we find it necessary to contact you.

## ADDITIONAL OR REPLACEMENT MANUALS

**Operator's and Parts Manuals** are available for purchase from your ECHO dealer or directly from ECHO. [See ordering instructions at the end of this manual.]

## ORDERING INSTRUCTIONS

To obtain a Parts Catalog or Operator's Manual send a check or money order for \$2.00 per Parts Catalog or \$1.50 per Operator's Manual made payable to ECHO, INCORPORATED. State on a sheet of paper model number and serial number of the ECHO unit you have, part number of the manual (if known), your name and address and mail to address above:

### Available Parts Lists

PB-2100 Type 1E S/N 001001 & UP Part Number 99922202804

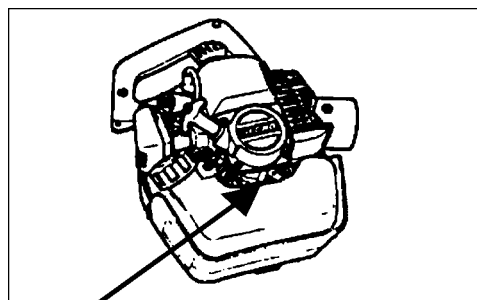

## DEALER?

Call  
1-800-432-ECHO  
1-800-432-3246

## CONSUMER SUPPORT

1-800-673-1558  
8 - 5 Mon - Fri C.S.T.

ECHO LIMITED WARRANTY REGISTRATION CARD / TARJETA DE INSCRIPCIÓN DE GARANTÍA LIMITADA	
<p>Please Print/ Por Favor Escriba Con Letra De Imprenta</p> <p>Purchaser's Name (Homeowner of Business/ Nombre del Comprador (Dueño de Casa o Negocio)</p>	
<p>Address/Dirección</p>	
<p>City/Ciudad</p>	
<p>State/Estado</p>	
<p>Phone/Telefono</p>	
<p>Serial No. and/or Type No. / Número de serie y/o número de tipo</p>	
<p>Customer Signature / Firma del Cliente</p>	
<p>Dealer Signature (If applicable) / Firma del Distribuidor (Si Se Aplica)</p>	
<p>Do not write in this area.</p>	
<p><b>A. Primary use of tool/ Uso principal de la herramienta:</b>                      1. 0 Homeowner 2. 1 Landscaper 3. 1 Professional                      Dueño de casa Distribuidor de jardines</p>	
<p><b>B. Safety/operational information received with product? / ¿Que información de seguridad/operación recibió con el producto?</b>                      1. 0 Operator's Manual 2. 1 Safety glasses                      Manual del Operador</p>	
<p><b>C. Have you reviewed the Brush Cutter/Trimmer Safety Video/ video? / ¿Ha visto el video de seguridad para información general sobre el control de mantenimiento?</b>                      1. 0 2. 1 Yes Available at any authorized Echo dealer. See instruction card/ Distribuidor autorizado de Echo. Ver instrucciones.</p>	
<p><b>TO PURCHASE A COPY OF THE ECHO SAFETY VIDEO OVERVIEW ON THE BRUSHCUTTER/TRIMMER SAFETY MANUAL, CONTACT: / PARA COMPRAR UNA COPIA DEL VIDEO DE INFORMACIÓN GENERAL SOBRE EL MANUAL DE SEGURIDAD DEL CORTAHOJE DE MANEJO/RECORTE, PONGASE EN CONTACTO CON:</b>                      ECHO, INCORPORATE                      400 OAKWOOD RD.                      LAKE ZURICH, IL 60047-1564</p>	

ECHO Incorporated

400 Oakwood Road

Lake Zurich, IL 60047

Technical Publications Orders



ECHO, INCORPORATED

400 Oakwood Road

Lake Zurich, IL 60047





**SUPPLEMENT TO OPERATOR'S MANUAL  
PART NUMBER X7501135101 (89861020561)  
FOR MODEL: PB-2100 S/N 898201 & UP**

*Please use this Operator Manual Supplement when assembling and maintaining your PB-2100.*

**DESCRIPTION Page 9  
EMISSION CONTROL**

**IMPORTANT ENGINE INFORMATION**  
ENGINE FAMILY : 2EHXS.0214RA DISPLACEMENT : 21.2cc  
EMISSION COMPLIANCE PERIOD : 300 HRS.  
THIS ENGINE MEETS U.S. EPA PHASE 2 EMISSION  
REGULATIONS FOR SMALL NONROAD ENGINES. REFER  
TO OWNER'S MANUAL FOR MAINTENANCE SPECIFICA-  
TIONS AND ADJUSTMENTS.



**PRODUCT EMISSION DURABILITY**

The 300 hour emission durability compliance period is the time span selected by the manufacturer certifying the engine emissions output meets applicable U.S. EPA emissions regulations, provided that approved maintenance procedures are followed as listed in the Maintenance Section of this manual.

**PRE-OPERATION Page 12**

**FUEL**

**Two Stroke Oil** - A two-stroke engine oil meeting ISO-L-EGD (ISO/CD 13738) and J.A.S.O. FC Standards, must be used. Echo brand Premium 50:1 oil meets these standards. Engine problems due to inadequate lubrication caused by failure to use an ISO-L-EGD and J.A.S.O. FC certified oil, such as Echo Premium 50:1 Two-stroke Oil, will void the two-stroke engine warranty. (Emission related parts only are covered for two years, regardless of two-stroke oil used, per the statement listed in the EPA Phase II Defect Warranty Explanation.)

**MAINTENANCE**

**CARBURETOR ADJUSTMENT Page 20**

*Emission Models*

**NOTE**

Every unit is run at the factory and the carburetor is set in compliance with EPA Phase II Emission Regulations. In addition, the carburetor is equipped with HI and LO needle adjustment limiters that prevent settings outside acceptable limits.

**SUPLEMENTO DEL MANUAL DEL OPERADOR  
NÚMERO DE PIEZA X7501135101 (89861020561)  
PARA LOS MODELO: PB-2100 Serie Número 898201 y Superior**

*Utilice por favor este suplemento manual del operador al ensamblar y manteniendo su PB-2100*

**DESCRIPCIÓN Page 9**

**CONTROL DE EMISIONES**

**INFORMACIÓN IMPORTANTE SOBRE EL MOTOR**  
FAMILIA DE MOTORES: 2EHXS.0214RA CILINDRADA: 21.2 cc  
PERIODO DE LA CONFORMIDAD PARA LA EMISIONES : 300  
HORAS.  
ESTE MOTOR RESUELVE LOS E.E.U.U. REGULACIONES DE  
LA EMISIÓN DE EPA PH2 PARA EL MOTOR PEQUEÑO DEL  
NONROAD. CONSULTE EN EL MANUAL DEL PROPIETARIO  
LAS ESPECIFICACIONES Y AJUSTES DE MANTENIMIENTO.



**DURABILIDAD DE LAS EMISIONES DEL PRODUCTO**

El período de durabilidad de conformidad para la emisiones de 300 horas es el tiempo seleccionado por el fabricante certificando que las emisiones de salida del motor cumplen con las regulaciones de emisiones aplicables de EPA de EE, UU, siempre que se sigan los procedimientos de mantenimiento aprobados según se indican en la sección de mantenimiento de este manual.

**OPERACIÓN PRELIMINAR Page 12**

**COMBUSTIBLE**

**Aceite de dos tiempos** - Se debe usar un aceite de motor de dos tiempos que cumpla con las normas ISO-L-EGD (ISO/CD. 13738) y J.A.S.O. FC. El aceite de calidad Echo 50:1 cumple con estas normas. Los problemas del motor debidos a una lubricación inadecuada por no usar un aceite certificado ISO-L-EGD y J.A.S.O.FC, tal como aceite de dos tiempos 50:1 de calidad óptima de Echo, anulará la garantía del motor de dos tiempos. (Las piezas relacionadas con las emisiones sólo están cubiertas durante dos años, sea cual sea el aceite de dos tiempos usado, según la declaración indicada en la explicación de garantía de defectos de emisiones de la Fase II de la EPA).

**MANTENIMIENTO Page 20**

**AJUSTE DEL CARBURADOR**

**NOTA**

Todas las unidades se hacen funcionar en fábrica y el carburador se ajusta en cumplimiento con las regulaciones de emisiones de EPA Fase II. Este carburador no tiene agujas de ajuste de aceleración y alta velocidad.

## Free Manuals Download Website

<http://myh66.com>

<http://usermanuals.us>

<http://www.somanuals.com>

<http://www.4manuals.cc>

<http://www.manual-lib.com>

<http://www.404manual.com>

<http://www.luxmanual.com>

<http://aubethermostatmanual.com>

Golf course search by state

<http://golfingnear.com>

Email search by domain

<http://emailbydomain.com>

Auto manuals search

<http://auto.somanuals.com>

TV manuals search

<http://tv.somanuals.com>