



## **PAS 80 Tooth Blade Brushcutter Attachment**

**99944200600**

*Operator's Manual*

### **FOR MODELS:**

**SRM-2100SB TYPE 1/1E**

**SRM-2400SB TYPE 1/1E**

**SRM-210SB/211SB/225SB**

**SRM-260SB/261SB**

**PAS-2100 TYPE 1E**

**PAS-2400 TYPE 1E**

**PAS-2601 TYPE 1E**

**PAS-210/211/225**

**PAS-230/231**

**PAS-260/261/265**



### **WARNING**

Read rules for safe operation and instructions carefully. ECHO provides an Operator's Manual with this attachment and a separate Operator's Manual and Safety Manual (if available) with the Power Head. All manuals must be read and understood for proper and safe operation. Failure to do so could result in serious injury.

## INTRODUCTION

Welcome to the ECHO family. This ECHO product was designed and manufactured to provide long life and on-the-job dependability. Read and understand this manual included with your attachment. You will find this manual easy to use and full of helpful operations tips and SAFETY messages.

### THE OPERATOR'S MANUAL

Contains specifications and information for operation, starting, stopping, maintenance, storage, and assembly specific to this product.

### THE SAFETY MANUAL

Explains possible hazards involved with the use of Grass Trimmers and Brush Cutters and the measures you should take to insure safe operation.

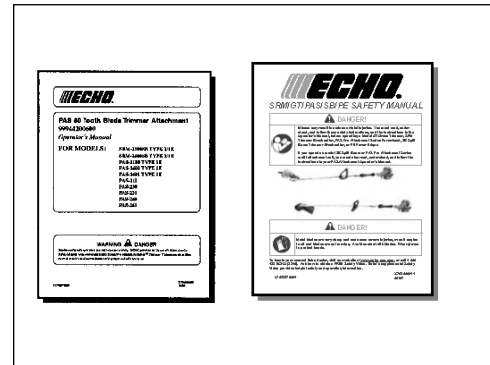

## TABLE OF CONTENTS

|   |    |  |    |
|---|----|--|----|
| Introduction.....                                     | 2  | Maintenance.....                         | 10 |
| - The Operator's Manual.....                          | 2  | - Skill Levels.....                      | 11 |
| - The Safety Manual.....                              | 2  | - Maintenance Intervals.....             | 11 |
| Safety.....   | 3  | - Lubrication.....                       | 11 |
| - Manual Safety Symbols and Important Information ... | 3  | Storage.....                             | 12 |
| - International Symbols.....                          | 3  | Specifications.....                      | 12 |
| - Personal Condition and Safety Equipment.....        | 4  | Servicing Information.....               | 16 |
| - Equipment.....                                      | 6  | - Parts/Serial Number.....               | 16 |
| Description.....                                      | 6  | - Service.....                           | 16 |
| Contents.....   | 7  | - ECHO Consumer Product Support.....     | 16 |
| Assembly.....   | 8  | - Warranty Card.....                     | 16 |
| - Power Head Shaft/Attachment Lower Shaft             |    | - Additional or Replacement Manuals..... | 16 |
| Assembly.....   | 8  |  |    |
| - Install Handle/Barrier Bar.....                     | 9  |  |    |
| - Blade Installation.....                             | 9  |  |    |
| - Balance Unit.....                                   | 10 |  |    |
| Operation.....  | 10 |  |    |

Specifications, descriptions and illustrative material in this literature are as accurate as known at the time of publication, but are subject to change without notice. Illustrations may include optional equipment and accessories, and may not include all standard equipment.

## SAFETY

### MANUAL SAFETY SYMBOLS AND IMPORTANT INFORMATION

Throughout this manual and on the product itself, you will find safety alerts and helpful, informational messages preceded by symbols or key words. The following is an explanation of those symbols and key words and what they mean to you.

#### **DANGER**

The safety alert symbol accompanied by the word "DANGER" calls attention to an act or condition which **WILL** lead to serious personal injury or death if not avoided.

#### **WARNING**

The safety alert symbol accompanied by the word "WARNING" calls attention to an act or condition which **CAN** lead to serious personal injury or death if not avoided.

#### **CAUTION**

The safety alert symbol accompanied by the word "CAUTION" calls attention to an act or condition which may lead to minor or moderate personal injury if not avoided.



#### **CIRCLE AND SLASH SYMBOL**

This symbol means the specific action shown is prohibited. Ignoring these prohibitions can result in serious or fatal injury.

#### **NOTE**











This enclosed message provides tips for use, care and maintenance of the unit.

#### **IMPORTANT**

The enclosed message provides information necessary for the protection of the unit.

## INTERNATIONAL SYMBOLS

| Symbol form/shape   | Symbol description/application  | Symbol form/shape   | Symbol description/application                                    |
|---|---|---|---|
|  | Read and understand Operator's Manual.  |  | Fuel and oil mixture  |
|  | Wear eyes, ears and head protection   |  | Finger Severing   |
|  | Hot Surface   |  | Wear hand protection. Use two handed.                             |
|  | Safety/Alert  |  | DO NOT smoke near fuel.   |
|  | Avoid all power lines. This unit is not insulated against electrical current. |  | Do not operate closer than 15 M (50 ft.) from electrical hazards. |
|  | Keep bystanders at least 15 meters (50 feet) away.                            |  | Plan retreat path from falling objects.                           |

| Symbol form/shape  | Symbol description/application            | Symbol form/shape   | Symbol description/application             |
|--|---|---|--|
|   | DO NOT allow flames or sparks near fuel.  |  | Wear slip resistant foot wear.             |
|   | Engine choke control.                     |  | Ignition ON/OFF                            |
|   | Emergency stop                            |  | Primer bulb                                |
|   | Chain lubrication                         |  | Carburetor adjustment - High speed mixture |
|   | Carburetor adjustment - Low speed mixture |  | Carburetor adjustment - Idle speed         |
|  |   | Keep bystanders and helpers away 15 m (50 ft.).                                       |  |

## PERSONAL CONDITION AND SAFETY EQUIPMENT



### **WARNING**

Users of this product risk injury to themselves and others if the unit is used improperly and/or safety precautions are not followed. Proper clothing and safety gear must be worn when operating unit.

### ***Physical Condition***

Your judgment and physical dexterity may not be good:

- if you are tired or sick,
- if you are taking medication,
- if you have taken alcohol or drugs.

Operate unit only if you are physically and mentally well.

### ***Eye Protection***

Wear eye protection that meets ANSI Z87.1 or CE requirements whenever you operate the unit.

### ***Hand Protection***

Wear no-slip, heavy-duty work gloves to improve your grip on the handle. Gloves also reduce the transmission of machine vibration to your hands.

### ***Hearing Protection***

ECHO recommends wearing hearing protection whenever unit is used.

### ***Proper Clothing***

Wear snug fitting, durable clothing;

- Pants should have long legs, shirts with long sleeves.
- **DO NOT WEAR SHORTS,**
- **DO NOT WEAR TIES, SCARVES, JEWELRY,** or clothing with loose or hanging items that could become entangled in moving parts or surrounding growth.

Wear protective hair covering to contain long hair.

Wear sturdy work shoes with nonskid soles;

- **DO NOT WEAR OPEN TOED SHOES,**
- **DO NOT OPERATE UNIT BAREFOOTED.**

Keep long hair away from engine and air intake. Retain hair with cap or net.

### ***Hot Humid Weather***

Heavy protective clothing can increase operator fatigue which may lead to heat stroke. Schedule heavy work for early morning or late afternoon hours when temperatures are cooler.

### ***Extended Operation/Extreme Conditions***

It is believed that a condition called Raynaud's Phenomenon, which affects the fingers of certain individuals, may be brought about by exposure to vibration and cold. Exposure to vibration and cold may cause tingling and burning sensations, followed by loss of color and numbness in the fingers. The following precautions are strongly recommended, because the minimum exposure, which might trigger the ailment, is unknown.

- Keep your body warm, especially the head, neck, feet, ankles, hands, and wrists.
- Maintain good blood circulation by performing vigorous arm exercises during frequent work breaks, and also by not smoking.
- Limit the hours of operation. Try to fill each day with jobs where operating the unit or other hand-held power equipment is not required.
- If you experience discomfort, redness, and swelling of the fingers followed by whitening and loss of feeling, consult your physician before further exposing yourself to cold and vibration.



## ***Repetitive Stress Injuries***

It is believed that overusing the muscles and tendons of the fingers, hands, arms, and shoulders may cause soreness, swelling, numbness, weakness, and extreme pain in those areas. Certain repetitive hand activities may put you at a high risk for developing a Repetitive Stress Injury (RSI). An extreme RSI condition is Carpal Tunnel Syndrome (CTS), which could occur when your wrist swells and squeezes a vital nerve that runs through the area. Some believe that prolonged exposure to vibration may contribute to CTS. CTS can cause severe pain for months or even years.

To reduce the risk of RSI/CTS, do the following:

- Avoid using your wrist in a bent, extended, or twisted position. Instead try to maintain a straight wrist position. Also, when grasping, use your whole hand, not just the thumb and index finger.
- Take periodic breaks to minimize repetition and rest your hands.
- Reduce the speed and force with which you do the repetitive movement.
- Do exercise to strengthen the hand and arm muscles.
- Immediately stop using all power equipment and consult a doctor if you feel tingling, numbness, or pain in the fingers, hands, wrists, or arms. The sooner RSI/CTS is diagnosed, the more likely permanent nerve and muscle damage can be prevented.

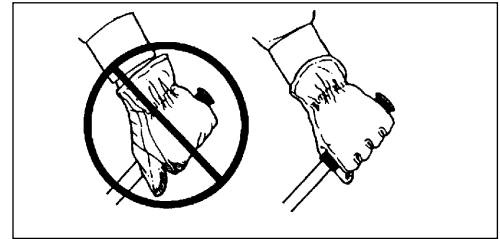

## **DANGER**

Do not operate this product indoors or in inadequately ventilated areas. Engine exhaust contains poisonous emissions and can cause serious injury or death.

## ***Read the Manuals***

- Provide all users of this equipment with the Operator's Manual and Safety Manual for instructions on Safe Operation.

## ***Clear the Work Area***

- Spectators and fellow workers must be warned, and children and animals prevented from coming nearer than 15 m (50 ft.) while the unit is in use.

## ***Keep a Firm Grip***

- Hold the front and rear handles with both hands, with thumbs and fingers encircling the handles.

## ***Keep a Solid Stance***

- Maintain footing and balance at all times. Do not stand on slippery, uneven or unstable surfaces. Do not work in odd positions or on ladders. Do not over reach.

## ***Avoid Hot Surfaces***

- Keep exhaust area clear of flammable debris. Avoid contact during and immediately after operation.

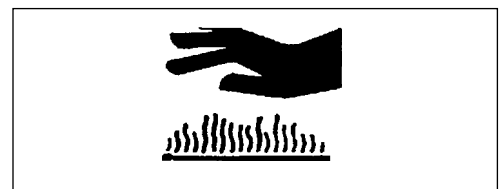

## EQUIPMENT



### WARNING

Use this attachment with ECHO approved models only. Serious injury may result from the use of this attachment combined with a non approved ECHO product.

Before operation a complete check of the unit must be performed;

- Check unit for loose/missing nuts, bolts and screws. Tighten and/or replace as needed.
- Inspect shield for damage and make sure it is **securely** in place. Replace if shield is damaged or missing.
- Check that the cutting attachment is firmly attached and in safe operating condition.
- Do not use trimmer if any part is missing or damaged.
- Have repairs done only by an authorized ECHO Service dealer.

### IMPORTANT

80-Tooth blade requires professional sharpening.



### WARNING

Moving parts can amputate fingers or cause severe injuries. Keep hands, clothing and loose objects away from all openings.

- **ALWAYS** stop engine, disconnect spark plug, and make sure all moving parts have come to a complete stop before removing obstructions, clearing debris, or servicing unit.
- **DO NOT** start or operate unit unless all guards and protective covers are properly assembled to unit.
- **NEVER** reach into any opening while the engine is running. Moving parts may not be visible through openings.

## DESCRIPTION

Locate these safety decals on your unit. Make sure the decals are legible and that you understand and follow the instructions on them. If a decal cannot be read, a new one can be ordered from your ECHO Dealer. See PARTS ORDERING instructions for specific information.

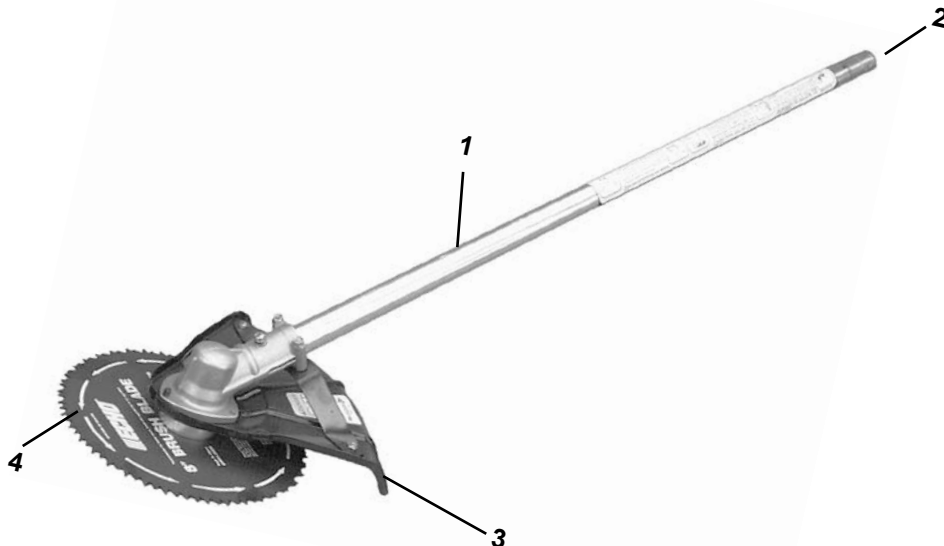

## Debris Shield Decal

## Shaft Decals

P/N X505002500



P/N 89016841031

- LOWER DRIVE SHAFT ASSEMBLY** - Includes the Debris Shield Assembly, Gear Housing assembly, Flexible Drive Cable, Metal Blade and Safety Decals.
- FLEXIBLE DRIVE CABLE** - Cable end fits into upper drive shaft coupler. Lubricate drive cable every 25 hours with ECHO® LUBE™ grease.
- METAL BLADE SHIELD** - Required when unit is equipped with blades. Do not operate unit without shield.
- BLADE** - Circular blade for brush cutting applications. Harness, metal shield and U-handles required for blade operation.

## CONTENTS

After opening the carton, check for damage. Immediately notify your retailer or ECHO Dealer of damaged or missing parts. Use the contents list to check for missing parts.

- \_\_\_ 1 - Pro Attachment Series™ Brushcutter Attachment
- \_\_\_ 1 - Operator's Manual
- \_\_\_ 1 - Safety Manual
- \_\_\_ 1 - Warranty Registration Card
- \_\_\_ - Assembly Tool (s)
- \_\_\_ 1 - 80 Tooth Metal Blade
- \_\_\_ 1 - Metal shield
- \_\_\_ 1 - Shield bracket
- \_\_\_ 1 - 4-Hole Barrier Bar
- \_\_\_ 1 - 2-Hole Barrier Bar
- \_\_\_ 3 - 5mm x 10mm screws (shield mounting)
- \_\_\_ 2 - 5mm x 8mm screws (bracket mounting)
- \_\_\_ 4 - 5mm nuts (bracket mounting)
- \_\_\_ 4 - 5mm lockwashers (bracket mounting)
- \_\_\_ 4 - 5mm x 35mm bolts (barrier bar)
- \_\_\_ 4 - 5mm nuts (barrier bar)
- \_\_\_ 9 - Split pins
- \_\_\_ 1 - Storage Hook Assembly
- \_\_\_ 1 - Shoulder Harness w/Quick-release Hook

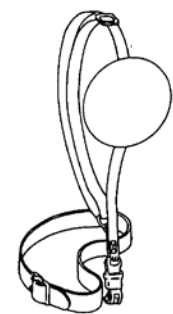
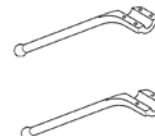
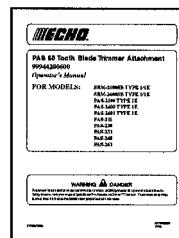

## ASSEMBLY



### WARNING

Do not perform maintenance or assembly procedures with engine running.

*Parts Required:* Power Head Shaft, Attachment Lower Shaft Assembly, Metal Shield, Bracket, Barrier Bar

## POWER HEAD SHAFT/ATTACHMENT LOWER SHAFT ASSEMBLY

1. Set Power Head/Shaft Assembly on a level surface.
2. Pull locator pin (A) and rotate counter clockwise 1/4 turn to lock out position.
3. Remove vinyl cap from attachment drive shaft.
4. Remove cardboard spacer, if necessary.
5. Carefully fit attachment lower drive shaft assembly into coupler (B) to decal assembly line (C), making sure that the inner lower drive shaft engages into the upper drive shaft mount.

### NOTE

Earlier model Power Heads may have shorter couplings. Short couplings fit flush to decal point (E). New couplings are 4-3/4 in. long, and fit flush to line (C).

### NOTE

Lower bearing housing and head assembly must be in line with the engine.

6. Rotate locator pin (A) 1/4 turn clockwise to engage lower shaft hole. Insure locator pin is fully engaged by gently twisting lower drive shaft. Locator pin (A) should snap flush in coupler. Full engagement will prevent further shaft rotation.
7. Secure lower shaft assembly to coupler by tightening clamping knob (D).

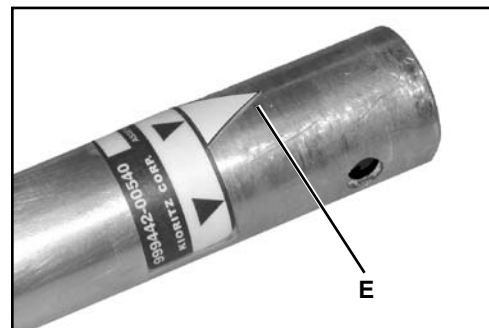
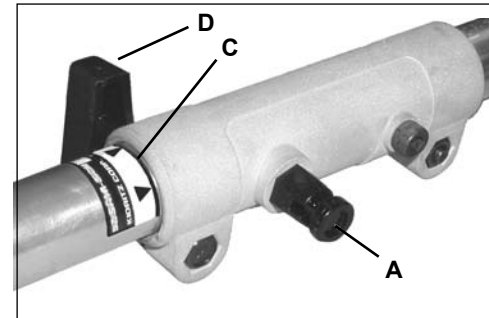
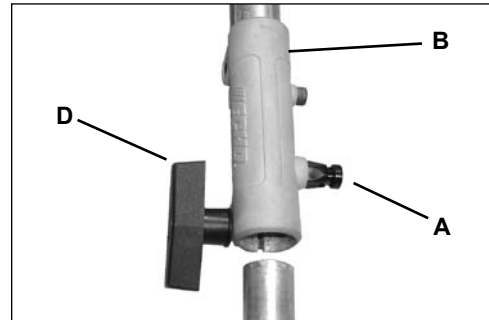
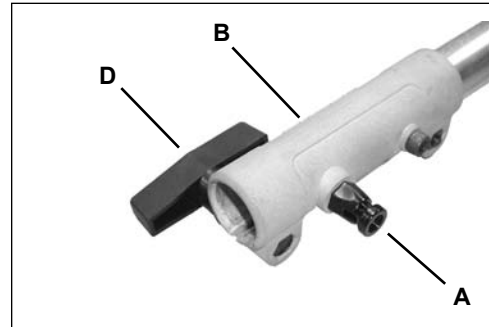



## INSTALL HANDLE/BARRIER BAR

### NOTE

The Barrier Bar is required when using grass or weed blades. Units equipped with U-Handles do not require installation of the Barrier Bar.

1. Remove screws and nuts and back plate from handle.

### 4-screw front handles

2. Position front handle on shaft and install Barrier Bar using four (4) 5x35 mm screws and (4) new nuts included with kit. Handle must be at least 10 inches (250 mm) from center of rear handle grip.
3. Adjust handle position for comfortable operation, and tighten screws securely.

### 2-screw front handles

2. Position front handle on shaft and install Barrier Bar using two (2) 5x35 mm screws provided in kit. Handle must be at least 10 inches (250 mm) from center of rear handle grip.
3. Adjust handle position for comfortable operation, and tighten screws securely.

### NOTE

The Barrier Bar is not a handle.



## BLADE INSTALLATION

### Install Metal Shield

1. Loosely attach bracket (A) to shield (B) and attach to bottom of gear housing (C) with screws and nuts provided. Tighten all attaching hardware.

### Install Blade

2. Install upper plate (D) on splined PTO shaft. Blade installation requires use of Upper Plate (D) with 20mm pilot.
3. Place Blade (E) over upper plate pilot, install the Lower Plate (F) and 10mm LH nut (G).
4. Insert Locking Tool (K) through hole in upper plate and notch in gear housing to prevent PTO shaft from turning. Tighten nut and secure with Split Pin (L).

### BLADE UPPER PLATE

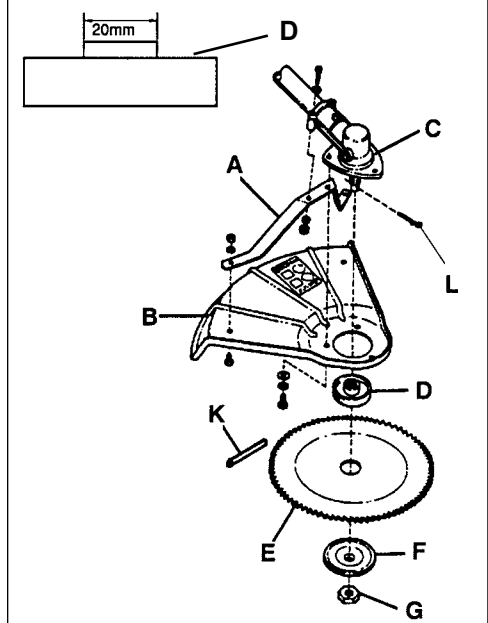

## BALANCE UNIT

1. Put on harness and attach unit to harness.
2. Slide harness clamp up and down until unit balances with head approximately 2 - 3 in. from the ground.
3. Tighten clamp screw.

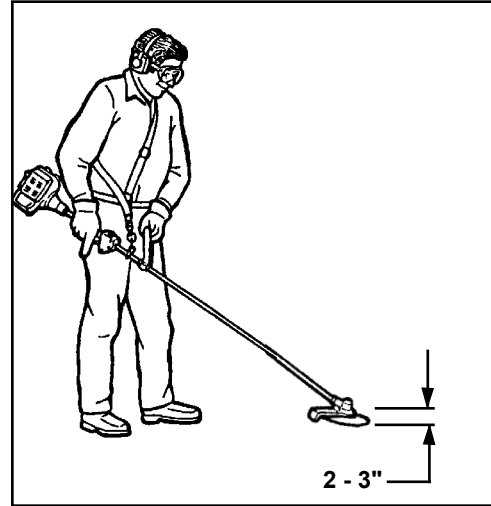

### NOTE

In case of Emergency, the trimmer/brushcutter can be released from the harness by pulling up on the quick-release collar.

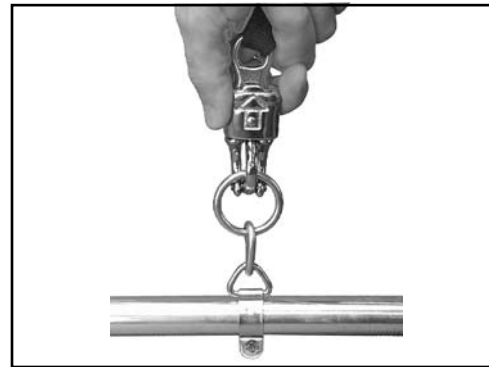

## OPERATION

### NOTE

Refer to your Split Boom\Pro Attachment Series™ Operator's Manual for correct engine fueling, starting and stopping instructions.

## MAINTENANCE

### **WARNING**

Moving parts can amputate fingers or cause severe injuries. Keep hands, clothing and loose objects away from all openings. Always stop engine, disconnect spark plug, and make sure all moving parts have come to a complete stop before removing obstructions, clearing debris, or servicing unit. Allow unit to cool before performing service. Wear gloves to protect hands from sharp edges and hot surfaces.

Your ECHO trimmer is designed to provide many hours of trouble free service. Regular scheduled maintenance will help your trimmer achieve that goal. If you are unsure or are not equipped with the necessary tools, you may want to take your unit to an ECHO Service Dealer for maintenance. To help you decide whether you want to DO-IT-YOURSELF or have the ECHO Dealer do it, each maintenance task has been graded. If the task is not listed see your ECHO dealer for repairs.

## SKILL LEVELS

- Level 1 = Easy to do. Common tools may be required.
- Level 2 = Moderate difficulty. Some specialized tools may be required.

## MAINTENANCE INTERVALS

| Component         | Maintenance Procedure   | Skill Level | Interval              |
|-------------------|-------------------------|-------------|-----------------------|
| Drive Shaft       | Grease                  | 1           | Every 25 hours of use |
| Gear Housing      | Grease                  | 1           | Every 50 hours of use |
| Screws/Nuts/Bolts | Inspect/Tighten/Replace | 1           | Before Each Use       |

**IMPORTANT** - Time intervals shown are maximum. Actual use and your experience will determine the frequency of required maintenance.

## LUBRICATION

### Level 1.

*Parts Required:* POWERBLENDX™ 8 oz. (P/N 91014) or Lithium Base Grease.



### *Gear Housing*

1. Clean all loose debris from gear box.
2. Remove plug (A) and check level of grease.
3. Fill gear case with grease.
4. Install plug (A).

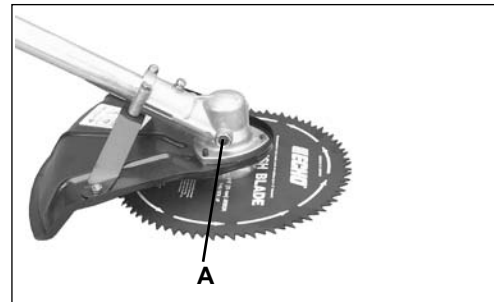

### *Drive Shaft (Lower)*

**IMPORTANT**  
Lower and upper drive shaft must be lubricated with POWER BLENDX™ grease every 25 hours of operation, otherwise drive shaft assembly overheating and failure can result.

1. Loosen two (2) 8 mm upper gear housing bolts (B) and locator screw (C). Remove gear case assembly.
2. Remove flex cable, wipe clean and apply a thin coating, 15 ml, of grease.
3. Install flex cable. Make sure cable end engages upper drive shaft adaptor.
4. Install gear case assembly onto drive shaft aligning locator screw with hole in drive shaft.
5. Tighten two 8 mm bolts (B) and locator screw (C).

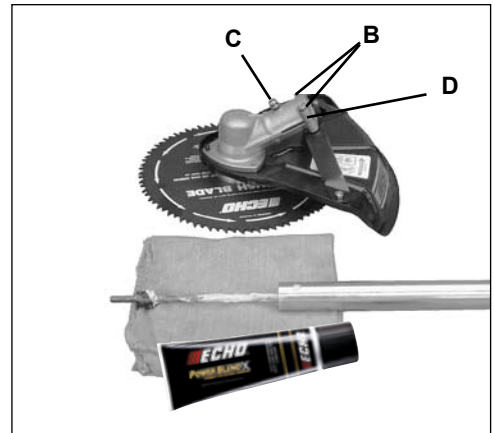

**IMPORTANT**  
Flat edge of washers (D) must be against drive shaft.

## STORAGE

### *Storage Hook Installation*

1. Insert small end of hook into locating hole on attachment shaft.
2. Slide plastic cap onto end of attachment shaft.

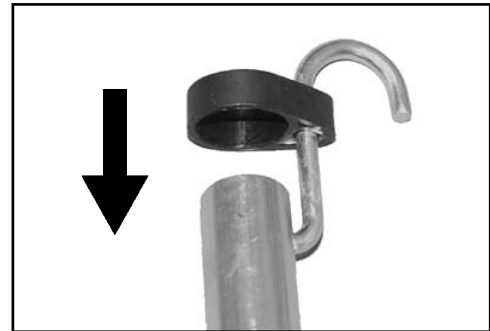

## SPECIFICATIONS

### *PAS 80 Tooth Blade Attachment*

|                      |  |
|----------------------|--|
| Shaft Length         | 870 mm (34.3 in.)                          |
| Attachment Width     | 280 mm (11 in.)                            |
| Attachment Height    | 255 mm (10 in.)                            |
| Weight (dry) w/blade | 1.5 kg. (3.32 lb.)                         |
| Drive Shaft          | 6.35 mm (1/4 in.) Flex Shaft               |
| Rotating Direction   | Counter-clockwise viewed from the top      |
| Cutter Attachment    | 80 Tooth, 203 mm (8 in.) Metal Brush Blade |

**NOTES**

**NOTES**

NOTES

## SERVICING INFORMATION

### PARTS/SERIAL NUMBER

Genuine ECHO Parts and ECHO REPOWER™ Parts and Assemblies for your ECHO products are available only from an Authorized ECHO Dealer. When you do need to buy parts **always** have the Model Number and Serial Number of the unit with you. You can find these numbers on the engine housing. For future reference, write them in the space provided below.

Model No. \_\_\_\_\_ SN. \_\_\_\_\_

### SERVICE

Service of this product during the warranty period must be performed by an Authorized ECHO Service Dealer. For the name and address of the Authorized ECHO Service Dealer nearest you, ask your retailer or call: 1-800-432-ECHO (3246). Dealer information is also available on our Web Site. When presenting your unit for Warranty service/repairs, proof of purchase is required.

### ECHO CONSUMER PRODUCT SUPPORT

If you require assistance or have questions concerning the application, operation or maintenance of this product you may call the ECHO Consumer Product Support Department at 1-800-673-1558 from 8:30 am to 4:30 pm (Central Standard Time) Monday through Friday. Before calling, please know the model and serial number of your unit to help your Consumer Product Support Representative.

### WARRANTY REGISTRATION

You may register your Echo equipment using the warranty registration card or register on-line at [www.echo-usa.com](http://www.echo-usa.com). Registering provides a direct link between you and ECHO if we find it necessary to contact you.

### ADDITIONAL OR REPLACEMENT MANUALS

**Replacement Operator, Safety Manuals, and Parts Catalogs** are available from your ECHO dealer or at [www.echo-usa.com](http://www.echo-usa.com) or by contacting ECHO Inc., 400 Oakwood Road, Lake Zurich, IL 60047 (800-673-1558).

**Safety Videos** are available from your Echo dealer. A \$5.00 shipping charge will be required for each video.



### DEALER?

Call  
**1-800-432-ECHO**  
or  
**[www.echo-usa.com](http://www.echo-usa.com)**

### CONSUMER PRODUCT SUPPORT

**1-800-673-1558**  
**8:30 - 4:30 Mon - Fri C.S.T.**



# ECHO®

ECHO, INCORPORATED

400 OAKWOOD ROAD

LAKE ZURICH, IL 60047

[www.echo-usa.com](http://www.echo-usa.com)

S33600001001/S33600999999



## Free Manuals Download Website

<http://myh66.com>

<http://usermanuals.us>

<http://www.somanuals.com>

<http://www.4manuals.cc>

<http://www.manual-lib.com>

<http://www.404manual.com>

<http://www.luxmanual.com>

<http://aubethermostatmanual.com>

Golf course search by state

<http://golfingnear.com>

Email search by domain

<http://emailbydomain.com>

Auto manuals search

<http://auto.somanuals.com>

TV manuals search

<http://tv.somanuals.com>