

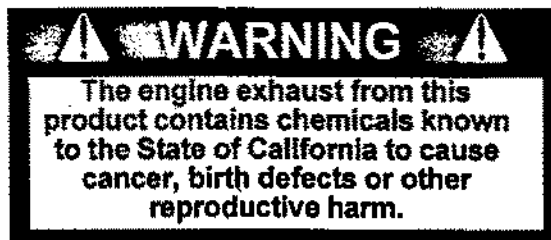

Grass Trimmer/Brush Cutter

Operator's Manual

MODELS, SRM-2100SB Type 1
SRM-2400SB Type 1
Serial Number 001001 & UP
SRM-2100SB Type 1E
Serial Number 001001 - 058701
SRM-2400SB Type 1E
Serial Number 001001 - 0504695



WARNING DANGER

Read rules for safe operation and instructions carefully. ECHO provides an Operator's Manual and a Safety Manual. Both must be read and understood for proper and safe operation.

INTRODUCTION

Welcome to the ECHO family. This ECHO product was designed and manufactured to provide long life and on-the-job-dependability. Read and understand this manual and the SAFETY MANUAL you found in the same package. You will find both easy to use and full of helpful operating tips and SAFETY messages.

WARNING DANGER

Read rules for safe operation and instructions carefully. ECHO provides an Operator's Manual and a Safety Manual. Both must be read and understood for proper and safe operation.

THE OPERATORS MANUAL --

contains specifications and information for operation, starting, stopping, maintenance, storage and assembly specific to this product.

THE SAFETY MANUAL --

explains possible hazards involved with the use of Grass Trimmers and Brush Cutters and what measures you should take to insure safe operation.



TABLE OF CONTENTS

Introduction	2	Pre-Operation	19
- The Operator's Manual	2	- Operation with Blades	19
- The Safety manual	2	- Fuel	21
Manual Safety Symbols & Important Information	3	- Equipment Check	22
Safety	3	- Determine Operation Area	22
- General Description	3	Operation	23
- Decals	4	- Starting Cold Engine	23
- International Symbols	4	- Starting Warm Engine	24
- Equipment	5	- Stopping Engine	24
- Fuel	5	Maintenance	25
- Personal Condition & Safety Equipment	6	- Skill Levels	25
- Safe Operation	7	- Maintenance Intervals	25
- Extended Operation/Extreme Conditions	8	- Air Filter	26
Description	9	- Fuel Filter	26
- Contents	9	- Spark Plug	27
- Blade Terms & Definitions	10	- Cooling System Cleaning	27
- Emission Control	10	- Exhaust System	28
Specifications	12	- Carburetor Adjustment Type 1E	30
Assembly	13	- Carburetor Adjustment Type 1	31
- Powerhead Shaft	13	- Lubrication	32
- Lower Shaft Assembly	13	- Nylon Line Replacement	33
- Plastic Shield Installation	13	- Starter Rope Replacement	34
- Nylon Head Installation	14	- Sharpening Metal Blades	36
- Loop Handle Installation	14	Troubleshooting	37
- Blade Installation	15	Storage	38
- Harness Clamp Installation	16	Servicing Information	40
- U-Handle Installation	17	- Parts	40
		- Service	40
		- Warranty Card	40
		- Additional or Replacement Manuals	40
		- Manual Ordering Instructions	40

Specifications, descriptions and illustrative material in this literature are as accurate as known at the time of publication, but are subject to change without notice. Illustrations may include optional equipment and accessories, and may not include all standard equipment.

MANUAL SAFETY SYMBOLS & IMPORTANT INFORMATION

Throughout this manual and on the product itself, you will find safety alerts and helpful, information messages preceded by symbols or key words. The following is an explanation of those symbols and key words and what they mean to you.



This symbol accompanied by the words **WARNING** and **DANGER** calls attention to an act or condition that can lead to serious personal injury to operator and bystanders.



The circle with the slash symbol means whatever is shown within the circle is prohibited.



IMPORTANT The enclosed message provides information necessary for the protection of the unit.

NOTE This enclosed message provides tips for use, care and maintenance of the unit.

SAFETY

GENERAL DESCRIPTION

IMPORTANT

See Description and Specification sections for full description and illustration of model variation in power head, handle type, harness and debris shield/cutter head.

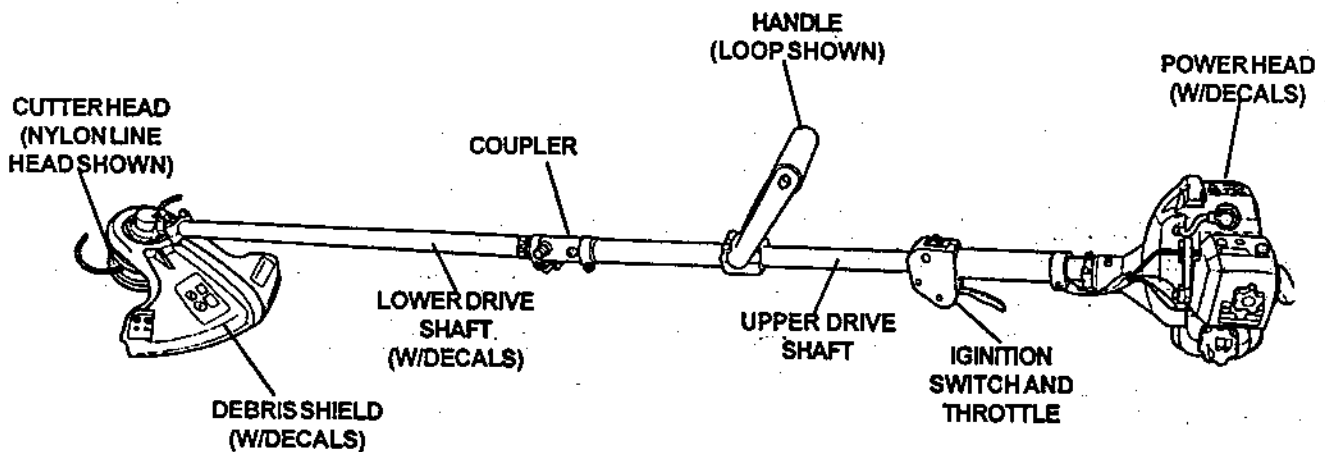

DECALS

Locate these safety decals on your unit. The complete unit illustration, found in the "DESCRIPTION" section, will help you locate them. Make sure the decals are legible and that you understand and follow the instructions on them. If a decal cannot be read, a new one can be ordered from your ECHO dealer. See PARTS ORDERING instructions for specific information.

Shaft Decal



- This unit can be dangerous and cause serious injury if improperly used. To reduce injury risk to operator, helpers and bystanders, read and understand the Operator's and Safety manuals.
- Blindness can occur from objects that are thrown or ricocheted even with shield in place. Operators, helpers and bystanders must wear ANSI Z87.1 approved eye protection.
- Always wear hearing protection when operating unit.
- Prevent accidental contact with unit and any cutting attachment. Maintain a 50 ft. (15M) radius, DANGER ZONE surrounding the operator. ONLY the operator, dressed in proper protective clothing should be in the DANGER ZONE.
- Beware of KICKOUT (blade thrust) when using blades. Special precautions are necessary for blade operation, see your Operator's and Safety Manuals. ONLY install ECHO approved blades on Brush Cutters (SRM) models equipped with proper blade shield, U-handles, harness, blade collar, nut and cotter pin.
- Blade/Cutting attachment does not stop immediately after releasing throttle. Keep hands and feet clear of blade/cutting attachment unless engine is shut off and cutting attachment is not moving.
- INSPECT BLADES BEFORE USE.
- DO NOT USE DAMAGED, CRACKED, BENT, DULL OR IMPROPERLY SHARPENED BLADES.
- Do not remove shields, modify the unit or install attachments or parts not approved by ECHO. Approved attachment information and replacement Operator's and Safety Manuals are available from your ECHO dealer or by writing: ECHO, INCORPORATED, 400 OAKWOOD RD., LAKE ZURICH, IL 60047.

DEBRIS SHIELD DECAL

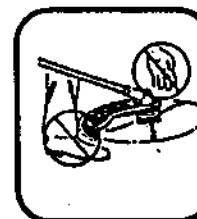
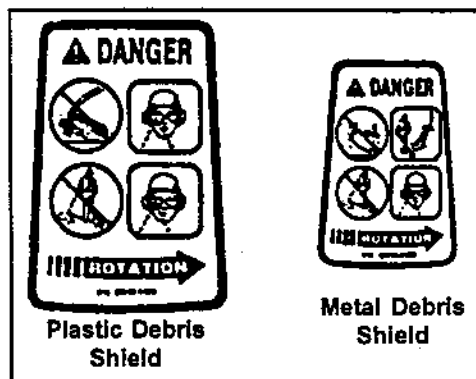

INTERNATIONAL SYMBOLS

Symbol form/shape	Symbol description/application	Symbol form/shape	Symbol description/application
	WARNING, SEE OPERATOR MANUAL		Fuel and oil mixture
	Wear eyes, ears and head protection		Finger Severing
	Emergency stop		Carburetor adjustment - Low speed mixture

Symbol form/shape	Symbol description/application	Symbol form/shape	Symbol description/application
	Hot Surface		Carburetor adjustment - High speed mixture
			Carburetor adjustment - Idle speed

EQUIPMENT

Before operation a complete check of the unit must be performed;

- Check unit for loose/missing nuts, bolts and screws. Tighten and/or replace as needed.
- Inspect fuel lines, tank and area around carburetor for fuel leaks. DO NOT operate unit if leaks are found.
- Inspect shield for damage and ensure that the cut-off knife is securely in place. Replace if either is damaged or missing.
- Check that the cutting attachment is firmly attached and in safe operating condition.

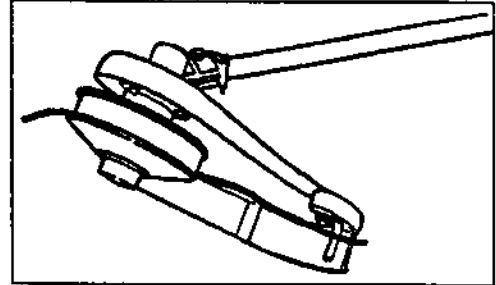
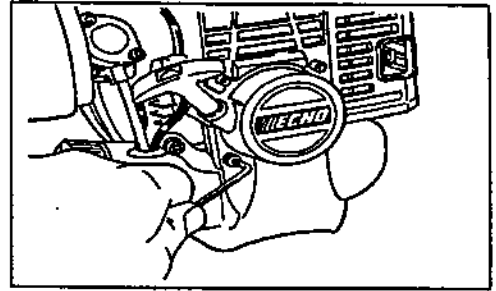

FUEL

WARNING DANGER

Fuel is **VERY** flammable. Use extreme care when mixing, storing or handling, otherwise serious personal injury may result.

- Use an approved fuel container.
- DO NOT smoke near fuel.
- DO NOT allow flames or sparks near fuel.
- Fuel tanks/cans may be under pressure. Always loosen fuel caps slowly allowing pressure to equalize.
- NEVER refuel a unit when the engine is HOT!
- NEVER refuel a unit with the engine running.
- DO NOT fill fuel tanks indoors. ALWAYS fill fuel tanks outdoors over bare ground.
- Securely tighten fuel cap after refueling.
- Inspect for fuel leakage. If fuel leakage is found, do not start or operate unit until leakage is repaired.

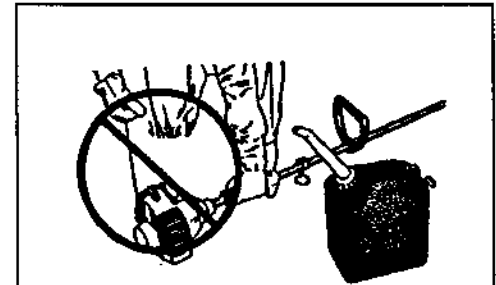

After Refueling;

- Wipe any spilled fuel from the unit.
- Move at least 10 ft. (3 M) from refueling location before starting.

After Use;

- DO NOT store a unit with fuel in its tank. Leaks can occur. Return unused fuel to an approved fuel storage container.

PERSONAL CONDITION & SAFETY EQUIPMENT

WARNING DANGER

Trimmer/Brush Cutter users risk injury to themselves and others if the trimmer/brush cutter is used improperly and or safety precautions are not followed. Proper clothing and safety gear must be worn when operating a trimmer.

Physical Condition –

Your judgment and physical dexterity may not be good:

- if you are tired or sick,
- if you are taking medication,
- if you have taken alcohol or drugs.

Operate unit only if you are physically and mentally well.



Eye Protection –

Eye protection goggles that meet ANSI Z87.1 requirements were included with your trimmer. Wear these goggles whenever you operate the trimmer.



Hand Protection –

Wear no-slip, heavy duty work gloves to improve your grip on the Grass Trimmer/Brush Cutter handles. Gloves also reduce the transmission of machine vibration to your hands. Special vibration reducing gloves such as Echo's Pro-Comfort are designed to provide additional comfort.

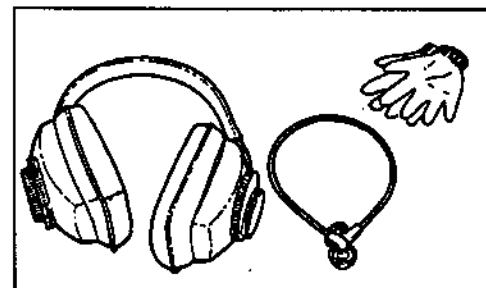

Hearing Protection –

Wear hearing protection. OSHA requires the use of hearing protection if this unit is used 2 hours per day or more. ECHO recommends wearing hearing protection whenever unit is used.

Proper Clothing –

Wear snug fitting, durable clothing;

- Pants should have long legs, shirts with long sleeves.
- DONOT WEAR SHORTS,
- DONOT WEAR TIES, SCARVES, JEWELRY.

Wear sturdy work shoes with non-skid soles;

- DONOT WEAR OPENTOED SHOES,
- DONOT OPERATE UNIT BAREFOOTED.



Hot Humid Weather --

Heavy protective clothing can increase operator fatigue which may lead to heat stroke. Schedule heavy work for early morning or late afternoon hours when temperatures are cooler.

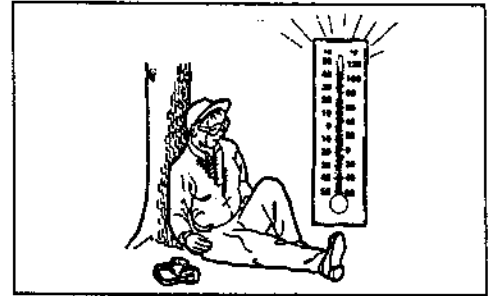

SAFE OPERATION

Determine Operation Area

- Review the area to be trimmed. Look for hazards that could contribute to unsafe conditions.
- Spectators and fellow workers must be warned, and children and animals prevented from coming nearer than 50 ft. (15M) while the trimmer is in use.

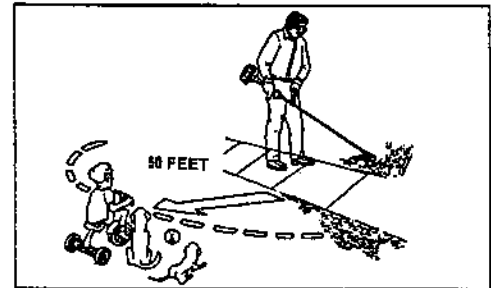

Operation

Use Proper Clothing & Equipment

- Before starting the unit, equip yourself and any other person working within the 50 ft. (15M) Safety Zone with the required Protective Equipment and clothing.

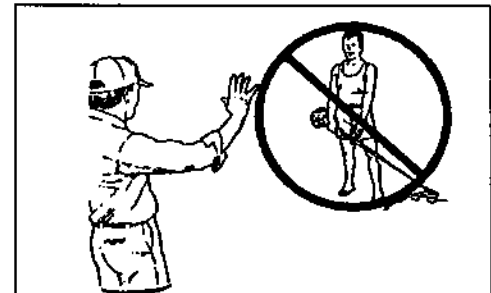

Avoid Hot Surfaces

- During operation, the complete unit, especially the drive shaft housing and the bearing housing may become very hot, too hot to touch. Avoid contact during and immediately after operation.

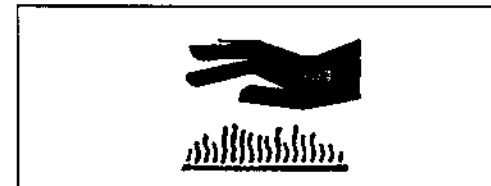

Keep A Firm Grip

- Hold the front and rear handles with both hands with thumbs and fingers tightly encircling the handles



Keep A Solid Stance

- Maintain footing and balance at all times. Do not stand on slippery, uneven or unstable surfaces. Do not work in odd positions or on ladders. Do not over reach.

EXTENDED OPERATION/EXTREME CONDITIONS***Vibration and Cold—***

It is believed that a condition called Raynaud's Phenomenon, which affects the fingers of certain individuals may be brought about by exposure to vibration and cold. Exposure to vibration and cold may cause tingling and burning sensations followed by loss of color and numbness in the fingers. The following precautions are strongly recommended because the minimum exposure which might trigger the ailment is unknown.

- Keep your body warm, especially the head, neck, feet, ankles, hands and wrists.
- Maintain good blood circulation by performing vigorous arm exercises during frequent work breaks and also by not smoking.
- Limit the hours of operation. Try to fill each day with jobs where operating the trimmer or other hand-held power equipment is not required.
- If you experience discomfort, redness and swelling of the fingers followed by whitening and loss of feeling, consult your physician before further exposing yourself to cold and vibration.

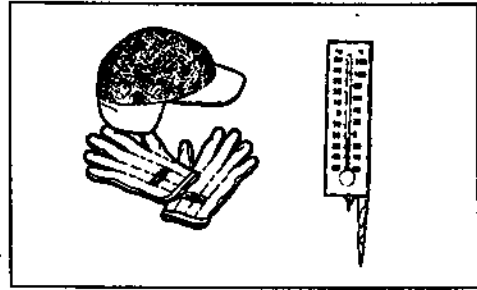
***Repetitive Stress Injuries—***

It is believed that overusing the muscles and tendons of the fingers, hands, arms and shoulders may cause soreness, swelling, numbness, weakness and extreme pain in those areas. Certain repetitive hand activities may put you at a high risk for developing a Repetitive Stress Injury (RSI). An extreme RSI condition is Carpal Tunnel Syndrome (CTS), which could occur when your wrist swells and squeezes a vital nerve that runs through the area. Some believe that prolonged exposure to vibration may contribute to CTS. CTS can cause severe pain for months or even years. To reduce the risk of RSI/CTS, do the following:

- Avoid using your wrist in a bent, extended or twisted position. Instead try to maintain a straight wrist position. Also, when grasping, use your whole hand, not just the thumb and index finger.
- Take periodic breaks to minimize repetition and rest your hands.
- Reduce the speed and force with which you do the repetitive movement.
- Do exercises to strengthen the hand and arm muscles.
- See a doctor if you feel tingling, numbness or pain in the fingers, hands, wrists or arms. The sooner RSI/CTS is diagnosed, the more likely permanent nerve and muscle damage can be prevented.

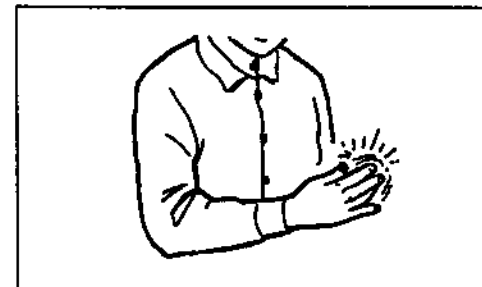
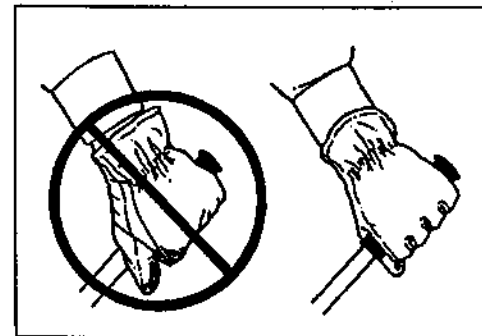

DESCRIPTION

The ECHO product you purchased has been factory pre-assembled for your convenience. Due to packaging restrictions, shield installation and other assembly may be necessary.

After opening the carton, check for damage. Immediately notify your retailer or ECHO Dealer of damaged or missing parts. Use the contents list to check for missing parts.

CONTENTS

<i>Contents List</i>		
Items	MODELS	
	SRM-2100SB	SRM-2400SB
1 - Power Head w/Upper Drive Shaft Assembly	√	√
1 - Lower Drive Shaft Assembly	√	√
1 - Plastic Bag (co-pack)	√	√
- 1, Operator's Manual	√	√
- 1, Safety Manual	√	√
- 1, Warranty Registration Card	√	√
- 1, Limited Warranty Statement	√	√
- 1, Plastic shield	√	√
- 1, Tool Bag	√	√
-1, 8mm x 10mm wrench	√	√
-1, screw	√	√
-1, locking tool	√	√
- 1, Nylon Trimmer Head	√	√
- 1, Safety Goggle	√	√
- 1, 2-Stroke Oil Sample, 2.6 oz.	√	√
- 1, Plastic Bag	√	√
-1, front handle (L.H.)	√	√
-1, front handle support	√	√
-plastic bag	√	√
--4, 5mm x 35mm screws (handle mtg.)	√	√
--4, 5mm nuts (handle mtg.)	√	√
-- 1, Plastic Bag	√	√
-- shield plate	√	√
-- 3, 5mm x 15mm screws (shield mtg.)	√	√

10 ECHO

BLADE TERMS & DEFINITIONS --

Blade Convertible

Models (SRM-2100SB, SRM-2400SB) can be converted to utilize blades. Plastic/nylon blades require a "Blade Conversion Kit", which includes a shoulder harness, and steel shield with necessary attaching hardware. Steel/metal blade also require the, "Blade Conversion Kit", plus a "U-Handle Kit" must be installed.

EMISSION CONTROL Type 1E Models

The emission control system for this engine is EM (Engine Modification).

IMPORTANT ENGINE INFORMATION

ENGINE FAMILY: TEH0240824RC

DISPLACEMENT: 23.6cc

THIS ENGINE MEETS U.S. EPA PH1 AND 1995-1998 CALIFORNIA EMISSION REGULATIONS FOR ULGE ENGINES. REFER TO OWNER'S MANUAL FOR MAINTENANCE SPECIFICATIONS AND ADJUSTMENTS.

KIORITZ CORP.

Emission Control Label located on Engine
(EXAMPLE ONLY, information on label varies by FAMILY).

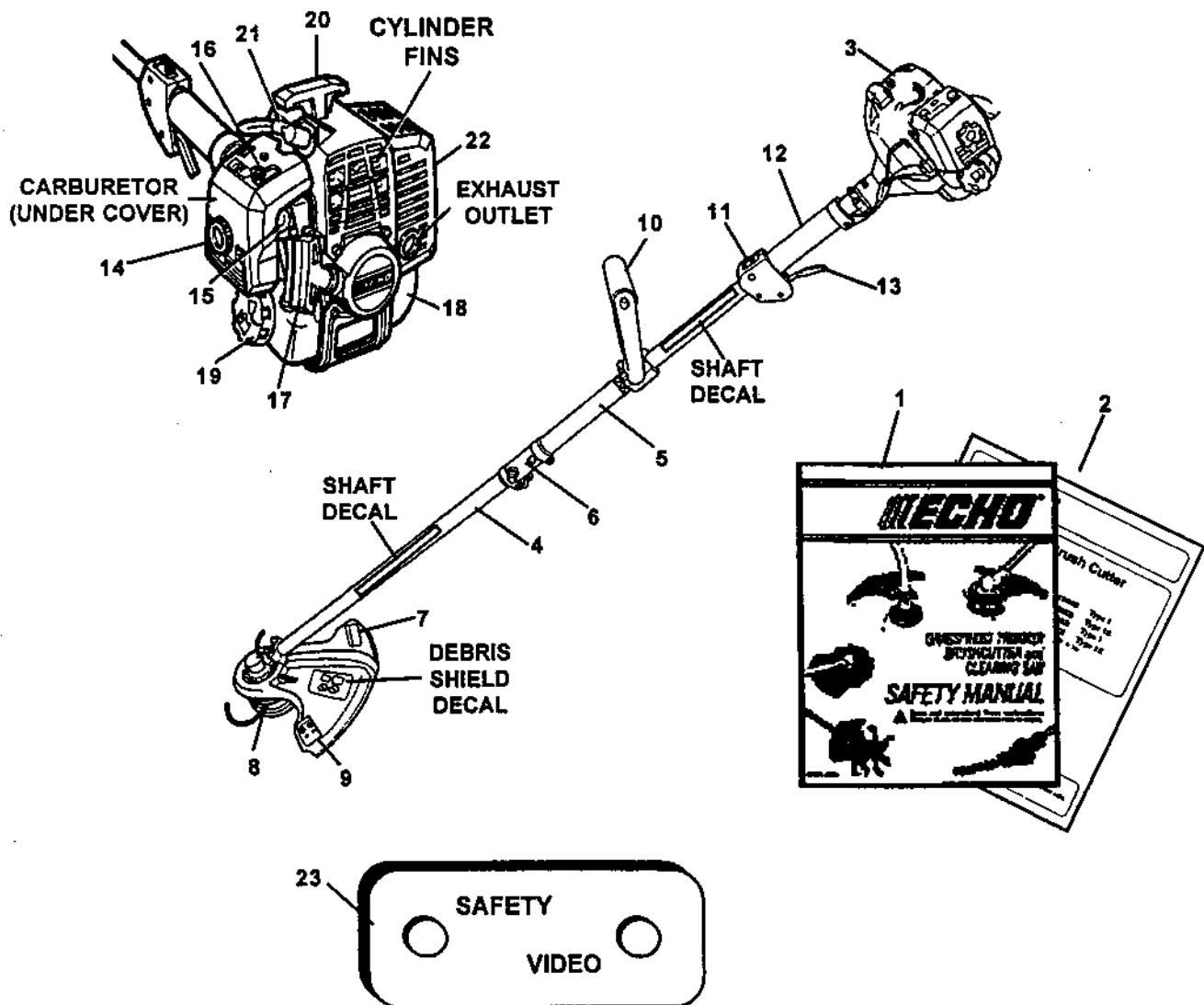

1. **SAFETY MANUAL** - Included in plastic bag (co-pack). Read before operation and keep in a safe place for future reference to learn proper, safe operating techniques.
2. **OPERATORS MANUAL** - Included in plastic bag (co-pack). Read before operation and keep in a safe place for future reference, i.e., operation, maintenance, storage and specifications.
3. **POWER HEAD** - Includes the Engine, Clutch, Fuel System, Ignition System and Starter.
4. **LOWER DRIVE SHAFT ASSEMBLY** - Includes the Debris Shield Assembly, Gear Housing assembly, Flexible Drive Cable, Nylon Cutter Head and Safety Decal.
5. **UPPER DRIVE SHAFT ASSEMBLY** - Includes the Rear (Right Hand) Assembly, Loop (Front, Left Hand) Handle Assembly, Flexible Drive Cable, Drive Shaft Assembly Coupler and Power Head.
6. **DRIVE SHAFT COUPLER** - Includes Locator Pin and Clamping Knob.
7. **PLASTIC DEBRIS SHIELD ASSEMBLY** - Included in plastic bag (co-pack). **MUST** be installed on unit before use, see Assembly Instructions. Shield assembly includes the Cut-Off Knife and Safety Decal. Mounts on the Gear Housing Assembly just above the cutting attachment. Helps protect the operator by deflecting debris produced during the trimming operation. This shield must be replaced with the steel shield for blade use on (SRM Models only).
8. **NYLON CUTTER HEAD** - Contains replaceable nylon trimming line that advances when the trimmer head is tapped against the ground while the head is turning at normal operating speed.
9. **CUT-OFF KNIFE** - Trims line to the correct length: 5" from head to end of line after head is tapped on the ground during operation and the line advances. If trimmer is operated without a cut-off knife the line will become too long. If the line is more than the listed length the operating speed will slow, the engine overheat and engine damage may occur.
10. **LOOP HANDLE** - The Loop (front) must be assembled to the Upper Drive Shaft assembly and positioned for proper cutting attitude and operator comfort.
11. **IGNITION SWITCH** - "SLIDE SWITCH" mounted on top of the Throttle Trigger Housing. Move switch FORWARD to RUN, BACK to STOP.
12. **GRIP** - Rear (right hand) handle.
13. **THROTTLE TRIGGER** - Spring loaded to return to idle when released. During acceleration, press trigger gradually for best operating technique. **DO NOT** hold trigger while starting.
14. **AIR CLEANER** - Contains replaceable filter element.
15. **PURGE BULB** - Before starting and after filling the fuel tank, pump purge bulb 3-4 times or until a steady stream of fresh fuel without air is visible through the "clear" fuel return line.
16. **CHOKE** - The choke control lever is located on the top of the choke case.
SRM-2100SB - Push lever to "COLD START" to close choke for cold starting. Pull the lever all the way back for the "RUN" position.
SRM-2400SB - Pull choke knob up to close the choke for cold starting. Push knob down for the "RUN" position.
17. **STARTER HANDLE** - Pull handle slowly until starter engages, then quickly and firmly. When engine starts, return handle slowly. **DO NOT** let handle snap back or damage to unit will occur.
18. **FUEL TANK** - Contains fuel and fuel filter.
19. **FUEL TANK CAP** - Covers and seals fuel tank opening.
20. **ARM REST** - Provides arm rest during operation and protects arm from the hot engine.
21. **SPARK PLUG** - Provides spark to ignite fuel mixture.
22. **MUFFLER/SPARK ARRESTOR** - The muffler controls the exhaust noise while the spark arrestor prevents hot, glowing particles of carbon from leaving the muffler where they could possibly start a fire. Built in accordance with SAEJ335, this product is approved for use on U.S. Forest Land and within the states of California, Maine, Oregon and Washington if the spark arresting screen is in place and in good repair.
23. **SAFETY VIDEO** - P/N 99922202540 (Not included with unit and English version only) is available for your review and purchase at a cost of \$5.00 from ECHO, INC. or any authorized ECHO dealer. The video overviews safety precautions and proper operating techniques provided in detail in the Safety Manual, and is supplemental to the Safety Manual. Read and understand the Safety Manual for complete information on safe operation.

SPECIFICATIONS

SRM-2100SB, SRM-2400SB

MODEL	SRM-2100SB	SRM-2400SB
Shaft Length	1500 mm (59 in.)	1500 mm (59 in.)
Unit Width	330 mm (13.0 in.)	330 mm (13.0 in.)
Unit Height	300 mm (11.8 in.)	360 mm (14.2 in.)
Weight (dry) w/Cutter Head	(11.9 lb.) 5.4 kg	(12.4 lb.) 5.6 kg
Engine Type	Air cooled, two-stroke, single cylinder gasoline engine	
Bore	32.2 mm (1.268 in.)	34.0 mm (1.34 in.)
Stroke	26.0 mm (1.04 in.)	26.0 mm (1.04 in.)
Displacement	21.2 cc (1.29 cu. in.)	23.6 cc (1.44 cu. in.)
Exhaust System	Spark Arrestor Muffler	
Carburetor	Zama diaphragm model C1U w/purge	Walbro diaphragm model WT w/purge
Ignition System	Flywheel magneto, capacitor discharge	
Spark Plug	NGK BPM-7A or Champion CJ-7Y Gap 0.65 mm (0.026 in.)	
Fuel	Mixed (Gasoline and Two-stroke Oil)	
Fuel/Oil Ratio	50:1 ECHO High Performance, two-stroke air cooled engine oil	
Gasoline	89 Octane unleaded. DO NOT use fuel containing methyl alcohol, more than 10% ethyl alcohol or 15% MTBE.	
Oil	50:1 ECHO High Performance, two-stroke air cooled engine oil	
Fuel Tank Capacity	0.4 lit. (13.5 US fl. oz.)	0.4 lit. (13.5 US fl. oz.)
Starter System	Automatic Rewind Starter	
Clutch	Centrifugal Type	
Drive Shaft Upper & Lower	1/4" Flex Shaft	1/4" Flex Shaft
Rotating Direction	Clockwise viewed from top	
Cutter Head	Nylon line head (2-line) with .095 in. Cross Fire™ line capacity 13m (40 ft.)	
Loop Handle*	Left - D-Loop, Right - Grip, when operating with line - Standard	
Shoulder Harness	Optional	Optional
Wide Open Throttle Speed with Trimmer Head	8300 - 8800 RPM	8800 - 9300 RPM
Wide Open Throttle Speed with Blade (Optional)	9500 - 11,000 RPM	9500 - 11,000 RPM
Idle Speed	2400 - 3000 RPM	2400 - 3000 RPM

* Install and use U-Handle when operating any model with blade.

ASSEMBLY

POWER HEAD SHAFT/LOWER SHAFT ASSEMBLY

Tools Required: None

Parts Required: Power Head Shaft, Lower Shaft Assembly, Clamping Knob, Bolt (5x35mm), Flat Washer, Lockwasher

1. Assemble bolt (A) through coupler (B) mounting holes from right to left viewed from open end.
2. Assemble flat washer (C) and lock washer (D) onto bolt end.
3. Assemble and lightly snug clamping knob (E).
4. Set Power Head/Shaft Assembly on a level surface.
5. Pull locator pin (F) and rotate counter clockwise 1/4 turn to lock out position.
6. Carefully fit lower drive shaft assembly into coupler (B) to decal assembly line (G), making sure that the inner lower drive shaft engages into the upper drive shaft mount.

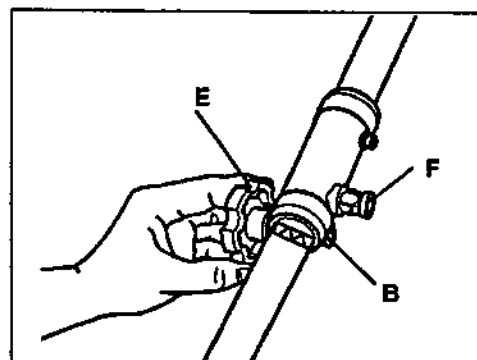
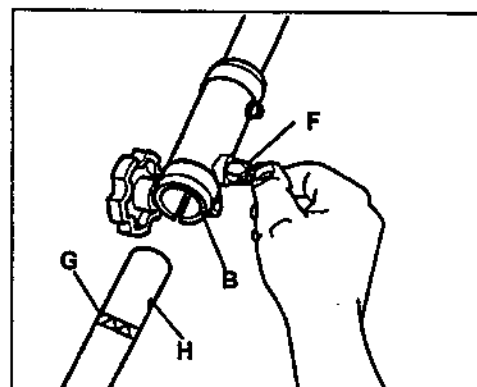
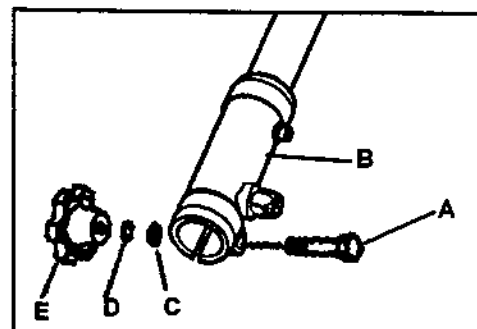

NOTE

Lower bearing housing and head assembly must be in line with the engine.

7. Rotate locator pin (F) 1/4 turn clockwise to engage lower shaft hole (H). Insure locator pin is fully engaged by gently twisting lower drive shaft. Locator pin should snap flush in coupler. Full engagement will prevent further shaft rotation.
8. Secure lower shaft assembly to coupler by tightening clamping knob (E).

PLASTIC SHIELD INSTALLATION

(for Nylon Line Operation)

Tools Required: Screwdriver.

Parts Required: Plastic Shield, Shield Plate, three (3) 5mm x 15mm screws.

14 ECHO

NOTE

The plastic shield is for use with the Nylon Line Head only.
Install Metal Shield when using plastic or metal blades.

1. Snap the shield on the bottom of the bearing housing flange.
2. Place shield plate on shield, align holes & install three (3) screws.

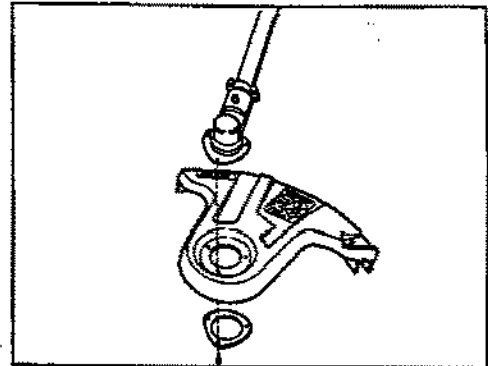

NYLON LINE HEAD INSTALLATION

Tools Required: Head Locking Tool

Parts Required: Nylon Line Head.

1. Align locking hole in upper plate with notch in edge of gear housing and insert head locking tool (A).
2. Remove rubber retainer from threaded P.T.O. Shaft (C).
3. Be sure upper plate (B) remains on PTO shaft.
4. Thread line head onto shaft by turning it counter clockwise until head is tight against upper plate (B).

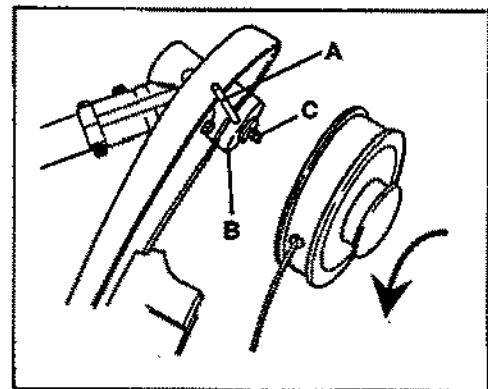

LOOP HANDLE INSTALLATION

Tools Required: Screwdriver.

Parts Required: Loop Handle, Handle Support, Four (4) 5mm x 35mm screws with captivated washers, four (4) 5mm nuts.

1. Position loop handle on drive shaft, DO NOT tighten screws yet.

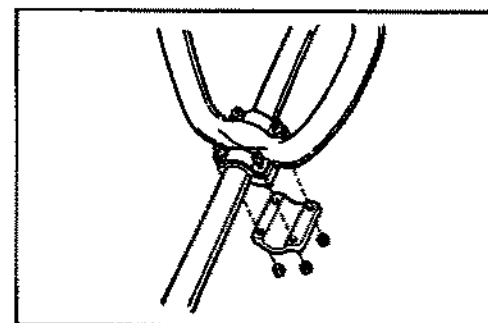

2. Position handle for comfortable operation and secure screws.



BLADE INSTALLATION

Assembly instructions for Blade conversion Kit and U-Handle Kit when operating with optional blades.
All Models.

IMPORTANT

If non-standard monofilament head, METAL/PLASTIC blade or cultivator etc. is used, THE CARBURETOR MUST BE RE-SET or serious engine damage may occur. See "Carburetor Adjustment" pages 30 and 31 and "Specifications" page 12.

WARNING DANGER

You must install a U-Handle Kit and Blade Conversion kit before operating this unit using metal blades, otherwise serious injury may result.

Install Metal Shield

Tools Required: 8mm x 10mm Open End Wrench, Screwdriver, Srench.

Parts Required: Metal Shield, Bracket, 3- 5mm x 15mm screws w/captivated flat and lockwasher (metal shield to gear housing), 2- 5mm x 8mm screws, 4- 5mm nuts, 4- 5mm lockwashers (bracket to shield and bracket to gear housing).

1. Remove nylon line head and plastic shield.
2. Loosely attach bracket (A) to shield (B) and attach to bottom of gear housing (C) with screws and nuts provided. Tighten all attaching hardware.

Install Blade

Tools Required: Locking Tool, srench.

Parts Required: Upper Plate w/20mm pilot, Lower Plate, 10mm Nut w/ LH threads, 2mm x 25mm Split Pin (cotter pin).

3. Install upper plate (D) on splined shaft. Blade installation requires use of Upper Plate (D) with 20mm pilot. Upper plate with 37mm pilot should be retained for use only with nylon line head.
4. Place Blade (E) over upper plate pilot, install the Lower Plate (F) and 10mm LH nut (G). Tri-Cut Blade (H) is installed with Glide Cup (J).
5. Insert Locking Tool (K) through hole in upper plate and notch in gear housing to prevent splined shaft from turning. Tighten nut and secure with Split Pin (L).

BLADE UPPER PLATE

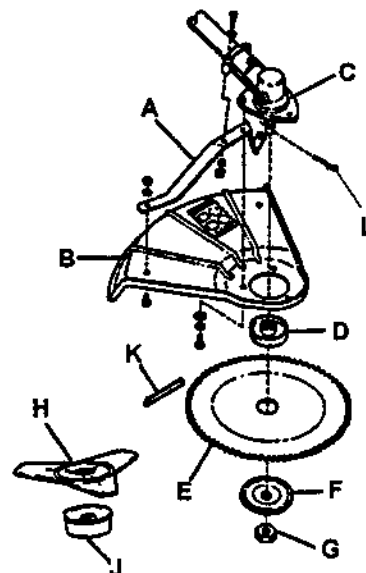
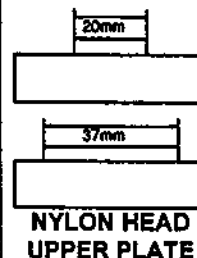

Harness Clamp Installation

Tools Required: Screwdriver, 8mm x 10mm Open End Wrench.

Parts Required: Clamp, 4mm x 18mm Hexagon Head, Bolt, Link.

6. Remove coupler from upper drive shaft assembly by loosening clamping screw (A) and removing set screw (B).

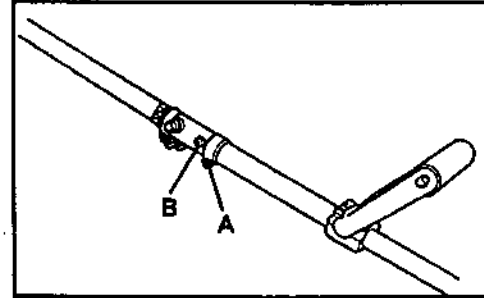

IMPORTANT

Prevent flexible drive cable from sliding from drive shaft housing. If cable does slide free, clean dirt from cable and re-lubricate with lithium based grease prior to re-assembly.

7. Remove front handle.
 - a. Remove four (4) screws and nuts and handle support from handle.
 - b. Remove handle.
8. Install clamp.

NOTE

Optional Harness for nylon line head operation uses type (A) clamp, blade operation uses type (B) clamp.

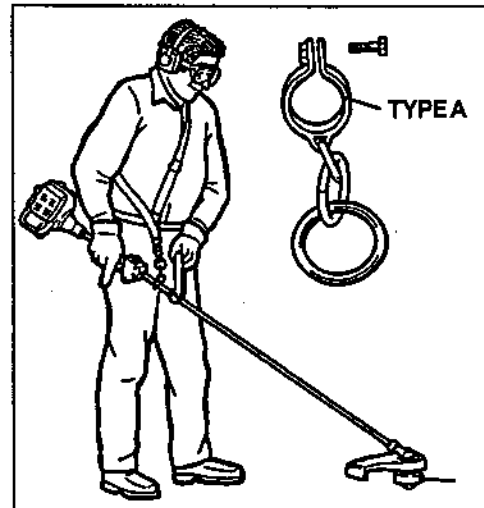

- a. Type (A) clamp installation.
 - Slightly spread clamp and slide up shaft.
 - Install hex head bolt, DO NOT tighten at this time.
- b. Type (B) clamp installation.
 - Slightly spread clamp and slide up shaft.
 - Install single link using spacer, DO NOT tighten at this time.

9. Re-install coupler and lower drive shaft assembly.

10. Balance unit.
 - a. Put on harness and attach unit to harness.
 - b. Slide clamp up or down until unit balances with head approximately 2" - 3" from the ground.
 - c. Tighten clamp screw.

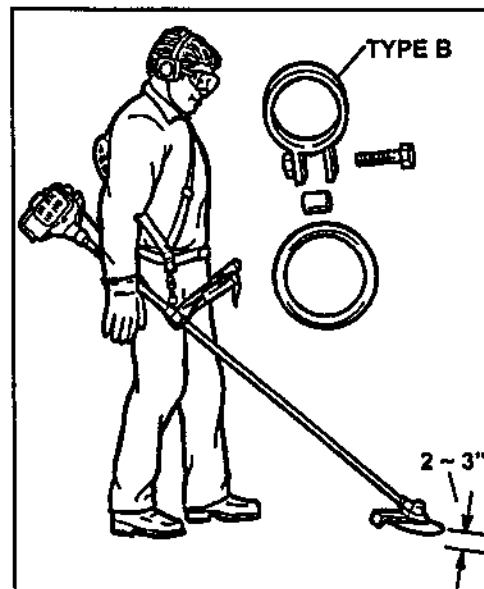

U-HANDLE INSTALLATION

Tools Required: 8mm x 10mm Open End Wrench, Screwdriver, 3mm Allen Wrench

Parts Required: U-Handle Kit.

1. Close choke and remove air filter cover.
2. Disconnect ignition stop leads (C).
3. Remove inner throttle cable from carburetor swivel (B).
4. Loosen nut (A) and remove throttle cable.
5. Loosen screws (D) and pull drive shaft assembly from clutch case.
6. Loosen four (4) rear handle screws (E) and pull rear handle throttle trigger and ignition switch assembly (D) from the drive shaft assembly.
7. Loosen four (4) screws and remove loop front handle (F).
8. Position handle bracket (G) 15 3/4 inches (400mm) from engine end of drive shaft. Secure with two (2) 6mm x 30mm bolts.
9. Install hook. Three loop hook included with Blade Conversion Kit for blade use. Position 8 5/8 inch (220mm) from engine end of drive shaft assembly. **DO NOT** tighten at this time.
10. Install handles in bracket (G), place clamp top over handles and secure with four (4) 5mm x 35mm bolts (H).

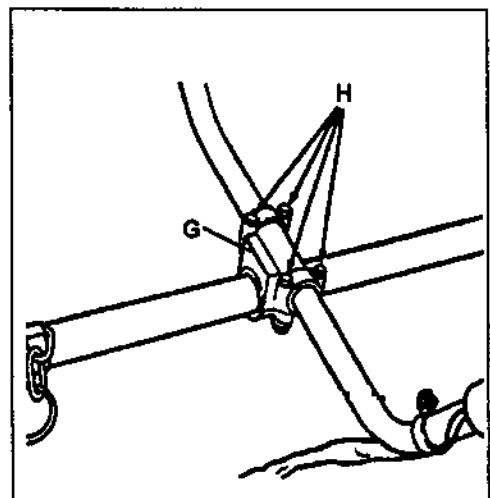
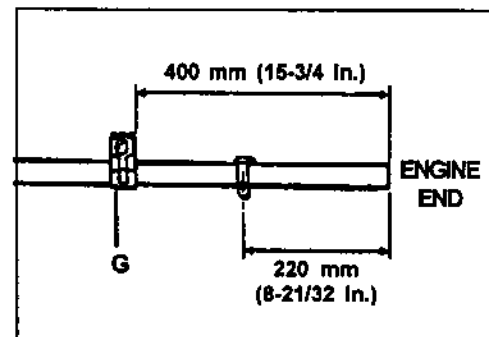
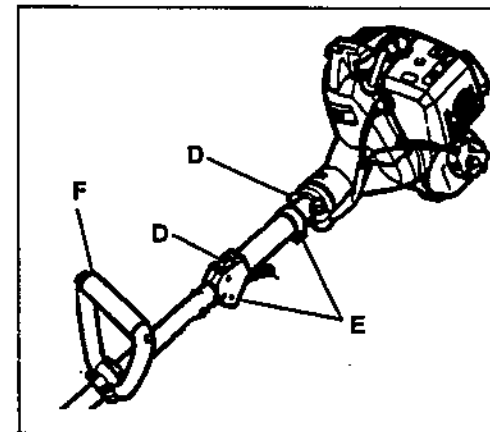
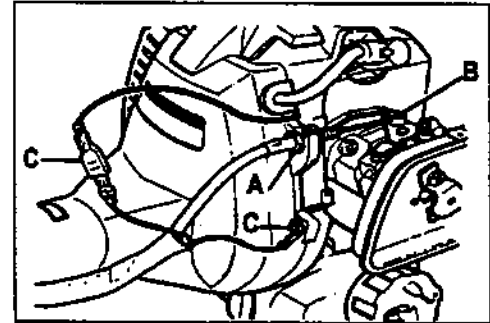

11. Secure throttle cable and leads to drive shaft by sliding wedge under harness hook.
12. Install power head and align gear box, power head and U-handles. Tighten all screws.



13. Place throttle cable in slot in bracket. One nut and washer on each side of bracket. Finger tighten both nuts (A).

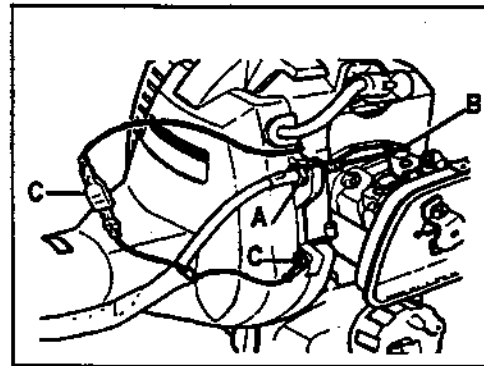

14. Attach inner cable to swivel (B). Check throttle for freedom of movement and that wide open throttle / low idle extremes are adjusted properly. If adjustment cannot be achieved with adjusting nuts, the outer cable must be adjusted by moving the Cable Adjustment Clamp (I). Consult with your Echo Dealer for correct adjustment procedure.

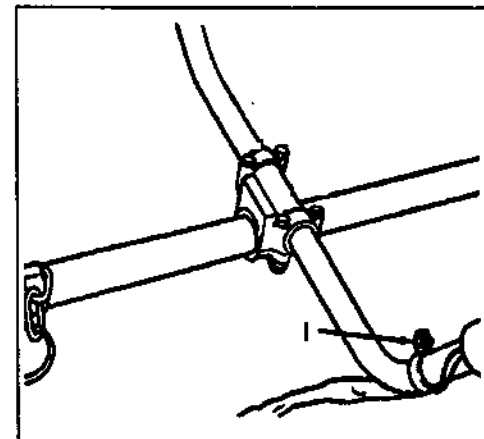

15. Attach ignition leads (C).

PRE - OPERATION

OPERATION WITH BLADES

Preparing the Trimmer/Brush Cutter for Blade Use

WARNING DANGER

Blade use **DEMANDS** specific Brush Cutter configuration. Operation without specified shield and harness can result in serious personal injury.

Plastic and Nylon Blades Require "Blade Conversion Kit," P/N 99922200410 (metal shield and shoulder harness).

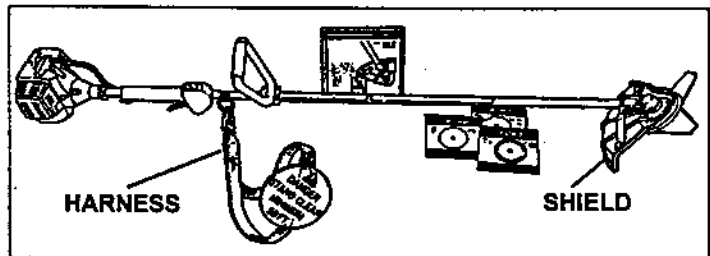

Steel/Metal Blades Require "Blade Conversion Kit" PLUS a "U-Handle Kit." P/N 35130449230 or Combination Blade and U-Handle Kit P/N 99944200450

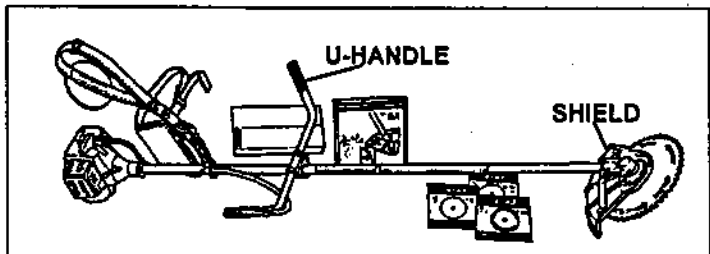

Choosing the Correct Blade

WARNING DANGER

The type of Blade used **MUST** be matched to the type and size of material cut. An improper or dull blade can cause serious personal injury. Blades **MUST** be sharp. Dull blades increase the chance of kick out and injury to yourself and bystanders.

Plastic/Nylon Blades may be used where ever the nylon line head is used. **DO NOT** use this blade for heavy weeds or brush!

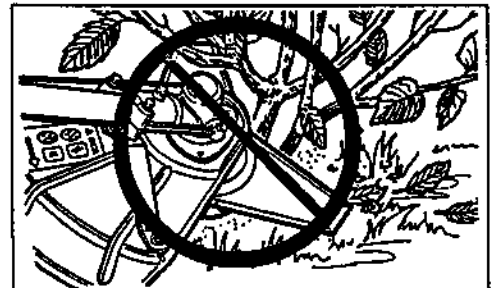

8 Tooth Weed/Grass Blade P/N 69600120331 is designed for grass, garden debris and thick weeds. **DO NOT** use this blade for brush or heavy woody growth, 3/4" (19 mm) diameter or larger.

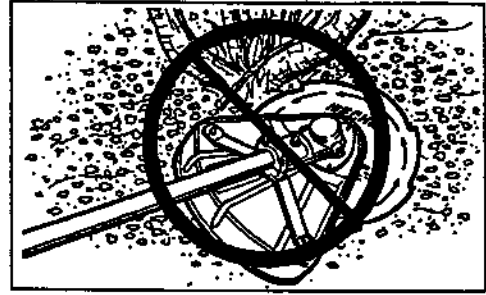

Brush/Clearing Blade P/N 69500120331 is designed for cutting brush and woody growth up to 3" (76 mm) diameter.



Use Shoulder/Waist Harness P/N 99944200200 Use of the Shoulder/Waist Harness is recommended for **ALL** Trimmer/Brush Cutter use, not just Blade operation. The Shoulder/Waist Harness when used in a trimming operation with nylon line head suspends the trimmer from the operator's shoulder and reduces operator fatigue.

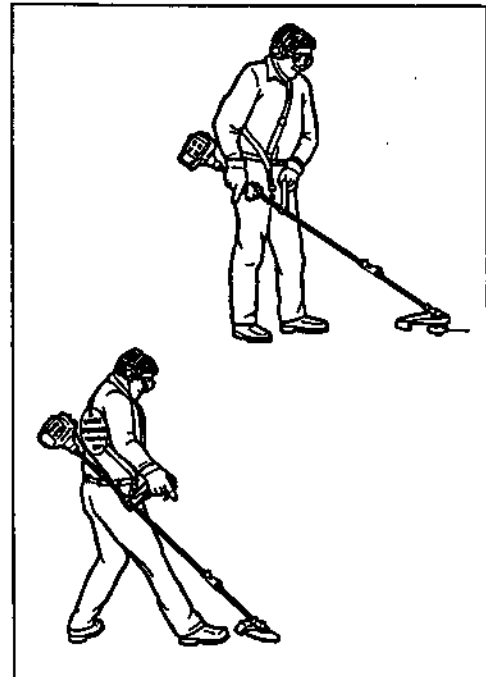

During blade operation, the same fatigue reduction is achieved. Safety to the operator is also enhanced by preventing blade contact with the operators hands and feet by restricting trimmer movement.

NOTE

In case of Emergency, pull up on the Quick Release Collar to disconnect the trimmer from the harness.

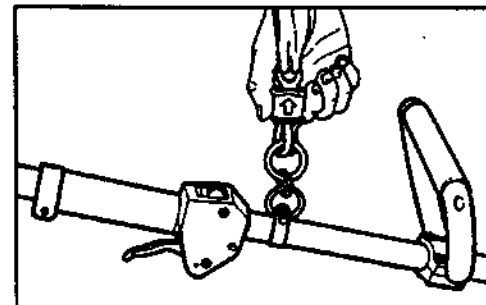

FUEL

Fuel Requirements –

Gasoline - Use 89 Octane [$R_{\frac{1}{2}}M$] gasoline known to be good quality. Gasoline may contain up to 10% Ethanol (grain alcohol) or 15% MTBE (methyl tertiary-butyl ether). Gasoline containing methanol (wood alcohol) is NOT approved.

Two Stroke Oil - A two-stroke engine oil meeting proposed ISO-L-EGD Standard (ISO/CD 13738), must be used. Echo brand Premium 50:1 oil meets this proposed standard. Engine problems due to inadequate lubrication caused by failure to use an ISO-L-EGD approved oil, such as Echo Premium 50:1 Two-stroke Oil, will void the two-stroke engine warranty. (Emission related parts only are covered for two years, regardless of two-stroke oil used, per the statement listed in the EPA Phase I/California Emission Defect Warranty Explanation.)

Mixing - Follow directions on the oil container.

Handling Fuel –

WARNING DANGER

Fuel is **VERY** flammable. Use extreme care when mixing, storing or handling or serious personal injury may result.

- Use an approved fuel container.
- **DONOT** smoke near fuel.
- **DO NOT** allow flames or sparks near fuel.
- Fuel tanks/cans may be under pressure. Always loosen fuel caps slowly allowing pressure to equalize.
- **NEVER** refuel a unit when the engine is **HOT!**
- **NEVER** refuel a unit with the engine running.
- **DO NOT** fill fuel tanks indoors. **ALWAYS** fill fuel tanks out doors over bare ground.
- Securely tighten fuel cap after refueling.
- Inspect for fuel leakage. If fuel leakage is found, do not start or operate unit until leakage is repaired.

After Refueling -

- Wipe any spilled fuel from the unit.
- Move at least 3M. (10 ft.) from refueling location before starting.

After use -

- **DO NOT** store a unit with fuel in its tank. Leaks can occur. Return unused fuel to an approved fuel storage container.

Storage -

Fuel storage laws vary by locality. Contact your local government for the laws affecting your area. As a precaution, store fuel in an approved, air tight container. Store in a well ventilated, unoccupied building, away from sparks and flames. Do not store fuel longer than 30 days.

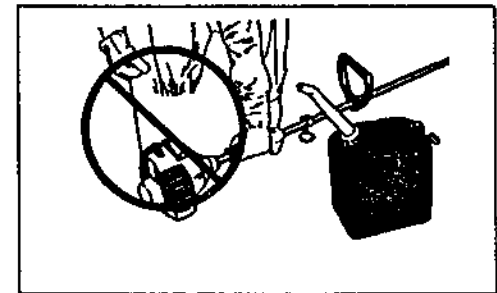
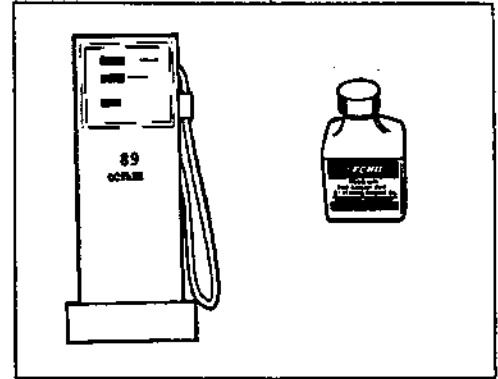

S	M	T	W	T	F	S
1	2	3	4	5	6	7
8	9	10	11	12	13	14
15	16	17	18	19	20	21
22	23	24	25	26	27	28
29	30	31				

IMPORTANT

Stored fuel ages. Do not mix more fuel than you expect to use in thirty (30) days, ninety (90) days when a fuel stabilizer is added.

IMPORTANT

Stored two-stroke fuel may separate. ALWAYS shake fuel container thoroughly before each use.

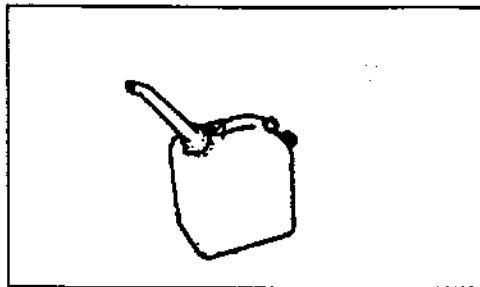

EQUIPMENT CHECK

Before operation a complete check of the unit must be performed;

- Check unit for loose/missing nuts, bolts and screws. Tighten and/or replace as needed.
- Inspect fuel lines, tank and area around carburetor for fuel leaks. DO NOT operate unit if leaks are found.
- Inspect shield for damage and ensure that the cut-off knife is securely in place. Replace if either is damaged or missing.
- Check that the cutting attachment is firmly attached and in safe operating condition.
- Check that loop (front) handle and shoulder strap/ or shoulder/waist harness is adjusted for safe, comfortable operation. See Assembly for proper adjustment.

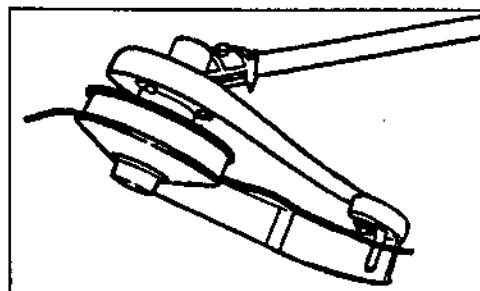
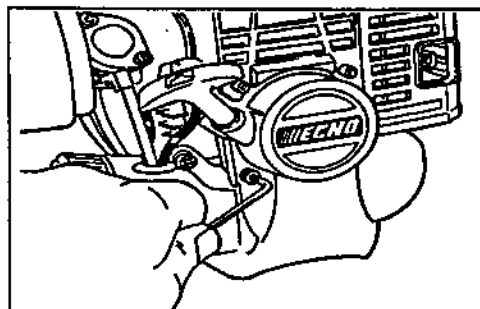

DETERMINE OPERATION AREA

- Review the area to be trimmed. Look for hazards that could contribute to unsafe conditions.
- Spectators and fellow workers must be warned, and children and animals prevented from coming nearer than 50 ft. (15M) while the trimmer is in use.

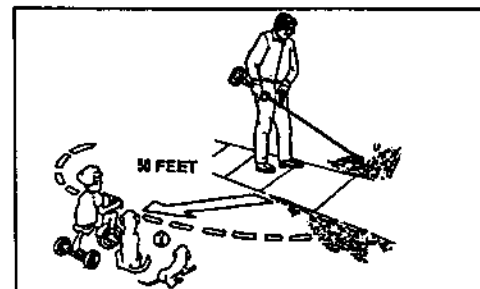

OPERATION

- Before starting the unit, equip yourself and any other person working within the 50 ft. (15M) Safety Zone with the required Protective Equipment and clothing.
- During operation, the complete unit, especially the drive shaft housing and the bearing housing may become very hot, too hot to touch. Avoid contact during and immediately after operation.

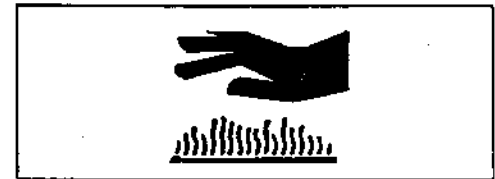

STARTING COLD ENGINE

WARNING DANGER

Trimmer head should not rotate at idle. If head rotates, readjust carburetor according to carburetor adjustment instructions in this manual or see your ECHO Dealer, otherwise serious personal injury may result.

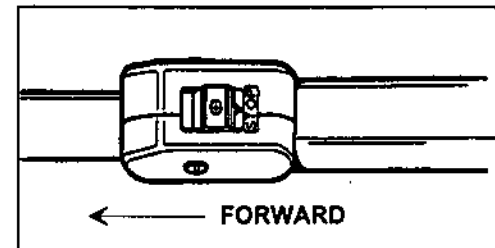

1. **Ignition Switch - Start/Run.**
Move Ignition Switch button forward away from the STOP position.
2. **Close Choke - Cold Start.**
Push choke lever forward or pull choke knob up to the Cold Start Position.
3. **Purge-Pump Bulb.**
Pump purge bulb until fuel is visible in the "Clear" fuel return line.
4. **Start - Pull Rope.**
Lay the trimmer on a flat clear area and pull the starter rope until engine fires.

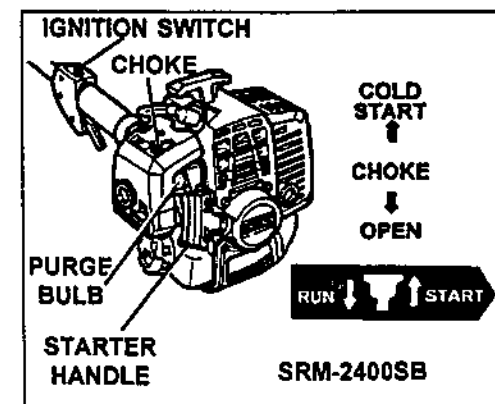
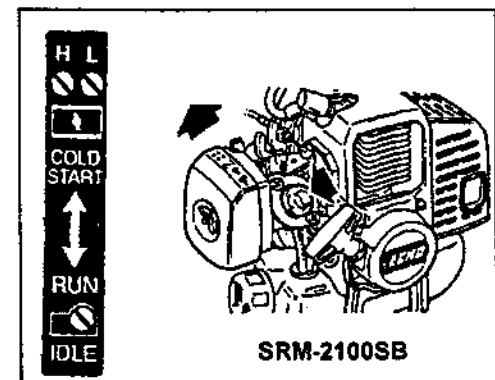

5. *Open Choke - Run.*

Push the choke lever back or push the choke knob down to the OPEN - RUN position. Restart engine if necessary and allow to warm up running at idle for several minutes.

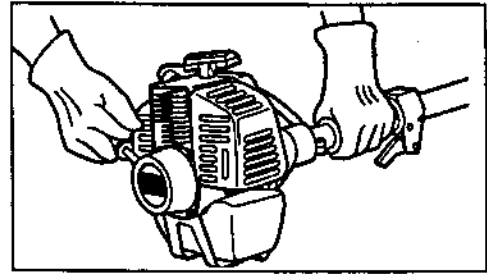

STARTING WARM ENGINE

The starting procedure is the same as Cold Start except DO NOT close the choke.

NOTE

If engine does not start after 4 pulls, use Cold Start Procedure.

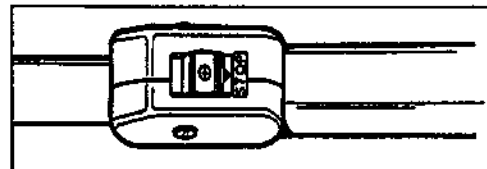

WARNING DANGER

Trimmer head should not rotate at idle. If head rotates, readjust carburetor according to carburetor adjustment instructions in this manual or see your ECHO Dealer, otherwise serious personal injury may result.

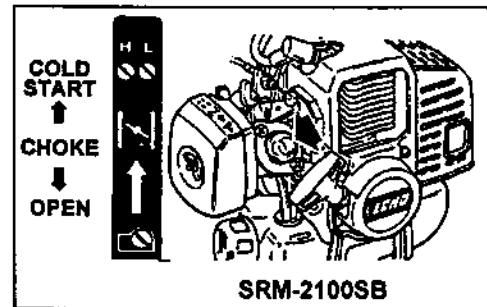

1. **Ignition Switch - Start/Run.** Move Ignition Switch button away from the STOP position.
2. **Purge - Pump Bulb.** Pump purge bulb until fuel is visible in the "Clear" fuel return line.
3. **Start - Pull Rope.** Lay the trimmer on a flat clear area and pull the starter rope until the engine fires.

STOPPING ENGINE

1. **Release Throttle.** Allow engine to idle for a minute.
2. **Ignition Switch - Stop.** Move ignition switch button backward to STOP position.

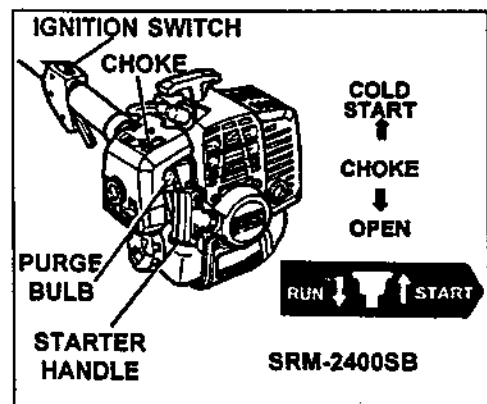

WARNING DANGER

If engine does not stop when ignition switch is moved to STOP position, close choke - COLD START position - to stall engine. Have your ECHO dealer repair ignition switch before using trimmer again.

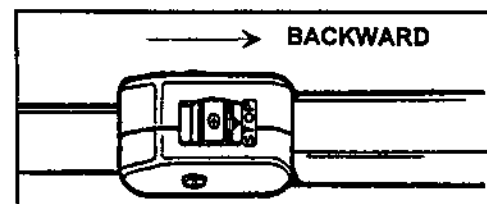

MAINTENANCE

Your ECHO unit is designed to provide many hours of trouble-free service. Regular scheduled maintenance will help your unit achieve that goal. If you are unsure or are not equipped with the necessary tools, you may want to take your unit to an ECHO Service Dealer for maintenance. To help you decide whether you want to DO-IT-YOURSELF or have the ECHO Dealer do it, each maintenance task has been graded. If a task is not listed, see your ECHO Dealer for repairs.

SKILL LEVELS

- Level 1** = Easy to do. Most required tools come with unit.
- Level 2** = Moderate difficulty. Some specialized tools may be required.
- Level 3** = Experience required. Specialized tools are required. ECHO recommends that the unit be returned to your ECHO dealer for service.

ECHO offers **REPOWER™** Maintenance Kits and Parts to make your maintenance job easier. Below each task heading are listed the various part numbers required for that task. See your ECHO dealer for these parts.

MAINTENANCE INTERVALS

COMPONENT/ SYSTEM	MAINTENANCE PROCEDURE	REQ'D SKILL LEVEL	DAILY OR BEFORE USE	EVERY REFUEL	3 MONTHS OR 90 HOURS	6 MONTHS OR 270 HOURS	YEARLY 600 HOURS
Recommended Echo Dealer Maintenance Procedures							
Cylinder Exhaust Port	Inspect/Clean/Decarbon	3			I / C		
Do-It-Yourself Maintenance Procedures							
Air Filter	Inspect/Clean/Replace	1	I / C		R*		
Choke	Inspect/Clean	2	I / C				
Fuel Filter	Inspect/Replace	1			I		I / R *
Fuel System, leaks	Inspect/Replace	1	I *	I	I		
Cooling System	Inspect/Clean	2	I / C				
Muffler Spark Arrestor	Inspect/Replace	2			I / R *		
Drive Shaft (Flex Cable Models)	Grease	2			I (1)		
Gear Housing	Grease	2			I (2)		
Recoil Starter Rope	Inspect/Clean	1	I / C *				
Spark Plug	Inspect/Clean	2			I / C	R *	
Screws/Nuts/Bolts	Inspect/Tighten/Replace	1	I / R *				

MAINTENANCE PROCEDURE LETTER CODES: I = INSPECT, R = REPLACE, C = CLEAN

IMPORTANT NOTE - Time intervals shown are maximum. Actual use and your experience will determine the frequency of required maintenance.

MAINTENANCE PROCEDURE NOTES:

(1) Apply ECHO® LUBE™ every 25 hours of use.

(2) Apply ECHO® LUBE™ every 50 hours of use.

* All recommendations to replace are based on the finding of damage or wear during inspection..

AIR FILTER

Level 1.

Tools required: Cleaning brush, 1" or 2" medium bristle paint brush.

Parts required:

SRM-2100SB 90008 REPOWER AIR & FUEL FILTER KIT.

SRM-2400SB 90030 REPOWER AIR & FUEL FILTER KIT.

1. Close choke (Cold Start Position). This prevents dirt from entering the carburetor throat when the air filter is removed. Brush accumulated dirt from the air cleaner area.
2. Remove the air cleaner cover. Clean and inspect the element for damage. If element is fuel soaked and very dirty, replace.
3. If element can be cleaned and reused, be certain it:
 - still fits the cavity in the air cleaner cover.
 - is installed with the original side out.

NOTE

Carburetor adjustment may be needed after air filter cleaning/ replacement.

FUEL FILTER

Level 1.

Tools required: Fuel line hook. 8"-10" (203-254 mm) length of wire with one end bent into a hook. Clean rag, funnel, and an approved fuel container.

Parts required:

SRM-2100SB 90008 REPOWER AIR & FUEL FILTER KIT.

SRM-2400SB 90030 REPOWER AIR & FUEL FILTER KIT.

WARNING DANGER

Fuel is **VERY** flammable. Use extreme care when mixing, storing or handling, otherwise serious personal injury may result.

1. Use a clean rag to remove loose dirt from around fuel cap and empty fuel tank.
2. Use the "fuel line hook" to pull the fuel line and filter from the tank.
3. Remove the filter from the line and install the new filter.

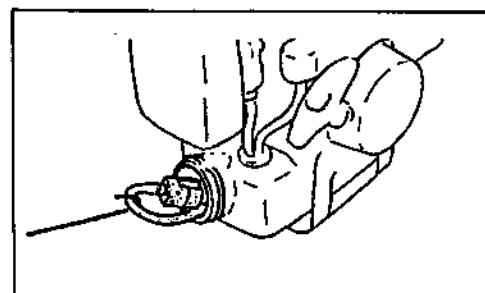
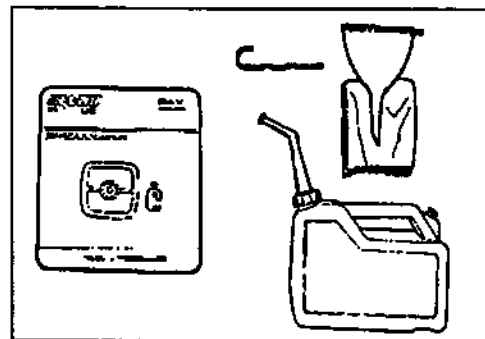
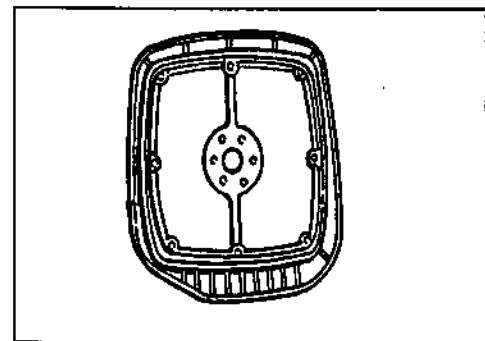
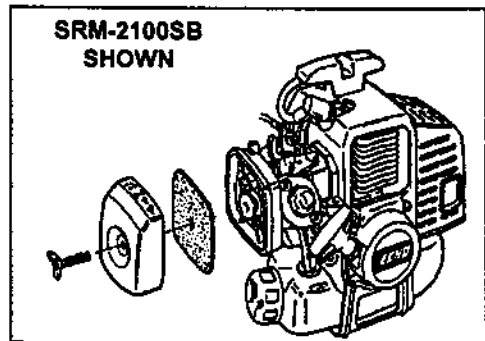
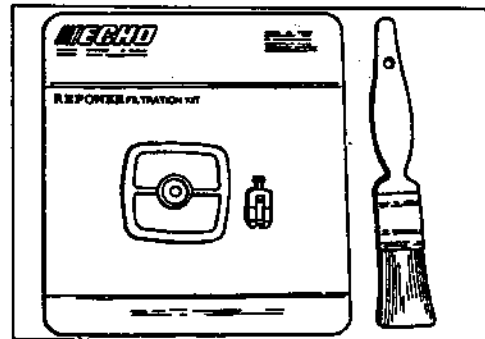

SPARK PLUG

Level 2.

Tools Required: Srench (combination socket wrench & screw driver supplied with unit) Feeler gauge, preferably a wire gauge. Brush.

Parts Required: Spark Plug, Champion CJ-7Y or NGK BPM-7A

1. Remove spark plug and check for fouling, worn and rounded center electrode.
2. Clean the plug or replace with a new one. DO NOT sand blast to clean. Remaining sand will damage engine.
3. Adjust spark plug gap by bending outer electrode.

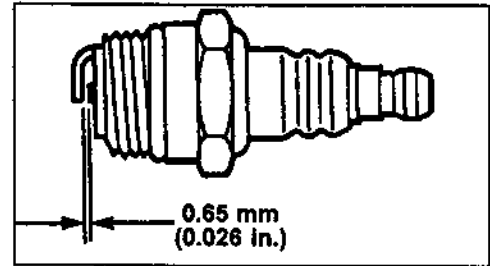
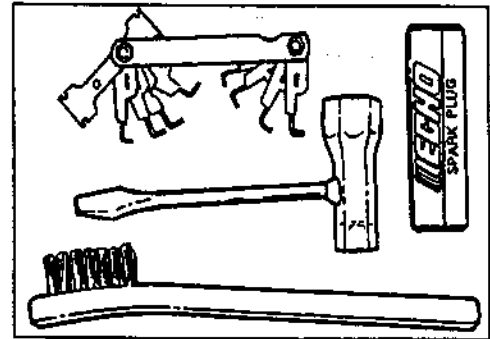

COOLING SYSTEMS CLEANING

Level 3.

Tools required: Phillips Screwdriver, 3 MM Allen Wrench, Pointed Wood Stick, Cleaning Brush, 1"-2" medium bristle paint brush.

Parts Required: None if you are careful.

IMPORTANT

To maintain proper engine operating temperatures, cooling air must pass freely through the cylinder fin area. This flow of air carries combustion heat away from the engine.

Overheating and engine seizure can occur when:

- Air intakes are blocked, preventing cooling air from reaching the cylinder.
- Dust and grass build up on the outside of the cylinder. This build up insulates the engine and prevents the heat from leaving.

Removal of cooling passage blockages or cleaning of cooling fins is considered "Normal Maintenance". Any failure attributed to lack of maintenance is not warranted.

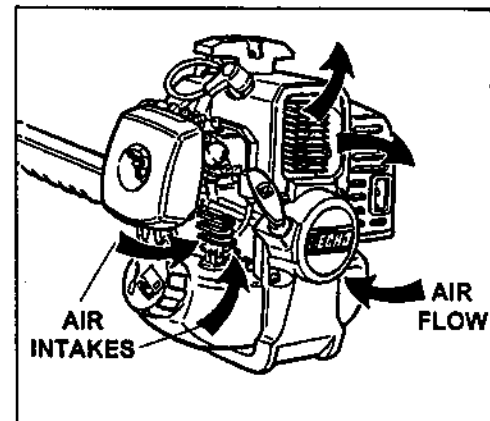
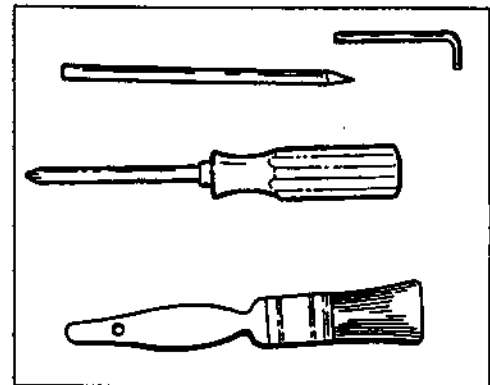

1. Remove spark plug lead & throttle cable end from the carburetor swivel.
2. Remove the four screws that retain the cover. Two at the top of the starter, two on either side of the front. Lift the cover from the engine and lay to the front of the trimmer.

NOTE

The throttle cable remains assembled to the cover and the spark plug lead and grommet remain installed.

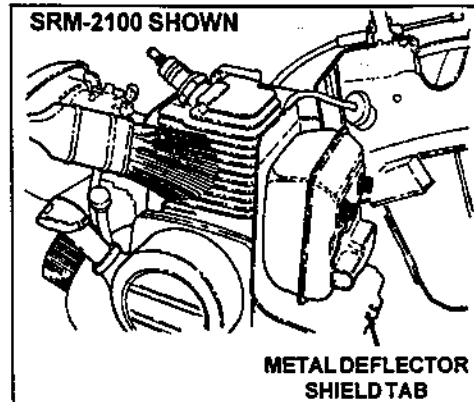

NOTE

When installing the cover, be certain the tab of the metal deflector shield is in the slot of the cover.

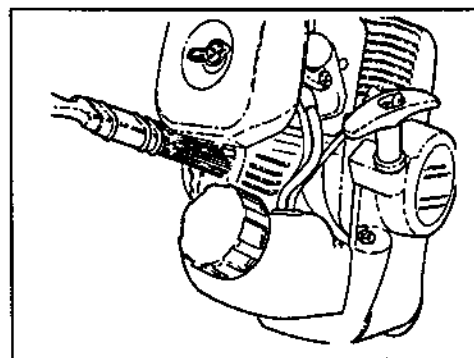

EXHAUST SYSTEM

Level 3.

Tools Required: Phillips Screwdriver. Srench. 10mm Open end wrench. Soft metal brush. Wooden carbon scraper. 3mm Allen Wrench, 4mm Allen Wrench.

Parts Required:

SRM-2100SB90000 REPOWER MAINTENANCE KIT.
SRM-2400SB90029 REPOWER MAINTENANCE KIT.

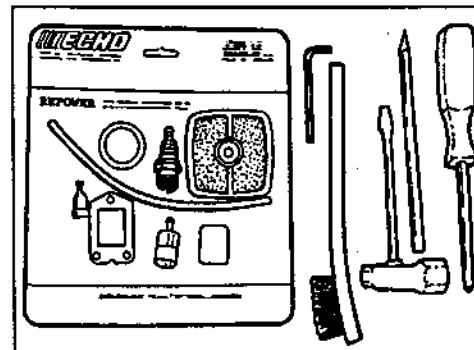

Exhaust Port

1. Remove engine cover (A). See "Cleaning Cooling System" pages 27 & 28 for step by step instructions.
2. Remove two socket head cap screws. Lift muffler and gaskets away from engine.

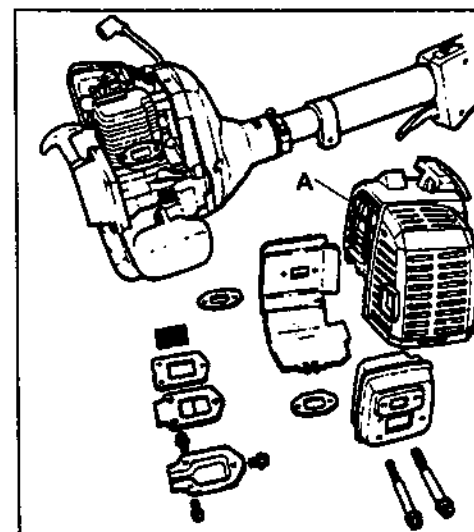

3. Place piston at Top Dead Center (TDC) to prevent carbon/dirt from entering cylinder.

IMPORTANT

DO NOT use a metal tool to remove carbon deposits. Use extreme care not to scratch piston.

4. Inspect exhaust port for carbon buildup and clean using a wooden stick.
5. Check that all loose carbon is removed from port.
6. Re-assemble using new gaskets.

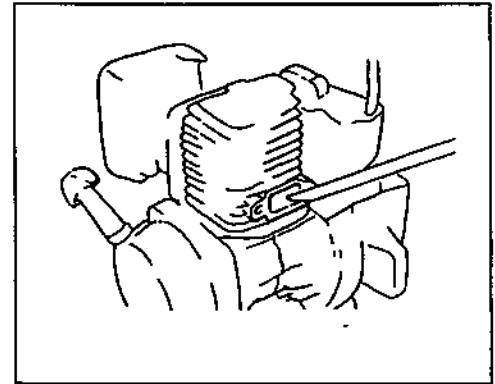

Spark Arrester Screen

1. Remove spark arrestor screen cover (A), screen holder (B), gasket (C) and screen (D) from muffler body.
2. Clean carbon deposits from screen and muffler components.
3. Replace screen if it is cracked, plugged or has holes burned through.

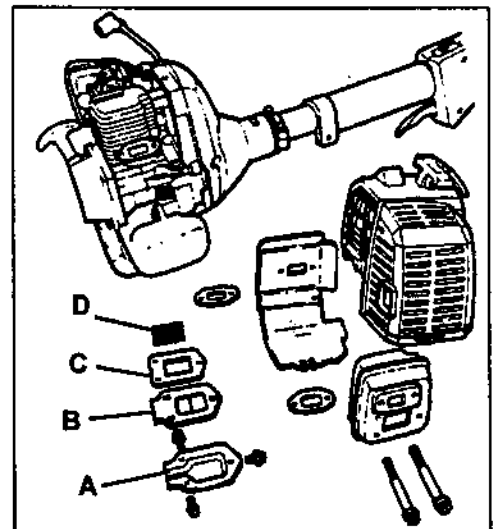

CARBURETOR ADJUSTMENT

Type 1E Models

Level 2.

Tools required: Screwdriver, Tachometer (ECHOP/N99051130017).

Parts required: None.

NOTE

Every unit is run at the factory and the carburetor is set in compliance with EPA Phase 1 and California Emission Regulations. In addition, the carburetor is equipped with HI and LO needle adjustment limiters that prevent settings outside acceptable limits.

1. Before adjusting the carburetor, clean or replace the air filter and spark arrester screen.
2. Trimmer line must be extended to the cut-off knife.
3. Start engine and run for several minutes to reach operating temperature.
4. Stop engine. Turn HI speed needle (A) CCW (counter clockwise) to stop. Turn LO speed needle (B) midway between full CCW and CW (clockwise) stops.
5. Idle Speed Adjustment.
 - Start engine and turn "idle" speed adjustment screw (C) CW until the cutting attachment begins to turn, then turn the screw CCW until attachment stops turning. Turn screw CCW an additional 1/4 turn.
6. Accelerate to full throttle for 2-3 seconds to clear excess fuel from engine then return to idle. Accelerate to full throttle to check for smooth transition from idle to full throttle. If engine hesitates, turn LO needle (B) CCW an additional 1/8 turn and repeat acceleration. Continue adjusting until smooth acceleration results.
7. Check HI speed RPM at W.O.T. (Wide Open Throttle). HI speed RPM should be set to the specifications found on Page 12 "Specifications" of this manual for the type of cutting attachment on this unit.
8. Check idle speed and reset if necessary. If a tachometer is available, idle speed should be set to the specifications found on page 12 "Specifications" of this manual.

WARNING DANGER

When carburetor adjustment is completed, the trimmer head or blade should not turn at idle, otherwise serious personal injury may result.

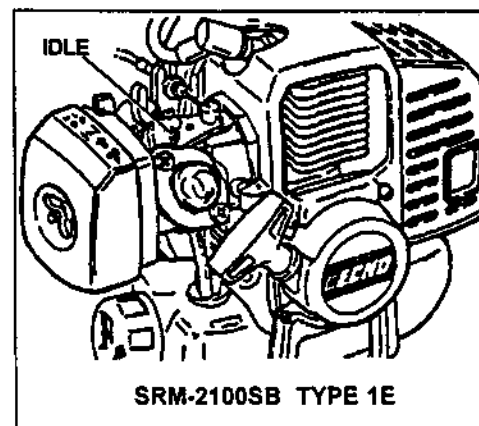
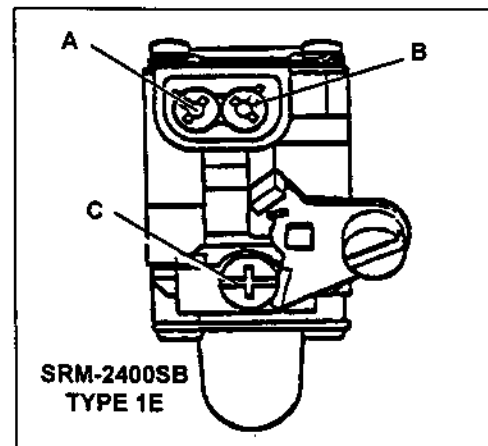
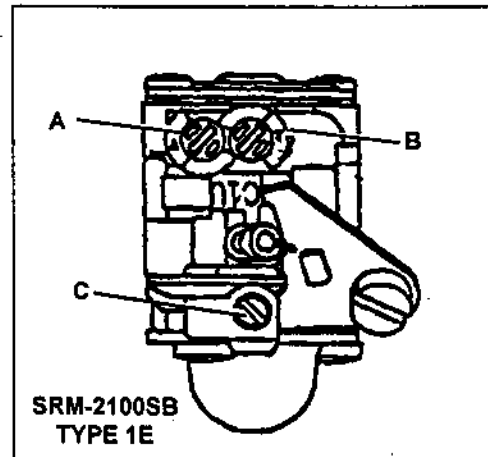
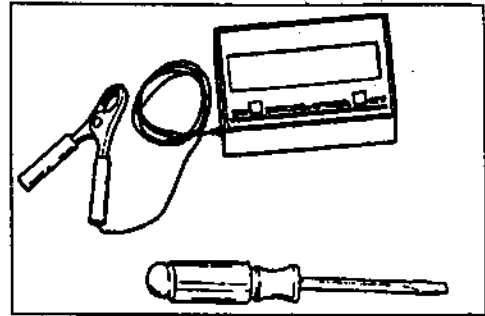

CARBURETOR ADJUSTMENT

Type I Models

Tools Required: Screwdriver, Tachometer (ECHO P/N 90051130017).

NOTE

If carburetor has limiter caps follow "Carburetor Adjustment" procedures for Type 1E models on previous page.

Idle Speed Adjustment

Turn "idle" speed adjustment screw (A) CW (clockwise) until cutting attachment begins to turn, then turn screw out CCW (counter clockwise) until attachment stops turning. Turn screw out, CCW an additional 1/4 turn.

WARNING DANGER

Trimmer head or blades must not turn when unit is idling, otherwise serious personal injury may result.

Basic Setting

1. Stop engine and turn both LO (B) and HI (C) needles in, CW until they stop and are lightly seated.

IMPORTANT

DO NOT over tighten needles. Forcing them to tighten will damage the carburetor.

2. (SRM-2100SB) Turn LO needle (B) out, CCW 2-1/2 turns. Turn HI needle (C) out CCW 2-1/8 turns. (SRM-2400SB) Turn LO needle (B) out, CCW 3 turns. Turn HI needle (C) out, CCW 2-3/4 turns.

Fine Tuning (Requires Accurate Tachometer)

1. Start engine and allow to warm to operating temperature (minimum 2 - 3 minutes) varying engine speed from idle to full throttle.
2. Always begin fine tuning with LO needle (B).
 - a. Lean drop-off - With engine idling, turn LO needle (B) slowly CW (in) to lean drop-off point. RPM will increase, then abruptly drop-off. (1) Note this position.
 - b. Rich drop-off - With engine idling, slowly turn LO needle (B) CCW (out) to rich drop-off point. RPM will increase then gradually slow and drop-off. (2) Note this position.
 - c. Final setting - Set needle at mid point between lean rich drop-off points. (3)
 - d. Turn 1/8 turn CCW (out) making mixture slightly richer (4).
3. HI speed adjustment.
Adjust HI needle (C) with tachometer. Refer to Wide Open Throttle RPM settings listed in "Specifications" on page 12.
4. Check idle speed and reset if necessary. If tachometer is available, idle speed should be set to the specifications found on page 2 "Specifications" of this manual.

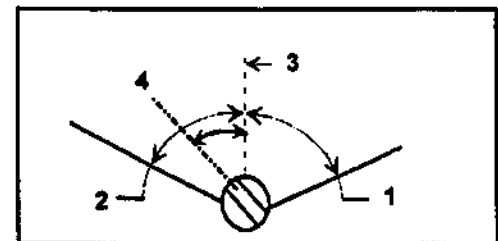
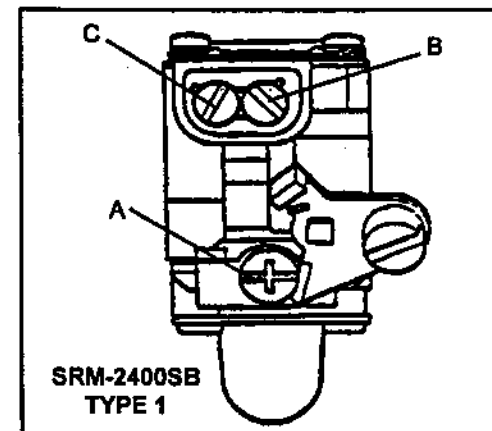
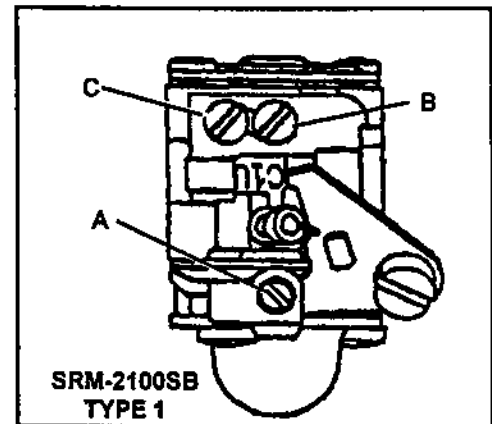

WARNING DANGER

When carburetor adjustment is completed, the trimmer head or blade should not turn at idle, otherwise serious personal injury may result.

LUBRICATION

Level 1.

Tools Required: 8 mm Open End Wrench, Screwdriver, Clean Rag.

Parts Required: Lithium Base Grease.

Gear Housing

1. Clean all loose debris from gear box.
2. Remove plug (A) and check level of grease.
3. Add grease if necessary, DO NOT over fill.

Drive Shaft (Lower)

IMPORTANT

Lower and upper drive shaft **must** be lubricated with high temperature automotive grease every 25 hours of operation, otherwise drive shaft assembly overheating and failure can result.

1. Loosen clamping knob (D).
2. Pull locator pin (A) and rotate 1/4 turn counter clockwise to lockout position.
3. Remove lower drive shaft housing.
4. Remove lower flex cable, wipe clean and apply a thin coating of (1/2 oz. (15ml) of high temperature automotive grease.
5. Reinstall cable. Carefully fit lower drive shaft assembly into coupler (B) to decal assembly line (C) making sure inner lower flex cable engages into the upper drive shaft mount. Rotate and lock locator pin (A). Tighten clamping knob (D).

Drive Shaft (Upper)

1. Remove coupler from upper drive shaft assembly by loosening clamping screw (E) and removing set screw (F).
2. Remove upper flex cable, wipe clean and apply a thin coating of (1/2 oz. (15ml) of high temperature automotive grease.
3. Reinstall cable. Make sure that the flex cable engages into the clutch mount and also into the coupler mount.
4. Install set screw (F) and tighten clamping screw (E).

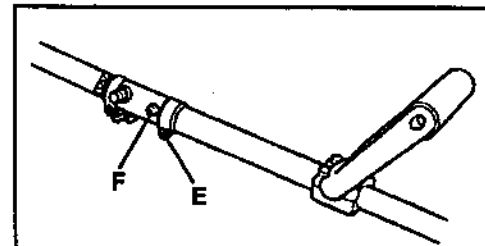
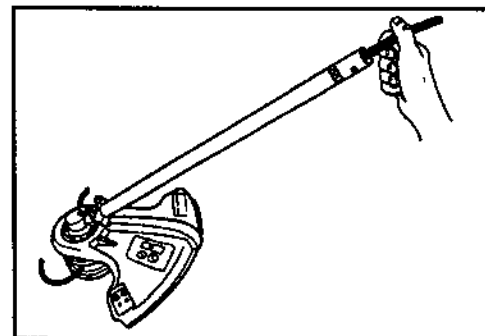
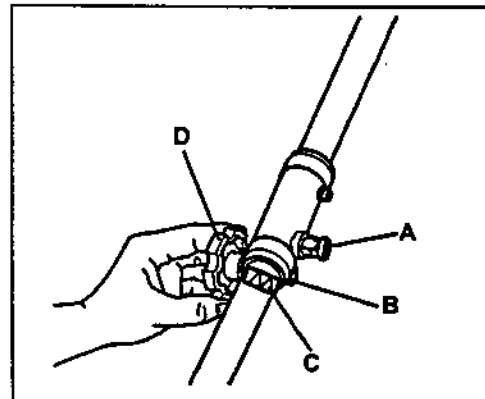
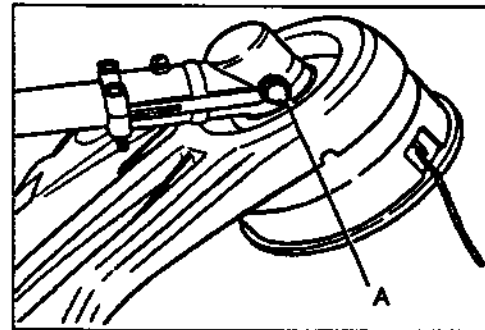
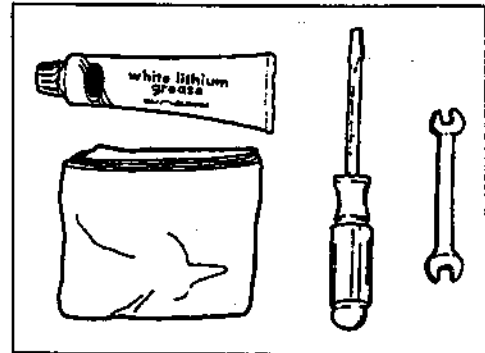

NYLON LINE REPLACEMENT

Level 1.

Tools Required: Head locking tool (if head is to be removed)

Parts Required: ECHO 0.095" Nylon Trimmer Line 40 feet (12m) long.

1. Hold drum and turn spool CW (clockwise) until it stops. Pull spool from drum. **DO NOT** push in on spool when turning.
2. Use one piece of new nylon line 40 ft. (12m) long and thread through the molded loop on the spool. Pull line tight and adjust so one end is 6 in. (15 cm) longer than the other.
3. Hold the spool, opening toward you. Place index finger between the two strands and wind the line, tightly and evenly, in the direction of the arrow marked "CC".
4. Stop when approximately 6" - 8" (15-20 cm) line remains and place ends of line in notches in spool.
5. Feed ends of line through housing eyelets and place spool over drive. Align pegs on drive with notches in spool and push spool into drum.
6. Pull on both lines until they come free from notches in spool.
7. Hold drum firmly and turn spool CCW (counterclockwise) until it stops. **DO NOT** push in on spool when turning.
8. Pull both lines out and trim to cut-off knife length.

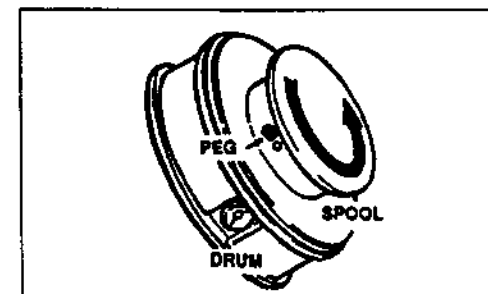
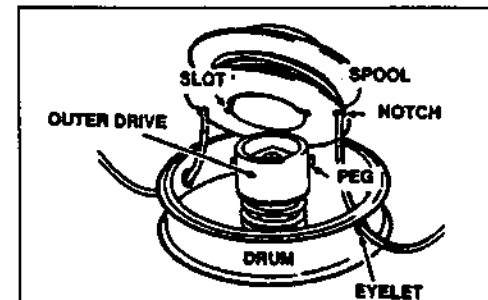
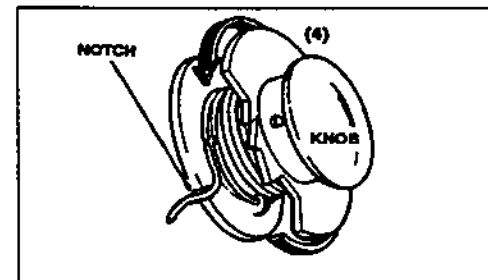
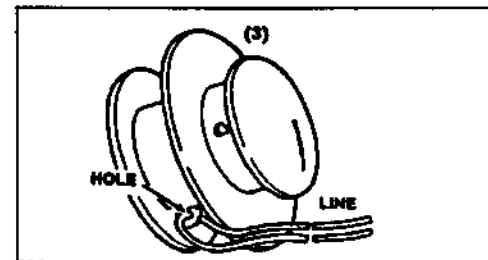
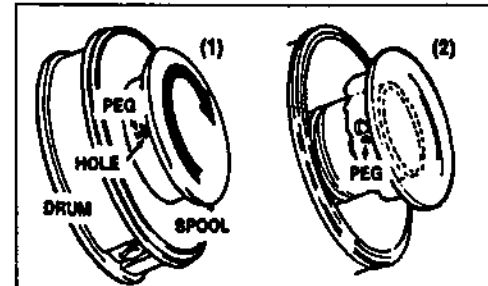
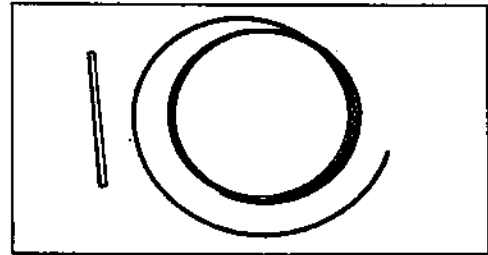

STARTER ROPE REPLACEMENT

Level 3.

Tools required: SAFETY GOGGLES, Screwdriver, 3mm Allen Wrench.

Parts Required: 35 in. (890 mm) ECHO Starter Rope, Lithium based grease.

1. Remove four (4) screws holding starter assembly on engine, remove starter.
2. Hold starter drum in place and cut off or untie knot (A). Allow the drum to slowly turn until all spring tension is relieved.

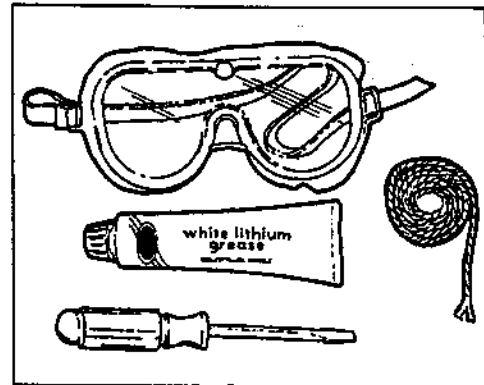

WARNING DANGER

The spring inside the starter is under tension. **DO NOT** remove screw (B) until spring tension is relieved.

IMPORTANT

The spring must not come out with the drum. If resistance is felt when lifting the drum, **STOP!** See your Authorized ECHO Service Dealer for help.

3. Remove screw (B), turn drum slightly clockwise and lift carefully and slowly away from spring.
4. Remove the old starter rope and prepare the new rope by first heating both ends to prevent fraying.
5. Pass one end of the rope through the opening of the drum and tie a knot. Press knot and end of rope in cavity of drum.

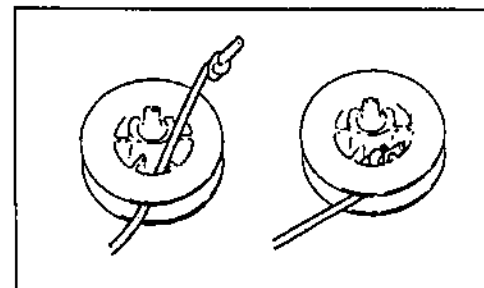
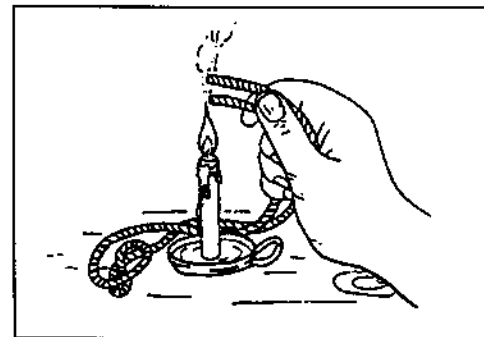
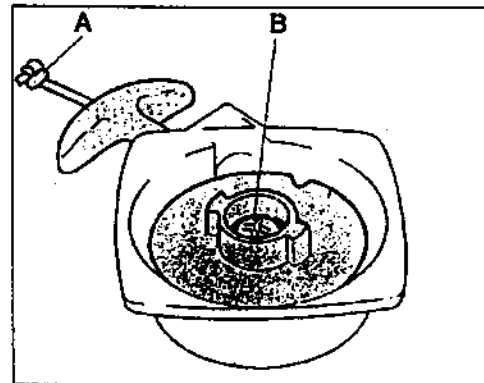

6. Thread the rope through the eyelet in the housing (C) then through the starter handle (D). Follow the illustration and tie another knot in the free end of the rope. Pull the knot into the handle.

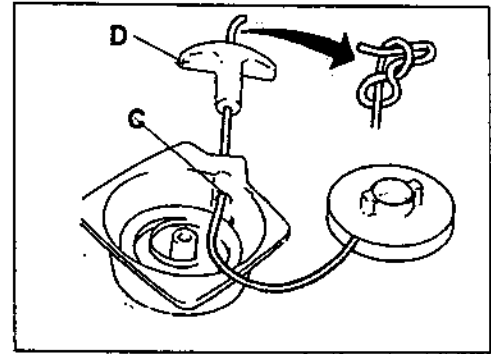

7. Check that the hook (E) on the end of the spring touches the post (F). Lightly grease the top of the spring and the post.
8. Hold the drum pawl side up and wind the rope on the drum counterclockwise, four (4) turns.

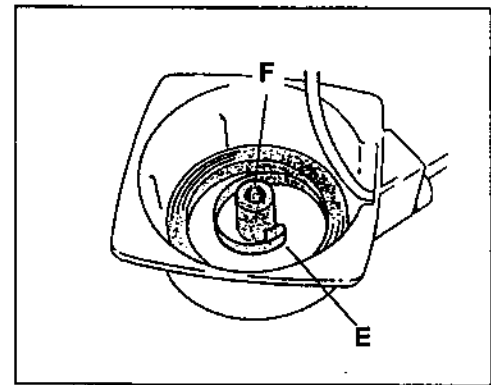

9. Install drum. The loop in the spring must engage the slot in the drum. Replace the screw and washer.

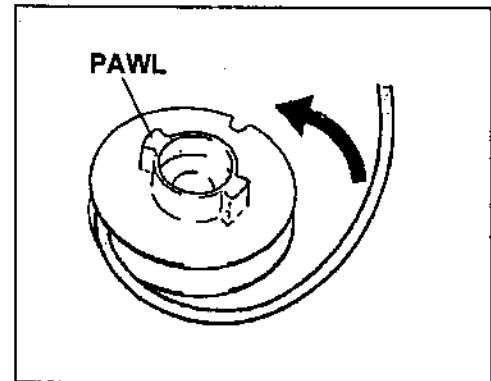

10. Hold the rope in the notch and rotate the drum counterclockwise several turns.
11. Hold the drum to prevent it from rewinding, pull the excess rope taut with the handle and allow to rewind slowly.
12. Pull rope several times to check spring tension. If rope does not rewind fully, repeat 10.
13. Pull rope out all the way. Drum must be able to turn an additional 1/2 turn counter clockwise. If drum does not turn, see your Authorized ECHO Service Dealer.

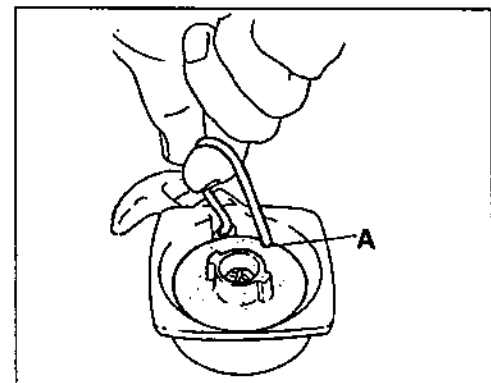

14. Install starter and test.

SHARPENING METAL BLADES

Three styles of metal blades are approved for use on the ECHO Brushcutter. The 8-tooth blade can be sharpened during normal maintenance. The clearing blade and 80 tooth blade require professional service.

Before sharpening, CLOSELY inspect blade for cracks (look at the bottom of each tooth and the center mounting hole closely), missing teeth and bending. If ANY of these problems are discovered, replace the blade.

When sharpening a blade, always remove the same amount of materials from each tooth to maintain balance. A blade that is not balanced will cause unsafe handling due to vibration and can result in blade failure.

8-tooth Blade

Tool required: Flat file (preferred). Electric grinder if special care is used. Round (rat tail) file for gullet (radius).

1. File each tooth at a 30 degree angle a specific number of times, eg. 4 strokes per tooth. Work your way around the blade until all teeth are sharp.
2. DO NOT file the 'gullet' (radius) of the tooth with the flat file. The radius must remain. A sharp corner will lead to a crack and blade failure.

IMPORTANT

If an electric grinder is used, use care not to overheat teeth, do not allow tips/tooth to glow red or turn blue. DO NOT place blade in cooling water. This will change the temper of the blade and could result in blade failure.

3. After sharpening teeth, check each tooth radius for evidence of a square (sharp) corner. Use the round (rat tail) file to renew the radius.

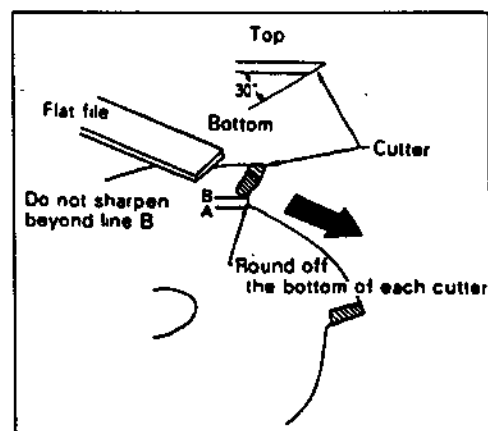
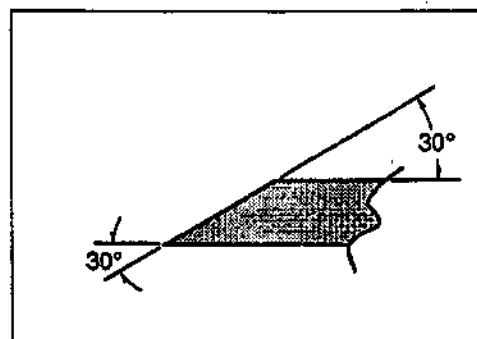
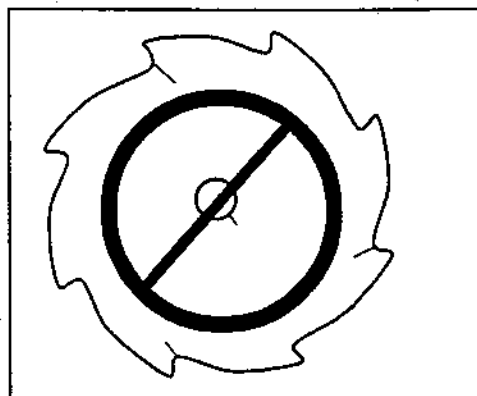

TROUBLESHOOTING

Problem		Cause	Remedy
Engine — starts hard — does not start			
Engine Cranks	Fuel at carburetor ↓ No fuel at carburetor	Fuel strainer clogged Fuel line clogged Carburetor	Clean Clean See your Echo dealer
	Fuel at cylinder ↓ No fuel at cylinder	Carburetor	See your Echo dealer
	Muffler wet with fuel	Fuel mixture is too rich	Open choke Clean/replace air filter Adjust carburetor See your Echo dealer
	Spark at end of plug wire ↓ No spark at end of plug wire	Ignition switch off Electrical problem Interlock switch	Turn switch on See your Echo dealer See your Echo dealer
	Spark at plug ↓ No spark at plug	Spark gap incorrect Covered with carbon Fouled with fuel Spark plug defective	Adjust. 0.65 mm (0.026 in.) Clean or replace Clean or replace Replace plug
Engine does not crank		Internal engine problem	See your Echo dealer
Engine runs	Dies or Accelerates poorly	Air filter dirty Fuel filter dirty Fuel vent plugged Spark plug Carburetor Cooling system plugged Exhaust port/spark arrestor screen plugged	Clean or replace Replace Replace Clean and adjust/replace Adjust Clean Clean

STORAGE

Long Term Storage (over 30 days)

Do not store your unit for a prolonged period of time (30 days or longer) without performing protective storage maintenance which includes the following:

1. Store unit in a dry, dust free place, out of the reach of children.

WARNING **DANGER**

Do not store in enclosure where fuel fumes may accumulate or reach an open flame or spark.

2. Place the ignition in the "OFF" position.
3. Remove accumulation of grease, oil, dirt and debris from exterior of unit.
4. Perform all periodic lubrication and services that are required.
5. Tighten all the screws and nuts.
6. **Drain the fuel tank completely** and pull the starter handle several times to remove fuel from the carburetor.
7. Remove the spark plug and pour 1/4 oz. (1/2 tablespoon) of fresh, clean, two-stroke engine oil into the cylinder through the spark plug hole.
 - A. Place a clean cloth over the spark plug hole.
 - B. Pull the recoil starter handle 2-3 times to distribute the oil inside the engine.
 - C. Observe the piston location through the spark plug hole. Pull the recoil handle slowly until the piston reaches the top of its travel and leave it there.
8. Install the spark plug (do not connect ignition cable).

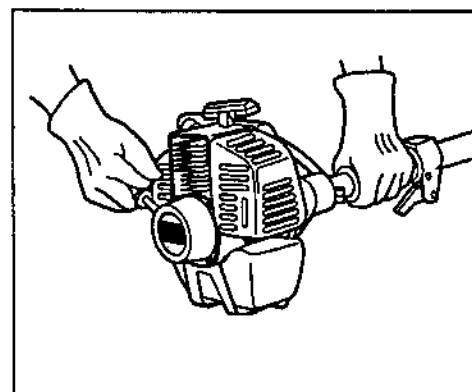
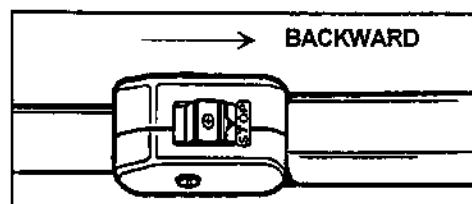

SERVICING INFORMATION

PARTS --

Genuine ECHO Parts and ECHO Re Power Parts and Assemblies for your ECHO products are available only from an Authorized ECHO Dealer. When you do need to buy parts always have the Model Number, Type number and Serial Number of the unit with you. You can find all three numbers on the engine housing. For future reference, write them in the space provided below.

Model No. _____ Type No. _____ SN. _____

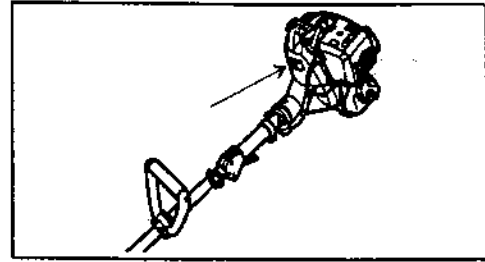

SERVICE --

Service of this product during the warranty period must be performed by an Authorized ECHO Service Dealer. For the name and address of the Authorized ECHO Service Dealer nearest you, ask your retailer or call: 1-800-432-ECHO. When presenting your unit for Warranty service/repairs, proof of purchase is required.

DEALER?
Call
1-800-432-ECHO

WARRANTY CARD --

This card is our means of registering all original owners of ECHO equipment. The card plus proof of purchase provides you the assurance that authorized warranty work will be done. It also provides a direct link between you and ECHO if we find it necessary to contact you.

ECHO LIMITED WARRANTY REGISTRATION CARD (Part of Limited Warranty. Subject to ECHO's Standard Warranty Terms)																			
<table border="1"> <tr> <td>NAME</td> <td>DATE</td> </tr> <tr> <td>ADDRESS</td> <td>PHONE</td> </tr> <tr> <td>CITY</td> <td>STATE</td> </tr> <tr> <td>ZIP</td> <td></td> </tr> <tr> <td>MODEL NO.</td> <td>TYPE NO.</td> </tr> <tr> <td>SERIAL NO.</td> <td></td> </tr> <tr> <td>DATE PURCHASED</td> <td></td> </tr> <tr> <td>DEALER NAME</td> <td>DEALER ADDRESS</td> </tr> <tr> <td>DEALER PHONE</td> <td></td> </tr> </table>		NAME	DATE	ADDRESS	PHONE	CITY	STATE	ZIP		MODEL NO.	TYPE NO.	SERIAL NO.		DATE PURCHASED		DEALER NAME	DEALER ADDRESS	DEALER PHONE	
NAME	DATE																		
ADDRESS	PHONE																		
CITY	STATE																		
ZIP																			
MODEL NO.	TYPE NO.																		
SERIAL NO.																			
DATE PURCHASED																			
DEALER NAME	DEALER ADDRESS																		
DEALER PHONE																			
<table border="1"> <tr> <td> <input type="checkbox"/> 1 Year <input type="checkbox"/> 2 Years <input type="checkbox"/> 3 Years <input type="checkbox"/> 4 Years <input type="checkbox"/> 5 Years <input type="checkbox"/> 6 Years <input type="checkbox"/> 7 Years <input type="checkbox"/> 8 Years <input type="checkbox"/> 9 Years <input type="checkbox"/> 10 Years </td> <td> <input type="checkbox"/> 1 Year <input type="checkbox"/> 2 Years <input type="checkbox"/> 3 Years <input type="checkbox"/> 4 Years <input type="checkbox"/> 5 Years <input type="checkbox"/> 6 Years <input type="checkbox"/> 7 Years <input type="checkbox"/> 8 Years <input type="checkbox"/> 9 Years <input type="checkbox"/> 10 Years </td> </tr> </table>		<input type="checkbox"/> 1 Year <input type="checkbox"/> 2 Years <input type="checkbox"/> 3 Years <input type="checkbox"/> 4 Years <input type="checkbox"/> 5 Years <input type="checkbox"/> 6 Years <input type="checkbox"/> 7 Years <input type="checkbox"/> 8 Years <input type="checkbox"/> 9 Years <input type="checkbox"/> 10 Years	<input type="checkbox"/> 1 Year <input type="checkbox"/> 2 Years <input type="checkbox"/> 3 Years <input type="checkbox"/> 4 Years <input type="checkbox"/> 5 Years <input type="checkbox"/> 6 Years <input type="checkbox"/> 7 Years <input type="checkbox"/> 8 Years <input type="checkbox"/> 9 Years <input type="checkbox"/> 10 Years																
<input type="checkbox"/> 1 Year <input type="checkbox"/> 2 Years <input type="checkbox"/> 3 Years <input type="checkbox"/> 4 Years <input type="checkbox"/> 5 Years <input type="checkbox"/> 6 Years <input type="checkbox"/> 7 Years <input type="checkbox"/> 8 Years <input type="checkbox"/> 9 Years <input type="checkbox"/> 10 Years	<input type="checkbox"/> 1 Year <input type="checkbox"/> 2 Years <input type="checkbox"/> 3 Years <input type="checkbox"/> 4 Years <input type="checkbox"/> 5 Years <input type="checkbox"/> 6 Years <input type="checkbox"/> 7 Years <input type="checkbox"/> 8 Years <input type="checkbox"/> 9 Years <input type="checkbox"/> 10 Years																		
IN ORDER TO QUALIFY FOR THE ECHO LIMITED WARRANTY, THE PURCHASER MUST REGISTER THIS CARD WITHIN 90 DAYS OF THE DATE OF PURCHASE.																			

ADDITIONAL OR REPLACEMENT MANUALS --

Safety Manuals are available, free of charge, from your ECHO dealer or by contacting Echo Incorporated, 400 Oakwood Road, Lake Zurich, IL 60047

Operators and Parts Manuals are available for purchase from your ECHO dealer or directly from ECHO. [See ordering instructions at the end of this manual.]

ECHO Incorporated
400 Oakwood Road
Lake Zurich, IL 60047

Technical Publications Orders

ORDERING INSTRUCTIONS

To obtain a Parts Catalog or Operator's Manual send a check or money order for \$2.00 per Parts Catalog or \$1.50 per Operator' Manual made payable to ECHO, INCORPORATED. State on a sheet of paper model number and serial number of the ECHO unit you have, part number of the manual (if known), your name and address and mail to address above.

Available Parts Lists

SRM-2100SB TYPE 1/E S/N 001001 & UP
SRM-2400SB TYPE 1/E S/N 001001 & UP

PART NUMBER 99922202870
PART NUMBER 99922202871

ECHO
ECHO, INCORPORATED
400 OAKWOOD ROAD
LAKE ZURICH, IL 60047

Free Manuals Download Website

<http://myh66.com>

<http://usermanuals.us>

<http://www.somanuals.com>

<http://www.4manuals.cc>

<http://www.manual-lib.com>

<http://www.404manual.com>

<http://www.luxmanual.com>

<http://aubethermostatmanual.com>

Golf course search by state

<http://golfingnear.com>

Email search by domain

<http://emailbydomain.com>

Auto manuals search

<http://auto.somanuals.com>

TV manuals search

<http://tv.somanuals.com>