

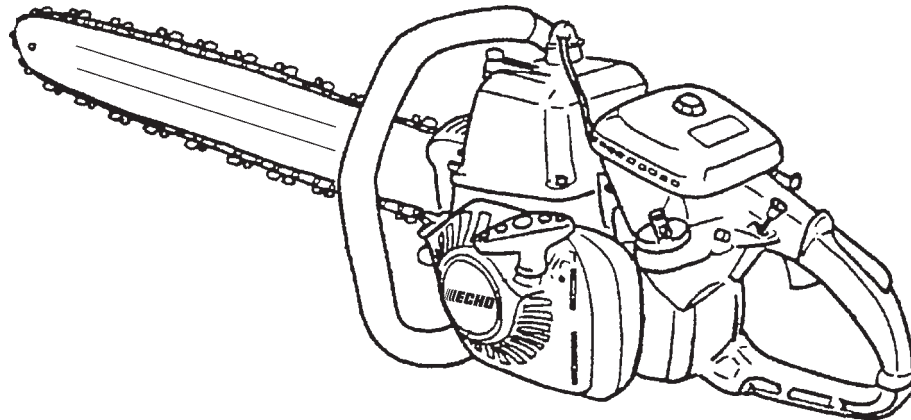

GB ENGLISH



OPERATOR'S MANUAL

CHAIN SAW

CS-1201



WARNING  **DANGER**

**READ INSTRUCTIONS CAREFULLY AND FOLLOW RULES FOR
SAFE OPERATION.
FAILURE TO DO SO COULD RESULT IN SERIOUS INJURY.**

INTRODUCTION









This manual shows rules of safe operation, proper use, servicing, and maintenance of your ECHO chain saw. Follow these instructions in order to maintain a good operating condition and a long service life. Misuse of the chain saw can cause serious bodily injury.

It is important for you to understand all safety precautions correctly before using your chain saw. This chain saw is designed for cutting wood or wood products. Do not cut solid metal, sheet metal, plastic or any non-wood materials. If there is any clause in this Manual that is hard to be understood, please contact your ECHO dealer.

CONTENTS

INTRODUCTION	2	SERVICE MAINTENANCE GUIDE	14
DECALS AND SYMBOLS	2	TROUBLE SHOOTING	14
RULES FOR SAFE OPERATION	2	SERVICE	15
PARTS IDENTIFICATION	7	SAW CHAIN MAINTENANCE	17
ASSEMBLY	8	STORAGE	18
OPERATION	8	SPECIFICATIONS	19
CUTTING INSTRUCTION	10		

DECALS AND SYMBOLS

Symbol form/shape	Symbol description/application	Symbol form/shape	Symbol description/application
	This symbol accompanied by the words WARNING and DANGER calls attentions to an act or a condition which can lead to serious personal injury or death.		Petrol and oil mixture
	Circle and slash symbol means whatever is shown is prohibited.		Chain oil fill / oil pump
	This enclosed message provides tips for use, care and maintenance of the unit.		Carburettor adjustment - Low speed mixture
			Carburettor adjustment - High speed mixture
			Carburettor adjustment - Idle speed



RULES FOR SAFE OPERATION

1. GENERAL PRECAUTIONS

OPERATOR'S MANUAL

- Read the operator's manual for your chain saw carefully.
Be thoroughly familiar with the chain saw's controls and how to use the chain saw properly. Failure to follow instructions could lead to personal injury.
- If you have any questions or problems, please contact your ECHO dealer.

PHYSICAL CONDITION

- Do not operate a chain saw when you are fatigued or under the influence of alcohol or drugs.
- You should be in good physical and mental health in order to handle your chain saw safely. Errors in judgement or execution can be serious or fatal. If you have any physical condition which strenuous work could worsen, check with your physician before using a chain saw.
Do not operate when ill or fatigued, or under the influence of any substance or medication which could affect your vision, dexterity or judgement.

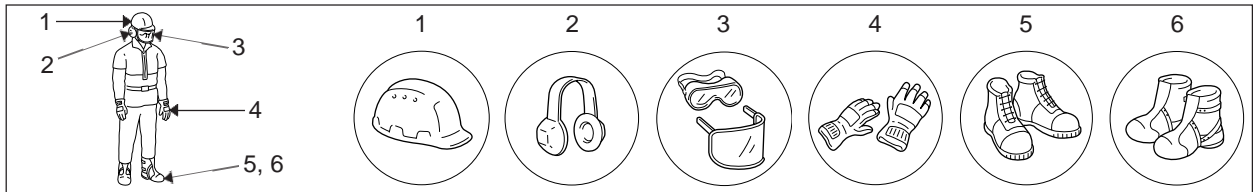

PERSONAL EQUIPMENT

- Always wear approved goggles to protect your eyes. Wood chips, dust, snapping branches and other debris can be thrown by the cutting chain into the operator's facial area. Goggles may also offer limited protection in the event of the cutting chain hitting the operator in the eye area. If conditions warrant that a ventilated face shield be worn, goggles must be worn underneath it.
- ECHO recommends wearing hearing protection at all times. If not followed, hearing loss can occur. You should reduce the risk of hearing damage by wearing either "headset" type protectors or ear plugs which are approved by an authorized organization.



- Never wear loose clothing, unbuttoned jackets, flared sleeves and cuffs, scarves, tie-strings, neckties, cords, chains, jewelry, etc. which could snag the saw chain or underbrush.
- Clothing should be of sturdy, protective material. It should be snug-fitting to resist snagging, but roomy enough for freedom of movement.
- Trousers legs should not be flared or cuffed, and should be either tucked into the boot tops or trimmed short.

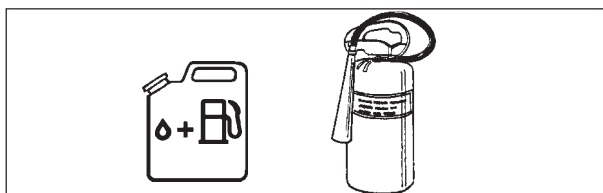

FUEL

WARNING **DANGER**

- **PETROL AND FUEL ARE EXTREMELY FLAMMABLE. IF SPILLED OR IGNITED BY IGNITION SOURCE, IT CAN CAUSE FIRE AND SERIOUS INJURY OR PROPERTY DAMAGE. EXTREME CAUTION IS REQUIRED WHEN HANDLING PETROL OR FUEL.**
- **AFTER REFUELLING, TIGHTEN FUEL CAP FIRMLY AND CHECK FOR LEAKAGE. IN CASE OF FUEL LEAKAGE, REPAIR BEFORE STARTING OPERATION SINCE THERE IS A DANGER OF FIRE.**

- Use an appropriate type of fuel container.
- Do not smoke or bring flame or sparks near to fuel supplies.

CAUTION

Stuffing ears with cotton is not recommended.

- All persons who make part of their living using chain saws should be tested periodically for hearing deterioration.
- Always wear a cap or hat when working with a chain saw. A safety hard hat is highly recommended when felling or working under trees, or when objects can fall on you.
- Wear heavy duty, non-slip gloves for improved grip, and also for protection against cold and vibration.
- Safety tip shoes or boots with non-slip sole should be worn.

- Safety vests, leg chaps and logger's pants of ballistic material are available. It is the operator's responsibility to wear such additional protection if conditions warrant it.
- Never operate a chain saw when you are alone. Arrange to have someone remain within calling distance in case you need help.

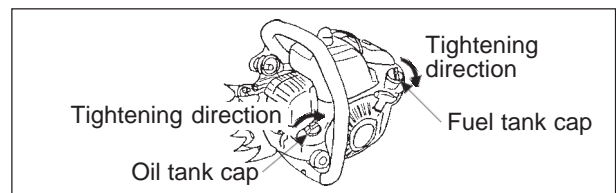

- The fuel tank may be under pressure. Always loosen the fuel cap and wait for pressure to be equalized before removing the cap.
 - Fill the fuel tank outdoors over bare ground and install the fuel cap securely. Do not pour fuel indoors.
 - Wipe any spilled fuel off the unit.
 - Never refuel while the engine is still hot, or fuel a running engine.
 - Do not store the unit with fuel in its tank, because a fuel leak could start a fire.
 - Bring an extinguisher or shovel in case of fire.
- Despite the precautions which can be taken, operating a chain saw, or just working in the forest, presents dangers.

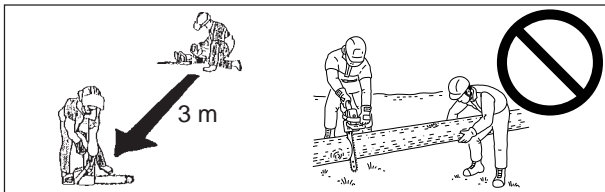

STARTING ENGINE

- Move the chain saw at least 3 m from the fuelling point before starting the engine.
- Do not allow other persons to be near the chain saw when you are starting or cutting with the chain saw. Keep bystanders and animals out of the work area. Do not let anyone hold wood for you to cut.
- Do not start cutting until you have a clear work area, secure footing and a planned retreat path from the falling tree.
- Before you start the engine, make sure that the saw chain is not contacting anything.
- Keep the handles dry, clean, and free of oil or fuel mixture.
- Operate the chain saw only in well-ventilated areas. Exhaust gas, oil mist (from chain saw lubrication) or saw dust saw is harmful to health.

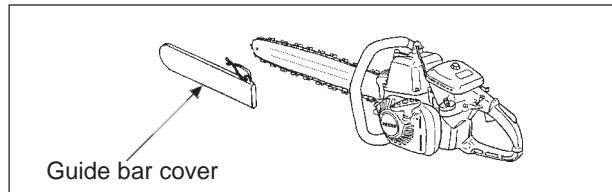

TRANSPORTATION

- When transporting your chain saw, use the appropriate guide bar cover.
- Carry the chain saw with the engine stopped, the guide bar and saw chain to the rear, and the silencer away from your body.

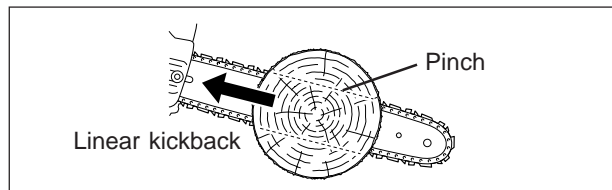
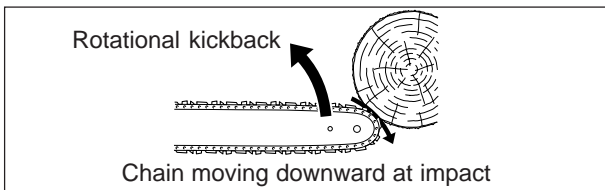

2. KICKBACK SAFETY PRECAUTIONS

WARNING  **DANGER**
KICKBACK SAFETY PRECAUTION FOR CHAIN SAW USERS: KICKBACK MAY OCCUR WHEN THE NOSE OR TIP OF THE GUIDE BAR TOUCHES AN OBJECT OR WHEN THE WOOD CLOSES IN AND PINCHES THE SAW CHAIN IN THE CUT.

- In some cases, tip contact may cause a lightning-fast reverse reaction, kicking the guide bar up and back toward the operator (this is called a rotational kickback). Pinching the saw chain along the top of the guide bar may push the guide bar rapidly back toward the operator (this is called a linear kickback).

- Either or these reactions may cause you to lose control of the saw and come in contact with the moving chain, which could result in serious personal injury. As a chain saw user, you should take several steps to keep your cutting jobs free from accident or injury.
- With a basic understanding of kickback, you can reduce or eliminate the element of surprise. Sudden surprise contributes to accidents. Understand that rotational kickback is preventable by keeping an unshielded bar nose from touching an object or the ground.

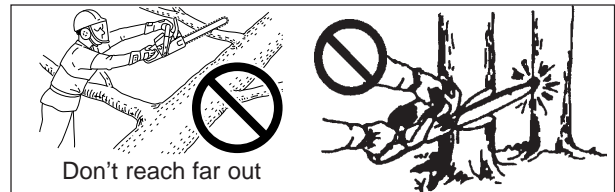
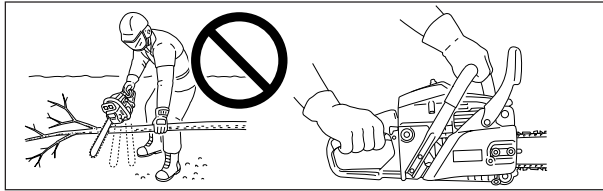

- Do not operate a chain saw with one hand! Serious injury to the operator, helpers or bystanders may result from one-handed operation. For proper control, always use two hands when operating a chain saw, one of which operates the trigger. Otherwise, this can result in the chain saw “skating” or skidding, which can result in personal injury due to loss of control.
- Keep a good firm grip on the saw which both hands, with the right hand on the rear handle and the left hand on the front handle, when the engine is running. Use a firm grip with thumbs and fingers enriching the chain saw handles. A firm grip will help you reduce kickback and maintain control of the saw. Two hands must be used to control the saw at all times.
- Do not overreach or cut above chest height.
- Make sure that the area in which you are cutting is free from obstructions. Do not let the bar nose contact a log, branch, or any other obstruction which could be hit while you are operating the saw.
- Cutting at high engine speeds may reduce the likelihood of kickback. But cutting at part-throttle or low engine speeds may be preferable to control the chain saw in tight situations and may also reduce the likelihood of kickback.
- Follow manufacturer’s sharpening and maintenance instructions for the saw chain.
- Use only replacement guide bars and chains specified by the manufacturer, or the acceptable equivalents of these guide bars and chains.



3. OTHER SAFETY PRECAUTIONS VIBRATION AND COLD

It is believed that a condition called Raynaud’s Phenomenon, which affects the fingers of certain individuals, may be brought about by exposure to cold and vibration.

Accordingly, your ECHO chain saw has shock mounts designed to reduce the intensity of vibration received through the handles.

Exposure to cold and vibration may cause tingling and burning followed by loss of color and numbness in the fingers. We strongly recommend you take the following precautions because the minimum exposure which might trigger the ailment is unknown.

- Keep your body warm, especially the head and neck, feet and ankles, and hands and wrists.
- Maintain good blood circulation by performing vigorous arm exercises during frequent work breaks and also by not smoking.
- Limit the number of hours of chain saw operation. Try to fill a part of each work day with jobs other than chain sawing.
- If you experience discomfort, redness and swelling of the fingers, followed by whitening and loss of feeling, consult your physician before further exposing yourself to cold and vibration.

REPETITIVE STRESS INJURIES

It is believed that over-using the muscles and tendons of the fingers, hands, arms and shoulders may cause soreness, swelling, numbness, weakness and extreme pain to the areas just mentioned.

To reduce the risk of repetitive stress injury, do the following:

- Avoid using your wrist in a bent, extended or twisted position. Instead, try to maintain a straight wrist position. Also, when grasping, use your whole hand, not just the thumb and index finger.
- Take periodic breaks to minimize repetition and rest your hands.
- Reduce the speed and force in which you do the repetitive movement.
- Do exercises to strengthen the hand and arm muscles.
- See a doctor if you feel tingling, numbness or pain in the fingers, hands, wrists or arms.

MACHINE CONDITIONS

- Do not operate a chain saw that is damaged, improperly adjusted, or not completely and securely assembled.
Do not operate the chain saw with a loose or defective silencer.
Be sure that the saw chain stops moving when the throttle control trigger is released.

WARNING  **DANGER**
DO NOT MODIFY A CHAIN SAW IN ANY WAY. ONLY ATTACHMENTS AND PARTS SUPPLIED BY KIORITZ CORP. OR EXPRESSLY APPROVED BY KIORITZ CORP. FOR USE WITH THE SPECIFIC KIORITZ CORP. CHAIN SAW MODELS ARE AUTHORIZED. ALTHOUGH CERTAIN UNAUTHORIZED ATTACHMENTS ARE USEABLE WITH THE KIORITZ CORP. POWERHEAD, THEIR USE MAY, IN FACT, BE EXTREMELY DANGEROUS.

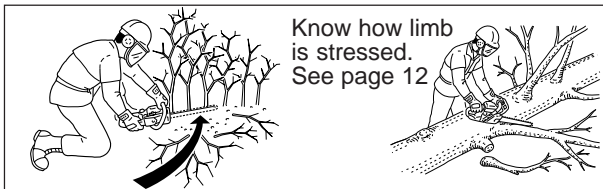

SERVICES

- All chain saw service operations, other than items listed in the operator's manual maintenance instructions, should be performed by competent service personnel.
(For example, if an improper tool is used to hold the flywheel in order to remove the clutch, structural damage to the flywheel could occur and subsequently could cause the flywheel to burst.)

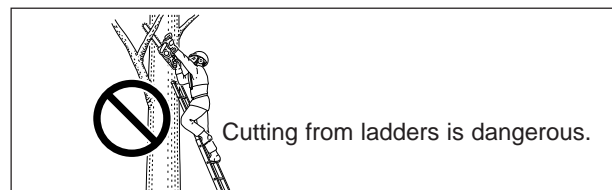

CUTTING

- Do not operate a chain saw in a tree unless you have been specifically trained to do so.
- Keep all parts of your body away from the saw chain when the engine is running.
- Use extreme caution when cutting small-size brush and saplings because slender material may catch the saw chain and be whipped toward you or pull you off balance.
- When cutting a limb that is under tension, be alert for spring-back so that you will not be struck by the limb or chain saw when the tension in the wood fibers is released.

- Cutting while on a ladder is extremely dangerous because the ladder can slip and your control of the chain saw is limited.
Working aloft should be left to professionals.
- Stop the engine before setting the chain saw down.

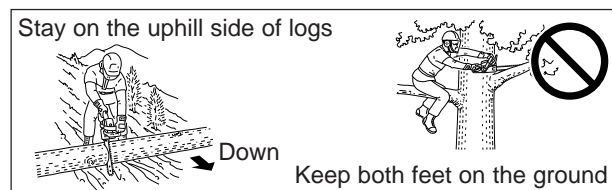
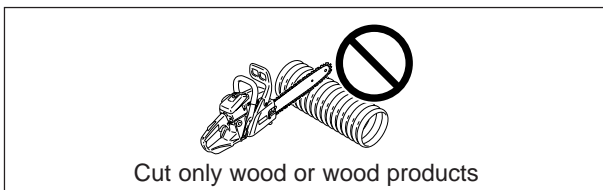

WOOD PRACTICES

- Operating a chain saw safely requires a chain saw in proper working order, sound judgement, and knowledge of the methods which should be applied in each cutting situation.
- Do not let any person use your saw unless he has read this operator's manual and fully understands its instructions.
- Never let children operate the saw.
- Use your saw only to cut wood or wood products. Do not cut solid metal, sheet metal, plastics or any non-wood materials.

- Stay on the uphill side when bucking or limbing logs which might roll when cut.
- Keep both feet on the ground. Do not work from off-the-ground positions.

PARTS IDENTIFICATION

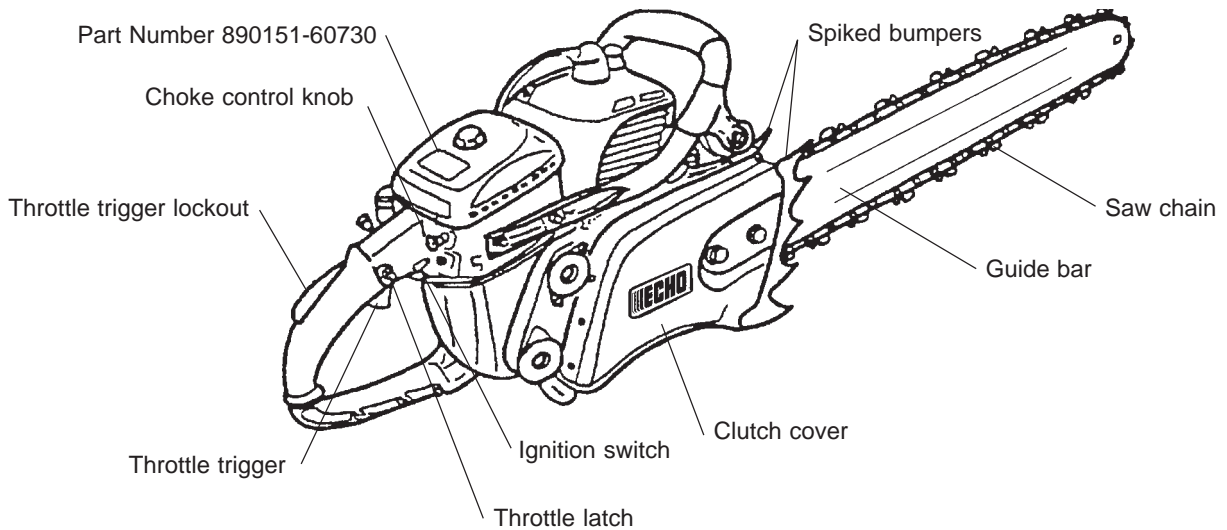
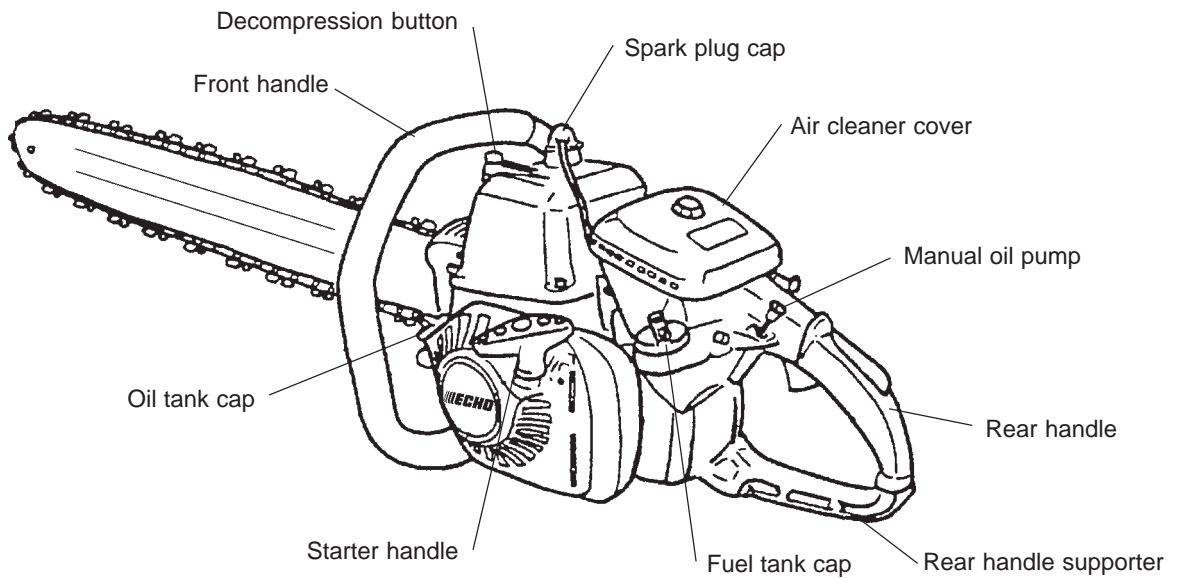

Part Number 890151-60730

CS-1201

CAUTION : For Safe Operation
Follow All Safety Precautions
In Operator's Manual.

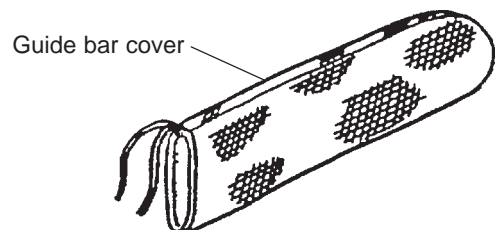

* If a decal cannot be read, a new one can be ordered from your ECHO dealer.

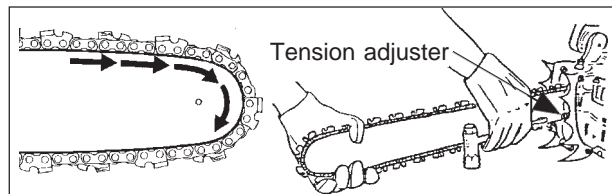
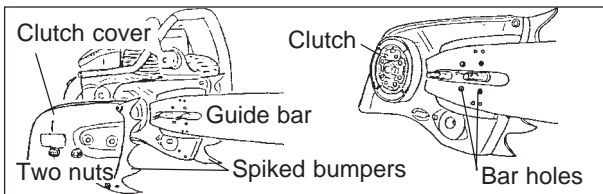

ASSEMBLY

MOUNTING GUIDE BAR AND CHAIN

The unit is delivered with guide bar and saw chain separated. Install guide bar and chain as follows.

WARNING **DANGER**
FOR YOUR OWN SAFETY, ALWAYS STOP THE ENGINE BEFORE PERFORMING ANY OF THE FOLLOWING OPERATIONS.

- Unscrew two nuts and remove clutch cover.
- Install the spiked bumpers on the front of machine.
- Mount the bar and slide toward clutch to make saw chain installation easier.
- Install saw chain as shown. (Ensure cutters are pointing in the right direction)
- Install the clutch cover, tighten nuts finger tight. Ensure that chain tension adjuster fits into bar hole.

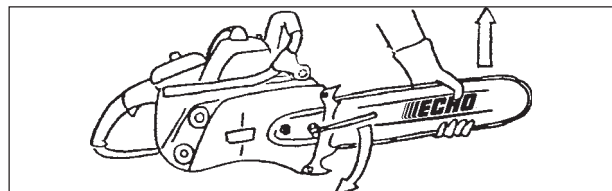
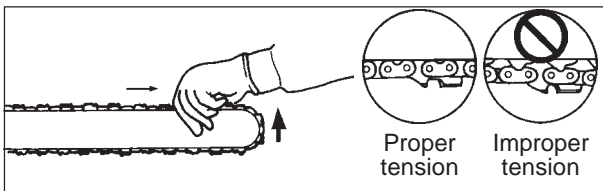

- Hold the bar nose up and turn the adjuster clockwise until the chain fits snugly against the underside of the bar.

- Tighten both nuts with the bar nose held up.
- Pull the chain around the bar by hand. Loosen the adjustment if you feel tight spots.
- Start the engine and run at low speed. Stop and readjust if necessary.

CAUTION
1. All adjustments should be made cold.
2. Always wear gloves when working on chain.
3. Do not operate with a loose chain.

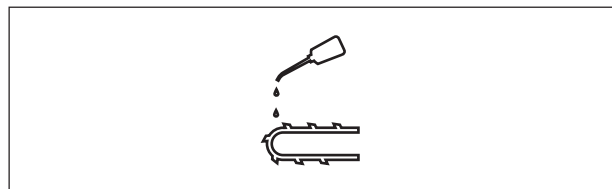

OPERATION

FUEL AND LUBRICANT

- Fuel is a mixture of regular grade petrol and an air-cooled 2-stroke engine oil of reputable brand name. Minimum 89 Octane unleaded petrol is recommended. Do not use fuel containing methyl alcohol or more than 10 % of ethyl alcohol.
- Recommended mixture ratio; 50 : 1 (2 %) for ISO-L-EGD Standard (ISO/CD 13738), JASO FC grade and ECHO Premium 50 : 1 oil and 25 : 1 (4 %) for JASO FA or FB grade oil.
 - Do not mix directly in engine fuel tank.
 - Avoid spilling petrol or oil. Spilled fuel should always be wiped up.
 - Handle petrol with care, it is highly inflammable.
 - Always store fuel in approved container.

CHAIN LUBRICANT

Proper lubrication of the chain while in operation reduces the friction between the chain and the guide bar to a minimum and assures a longer life time. Use only special chain oil of high quality for this purpose. Do not use any waste or reclaimed oil to avoid various problems with the oil pump. In case of emergency, it is allowed to use motor oil for a short time.
 SAE 30.... in summer
 SAE 10.... in winter or for the cutting of wood with a high resin content.

CAUTION
Whenever opening up the fuel tank, always loosen the cap very slowly and wait for the tank pressure to be equalized before removing the cap.

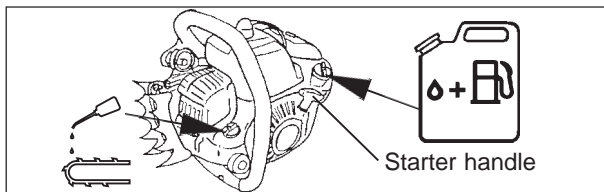

STARTING THE ENGINE

- Fill the fuel tank with fuel mixture. It is not permitted to fill fuel above the shoulder level of fuel tank.
- Fill the chain oil tank with lubricant.
- Place chain saw down on a clear level place where the saw chain will not be in contact with anything.
- Lubricate the chain whenever the chain is mounted on the saw or remounted.
- Push manual oiler button until oil coming onto the saw chain.

NOTE

Do not pull starter rope out to the maximum position. Do not allow starter handle to snap back against the casing.

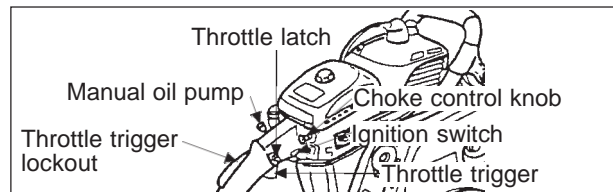

- Lift ignition switch up.
- Pull choke control knob all the way out. (Use only when engine is cold.)
- Keep your body to the left of the saw. Hold the saw down with the left hand on top of the front handle, and with your right foot on the rear handle supporter.
- Make sure guide bar and saw chain are not touching anything when starting the saw.
- In order to start engine easily, push decompression button while pulling starter handle to reduce pressure in cylinder. Rotate the decompression button 90 degrees clockwise to latch. When engine starts, turn back the decompression button to release.
- Pull starter handle several times until first firing sound is heard.
- Push choke control knob all the way in.
- Pull starter handle again.
- When engine is hard to start, press throttle trigger lockout down while squeezing the trigger and push the latch in. When engine starts, immediately squeeze the trigger up to release the latch.
- After engine has started, idle for a few minutes to warm it up.
- Ensure proper acceleration and lubrication of saw chain and guide bar.

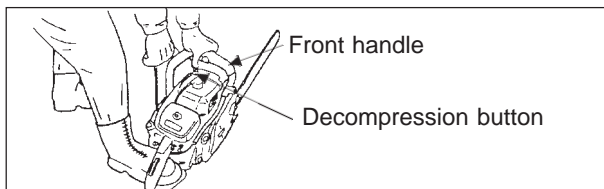

CAUTION

Clutch engages and chain will rotate when engine is started with throttle trigger squeezed. After engine starts release throttle trigger to idle position.

CAUTION

When throttle latch is used, saw chain will go into motion as soon as the engine starts. Never use throttle latch for cutting. Use it only when starting the engine.

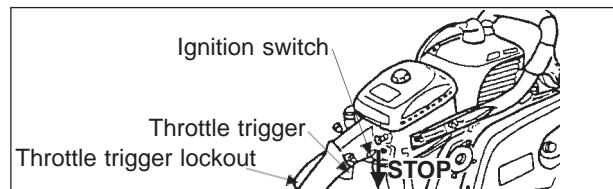

STOPPING THE ENGINE

- Release throttle trigger and push ignition switch down.

NOTE

If engine does not stop, pull choke control knob all the way out to stop engine. Check and repair ignition switch before starting the engine again.

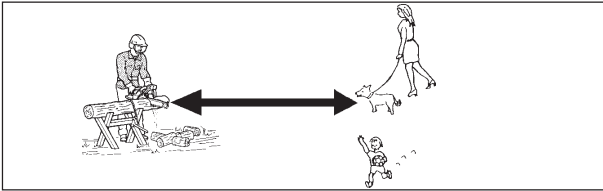

PRE CUTTING TEST

- Familiarize yourself with your chain saw before you start actual cutting.
- For this purpose it may be wise to practice by cutting some small logs or limbs several times.
- Do not allow either people or animals into the work area. Multiple operators - Keep a safe distance between two or more operators when working together simultaneously.

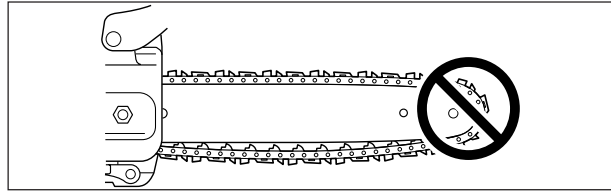

CHECKING CHAIN TENSION

- Chain tension should be checked frequently during work and corrected if necessary.
- Tension the chain as tight as possible, but so it can still be pulled easily along the bar by hand.

WARNING  **DANGER**
MAKE SURE THAT THE ENGINE IS SHUT OFF WHEN CHECKING CHAIN TENSION.

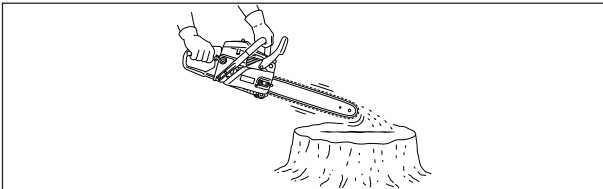

CHAIN LUBRICATION TEST

Hold the chain just above a dry surface and open the throttle to half speed for 30 seconds. A thin line of "thrown" oil should be seen on the dry surface.

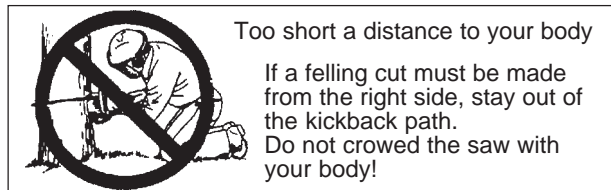
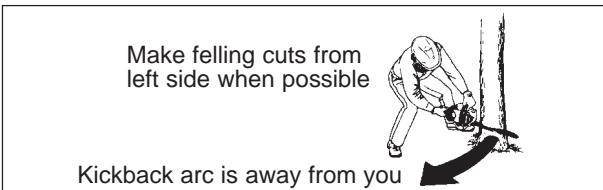

CUTTING INSTRUCTION

GENERAL

In all circumstances the operation of the chain saw is a one-man job. It is difficult at times to take care of your own safety, so don't assume the responsibility for a helper as well. After you have learned the basic techniques of using the saw, your best aid will be your own good common sense. The accepted way to hold the saw is to stand to the left of the saw with your left hand on the front handle so you can operate the throttle trigger with your right index finger. Before attempting to fell a tree, cut some small logs or limbs. Be thoroughly familiar with the controls and the responses of the saw.

Start the engine, see that it is running properly. Squeeze the trigger to open the throttle wide open, then start the cut. It is not necessary to press down hard to make the saw cut. If the chain is properly sharpened, the cutting should be relatively effortless. Pushing the saw too hard will slow the engine and cutting will actually be more difficult.

Some material may adversely affect the housing of your chain saw. (Example: palm tree acid, fertilizer etc.) To avoid housing deterioration carefully remove all packed saw dust around clutch and guide bar area and wash with water.

WARNING  **DANGER**
DO NOT LET THE NOSE OR TIP OF THE GUIDE BAR TOUCH ANYTHING WHILE ENGINE IS RUNNING TO AVOID KICKBACK.

FELLING A TREE

A falling tree can seriously damage anything it may hit - a car, a house, a fence, a power-line or another tree. There are ways to make a tree fall where you want it, so first decide where that is!

Before cutting, clear the area around the tree. You will need good footing while working and you should be able to work the saw without hitting any obstacles.

Next select a path of retreat.

When the tree begins to fall you should retreat away from the direction of fall at a 45-degree angle and at least 3 m from the trunk to avoid the trunk kicking back over the stump. (See figure right, top)

Begin the cut on the side to which the tree is to fall.

Cut a notch approximately 1/3 of the way into the tree. (See figure A)

The position of this notch is important since the tree will try to fall "into" the notch. (See figure A)

The felling cut is made on the side opposite the notch.

Make the felling cut by placing spiked bumper 2.5 cm to 5 cm above the bottom of the notch and stop cutting at approximately 1/10 of diameter to the inner edge of the notch (See figure B) in order to leave the uncut portion of the wood as a hinge.

Do not try to cut through to the notch with the felling cut. The remaining wood between the notch cut and felling cut will act as a hinge when the tree falls, guiding it in the desired direction.

When the tree starts to fall, stop the engine, place the saw on the ground and make your retreat quickly.

To fell big trees with a diameter exceeding twice the bar length, start the notching cuts from one side and draw the saw through to the other side of the notch.

Start the back cut on one side of the tree with the spiked bumper engaged, pivoting the saw through to form the desired hinge on that side.

Then remove the saw for the second cut.

Insert the saw in the first cut very carefully so as not to cause kickback.

The final cut is made by drawing the saw forward in the cut to reach the hinge. (See figure C)

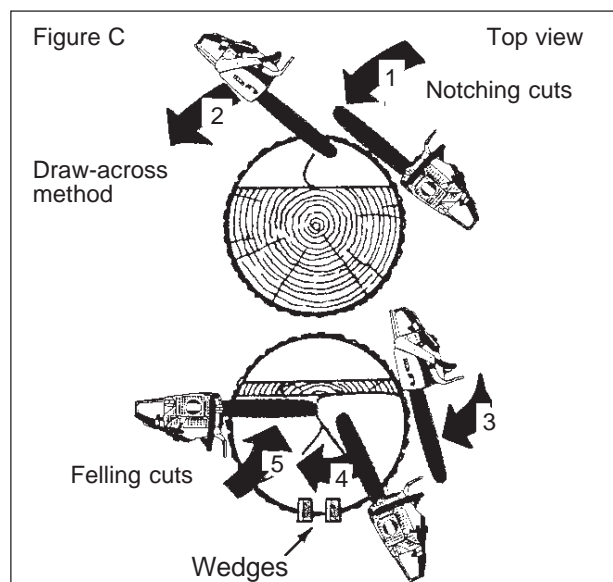
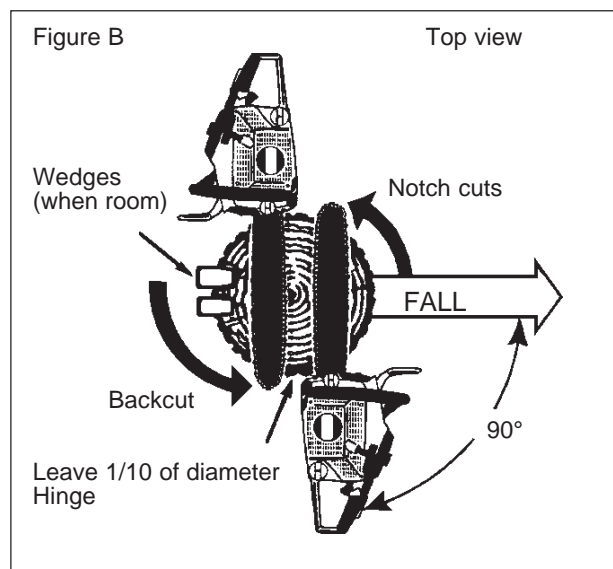
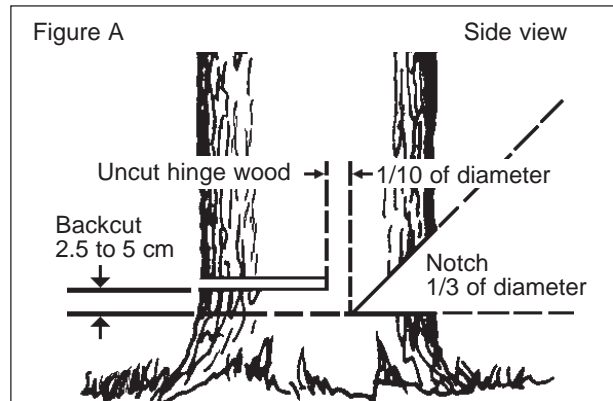
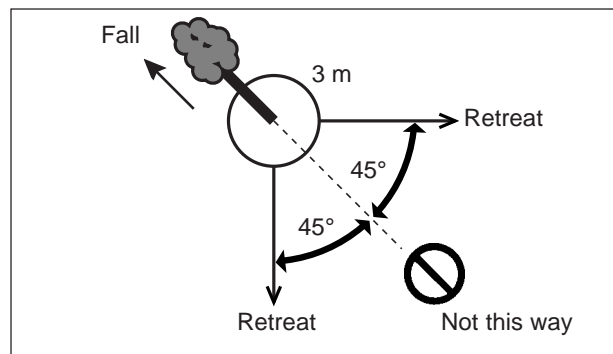

LIMBING

Limbing a fallen tree is much the same as bucking.

Never remove a limb from a tree while it is supporting your weight.

Be careful of the tip touching other limbs.

Always use both hands.

Don't cut with the saw overhead or the bar in a vertical position. If the saw should kickback, you may not have good enough control to prevent possible injury.

CAUTION

Don't saw above chest height.

Do not cut above chest height



Know how limb is stressed

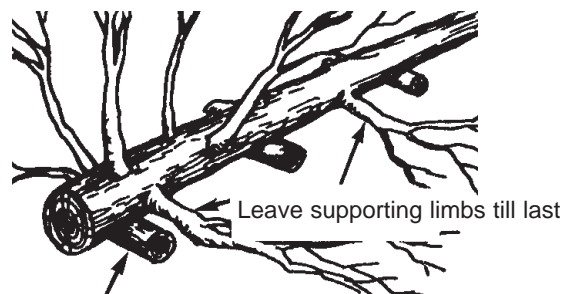
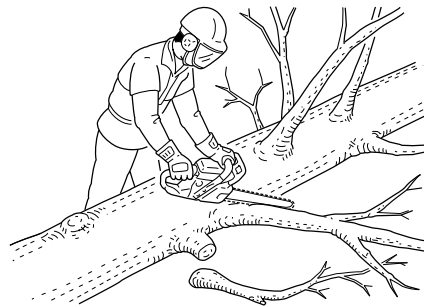

Slide support logs under trunk

BUCKING

Bucking is the sawing of a log or fallen tree into smaller pieces.

There are a few basic rules which apply to all bucking operations.

Keep both hands on the handles at all times.

Support logs if possible.

When cutting on a slope or hillside, always stand uphill.

CAUTION

Stay on the uphill side of logs.

No standing on log

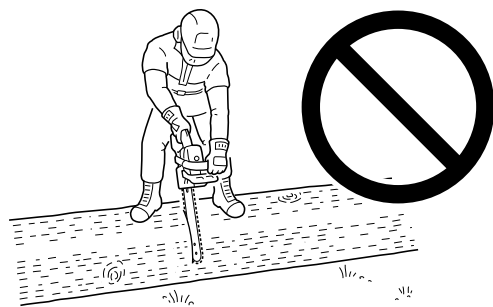

Stay on the uphill side of logs

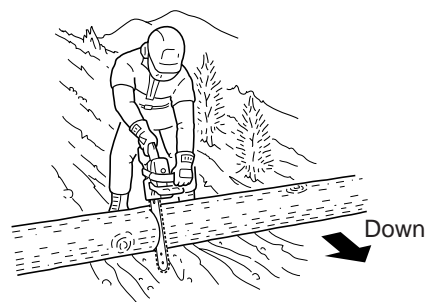

TENSION AND COMPRESSION IN TIMBER

A length of timber lying on the ground will be subject to tension and compression, depending at which points the major support is.

When timber is supported at its ends the compression side is at the top and the tension side is at the bottom. To cut between these support points, make the first cut downwards approximately 1/3rd the timber diameter. The second cut is made upwards and should meet the first cut.

When the timber is supported at one end only, make the first cut upwards approximately 1/3rd the timber diameter. The second cut is made downwards and should meet the first cut.

CAUTION

If you have misjudged the effects of tension and compression, and cut from the wrong side, the timber will pinch the guide bar and chain, trapping it. Ricing the engine with the chain jammed will burn out your clutch.

If the chain should become jammed and the saw can not be removed from the cut do not force it out. Stop the saw, force a wedge into the cut to open it up.

Never force the saw when it is jammed.

Do not force the saw into the cut.

A dull chain is unsafe and will cause excessive wear to the cutting attachments.

A good way to tell when the chain is dull is when fine saw dust comes out instead of chips.

CAUTION

Do not touch hot surfaces of cylinder cover and silencer after you used the chain saw.

WARNING  **DANGER**
NEVER USE THROTTLE LATCH FOR CUTTING JOBS.

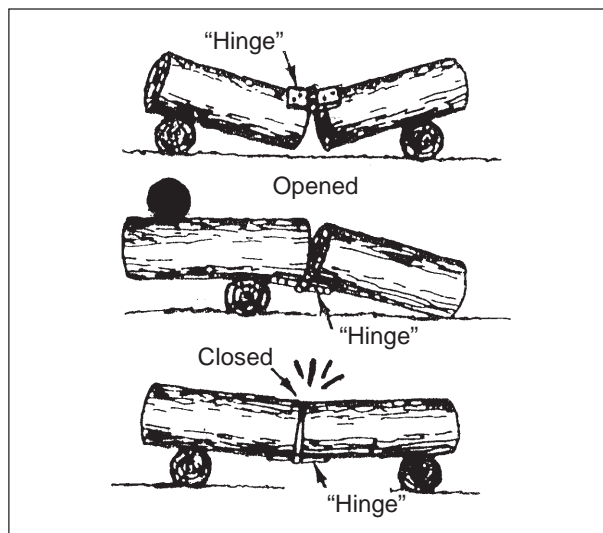

Heavy stress

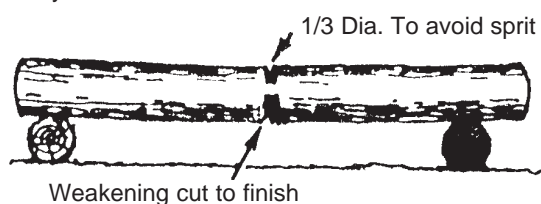

Overbuck

DOWNs

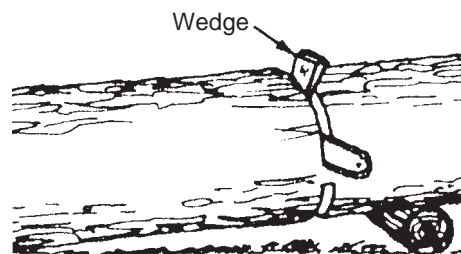
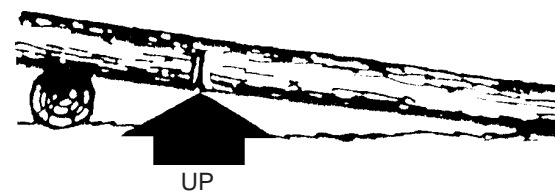
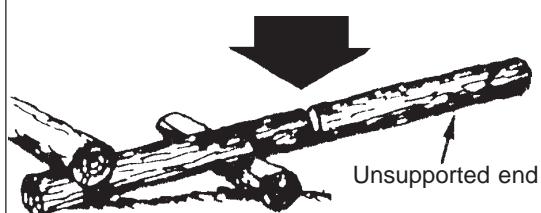

Make angled cut when one section may settle against the other

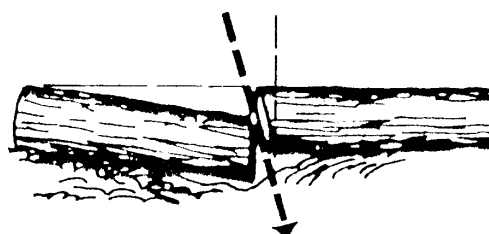

SERVICE MAINTENANCE GUIDE

AREA	MAINTENANCE	PAGE	BEFORE USE	MONTHLY
Air Filter	Clean/Replace	15	•	
Fuel Filter	Inspect/Clean/Replace	15	•	
Spark Plug	Inspect/Clean/Adjust/Replace	16		•
Carburettor	Adjust/Replace and adjust	15		•
Cooling System	Inspect/Clean	16	•	
Silencer	Inspect/Tighten/Clean	16	•	
Oil Filter	Inspect/Clean/Replace	15	•	
Sprocket	Inspect/Replace	16		•
Starter Rope	Inspect/Replace	-		•
Guide Bar	Inspect/Clean	16	•	
Fuel System	Inspect	15	•	
Screws, Bolts and Nuts	Inspect, Tighten/Replace	-	•	

IMPORTANT

Time intervals shown are maximum. Actual use and your experience will determine the frequency of required maintenance.

TROUBLE SHOOTING

Trouble		Cause	Remedy
Engine	- hard to start - does not start		
Engine cranks	Fuel at carburettor → No fuel at carburettor	<ul style="list-style-type: none"> • Fuel filter clogged • Fuel line clogged • Carburettor 	<ul style="list-style-type: none"> • Clean or replace • Clean • Ask your ECHO dealer
	Fuel at cylinder → No fuel at cylinder	<ul style="list-style-type: none"> • Carburettor 	<ul style="list-style-type: none"> • Ask your ECHO dealer
	→ Silencer wet with fuel	<ul style="list-style-type: none"> • Fuel mixture is too rich 	<ul style="list-style-type: none"> • Open choke • Clean/replace air filter • Adjust carburettor • Ask your ECHO dealer
	Spark at end of plug wire → No spark at end of plug wire	<ul style="list-style-type: none"> • Ignition switch off • Electrical problem 	<ul style="list-style-type: none"> • Turn switch on • Ask your ECHO dealer
	Spark at plug → No spark at plug	<ul style="list-style-type: none"> • Spark gap incorrect • Covered with carbon • Fouled with fuel • Spark plug defective 	<ul style="list-style-type: none"> • Adjust 0.6 to 0.7 mm • Clean or replace • Clean or replace • Replace plug
Engine does not crank		<ul style="list-style-type: none"> • Internal engine problem 	<ul style="list-style-type: none"> • Ask your ECHO dealer
Engine runs	Dies or accelerates poorly	<ul style="list-style-type: none"> • Air filter dirty • Fuel filter dirty • Fuel vent plugged • Spark plug • Carburettor • Cooling system plugged • Exhaust port/silencer plugged 	<ul style="list-style-type: none"> • Clean or replace • Clean or replace • Clean • Clean and adjust/replace • Adjust • Clean • Clean

WARNING DANGER

- ALL CHAIN SAW SERVICE OPERATIONS, OTHER THAN ITEMS LISTED IN THE OPERATOR'S MANUAL, SHOULD BE PERFORMED BY COMPETENT SERVICE PERSONNEL.
- FUEL VAPORS ARE EXTREMELY FLAMMABLE AND MAY CAUSE FIRE AND/OR EXPLOSION. NEVER TEST FOR IGNITION SPARK BY GROUNDING SPARK PLUG NEAR CYLINDER PLUG HOLE, OTHERWISE SERIOUS PERSONAL INJURY MAY RESULT.

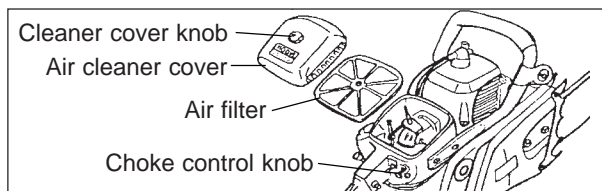
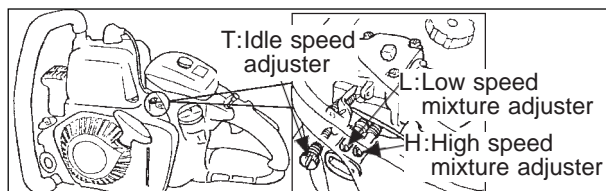

SERVICE

- If you have any questions or problems, please contact your ECHO dealer.

CARBURETTOR

- Do not adjust the carburettor unless necessary.
- To adjust the carburettor proceed as follows:
 - Low speed mixture adjuster (L): $1\frac{1}{4}$ to $1\frac{3}{4}$ turns open
 - High speed mixture adjuster (H): $1\frac{1}{2}$ turns open
 - Screw in the needles until lightly seated and return indicated turn above.
- Turn idle speed adjuster (T) clockwise until chain begins to rotate. Then back screw $\frac{1}{2}$ turn.

CAUTION

When starting, idle speed adjuster (T) should be adjusted not to rotate the saw chain.
When there is some trouble with the carburettor, contact your dealer.

AIR FILTER

- Check before every use.
- Always keep air filter clean to maintain air/fuel mixture in a correct ratio constantly.
- Before removing air cleaner cover, pull choke control out to prevent dust from entering into carburetor.
- Turn cleaner cover knob anticlockwise with hand and remove air cleaner cover and air filter.
Brush off dust lightly, or wash it in a non-inflammable solvent if necessary, or replace the air filter.
- Dry it completely before installation.
- Reinstall air filter and cover.

CHECK FUEL SYSTEM

- Check before every use.
- After refuelling, make sure fuel does not leak or exude from around fuel pipe, fuel grommet or fuel tank cap.
- In case of fuel leakage or exudation there is a danger of fire. Stop using the machine immediately and request your dealer to inspect or replace.

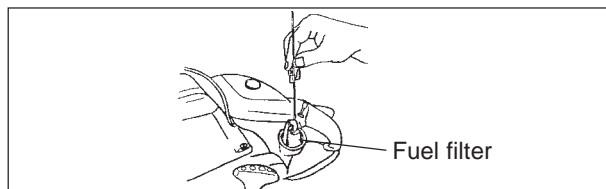

FUEL FILTER

- Check periodically.
 - Do not allow dust to enter fuel tank.
 - A clogged filter will cause difficulty in starting engine or abnormalities in engine performance.
 - Pick up the fuel filter through fuel inlet port with a piece of steel wire or the like.
 - When the filter is dirty, replace it.
 - When the inside of the fuel tank is dirty, it can be cleaned by rinsing the tank out with petrol.

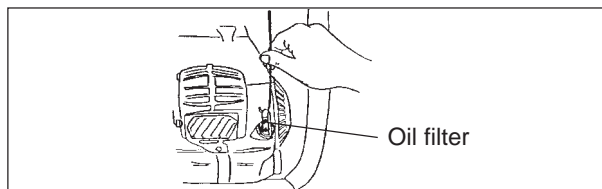

OIL FILTER

- Check periodically.
 - Do not allow dust to enter oil tank.
 - A clogged oil filter will affect the normal lubricating system.
 - Pick it up through oil filling hole with a piece of steel wire or the like.
 - If the filter is dirty, wash it in petrol or replace it.
 - When the inside of the oil tank gets dirty, it can be cleaned by rinsing the tank out with petrol.

WARNING  **DANGER**
PETROL AND FUEL ARE EXTREMELY FLAMMABLE.
EXTREME CAUTION IS REQUIRED WHEN HANDLING PETROL OR FUEL.

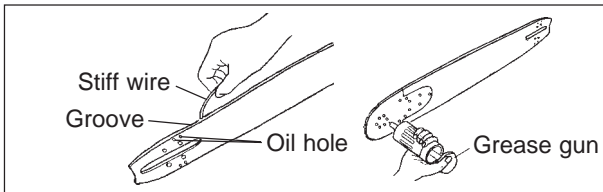

GUIDE BAR

- Clean before using.
 - Clean the groove of the guide bar with a small screw driver, for example.
 - Clean oil holes with a wire.
- When you use sprocket nose guide bar, check nose sprocket to see if it rotates freely or needs grease. Worn guide bar should be replaced. Injection of grease into the sprocket using grease gun.
- Reverse guide bar periodically.
- Check sprocket and the clutch and clean the bar mount area before installation of the guide bar. Replace either or both if worn.

NOTE

When replacing guide bar or saw chain, ask your ECHO dealer.

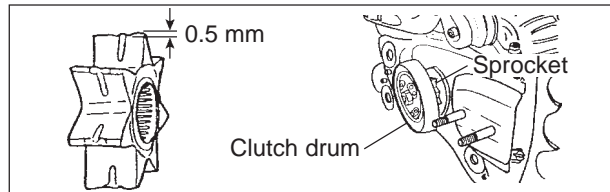

SPROCKET

- The damaged sprocket will cause premature damage or wear of saw chain.
 - When the sprocket has worn out 0.5 mm or more, replace it.
- Check sprocket when you install new chain. Replace it if worn.

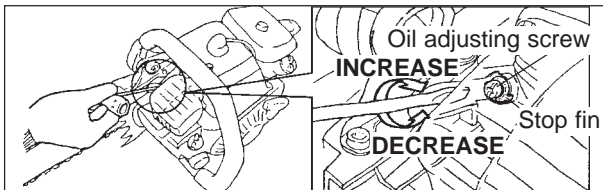

AUTOMATIC OILER

- The discharge volume of the automatic oiler is adjusted to 10 mL/min approximately at 7,000 r/min, prior to shipment from factory.
 - To increase the delivery volume, turn the adjusting screw clockwise. When the adjusting screw touches stopper and stops, this position indicates maximum discharge volume. (23 mL/min at 7,000 r/min)
 - Do not turn the adjusting screw beyond the maximum or minimum limit of volume adjustment.

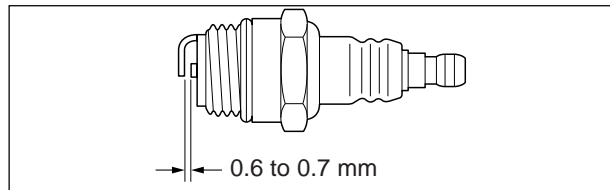

SPARK PLUG

- Check periodically.
 - The standard spark gap is 0.6 to 0.7 mm.
 - Correct the spark gap if it is wider or narrower than the standard gap.
- Fastening torque: 15 to 17 N·m (150 to 170 kgf·cm)

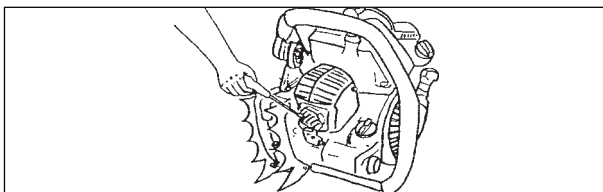

SILENCER

- Clean deposits from silencer.

NOTE

Recommend removal of silencer be done by the Dealer. Because they need thread locking sealant with special torques when assembling.

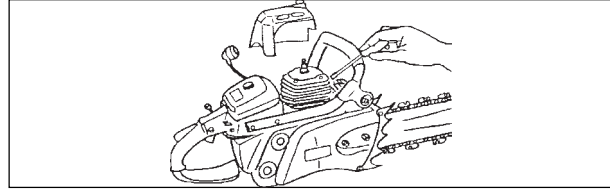

CYLINDER FINS

- Check periodically.
- Clogged fins will result in poor engine cooling.
- Remove dirt and dust from between fins to let cooling air pass easily.

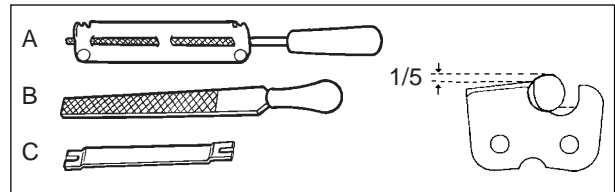
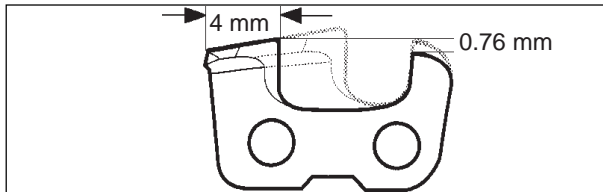

SAW CHAIN MAINTENANCE

Never operate a chain saw with a dull or damaged chain. If the chain requires excessive pressure to cut or produces dust instead of wood chips then inspect the cutters for damage. When sharpening the chain the objective will be to maintain the same angles and profiles throughout its life as when it was new. Inspect the chain for damage or wear every time you refuel your chain saw. When the length of the cutting teeth has worn down to only 4 mm the chain must be replaced.

• Sharpening

In order to file the chain correctly you need: round file and file holder (A), flat file (B) and a depth gauge tool (C).

By using the correct file size (5.6 mm Round file) and a file holder, it is easier to receive a good result.

Consult your ECHO dealer for correct sharpening tools and sizes.

WARNING **DANGER**
SWITCH OFF THE ENGINE BEFORE SHARPENING THE CHAIN.
ALWAYS WEAR GLOVES WHEN WORKING ON CHAIN.

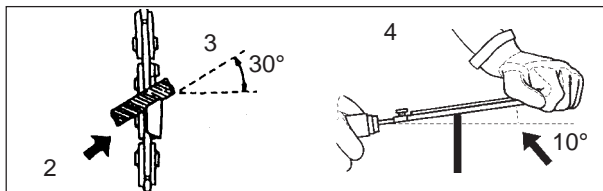

1. Lock the chain - push hand guard forward. To rotate the chain - pull hand guard against front handle.
2. Your chain will have alternative left and right hand cutters. Always sharpen from the inside out.
3. Keep the angle lines of the file holder parallel to the line of the chain and file the cutter back until the damaged area (side plate and top plate) has been removed.
4. Hold the file tipped 10° upward.
5. Sharpen the most damaged cutter first and then take all the other cutters back to the same length.

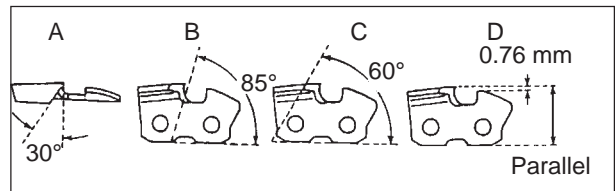

• Properly filed cutters are shown below.

- A : Top plate angle 30°
- B : Side plate angle 85°
- C : Top plate cutting angle 60°
- D : Depth gauge 0.76 mm

NOTE

These angles are referred to as Oregon 27 saw chain. For other branded saw chain, follow its chain manufacturer's instruction.

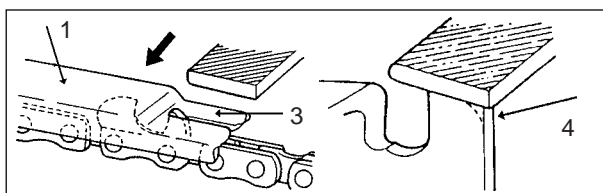

1. The depth control determines the thickness of wood chip produced and must be maintained correctly throughout the chain life.
2. As the cutter length is reduced, the depth control height is altered and must be reduced.
3. Position the depth gauge, and file off any of the depth control which protrudes.
4. Round off the front of the depth control to allow smooth cutting.

(PRECAUTION)

The following faults will increase the risk of kickback considerably.

- 1) Top plate angle too large
- 2) Side plate angle too small
- 3) File diameter too small
- 4) Depth gauge too large

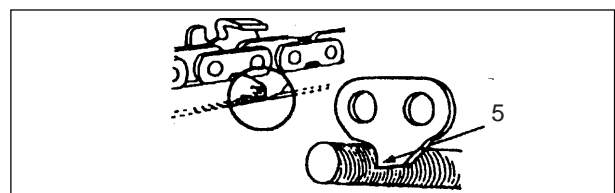

- Drive link serves to remove sawdust from the groove of the guide bar. Therefore, keep the lower edge of the drive link sharp, indicated as 5.

- When setting of the chain is finished, soak it in oil and wash away filings completely before using.
- When the chain has been filed on the bar, supply sufficient oil to it, and rotate the chain slowly to wash away the filings before using again.
- If the chain saw is operated with filings clogged in the groove, the saw chain and the guide bar will be damaged prematurely.
- If the saw chain becomes soiled with resin for instance, clean it with kerosene and soak it in oil.

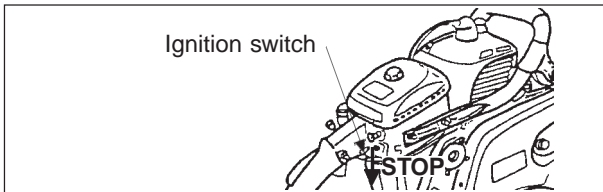

STORAGE

LONG TERM STORAGE (Over 30 days)

WARNING  **DANGER**
DO NOT STORE IN AN ENCLOSURE WHERE FUEL FUMES MAY ACCUMULATE OR REACH AN OPEN FLAME OR SPARK.

Do not store your unit for a prolonged period of time (30 days or longer) without performing protective storage maintenance which includes the following:

1. Store unit in a dry, dust free place, out of the reach of children and other unauthorized persons.
2. Place the ignition switch in the "STOP" position.
3. Remove accumulation of grease, oil, dirt and debris from exterior of unit.
4. Perform all periodic lubrication and services that are required.
5. Tighten all the screws, bolts and nuts.
6. Drain the fuel tank completely and pull the recoil starter handle several times to remove fuel from the carburettor.
7. Always store fuel in approved container.

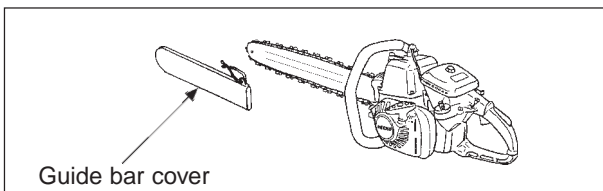

8. Remove the spark plug and pour 1/2 tablespoon of fresh, clean, two-stroke engine oil into the cylinder through the spark plug hole.
 - A. Place a clean cloth over the spark plug hole.
 - B. Pull the recoil starter handle 2 or 3 times to distribute the oil inside the engine.
 - C. Observe the piston location through the spark plug hole.
 Pull the recoil starter handle slowly until the piston reaches the top of its travel and leave it there.
9. Install the spark plug (do not connect ignition cable).
10. Cover the chain and the guide bar with the guide bar cover before putting them in storage.

NOTE

- For future reference, you should keep this operator's manual.
- If this operator's manual has become illegible through impairment or is lost, please purchase a new one from your ECHO dealer.
- When renting or lending this machine to a person who will operate it, always include this operator's manual, which provides explanation and instructions.
- When transferring a product, please deliver it attaching the operator's manual.

SPECIFICATIONS

		CS-1201
External dimentions : L × W × H	mm	490 × 300 × 320
Mass : Saw without guide bar and chain, empty tanks	kg	10.6
Volume : Fuel tank Tank for chain lubrication oil Fuel (Mixture ratio) Oil (Chain oil)	L L	1.25 0.65 Regular grade petrol. Minimum 89 Octane unleaded petrol is recommended. Do not use fuel containing methyl alcohol or more than 10 % of ethyl alcohol. 50 : 1 (2 %) for ISO-L-EGD Standard (ISO/CD 13738), JASO FC grade and ECHO Premium 50 : 1 oil and 25 : 1 (4 %) for JASO FA or FB grade oil. Special chain oil or motor oil
Cutting length : All specified usable cutting lengths of guide bar	cm	*83
Chain : Specified pitch Specified gauge (thickness of drive links) Type of guide bar Guide bar gauge Type of chain Lubrication	mm mm cm mm	10.26 (0.404 inch) 1.6 (0.063 inch) *83 (ECHO 33G63) 1.6 (0.063 inch) *Oregon 27-100E Adjustable automatic oil pump and manual
Sprocket : Specified number of teeth		7
Engine : Type Carburettor Magneto Spark plug Starter Power transmission Decompression device Engine displacement	mL (cm ³)	Air cooled 2-cycle single cylinder Diaphragm type Flywheel magneto, TCI system CHAMPION CJ-6Y Recoil starter Automatic centrifugal clutch With 116.3
Other devices :		Throttle trigger lockout, Chain catcher, Anti-vibration device, Spiked bumper

*Standard configuration, other lengths are available.

Specifications, descriptions and illustrative material in this literature are as accurate as known at the time of publication, but are subject to change without notice.

Illustrations may include optional equipment and accessories, and may not include all standard equipment.



KIORITZ CORPORATION

7-2 SUEHIROCHO 1-CHOME, OHME, TOKYO 198-8711, JAPAN
PHONE: 81-428-32-6118. FAX: 81-428-32-6145.



Free Manuals Download Website

<http://myh66.com>

<http://usermanuals.us>

<http://www.somanuals.com>

<http://www.4manuals.cc>

<http://www.manual-lib.com>

<http://www.404manual.com>

<http://www.luxmanual.com>

<http://aubethermostatmanual.com>

Golf course search by state

<http://golfingnear.com>

Email search by domain

<http://emailbydomain.com>

Auto manuals search

<http://auto.somanuals.com>

TV manuals search

<http://tv.somanuals.com>