



Edelbrock 4.6L Mustang GT Supercharger

Part #1580 & #1585



Edelbrock 4.6L Ford Supercharger System for 2005 and later Mustang GTs

Installation Instructions

INTRODUCTION

Thank you for purchasing the Edelbrock 4.6L Ford Supercharger System for the Mustang GT. The Edelbrock E-Force Supercharger System for the 2005-2009 4.6L 3V Mustang utilizes Eaton's new Gen VI TVS Supercharger rotors, featuring a four lobe design with a full 160 deg. of twist for maximum flow, minimum temperature rise, quiet operation, and the reliability for which Eaton is known. These rotors however, are merely the foundation of the system. The Edelbrock Supercharger is a complete system that maximizes efficiency and performance by minimizing air restriction into, and out of, the supercharger. This results in maximum airflow, with minimum temperature rise and minimum power consumption. In addition, Edelbrock inverted the supercharger and packaged it down low in the valley, allowing for an incredible, industry leading, 15 inches of runner length, maximizing low end torque. The supercharger housing itself is integrated into the intake manifold for a seamless design with minimal components, eliminating the possibility of vacuum leaks between gasket surfaces. The system also utilizes a front drive, front inlet configuration giving it the shortest, least restrictive inlet path on the market. Further minimizing inlet restriction is the massive 85mm electronic throttle body that is included in the kit. Sitting right above the supercharger and below the enormous runners is the largest air to water intercooler available, measuring an astonishing 110 square inches. Last but not least, the E-Force supercharger is without a doubt the best looking engine compartment upgrade imaginable. It features a uniquely styled plenum, and includes matching side covers. In summation, the Edelbrock supercharger will provide you with the most power at the lowest amount of boost resulting in neck snapping performance that is safe to operate on a completely stock engine. It is also pending 50 state emissions legality, and can be had with an optional 3 yr 36,000 mile warranty so that there are no worries when installing it on your brand new car.

Edelbrock Corporation, 2700 California Street, Torrance, CA 90503

Toll-Free Tech Line: 1-800-416-8628

Office: 310-781-2222

Tech E-Mail: Edelbrock@Edelbrock.com

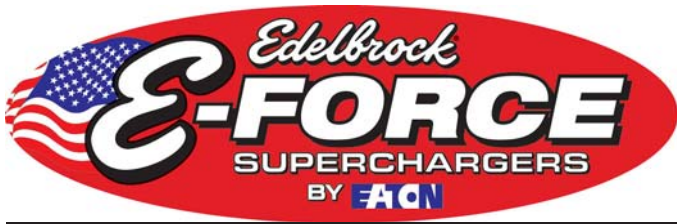

Edelbrock 4.6L Ford Supercharger System for 2005 and later Mustang GTs

Installation Instructions

IMPORTANT WARNINGS

Proper installation is the responsibility of the installer. Improper installation will void warranty and may result in poor performance and engine or vehicle damage.

Due to the complexity of the Edelbrock E-Force Supercharging system, it is recommended that this system only be installed by a qualified professional with access to a service lift, pneumatic tools, and a strong familiarity with automotive service procedures. To qualify for the optional 3-year, 36,000 mile warranty, it is necessary to have this system installed by a certified ASE technician, Ford dealership, or Edelbrock approved installer. Failure to have this system installed by a properly certified service center may result in voiding of both the optional warranty offered with this system, as well as the standard Edelbrock parts warranty. Please contact the Edelbrock Technical Support department if you have any questions regarding how this system and/or your installer of choice will affect any warranty coverage for which your vehicle may qualify.

Any previously installed aftermarket tuning equipment must be removed and the vehicle returned to an as stock condition before installing the supercharger.

Any equipment that directly modifies the fuel mixture or ignition timing of the engine can cause severe engine damage if used in conjunction with the Edelbrock E-Force Supercharger System. This includes, but is not limited to: ignition boxes, air/fuel controllers, OBDII programmers, and any other device that modifies signals to and/or from the ECU. Aftermarket bolt-on equipment such as underdrive pulleys or air intake kits will also conflict with the operation of the supercharger and must be removed prior to installation. Use of any of these products with the E-Force Supercharger could result in severe engine damage.

91 octane or higher gasoline is required at all times. If your vehicle has been filled with anything less, it must be run until dry and refilled with 91 or higher octane gasoline twice prior to installation.

This kit includes all the parts needed to install this system on '07 & '08 Mustang GTs only. '05 & '06 models will also need the 15804 Cooling Upgrade Kit, while '09 models will need the 15805 Hardware Kit.

Mustang GTs produced in 2005 and 2006 were equipped with a cooling system that mounted the thermostat on the cold side of the radiator. The Edelbrock E-Force Supercharger was designed to take advantage of the improvements in cooling efficiency that are offered by mounting the thermostat on the hot side as found in later models. Cooling Upgrade Kit #15804 will allow owners of '05 & '06 model year Mustangs to retro-fit their cars with the later model cooling systems, and is required before the supercharger can be installed. 2009 model year Mustangs received some minor changes from previous model years and will require a different pulley nut and intake manifold gaskets, offered in kit #15805, to operate correctly. It is strongly recommended that these parts be purchased, if needed, before beginning installation of the supercharger.



Edelbrock 4.6L Ford Supercharger System for 2005 and later Mustang GTs

Installation Instructions

INSTALLING A BOOST GAUGE OR PRESSURE TRANSDUCER

Your E-Force supercharger is equipped with two options for measuring boost. The TMAP sensor mounted on top of the manifold at the rear of the driver's side, outputs a 0-5 volt signal through pins 1 & 2 (pin 1 is signal & pin 2 is signal return,) that can be converted to an absolute pressure reading using the below calibration curve. Use of this signal requires an ambient pressure correction for calculating boost pressure.

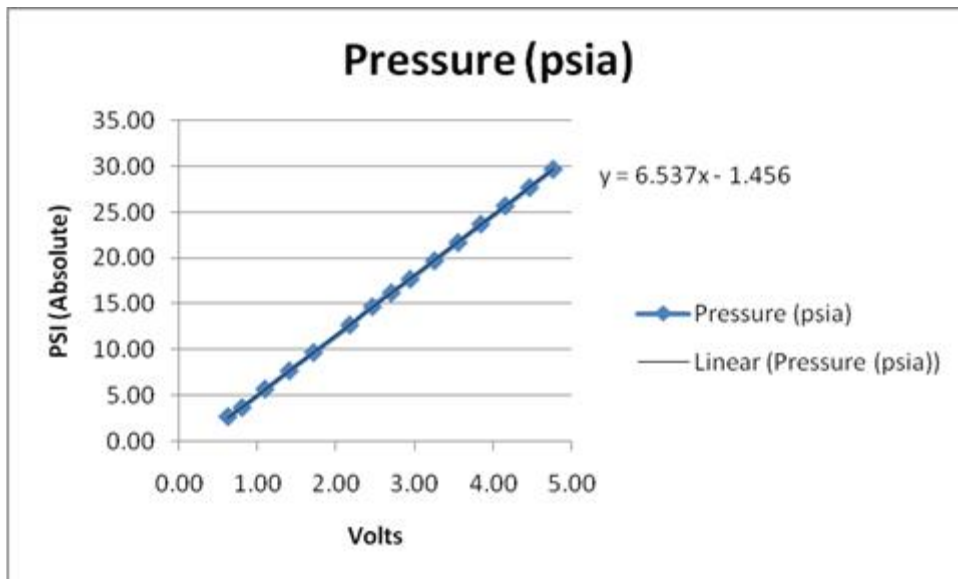

Voltage	Pressure (psia)
0.62	2.70
0.80	3.69
1.09	5.70
1.40	7.69
1.71	9.70
2.17	12.70
2.46	14.70
2.70	16.21
2.94	17.70
3.25	19.71
3.55	21.70
3.84	23.71
4.15	25.70
4.46	27.70
4.76	29.70

The second option is to utilize the pressure port at the rear of the passenger side intake runner flange. Your supercharger has been pre-drilled and tapped for a 1/8" NPT fitting. There is currently a plug sealing the hole, which can be removed, and replaced with a fitting to adapt to your sensor.

CAUTION: Never cut into the vacuum lines leading to the fuel rail pressure sensor and bypass actuator, on the driver's side of the manifold, for the purpose of tapping in a boost gauge. Interruption of the vacuum signal to the fuel rail pressure sensor can affect the fuel pressure reading to the PCM, which can result in engine failure!

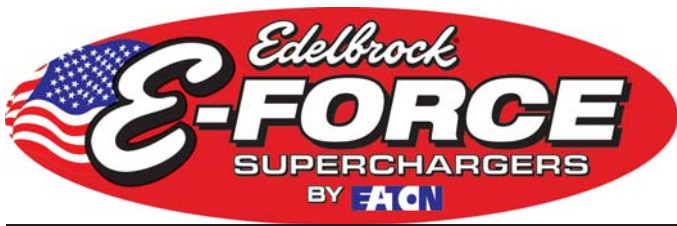

Edelbrock 4.6L Ford Supercharger System for 2005 and later Mustang GTs

Installation Instructions

I. Hood Removal

1. Use a panel puller to pry off two of the push-pins holding the hood insulator in place on the passenger side, then reach behind the insulator to disconnect the washer hose from the T-junction at the passenger side nozzle.



Detach hose retaining clip, then remove these two pins.



Pull hose off here.

(Insulator fully removed for illustrative purposes.)

2. Have an assistant support the hood while a 10mm socket is used to remove the four bolts attaching it to its hinges. Lift the hood off the vehicle and set it aside.



II. Battery Removal

3. Use an 8mm socket to loosen the negative battery terminal clamp and remove it. Tuck it to the side to prevent any accidental contact with the negative battery terminal.

4. Use a 10mm socket to remove the nut on the positive battery terminal that retains the alternator power wire. Detach this wire from the terminal, then loosely reinstall the nut.



5. Use an 8mm socket to loosen and remove the positive battery terminal clamp, then tuck the wire over to the side.

6. Pull the insulating sleeve off of the battery, then use an 8mm socket to loosen the long bolt that secures the battery tie-down strap. The battery can then be removed and set aside.



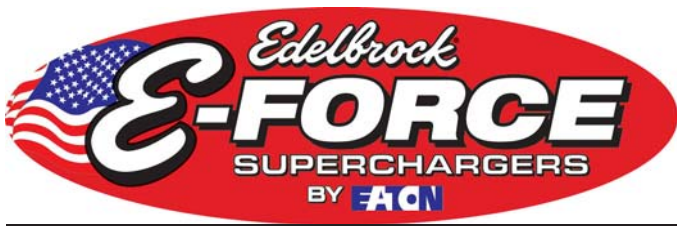

Edelbrock 4.6L Ford Supercharger System for 2005 and later Mustang GTs

Installation Instructions

7. Use a 10mm socket with a 12" extension bar to remove the three bolts holding the battery tray in place, then use a panel puller to detach the wiring harness clip. Remove and set aside the tray.



Bolts

Wiring Harness Clip

8. Use a flat blade screwdriver to pry up the head of the six push-pins that retain the radiator shroud, then use a panel puller to fully remove the push-pins. Lift the shroud off the car and set it and the push-pins aside.

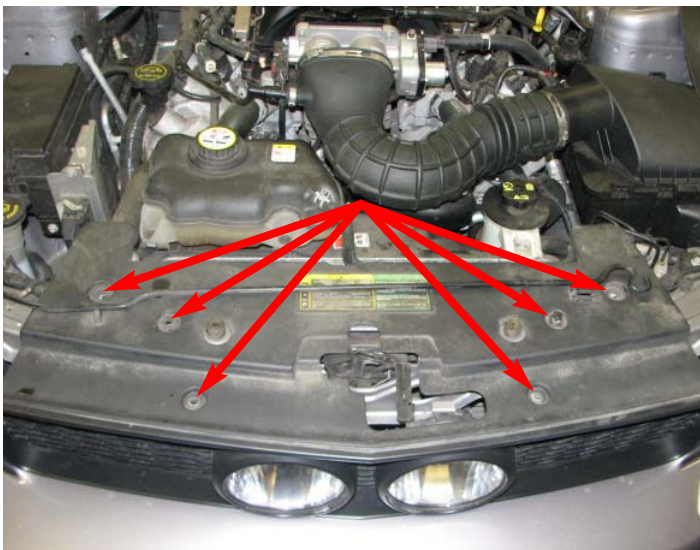

III. Removing Engine Components

9. Detach the charge motion control valve (CMCV) electrical connector at the rear of the manifold. Separate the wiring retainers from the intake manifold stud and the CMCV bracket, then move the wiring harness to the side.



10. Detach the throttle position sensor (TPS) and electronic throttle control (ETC) connectors from the throttle body.



ETC

TPS

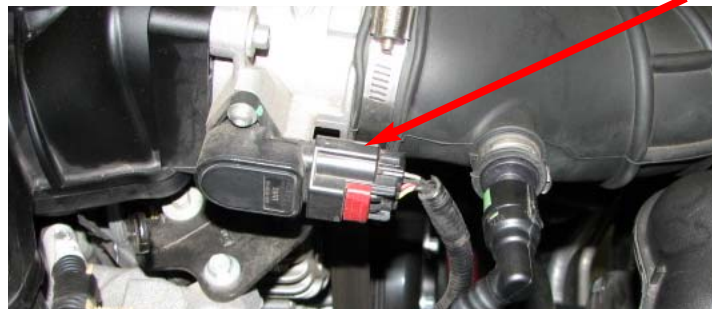

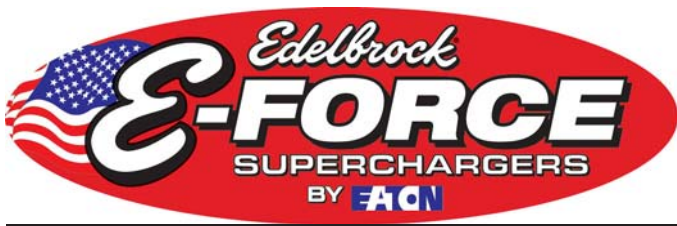

Edelbrock 4.6L Ford Supercharger System for 2005 and later Mustang GTs

Installation Instructions

11. Detach the mass airflow sensor electrical connector from the air filter outlet tube.



14. Disconnect and remove the passenger side PCV hose. This hose will not be reused.



12. Disconnect the evaporative emissions tube from the intake manifold and move it to the side.



15. Detach the electrical connectors from all eight fuel injectors and the fuel pressure sensor.

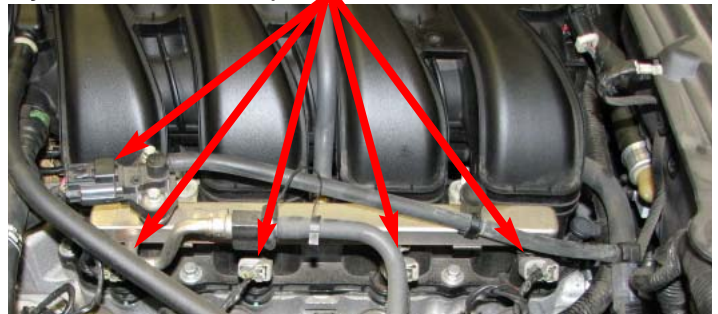

13. Disconnect the PCV line from where it is connected to the driver side valve cover, then disconnect it from the intake manifold and remove it. This hose will not be reused.



16. Disconnect the vacuum hose from the fuel pressure sensor.



17. Detach the battery cable anchors from the fuel rail bolts by pulling upward firmly.

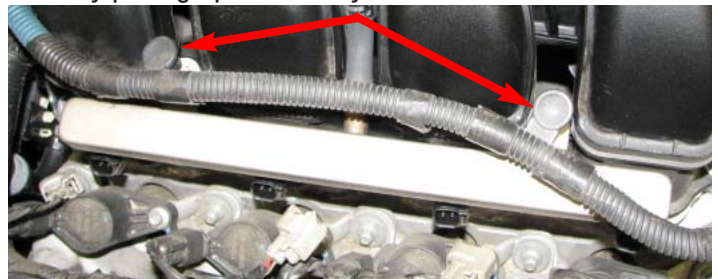



Edelbrock 4.6L Ford Supercharger System for 2005 and later Mustang GTs

Installation Instructions

18. Remove the fuel line lock clip and let it dangle.



19. Use a 5/8" fuel line removal tool to disconnect the fuel supply line from the fuel rails. Use a shop rag wrapped over the connection to absorb the fuel remaining in the system.



20. Disconnect the vacuum hose connected to the brake booster.



Pull hose off nipple, do not remove fitting from booster.

21. Loosen the four studs that hold down the fuel rails. The rails and injectors can then be removed together and set aside.

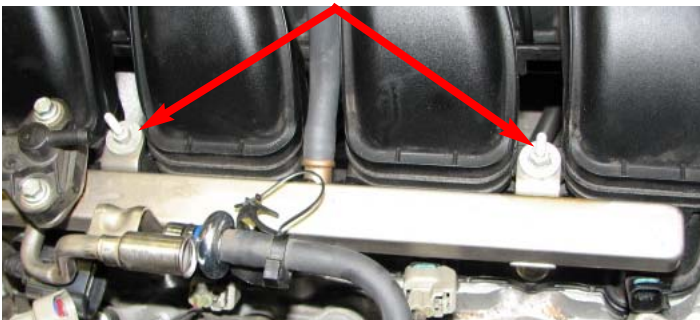

©2009 Edelbrock Corporation
Catalog #1580

22. Remove the retaining clips that hold in the injectors and set them aside for reinstallation later, along with the rails. The stock injectors will not be reused.



23. Use a flat head screwdriver to loosen the worm clamps that retain the air inlet tube between the throttle body and air filter cover, then remove the tube.



24. The manifold bolts may now be removed with a 10mm socket and the intake lifted off the engine. There is no need to detach the throttle body as it will not be reused. Use an extension bar to reach the two center bolts hidden between the runners.



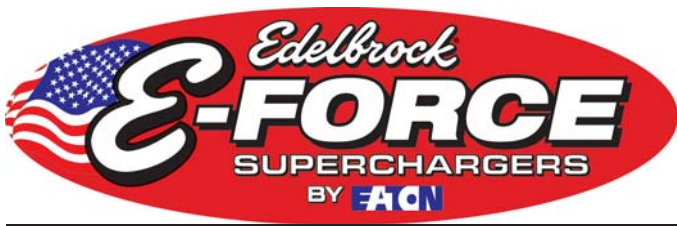

Edelbrock 4.6L Ford Supercharger System for 2005 and later Mustang GTs

Installation Instructions

25. 2005-2008 applications should remove the o-ring seals from the intake manifold and inspect them for damage. Any damaged seals must be replaced; the rest will be retained for reuse with the supercharger runners. 2009 and later applications will use the o-rings supplied in the 15805 Hardware Kit.



26. Use a soft cloth to clean any irregularities on the sealing surfaces of the cylinder heads. Use two strips of masking tape to prevent any debris from entering the exposed ports.



27. Unlatch the air cleaner cover, then use a Torx-20 driver to remove the MAF sensor from the outlet tube. Apply a small strip of tape to the MAF sensor to distinguish it from the modified unit supplied with this kit.

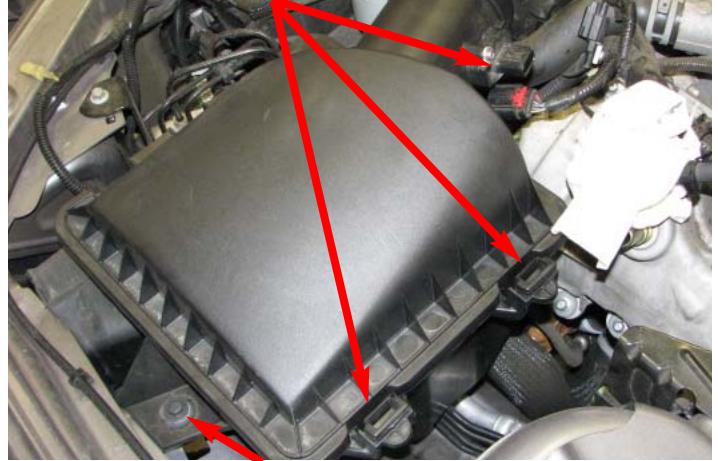

28. Use a 10mm socket to unbolt the air cleaner housing and remove it.

29. Loosen the tensioner arm by using a 1/2" drive breaker bar, and remove the serpentine belt. This belt can be discarded as it will not be reused.

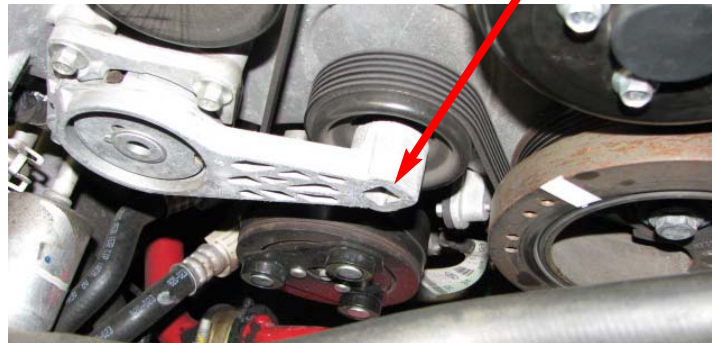

30. Use a 13mm socket to remove the two nuts at the bottom of the alternator.





Edelbrock 4.6L Ford Supercharger System for 2005 and later Mustang GTs

Installation Instructions

31. Use a 10mm socket to remove the two outer alternator bracket bolts, and an 8mm socket to remove the two inner alternator bracket bolts.

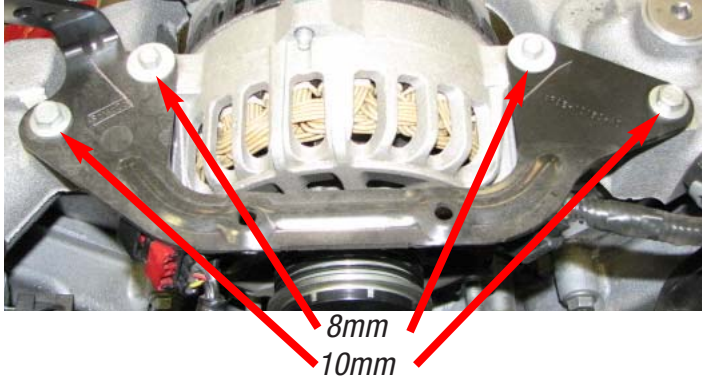

32. Use a panel puller to remove the harness locating pin from the alternator bracket, remove the bracket, then disconnect the alternator electrical connector. Trace the alternator harness back to where it clips into the main harness and detach it. This wire may now be discarded.



33. Push aside the protective boot to access and remove the nut retaining the alternator power wire. The power wire will not be reused and can be discarded. The alternator can now be lifted out and set aside.



©2009 Edelbrock Corporation
Catalog #1580

IV. Front Fascia

34. Use a 10mm socket to remove the two upper front bumper cover bolts, located between the grille and headlights.



35. Use a jack and jack stands or a service lift to raise the front of the vehicle. Use a 5.5mm (or 7/32") socket to remove the seven bolts that retain the lower splash shield, then set the shield and bolts aside.

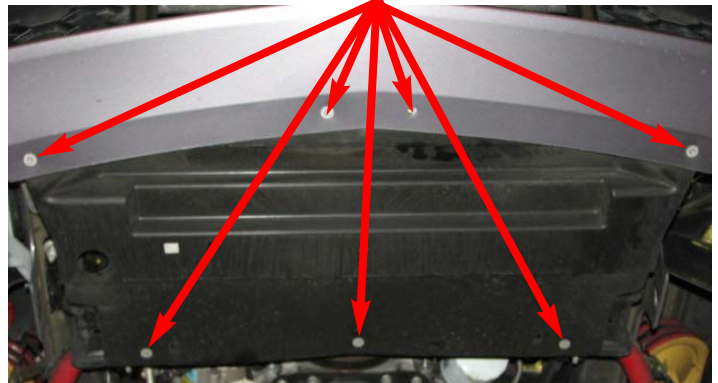

36. Remove the five push-pins and three screws that secure each of the front inner fender wells. Note that the front inner fender wells are divided in two sections, but you will only need to remove the forward half. Turn the head of push-pins that have a philips head recess on them about a quarter turn or until the head pops up, then fully remove the pin with a panel puller. Remove and set aside the forward half of both front inner fender wells.



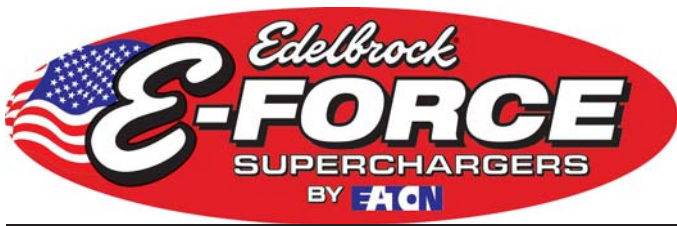

Edelbrock 4.6L Ford Supercharger System for 2005 and later Mustang GTs

Installation Instructions

37. Reach through the fender well with a 10mm socket to loosen the two nuts on each side that attach the front bumper cover to the body.



38. Pull the front bumper cover down off the studs, then forward slightly to access the fog lamp, turn signal and running light electrical connectors. Once these have been detached, the entire front cover can be removed with the lights and indicators in place.

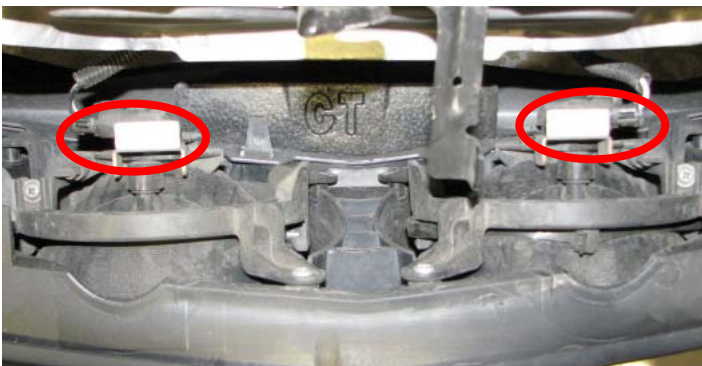

39. Use a panel puller to remove the four pins retaining the foam insulator, then set them and the insulator aside.



©2009 Edelbrock Corporation
Catalog #1580

V. Cooling System

40. To avoid injury be sure the engine has fully cooled before draining the cooling system. Release any excess pressure in the system by using a cloth to rotate the radiator cap counterclockwise. Step away from the vehicle if any hot vapor is vented, then remove the cap.



41. Place a drain pan below the radiator petcock on the passenger side, then use a 19mm wrench to open the petcock and drain the coolant.

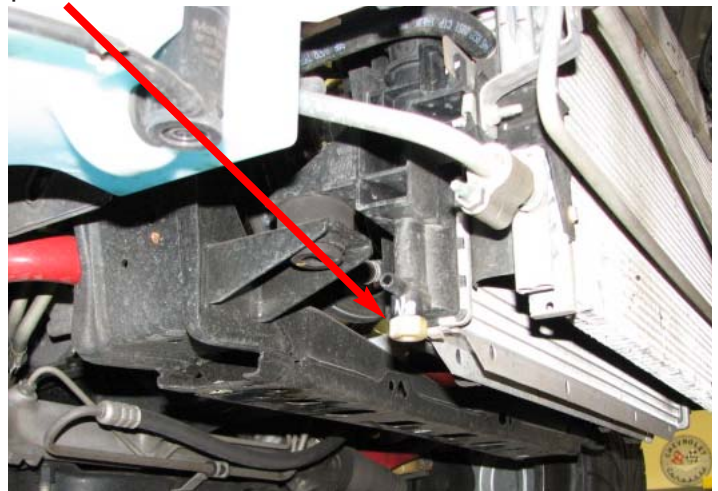

NOTE: If this system is being installed on an '05 or '06 Mustang GT, you will need to have purchased the Cooling System Upgrade Kit #15804 before proceeding with the installation. Otherwise, 2007 and later vehicles should skip ahead to step 48.



Edelbrock 4.6L Ford Supercharger System for 2005 and later Mustang GTs

Installation Instructions

42. Use large pliers or a clamp removal tool to detach both upper radiator hoses from the water crossover.



43. Place shop rags in the engine valley to catch excess coolant, then disconnect the heater hose connected to the bottom of the crossover. Use a 10mm socket to unbolt and remove the water crossover. Remove and save the o-rings for reuse later.



44. Disconnect the lower hoses joining the thermostat housing to the radiator, engine block and the bottom of the coolant recovery tank. Separate the hose clamps from the end of the hoses and save them for reuse later.



45. Disassemble the thermostat housing and remove the thermostat. The thermostat itself can be discarded but the o-ring will be reused.



46. Use a 15mm socket to remove the hose bracket.



47. Connect the radiator hose assembly supplied in the 15804 kit to the driver side radiator fitting and the engine block fitting behind the power steering pump using the stock hose clamps. The long segment should be connected to the bottom of the coolant recovery tank, also reusing the stock hose clamp.



Radiator Engine Block Coolant Recovery Tank

NOTE: '05-'06 applications can skip ahead to step 51, the following steps only apply to '07 and later Mustangs.



Edelbrock 4.6L Ford Supercharger System for 2005 and later Mustang GTs

Installation Instructions

48. Disconnect the upper radiator hose from the thermostat housing and radiator, then set it aside.
49. Remove and save the thermostat, its housing and the o-ring for later reuse.
50. Unbolt and remove the water crossover from the front of the engine block and unclip the heater hose from the bottom. Save the o-ring seals for later reuse.

VI. Installing Intercooler Accessories

51. Replace the two upper inside bumper bolts with the two M8 x 30mm long hex flange bolts included in hardware bag #5.



52. Replace both outer bumper bolts on the passenger side with the two M8 x 30mm hex flange bolts supplied in hardware bag #5.

53. Hang the heat exchanger behind the bumper reinforcement on the inner bumper bolts replaced in step 52 and secure it with the four M8 flange nuts supplied in hardware bag #5.

54. Install the supplied 5" piece of 3/4" hose onto the outlet of the intercooler water pump, secure it with the supplied hose clamp, then slide a second clamp onto the hose to secure it on the heat exchanger.



©2009 Edelbrock Corporation
Catalog #1580

55. Hang the water pump on the passenger side outer bumper bolts while pushing the outlet hose onto the inlet nipple of the heat exchanger. Secure the hose with a clamp, and the water pump bracket with two of the M8 flange nuts supplied.



56. Install the long 3/4" hose onto the driver side barb of the heat exchanger and secure it with a clamp.



VII. Wiring

57. Locate the large multi-pin connector (C110) secured to the driver side of the PCM bracket. This connector has 12 pins in '05 Mustangs, while '06 and later cars have a 16-pin connector in this location.

58. Separate the harness connectors. '05 and '06 applications should trim enough electrical tape from the harness behind the chassis side connector (closest to the radiator) to pull out 2" of wire from the convoluted tubing. '07 and later applications will trim the electrical tape from behind the engine connector (closest to the firewall) to pull out 2" of wire from the convoluted tubing.



Chassis Side for
'05 & '06 Mustangs

Engine Side for
'07 & Later Mustangs

Brochure #63-1580
Rev. 2/09 - AJ/mc

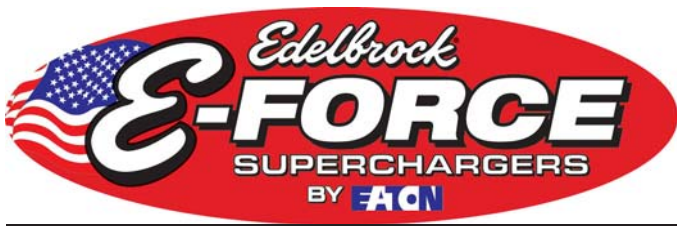

Edelbrock 4.6L Ford Supercharger System for 2005 and later Mustang GTs

Installation Instructions

59. '05 applications should locate the red wire in pin 10, near the bottom of the connector. '06 applications should locate the red wire in pin 2, at the top left of the connector. '07 and later applications should locate the red wire with the yellow stripe in pin 16.



'06 Model Year Example

60. Once you have located the appropriate wire for your model year application, cut the wire 1.5" back from the connector and strip the end on the harness side.

61. Insert the the exposed end of the stripped harness wire into the butt connector pre-installed on the yellow wire with the red stripe of the intercooler water pump harness. Secure the connection by crimping the butt connector with an appropriate crimp tool, then use a heat gun on the connection until it shrinks.



62. Remove the relay from the relay socket on the supplied intercooler water pump wiring harness.

63. Mount the pump relay on the lower passenger side fascia bracket bolt. Apply a light coat of blue loctite to the bolt threads, then secure the relay holder with an M6 nut supplied in hardware bag #7. Reinstall the relay.

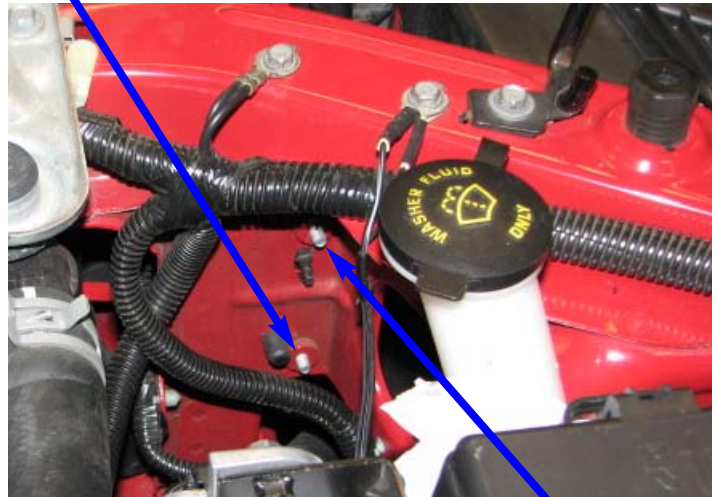

64. Route the ground wire to the upper fascia bracket bolt and secure it with an M6 nut from hardware bag #7.

65. Route wires under the fuse box and attach the fuse holder to the passenger side strut tower with a 10mm socket and the M6 bolt supplied in hardware bag #7. This bolt hole is threaded on '07 and later Mustangs, but '05 and '06 will need to use an M6 nyloc nut supplied in the #15804 Cooling Upgrade Kit.

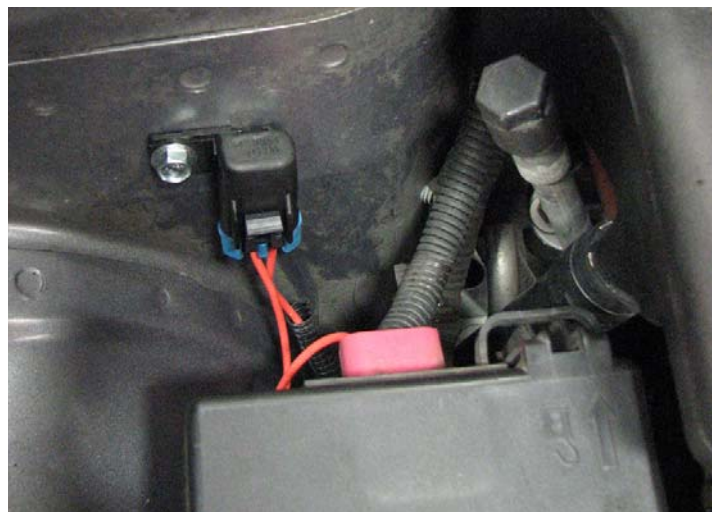

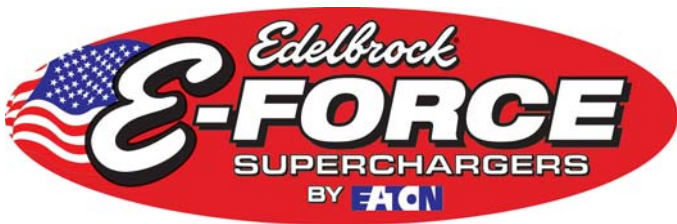

Edelbrock 4.6L Ford Supercharger System for 2005 and later Mustang GTs

Installation Instructions

66. Use a 10mm socket to attach the power wire to the power terminal on the fuse box



67. Route the water pump electrical connector below the fuse box and around the washer fluid reservoir and plug it into the intercooler water pump.

68. Locate the ETC electrical connector on the main engine wiring harness, previously removed from the driver side of the throttle body. Use a hooked terminal removal tool or dental pick to elevate the red plastic wedge lock inside the connector.



69. Use a de-pinning tool, needle or safety pin to slide under the terminal and lift the locking tab while pulling gently on the corresponding wire to de-pin the connector. De-pin both wires and remove the connector.

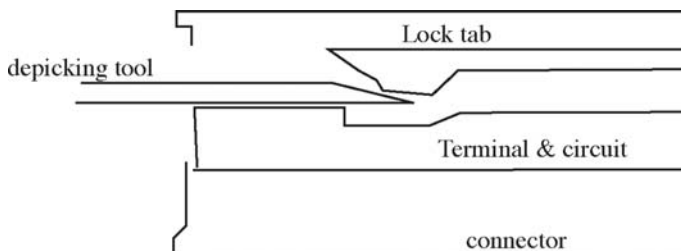

Recommended Tools

70. Detach ETC connector from supplied ETC extension harness and raise wedge lock. Insert the red wire with the yellow stripe into Pin 1 of the new ETC connector by aligning the slot on the wire terminal with the tab in the connector and pushing gently until it clicks into place, then insert the blue wire with the yellow stripe into Pin 2 and seat it gently.

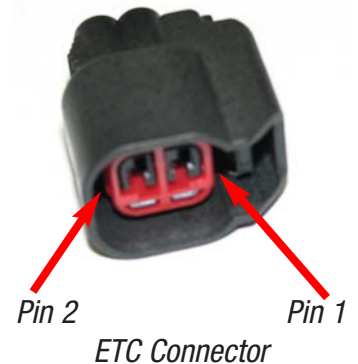
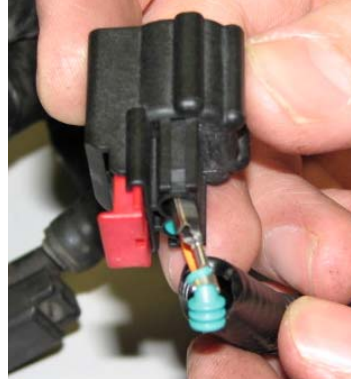

71. Once both wires are seated in the connector, depress the red wedge lock to secure them in place.



72. Install the short ETC harness extension onto the newly pinned connector.

73. Locate the TPS connector on the passenger side of the main engine wiring harness. Use a small pick or screwdriver to release the center locking tab while prying up on the white wedge lock.

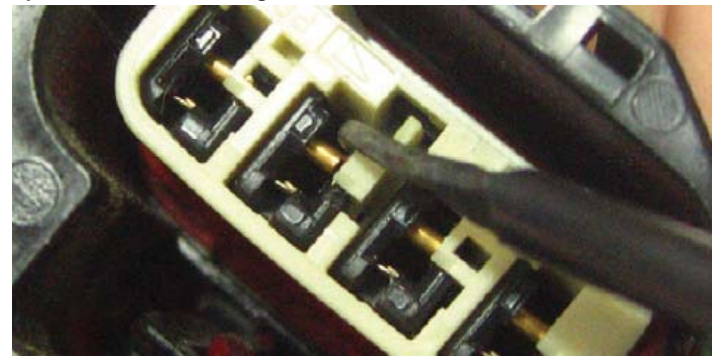

Installation Instructions

74. Once the wedge lock is elevated, de-pin all four wires on the connector using the same procedure as with the ETC connector.

75. Detach the TPS connector from the TPS/Alternator extension harness and raise the wedge lock by pushing the center lock tab and pulling up. Align the slot on the wire terminal with the tab in the connector, then insert the yellow wire with the white stripe into Pin 1 of the TPS Connector and seat it gently.

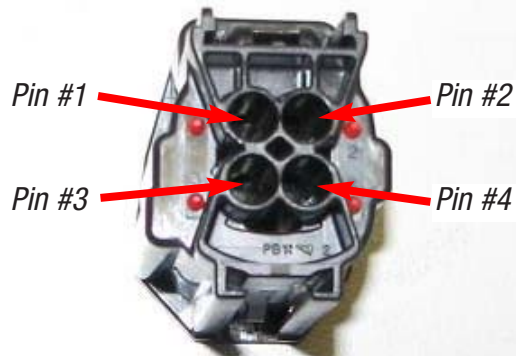
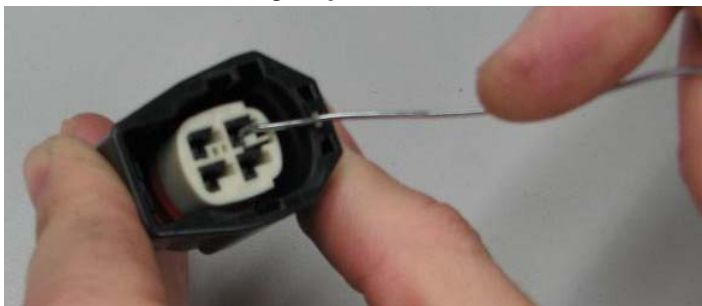

TPS Connector

76. Insert the red wire with the green stripe into Pin 2 of the TPS Connector and seat it gently.

77. Insert the black wire with the green stripe into Pin 3 of the TPS Connector and seat it gently.

78. Insert the grey wire with the white stripe into Pin 4 of the TPS Connector and seat it gently. Depress the white wedge lock to secure the wires in place.

79. Attach the electrical connector of the TPS/Alternator wiring harness to the connector you just installed.

80. Locate the electrical connector on the main harness previously occupied by the alternator control wiring harness. Attach the round alternator connector on the supplied TPS/Alternator harness into this connector and route the harness around the back of the engine bay, then forward along the driver side cylinder head.

81. Locate the MAF sensor connector on the driver side of the main engine wiring harness. Use a pick shaped tool to hook the center tab provision on the face of the connector and pry the wedge lock out altogether.

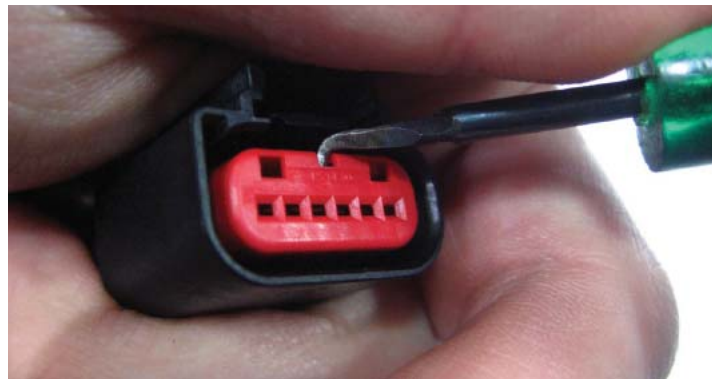

82. Use a razor or sharp knife to cut the electrical tape directly behind the connector, then pull the connector away from the convoluted tubing until 2" of wire have been exposed.

83. Use a small needle or safety pin to de-pin and remove the two wires on the right side (gray and gray with a red stripe).



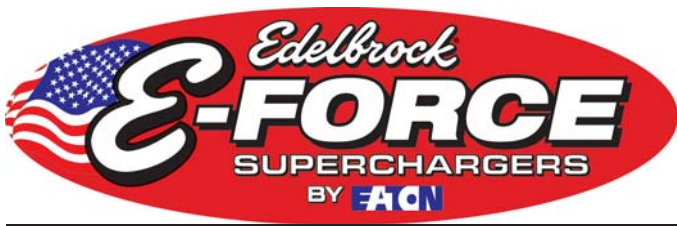

Edelbrock 4.6L Ford Supercharger System for 2005 and later Mustang GTs

Installation Instructions

84. Detach the TMAP connector from the supplied TMAP wiring harness and raise the wedge lock. Insert the gray wire into Pin 1 of the supplied TMAP connector and seat it gently.

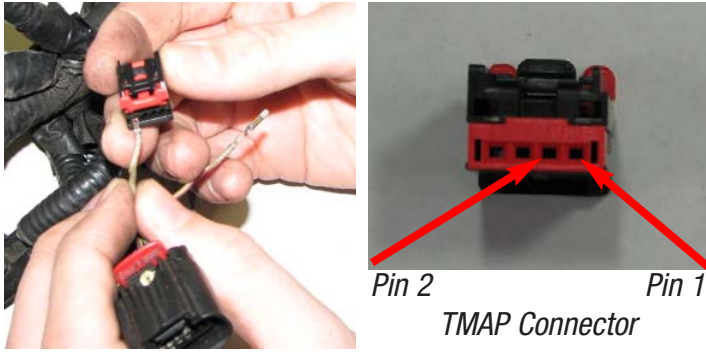

85. Insert the gray wire with the red stripe into Pin 2 of the TMAP connector and seat it gently. Depress the red wedge lock to secure the wires in place.

86. Reinstall the red wedge lock into the OEM MAF sensor connector and push it gently until seated.



87. Tuck the wires back into the convoluted tubing and secure them with a small strip of electrical tape.

88. Install the TMAP wiring harness extension onto the new connector and route it towards the back of the engine bay.

VIII. Cooling System Modifications

89. Route the molded hose under the fuse box and onto the inlet at the top of the water pump. Secure it with a clamp.



90. Remove the two inner passenger side strut tower nuts and hang the recovery tank bracket from the exposed bolts. Do not reinstall strut nuts at this time.



91. Slide the molded hose onto the bottom barb of the tank and secure it with a clamp.

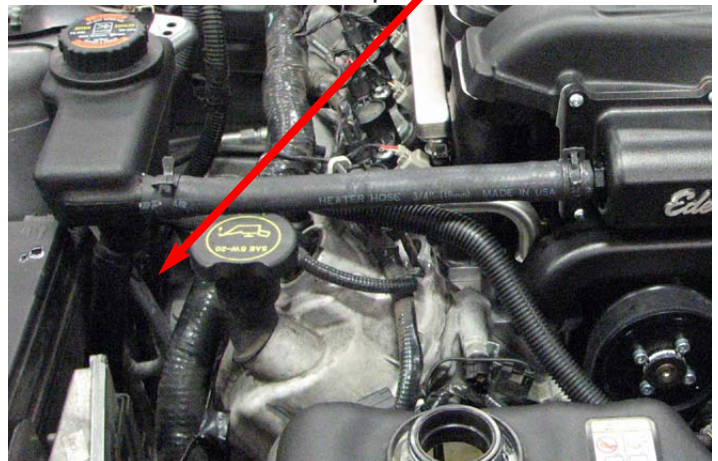

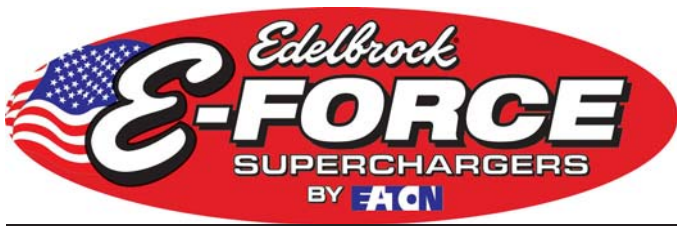

Edelbrock 4.6L Ford Supercharger System for 2005 and later Mustang GTs

Installation Instructions

92. Reinstall the foam bumper insulator and secure it in place with the stock body pins.

93. Reconnect the fog lights and indicators, then replace the fascia onto the front of the car. Reach through the fender wells to reattach the nuts that secure it.

94. Reinstall the screws and push in rivets that secure the inner fender wells, then reinstall the upper front fascia bolts.

95. Replace the lower splash shield and the radiator shroud and secure them with the stock fasteners. The vehicle can now be lowered.

96. Two hard coolant lines are held in place in the engine valley by a bracket bolted to the rear of the passenger side cylinder head. Remove the bolt holding this bracket in place, then unclip the lower hose from the firewall.



97. Unclamp the upper hose from the hard line, then remove both hard lines, being careful not to damage the nipple in the bottom of engine valley.

98. Place the coolant pipes in cloth wrapped vice jaws to avoid damaging them, then use a hacksaw or cut-off wheel to separate the tubes by cutting the two brackets, as shown below.



©2009 Edelbrock Corporation
Catalog #1580

99. Once the coolant pipes have been separated, reinstall the smaller diameter of the two by gently sliding it onto the nipple in the engine valley and securing it onto the back of the head with the stock bolt. The lower hose and larger diameter hard line can be discarded.



100. Reattach the upper heater hose to the hard line with the stock hose clamp.



IX. Installing New Components.

101. Use a 13mm socket to remove the two idler pulleys on the driver's side of the engine, but save one of the mounting bolts for later.

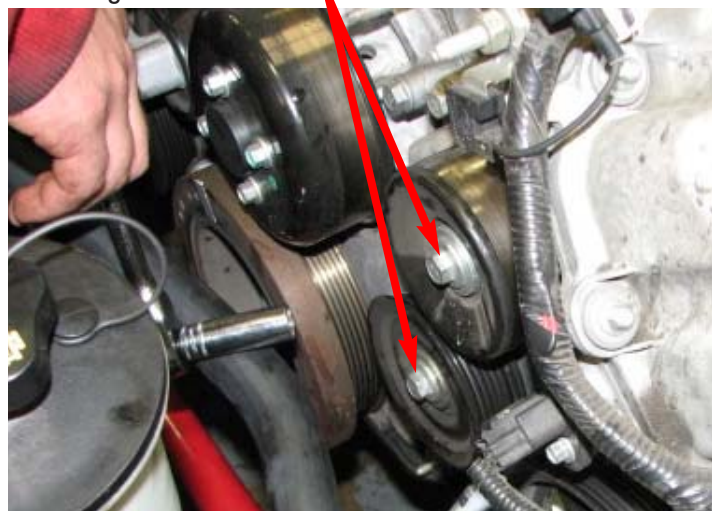

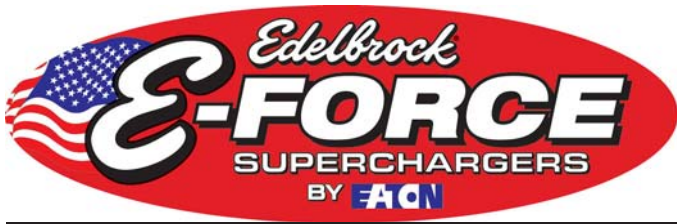

Edelbrock 4.6L Ford Supercharger System for 2005 and later Mustang GTs

Installation Instructions

102. Install the smaller of the two Edelbrock supplied idler pulleys onto the alternator bracket with the open end facing the bracket. Secure it with a small amount of blue Loctite applied to the bolt saved in the previous step, then use a 13mm socket to torque it down to 18 ft/lbs.



103. Remove the alternator mounting stud on the driver's side of the engine using a 5.5mm socket, or thread a second nut onto the stud as shown, and use a 13mm wrench on the nut closest to the block to remove the stud.



104. Use a 13mm socket to remove the two upper driver side front cover bolts, and an 18mm socket to remove the bottom driver side bolt, as shown below.

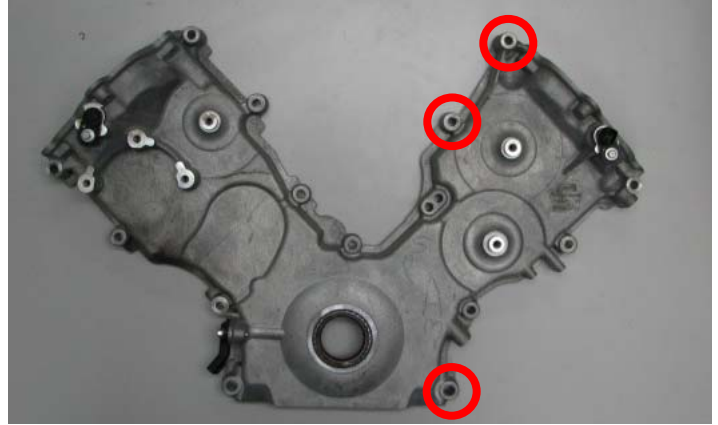

105. Slide the larger of the two Edelbrock supplied idler pulleys onto the lower idler boss of the front cover with the open side facing the engine block.



106. Use a 12mm deep socket and a small amount of blue loctite to install the alternator bracket using the bolts supplied in hardware bag #3. The upper two provisions will use the 65mm bolts, while the bottom provision will use the 75mm bolt. The center hole will use a 35mm bolt that will pass through both the bracket and pulley, and then thread into the front cover.

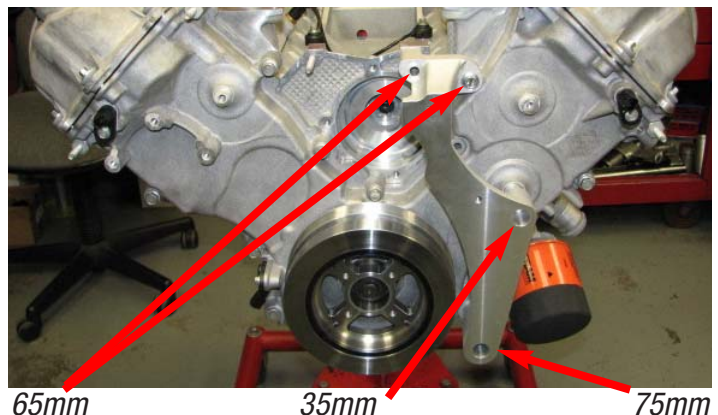



Edelbrock 4.6L Ford Supercharger System for 2005 and later Mustang GTs

Installation Instructions

X. Installing Spark Plugs (Not Included In 1585)

NOTE: The following steps only apply to Mustangs built prior to December, '07. Later applications have the proper heat range spark plug installed from the factory and will not use the supplied plugs. These Mustangs should skip ahead to **'Installing the Supercharger'**. Early model spark plugs that need to be replaced have a ground strap that extends all the way around the electrode, while late models have a standard 'L' shape. '08 Mustangs should remove a single plug to determine their style of plug, and if replacement is necessary.



Early Model Plug

107. Use a 7mm socket to remove the bolt that secures each ignition coil, then use a slight twisting motion to remove the coils.

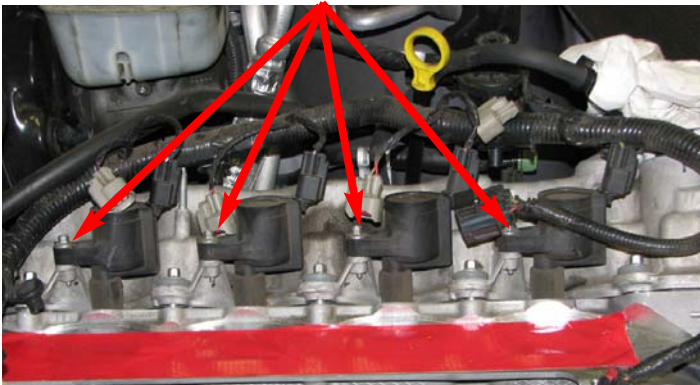

108. Use compressed air to clean out the spark plug well, then remove the stock spark plugs with a 9/16" spark plug socket.

109. Coat the threads of the Edelbrock supplied spark plugs with anti-sieze, and torque them to 25 ft/lbs.

110. Apply a thin layer of dielectric grease to the inside of the coil boots, then reinstall them onto the plugs.

111. Tighten the coil retaining bolts to 44 in/lbs.

©2009 Edelbrock Corporation
Catalog #1580

XI. Installing the Supercharger

112. Install the Edelbrock supplied heater hose on the firewall connector, and lay it to the side for now.



113. Remove the supercharger assembly from its packing container and install the o-ring seals, removed from the stock manifold on early applications and supplied in the #15805 Hardware Kit for 2009 applications, into the grooves on the bottom of the runners. Be sure to line up the tab on the o-rings with the notches provided.



114. Be sure that the engine bay and environs are clean and free of debris, then remove the masking tape used to protect the intake ports from contamination.

115. Install the o-ring gaskets removed from the stock water crossover into the supplied crossover.

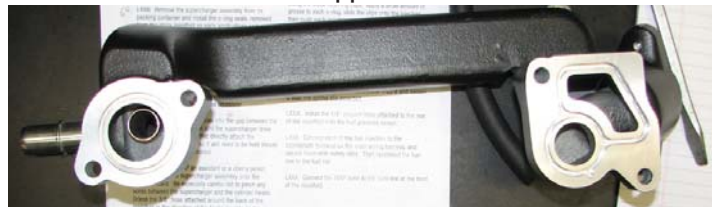



Edelbrock 4.6L Ford Supercharger System for 2005 and later Mustang GTs

Installation Instructions

116. Insert the water crossover into the gap between the intercooler manifold and the and the supercharger drive pulley. There are no bolts that directly attach the crossover to the manifold, so it will need to be held steady as the supercharger is installed.



117. With the help of an assistant or a cherry picker, carefully lower the supercharger assembly onto the cylinder heads. Be especially careful not to pinch any wires between the supercharger and the cylinder heads. Orient the attached 3/8" hose around the back of the manifold in the direction of the brake booster as the supercharger is lowered.

118. Push the supercharger as far to the rear of the engine bay as space allows so that the supplied bolts can be inserted into the provisions on the crossover. Pull the crossover forward against the bolts, then torque them to 7-1/2 ft/lbs with a 10mm socket.

119. Ensure correct alignment of the supercharger by looking through the injector holes to verify that they are aligned with the injector provisions of the cylinder head and that the manifold is centered left to right as well as front to back on the engine block.

©2009 Edelbrock Corporation
Catalog #1580

120. Use a 10 mm socket to install the supplied intake bolts, and torque them to 8 ft/lbs in the sequence shown.

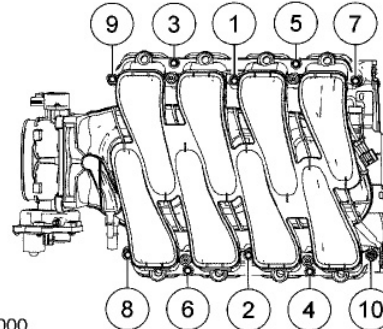

N0014000

121. Install the new fuel injectors (not included in 1585) into the stock fuel rails by applying a bit of o-ring lube to both o-rings of each injector, sliding the stock retaining clips onto the injectors, then pushing each injector into the rail until the clips snap into place.



122. Align each of the fuel injectors with its prospective well, then pull the top of the rail outboard so that the the brackets will clear the runner flanges as you push the rail down. Make sure that the TMAP wiring harness is routed below the driver side rail. The rails and injectors are fully seated once the rail brackets contact the runner bosses. Use a 5mm allen tool to secure the rails with the M6 socket head bolts supplied in hardware bag #2.





Edelbrock 4.6L Ford Supercharger System for 2005 and later Mustang GTs

Installation Instructions

123. Install the 3/8" vacuum hose attached to the rear of the manifold onto the brake booster nipple and secure it with the spring clamp provided.



124. Install the 1/4" vacuum hose attached to the rear of the manifold onto the fuel pressure sensor.



125. Connect each of the fuel injectors to the appropriate terminal on the main wiring harness, then reconnect the fuel line to the fuel rail and secure it with the lock clip.

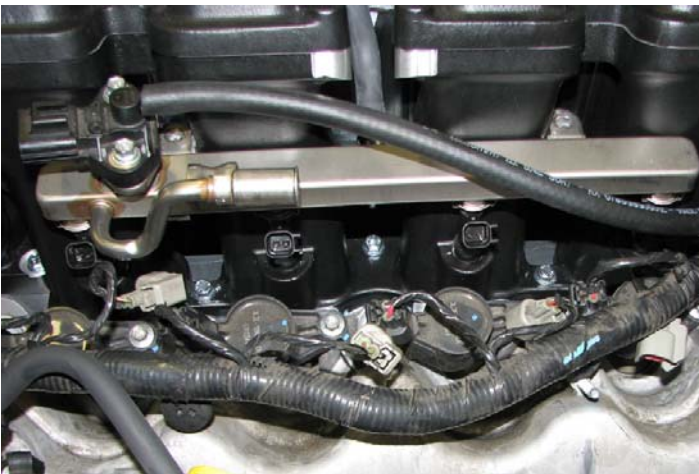

126. Connect the EVAP hose to the hard line at the front of the manifold.



127. Reconnect the fuel pressure sensor to the main wiring harness. Be sure to use the connector that does not have a red locking tab, the connector with a red locking tab is for the TPS.



128. Plug wiring harness extension into TMAP sensor.



XII. Modifying Stock Components

129. Use a 10mm socket to loosen the three bolts that hold the tensioner in place and remove the arm.



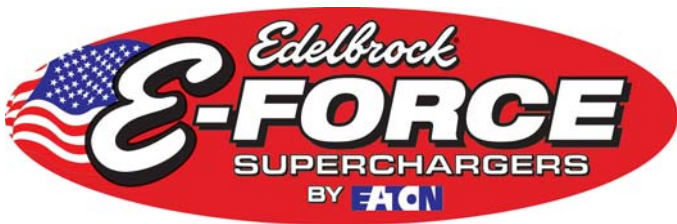

Edelbrock 4.6L Ford Supercharger System for 2005 and later Mustang GTs

Installation Instructions

130. Place the tensioner in a cloth wrapped vice and use a grinding wheel or hacksaw to remove the stop.

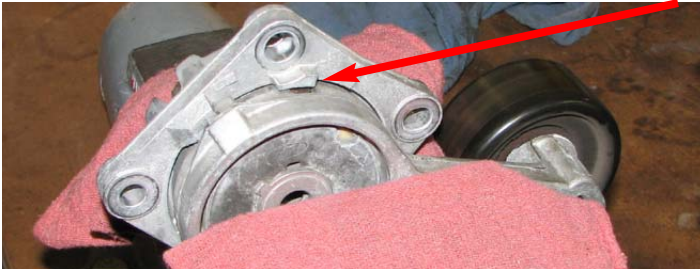

131. Use a grinding wheel or file to ensure that the area that was ground down is smooth and free of burrs.

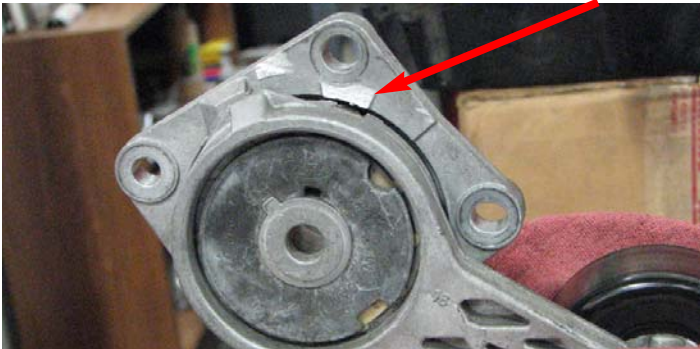

132. Use a 10mm socket to install the three tensioner brace bolts, making sure to line up the square holes.



133. Use a 10mm socket to reinstall the tensioner.



134. Use a flat head screwdriver to pop off the bearing cover on the alternator pulley. '05-'08 applications should use the supplied tool with an impact wrench to remove the stock pulley. '09 and later applications should use a 24mm allen tool with an impact wrench.

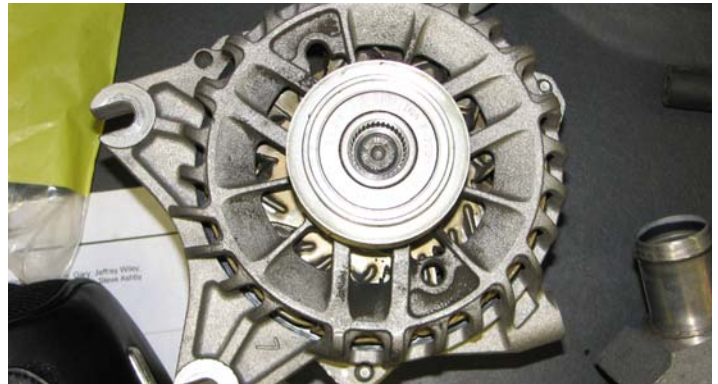

135. Install the new alternator pulley with the nut supplied in hardware bag #3 (with kit #15805 for '09 Mustangs) and blue Loctite.



136. Attach the stock protective boot to the new alternator power wire and fasten it to the alternator terminal with a 10mm socket. Route the wire around the back of the engine towards the battery, then attach the new alternator control wiring harness connector from the TPS/Alternator extension harness to the alternator.





Edelbrock 4.6L Ford Supercharger System for 2005 and later Mustang GTs

Installation Instructions

137. Unbolt the power steering reservoir so that it can be pushed out of the way while installing the alternator.



138. Thread the serpentine belt through the alternator bracket and over the alternator pulley before securing the alternator to the bracket with the two M8 x 40mm bolts supplied in hardware bag #3. Verify that the alternator is fully seated on the bolts before torquing them to 18 ft/lb.

139. Use a 12mm socket to fasten the alternator strap to the front cover using the M8 x 60mm long bolt supplied in hardware bag #3, then tighten it to 18 ft/lbs. Secure the strap to the alternator with the M6 x 20mm bolt from hardware bag #3 and tighten it to 8 ft/lbs.

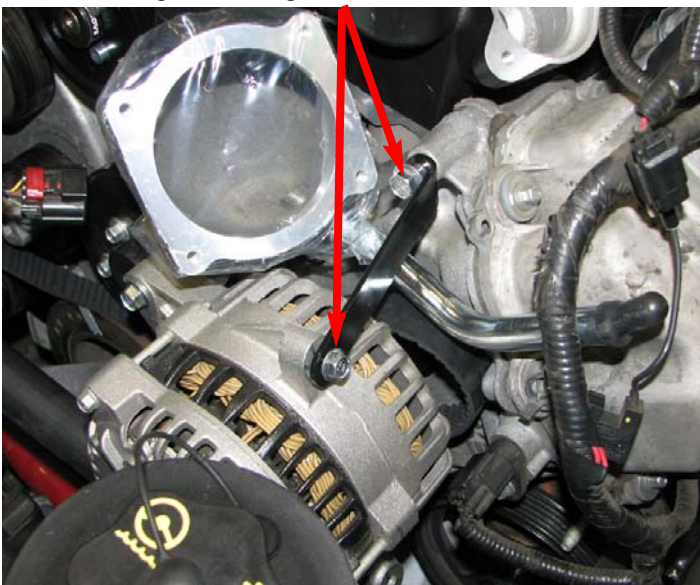

©2009 Edelbrock Corporation
Catalog #1580

140. Route the supplied serpentine belt according to the diagram provided below by using a 1/2" breaker bar to twist the belt tensioner enough to allow the belt to slide into place.

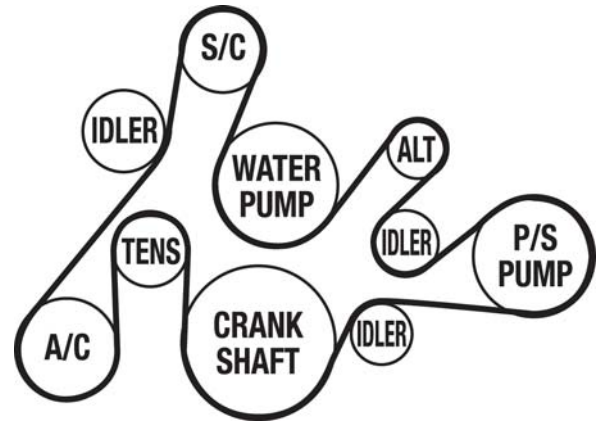

XIII. Installing the Throttle Body

141. Use 8mm and 10mm sockets to unbolt the OEM throttle body from the stock intake manifold, using care not to damage the motor housing.



142. Use a T20 Torx driver to remove the motor housing, plastic capped spring, and TPS from the OEM throttle body. **WARNING:** Rotating the TPS when removing or installing it may damage the internals beyond repair.

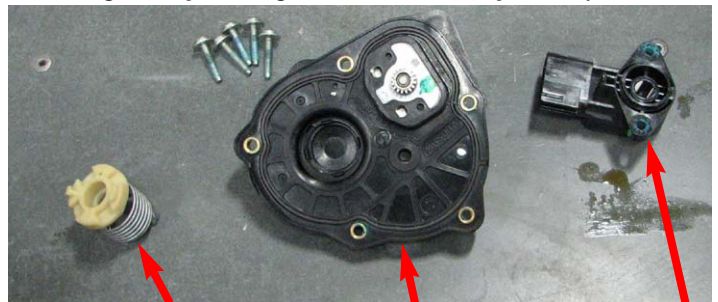

Plastic Capped Spring

ETC

TPS

Brochure #63-1580
Rev. 2/09 - AJ/mc



Edelbrock 4.6L Ford Supercharger System for 2005 and later Mustang GTs

Installation Instructions

143. Carefully remove the motor housing cap.



144. Install the plastic capped spring into the new Edelbrock supplied throttle body so that the pigtail end is hooked into the catch slot of the gear on the end of the throttle shaft.

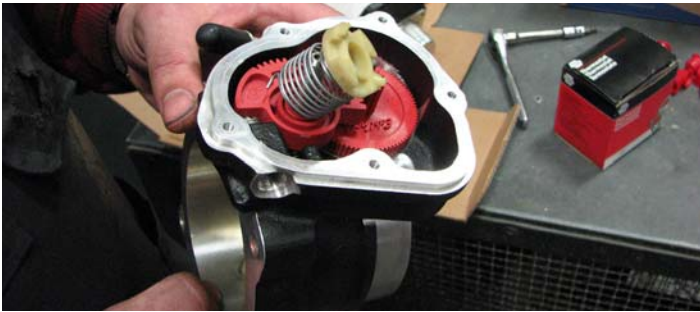

145. Install the ETC motor over the plastic capped spring and tighten the screws that hold it in place.

146. Use needle nose pliers to rotate the plastic spring cap roughly half a turn counter-clockwise until the two tabs line up with the notches in the motor housing. Pull up on the cap until it snaps into place.



147. Reinstall the motor housing cap by lining up the tabs and applying light pressure.

148. Reuse the stock bolts to install the TPS on the new throttle body by lining up the locating tab and pushing it straight on. Be careful to avoid rotating the TPS during installation.

149. Verify correct installation by pushing the butterfly open and closed a few times, making sure that it doesn't stick or bind in a particular position.

150. Align the throttle body gasket on the flange, then install the throttle body onto the inlet elbow with the bolts supplied in hardware bag #4. Open the throttle blade and align the two parts so that there is a smooth transition before tightening the bolts.



151. Use a cut off wheel or hacksaw and drill to cut the base of the airbox off as shown, then reinstall the airbox.

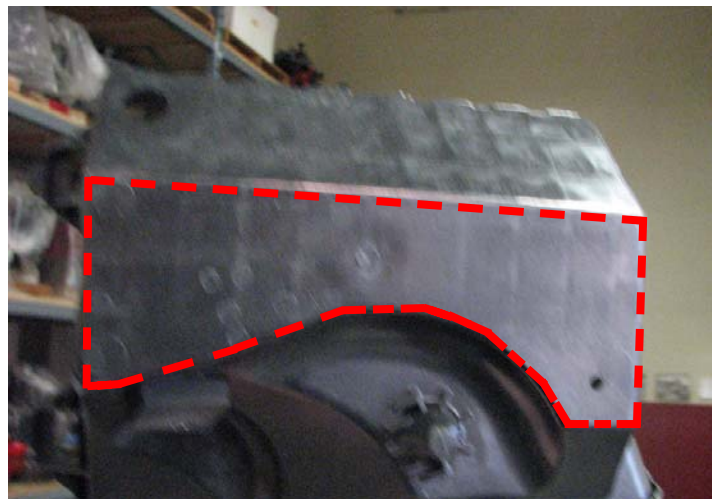

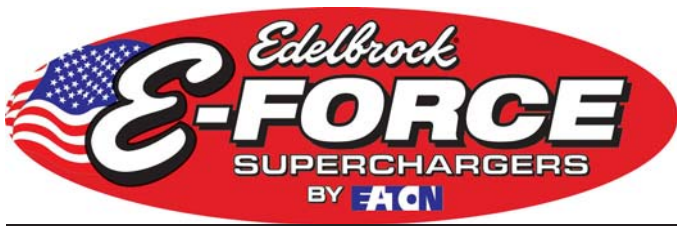

Edelbrock 4.6L Ford Supercharger System for 2005 and later Mustang GTs

Installation Instructions

152. Install the new high flow air filter in the airbox.

153. Use a T20 Torx driver to install the new MAF sensor in the air cover outlet tube, torque the two screws that retain it to 18 in/lbs., then reinstall the cover.



154. Install the throttle body elbow onto the throttle body and secure it with the provided hose clamps. The flexible elbow should be oriented so that it can be easily mated to the air cleaner cover outlet tube.



155. Route the new driver side PCV hose between the valve cover and intake elbow, then install the passenger side PCV hose between the fitting on the throttle body and valve cover.



156. Install the ETC extension harness and attach the electrical connectors for the TPS and ETC stepper motor.

157. Install the 12" piece of 3/4" hose from the recovery tank to the intercooler manifold fitting. Secure each end with a clamp.



158. Route the other end of the hose up to the intercooler manifold outboard of the A/C line, avoiding close proximity to the exhaust manifold and power steering pump, and attach it to the manifold fitting with a clamp.



159. Install the thermostat, o-ring & housing (thermostat and housing supplied in #15804 for '05-'06 applications, all model years reuse stock o-ring) onto the driver side of the water crossover. Torque the thermostat housing bolts to 7-1/2" ft/lbs. Install the stock molded hose onto the thermostat housing and line the other end up with the passenger side radiator fitting. Trim 1-1/2" from the radiator side of the hose to achieve the best fit.

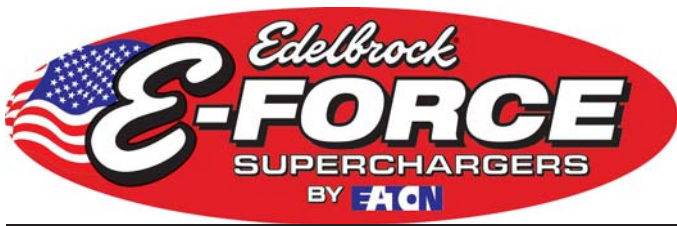

Edelbrock 4.6L Ford Supercharger System for 2005 and later Mustang GTs

Installation Instructions

160. Install the supplied heater hose onto the heater tube on the passenger side of the water crossover.



161. Verify that the coolant petcock is closed, then refill the coolant system.

162. Fill the intercooler system with a 50/50 blend of water and coolant poured into the recovery tank. Fill the tank until the water level is roughly 1" from the top of the threaded neck.

XIV. Installing Coil Covers (Does Not Apply To 1585)

163. Lift the recovery tank off the strut tower bolts and fold it forward.



164. '05 & '06 applications should tape off the strut tower brackets to prevent damaging the covers during installation. On some '05 & '06 vehicles, it may be necessary to clearance the flange on the bottom of the strut tower brackets in order for the covers to fit properly.



©2009 Edelbrock Corporation
Catalog #1580

165. Install the coil cover brackets onto the coil covers with the raised portion of the bracket facing towards the top of the cover, while the lower 'L' portion faces in towards the center of the cover, as shown below.



166. Apply a small amount of blue loctite to the thread of each bolt supplied in hardware bag #8, then tighten them with an 1/8" allen wrench while holding the nut steady with a 5/16" wrench.



167. Remove the engine oil dipstick.

168. Lube the grommet supplied with the driver side cover with silicone spray, then slide it over the dipstick tube and wiggle it into place with your thumbs as you lower the driver side cover into place.



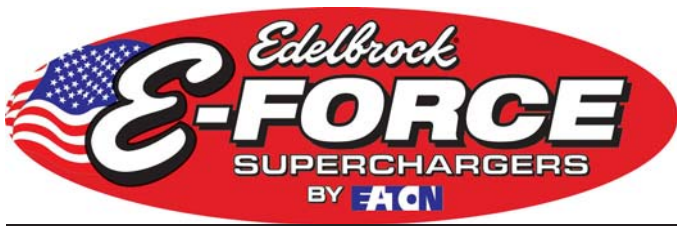

Edelbrock 4.6L Ford Supercharger System for 2005 and later Mustang GTs

Installation Instructions

169. Lower the driver side coil cover into place, orienting the bracket so that it lines up with the bolt provision below the TMAP sensor. Use caution not to pinch the TMAP wire harness as you are fastening the cover bracket to the runner with the supplied thumb screws. Verify that the cover stands are flush on the valve cover and not pinching any wires or hoses. Install the oil dipstick.



170. Install the passenger side cover by lowering it into place and fastening the thumbscrews. Use caution not to pinch any wire harnesses or heater hoses.



171. Replace the recovery tank on the strut tower bolts, then install and torque the strut tower nuts to 26 ft/lbs.

172. Reinstall the battery tray, battery, protective sleeve and tie down strap, then secure the battery. Reconnect the positive and negative clamps to their respective terminals, and connect new alternator power wire to the positive battery terminal.

173. Turn the ignition key to the 'ON' position.

174. Verify that water is flowing briskly through the recovery tank, then install the cap.

175. Have an assistant support the hood while you tighten the four bolts that secure it to its hinges. Be careful to verify that it is properly aligned and that the supercharger has nothing on top of it before you attempt to close the hood.

176. Reattach the washer nozzle hose and replace any hood insulator body pins that were removed.

XV. Flashing the ECU

177. Plug the supplied programming module into the OBD-II port of the car, located below the steering column.



178. Once the main menu has loaded, press the central 'select' button on the controller to access the 'Performance Tune' option.

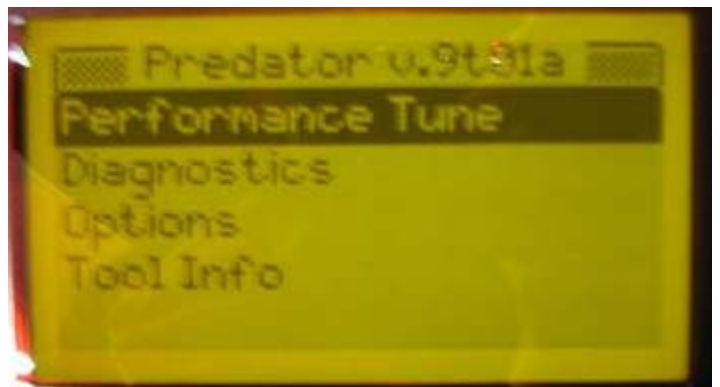

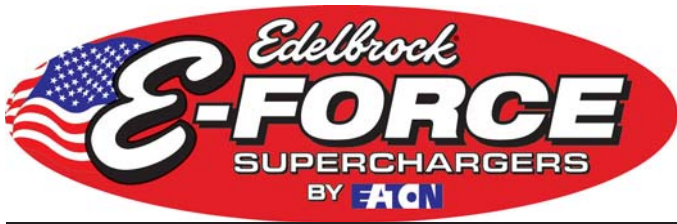

Edelbrock 4.6L Ford Supercharger System for 2005 and later Mustang GTs

Installation Instructions

179. Read the disclaimer carefully, then choose 'Agree' and press select.

180. Use the arrow buttons to select your transmission, then press select to confirm your selection.

181. Select 'Edelbrock E-Force 5psi' from the menu.

182. Read description and press select.

183. The programmer will automatically save a copy of your existing engine tune. Press select to continue.

184. Turn the ignition key to the 'OFF' position when prompted, but do not remove it.

185. Turn the ignition key to the 'ON' position when prompted, but do not attempt to start the car. the programmer will automatically start saving the stock calibration.

186. Once complete, follow the on-screen prompts regarding key position until you are given the option to 'Install Tune' or 'Modify Tune'. Choose 'Modify Tune' and press select.

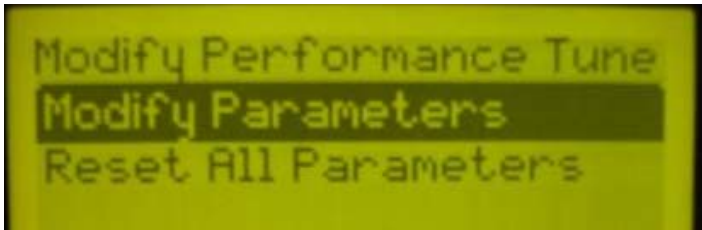

187. Read the disclaimer and press select.

188. Select 'Modify Parameters' and press select.

189. Press select to choose 'Axle Ratio'.

190. Press select to choose 'Axle Ratio', again.

191. Use the directional buttons to choose the number closest to your axle ratio (printed on the differential cover) and press select.

192. Press select to confirm your choice.

193. An asterisk will appear next to the 'Axle Ratio' option to signify that your changes have been saved. If your Mustang is equipped with non-stock tires, choose the 'Tire Revs per Mile' option and press select; otherwise, continue to step 193.

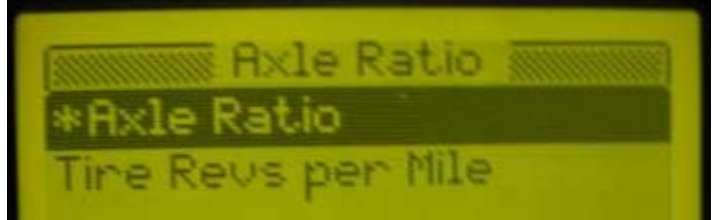

194. You will need to check your tire manufacturer's website to determine the tire revs per mile for your tires. The stock tires get 771 revs per mile.

195. Use the directional buttons to select the number closest to the tire revs per mile figure provided by your tire manufacturer. Press select again to confirm your selection.

196. Press escape twice to return to the Performance Tune menu. Choose 'Install Tune' and press select.

197. Confirm your choice by pressing select.

198. Follow the on-screen prompts regarding key position until you receive notification the tune installation is complete.

199. When the download is complete you will be prompted to disconnect the DiabloSport Performance Tuner from the OBD-II port of your vehicle.

200. If you have access to a diagnostic scan tool, run a 'Key On, Engine Off' test to verify that all connectors are properly installed, otherwise move on to the next step.

201. Start the car and verify a smooth idle. If you are using a diagnostic scan tool, run a 'Key On, Engine Run' test.

Free Manuals Download Website

<http://myh66.com>

<http://usermanuals.us>

<http://www.somanuals.com>

<http://www.4manuals.cc>

<http://www.manual-lib.com>

<http://www.404manual.com>

<http://www.luxmanual.com>

<http://aubethermostatmanual.com>

Golf course search by state

<http://golfingnear.com>

Email search by domain

<http://emailbydomain.com>

Auto manuals search

<http://auto.somanuals.com>

TV manuals search

<http://tv.somanuals.com>