



# Broadband Router

## Broadband Router

## User's Manual



<b>Introduction</b> .....	3
Features.....	4
Minimum Requirements .....	4
Package Content.....	4
Note.....	4
Get to know the Broadband Router.....	4
Back Panel.....	5
Front Panel .....	5
Setup Diagram .....	6
Getting started .....	7
<b>Chapter 1</b> .....	16
Quick Setup.....	16
Step 1) Time Zone.....	16
Step 2) Broadband Type.....	17
1.1 Cable Modem .....	18
1.2 Fixed-IP xDSL.....	19
1.3 PPPoE .....	20
1.4 PPTP .....	23
<b>Chapter 2</b> .....	26
General Settings .....	26
2.1 System.....	28
2.1.1 Time Zone.....	29
2.1.2 Password Settings.....	30
2.1.3 Remote Management.....	31
2.2 WAN .....	33
2.2.1 Dynamic IP .....	34
2.2.2 Static IP Address .....	34
2.2.3 PPPoE (PPP over Ethernet) .....	34
2.2.4 PPTP .....	34
2.2.5 L2TP .....	34
2.2.6 Telstra Big Pond .....	36
2.2.7 DNS .....	37
2.2.8 DDNS.....	38
2.3 LAN .....	39
2.4 NAT .....	41
2.4.1 Port Forwarding .....	43
2.4.2 Virtual Server .....	45
2.4.3 Special Applications.....	49
2.4.4 ALG Settings .....	52
2.5 Firewall .....	53
2.5.1 Access Control.....	54
2.5.2 URL Blocking .....	59
2.5.3 Denial of Service (DoS) .....	61
2.5.4 DMZ.....	62
<b>Chapter 3</b> .....	64

<b>Status</b> .....	<b>64</b>
<b>3.1 Status and Information</b> .....	<b>65</b>
<b>3.2 Internet Connection</b> .....	<b>66</b>
<b>3.3 Device Status</b> .....	<b>67</b>
<b>3.4 Security Log</b> .....	<b>68</b>
<b>3.5 Active DHCP Client Table</b> .....	<b>69</b>
<b>3.6 Statistics</b> .....	<b>70</b>
<b>Chapter 4</b> .....	<b>71</b>
<b>Tool</b> .....	<b>71</b>
<b>4.1 Configuration Tools</b> .....	<b>72</b>
<b>4.2 Firmware Upgrade</b> .....	<b>73</b>
<b>4.3 Reset</b> .....	<b>74</b>
<b>Appendix A</b> .....	<b>75</b>
<b>Glossary</b> .....	<b>76</b>

## Introduction

---

Congratulations on purchasing this Broadband Router. This Broadband Router is a cost-effective IP Sharing Router that enables multiple users to share the Internet through an ADSL or cable modem. Simply configure your Internet connection settings in the Broadband Router and plug your PC to the LAN port and you're ready to share files and access the Internet. As your network grows, you can connect another hub or switch to the router's LAN ports, allowing you to easily expand your network. The Broadband Router provides a total solution for the Small and Medium-sized Business (SMB) and the Small Office/Home Office (SOHO) markets, giving you an instant network today, and the flexibility to handle tomorrow's expansion and speed.

## Features

- High Internet Access throughput
- Allow multiple users to share a single Internet line
- Supports up to 253 users
- Internet Access via Cable or xDSL modem
- Access Private LAN Servers from the Public Network
- Equipped with four LAN ports (10/100M) and one WAN port (10/100M)
- Support DHCP (Server/Client) for easy setup
- Support advance features such as: Special Applications, DMZ, Virtual Servers, Access Control, Firewall.
- Allow you to monitor the router's status such as: DHCP Client Log, Security Log and Device/Connection Status
- Easy to use Web-based GUI for configuration and management purposes
- Remote Management allows configuration and upgrades from a remote site (over the Internet)

## Minimum Requirements

- One External xDSL (ADSL) or Cable modem with an Ethernet port (RJ-45)
- Network Interface Card (NIC) for each Personal Computer (PC)
- PCs with a Web-Browser (Internet Explorer 4.0 or higher, or Netscape Navigator 4.7 or higher)

## Package Content

- One 4-port Broadband router unit
- One Quick Installation Guide
- One User Manual CD
- One Power Adapter
- Accessories

## Note

The WAN "idle timeout" auto-disconnect function may not work due to abnormal activities of some network application software, computer virus or hacker attacks from the Internet. For example, some software sends network packets to the Internet in the background, even when you are not using the Internet. So please turn off your computer when you are not using it. This function also may not work with some ISP. So please make sure this function can work properly when you use this function in the first time, especially when your ISP charge you by time used.

## Get to know the Broadband Router

---

## Back Panel

The diagram (fig1.0) below shows the broadband router's back panel. The router's back panel is divided into three sections, **LAN**, **WAN** and **Reset**:

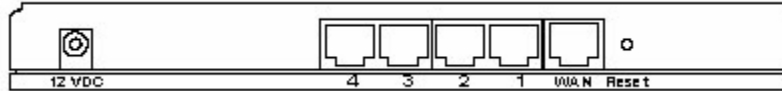

Figure 1.0

### 1) Local Area Network (LAN)

The Broadband router's 4 LAN ports are where you connect your LAN's PCs, printer servers, hubs and switches etc.

### 2) Wide Area Network (WAN)

The WAN port is the segment connected to your xDSL or Cable modem and is linked to the Internet.

### 3) Reset

The Reset button allows you to do one of two things.

- 1) If problems occur with your router, press the router's reset button with a pencil tip (for less than 4 seconds) and the router will re-boot itself, keeping your original configurations.
- 2) If problems persist or you experience extreme problems or you forgot your password, press the reset button for longer than 4 seconds and the router will reset itself to the factory default settings (**warning**: your original configurations will be replaced with the factory default settings)

## Front Panel

---

On the router's front panel there are LED lights that inform you of the router's current status. Below is an explanation of each LED and its description.



LED	Light Status	Description
PWR	ON	Router's power supply is on
WAN 10/100M	ON	WAN port 100Mbps is connected
	Off	WAN port 10Mbps is connected
WAN LNK/ACT	ON	WAN is connected
	Off	No WAN connection
	Flashing	WAN port has Activity (ACT), data being sent
LAN 10/100M (Port 1-4)	ON	LAN port 100Mbps is connected
	Off	LAN port 10Mbps is connected
LAN LNK/ACT (Port 1-4)	ON	LAN is connected
	Off	No LAN connection
	Flashing	LAN port has Activity (ACT), data being sent

## Setup Diagram

Figure 1.2 below shows a typical setup for a Local Area Network (LAN).

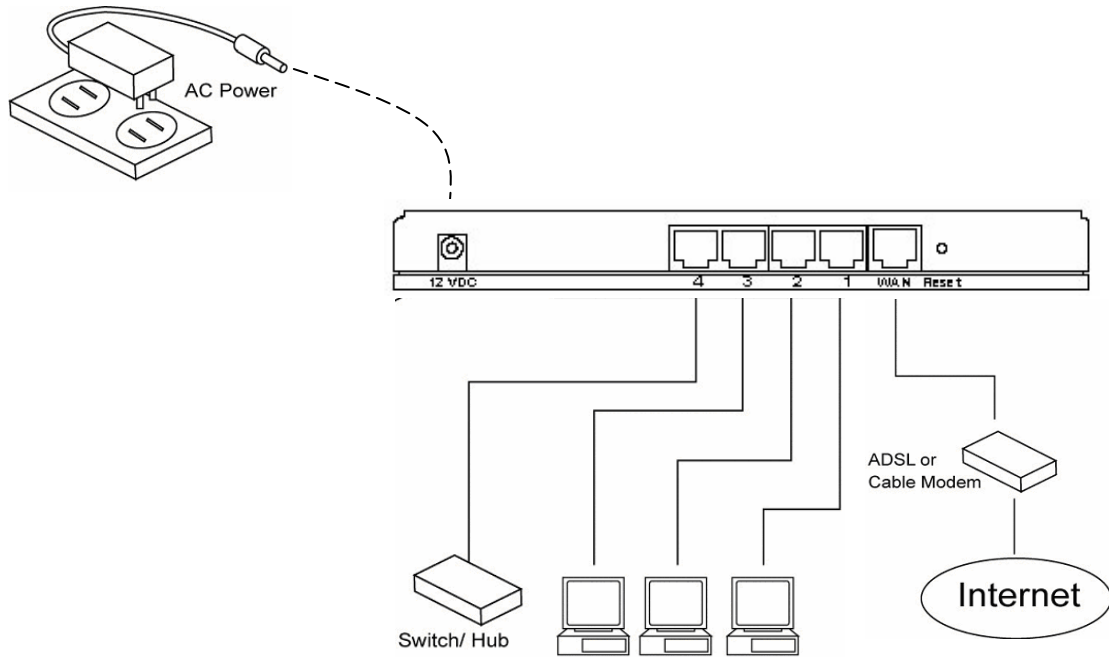

Figure 1.2

## Getting started

---

This is a step-by-step instruction on how to start using the router and get connected to the Internet.

- 1) Setup your network as shown in the setup diagram above (fig 1.2).
- 2) You then need to set your LAN PC clients so that it can obtain an IP address automatically. All LAN clients require an IP address. Just like an address, it allows LAN clients to find one another. (If you have already configured your PC to obtain an IP automatically then proceed to step 3, page 11)

### **Configure your PC to obtain an IP address automatically**

By default the broadband router's DHCP is on, this means that you can obtain an IP address automatically once you've configured your PC to obtain an IP address automatically. This section will show you how to configure your PC's so that it can obtain an IP address automatically for either Windows 95/98/Me, 2000 or NT operating systems. For other operating systems (Macintosh, Sun, etc.), follow the manufacturer's instructions. The following is a step-by-step illustration on how to configure your PC to obtain an IP address automatically for 2a) **Windows 95/98/Me**, 2b) **Windows XP**, 2c) **Windows 2000** and 2d) **Windows NT**.

#### **2a) Windows 95/98/Me**

- 1: Click the *Start* button and select *Settings*, then click *Control Panel*. The *Control Panel* window will appear.
- 2: Double-click *Network* icon. The *Network* window will appear.
- 3: Check your list of Network Components. If TCP/IP is not installed, click the *Add* button to install it now. If TCP/IP is installed, go to **step 6**.
- 4: In the *Network Component Type* dialog box, select *Protocol* and click *Add* button.
- 5: In the *Select Network Protocol* dialog box, select *Microsoft* and *TCP/IP* and then click the *OK* button to start installing the TCP/IP protocol. You may need your Windows CD to complete the installation.
- 6: After installing TCP/IP, go back to the *Network* dialog box. Select *TCP/IP* from the list of *Network Components* and then click the *Properties* button.
- 7: Check each of the tabs and verify the following settings:
  - **Bindings:** Check *Client for Microsoft Networks* and *File and printer sharing for Microsoft Networks*.
  - **Gateway:** All fields are blank.
  - **DNS Configuration:** Select *Disable DNS*.
  - **WINS Configuration:** Select *Disable WINS Resolution*.
  - **IP Address:** Select *Obtain IP address automatically*.



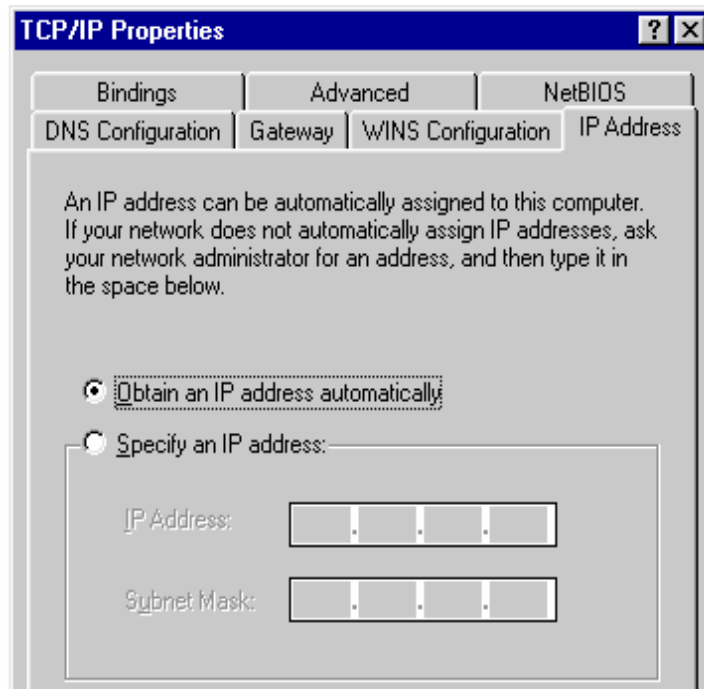

8: Reboot the PC. Your PC will now obtain an IP address automatically from your Broadband Router's DHCP server.

**Note:** Please make sure that the Broadband router's DHCP server is the only DHCP server available on your LAN.

Once you've configured your PC to obtain an IP address automatically, please proceed to Step 3

## 2b) Windows XP

- 1: Click the *Start* button and select *Settings*, then click *Network Connections*. The *Network Connections* window will appear.
- 2: Double-click *Local Area Connection* icon. The *Local Area Connection* window will appear.
- 3: Check your list of Network Components. You should see *Internet Protocol [TCP/IP]* on your list. Select it and click the *Properties* button.
- 4: In the Internet Protocol (TCP/IP) Properties window, select *Obtain an IP address automatically* and *Obtain DNS server address automatically* as shown on the following screen.

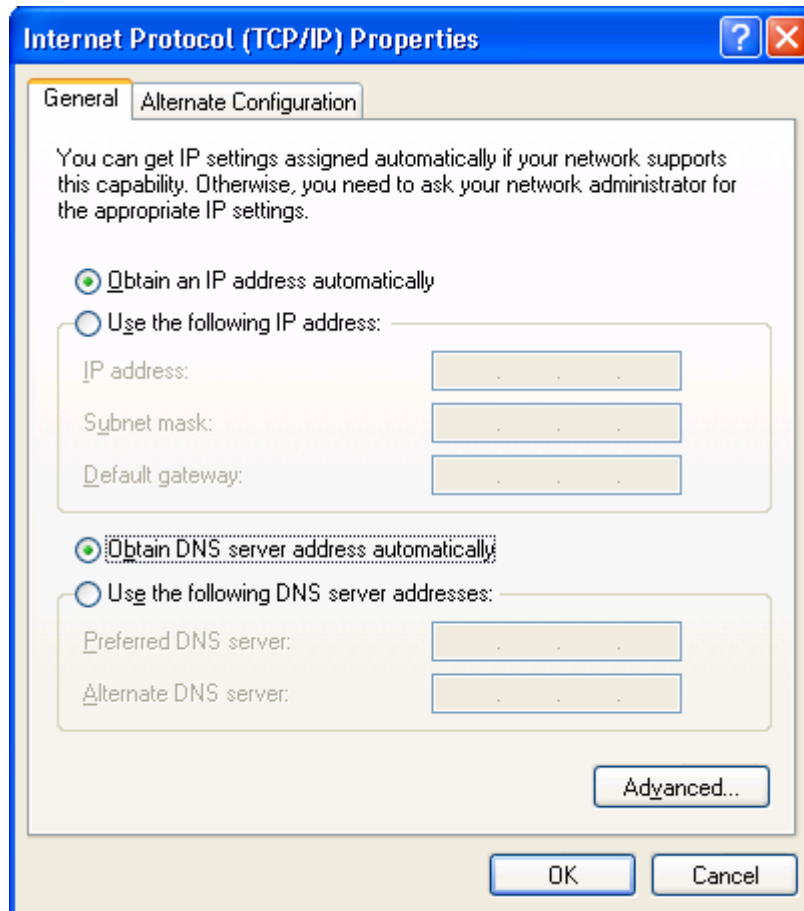

5: Click *OK* to confirm the setting. Your PC will now obtain an IP address automatically from your Broadband Router's DHCP server.

**Note:** Please make sure that the Broadband router's DHCP server is the only DHCP server available on your LAN.

Once you've configured your PC to obtain an IP address automatically, please proceed to Step 3.

## 2c) Windows 2000

1: Click the *Start* button and select *Settings*, then click *Control Panel*. The *Control Panel* window will appear.

2: Double-click *Network and Dial-up Connections* icon. In the *Network and Dial-up Connection* window, double-click *Local Area Connection* icon. The *Local Area Connection* window will appear.

3: In the *Local Area Connection* window, click the *Properties* button.

4: Check your list of Network Components. You should see *Internet Protocol [TCP/IP]* on your list. Select it and click the *Properties* button.

5: In the Internet Protocol (TCP/IP) Properties window, select *Obtain an IP address*

automatically and Obtain DNS server address automatically as shown on the following screen.

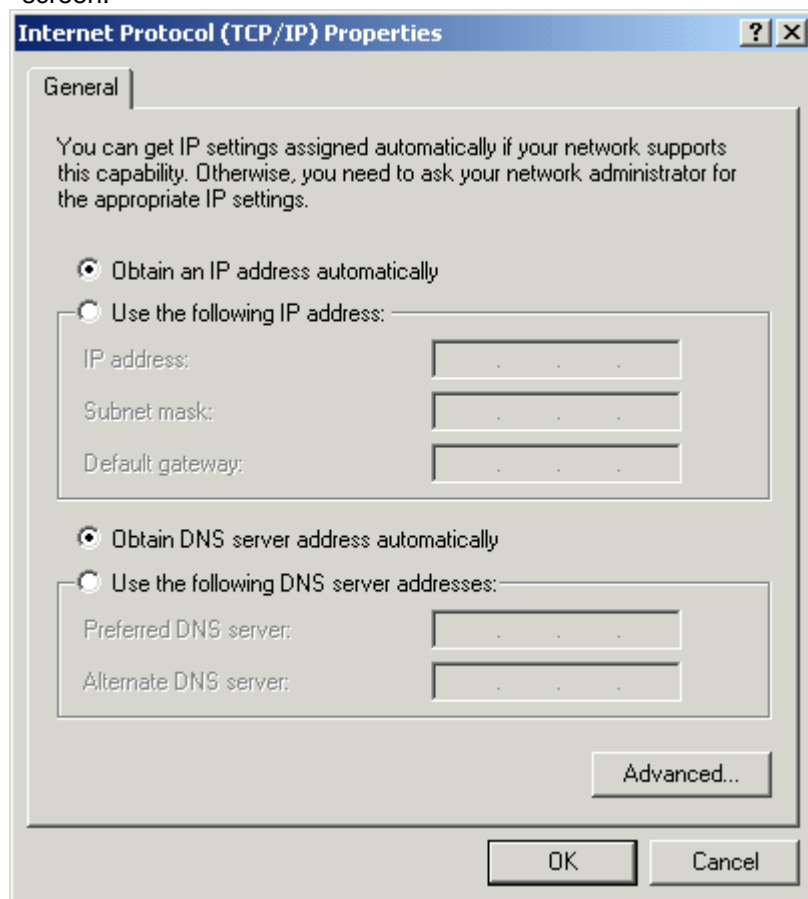

6: Click *OK* to confirm the setting. Your PC will now obtain an IP address automatically from your Broadband Router's DHCP server.

**Note:** Please make sure that the Broadband router's DHCP server is the only DHCP server available on your LAN.

Once you've configured your PC to obtain an IP address automatically, please proceed to Step 3.

## 2d) Windows NT

1: Click the *Start* button and select *Settings*, then click *Control Panel*. The *Control Panel* window will appear.

2: Double-click *Network* icon. The *Network* window will appear. Select the *Protocol* tab from the *Network* window.

3: Check if the *TCP/IP Protocol* is on your list of *Network Protocols*. If TCP/IP is not installed, click the *Add* button to install it now. If TCP/IP is installed, go to **step 5**.

4: In the *Select Network Protocol* window, select the *TCP/IP Protocol* and click the *Ok*

button to start installing the TCP/IP protocol. You may need your Windows CD to complete the installation.

5: After you install TCP/IP, go back to the *Network* window. Select *TCP/IP* from the list of *Network Protocols* and then click the *Properties* button.

6: Check each of the tabs and verify the following settings:

- **IP Address:** Select *Obtain an IP address from a DHCP server*.
- **DNS:** Let all fields be blank.
- **WINS:** Let all fields be blank.
- **Routing:** Let all fields be blank.

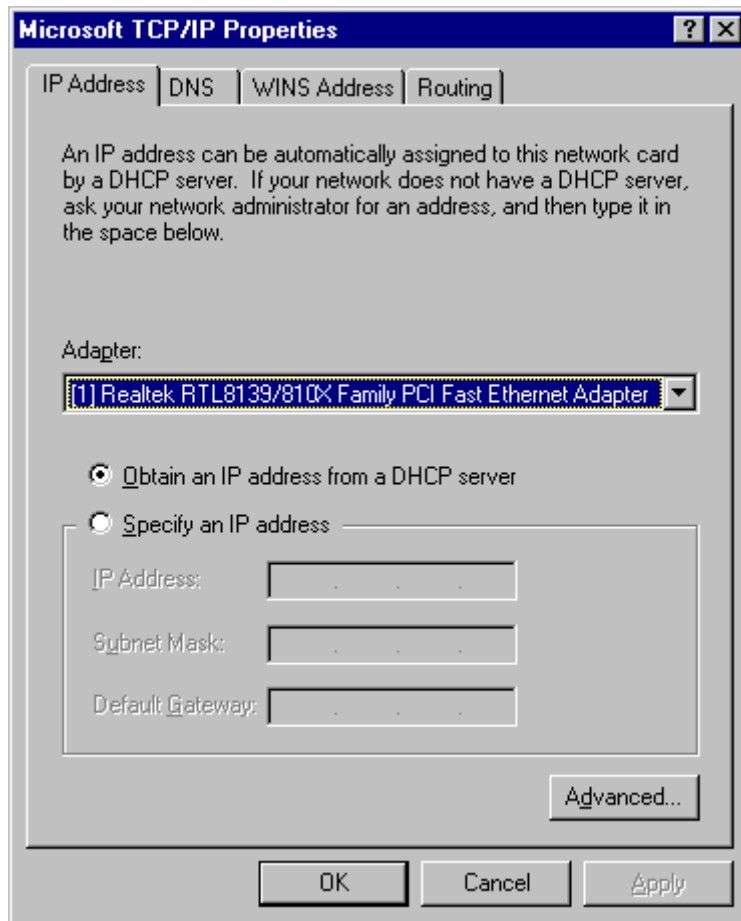

7: Click *OK* to confirm the setting. Your PC will now obtain an IP address automatically from your Broadband Router's DHCP server.

**Note:** Please make sure that the Broadband router's DHCP server is the only DHCP server available on your LAN.

Once you've configured your PC to obtain an IP address automatically, please proceed to Step 3.

- 3) Once you have configured your PCs to obtain an IP address automatically, the router's DHCP server will automatically give your LAN clients an IP address. By default the Broadband Router's DHCP server is enabled so that you can obtain an IP address automatically. To see if you have obtained an IP address, see Appendix A.

**Note:** Please make sure that the Broadband router's DHCP server is the only DHCP server available on your LAN. If there is another DHCP on your network, then you'll need to switch one of the DHCP servers off. (To disable the Broadband router's DHCP server see chapter 2 LAN Port)

- 4) Once your PC has obtained an IP address from your router, enter the default IP address **192.168.2.1** (broadband router's IP address) into your PC's web browser and press <enter>



- 5) The login screen below will appear. Enter the "User Name" and "Password" and then click <OK> to login.

**Note:** By default the user name is "admin" and the password is "1234". For security reasons it is recommended that you change the password as soon as possible (in General setup/system/password, see chapter 2)

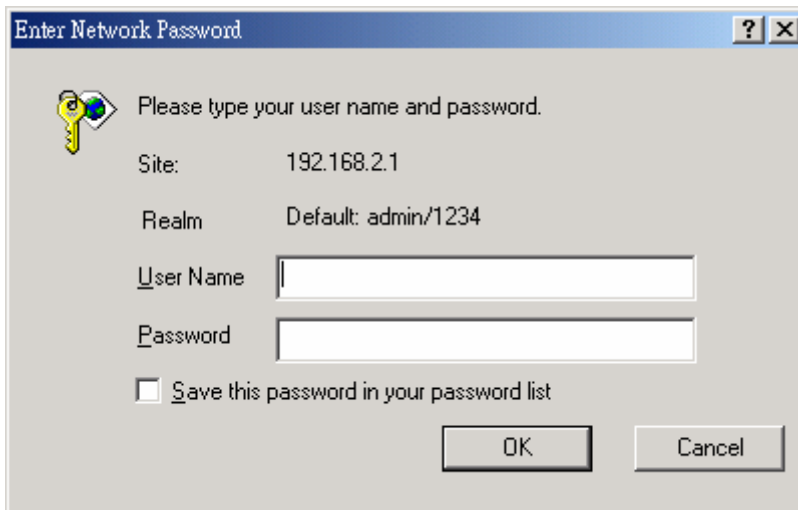

- 6) The **HOME** page screen below will appear. The **Home** Page is divided into four sections, **Quick Setup Wizard, General Setup, Status Information** and **Tools**.

#### **Quick Setup Wizard** (*Chapter 1*)

If you only want to start using the broadband router as an Internet Access device then you **ONLY** need to configure the screens in the Quick Setup Wizard section.

#### **General Setup** (*Chapter 2*)

If you want to use more advanced features that the broadband router has to offer, then you'll need to configure the Quick Setup Wizard and the General Setup section. Alternatively, you

can just configure the General Setup section, since the General Setup/WAN and the Quick Setup Wizard contain the same configurations.

**Status Information** (*Chapter 3*)

The Status Information section is for you to monitor the router's current status information only.

**Tools** (*Chapter 4*)

If you want to Reset the router (because of problems) or save your configurations or upgrade the firmware then the Tools section is the place to do this.

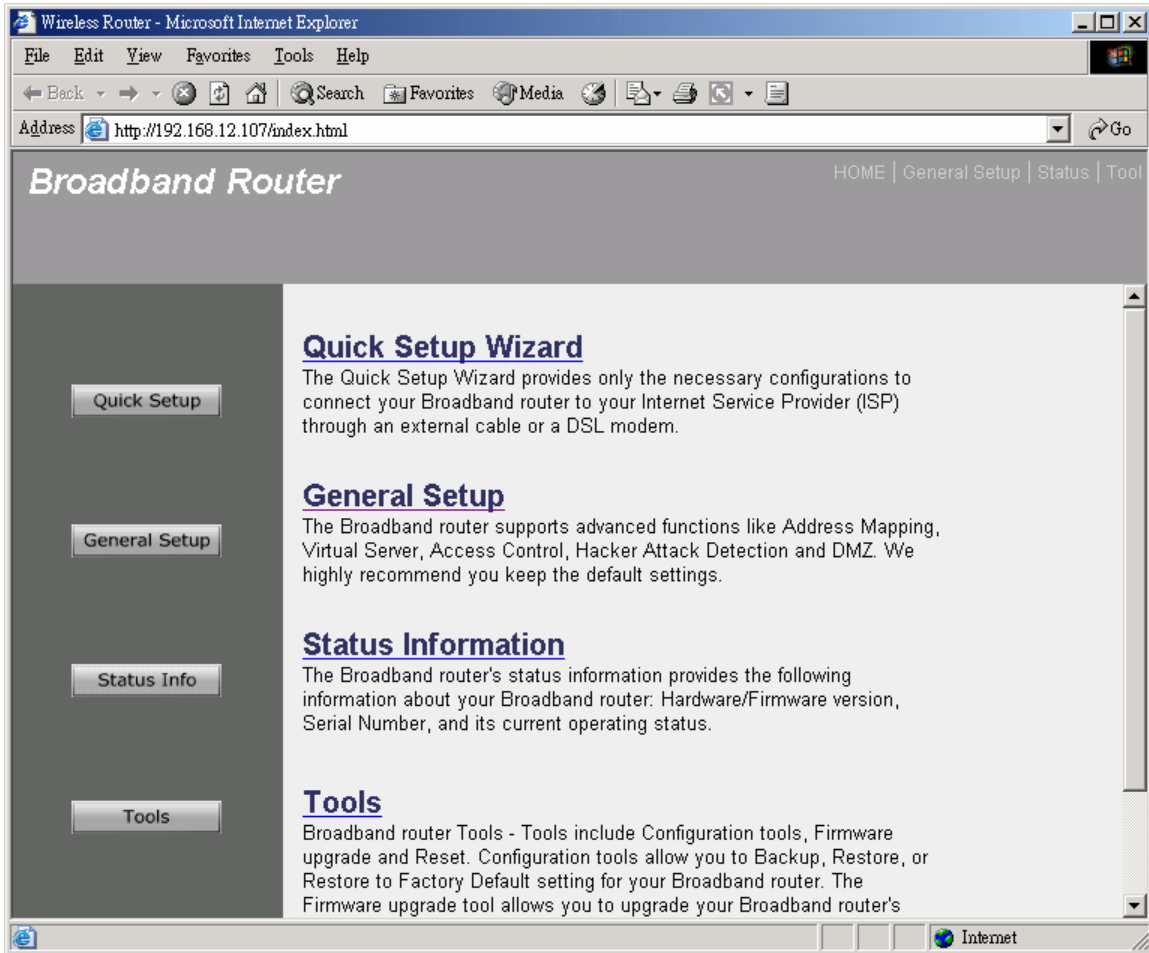

Menu	Description
<b>Quick Setup Wizard</b> ( <i>Chapter 1</i> )	Select your Internet connection type and then input the configurations needed to connect to your Internet Service Provider (ISP).
<b>General Setup</b> ( <i>Chapter 2</i> )	This section contains configurations for the Broadband router's advance functions such as: Address Mapping, Virtual Server, Access

Control, Hacker Attack Prevention, DMZ, Special applications and other functions to meet your LAN requirements.

### **Status Information** (*Chapter 3*)

In this section you can see the Broadband router's system information, Internet Connection, Device Status, Security Log and DHCP client Log information.

### **Tools** (*Chapter 4*)

This section contains the broadband router's Tools - Tools include Configuration tools, Firmware upgrade and Reset. Configuration tools allow you to Backup (save), Restore, or Restore to Factory Default configuration for your Broadband router. The Firmware upgrade tool allows you to upgrade your Broadband router's firmware. The RESET tool allows you to reset your Broadband router.

- 
- 7) Click on **Quick Setup Wizard** (see chapter 1) to start configuring settings required by your ISP so that you can start accessing the Internet. The other sections (General Setup, Status Information and Tools) do not need to be configured unless you wish to implement/monitor more advance features/information.

Select the section (Quick Setup Wizard, General Setup, Status Information and Tools) you wish to configure and proceed to the corresponding chapter. Use the selections on the web management's top right hand page to navigate around the web-based management User Interface.

# Chapter 1

## Quick Setup

The Quick Setup section is designed to get you using the broadband router as quick as possible. In the Quick Setup you are required to fill in only the information necessary to access the Internet. Once you click on the **Quick Setup Wizard** in the HOME page, you should see the screen below.

### Step 1) Time Zone

The Time Zone allows your router to base its time on the settings configured here, this will affect functions such as Log entries and Firewall settings.

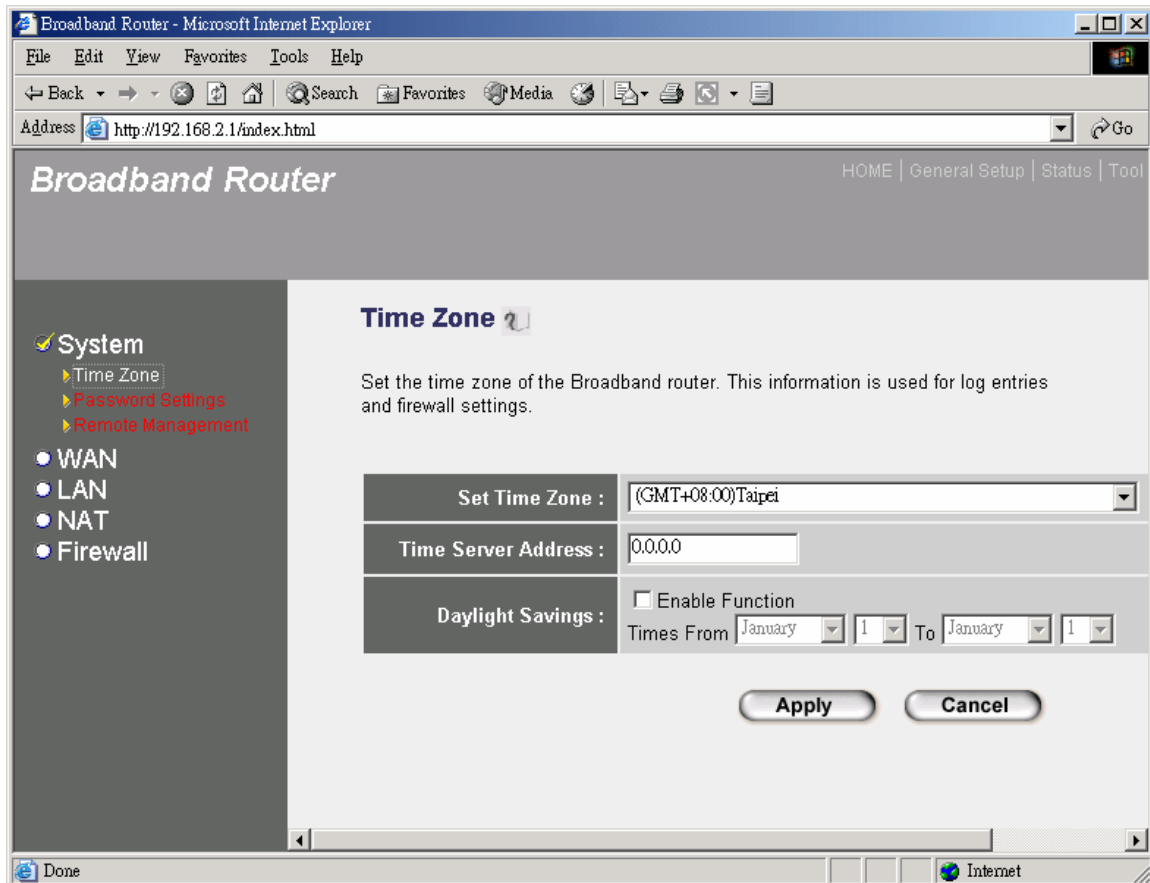

Parameter	Description
<b>Set Time Zone</b>	Select the time zone of the country you are currently in. The router will set its time based on your selection.
<b>Time Server Address</b>	You can manually assign time server address if the default time server dose not work.
<b>Enable Daylight Savings</b>	The router can also take Daylight savings into account. If you wish to use this function, you



must check/tick the enable box to enable your daylight saving configuration (below).

**Start Daylight Savings Time**

Select the period in which you wish to start daylight Savings Time

**End Daylight Savings Time**

Select the period in which you wish to end daylight Savings Time

---

Click on **NEXT** to proceed to the next page (step 2) Broadband Type.

**Step 2) Broadband Type**

In this section you have to select one of four types of connections that you will be using to connect your broadband router's WAN port to your ISP (see screen below).

**Note:** Different ISP's require different methods of connecting to the Internet, please check with your ISP as to the type of connection it requires.

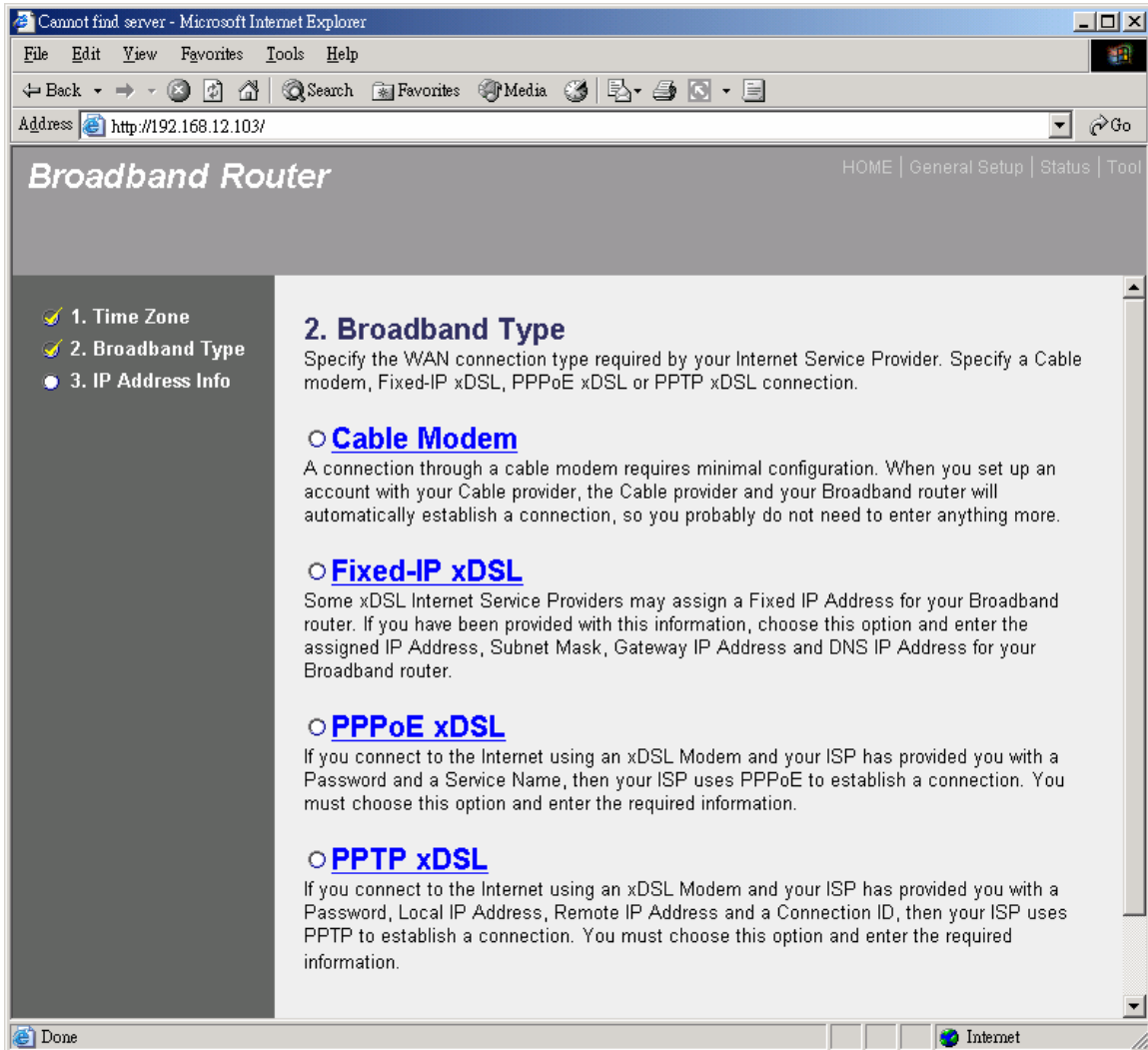

Menu	Description
<b>1.1 Cable Modem</b>	Your ISP will automatically give you an IP address
<b>1.2 Fixed-IP xDSL</b>	Your ISP has given you an IP address already
<b>1.3 PPPoE</b>	Your ISP requires you to use a Point-to-Point Protocol over Ethernet (PPPoE) connection.
<b>1.4 PPTP</b>	Your ISP requires you to use a Point-to-Point Tunneling Protocol (PPTP) connection.

Click on one of the WAN type and then proceed to the manual's relevant sub-section (**1.1**, **1.2**, **1.3** or **1.4**). Click on **Back** to return to the previous screen.

### 1.1 Cable Modem

Choose Cable Modem if your ISP will automatically give you an IP address. Some ISP's may also require that you fill in additional information such as Host Name and MAC address (see screen below).

**Note:** The Host Name and MAC address section is *optional* and you can skip this section if your ISP does not require these settings for you to connect to the Internet.

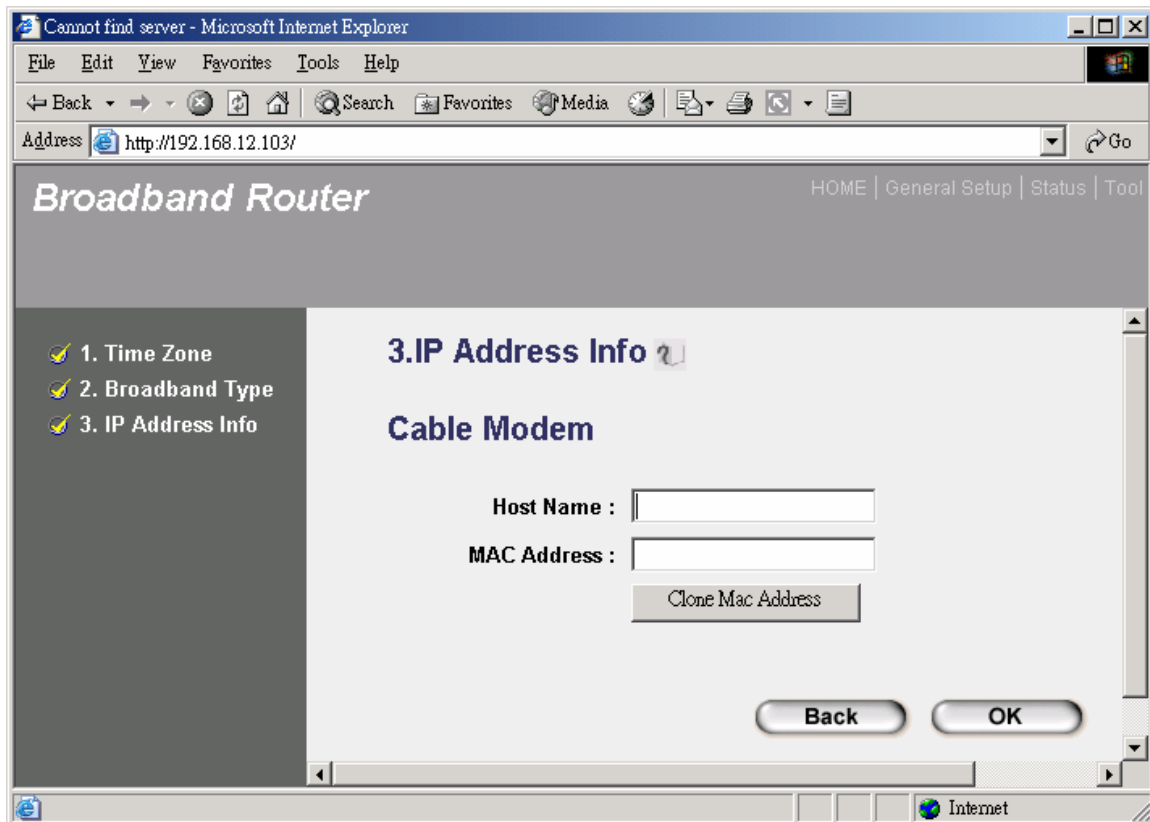

Parameters	Description
Host Name	If your ISP requires a Host Name, type in the host name provided by your ISP, otherwise leave it blank if your ISP does not require a Host Name.
MAC Address	Your ISP may require a particular MAC address in order for you to connect to the Internet. This MAC address is the PC's MAC address that your ISP had originally connected your Internet connection to. Type in this MAC address in this section or use the " <b>Clone MAC Address</b> " button to replace the WAN MAC address with the MAC address of that PC (you have to be using that PC for the Clone MAC Address button to work). To find out the PC's MAC address see Appendix A. (see Glossary for an explanation on MAC address)

Click <OK> when you have finished the configuration above. **Congratulations!** You have completed the configuration for the Cable Modem connection. You can start using the router now, if you wish to use some of the advance features supported by this router see chapter 2, 3, 4.

## 1.2 Fixed-IP xDSL

Select Fixed-IP xDSL if your ISP has given you a specific IP address for you to use. Your ISP should provide all the information required in this section.

---

Parameters	Description
IP	This is the IP address that your ISP has given you.
Gateway IP	This is the ISP's IP address gateway
DNS	This is the ISP's DNS server IP address
Subnet Mask	Enter the Subnet Mask provided by your ISP (e.g. 255.255.255.0)

---

Click <**OK**> when you have finished the configuration above. **Congratulations!** You have completed the configuration for the Fixed-IP x DSL connection. You can start using the router now, if you wish to use some of the advance features supported by this router see chapter 2, 3, 4.

### 1.3 PPPoE

Select PPPoE if your ISP requires the PPPoE protocol to connect you to the Internet. Your ISP should provide all the information required in this section.

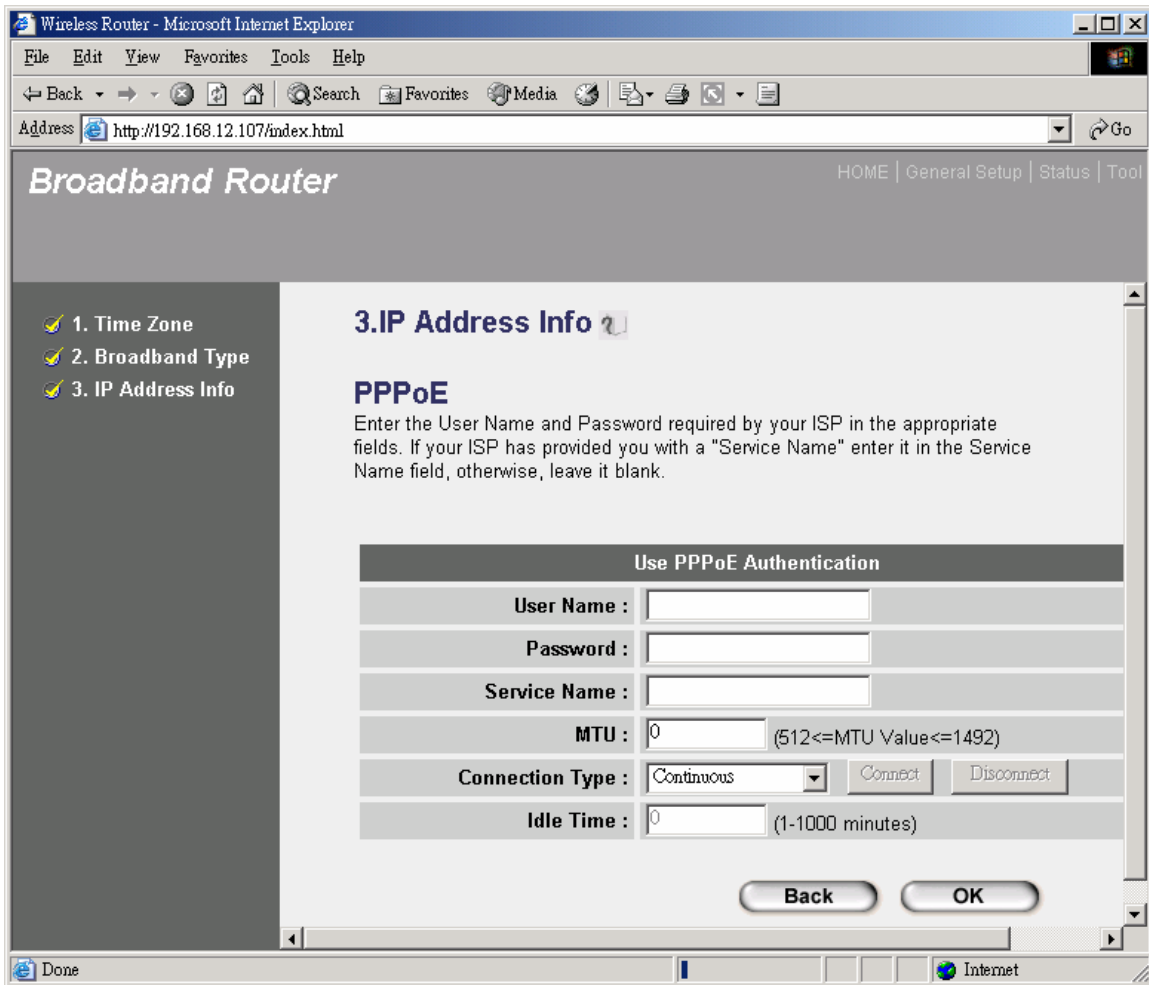

Parameter	Description
User Name	Enter the User Name provided by your ISP for the PPPoE connection
Password	Enter the Password provided by your ISP for the PPPoE connection
Service Name	This is optional. Enter the Service name should your ISP requires it, otherwise leave it blank.
MTU	This is optional. You can specify the maximum size of your transmission packet to the Internet. Leave it as it is if you to not wish to set a maximum packet size.
Connection Type	If you select "Continuous", the router will always connect to the ISP. If the WAN line breaks down and links again, the router will auto-reconnect to the ISP.

If you select “Connect On Demand”, the router will auto-connect to the ISP when someone want to use the Internet and keep connected until the WAN idle timeout. The router will close the WAN connection if the time period that no one is using the Internet exceeds the “Idle Time”.

If you select “Manual”, the router will connect to ISP only when you click “Connect” manually from the Web user interface. The WAN connection will not disconnected due to the idle timeout. If the WAN line breaks down and latter links again, the router will not auto-connect to the ISP.

### Idle Time

You can specify an idle time threshold (minutes) for the WAN port. This means if no packets have been sent (no one using the Internet) during this specified period, the router will automatically disconnect the connection with your ISP.

**Note:** This “idle timeout” function may not work due to abnormal activities of some network application software, computer virus or hacker attacks from the Internet. For example, some software sends network packets to the Internet in the background, even when you are not using the Internet. So please turn off your computer when you are not using it. This function also may not work with some ISP. So please make sure this function can work properly when you use this function in the first time, especially your ISP charge you by time used.

---

Click <OK> when you have finished the configuration above. **Congratulations!** You have completed the configuration for the PPPoE connection. You can start using the router now, if you wish to use some of the advance features supported by this router see chapter 2, 3, 4.

## 1.4 PPTP

Select PPTP if your ISP requires the PPTP protocol to connect you to the Internet. Your ISP should provide all the information required in this section.

The screenshot shows the configuration interface for a wireless router. The browser window is titled "Wireless Router - Microsoft Internet Explorer" and the address bar shows "http://192.168.12.107/index.html". The page content includes a navigation menu with "HOME", "General Setup", "Status", and "Tool". The main content area is titled "Broadband Router" and contains a sidebar with three steps: "1. Time Zone", "2. Broadband Type", and "3. IP Address Info". The "3. IP Address Info" section is expanded, showing "PPTP" settings. Under "WAN Interface Settings", the "Use the following IP address" radio button is selected. The "IP Address" and "Subnet Mask" fields are both set to "0.0.0.0". Under "PPTP Settings", there are fields for "User ID", "Password", "PPTP Gateway" (0.0.0.0), "Connection ID" (Optional), "BEZEQ-ISRAEL" (checkbox), "Connection Type" (Continuous), and "Idle Time Out" (0 minutes). "Connect" and "Disconnect" buttons are next to the "Connection Type" dropdown. "Back" and "OK" buttons are at the bottom of the form.

Parameter	Description
Obtain an IP address by DHCP automatically	The ISP requires you to obtain an IP address before connecting to the PPTP server.
Use the following IP address connect to the	The ISP gives you a static IP to be used to PPTP server.

IP Address	This is the IP address that your ISP has given you to establish a PPTP connection.
Subnet Mask	Enter the Subnet Mask provided by your ISP (e.g. 255.255.255.0)
Gateway	Enter the IP address of the ISP Gateway
User ID	Enter the User Name provided by your ISP for the PPTP connection. Sometimes called a Connection ID
Password	Enter the Password provided by your ISP for the PPTP connection
PPTP Gateway	If your LAN has a PPTP gateway, then enter that PPTP gateway IP address here. If you do not have a PPTP gateway then enter the ISP's Gateway IP address above
Connection ID	This is the ID given by ISP. This is optional.
BEZEQ-ISRAEL	Select this item if you are using the service provided by BEZEQ in Israel.
Connection Type	<p>If you select "Continuous", the router will always connect to the ISP. If the WAN line breaks down and links again, the router will auto-reconnect to the ISP. If you select "Connect On Demand", the router will auto-connect to the ISP when someone want to use the Internet and keep connected until the WAN idle timeout. The router will close the WAN connection if the time period that no one is using the Internet exceeds the "Idle Time".</p> <p>If you select "Manual", the router will connect to ISP only when you click "Connect" manually from the Web user interface. The WAN connection will not disconnected due to the idle timeout. If the WAN line breaks down and latter links again, the router will not auto-connect to the ISP.</p>
Idle Time	<p>You can specify an idle time threshold (minutes) for the WAN port. This means if no packets have been sent (no one using the Internet) throughout this specified period, then the router will automatically disconnect the connection with your ISP.</p> <p><b>Note:</b> This "idle timeout" function may not work due to abnormal activities of some network application software, computer virus or hacker attacks from the Internet. For example, some software sends network packets to the Internet in the background, even when you are not using the Internet. So please turn off your computer when you are not using it. This function also may not</p>



work with some ISP. So please make sure this function can work properly when you use this function in the first time, especially your ISP charge you by time used.

---

Click <**OK**> when you have finished the configuration above. **Congratulations!** You have completed the configuration for the PPTP connection. You can start using the router now, if you wish to use some of the advance features supported by this router see chapter 2, 3, 4.

## Chapter 2

### General Settings

Once you click on the **General Setup** button at the Home Page, you should see the screen below.

If you have already configured the Quick Setup Wizard you do NOT need to configure anything thing in the General Setup screen for you to start using the Internet.

The General Setup contain advanced features that allow you to configure the router to meet your network's needs such as: Address Mapping, Virtual Server, Access Control, Hacker Attack Prevention, Special Applications, DMZ and other functions.

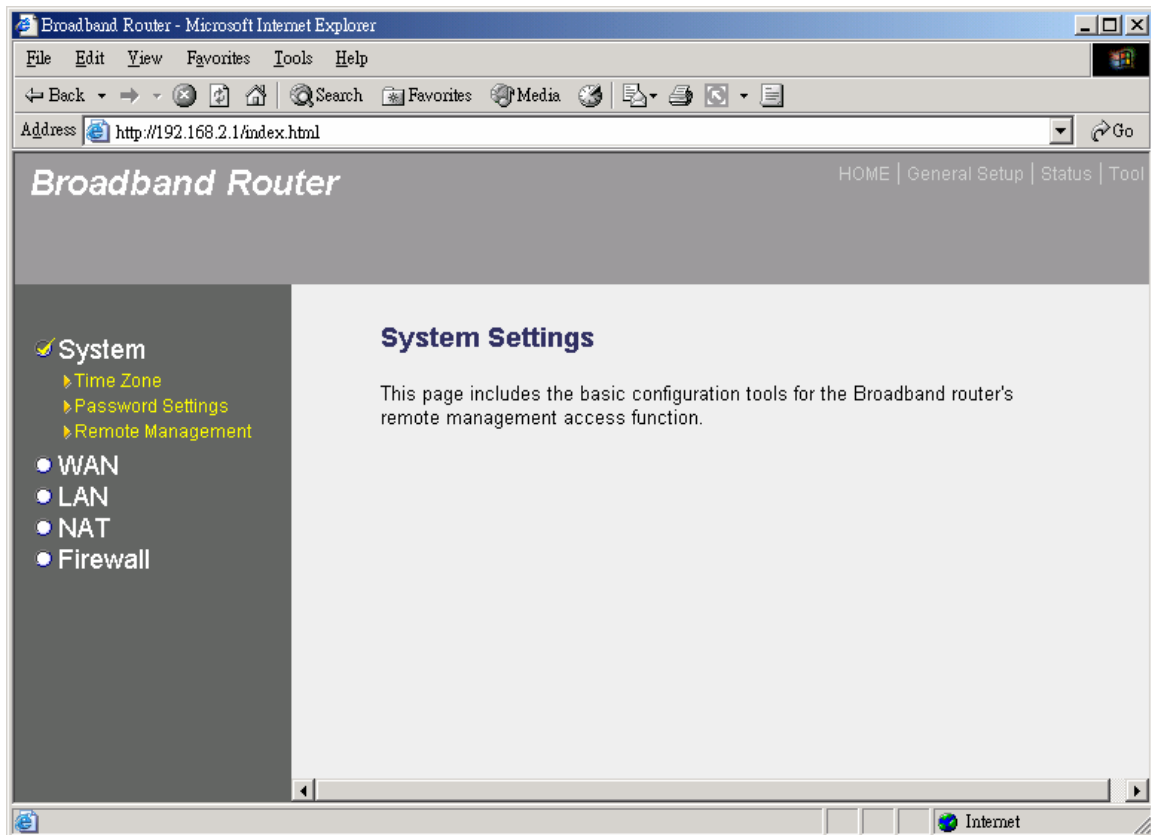

Below is a general description of what advance functions are available for this broadband router.

---

Menu	Description
2.1 System	This section allows you to set the Broadband router's system Time Zone, Password and Remote Management Administrator.
2.2 WAN	This section allows you to select the connection method in order to establish a connection with your ISP (same as the Quick Setup Wizard section)
2.3 LAN	You can specify the LAN segment's IP address, subnet Mask, enable/disable DHCP and select an IP range for your LAN
2.4 NAT	You can configure the Address Mapping, Virtual Server and Special Applications functions in this section. This allows you to specify what user/packet can pass your router's NAT.
2.5 Firewall	The Firewall section allows you to configure Access Control, Hacker Prevention and DMZ.

---

Select one of the above five General Setup selections and proceed to the manual's relevant sub-section

## 2.1 System

The system screen allows you to specify a time zone, to change the system password and to specify a remote management user for the broadband router.

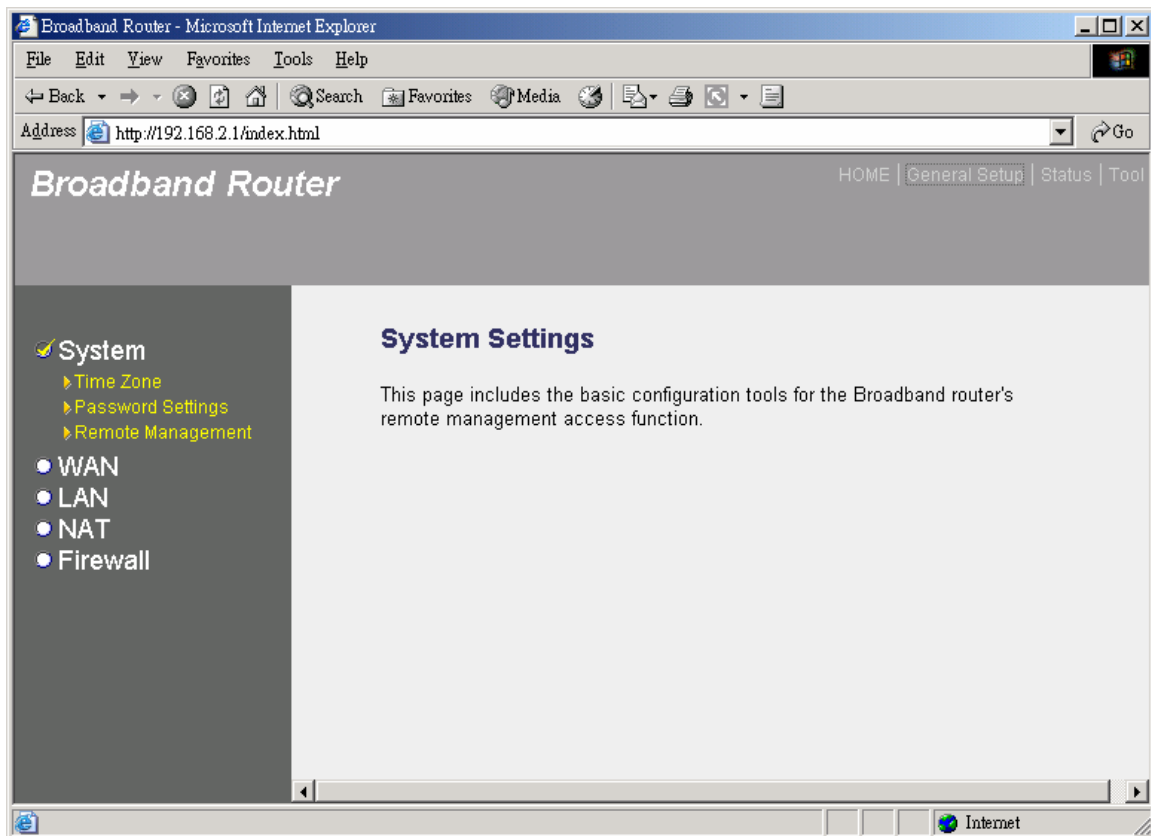

Parameters	Description
<i>System Settings</i>	
2.1.1 Time Zone	Select the time zone of the country you are currently in. The router will set its time based on your selection.
2.1.2 Password Settings	Allows you to select a password in order to access the web-based management website.
2.1.3 Remote Management	You can specify a Host IP address that can perform remote management functions.
Select one of the above three system settings selections and proceed to the manual's relevant sub-section	

## 2.1.1 Time Zone

The Time Zone allows your router to reference or base its time on the settings configured here, which will affect functions such as Log entries and Firewall settings.

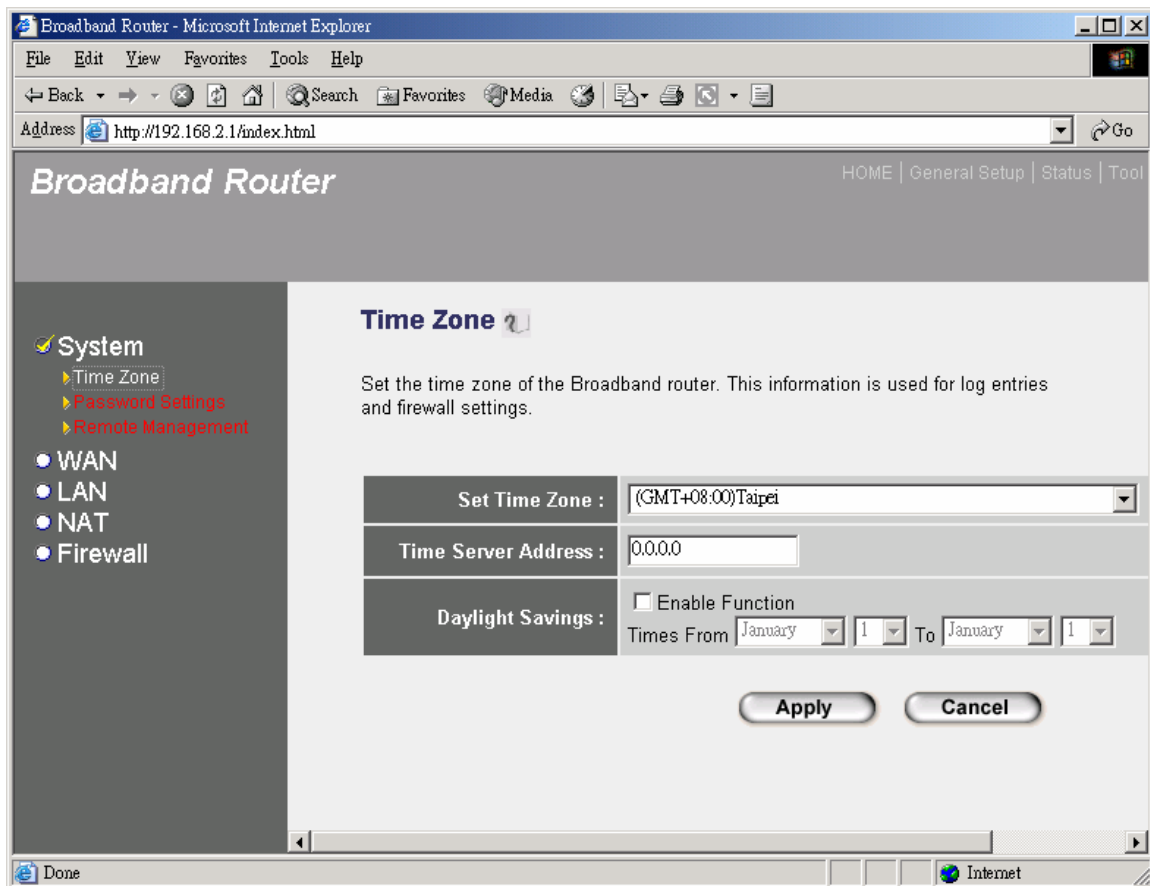

Parameter	Description
<b>Set Time Zone</b>	Select the time zone of the country you are currently in. The router will set its time based on your selection.
<b>Time Server Address</b>	You can manually assign time server address if the default time server dose not work.
<b>Enable Daylight Savings</b>	The router can also take Daylight savings into account. If you wish to use this function, you must check/tick the enable box to enable your daylight saving configuration (below).
<b>Start Daylight Savings Time</b>	Select the period in which you wish to start daylight Savings Time
<b>End Daylight Savings Time</b>	Select the period in which you wish to end daylight Savings Time

Click **<Apply>** at the bottom of the screen to save the above configurations. You can now configure other advance sections or start using the router (with the advance settings in place)

## 2.1.2 Password Settings

You can change the password required to log into the broadband router's system web-based management. By default, there is no password. So please assign a password to the Administrator as soon as possible, and store it in a safe place. Passwords can contain 0 to 30 alphanumeric characters, and are case sensitive.

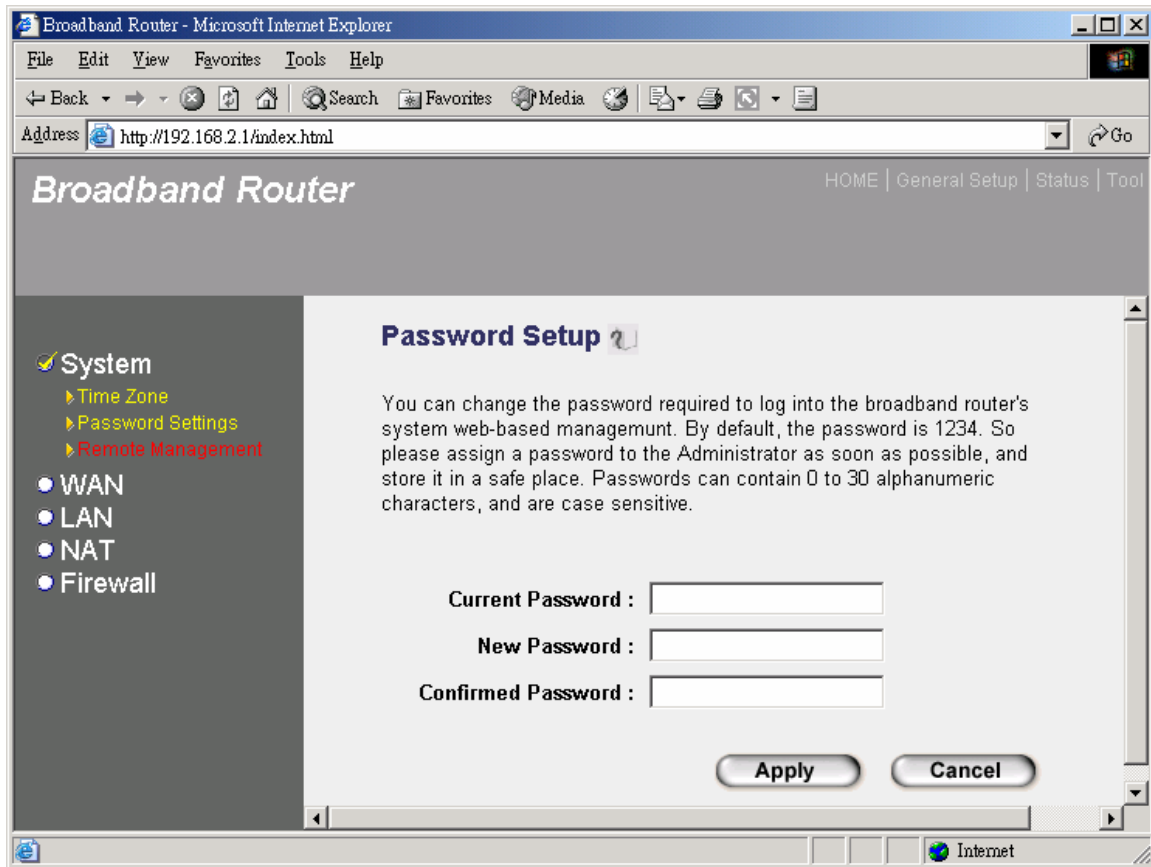

Parameters	Description
Current Password	Enter your current password for the remote management administrator to login to your Broadband router. Note: By default there is NO password
New Password	Enter your new password
Confirmed Password	Enter your new password again for verification purposes <b>Note:</b> If you forget your password, you'll have to reset the router to the factory default (No password) with the reset button (see router's back panel)

Click **<Apply>** at the bottom of the screen to save the above configurations. You can now configure other advance sections or start using the router (with the advance settings in place)

### 2.1.3 Remote Management

The remote management function allows you to designate a host in the Internet the ability to configure the Broadband router from a remote site. Enter the designated host IP Address in the Host IP Address field.

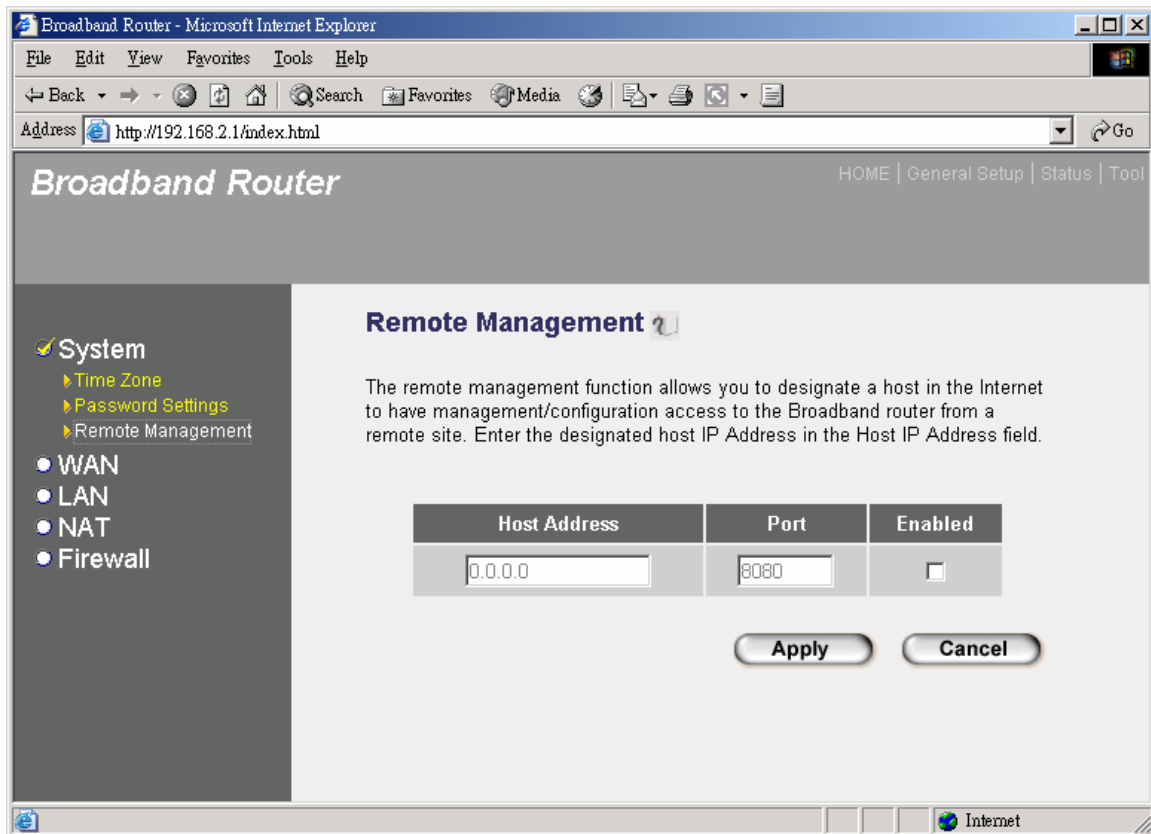

Parameters	Description
Host Address	<p>This is the IP address of the host in the Internet that will have management/configuration access to the Broadband router from a remote site. This means if you are at home and your home IP address has been designated the Remote Management host IP address for this router (located in your company office), then you are able to configure this router from your home. If the Host Address is left <b>0.0.0.0</b> this means anyone can access the router's web-based configuration from a remote location, providing they know the password.</p> <p>Click the <b>Enabled</b> box to enable the Remote Management function.</p> <p><b>Note:</b> When you want to access the web-based management from a remote site, you must enter the router's WAN IP address (e.g. 10.0.0.1) into your web-browser followed by port number 8080, e.g. 10.0.0.1:8080 (see below). You'll also need to know the password set in the Password Setting screen in order to access the router's web-based management.</p>

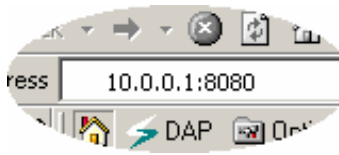

**Port**                      The port number of remote management web interface.

**Enabled**                 Select "Enabled" to enable the remote management function.

---

Click <**Apply**> at the bottom of the screen to save the above configurations. You can now configure other advance sections or start using the router (with the advance settings in place)



## 2.2 WAN

Use the WAN Settings screen if you have already configured the Quick Setup Wizard section and you would like to change your Internet connection type. The WAN Settings screen allows you to specify the type of WAN port connect you want to establish with your ISP. The WAN settings offer the following selections for the router's WAN port, **Dynamic IP**, **PPPoE**, **PPTP**, **Static IP Address**, **L2TP**, **Telstra Big Pond**, **DNS** and **DDNS**.

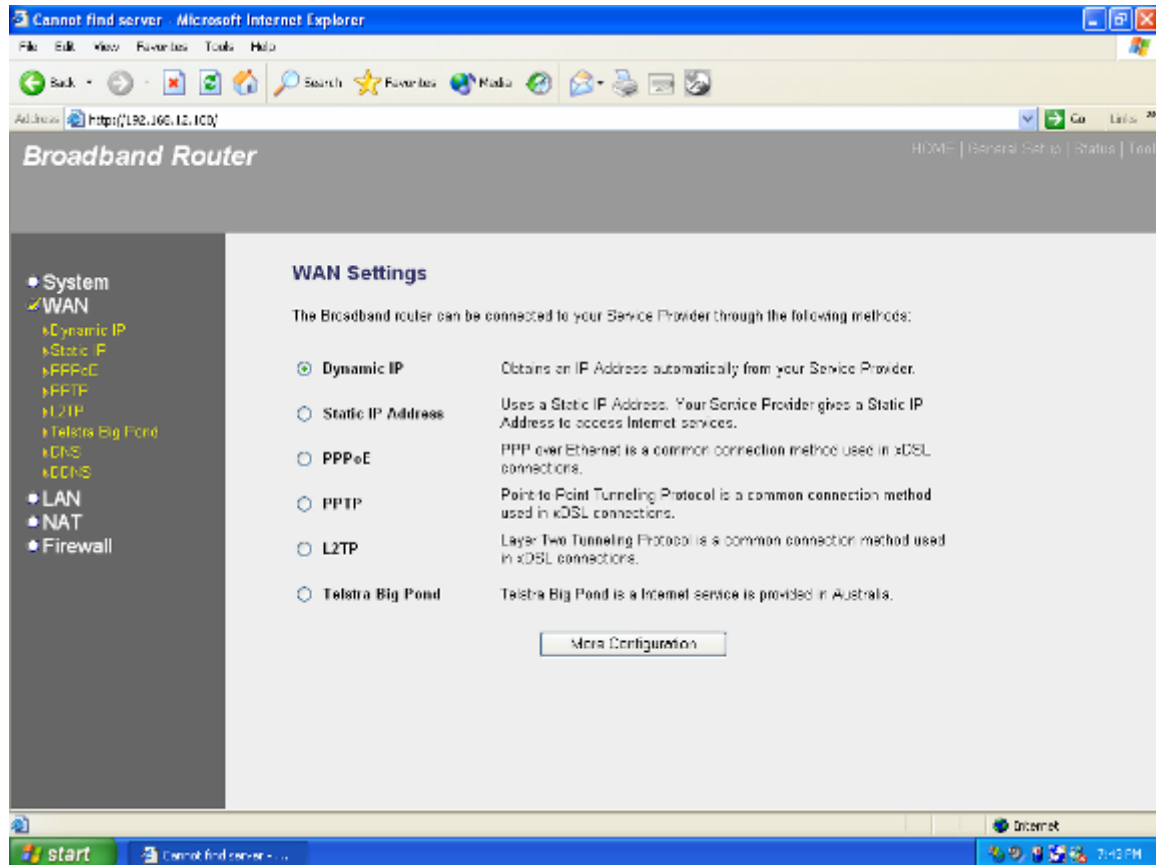

Parameters	Description
<b>2.2.1 Dynamic IP</b>	Your ISP will automatically give you an IP address
<b>2.2.2 Static IP address</b>	Your ISP has given you an IP address already
<b>2.2.3 PPPoE</b>	Your ISP requires PPPoE connection.
<b>2.2.4 PPTP</b>	Your ISP requires you to use a Point-to-Point Tunneling Protocol (PPTP) connection.
<b>2.2.5 L2TP</b>	Your ISP requires L2TP connection.
<b>2.2.6 Telstra Big Pond</b>	Your ISP requires Telstra Big Pond connection.
<b>2.2.7 DNS</b>	You can specify a DNS server that you wish to use

## 2.2.8 DDNS

You can specify a DDNS server that you wish to use and configure the user name and password provided by you DDNS service provider.

---

Once you have made a selection, click **<More Configuration>** at the bottom of the screen and proceed to the manual's relevant sub-section

## 2.2.1 Dynamic IP

Choose the Dynamic IP selection if your ISP will automatically give you an IP address. Some ISP's may also require that you fill in additional information such as Host Name, Domain Name and MAC address (see chapter 1 "Cable Modem" for more detail)

## 2.2.2 Static IP Address

Select Static IP address if your ISP has given you a specific IP address for you to use. Your ISP should provide all the information required in this section. (See chapter 1 "Fixed IP" for more detail)

## 2.2.3 PPPoE (PPP over Ethernet)

Select PPPoE if your ISP requires the PPPoE protocol to connect you to the Internet. Your ISP should provide all the information required in this section. (See chapter 1 "PPPoE" for more detail)

## 2.2.4 PPTP

Select PPTP if your ISP requires the PPTP protocol to connect you to the Internet. Your ISP should provide all the information required in this section. (See chapter 1 "PPTP" for more detail)

## 2.2.5 L2TP

Select L2TP if your ISP requires the L2TP protocol to connect you to the Internet. Your ISP should provide all the information required in this section.

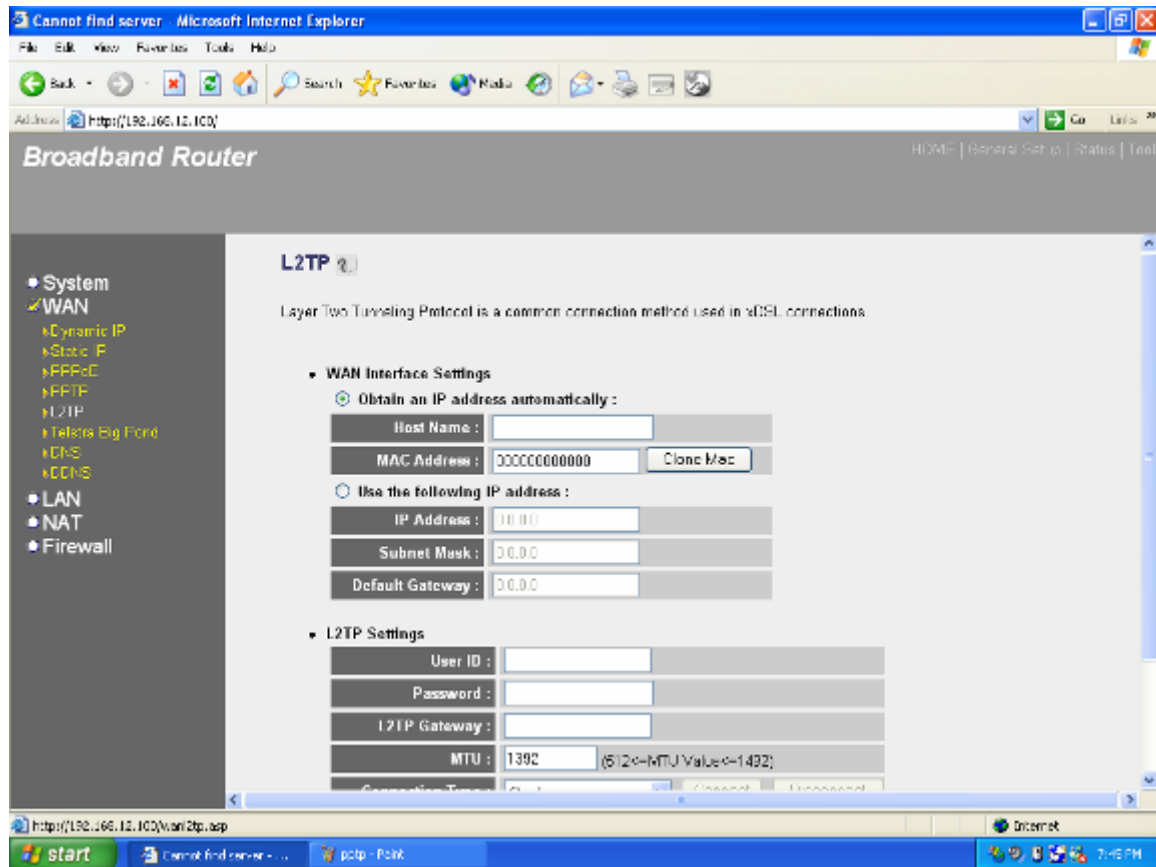

Parameter	Description
Obtain an IP address by DHCP automatically	The ISP requires you to obtain an IP address before connecting to the L2TP server.
Use the following IP address connect to the	The ISP give you a static IP to be used to L2TP server.
IP Address	This is the IP address that your ISP has given you to establish a L2TP connection.
Subnet Mask	Enter the Subnet Mask provided by your ISP (e.g. 255.255.255.0)
Gateway	Enter the IP address of the ISP Gateway.
User ID	Enter the User Name provided by your ISP for the PPTP connection. Sometimes called a Connection ID

Password	Enter the Password provided by your ISP for the PPTP connection
L2TP Gateway	If your LAN has a L2TP gateway, then enter that L2TP gateway IP address here. If you do not have a L2TP gateway then enter the ISP's Gateway IP address above
Connection Type	<p>If you select "Continuous", the router will always connect to the ISP. If the WAN line breaks down and links again, the router will auto-reconnect to the ISP. If you select "Connect On Demand", the router will auto-connect to the ISP when someone want to use the Internet and keep connected until the WAN idle timeout. The router will close the WAN connection if the time period that no one is using the Internet exceeds the "Idle Time".</p> <p>If you select "Manual", the router will connect to ISP only when you click "Connect" manually from the Web user interface. The WAN connection will not disconnected due to the idle timeout. If the WAN line breaks down and latter links again, the router will not auto-connect to the ISP.</p>
Idle Time Out	<p>You can specify an idle time threshold (minutes) for the WAN port. This means if no packets have been sent (no one using the Internet) throughout this specified period, then the router will automatically disconnect the connection with your ISP.</p> <p><b>Note:</b> This "idle timeout" function may not work due to abnormal activities of some network application software, computer virus or hacker attacks from the Internet. For example, some software sends network packets to the Internet in the background, even when you are not using the Internet. So please turn off your computer when you are not using it. This function also may not work with some ISP. So please make sure this function can work properly when you use this function in the first time, especially your ISP charge you by time used.</p>

---

Click <OK> when you have finished the configuration above. **Congratulations!** You have completed the configuration for the L2TP connection. You can start using the router now, if you wish to use some of the advance features supported by this router see chapter 2, 3, 4.

## 2.2.6 Telstra Big Pond

Select Telstra Big Pond if your ISP requires the Telstra Big Pond protocol to connect you to the Internet. Your ISP should provide all the information required in this section. Telstra Big Pond protocol is used by the ISP in Australia.

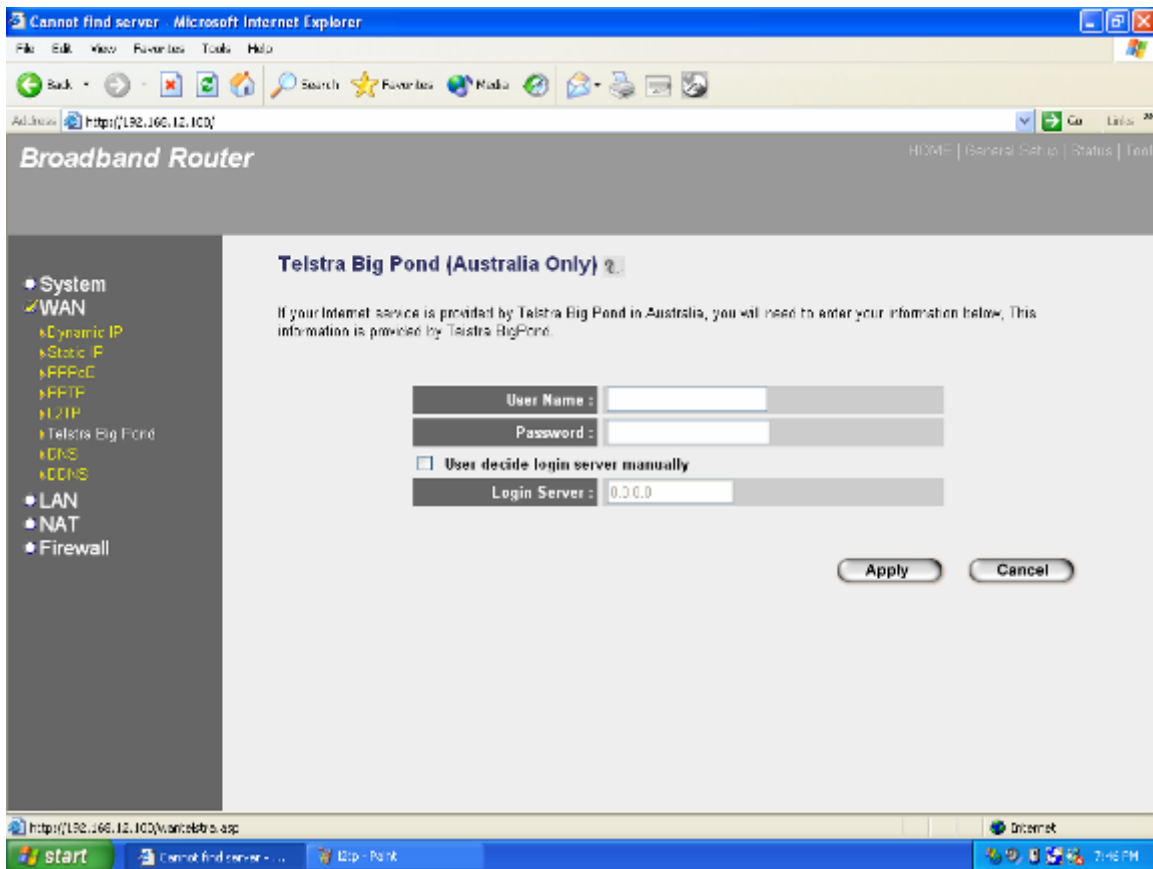

Parameter	Description
User Name	Enter the User Name provided by your ISP for the Telstra Big Pond connection
Password	Enter the Password provided by your ISP for the Telstra Big Pond connection
User decide login server manually	Select if you want to assign the IP of Telstra Big Pond's login server manually.
Login Server	The IP of the Login Server.

Click <OK> when you have finished the configuration above. **Congratulations!** You have completed the configuration for the Telstra Big Pond connection. You can start using the router now, if you wish to use some of the advance features supported by this router see chapter 2, 3, 4.

## 2.2.7 DNS

A Domain Name System (DNS) server is like an index of IP addresses and Web addresses. If you type a Web address into your browser, such as www.router.com, a DNS server will find that name in its index and the matching IP address. Most ISPs provide a DNS server for speed and

convenience. If your Service Provider connects you to the Internet with dynamic IP settings, it is likely that the DNS server IP address is provided automatically. However, if there is a DNS server that you would rather use, you need to specify the IP address of that DNS server here.

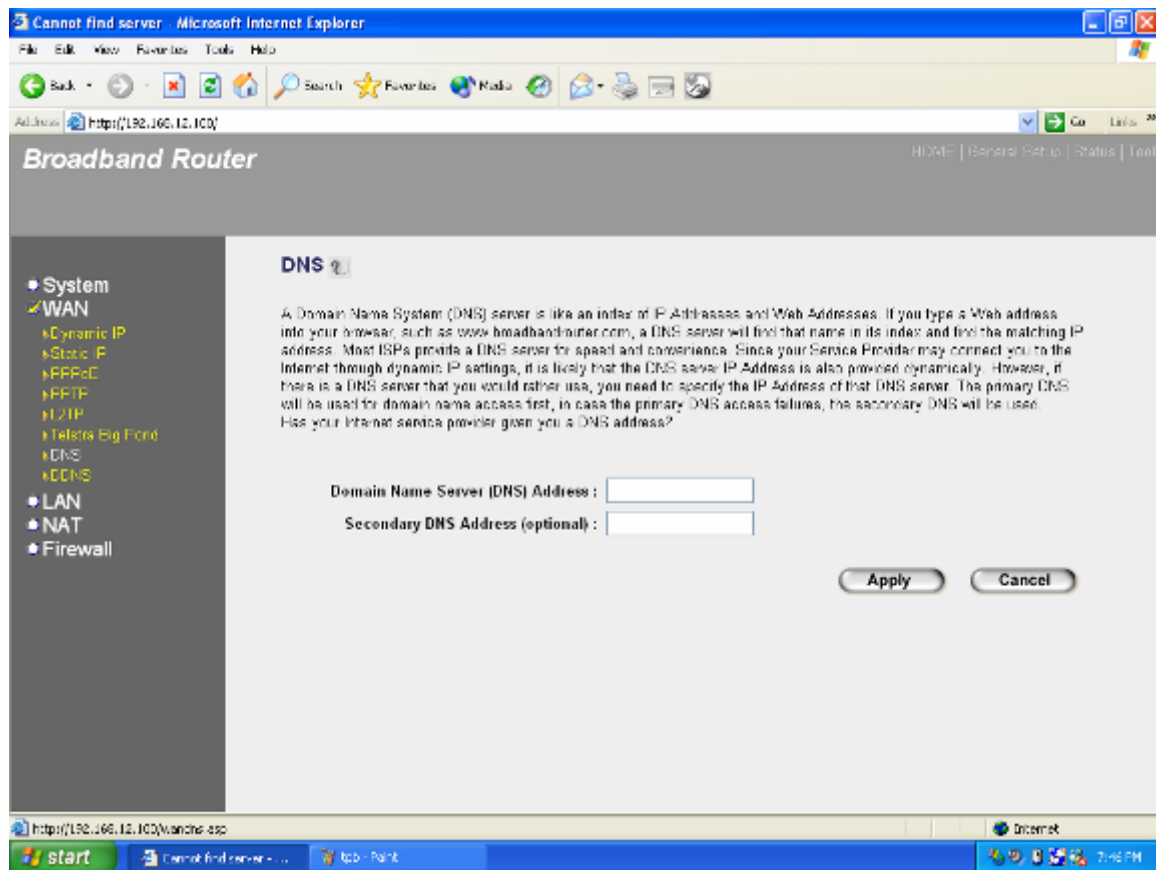

Parameters	Description
Domain Name Server (DNS) Server	This is the ISP's DNS server IP address that they gave you; or you can specify your own preferred DNS server IP address
Secondary DNS Address (optional)	This is optional. You can enter another DNS server's IP address as a backup. The secondary DNS will be used should the above DNS fail.

Click **<Apply>** at the bottom of the screen to save the above configurations. You can now configure other advance sections or start using the router (with the advance settings in place)

## 2.2.8 DDNS

DDNS allows you to map the static domain name to a dynamic IP address. You must get an account, password and your static domain name from the DDNS service providers. This router supports DynDNS and TZO.

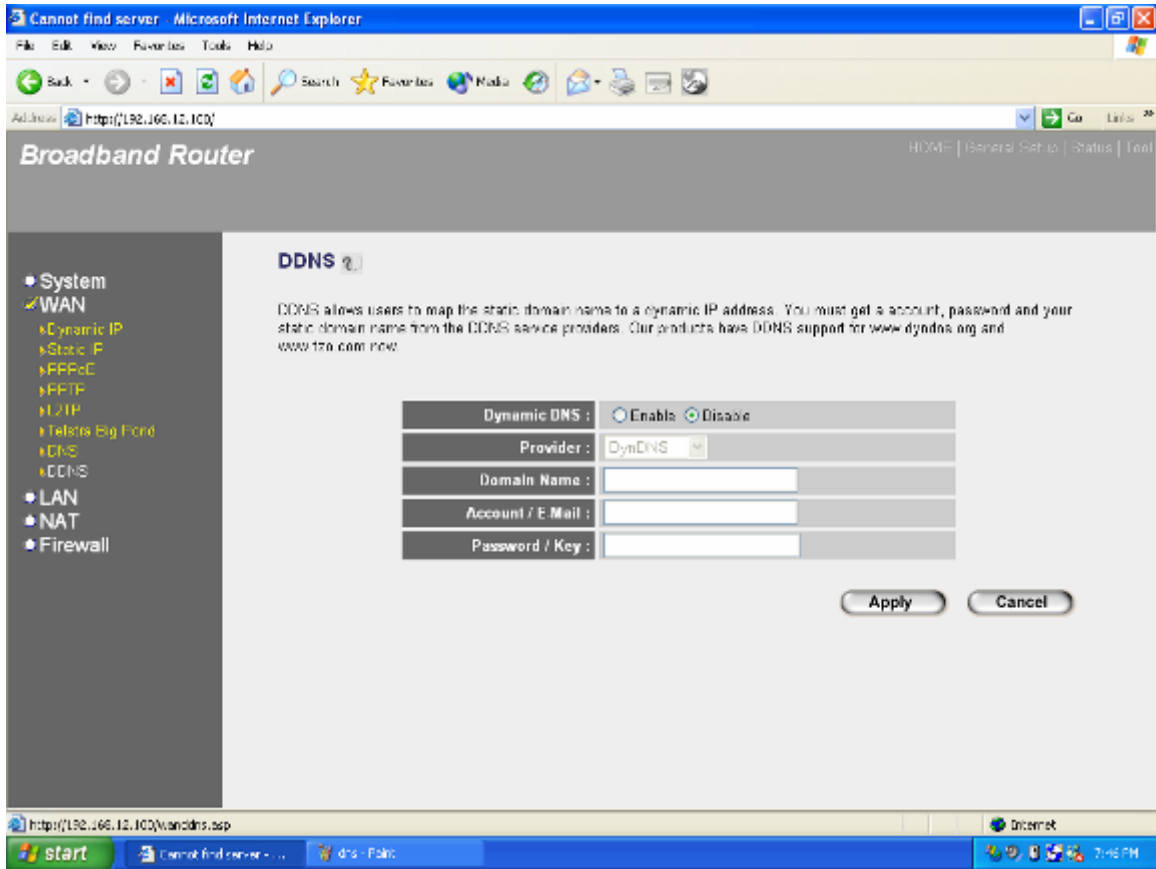

Parameters	Default	Description
Enable/Disable	Disable	Enable/Disable the DDNS function of this router
Provider		Select a DDNS service provider
Domain name		Your static domain name that use DDNS
Account/E-mail		The account that your DDNS service provider assigned to you
Password/Key		The password you set for the DDNS service account above

Click <Apply> at the bottom of the screen to save the above configurations. You can now configure other advance sections or start using the router (with the advance settings in place)

## 2.3 LAN

The LAN Port screen below allows you to specify a private IP address for your router's LAN ports as well as a subnet mask for your LAN segment.

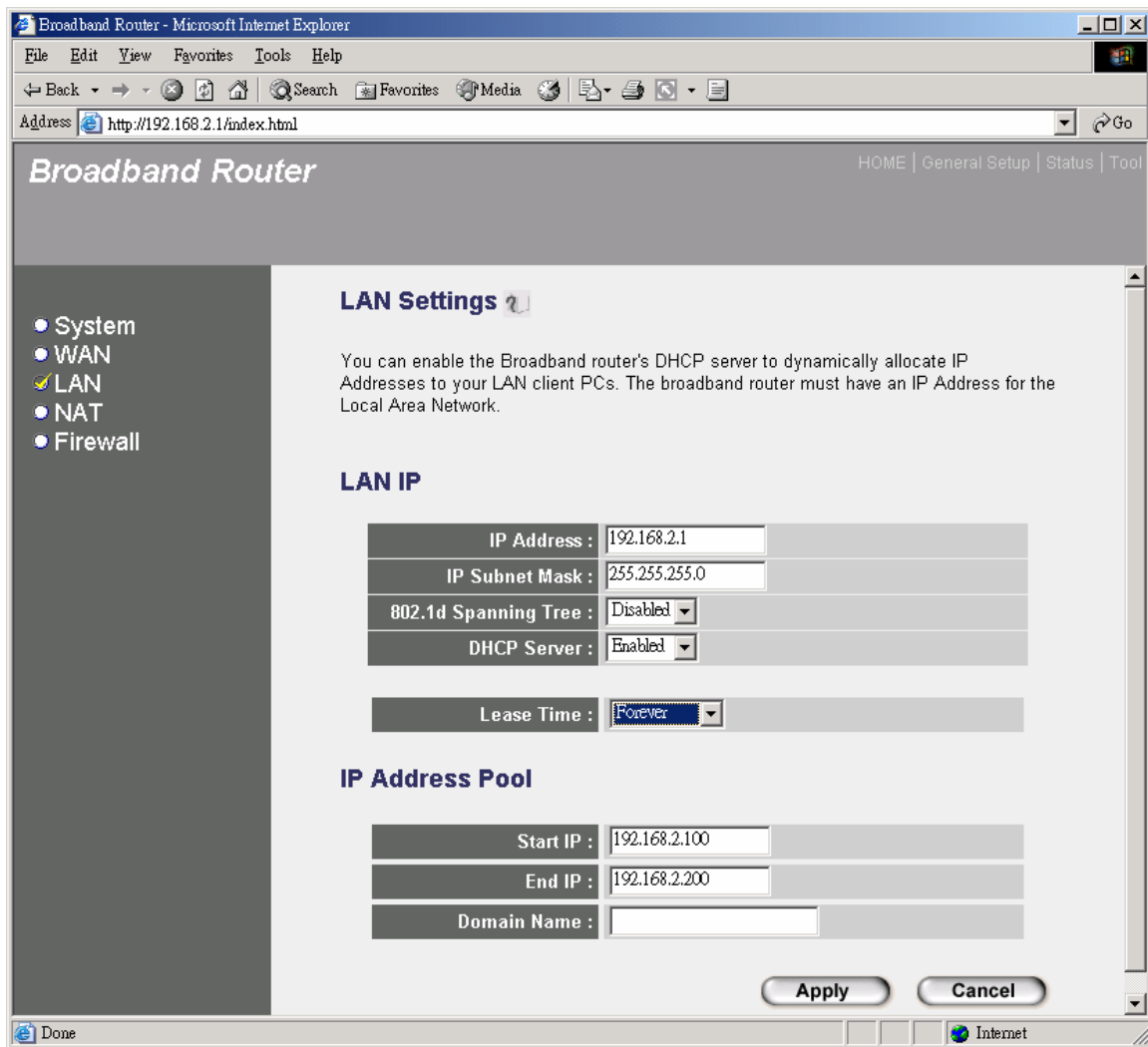

Parameters	Default	Description
<b>LAN IP</b>		
IP address	192.168.2.1	This is the router's LAN port IP address (Your LAN clients default gateway IP address)
IP Subnet Mask	255.255.255.0	Specify a Subnet Mask for your LAN segment
802.1d Spanning Tree	Disabled	If 802.1d Spanning Tree function is enabled, this router will use the spanning tree protocol to prevent from network loop happened in the LAN ports.
DHCP Server	Enabled	You can enable or disable the DHCP server. By enabling the DHCP server the router will automatically give your LAN clients an IP address. If the DHCP is not enabled then you'll



have to manually set your LAN client's IP addresses; make sure the LAN Client is in the same subnet as this broadband router if you want the router to be your LAN client's default gateway

### Lease Time

The DHCP when enabled will temporarily give your LAN clients an IP address. In the Lease Time setting you can specify the time period that the DHCP lends an IP address to your LAN clients. The DHCP will change your LAN client's IP address when this time threshold period is reached

### IP Address Pool

You can select a particular IP address range for your DHCP server to issue IP addresses to your LAN Clients.

**Note:** By default the IP range is from: Start IP **192.168.2.100** to End IP **192.168.2.199**. If you want your PC to have a static/fixed IP address then you'll have to choose an IP address outside this IP address Pool

### Domain Name

You can specify a Domain Name for your LAN

---

Click <**Apply**> at the bottom of the screen to save the above configurations. You can now configure other advance sections or start using the router (with the advance settings in place)

## 2.4 NAT

Network Address Translation (NAT) allows multiple users at your local site to access the Internet through a single Public IP Address or multiple Public IP Addresses. NAT provides Firewall protection from hacker attacks and has the flexibility to allow you to map Private IP Addresses to Public IP Addresses for key services such as Websites and FTP.

---

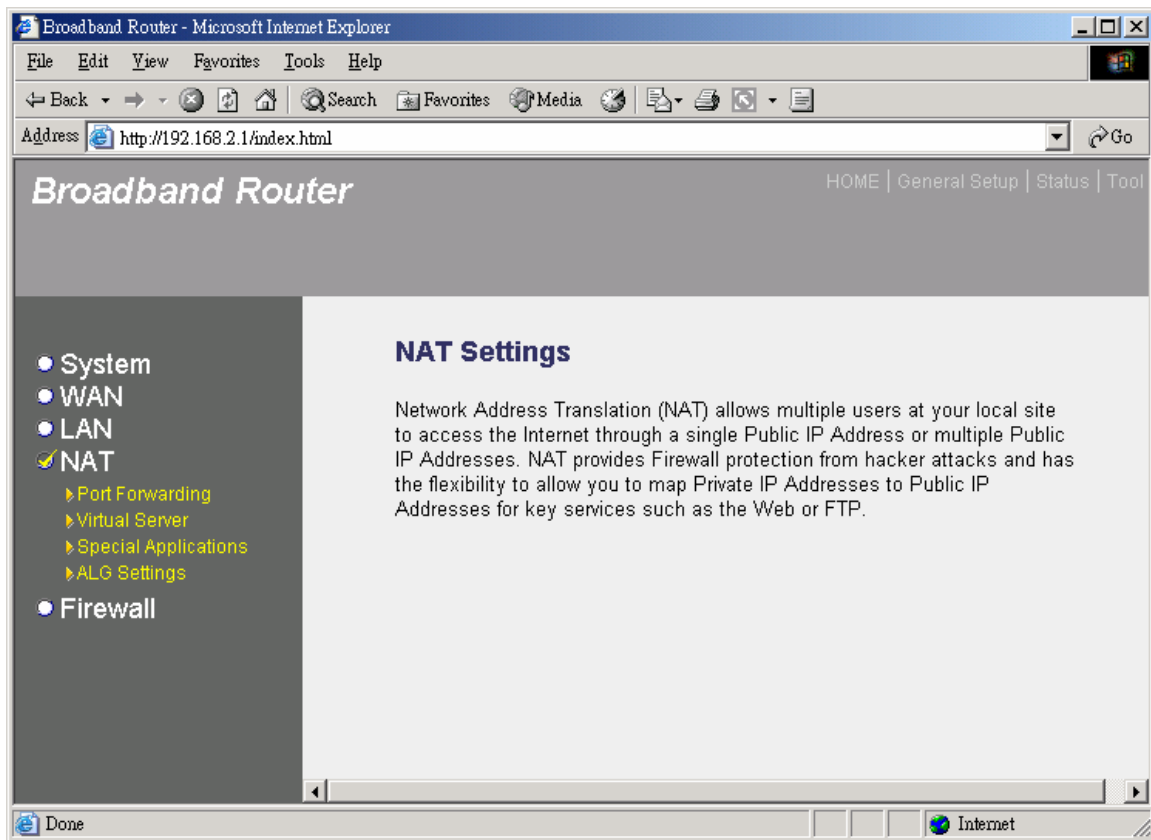

Parameter	Description
2.4.1 Port Forwarding	You can have different services (e.g. email, FTP, Web etc.) going to different service servers/clients in your LAN. The Port Forwarding allows you to re-direct a particular range of service port numbers (from the Internet/WAN Ports) to a particular LAN IP address.
2.4.2 Virtual Server	You can have different services (e.g. email, FTP, Web etc.) going to different service servers/clients in your LAN. The Virtual Server allows you to re-direct a particular service port number (from the Internet/WAN Port) to a particular LAN IP address and its service port number.
2.4.3 Special Applications	Some applications require multiple connections, such as Internet games, video conferencing, Internet telephony and others. In this section you can configure the router to support these types of applications.
2.4.4 ALG Setting	You can select special applications that need "Application Layer Gateway" to support here.

Click on one of the three NAT selections and proceed to the manual's relevant sub-section.

### **2.4.1 Port Forwarding**

The Port Forwarding allows you to re-direct a particular range of service port numbers (from the Internet/WAN Ports) to a particular LAN IP address. It helps you to host some servers behind the router NAT firewall.

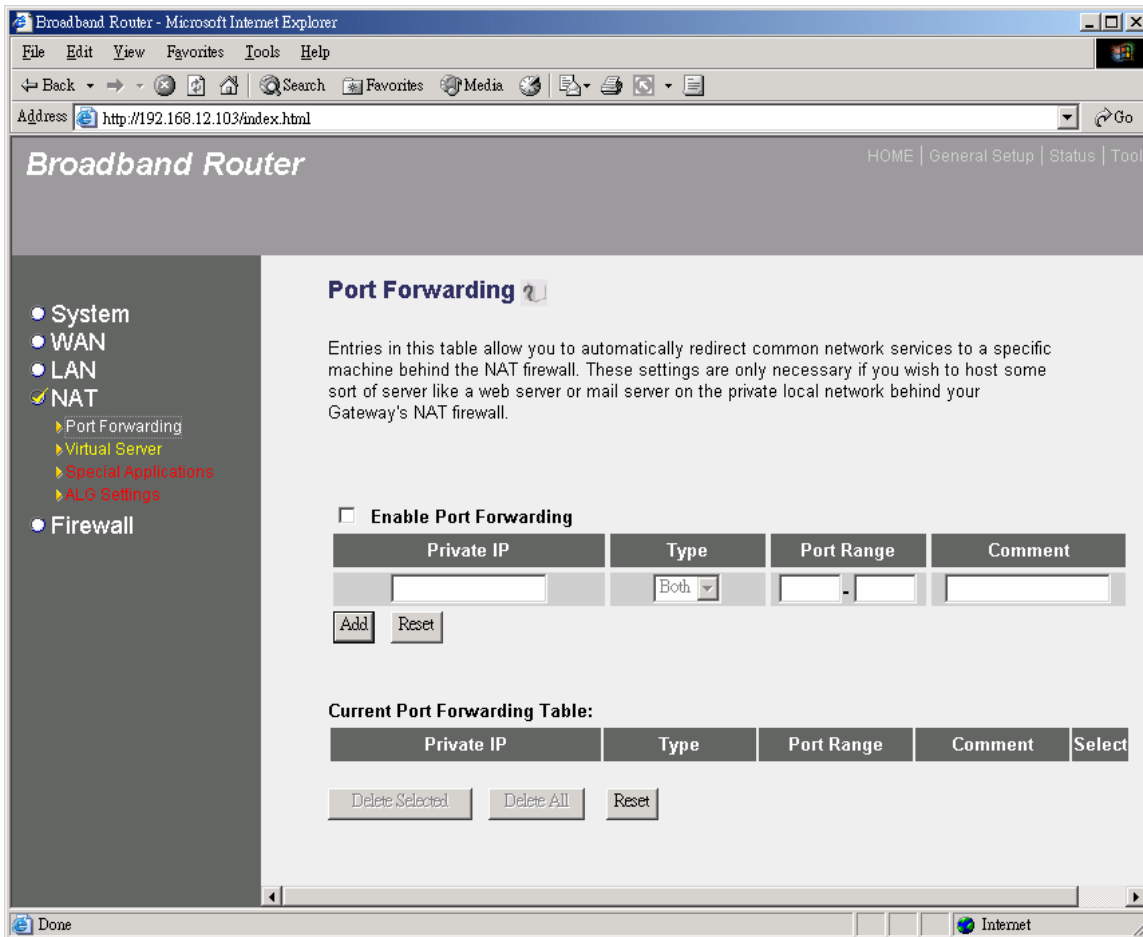

Parameter	Description
Enable Port Forwarding	Enable Port Forwarding
Private IP	This is the private IP of the server behind the NAT firewall. <b>Note:</b> You need to give your LAN PC clients a fixed/static IP address for Port Forwarding to work properly.
Type	This is the protocol type to be forwarded. You can choose to forward "TCP" or "UDP" packets only or select "both" to forward both "TCP" and "UDP" packets.
Port Range	The range of ports to be forward to the private IP.
Comment	The description of this setting.
Add Port Forwarding into the table	Fill in the "Private IP", "Type", "Port Range" and "Comment" of the setting to be added and then click "Add". Then this Port Forwarding setting will be added into the "Current Port Forwarding

Table" below. If you find any typo before adding it and want to retype again, just click "Clear" and the fields will be cleared.

Remove Port Forwarding into the table

If you want to remove some Port Forwarding settings from the " Current Port Forwarding Table", select the Port Forwarding settings you want to remove in the table and then click "Delete Selected". If you want remove all Port Forwarding settings from the table, just click "Delete All" button. Click "Reset" will clear your current selections.

---

Click <**Apply**> at the bottom of the screen to save the above configurations. You can now configure other advance sections or start using the router (with the advance settings in place)

## 2.4.2 Virtual Server

Use the Virtual Server function when you want different servers/clients in your LAN to handle different service/Internet application type (e.g. Email, FTP, Web server etc.) from the Internet. Computers use numbers called port numbers to recognize a particular service/Internet application

---

type. The Virtual Server allows you to re-direct a particular service port number (from the Internet/WAN Port) to a particular LAN private IP address and its service port number. (See Glossary for an explanation on Port number)

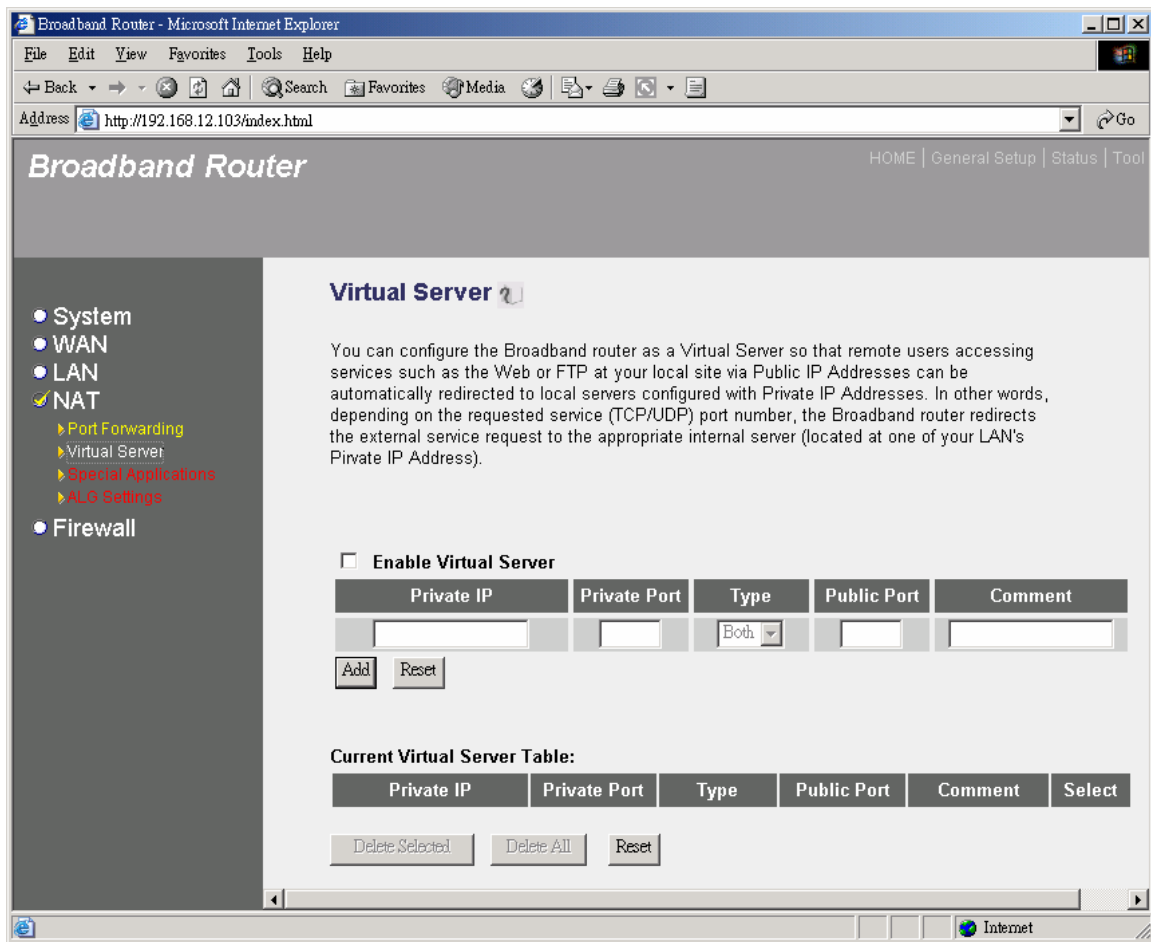

Parameters	Description
Enable Virtual Server	Enable Virtual Server.
Private IP	This is the LAN client/host IP address that the Public Port number packet will be sent to. <b>Note:</b> You need to give your LAN PC clients a fixed/static IP address for Virtual Server to work properly.
Private Port	This is the port number (of the above Private IP host) that the below Public Port number will be changed to when the packet enters your LAN (to the LAN Server/Client IP)
Type	Select the port number protocol type (TCP, UDP or both). If you are unsure, then leave it to the default both protocol.

Public Port	Enter the service (service/Internet application) port number from the Internet that will be re-directed to the above Private IP address host in your LAN <b>Note:</b> Virtual Server function will have priority over the DMZ function if there is a conflict between the Virtual Server and the DMZ settings.
Comment	The description of this setting.
Add Virtual Server	Fill in the "Private IP", "Private Port", "Type", "Public Port" and "Comment" of the setting to be added and then click "Add". Then this Virtual Server setting will be added into the "Current Virtual Server Table" below. If you find any typo before adding it and want to retype again, just click "Clear" and the fields will be cleared.
Remove Virtual Server	If you want to remove some Virtual Server settings from the "Current Virtual Server Table", select the Virtual Server settings you want to remove in the table and then click "Delete Selected". If you want remove all Virtual Server settings from the table, just click "Delete All" button. Click "Reset" will clear your current selections.

---

Click <**Apply**> at the bottom of the screen to save the above configurations. You can now configure other advance sections or start using the router (with the advance settings in place)

#### Example: Virtual Server

---

The diagram below demonstrates one of the ways you can use the Virtual Server function. Use the Virtual Server when you want the web server located in your private LAN to be accessible to Internet users. The configuration below means that any request coming from the Internet to access your web server will be translated to your LAN's web server (192.168.2.2). **Note:** For the virtual server to work properly Internet/remote users must know your global IP address. (For websites you will need to have a fixed/static global/public IP address)

### Configuration

Private IP: 192.168.2.2

Private Port: 80

Type: TCP

Public Port: 80

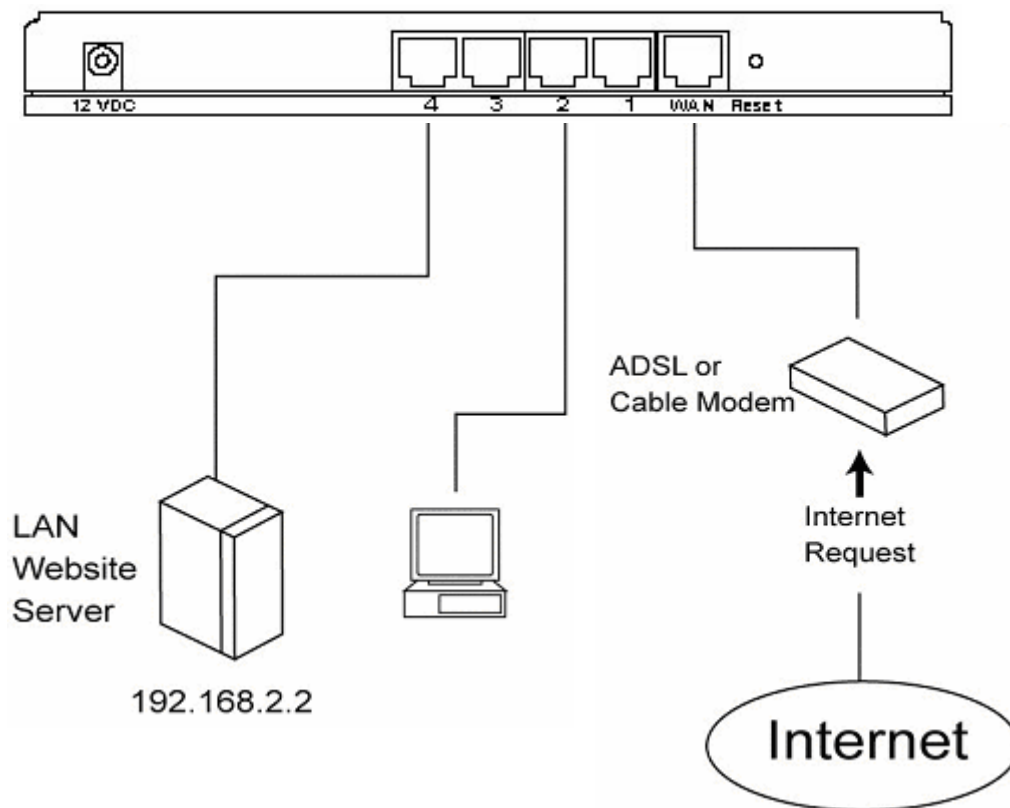



## 2.4.3 Special Applications

Some applications require multiple connections, such as Internet games, video conferencing, Internet telephony and others. In this section you can configure the router to support multiple connections for these types of applications.

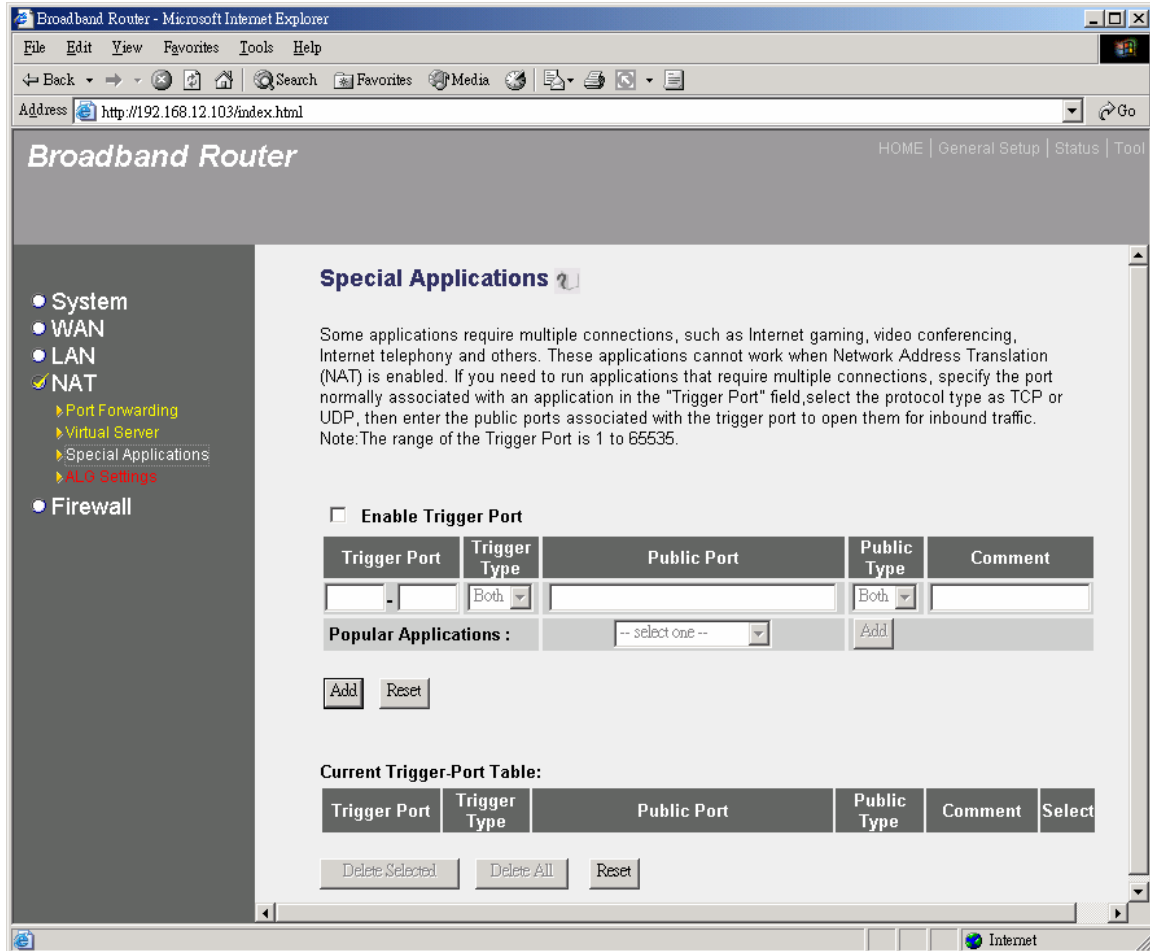

Parameters	Description
Enable Trigger Port	Enable the Special Application function.
Trigger Port	This is the out going (Outbound) range of port numbers for this particular application
Trigger Type	Select whether the outbound port protocol is "TCP", "UDP" or both.
Public Port	Enter the In-coming (Inbound) port or port range for this type of application (e.g. 2300-2400, 47624)
	<b>Note:</b> Individual port numbers are separated by a comma (e.g. 47624, 5775, 6541 etc.). To input a port range use a "dash" to separate the two port number range (e.g. 2300-2400)



- Public Type** Select the Inbound port protocol type: "TCP", "UDP" or both
- Comment** The description of this setting.
- Popular applications** This section lists the more popular applications that require multiple connections. Select an application from the Popular Applications selection. Once you have selected an application, click the **Add** button. This will automatically copy the Port Trigger information required for this popular application in into the input fields.
- Add Special Application** Fill in the "Trigger Port", "Trigger Type", "Public Port", "Public Type", "Public Port" and "Comment" of the setting to be added and then click "Add". Then this Special Application setting will be added into the "Current Trigger-Port Table" below. If you find any typo before adding it and want to retype again, just click "Clear" and the fields will be cleared. If you want to add a popular application, select one "Popular Application" and then click "Add".
- Remove Special Application** If you want to remove some Special Application settings from the " Current Trigger-Port Table", select the Special Application settings you want to remove in the table and then click "Delete Selected". If you want remove all Special Application settings from the table, just click "Delete All" button. Click "Reset" will clear your current selections.

---

Click **<Apply>** at the bottom of the screen to save the above configurations. You can now configure other advance sections or start using the router (with the advance settings in place)

**Example: Special Applications**

If you need to run applications that require multiple connections, then specify the port (outbound) normally associated with that application in the "Trigger Port" field. Then select the protocol type (TCP or UDP) and enter the public ports associated with the trigger port to open them up for inbound traffic.

**Example:**

ID	Trigger Port	Trigger Type	Public Port	Public Type	Comment
1	28800	UDP	2300-2400, 47624	TCP	MSN Game Zone
2	6112	UDP	6112	UDP	Battle.net

In the example above, when a user trigger's port 28800 (outbound) for MSN Game Zone then the

---

router will allow incoming packets for ports 2300-2400 and 47624 to be directed to that user.  
**Note:** Only one LAN client can use a particular special application at a time.

## 2.4.4 ALG Settings

You can select applications that need “Application Layer Gateway” to support.

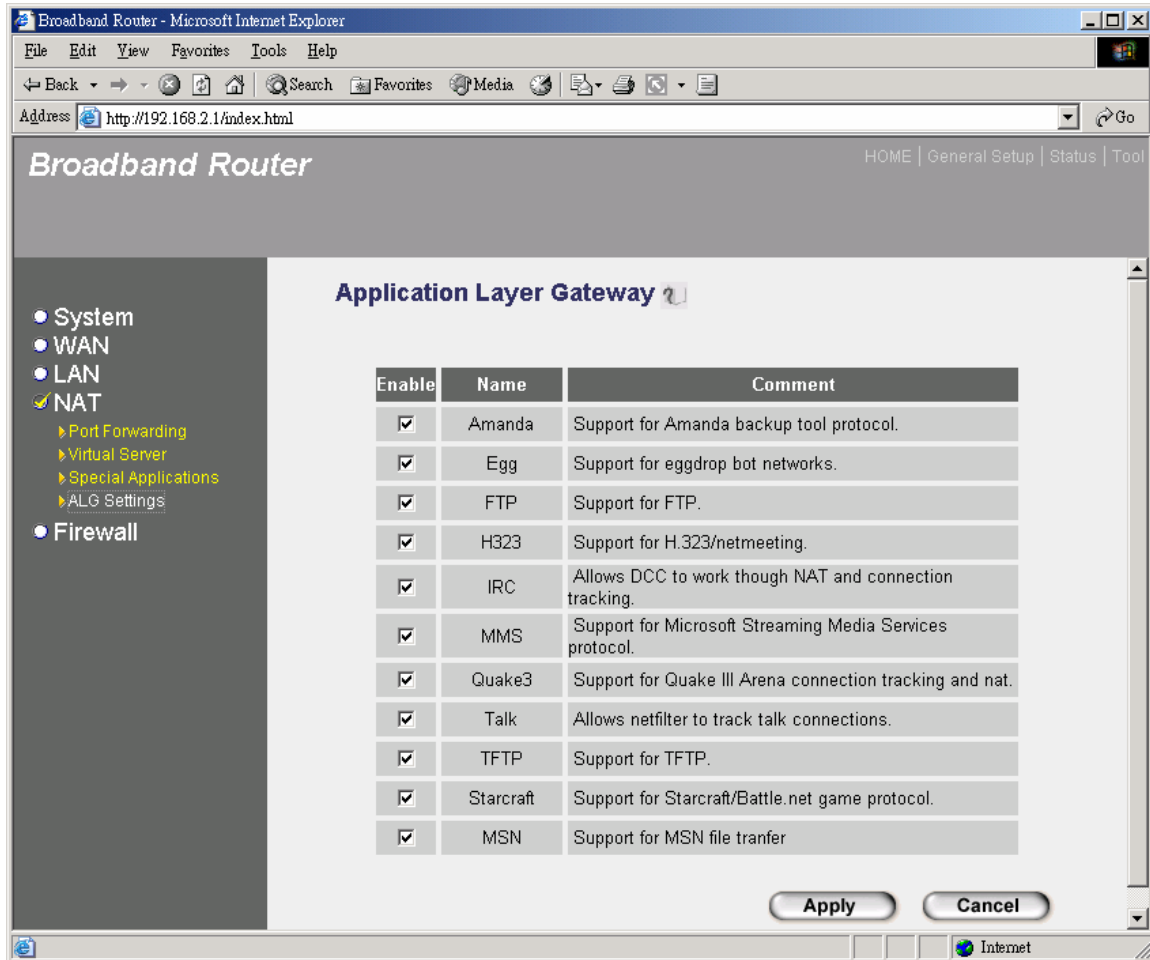

Parameters	Default	Description
Enable		You can select to enable “Application Layer Gateway” of an application and then the router will let that application correctly pass through the NAT gateway.

Click <Apply> at the bottom of the screen to save the above configurations. You can now configure other advanced sections or start using the router (with the advanced settings in place)

## 2.5 Firewall

The Broadband router provides extensive firewall protection by restricting connection parameters, thus limiting the risk of hacker attack, and defending against a wide array of common Internet attacks. However, for applications that require unrestricted access to the Internet, you can configure a specific client/server as a Demilitarized Zone (DMZ).

**Note:** To enable the Firewall settings select **Enable** and click **Apply**

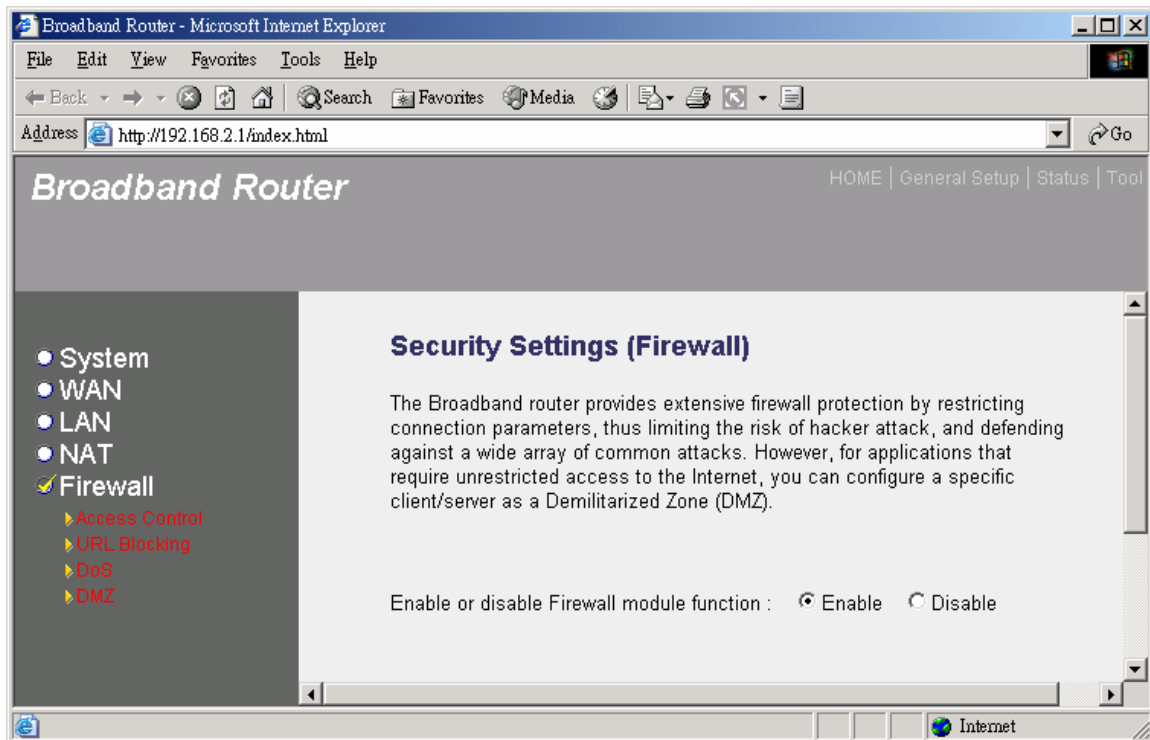

Parameters	Description
2.5.1 Access Control	Access Control allows you to specify which hosts users can or cannot have access to certain Internet applications
2.5.2 URL Blocking not be	URL Blocking allow you to specify which URLs can accessed by users.
2.5.3 DoS	The Broadband router's firewall can block common hacker attacks and can log the attack activities.
2.5.4 DMZ	The DMZ function allows you to re-direct all packets going to your WAN port IP address to a particular IP address in your LAN.

Click on one of the firewall selections and proceed to the manual's relevant sub-section

## 2.5.1 Access Control

If you want to restrict users from accessing certain Internet applications/services (e.g. Internet websites, email, FTP etc.), then this is the place to set that configuration. Access Control allows users to define the traffic type permitted in your LAN. You can control which PC client can have access to these services.

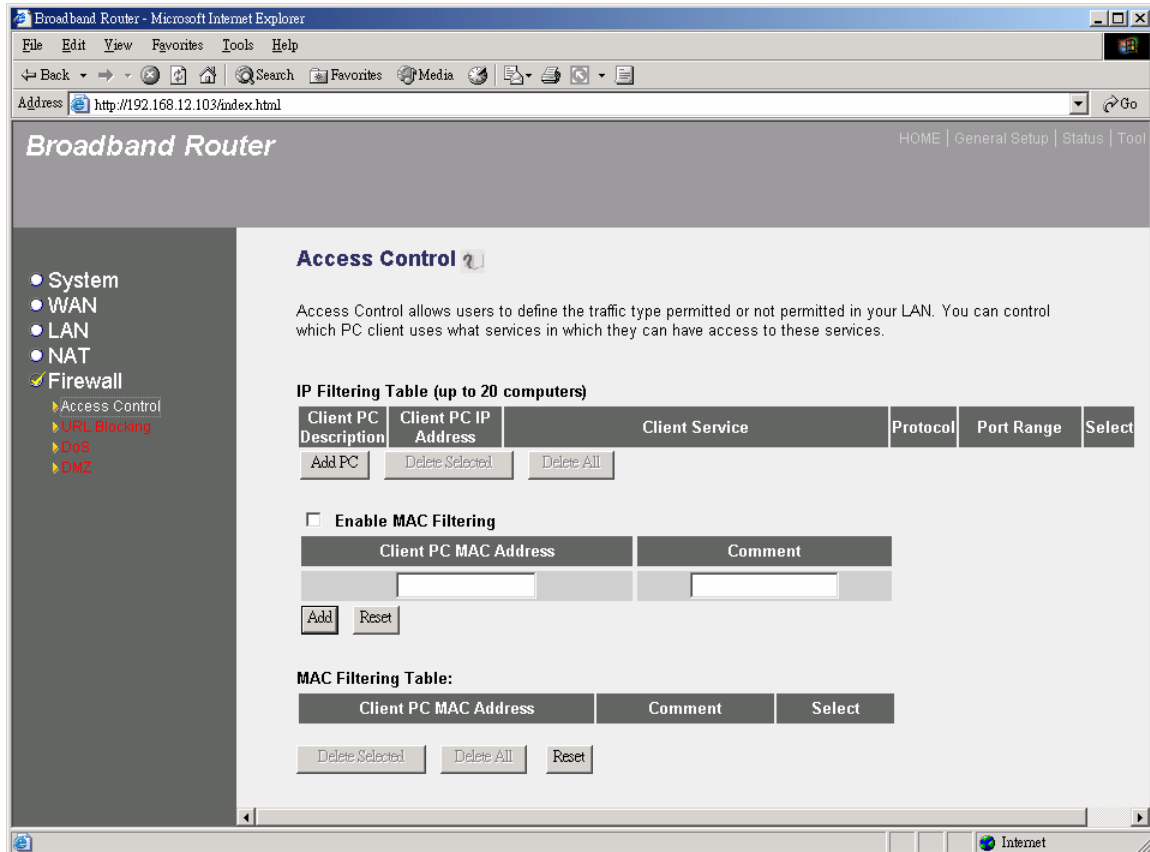

---

### Parameters

### Description

#### Filter client PCs by IP

Fill "IP Filtering Table" to filter PC clients by IP.

#### Add PC

You can click Add PC to add an access control rule for users by IP addresses.

#### Remove PC

If you want to remove some PC from the "IP Filtering Table", select the PC you want to remove in the table and then click "Delete Selected". If you want remove all PCs from the table, just click "Delete All" button.

#### Filter client PC by MAC address

Check "Enable MAC Filtering" to enable MAC Filtering.

---

#### Add PC

Fill in "Client PC MAC Address" and "Comment" of the PC that is allowed to access the Internet, and then click "Add". If you find any typo before adding it and want to retype again, just click "Reset" and the fields will be cleared.

#### Remove PC

If you want to remove some PC from the "MAC Filtering Table", select the PC you want to remove in the table and then click "Delete Selected". If you want remove all PCs from the table, just click "Delete All" button. If you want to clear the selection and re-select again, just click "Reset".

---

You can now configure other advance sections or start using the router (with the advance settings in place)

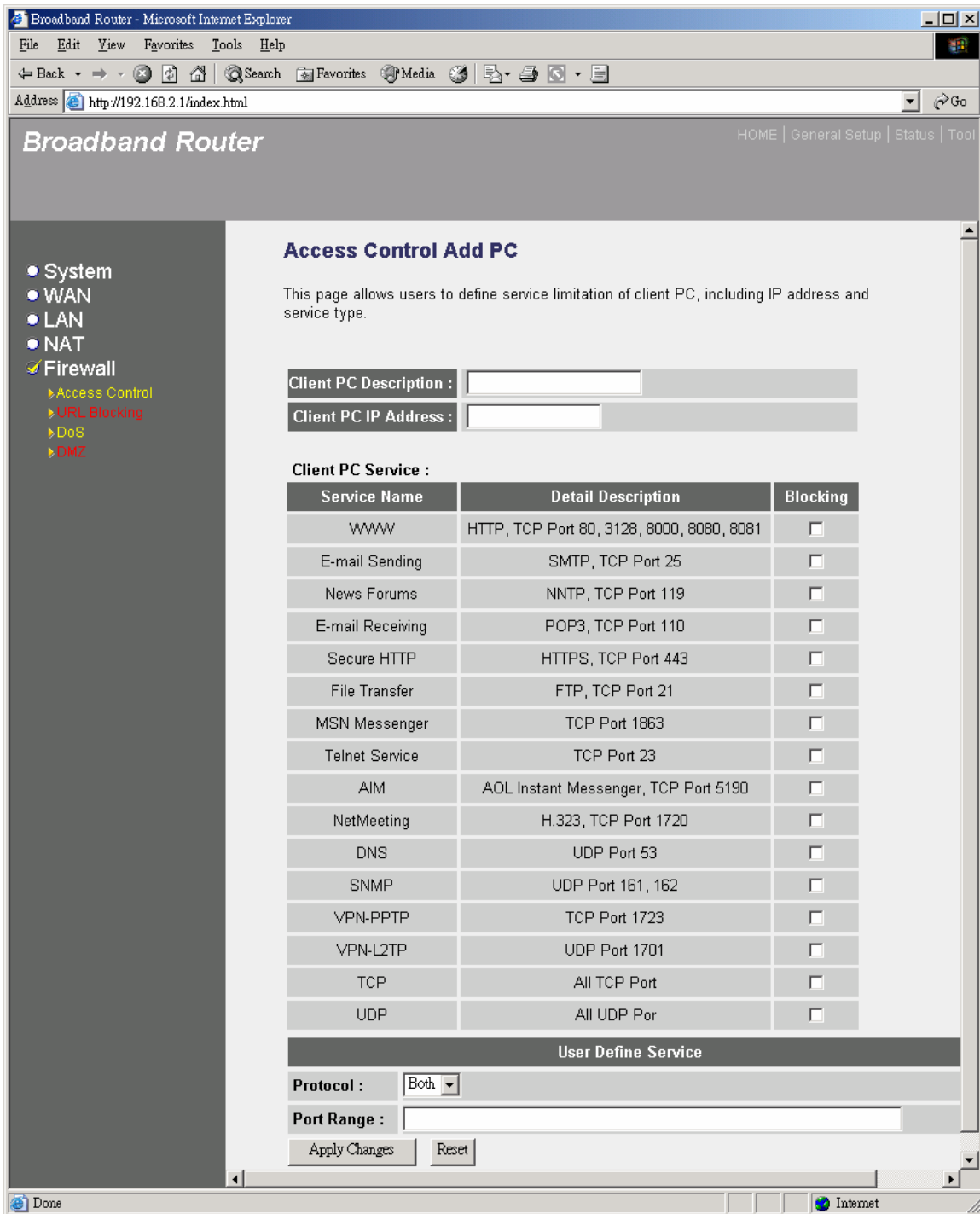

## Add PC

### Parameters

### Description

Client PC Description

The description for this client PC rule.

Client PC IP Addresses

Enter the IP address range that you wish to apply this Access Control rule. This is the user's IP address(es)



that you wish to setup an Access Control rule. You can select a range of users simply by inputting the starting users' IP address and the last user's IP address in the appropriate boxes. If you want to select only one user then input the user's IP address in both boxes.

**Note:** You need to give your LAN PC clients a fixed/static IP address for the Access Control rule to work properly.

Client PC Service	You can block the clients from accessing some Internet services by checking the services you want to block.
Protocol	This allows you to select UDP, TCP or both protocol type you want to block.
Port Range	You can assign up to five port ranges. The router will block clients from accessing Internet services that use these ports.
Apply Changes	Click "Apply Changes" to save the setting.
Reset	Click "Reset" to clear all fields.

---

Click <**Apply Changes**> at the bottom of the screen to save the above configurations. You can now configure other advance sections or start using the router (with the advance settings in place)

**Example: Access Control**

In the example below, LAN client A can only access websites that use Port 80. However, LAN client B is able to access websites and any other service that uses ports between 80 and 999.

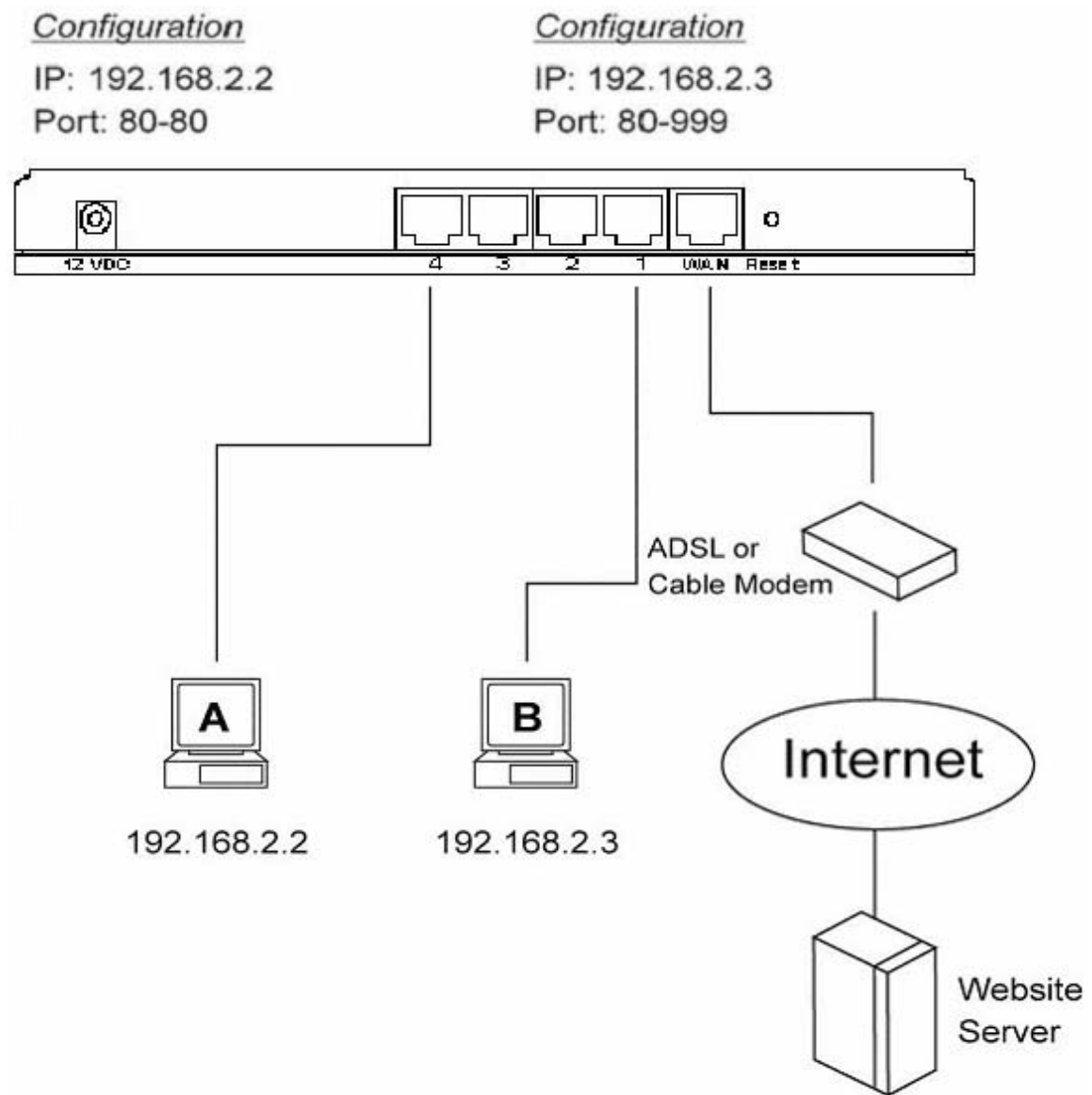

## 2.5.2 URL Blocking

You can block access to some Web sites from particular PCs by entering a full URL address or just keyword of the Web site.

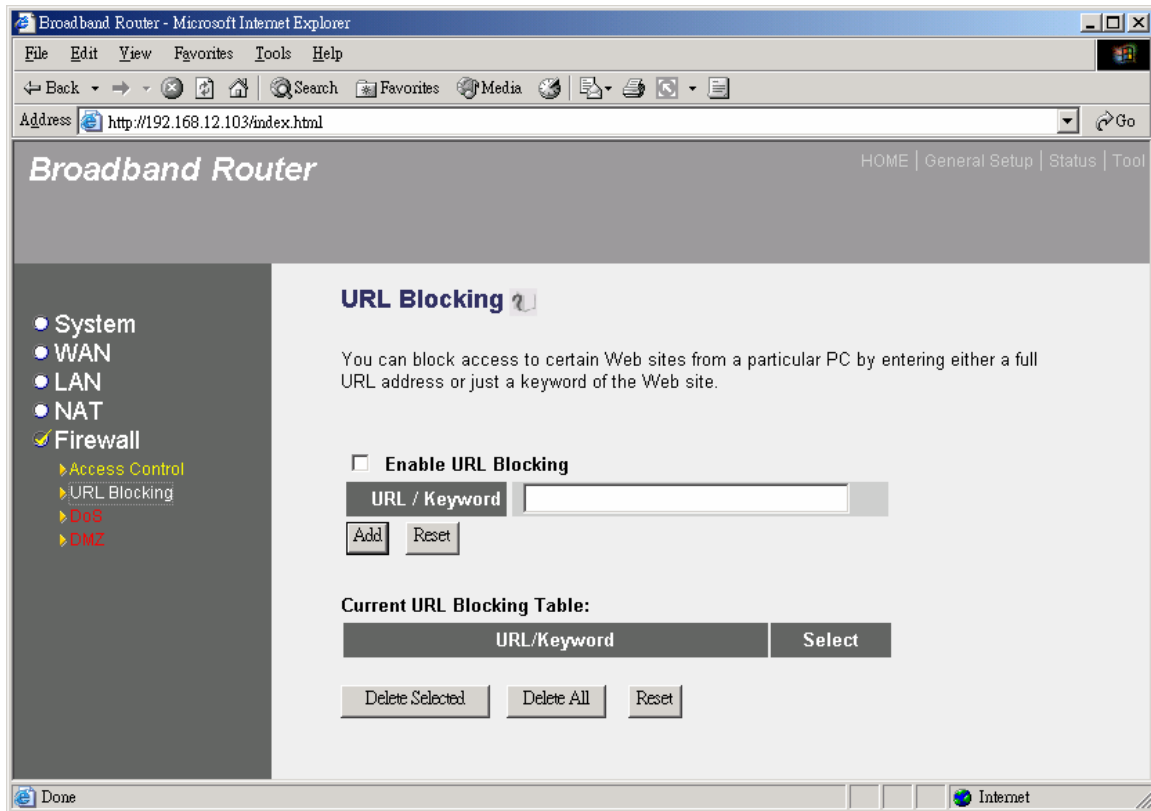

Parameters	Description
Enable URL Blocking	Enable/disable URL Blocking
Add URL Keyword	Fill in "URL/Keyword" and then click "Add". You can enter the full URL address or the keyword of the web site you want to block. If you find any typo before adding it and want to retype again, just click "Reset" and the field will be cleared.
Remove URL Keyword	If you want to remove some URL keyword from the "Current URL Blocking Table", select the URL keyword you want to remove in the table and then click "Delete Selected". If you want to remove all URL keyword from the table, just click "Delete All" button. If you want to clear the selection and re-select again, just click "Reset".

You can now configure other advance sections or start using the router (with the advance settings in place)

## 2.5.3 Denial of Service (DoS)

The Broadband router's firewall can block common hacker attacks, including Denial of Service, Ping of Death, Port Scan and Sync Flood. If Internet attacks occur the router can log the events.

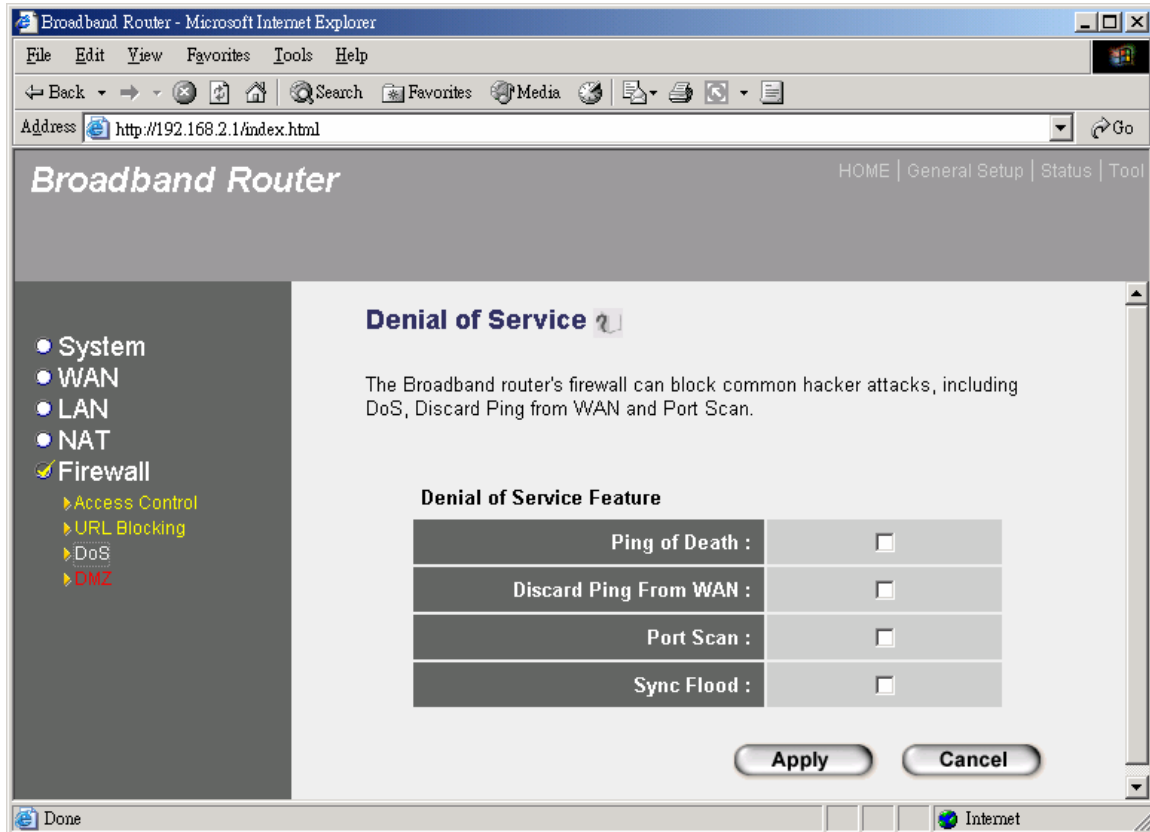

Parameters	Description
<b>Intrusion Detection Feature</b>	
Ping of Death	Protections from Ping of Death attack
Discard Ping From WAN	The router's WAN port will not respond to any Ping requests
Port Scan	Protection the router from Port Scan.
Sync Flood	Protection the router from Sync Flood attack.

Click <**Apply**> at the bottom of the screen to save the above configurations. You can now configure other advance sections or start using the router (with the advance settings in place)

## 2.5.4 DMZ

If you have a local client PC that cannot run an Internet application (e.g. Games) properly from behind the NAT firewall, then you can open the client up to unrestricted two-way Internet access by defining a DMZ Host. The DMZ function allows you to re-direct all packets going to your WAN port IP address to a particular IP address in your LAN. The difference between the virtual server and the DMZ function is that the virtual server re-directs a particular service/Internet application (e.g. FTP, websites) to a particular LAN client/server, whereas DMZ re-directs all packets (regardless of services) going to your WAN IP address to a particular LAN client/server.

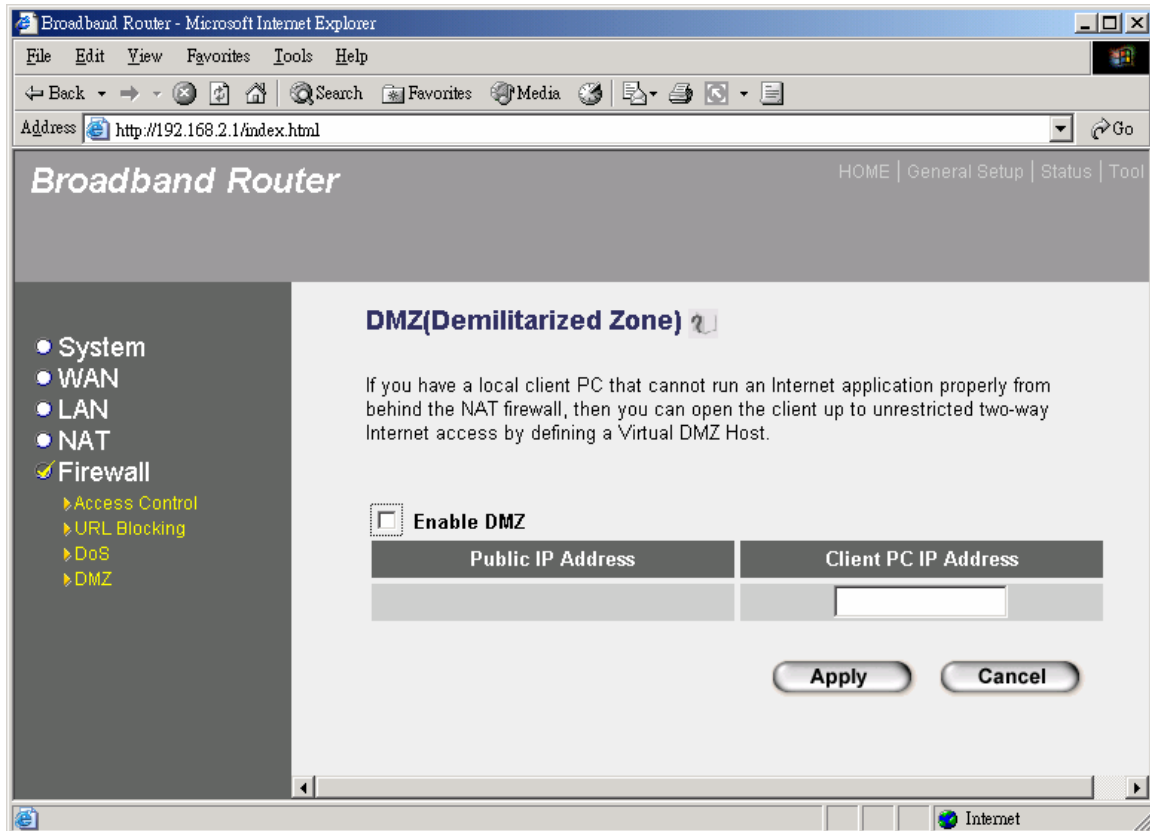

Parameters	Description
Enable DMZ	<p>Enable/disable DMZ</p> <p><b>Note:</b> If there is a conflict between the Virtual Server and the DMZ setting, then Virtual Server function will have priority over the DMZ function.</p>
Public IP Address	<p>The IP address of the WAN port or any other Public IP addresses given to you by your ISP</p>
Client PC IP Address	<p>Input the IP address of a particular host in your LAN that will receive all the packets originally going to the WAN port/Public IP address above</p> <p><b>Note:</b> You need to give your LAN PC clients a fixed/static IP address for DMZ to work properly.</p>

---

You can now configure other advance sections or start using the router (with the advance settings in place)

## Chapter 3

### Status

The Status section allows you to monitor the current status of your router. You can use the Status page to monitor: the connection status of the Broadband router's WAN/LAN interfaces, the current firmware and hardware version numbers, any illegal attempts to access your network, and information on all DHCP client PCs currently connected to your network.

---

Parameters	Description
<b>3.1 Status and Information</b> Shows the router's system information	
<b>3.2 Internet Connection</b>	View the Broadband router's current Internet connection status and other related information
<b>3.3 Device Status</b>	View the Broadband router's current setting status
<b>3.4 Security Log</b>	View any attempts that have been made to illegally gain access to your network.
<b>3.5 DHCP Client Table</b>	View your LAN client's information that is currently linked to the Broadband router's DHCP server
<b>3.6 Statistics</b>	<b>Shows the statistics</b>

---

Select one of the above five Status selections and proceed to the manual's relevant sub-section



### 3.1 Status and Information

The Status and Information section allows you to view the router's system information

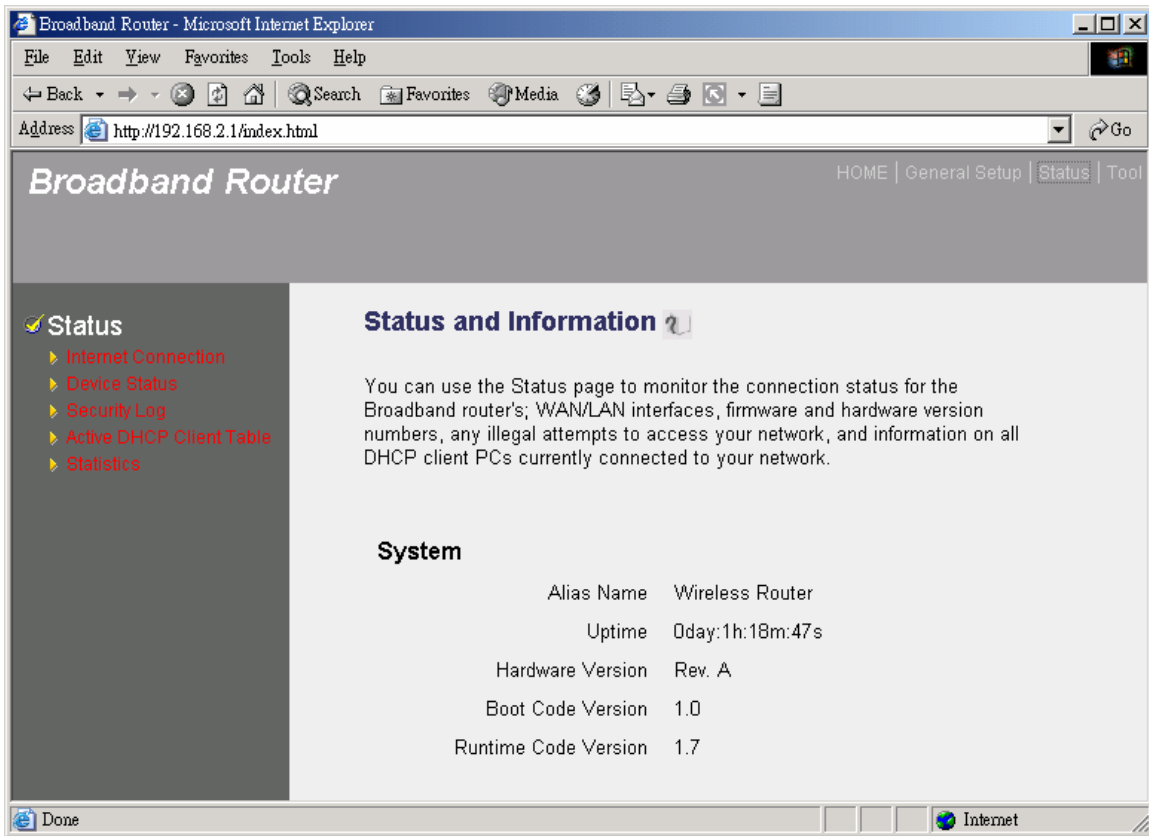

Parameters	Description
Information	You can see the router's system information such as the router's: LAN MAC Address, WAN MAC Address, Hardware version, Serial Number, Boot code Version, Runtime code Version

## 3.2 Internet Connection

View the Broadband router's current Internet connection status and other related information

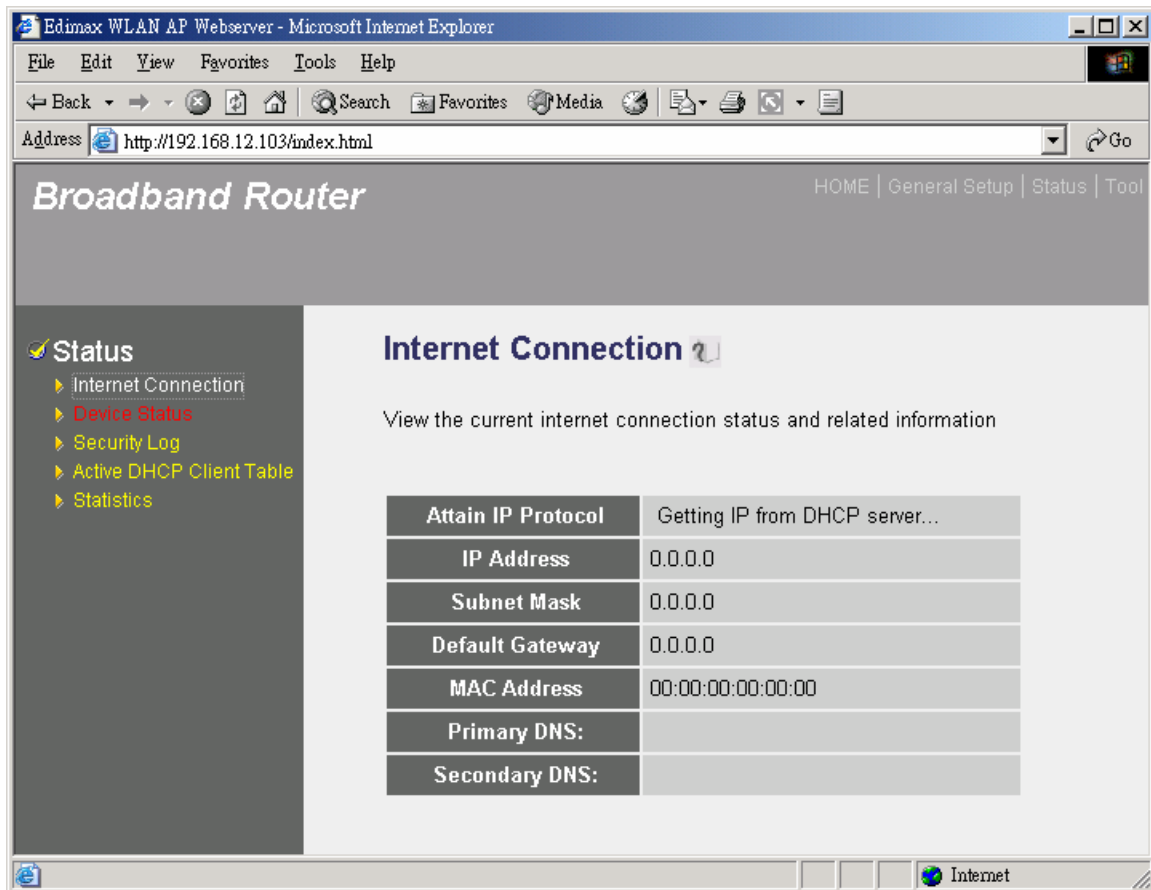

The screenshot shows a Microsoft Internet Explorer browser window displaying the Edimax WLAN AP Webserver. The address bar shows <http://192.168.12.103/index.html>. The page title is "Broadband Router". The navigation menu includes "HOME", "General Setup", "Status", and "Tool". The "Status" section is expanded, showing "Internet Connection" as the selected option. The "Internet Connection" page displays the current status and related information:

View the current internet connection status and related information

Attain IP Protocol	Getting IP from DHCP server...
IP Address	0.0.0.0
Subnet Mask	0.0.0.0
Default Gateway	0.0.0.0
MAC Address	00:00:00:00:00:00
Primary DNS:	
Secondary DNS:	

---

### Parameters

### Description

---

#### Internet Connection

This page displays whether the WAN port is connected to a **Cable/DSL** connection. It also displays the router's WAN port: **WAN IP** address, **Subnet Mask**, and ISP **Gateway** as well as the **Primary DNS** and **Secondary DNS** being used.

---

### 3.3 Device Status

View the Broadband router's current configuration settings. The Device Status displays the configuration settings you've configured in the **Quick Setup Wizard/General Setup** section.

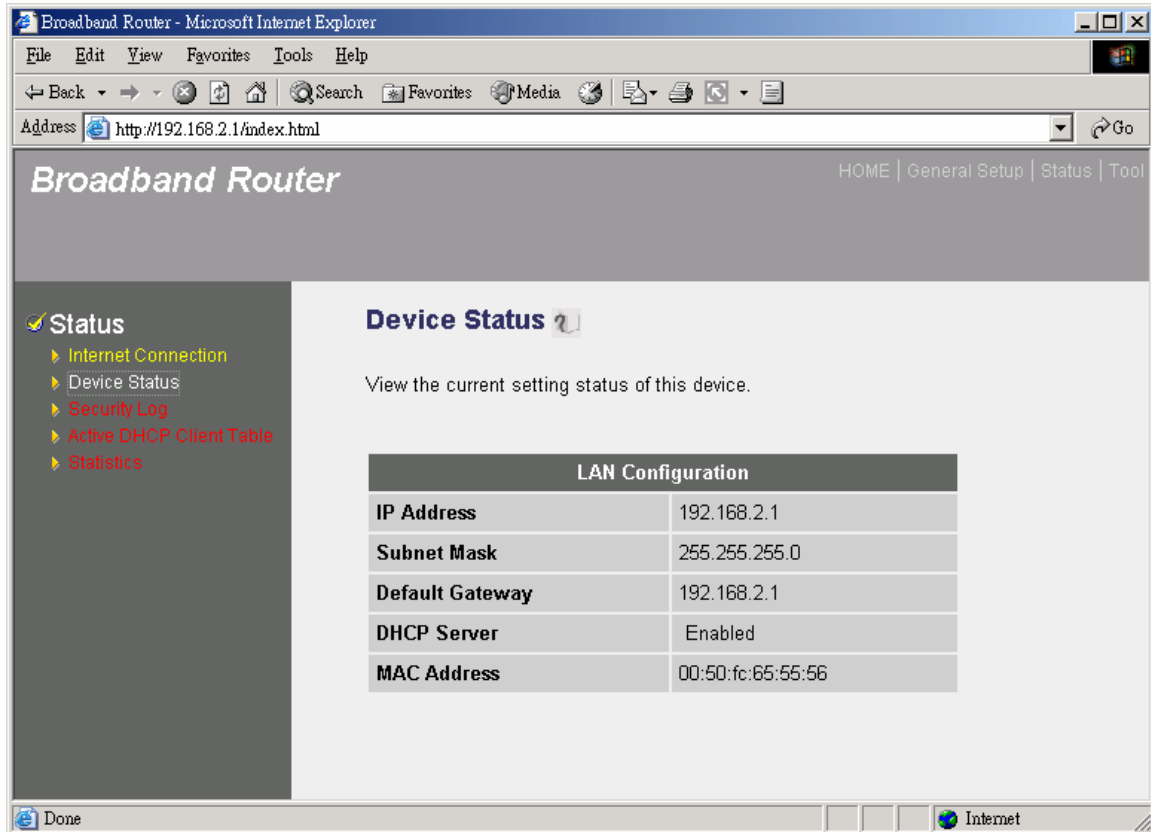

---

#### Parameters

#### Description

---

#### Device Status

This page shows the Broadband router's current device settings. This page displays the Broadband router LAN port's current LAN **IP Address**, **MAC Address** and **Subnet Mask**. It also shows whether the **DHCP Server** function is enabled/disabled.

---

### 3.4 Security Log

View any attempts that have been made to illegally gain access to your network.

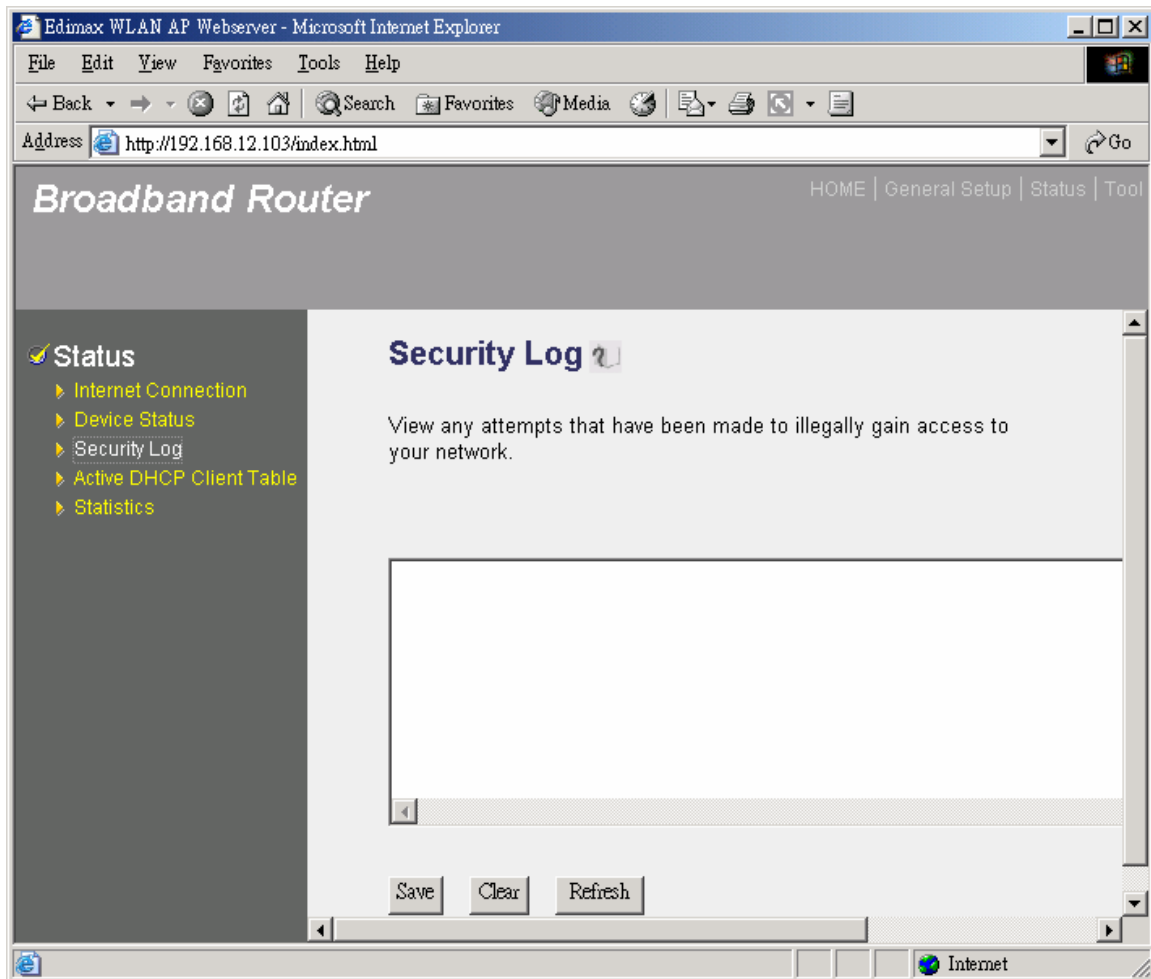

Parameters	Description
Security Log	This page shows the current security log of the Broadband router. It displays any illegal attempts to access your network. At the bottom of the page, the security log can be saved <Save> to a local file for further processing or the security log can be cleared <Clear> or it can be refreshed <Refresh> to get the most updated situation. When the system is powered down, the security log will disappear if not saved to a local file.

### 3.5 Active DHCP Client Table

View your LAN client's information that is currently linked to the Broadband router's DHCP server

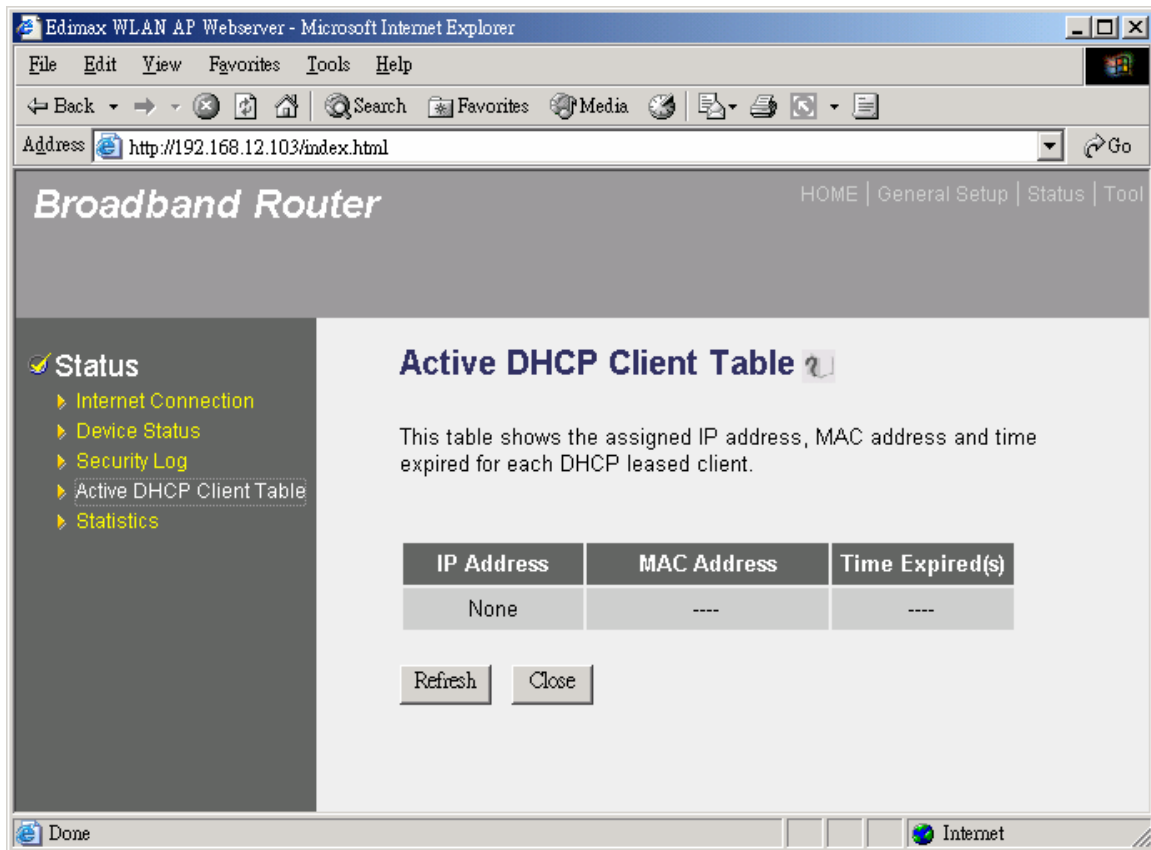

Parameters	Description
DHCP Client Log	This page shows all DHCP clients (LAN PCs) currently connected to your network. The "Active DHCP Client Table" displays the <b>IP</b> address and the <b>MAC</b> address and Time Expired of each LAN Client. Use the <b>Refresh</b> button to get the most updated situation

### 3.6 Statistics

View the statistics of packets sent and received on WAN and LAN.

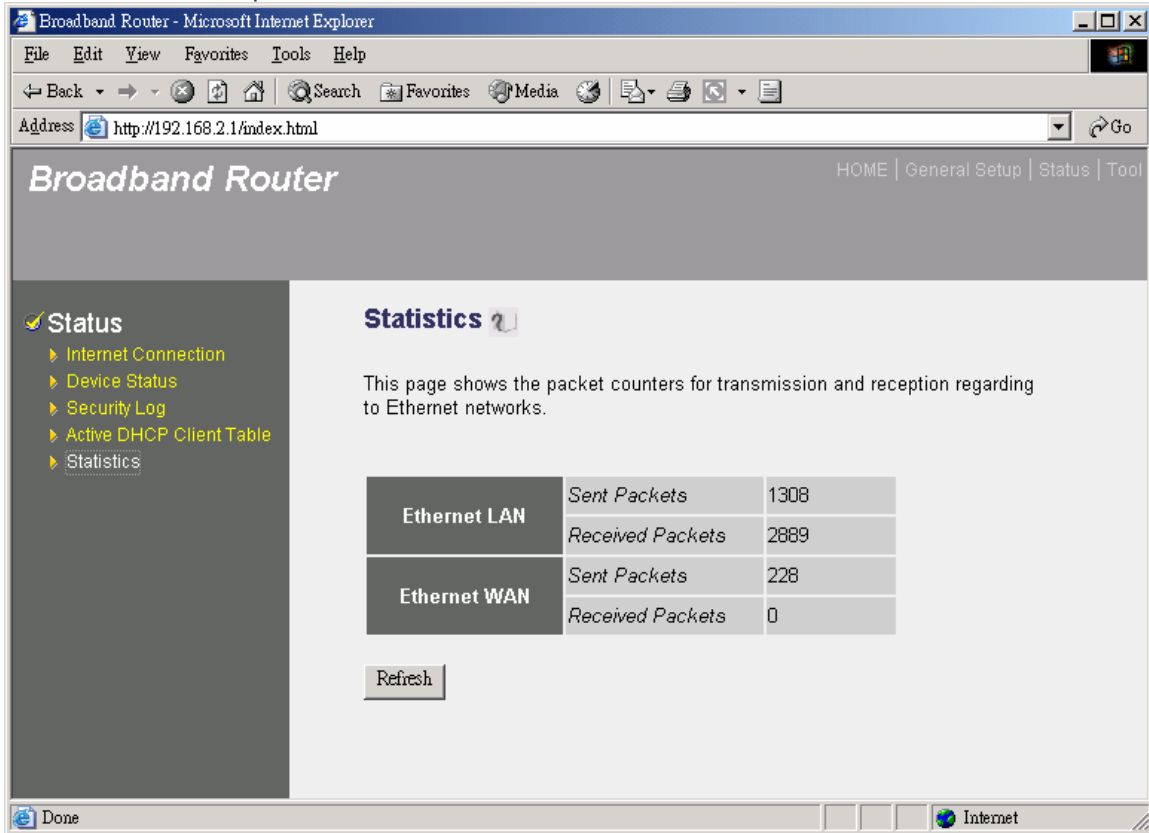

---

Parameters

Description

Statistics

Shows the counters of packets sent and received on WAN and LAN.

---

# Chapter 4

## Tool

This page includes the basic configuration tools, such as Configuration Tools (save or restore configuration settings), Firmware Upgrade (upgrade system firmware) and Reset.

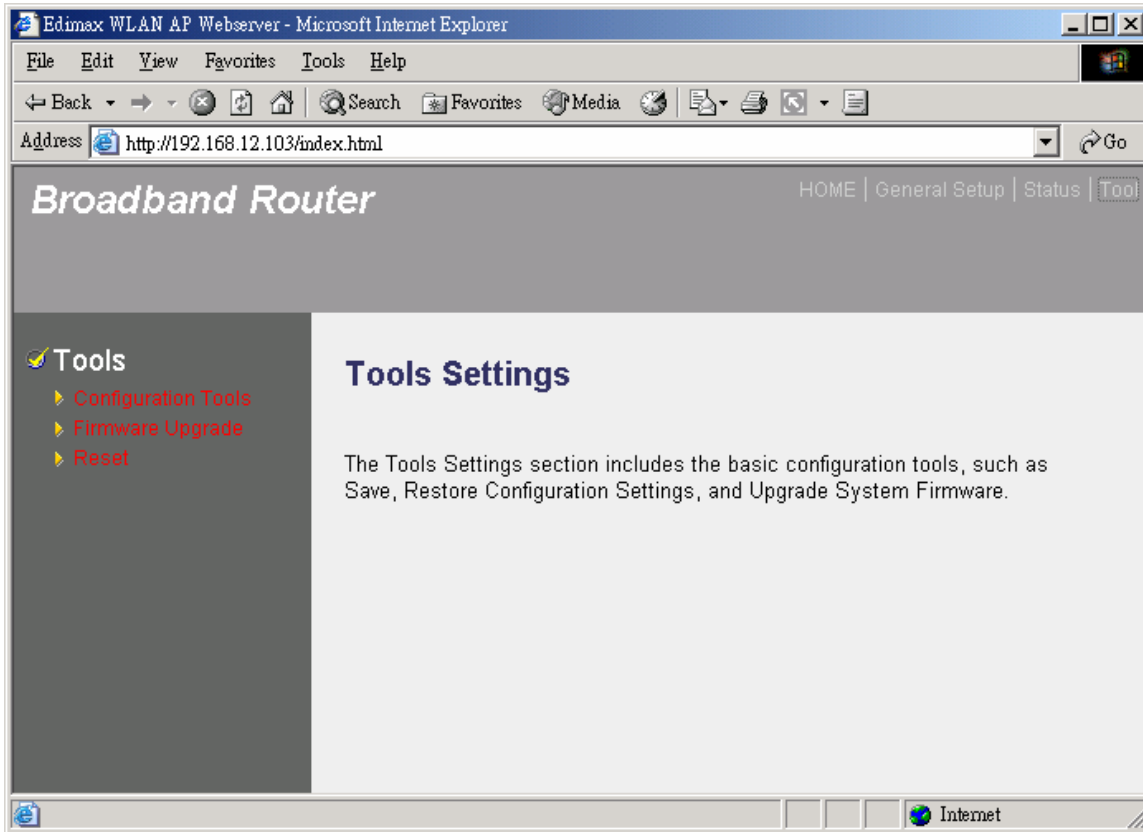

Parameters	Description
4.1 Configuration Tools	You can save the router's current configuration, restore the router's saved configuration files and restore the router's factory default settings
4.2 Firmware Upgrade	This page allows you to upgrade the router's firmware
4.3 Reset	You can reset the router's system should any problem exist

Select one of the above three **Tools Settings** selection and proceed to the manual's relevant sub-section

## 4.1 Configuration Tools

The Configuration Tools screen allows you to save (**Backup**) the router's current configuration setting. Saving the configuration settings provides an added protection and convenience should problems occur with the router and you have to reset to factory default. When you save the configuration setting (Backup) you can re-load the saved configuration into the router through the **Restore** selection. If extreme problems occur you can use the **Restore to Factory Defaults** selection, this will set all configurations to its original default settings (e.g. when you first purchased the router).

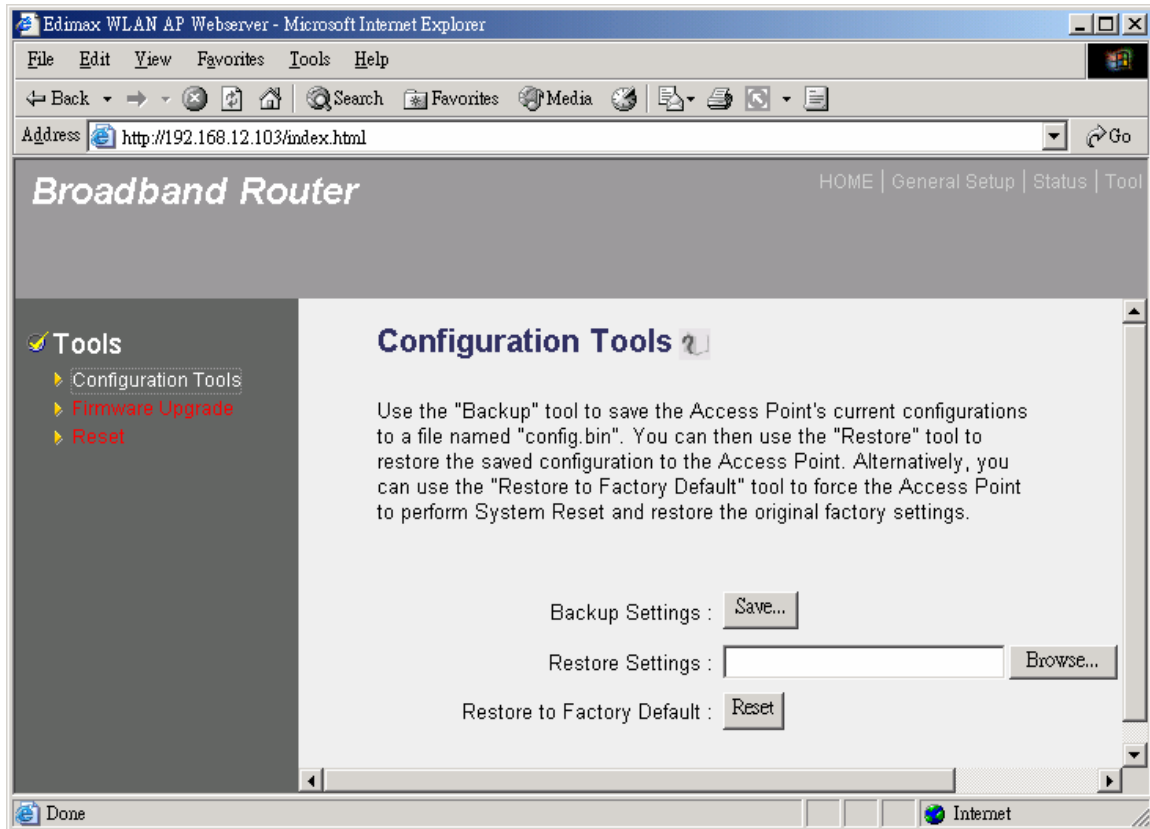

Parameters	Description
Configuration Tools	Use the " <b>Backup</b> " tool to save the Broadband router current configuration to a file named "config.bin" on your PC. You can then use the " <b>Restore</b> " tool to restore the saved configuration to the Broadband router. Alternatively, you can use the " <b>Restore to Factory Defaults</b> " tool to force the Broadband router to perform a power reset and restore the original factory settings.



## 4.2 Firmware Upgrade

This page allows you to upgrade the router's firmware

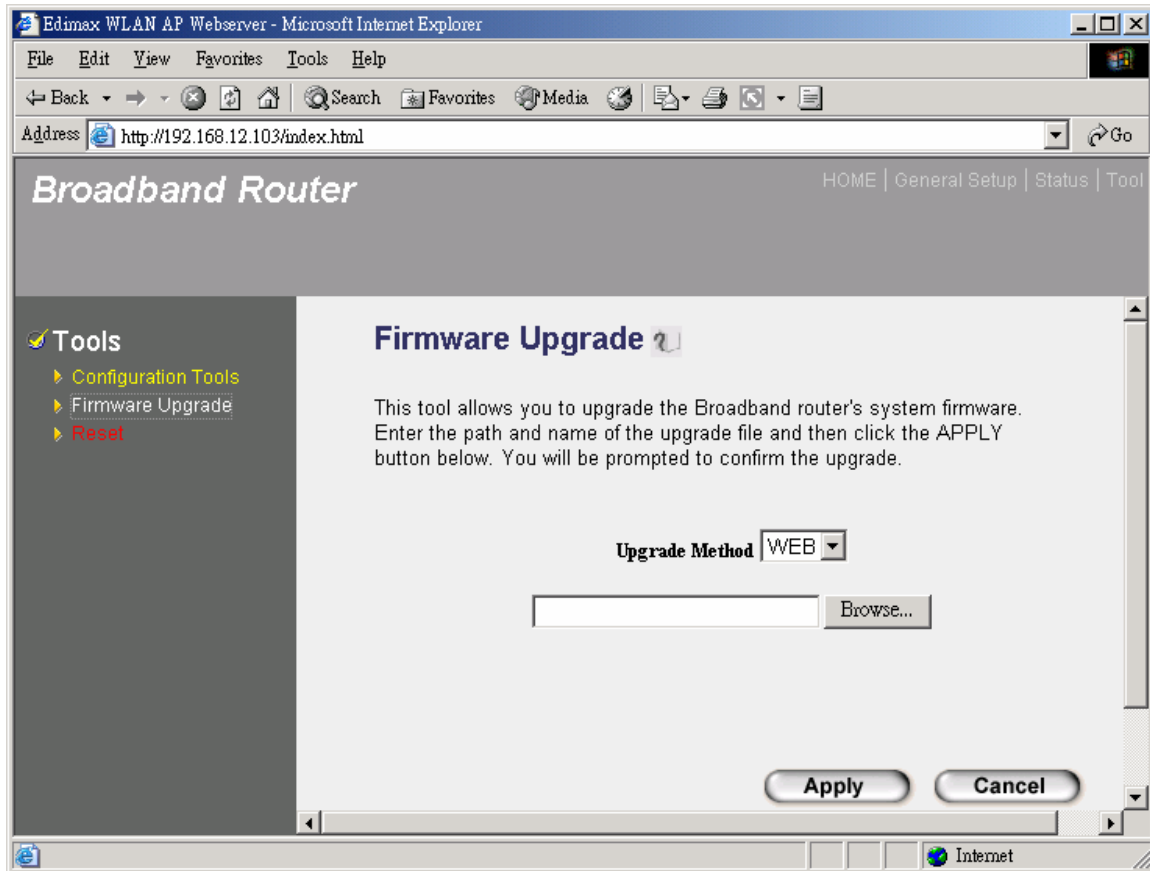

Parameters	Description
Firmware Upgrade	This tool allows you to upgrade the Broadband router's system firmware. To upgrade the firmware of your Broadband router, you need to download the firmware file to your local hard disk, and enter that file name and path in the appropriate field on this page. You can also use the Browse button to find the firmware file on your PC.

Once you've selected the new firmware file, click **<Apply>** at the bottom of the screen to start the upgrade process. (You may have to wait a few minutes for the upgrade to complete). Once the upgrade is complete you can start using the router.

### 4.3 Reset

You can reset the router's system should any problem exist. The reset function essentially Re-boots your router's system

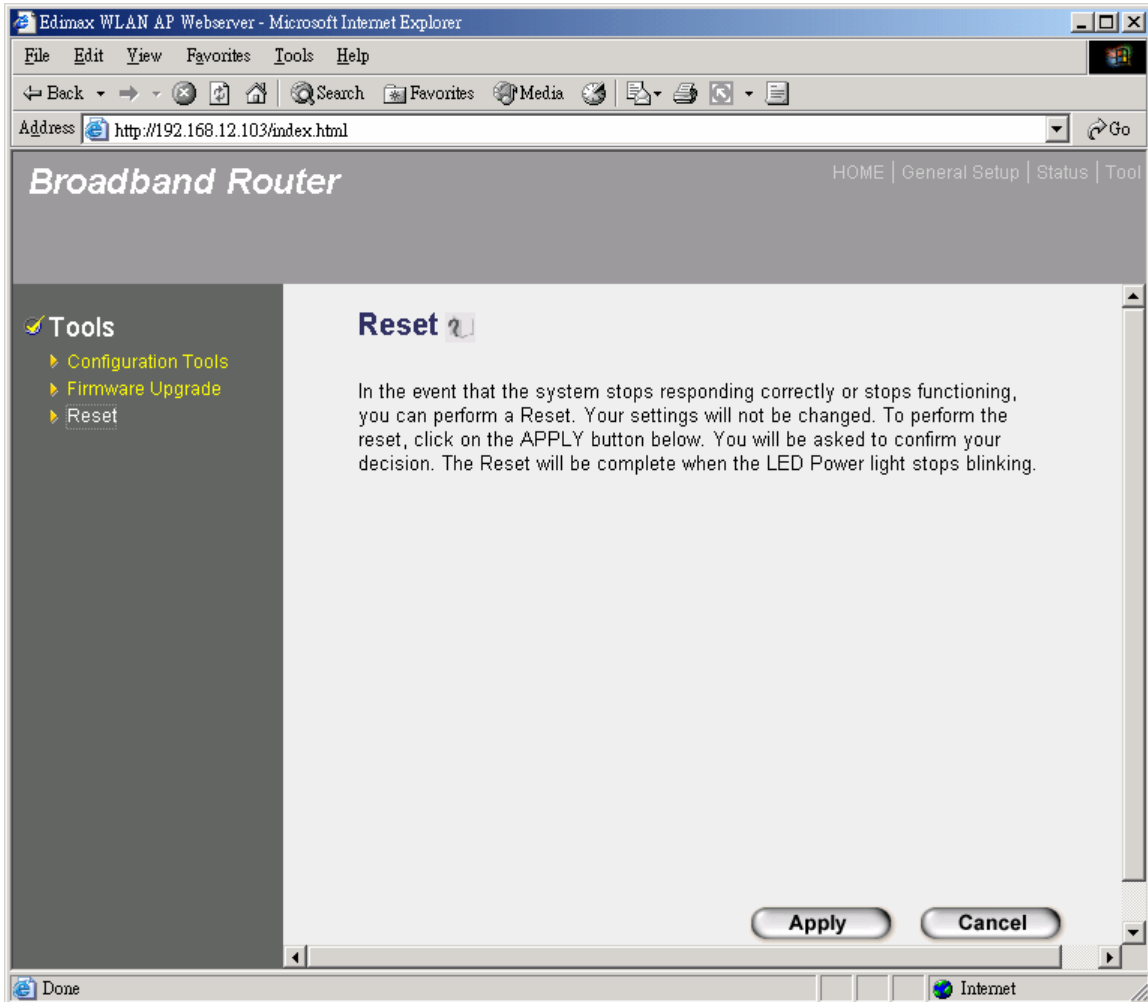

Parameters	Description
Reset	In the event that the system stops responding correctly or in some way stops functioning, you can perform a reset. <b>Your settings will not be changed.</b> To perform the reset, click on the <APPLY> button. You will be asked to confirm your decision. The reset will be complete when the power light stops blinking. Once the reset process is complete you may start using the router again.

## Appendix A

### How to Manually find your PC's IP and MAC address

- 1) In Window's open the Command Prompt program

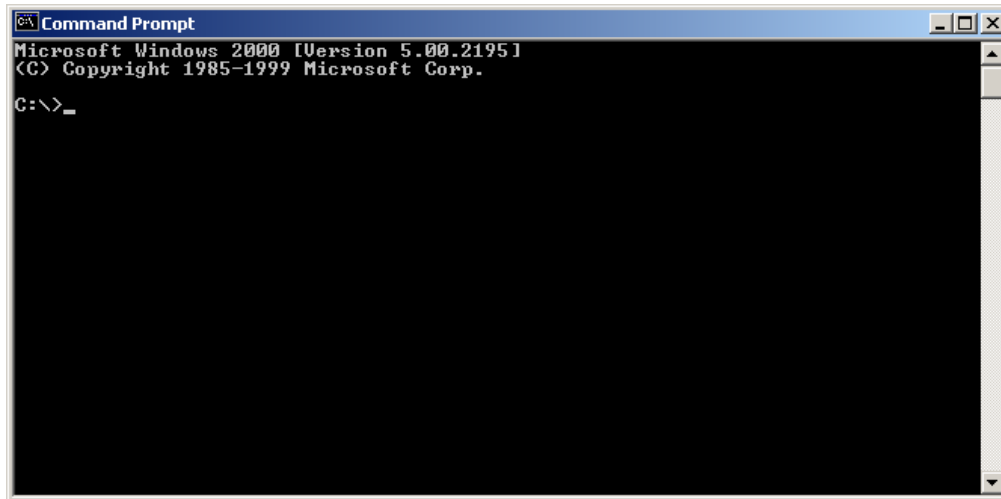

```
Command Prompt
Microsoft Windows 2000 [Version 5.00.2195]
(C) Copyright 1985-1999 Microsoft Corp.
C:\>_
```

- 2) Type **ipconfig /all** and <enter>

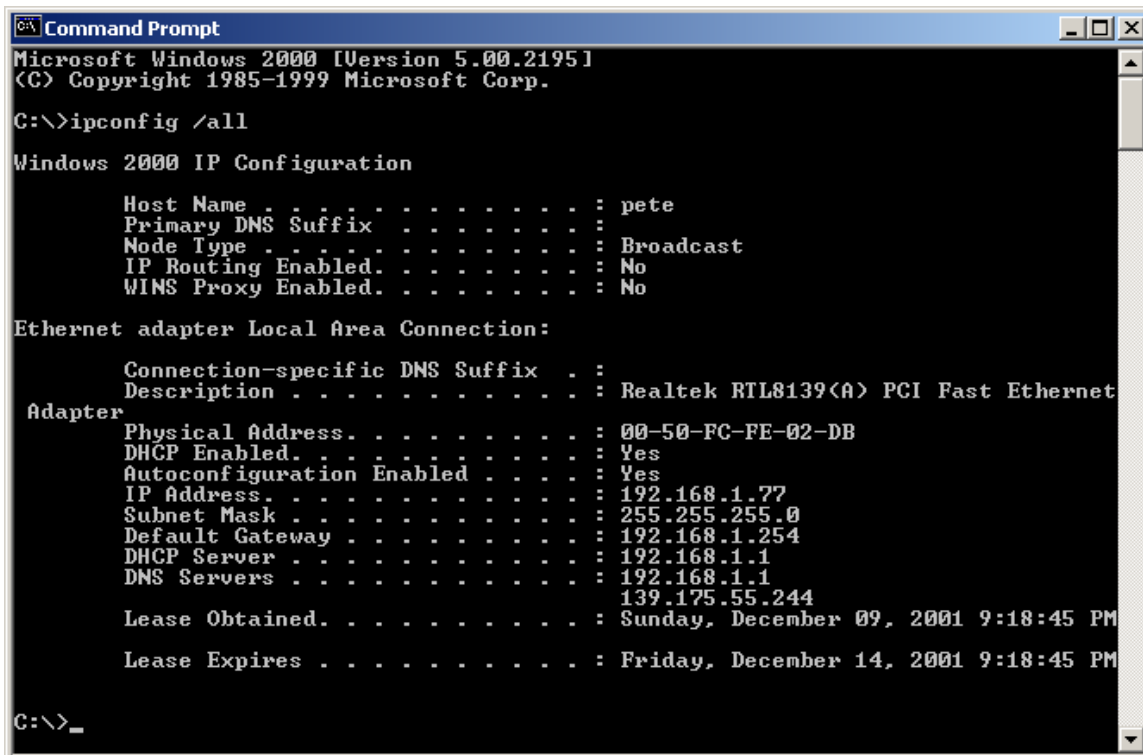

```
Command Prompt
Microsoft Windows 2000 [Version 5.00.2195]
(C) Copyright 1985-1999 Microsoft Corp.
C:\>ipconfig /all

Windows 2000 IP Configuration

    Host Name . . . . . : pete
    Primary DNS Suffix . . . . . :
    Node Type . . . . . : Broadcast
    IP Routing Enabled. . . . . : No
    WINS Proxy Enabled. . . . . : No

Ethernet adapter Local Area Connection:

    Connection-specific DNS Suffix . :
    Description . . . . . : Realtek RTL8139(A) PCI Fast Ethernet
Adapter
    Physical Address. . . . . : 00-50-FC-FE-02-DB
    DHCP Enabled. . . . . : Yes
    Autoconfiguration Enabled . . . . : Yes
    IP Address. . . . . : 192.168.1.77
    Subnet Mask . . . . . : 255.255.255.0
    Default Gateway . . . . . : 192.168.1.254
    DHCP Server . . . . . : 192.168.1.1
    DNS Servers . . . . . : 192.168.1.1
                          139.175.55.244
    Lease Obtained. . . . . : Sunday, December 09, 2001 9:18:45 PM
    Lease Expires . . . . . : Friday, December 14, 2001 9:18:45 PM

C:\>_
```

- Your PC's IP address is the one entitled **IP address** (192.168.1.77)
- The router's IP address is the one entitled **Default Gateway** (192.168.1.254)
- Your PC's MAC Address is the one entitled **Physical Address** (00-50-FC-FE-02-DB)

## Glossary

**Bridge:** A bridge is an intelligent, internetworking device that forwards or filters packets between different networks based on data link layer (MAC) address information.

**Default Gateway (Router):** Every non-router IP device needs to configure a default gateway's IP address. When the device sends out an IP packet, if the destination is not on the same network, the device has to send the packet to its default gateway, which will then send it out towards the destination.

**DHCP:** Dynamic Host Configuration Protocol. This protocol automatically gives every computer on your home network an IP address.

**DNS Server IP Address:** DNS stands for Domain Name System, which allows Internet servers to have a domain name (such as [www.Broadbandrouter.com](http://www.Broadbandrouter.com)) and one or more IP addresses (such as 192.34.45.8). A DNS server keeps a database of Internet servers and their respective domain names and IP addresses, so that when a domain name is requested (as in typing "Broadbandrouter.com" into your Internet browser), the user is sent to the proper IP address. The DNS server IP address used by the computers on your home network is the location of the DNS server your ISP has assigned to you.

**DSL Modem:** DSL stands for Digital Subscriber Line. A DSL modem uses your existing phone lines to transmit data at high speeds.

**Ethernet:** A standard for computer networks. Ethernet networks are connected by special cables and hubs, and move data around at up to 10/100 million bits per second (Mbps).

**Idle Timeout:** Idle Timeout is designed so that after there is no traffic to the Internet for a pre-configured amount of time, the connection will automatically be disconnected.

**IP Address and Network (Subnet) Mask:** IP stands for Internet Protocol. An IP address consists of a series of four numbers separated by periods, that identifies a single, unique Internet computer host in an IP network. Example: 192.168.2.1. It consists of 2 portions: the IP network address, and the host identifier.

The IP address is a 32-bit binary pattern, which can be represented as four cascaded decimal numbers separated by ".": `aaa.aaa.aaa.aaa`, where each "aaa" can be anything from 000 to 255, or as four cascaded binary numbers separated by ".": `bbbbbbbb.bbbbbbbb.bbbbbbbb.bbbbbbbb`, where each "b" can either be 0 or 1.

A network mask is also a 32-bit binary pattern, and consists of consecutive leading 1's followed by consecutive trailing 0's, such as

`11111111.11111111.11111111.00000000`. Therefore sometimes a network mask can also be described simply as "x" number of leading 1's.

When both are represented side by side in their binary forms, all bits in the IP address that correspond to 1's in the network mask become part of the IP network address, and the remaining bits correspond to the host ID.

For example, if the IP address for a device is, in its binary form, `11011001.10110000.10010000.00000111`, and if its network mask is, `11111111.11111111.11110000.00000000`

It means the device's network address is `11011001.10110000.10010000.00000000`, and its host ID is, `00000000.00000000.00000000.00000111`. This is a convenient and efficient method for routers to route IP packets to their destination.

**ISP Gateway Address:** (see ISP for definition). The ISP Gateway Address is an IP address for the Internet router located at the ISP's office.

**ISP:** Internet Service Provider. An ISP is a business that provides connectivity to the Internet for individuals and other businesses or organizations.

**LAN:** Local Area Network. A LAN is a group of computers and devices connected together in a relatively small area (such as a house or an office). Your home network is considered a LAN.

**MAC Address:** MAC stands for Media Access Control. A MAC address is the hardware address of a device connected to a network. The MAC address is a unique identifier for a device with an Ethernet interface. It is comprised of two parts: 3 bytes of data that corresponds to the Manufacturer ID (unique for each manufacturer), plus 3 bytes that are often used as the product's serial number.

**NAT:** Network Address Translation. This process allows all of the computers on your home network to use one IP address. Using the broadband router's NAT capability, you can access the Internet from any computer on your home network without having to purchase more IP addresses from your ISP.

**Port:** Network Clients (LAN PC) uses port numbers to distinguish one network application/protocol over another. Below is a list of common applications and protocol/port numbers:

Application	Protocol	Port Number
Telnet	TCP	23
FTP	TCP	21
SMTP	TCP	25
POP3	TCP	110
H.323	TCP	1720
SNMP	UCP	161
SNMP Trap	UDP	162
HTTP	TCP	80
PPTP	TCP	1723
PC Anywhere	TCP	5631
PC Anywhere	UDP	5632

**PPPoE:** Point-to-Point Protocol over Ethernet. Point-to-Point Protocol is a secure data transmission method originally created for dial-up connections; PPPoE is for Ethernet connections. PPPoE relies on two widely accepted standards, Ethernet and the Point-to-Point Protocol. It is a communications protocol for transmitting information over Ethernet between different manufacturers

**Protocol:** A protocol is a set of rules for interaction agreed upon between multiple parties so that when they interface with each other based on such a protocol, the interpretation of their behavior is well defined and can be made objectively, without confusion or misunderstanding.

**Router:** A router is an intelligent network device that forwards packets between different networks based on network layer address information such as IP addresses.

**Subnet Mask:** A subnet mask, which may be a part of the TCP/IP information provided by your ISP, is a set of four numbers (e.g. 255.255.255.0) configured like an IP address. It is used to create IP address numbers used only within a particular network (as opposed to valid IP address numbers recognized by the Internet, which must be assigned by InterNIC).

**TCP/IP, UDP:** Transmission Control Protocol/Internet Protocol (TCP/IP) and Unreliable Datagram Protocol (UDP). TCP/IP is the standard protocol for data transmission over the Internet. Both TCP and UDP are transport layer protocol. TCP performs proper error detection and error recovery, and thus is reliable. UDP on the other hand is not reliable. They both run on top of the IP (Internet Protocol), a network layer protocol.

**WAN:** Wide Area Network. A network that connects computers located in geographically separate areas (e.g. different buildings, cities, countries). The Internet is a wide area network.

**Web-based management Graphical User Interface (GUI):** Many devices support a graphical user interface that is based on the web browser. This means the user can use the familiar Netscape or Microsoft Internet Explorer to Control/configure or monitor the device being managed.

## Free Manuals Download Website

<http://myh66.com>

<http://usermanuals.us>

<http://www.somanuals.com>

<http://www.4manuals.cc>

<http://www.manual-lib.com>

<http://www.404manual.com>

<http://www.luxmanual.com>

<http://aubethermostatmanual.com>

Golf course search by state

<http://golfingnear.com>

Email search by domain

<http://emailbydomain.com>

Auto manuals search

<http://auto.somanuals.com>

TV manuals search

<http://tv.somanuals.com>