



# Ethernet Hub

## 18-Port Rackmount Ethernet Hub

ER-5398S

### User's Manual



## FCC COMPLIANCE STATEMENT

This equipment generates and uses radio frequency energy and if not installed and used properly, that is, in strict accordance with the instructions provided with the equipment, may cause interference to radio and TV reception. The equipment has been tested and found to comply with the limits for a Class A computing device in accordance with the specifications in Subpart B of Part 15 of FCC rules, which are designed to provide reasonable protection against such interference in a commercial environment. However, there is no guarantee that interference will not occur in a particular installation.

If you suspect this equipment is causing interference, turn your hub on and off while your radio or TV is showing interference to determine the source of the interference.

You can try to correct the interference by one or more of the following measures:

1. Reorient the receiving radio or TV antenna where this may be done safely.
2. To the extent possible, relocate the radio, TV or the other receiver away from the equipment.
3. Plug the computer which has the equipment installed into a different power outlet so that equipment and the receiver are on different branch circuits.

If necessary, you should consult the place of purchase or an experienced radio/television technician for additional suggestion.

**CAUTION** : The phone jack cannot be connected to telephone system.

# Contents

Chapter 1 Introduction .....	1
Chapter 2 Features & Specifications .....	2
Chapter 3 Package Contents .....	3
Chapter 4 Physical Description .....	4
Chapter 5 Installation .....	6
Chapter 6 Trouble-shooting .....	9

# 1 Introduction

Congratulations on your purchase of Edimax's 18-port rackmount Ethernet 10Base-T hub - ER-5398S. Designed to meet small and large 10Base-T network requirements, ER-5398S is built with 16 RJ-45 ports and two extra auto-detect AUI /BNC coaxial ports for cascading other 10Base-T hubs, mixing with thin or thick coaxial segments, or connecting to fiber backbone through fiber transceivers.

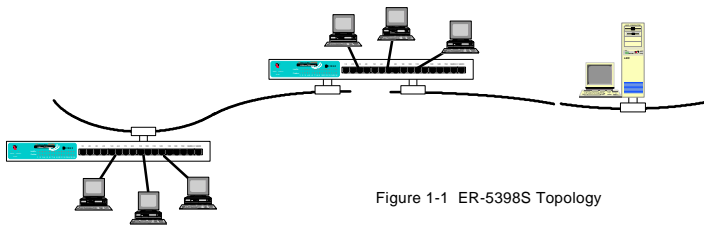

Figure 1-1 ER-5398S Topology

ER-5398S is rackmount size, 1U (1.75 inches) height, it can be installed on an industry standard 19 inches rack.

An uplink port located right next to the 16th RJ-45 port allows easy connection to other hubs or switches using regular straight-through cables as illustrated in Figure 1-2.

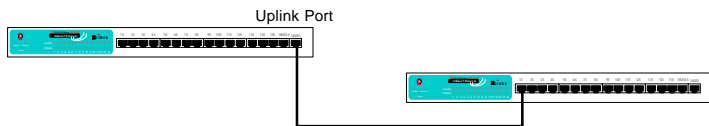

Figure 1-2 Uplink to another hub

To accommodate various cabling requirements, ER-5398S can be easily integrated with other 10Base-T hubs in a central 19-inch wiring rack or be placed separately as stand-alone or distributed workgroup wiring center.

## **2** Features & Specifications

### **(1) Features**

- Comply with IEEE 802.3 10Base-T, 10Base-2 and 10Base-5 Ethernet Standards.
- Support sixteen RJ-45 connectors for 10Base-T connection and two auto-detect 10Base-2 BNC/10Base-5 AUI ports for mixed media network environment.
- Built-in uplink port for easy connection to another hub using regular straight-through cable.
- Complete sets of LEDs provide an easy diagnostic on the hub's and individual port's status.
- Standard 19" rackmount
- Two-year warranty

### **(2) Specification**

- Standards : IEEE 802.3
- 10Mbps Ports : RJ-45 x 16 & AUI /BNC x 2
- Hub LEDs : Power, Collision, Jabber
- Port LEDs : RJ-45 - Link/Receive, Partition
- Dimensions : 17.4 x 5.55 x 1.75 inches/442 x 141 x 44 mm
- Weight : 4.04 lb./1.833kg
- Power : external full-range, 110-240V AC, 50-60Hz
- Operating Temperature : 32-131°F (0-55°C)
- Operating Humidity : 10-95% (Noncondensing)
- Emission : FCC Class A & CE Mark

### 3 Package Contents

- 18-port rackmount Ethernet Hub
- One power cord
- Two T-Connectors
- Rackmount accessories
- User's manual

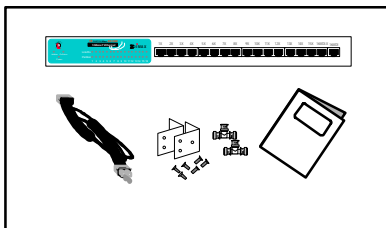

Figure 3-1 Package contents

# 4 Physical Description

## (1) Panel

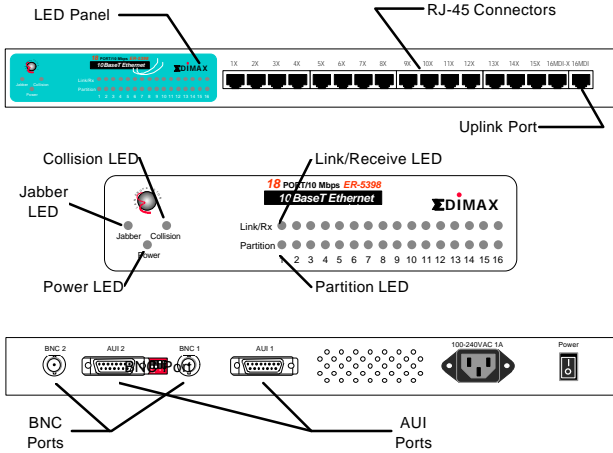

Figure 4-1 Panel description

## (2) LED

LED	Color	Status	Description
Power	Green	Lit	Power is supplied
		Off	No power
Collision	Yellow	Lit	Collision detected in this segment
		Off	No Collision
Jabber	Red	Lit	Jabber detected in this segment
		Off	No Jabber
Link/Rx (Link/Receive)	Green	Lit	A valid link is established
		Flash	Data packets received
		Off	No link is established
Partition	Red	Lit	This port is partitioned
		Off	This port is working normally

Table 4-1 LED description



## 5 Installation

### 1. Operating Environment

ER-5398S must be installed and operated within the limits of specified operating temperature and humidity (see previous section under Specifications). Do not place objects on top of the unit. Do not obstruct any vents at the sides of the unit. Do not position the hub near any heating source such as heater, radiator, or direct exposure to sun. Prevent entering of water and moisture into the unit. If necessary, use dehumidifier to reduce humidity.

### 2. Connecting to network devices with UTP cable

Connect one end of the network cable to any of the RJ-45 ports on the front panel of ER-5398S, and connect the other end of the network cable to the RJ-45 port of the network device. The network cables must comply with EIA/TIA 568 specifications and minimum Category 3 standard for 10Mbps data transmission. Maximum length between the hub and workstation is 100 meters (300ft). Once the network cable is connected on both ends and the attached network devices are powered on, the green LNK/Rx (Link Status) LED should be lit.

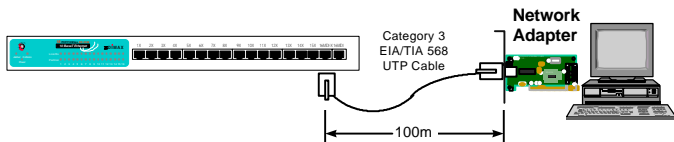

Figure 5-1 Connect the hub and network device

### 3. Uplink to Another Hub with UTP cable

Use uplink port to connect to another hub as illustrated in Figure 1-2. Connect one end of the network cable to the uplink port and connect the other end to any of the regular port in the other hub (except the uplink port). Connecting cable must comply with EIA/TIA 568 specifications and Category 3 standards to connect the hubs. Once the network cable is connected and both hubs are powered on, the green LNK/Rx (Link Status) LED should be lit. The maximum length of the uplink cable shall not exceed 100 meters (300 feet).

NOTE: Do not use the uplink port and 16th port at the same time.

#### 4. Connecting network devices with coaxial cables

ER-5398S provides two auto-detect BNC/AUI coaxial ports, each can function as either BNC or as AUI but can be used at the same time. A set of configuration DIP switches are located between port 1 and port 2, they can be used to configure the coaxial port as auto-detect, BNC only or AUI only as illustrated in Figure 5-2 and Table 5-1.



Figure 5-2 DIP Switch for AUI/BNC port

Port 1	Port 2	1	2
Auto	Auto	ON	ON
AUI	BNC	ON	OFF
BNC	AUI	OFF	ON
AUI	AUI	OFF	OFF

Table 5-1 DIP Switch configuration for AUI/BNC port

NOTE : The default setting is auto-detect mode.

When using the BNC port, attach the T-connector to the BNC port on the rear panel and connect the coaxial cables to the both open ends of the T-connector as illustrated in Figure 5-3. If the ER-5398S is at either end of the coaxial segment, make sure terminate the open end of T-connector with a 50-ohm terminator. When using the AUI port, firmly attach the AUI transceiver to the AUI port and secure the transceiver into the socket.

Note : Do not connect coaxial cable directly to the BNC port without using T-connector.

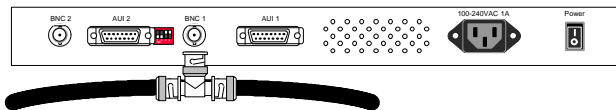

Figure 5-3 Connect the coaxial cables

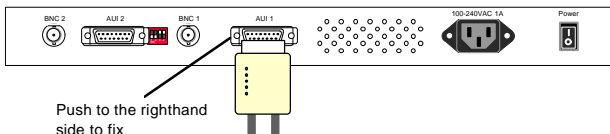

Figure 5-4 Connect the AUI transceiver

## 5. Connecting the power

Connect the power cord to the power socket on the rear panel of the unit. Connect the power cord to the power outlet and turn on power switch. The green Power LED on the front panel should be lit.

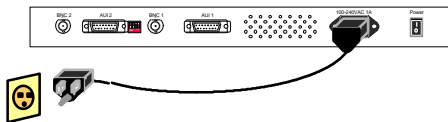

Figure 5-5 Connect the power

## **6** Troubleshooting

### **1. Power LED is not lit**

- Check if the power cord is properly connected to the power outlet and the hub. Make sure the power switch on the hub is turned ON.

### **2. LNK/Rx LED is not lit after connecting to an active workstation**

- Check the power switch of the network devices attached to the hub; make sure they are turned ON.
- Check the network cable; make sure it is properly connected to the hub and the network device.
- Check the network cable; make sure the cable complies with EIA/TIA 568 specification. Use straight-through minimum Category 3 grade cables.
- Do not use uplink port to connect to a workstation.

### **3. Uplink (16th) port's LNK/Rx LED is not lit after uplink to another hub**

- Check the network cable; make sure it is properly connected to both hubs. One end of the cable should be connected to uplink port while the other end of the cable should be connected to a regular port. Do not connect the cable to both uplink ports.
- Check the network cable; make sure the cable complies with EIA/TIA 568 specification.
- Check the length of the network cable does not exceed 100 meters (300 feet).
- Make sure both hubs are powered ON.

### **4. AUI/BNC ports do not transmit**

- Check the DIP switch setting.
- Check the AUI transceiver; make sure the SQE is set at OFF.
- Check the attachment of coaxial cable; make sure there's no loose connection.
- Check the coaxial cable; make sure the segment is terminated with 50-ohm terminator.

#### **5. Partition LED is lit**

- Check the connected devices. The hub will automatically partition a defective Ethernet device which causing excessive errors.

#### **6. Collision LED is constantly flashing**

- Remove all the network cables; connect the cables back one by one to isolate the source of the collision.
- Check the network cable, inferior cable quality will result in excessive collision and error packets.

#### **7. Jabber LED is constantly flashing**

- Check the connected devices. Remove all the network cables; connect the cables back one by one to isolate the source of the jabber.

**[!] Contact your dealer if problem persist.**

## Free Manuals Download Website

<http://myh66.com>

<http://usermanuals.us>

<http://www.somanuals.com>

<http://www.4manuals.cc>

<http://www.manual-lib.com>

<http://www.404manual.com>

<http://www.luxmanual.com>

<http://aubethermostatmanual.com>

Golf course search by state

<http://golfingnear.com>

Email search by domain

<http://emailbydomain.com>

Auto manuals search

<http://auto.somanuals.com>

TV manuals search

<http://tv.somanuals.com>