

FireWire AudioCapture FA-101

Owner's Manual

Before using this unit, carefully read the sections entitled: "USING THE UNIT SAFELY" and "IMPORTANT NOTES" (p. 3-p. 5). These sections provide important information concerning the proper operation of the unit. Additionally, in order to feel assured that you have gained a good grasp of every feature provided by your new unit, Owner's manual should be read in its entirety. The manual should be saved and kept on hand as a convenient reference.

FA-101 Internal block

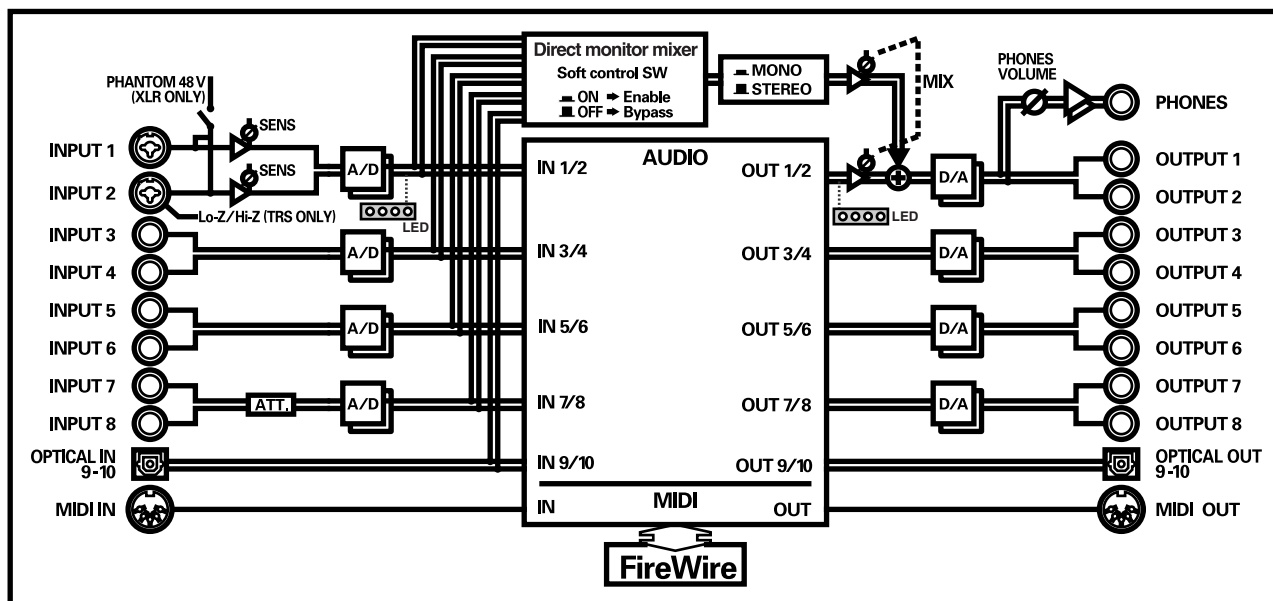

Copyright © 2004 ROLAND CORPORATION

All rights reserved. No part of this publication may be reproduced in any form without the written permission of ROLAND CORPORATION.

For the U.K.

IMPORTANT: THE WIRES IN THIS MAINS LEAD ARE COLOURED IN ACCORDANCE WITH THE FOLLOWING CODE.

BLUE: NEUTRAL
BROWN: LIVE

As the colours of the wires in the mains lead of this apparatus may not correspond with the coloured markings identifying the terminals in your plug, proceed as follows:

The wire which is coloured BLUE must be connected to the terminal which is marked with the letter N or coloured BLACK.
The wire which is coloured BROWN must be connected to the terminal which is marked with the letter L or coloured RED.
Under no circumstances must either of the above wires be connected to the earth terminal of a three pin plug.



For EU Countries

This product complies with the requirements of European Directive 89/336/EEC.

For the USA

FEDERAL COMMUNICATIONS COMMISSION RADIO FREQUENCY INTERFERENCE STATEMENT

This equipment has been tested and found to comply with the limits for a Class B digital device, pursuant to Part 15 of the FCC Rules. These limits are designed to provide reasonable protection against harmful interference in a residential installation. This equipment generates, uses, and can radiate radio frequency energy and, if not installed and used in accordance with the instructions, may cause harmful interference to radio communications. However, there is no guarantee that interference will not occur in a particular installation. If this equipment does cause harmful interference to radio or television reception, which can be determined by turning the equipment off and on, the user is encouraged to try to correct the interference by one or more of the following measures:

- Reorient or relocate the receiving antenna.
- Increase the separation between the equipment and receiver.
- Connect the equipment into an outlet on a circuit different from that to which the receiver is connected.
- Consult the dealer or an experienced radio/TV technician for help.

This device complies with Part 15 of the FCC Rules. Operation is subject to the following two conditions:

- (1) This device may not cause harmful interference, and
- (2) This device must accept any interference received, including interference that may cause undesired operation.

Tested To Comply With FCC Standards

FOR HOME OR OFFICE USE

Unauthorized changes or modification to this system can void the users authority to operate this equipment.
This equipment requires shielded interface cables in order to meet FCC class B Limit.

For Canada

NOTICE

This Class B digital apparatus meets all requirements of the Canadian Interference-Causing Equipment Regulations.

AVIS

Cet appareil numérique de la classe B respecte toutes les exigences du Règlement sur le matériel brouilleur du Canada.

For the USA



DECLARATION OF CONFORMITY Compliance Information Statement

Model Name : FA-101
Type of Equipment : FireWire Audio Capture
Responsible Party : Roland Corporation U.S.
Address : 5100 S. Eastern Avenue Los Angeles, CA 90040-2938
Telephone : (323) 890 3700







USING THE UNIT SAFELY

INSTRUCTIONS FOR THE PREVENTION OF FIRE, ELECTRIC SHOCK, OR INJURY TO PERSONS

About  WARNING and  CAUTION Notices









 WARNING	Used for instructions intended to alert the user to the risk of death or severe injury should the unit be used improperly.
 CAUTION	Used for instructions intended to alert the user to the risk of injury or material damage should the unit be used improperly. * Material damage refers to damage or other adverse effects caused with respect to the home and all its furnishings, as well to domestic animals or pets.

About the Symbols







	The  symbol alerts the user to important instructions or warnings. The specific meaning of the symbol is determined by the design contained within the triangle. In the case of the symbol at left, it is used for general cautions, warnings, or alerts to danger.
	The  symbol alerts the user to items that must never be carried out (are forbidden). The specific thing that must not be done is indicated by the design contained within the circle. In the case of the symbol at left, it means that the unit must never be disassembled.
	The  symbol alerts the user to things that must be carried out. The specific thing that must be done is indicated by the design contained within the circle. In the case of the symbol at left, it means that the power-cord plug must be unplugged from the outlet.

ALWAYS OBSERVE THE FOLLOWING

WARNING

- Before using this unit, make sure to read the instructions below, and the Owner's Manual. 
- Do not open or perform any internal modifications on the unit or its AC adaptor. 
- Do not attempt to repair the unit, or replace parts within it (except when this manual provides specific instructions directing you to do so). Refer all servicing to your retailer, the nearest Roland Service Center, or an authorized Roland distributor, as listed on the "Information" page. 
- Never use or store the unit in places that are:
 - Subject to temperature extremes (e.g., direct sunlight in an enclosed vehicle, near a heating duct, on top of heat-generating equipment); or are 
 - Damp (e.g., baths, washrooms, on wet floors); or are 
 - Humid; or are
 - Exposed to rain; or are
 - Dusty; or are
 - Subject to high levels of vibration. 
- Make sure you always have the unit placed so it is level and sure to remain stable. Never place it on stands that could wobble, or on inclined surfaces. 
- Be sure to use only the AC adaptor supplied with the unit. Also, make sure the line voltage at the installation matches the input voltage specified on the AC adaptor's body. Other AC adaptors may use a different polarity, or be designed for a different voltage, so their use could result in damage, malfunction, or electric shock. 

WARNING

- Use only the attached power-supply cord. Also, the supplied power cord must not be used with any other device. 
- Do not excessively twist or bend the power cord, nor place heavy objects on it. Doing so can damage the cord, producing severed elements and short circuits. Damaged cords are fire and shock hazards! 
- This unit, either alone or in combination with an amplifier and headphones or speakers, may be capable of producing sound levels that could cause permanent hearing loss. Do not operate for a long period of time at a high volume level, or at a level that is uncomfortable. If you experience any hearing loss or ringing in the ears, you should immediately stop using the unit, and consult an audiologist. 
- Do not allow any objects (e.g., flammable material, coins, pins); or liquids of any kind (water, soft drinks, etc.) to penetrate the unit. 
- In households with small children, an adult should provide supervision until the child is capable of following all the rules essential for the safe operation of the unit. 
- Protect the unit from strong impact. (Do not drop it!) 

WARNING

- Immediately turn the power off, remove the AC adaptor from the outlet, and request servicing by your retailer, the nearest Roland Service Center, or an authorized Roland distributor, as listed on the "Information" page when:
 - The AC adaptor, the power-supply cord, or the plug has been damaged; or
 - If smoke or unusual odor occurs
 - Objects have fallen into, or liquid has been spilled onto the unit; or
 - The unit has been exposed to rain (or otherwise has become wet); or
 - The unit does not appear to operate normally or exhibits a marked change in performance.
- Do not force the unit's power-supply cord to share an outlet with an unreasonable number of other devices. Be especially careful when using extension cords—the total power used by all devices you have connected to the extension cord's outlet must never exceed the power rating (watts/amperes) for the extension cord. Excessive loads can cause the insulation on the cord to heat up and eventually melt through.
- Before using the unit in a foreign country, consult with your retailer, the nearest Roland Service Center, or an authorized Roland distributor, as listed on the "Information" page.
- DO NOT play a CD-ROM disc on a conventional audio CD player. The resulting sound may be of a level that could cause permanent hearing loss. Damage to speakers or other system components may result.

CAUTION

- The unit and the AC adaptor should be located so their location or position does not interfere with their proper ventilation.
- Always grasp only the plug on the AC adaptor cord when plugging into, or unplugging from, an outlet or this unit.
- At regular intervals, you should unplug the AC adaptor and clean it by using a dry cloth to wipe all dust and other accumulations away from its prongs. Also, disconnect the power plug from the power outlet whenever the unit is to remain unused for an extended period of time. Any accumulation of dust between the power plug and the power outlet can result in poor insulation and lead to fire.
- Try to prevent cords and cables from becoming entangled. Also, all cords and cables should be placed so they are out of the reach of children.
- Never climb on top of, nor place heavy objects on the unit.
- Never handle the AC adaptor or its plugs with wet hands when plugging into, or unplugging from, an outlet or this unit.
- Before moving the unit, disconnect the AC adaptor and all cords coming from external devices.
- Before cleaning the unit, turn off the power and unplug the AC adaptor from the outlet.
- Whenever you suspect the possibility of lightning in your area, disconnect the AC adaptor from the outlet.
- Should you remove the ground terminal screw, make sure to put them in a safe place out of children's reach, so there is no chance of them being swallowed accidentally.
- Always turn the phantom power off when connecting any device other than condenser microphones that require phantom power. You risk causing damage if you mistakenly supply phantom power to dynamic microphones, audio playback devices, or other devices that don't require such power. Be sure to check the specifications of any microphone you intend to use by referring to the manual that came with it.

(This instrument's phantom power: 48 V DC, 20 mA Max)

IMPORTANT NOTES

In addition to the items listed under “USING THE UNIT SAFELY” on page 3, please read and observe the following:

Power Supply

- Do not connect this unit to same electrical outlet that is being used by an electrical appliance that is controlled by an inverter (such as a refrigerator, washing machine, microwave oven, or air conditioner), or that contains a motor. Depending on the way in which the electrical appliance is used, power supply noise may cause this unit to malfunction or may produce audible noise. If it is not practical to use a separate electrical outlet, connect a power supply noise filter between this unit and the electrical outlet.
- The AC adaptor will begin to generate heat after long hours of consecutive use. This is normal, and is not a cause for concern.
- Before connecting this unit to other devices, turn off the power to all units. This will help prevent malfunctions and/or damage to speakers or other devices.

Placement

- Using the unit near power amplifiers (or other equipment containing large power transformers) may induce hum. To alleviate the problem, change the orientation of this unit; or move it farther away from the source of interference.
- This device may interfere with radio and television reception. Do not use this device in the vicinity of such receivers.
- Noise may be produced if wireless communications devices, such as cell phones, are operated in the vicinity of this unit. Such noise could occur when receiving or initiating a call, or while conversing. Should you experience such problems, you should relocate such wireless devices so they are at a greater distance from this unit, or switch them off.
- When moved from one location to another where the temperature and/or humidity is very different, water droplets (condensation) may form inside the unit. Damage or malfunction may result if you attempt to use the unit in this condition. Therefore, before using the unit, you must allow it to stand for several hours, until the condensation has completely evaporated.

Maintenance

- For everyday cleaning wipe the unit with a soft, dry cloth or one that has been slightly dampened with water. To remove stubborn dirt, use a cloth impregnated with a mild, non-abrasive detergent. Afterwards, be sure to wipe the unit thoroughly with a soft, dry cloth.
- Never use benzene, thinners, alcohol or solvents of any kind, to avoid the possibility of discoloration and/or deformation.

Additional Precautions

- Unfortunately, it may be impossible to restore the contents of data that was stored hard disk once it has been lost. Roland Corporation assumes no liability concerning such loss of data.
- Use a reasonable amount of care when using the unit's buttons, sliders, or other controls; and when using its jacks and connectors. Rough handling can lead to malfunctions.
- When connecting / disconnecting all cables, grasp the connector itself—never pull on the cable. This way you will avoid causing shorts, or damage to the cable's internal elements.
- To avoid disturbing your neighbors, try to keep the unit's volume at reasonable levels. You may prefer to use headphones, so you do not need to be concerned about those around you (especially when it is late at night).
- When you need to transport the unit, package it in the box (including padding) that it came in, if possible. Otherwise, you will need to use equivalent packaging materials.
- Use a cable from Roland to make the connection. If using some other make of connection cable, please note the following precautions.
 - Some connection cables contain resistors. Do not use cables that incorporate resistors for connecting to this unit. The use of such cables can cause the sound level to be extremely low, or impossible to hear. For information on cable specifications, contact the manufacturer of the cable.
- Unauthorized duplication, reproduction, hiring, and lending prohibited.

Handling CD-ROMs

- Avoid touching or scratching the shiny underside (encoded surface) of the disc. Damaged or dirty CD-ROM discs may not be read properly. Keep your discs clean using a commercially available CD cleaner.

Copyright

- Unauthorized recording, distribution, sale, lending, public performance, broadcasting, or the like, in whole or in part, of a work (musical composition, video, broadcast, public performance, or the like) whose copyright is held by a third party is prohibited by law.
- When exchanging audio signals through a digital connection with an external instrument, this unit can perform recording without being subject to the restrictions of the Serial Copy Management System (SCMS). This is because the unit is intended solely for musical production, and is designed not to be subject to restrictions as long as it is used to record works (such as your own compositions) that do not infringe on the copyrights of others. (SCMS is a feature that prohibits second-generation and later copying through a digital connection. It is built into MD recorders and other consumer digital-audio equipment as a copyright-protection feature.)
- Do not use this unit for purposes that could infringe on a copyright held by a third party. We assume no responsibility whatsoever with regard to any infringements of third-party copyrights arising through your use of this unit.

- * Microsoft and Windows are registered trademarks of Microsoft Corporation.
- * The screen shots in this document are used in compliance with the guidelines of the Microsoft Corporation.
- * Windows® is known officially as: "Microsoft® Windows® operating system."
- * Apple and Macintosh are registered trademark of Apple Computer, Inc.
- * MacOS is a trademark of Apple Computer, Inc.
- * All product names mentioned in this document are trademarks or registered trademarks of their respective owners.

Contents

Contents of the package	8
Front and rear panel	9
Front panel	9
Rear panel.....	12
Installing the driver (Macintosh).....	14
Driver settings	14
Checking that you hear sound	16
Installing the driver (Windows).....	17
Giving priority to background services.....	21
Driver settings	22
Basic connections and settings	25
Basic connections	25
Recording a mic or guitar	26
Recording a digital signal	28
Connecting various types of equipment.....	29
Software settings	30
SONAR 3	30
Digital Performer	32
Cubase SX/SL.....	33
Logic.....	34
FA-101 Driver Settings dialog box (Windows).....	35
Troubleshooting.....	37
Main Specifications	46
Index.....	47

Contents of the package

■ FA-101

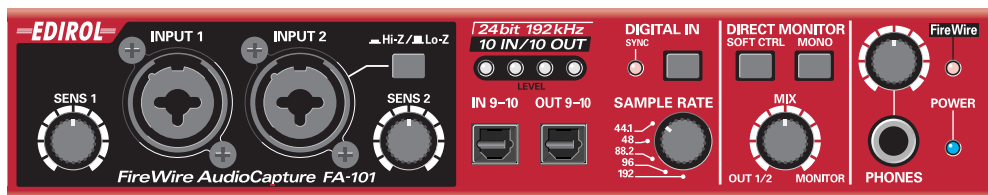

■ AC adaptor

This is the dedicated AC adaptor for the FA-101. Use only the supplied AC adaptor.

■ FireWire (IEEE 1394) cables

(one 6-pin ↔ 6-pin cable, one 6-pin ↔ 4-pin cable)

Use one of these cables to connect the FA-101 to the IEEE 1394 connector (FireWire connector, iLink connector, DV connector) of your computer.

NOTE The 6-pin ↔ 4-pin cable cannot supply bus power.

* Use only the FireWire (IEEE 1394) cables. If the supplied FireWire (IEEE 1394) cable becomes damaged or lost and you need a replacement, please contact the nearest Roland Service Center, or an authorized Roland distributor, as listed on the "Information" page.

■ Owner's manual

This is the manual you are reading. Please keep it at hand for reference.

■ CD-ROM

This contains drivers for the FA-101 and demo songs.

* Be careful not to touch or scratch the recorded surface (unprinted surface) of the disc. Doing so may render the disc unreadable. If the disc gets dirty, use a commercially available CD cleaner to clean it.

CAUTION Do not play back the CD-ROM in a conventional audio CD player. Doing so may produce high-volume sound that can damage your hearing and/or speakers. 

Front and rear panel

Front panel

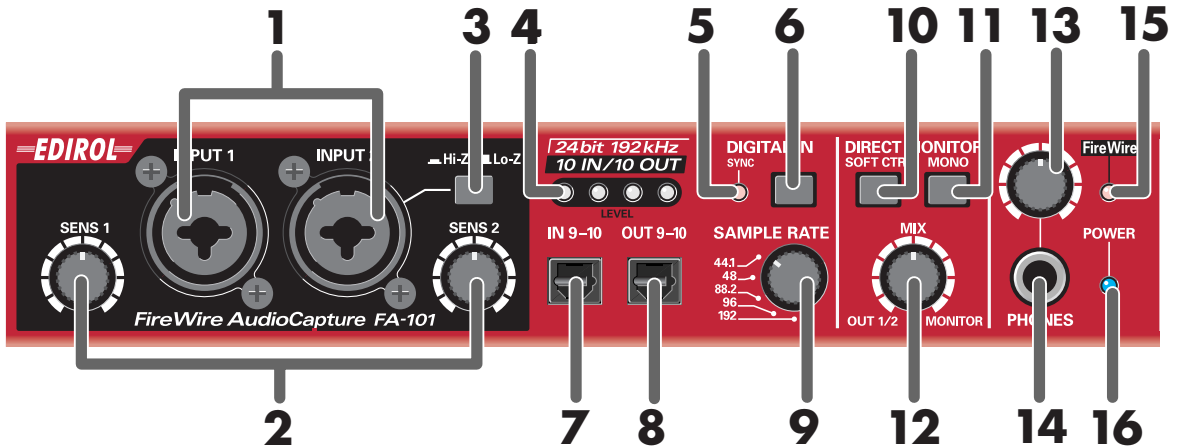

1. Combo input jacks

These are analog audio input jacks with mic preamps. They accommodate either XLR or phone plugs, allowing you to connect a variety of equipment. Either balanced or unbalanced signals may be connected.

Phantom power (48 V) is provided for XLR type connections, allowing you to connect condenser mics that require phantom power. In this case, turn on the **phantom power switch (19)** located on the rear panel.

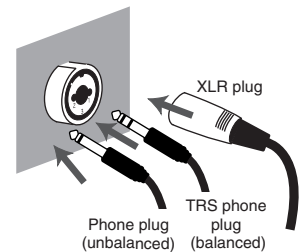

* This instrument is equipped with balanced (XLR/TRS) type input jacks. Wiring diagrams for these jacks are shown on the right. Make connections after first checking the wiring diagrams of other equipment you intend to connect.

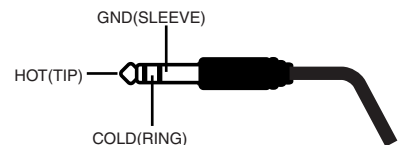

2. Input sensitivity knobs

These adjust the input level of the signals input to the front panel **combo input jacks (1)**.

3. Input impedance select switch

This switch selects either high impedance (Hi-Z) or low impedance (Lo-Z) as the type of device connected to the **INPUT 2** phone jack of the **combo input jacks (1)**. If you have connected a guitar or bass to this jack, select the high impedance (Hi-Z) setting; if you have connected a mic, select the low impedance (Lo-Z) setting.

* **Combo input jack INPUT 1** is fixed at low impedance (Lo-Z).

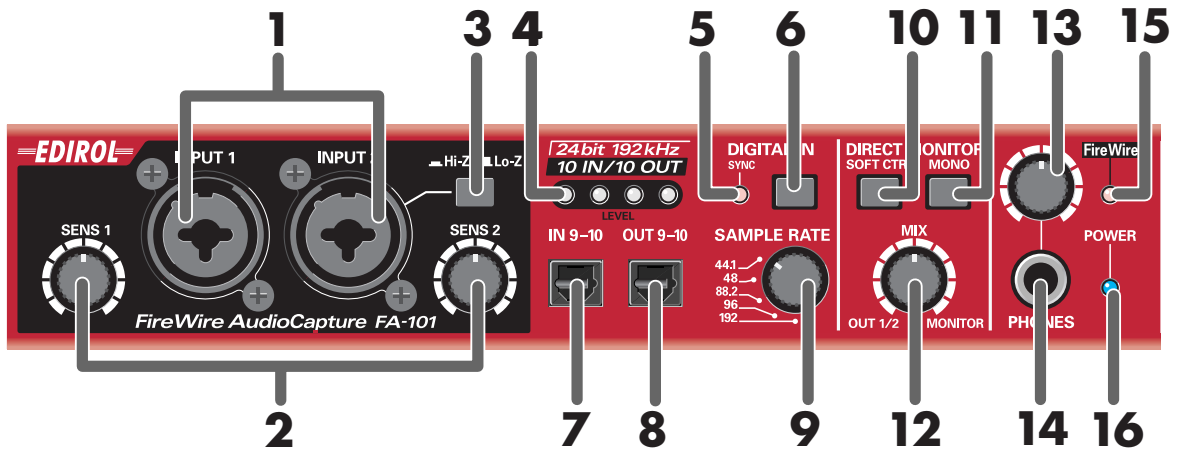

4. Input/output level indicators

These LEDs light according to the level of the signals that are being input via the combo **input jacks (1)** and WAVE OUT 1/2 (in the case of WDM, **OUTPUT 1** → see p. 22). (see block diagram → front cover)
To adjust the input level, stop playback of the sound from your computer.

When functioning as input level indicators	The red LED will light if the sound distorts. Use the input level knobs (2) to adjust the input level so that the red LED does not light.
When functioning as output level indicators	The red LED will light, but the sound is not distorting. * When operating at 192 kHz, the indicator will light only for input; it will not light for output.

5. Sync indicator

When the **digital input switch (6)** is on, this indicator shows the status of synchronization with a digital device connected to the **digital input connector (7)**. (external synchronization mode)

Lit green	Synchronized correctly.
Blinking green	Not synchronized. Check that your digital device is correctly connected to the digital input connector. Also make sure that the connected digital device is set to the same sampling frequency as that selected by the FA-101's sample rate select switch (9) .

6. Digital input switch

If you want to record a digital input, turn this on (↓ pressed inward). This lets the FA-101 synchronize to an external digital device connected to the **digital input connector (7)**.

7. Digital input connector (optical)

Use this when you want to input a digital audio signal from a CD/MD/DAT or similar device.

The signal input to the digital input connector is input as **INPUT 9** and **10** (in the case of WDM, **INPUT 5** → see p. 22).

If you want to record this digital input signal, turn on the **digital input switch (6)**.

You must input a signal of the same sampling frequency as that selected by the **sample rate select switch (9)**.

8. Digital output connector (optical)

Use this when you want to digitally connect an audio device, such as an MD or DAT unit.

The digital signal sent from the **digital output connector** is output as **OUTPUT 9** and **10** (in the case of WDM, **OUTPUT 5** → see p. 22).

9. Sample rate select switch

This specifies the sampling frequency at which audio data will be recorded and played back. In order to get this setting to take effect, you must exit all of your software, then cycle the power to the FA-101 (switch it off, then back on again).

* If you are using Macintosh and want to change the sampling frequency, you must first power down the FA-101. Then, access the Mac OS **System Preferences – Sound**, and verify that **EDIROL FA-101** has disappeared from the **Input** and **Output** panes. Then, power up the FA-101 again. For information on how to display the Mac OS **System Preferences – Sound**, refer to **“Input/output device settings”** (p. 14).

You must set the **sample rate select switch** to match the sampling frequency selected in the software you are using. If you use external synchronization mode (i.e., the DIGITAL IN switch turned on), the external device’s sampling frequency must also be the same.

[Limitations when using the FA-101 at 192 kHz]

- **Input/output level indicators**
The **input/output level indicators (4)** will not function during output.
- **Direct monitor**
You can monitor only the signal input through the **combo input jacks (1)**.

10. Direct monitor soft control switch (direct monitor mixer section)

Turn this on (⏏ pressed inward) if you want to control the direct monitor mixer (see block diagram → front cover) from your ASIO 2.0 compatible software. If this is on, your software will be able to control the monitor volume, pan, and on/off status of each input jack.

If this is off, all settings of the direct monitor mixer will be ignored (= bypassed), allowing you to monitor the input signals from all input jacks. This is convenient if you want to check the connections while temporarily ignoring the software settings.

* This function is available only on Windows.

11. STEREO/MONO select switch (direct monitor section)

This selects whether the input signal will be monitored in stereo (STEREO) or monaural (MONO). Turn this on (⏏ pressed inward) if you want to monitor in monaural.

Even if this is set to monaural (MONO), the audio signal is sent via FireWire (IEEE 1394) to your computer in stereo.

12. Direct monitor volume (direct monitor section)

This adjusts the monitor volume.

Turning this knob toward the left (OUT 1/2) will decrease the level of the sound being input through the input jacks. Turning the knob toward the right (MONITOR) will decrease the level of the sound being output from your computer. At the center position, the sound being output from your computer and the sound being input via the input jacks will both be at 100% of their level.

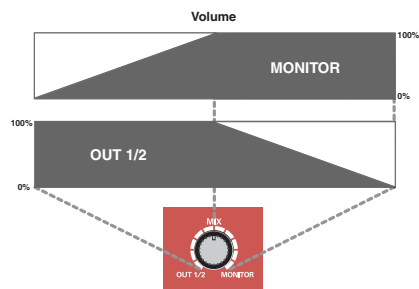

13. Headphone volume

This adjusts the volume that is output from the **headphone jack (15)**. This does not affect the volume that is output from the rear panel **main output jacks (MAIN OUT) (24)**.

14. Headphone jack

This jack outputs the mixed sound being input via the input jacks and the sound being output from the computer (WAVE OUT 1/2 (in the case of WDM, **OUTPUT 1** → see p. 22)). The balance of these two is adjusted by the **direct monitor volume (12)**.

Even if headphones are connected, the sound being sent from the rear panel’s **main output jacks (MAIN OUT) (24)** will not be cut off.

15. FireWire (IEEE 1394) indicator

Lights when the FA-101 is connected to your computer via a FireWire (IEEE 1394) cable.

16. Power indicator

Lights when the power is on.

Rear panel

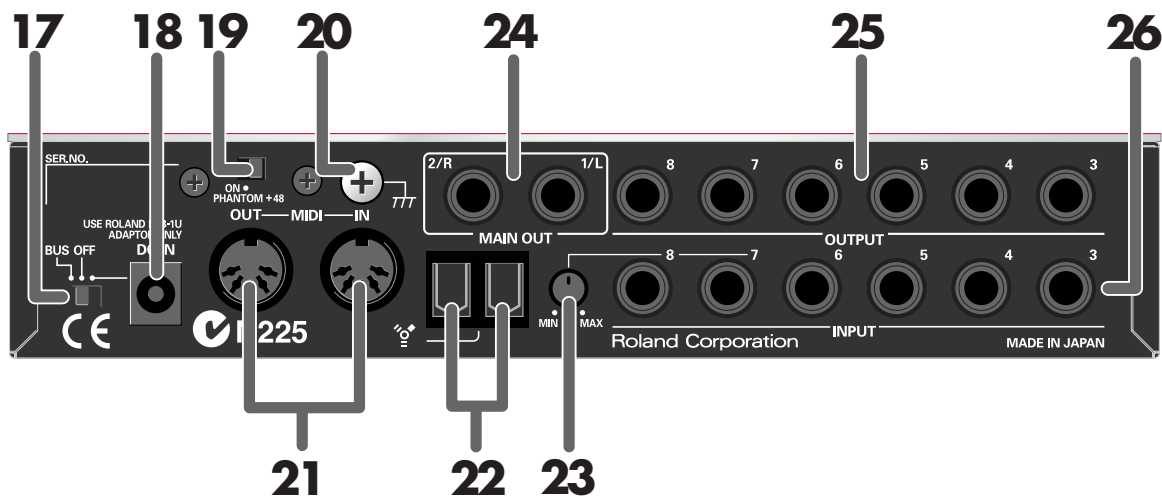

17. Power switch

Used to switch the power on (DC IN) or off (OFF), and for switching to bus power (BUS).

BUS

Bus power can be used if the FA-101 is connected to your computer via a FireWire (IEEE 1394) cable. In this case, power is supplied from your computer via the FireWire (IEEE 1394) cable. If you want to use bus power, set the power switch to the BUS position.

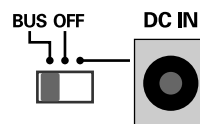

- **6-pin type**

You can use bus power if your computer has a 6-pin IEEE 1394 connector (FireWire connector, iLink connector, DV connector).



With some computers, the FA-101 may not operate on bus power. If so, connect the included AC adaptor to an AC outlet and use it to supply power to the FA-101. In this case, the power will be on when you set the power switch to the DC IN position.

- **4-pin type**

If your computer has a 4-pin FireWire (IEEE 1394) connector, you cannot use bus power. Set the power switch to the DC IN position.



18. AC adaptor jack

Connect the included AC adaptor to this jack.

* Never use any AC adaptor other than the supplied unit; doing so may cause malfunction.

19. Phantom power switch

This is an on/off switch for the phantom power supplied to the XLR connectors of the **combo input jacks (1)** on the front panel.

* You must leave the phantom power turned off (right position) unless condenser mics requiring phantom power are connected to the XLR jacks. Supplying phantom power to a dynamic mic or an audio playback device may cause malfunction. For details on the requirements of your mic, refer to its owner's manual.
(The FA-101's phantom power supply: DC 48 V, 20 mA maximum)

20. Grounding terminal

Depending on the circumstances of a particular setup, you may experience a discomforting sensation, or perceive that the surface feels gritty to the touch when you touch this device, microphones connected to it, or the metal portions of other objects, such as guitars. This is due to an infinitesimal electrical charge, which is absolutely harmless. However, if you are concerned about this, connect the ground terminal (see figure) with an external ground. When the unit is grounded, a slight hum may occur, depending on the particulars of your installation. If you are unsure of the connection method, contact the nearest Roland Service Center, or an authorized Roland distributor, as listed on the "Information" page.

Unsuitable places for connection

- Water pipes (may result in shock or electrocution)
- Gas pipes (may result in fire or explosion)
- Telephone-line ground or lightning rod (may be dangerous in the event of lightning)

21. MIDI IN/OUT connectors

You can connect these to the MIDI connectors of your MIDI equipment to send and receive MIDI messages.

22. FireWire (IEEE 1394) connectors

Use a FireWire (IEEE 1394) cable to connect these to your computer. These two connectors operate in the same way; it makes no difference which you use.

There are two types of connectors, as follows.

- **6-pin FireWire (IEEE 1394) cable**

Use the included 6-pin ↔ 6-pin cable. You will be able to use bus power.



- **4-pin FireWire (IEEE 1394) cable**

Use the included 6-pin ↔ 4-pin cable. If your computer has a 4-pin IEEE 1394 connector (FireWire connector, iLink connector, DV connector), you cannot use bus power.



23. Input level adjustment knob

This adjusts the level of the sound that is input at **input jacks 7 and 8 (26)**.

Input jacks 7 and 8 (26) are designed with a higher gain so that you can connect them to audio devices that have a lower output level, such as CD players or MIDI sound modules. If you connect these inputs to a device that has a higher output level, such as a mixer, use this **input level knob** to adjust the level.

* If no device is connected to the input jacks, turn the input level knob all the way toward the left (MIN).



24. Main output jacks (output jacks 1, 2)

These output the mixed sound that is being input via the input jacks and being output from the computer.

25. Output jacks 3–8

(Nominal output: +4 dBu)

These jacks output analog audio signals. Balanced output is supported.

26. Input jacks 3–8

Connect these when you want to input audio signals from mixers, audio devices, or MIDI sound modules. Balanced input is supported.

Installing the driver (Macintosh)

- 1 With the FA-101 disconnected, start up your Macintosh.
- 2 Use a FireWire (IEEE 1394) cable to connect the FA-101 to your Macintosh.
 1. With the FA-101's power switch off, connect the power cord to it.
 2. Plug the AC adaptor cable into an AC outlet.
 3. Use a FireWire (IEEE 1394) cable to connect the FA-101 to your Macintosh.
- 3 Turn on the FA-101's **power switch**.

The driver will be installed automatically.



This unit is equipped with a protection circuit. A brief interval (a few seconds) after power up is required before the unit will operate normally.

Next, you need to make audio device and MIDI device settings.
(→ "Driver settings" (p. 14))



Once the connections have been completed, turn on power to your various devices in the order specified. By turning on devices in the wrong order, you risk causing malfunction and/or damage to speakers and other devices.

Driver settings

Input/output device settings

If you want to use the FA-101 with the iTunes software included with your Macintosh, specify the input/output devices as follows.

The procedure for making device settings differs depending on the software you are using. For details, refer to the owner's manual for your software.

- 1 From the **Apple** menu, choose the **System Preferences** dialog box, and click **Sound**.
- 2 Click the **Sound Effects** tab, and choose **EDIROL FA-101** for the "Play alerts and sound effects through" setting.
- 3 Click the **Output** tab, and choose **EDIROL FA-101** for the "Choose a device for sound output" setting.
- 4 If the **Input** tab is shown, choose **EDIROL FA-101** for the "Choose a device for sound output" setting.



If you want sound to be played from the internal speakers of your Macintosh, choose "Internal speakers" in the **Output** tab. If you don't want alerts to be played through the FA-101, choose "Internal speakers" for the "Play alerts and sound effects through" setting.

Cautions for use

Before you use your software with the FA-101, please note the following.

- Before you start up your software, use a FireWire (IEEE 1394) cable to connect the FA-101 with your computer, and turn on the power.
- Do not disconnect the FA-101's FireWire (IEEE 1394) cable or switch off the power to the FA-101 while your software is running.
- Close your software before you switch off the FA-101's power.
- Turn off the Sleep setting of your Macintosh.
- The FA-101 will not work in the Classic environment of Mac OS X. Use it when the Classic environment is not running.
- Turn off the energy conservation settings of your Macintosh.
- If the **Options** pane of the **Energy Saver** preferences on your Macintosh has a **Processor Performance** setting, choose the "Highest" setting.

* Depending on the model of Macintosh you are using, starting up the Macintosh when the FA-101 is connected may cause operation to become unstable. In this case, start up the Macintosh and then connect the FA-101.

* If you want to change the FA-101's sample rate, turn the FA-101 off, change the sample rate, and then turn the FA-101 on again.

If, in the Mac OS **System Preferences - Sound - Output**, the **EDIROL FA-101** is not shown in the **"Choose a device for sound output"** setting, this means that the FA-101 is completely powered down.

Mac OS settings

- 1 Open the **Applications** folder of your Macintosh hard disk. In the **Utilities** folder, double-click **Audio MIDI Setup** to open the **Audio MIDI Setup**.

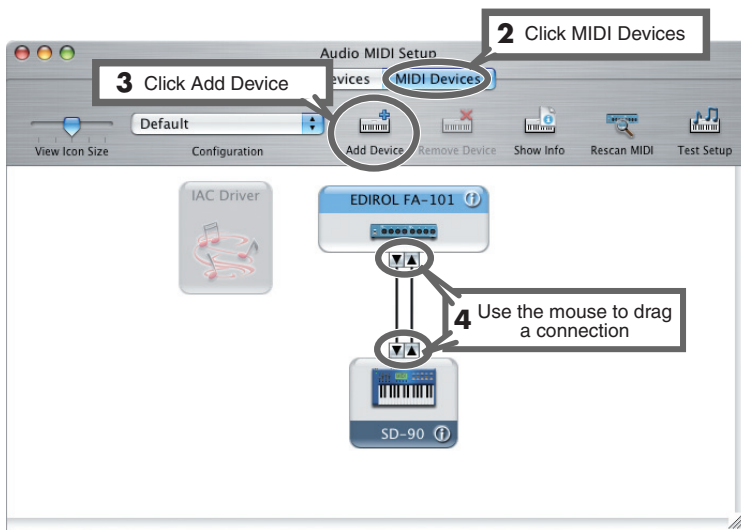

- 2 Click the **MIDI Devices** tab.
 - 3 Click **Add Device**.
New external device will appear.
 - 4 Connect the ▼ and ▲ symbols (which signify the outputs and inputs) of the **EDIROL FA-101** icon to those of the **New External Device** icon by using the mouse to drag between them.
- * Change icons and set other items according to the MIDI devices that are connected to the FA-101's MIDI connectors. If you double-click **new external device**, the **new external device Properties** dialog box will appear, allowing you to specify a variety of things, such as the device name.

Software settings

Before you start up your software, use a FireWire (IEEE 1394) cable to connect the FA-101 to your computer, and turn on the power of the FA-101.

If your software allows you to specify MIDI and audio input/output settings, choose **EDIROL FA-101**. For details, refer to the owner's manual for your software. Also refer to **"Software settings"** (p. 30).



For the latest information, please visit
<http://www.edirol.com/>

Checking that you hear sound

Now, let's play back the sample data to verify that the connections and settings are correct. We will use iTunes to play back the sample data provided on the included CD-ROM.

Before you continue, connect headphones or monitor speakers to the FA-101 as described in "**Basic connections**" (p. 25).

- 1 Set the FA-101's sample rate select switch to 48 kHz. You'll need to cycle the power to the FA-101 after changing the sampling rate.
- 2 Start up **iTunes** (included with Mac OS).
iTunes is normally located in the **Applications** folder on the hard disk.
- 3 Insert the included CD-ROM into the CD-ROM drive of your Macintosh.
- 4 From the **SampleSong** folder of the CD-ROM, drag **TTears(.mp3)** into the iTunes window.
- 5 Select **TTears(.mp3)** in the song list, and click .

Alternatively, you can start playback by pressing the space bar on your computer keyboard.

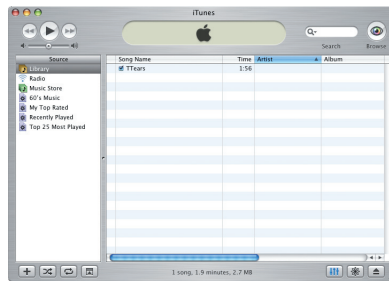

If the volume is too low, or if you don't hear sound at all, try turning the FA-101's **direct monitor volume** knob (p. 11) so it's positioned to the left of the MIX (center) position.

If the sample data plays correctly, the FA-101 is correctly connected to your Macintosh.



Use of the song data supplied with this product for any purpose other than private, personal enjoyment without the permission of the copyright holder is prohibited by law. Additionally, this data must not be copied, nor used in a secondary copyrighted work without the permission of the copyright holder.

About the demo songs

The SampleSong folder on the included CD-ROM contains the following demo songs. Please copy the demo songs to the hard disk of your Macintosh before listening to them.

* *The demo songs were produced at 48 kHz. You must set the FA-101's sample rate to 48 kHz. You'll need to cycle the power to the FA-101 after changing the sampling rate.*

for Cubase folder

This folder contains the demo songs as Cubase VST song files (.all) and Cubase SX project files (.cpr).

If you are using the Cubase SX demo version, the playback will not be correct since some functionality (such as effects) will not be available.

for Logic folder

This folder contains the demo songs as Logic project files (.lso).

Installing the driver (Windows)

What is a driver?

A driver is software that allows data to be transferred between the FA-101 and application software running on your computer when the FA-101 is connected to your computer via a FireWire (IEEE 1394) cable.

The driver sends data from your application software to the FA-101, and from the FA-101 to your application software. The driver is required in order for you to use the FA-101 while connected to your computer.

- 1 With the FA-101 disconnected, start up Windows.

* You must log on to Windows with a user name whose account has administrative privileges (e.g., Administrator).

- 2 Open the **System Properties** dialog box.

1. From the Windows **start** menu, choose **Control Panel**.
2. In “Pick a category,” click “**Performance and Maintenance**”.
3. In “or Pick a Control Panel icon,” click the **System** icon.

- 3 Click the **Hardware** tab, and then click [**Driver Signing**].

The **Driver Signing Options** dialog box appears.

- 4 In the **Driver Signing Options** dialog box, make sure that “**Ignore**” is selected.

If “**Ignore**” is selected, simply click [**OK**]. If “**Ignore**” is not selected, make a note of the current setting (Warn or Block), change the setting to “**Ignore**”, and click [**OK**].



- 5 Click [**OK**] to close the **System Properties** dialog box.

- 6 Close all currently running software (applications).

Also close all windows that are open. If you are using software such as antivirus programs, be sure to close these programs as well.

- 7 Find the included CD-ROM.

Insert the CD-ROM into your computer’s CD-ROM drive.

MEMO

Depending on your system, the **System** icon may be displayed directly in the **Control Panel** (Classic view). If so, double-click the **System** icon.

MEMO

If you change the “**Driver Signing Options**” setting, change it back to the original setting after you’ve installed the driver.

MEMO

If the screen indicates “**Windows can perform the same action each time you insert a disk or connect a device with this kind of file,**” click [**Cancel**].

Installing the driver (Windows)

- 8 From the Windows **start** menu, choose “**Run...**”
The “**Run**” dialog box will appear.
- 9 Input the name into the dialog box as shown, and click [**OK**].

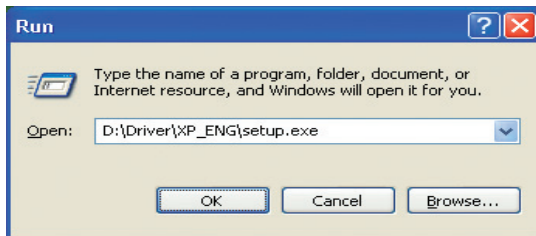

(Drive name): \Driver\XP_ENG\setup.exe

* The drive name is “D:” in the example shown here, but this may be different on your system. Specify the drive name for your CD-ROM drive.

- 10 The **EDIROL FA-101 Driver Setup** dialog box appears.
Click [**Install**].

If the setting in the **Driver Signing Options** dialog box is not set to “**Ignore**,” a dialog box like the following will appear.
Click [**Continue Anyway**] to continue driver installation.



- 11 A dialog box entitled “**Setup is now ready to install the drivers**” appears.
Use a FireWire (IEEE 1394) cable to connect the FA-101 to your computer.
 1. With the power switch turned off, connect the AC adaptor to the FA-101.
 2. Plug the AC adaptor’s power cord into an AC outlet.
 3. Use a FireWire (IEEE 1394) cable to connect the FA-101 to your computer.
- 12 **Turn on the power switch** of the FA-101.
The “**Found New Hardware**” message appears near the taskbar. Please wait.
- 13 A dialog box entitled **Welcome to the Found New Hardware Wizard** appears. Make sure that the box indicates “**EDIROL FA-101 Sub 1**,” choose “**Install the software automatically (Recommended)**,” and click [**Next**].

MEMO

Checking the name of your drive.

From the **start** menu, choose **My Computer**. In the window that appears, verify the name of the CD-ROM drive into which you inserted the CD-ROM in step 7.

The (D:) or (E:) displayed by the CD-ROM drive icon  is the drive name.

MEMO

If you want to install the driver into a different hard disk, click [**Browse**] and specify the desired location.

NOTE

Once the connections have been completed, turn on power to your various devices in the order specified. By turning on devices in the wrong order, you risk causing malfunction and/or damage to speakers and other devices.

NOTE

This unit is equipped with a protection circuit. A brief interval (a few seconds) after power up is required before the unit will operate normally.

- 14** A dialog box entitled “**Completing the Found New Hardware Wizard**” appears.
Click **[Finish]**.
Once again, the “**Found New Hardware**” message appears near the taskbar. Please wait.
- 15** A dialog box entitled **Welcome to the Found New Hardware Wizard** appears. Make sure that the box indicates “**EDIROL FA-101 Sub 2**,” choose “**Install the software automatically (Recommended)**,” and click **[Next]**.
- 16** A dialog box entitled “**Completing the Found New Hardware Wizard**” appears.
Click **[Finish]**.
The “**Found New Hardware**” message appears near the taskbar.
- 17** In the **EDIROL FA-101 Driver Setup** dialog box that is already displayed, click **[I Completed the Above Steps]**.
The “**Found New Hardware**” message appears near the taskbar.
- 18** The **Welcome to the Found New Hardware Wizard** dialog box appears. Make sure that the box indicates “**EDIROL FA-101**,” choose “**Install the software automatically (Recommended)**,” and click **[Next]**.

A dialog box like the following will appear if “**Driver Signing Options**” is not set to “**Ignore**.”

If a dialog box with the “**!**” symbol appears...

1. Click **[Continue Anyway]**.
2. Continue with the installation.

If a dialog box with the “**X**” symbol appears...

1. Click **[OK]**.
2. When the “**Found New Hardware Wizard**” appears, click **[Finish]**. Return to **step 1** (p. 17), and re-install the driver from the beginning.

- 19** A dialog box entitled “**Completing the Found New Hardware Wizard**” appears.
Click **[Finish]**.
Once again, the “**Found New Hardware**” message appears near the taskbar.

This completes driver installation.

MEMO

If the **Found New Hardware Wizard** asks you whether you want to connect to Windows Update, choose “**No**” and then click **[Next]**.

If you changed the “**Driver Signing Options**” setting (p. 17, step 4), restore the setting to its previous state after restarting Windows.

- 1.** Log on to Windows using the same user account as the one used when the driver was installed.
- 2.** From the Windows **start** menu, choose **Control Panel**.
- 3.** In “**Pick a category,**” click **Performance and Maintenance**.
- 4.** In “**or Pick a Control Panel icon,**” click the **System** icon. The **System Properties** dialog box appears.
** Depending on your system, the **System** icon may be shown directly in the **Control Panel** (Classic view). If so, double-click the **System** icon.*
- 5.** Click the **Hardware** tab, and then click [**Driver Signing**]. The **Driver Signing Options** dialog box appears.
- 6.** In **Driver Signing Options**, restore the previous setting (“Warn” or “Block”) and click [**OK**].
- 7.** Click [**OK**]. The **System Properties** dialog box closes.

Next, you need to set your computer so priority is given to background services, which will help to assure that audio and MIDI processing occur smoothly.
(→ “**Giving priority to background services**” (p. 21))

Giving priority to background services

Crackling may occur in the sound if you omit making this setting. To ensure that audio and MIDI are processed smoothly, make the setting as follows.

- 1 Open the **System Properties** dialog box.
 1. From the Windows **start** menu, choose **Control Panel**.
 2. In “Pick a category,” click “**Performance and Maintenance**”.
 3. In “or Pick a Control Panel icon,” click the **System** icon.
- 2 Click the **Advanced** tab.
- 3 Click [Settings] located at the right of the **Performance** area.
The **Performance Options** dialog box appears.
- 4 Click the **Advanced** tab.
- 5 In **Processor Scheduling**, choose “**Background services**,” and click [OK].
- 6 In the **System Properties** dialog box, click [OK]. The **System Properties** dialog box closes.

Next, you need to make audio device and MIDI device settings.

(→ “**Driver settings**” (p. 22))

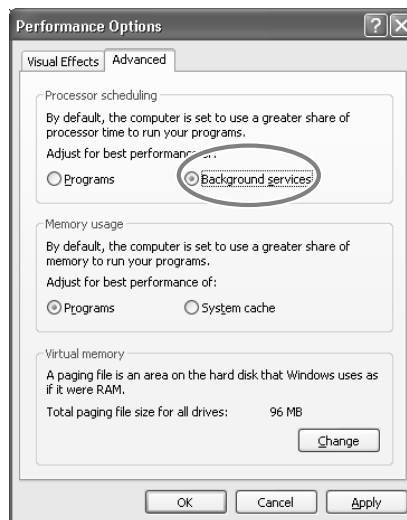

MEMO

Depending on your system, the **System** icon may be displayed directly in the **Control Panel** (Classic view). If so, double-click the **System** icon.

Driver settings

About the input and output devices

In order to get the best performance from the software you are using, you must choose the correct device settings. The FA-101's audio driver supports WDM and ASIO 2.0.

Audio devices

Audio output device (WDM)	EDIROL FA-101 Out 1...5	Note 1
Audio input device (WDM)	EDIROL FA-101 In 1...5	Note 1
ASIO device	EDIROL FA-101	

Note 1: Refer to "How WDM ports correspond to FA-101 output jacks" (p. 22).

MIDI devices

MIDI OUT	EDIROL FA-101 MIDI OUT If you specify EDIROL FA-101 as the output port for your sequencer software, etc., messages will be sent from the FA-101's MIDI OUT connector.
MIDI IN	EDIROL FA-101 MIDI IN If you specify EDIROL FA-101 as the input port for your sequencer software, etc., messages will be received from the FA-101's MIDI IN connector.

* For details on how to make settings for your software, you should also refer to the owner's manual for your software, as well as to "Software settings" (p. 30).

* If you are unable to select the FA-101 in the device settings of your software, it is possible that the FA-101 driver was not installed correctly. Please re-install the driver.

WDM

Use this if you are using the FA-101 with the following applications or situations.

- Conventional applications such as Media Player (for the settings, refer to "Input/output device settings" (p. 23))
- WDM driver mode compatible applications such as SONAR
- DirectSound compatible applications

ASIO

Use this if you are using the FA-101 with an ASIO-compatible application such as Cubase. In the ASIO settings of your application, choose "EDIROL FA-101." You will be able to use ten inputs and ten outputs.

* To prevent audio loop feedback or double monitoring, turn monitoring off in your application, or set your application to use ASIO Direct Monitor.

* When using the FA-101 with ASIO, we recommend that you not set your application to use the Microsoft GS Wavetable SW Synth. (This will decrease the processing load, and make it easier to change the driver buffer size.)

How WDM ports correspond to FA-101 output jacks

WDM output port	FA-101 output jacks	WDM input port	FA-101 input jacks
EDIROL FA-101 OUT 1	L OUTPUT 1 R OUTPUT 2	EDIROL FA-101 IN 1	L INPUT 1 R INPUT 2
EDIROL FA-101 OUT 2	L OUTPUT 3 R OUTPUT 4	EDIROL FA-101 IN 2	L INPUT 3 R INPUT 4
EDIROL FA-101 OUT 3	L OUTPUT 5 R OUTPUT 6	EDIROL FA-101 IN 3	L INPUT 5 R INPUT 6
EDIROL FA-101 OUT 4 * This port is not displayed when operating at 192 kHz.	L OUTPUT 7 R OUTPUT 8	EDIROL FA-101 IN 4 * This port is not displayed when operating at 192 kHz.	L INPUT 7 R INPUT 8
EDIROL FA-101 OUT 5 * This port is not displayed when operating at 192 kHz.	L OUTPUT 9 R OUTPUT 10	EDIROL FA-101 IN 5 * This port is not displayed when operating at 192 kHz.	L INPUT 9 R INPUT 10

Input/output device settings

If you will be using the Windows Media Player application with the FA-101, specify the input/output devices as follows.

The method in which you make device settings will depend on the software you are using. For details, refer to the owner's manual for your software.

- 1 Open the **Sound, Speech, and Audio Devices Properties** dialog box.
 1. From the Windows **start** menu, choose **Control Panel**.
 2. In **"Pick a category,"** click **Sound, Speech, and Audio Devices**.
 3. In **"or Pick a Control Panel icon,"** click the **Sounds and Audio Devices** icon.
- 2 Click the **Audio** tab.

- 3 In the **Sound playback**, **Sound recording**, and **MIDI music playback** areas, click the **Default device** field. From the list that appears for each field, choose the device shown below.

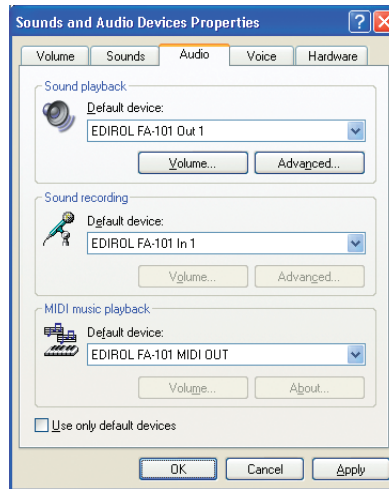

Sound playback	EDIROL FA-101 Out 1
Sound recording	EDIROL FA-101 In 1
MIDI music playback	EDIROL FA-101 MIDI OUT

- 4 Click **[OK]** to close the **Sounds and Audio Devices Properties** dialog box.

This completes the audio and MIDI input/output settings.

Software settings

Before you start up your software, use a FireWire (IEEE 1394) cable to connect the FA-101 to your computer, and turn on the power of the FA-101.

If your software allows you to specify MIDI and audio input/output settings, choose **EDIROL FA-101**. For details, refer to the owner's manual for your software. Also refer to **"Software settings"** (p. 30).

MEMO

Depending on your system, the **System** icon may be displayed directly in the **Control Panel** (Classic view). If so, double-click the **System** icon.

NOTE

If you are using sequencer software, you will need to make audio and MIDI device settings from within your software. For details, refer to the owner's manual for the software you are using.

NOTE

Each input/output device can only be used by one software application at a time; multient usage is not supported.

NOTE

If you are using the 192 kHz sample rate on Windows XP, the FA-101 may not appear in the Sounds tab of the Sounds and Audio Devices Properties dialog box. If so, please update your system to Windows XP Service Pack 1.

MEMO

For the latest information, please visit <http://www.edirol.com/>

Checking that you hear sound

Now, let's play back the sample data to verify that the connections and settings are correct. We will use standard Windows functionality to play back the sample data provided on the included CD-ROM.

Before you continue, connect headphones or monitor speakers to the FA-101 as described in "**Basic connections**" (p. 25).

- 1 Insert the CD-ROM into the CD-ROM drive of your computer.
- 2 From the **SampleSong** folder of the CD-ROM, drag **TTears(.mp3)** onto your desktop.
- 3 Set the FA-101's **sample rate select switch** to **48 kHz**.
You'll need to cycle the power to the FA-101 after changing the sampling rate.
- 4 Right-click the **TTears(.mp3)** file you copied, and choose **Play** from the menu that appears.

Playback begins.



If the volume is too low, or if you don't hear sound at all, try turning the FA-101's **direct monitor volume** knob (p. 11) so it's positioned to the left of the MIX (center) position.

If the sample data plays correctly, the FA-101 is correctly connected to your computer, and the driver has also been installed correctly.



Use of the song data supplied with this product for any purpose other than private, personal enjoyment without the permission of the copyright holder is prohibited by law. Additionally, this data must not be copied, nor used in a secondary copyrighted work without the permission of the copyright holder.



The contents of the menu that appears will depend on your system.

About the demo songs

The SampleSong folder on the included CD-ROM contains the following demo songs. Please copy the demo songs to the hard disk of your computer before listening to them.

* *The demo songs were produced at 48 kHz. You must set the FA-101's sample rate to 48 kHz. You'll need to cycle the power to the FA-101 after changing the sampling rate.*

for Cubase folder

This folder contains the demo songs as Cubase VST song files (.all) and Cubase SX project files (.cpr).

If you are using the Cubase SX demo version, the playback will not be correct since some functionality (such as effects) will not be available.

for SONAR folder

This folder contains the demo songs as SONAR project files (.cwb).

Basic connections and settings

This section explains basic connections and data flow for the FA-101.

Refer to the block diagram printed on the front cover of the manual as you read this section.

- * Before making connections to other equipment, turn down the volume of all your equipment and turn off the power to avoid causing malfunctions or damaging your speakers.
- * When connection cables with resistors are used, the volume level of equipment connected to the inputs (Input jacks) may be low. If this happens, use connection cables that do not contain resistors, such as those from the Roland PCS series.

Basic connections

Use a FireWire (IEEE 1394) cable to connect the FA-101 to your computer. MIDI data and audio data are transferred in both directions via the FireWire (IEEE 1394) cable.

By connecting headphones or monitor speakers as shown in the diagram below, you can monitor the playback from your software or the sound from an instrument or audio device connected to the FA-101.

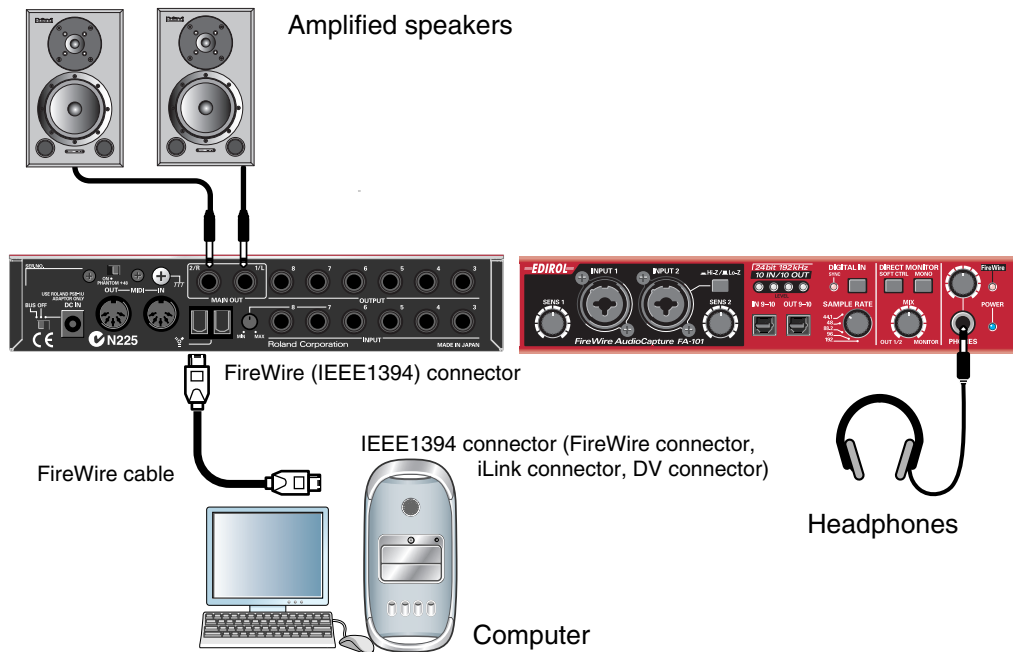

Recording a mic or guitar

Here's how to make connections and settings to let you sing or play your guitar while listening to audio data on your computer, and record just the vocal or guitar into your sequencer.

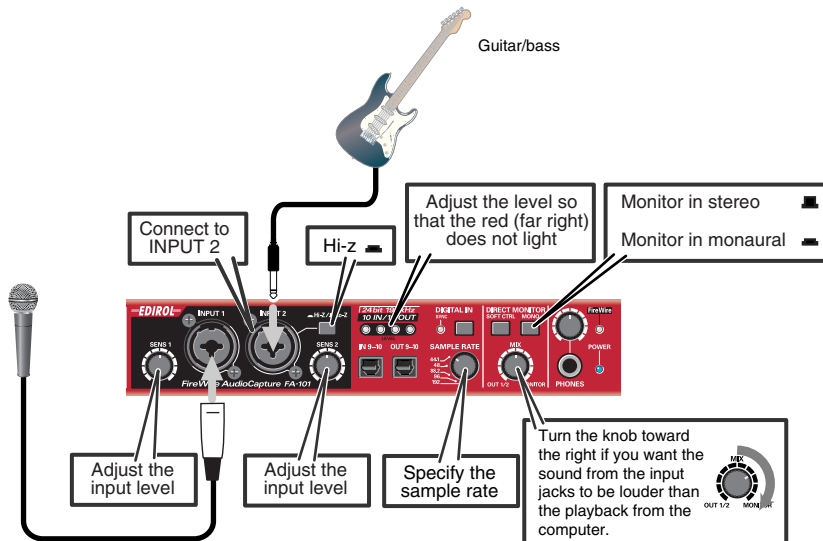

Connections

The sound of the mic connected to INPUT 1 will be recorded in your computer as the left (L) channel. If you connect a source to INPUT 2, it will be recorded on the right (R) channel.

Connect your guitar to INPUT 2.

Sample rate select switch

Set this to the same sample rate as selected in your recording software.

If you switch the FA-101's sample rate, you must turn the power of the FA-101 off, then on again to get the setting to take effect.

Input impedance select switch

If you've connected a mic to INPUT 2

Select Lo-Z.

If you've connected a guitar to INPUT 2

Select Hi-Z.

STEREO/MONO select switch (direct monitor section)

Set this according to whether you want to monitor the input signal in stereo or in monaural.

Direct monitor soft control switch

Turn this on if you want to control input monitoring from ASIO 2.0 compatible software.

Direct monitor volume

This adjusts the balance between the monitor volume and the audio playback volume from your computer. Adjusting the direct monitor volume will not affect the recording level.

Phantom power switch

If you're using a condenser mic, turn the phantom power switch on.

** If a device that does not use phantom power is connected, you must turn off the phantom power switch. Failing to do so may cause malfunction.*

Input sensitivity knob

Use the input sensitivity knob to adjust the input level. For the best audio quality, raise the level until it is as high as you can get it without causing the input level indicator to light in red.

Other notes

Don't connect anything to jacks you are not using.

Howling could be produced depending on the location of microphones relative to speakers. This can be remedied by:

1. Changing the orientation of the microphone(s).
2. Relocating microphone(s) at a greater distance from speakers.
3. Lowering volume levels.

Recording a digital signal

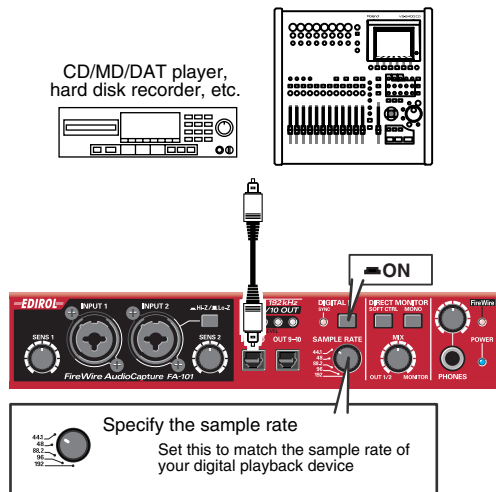

Connections

Connect your digital device to the digital input connector.

Sample rate select switch

Set this to match the sample rate of your digital playback device and the sample rate of your recording software. If you switch the FA-101's sample rate, you must turn the power of the FA-101 off, then on again to get the setting to take effect.



You cannot record digital signals if the 192 kHz setting is selected.

Digital input switch

Turn this on (lit) so that the FA-101 will synchronize to the digital signal being input to the digital input connector.

When synchronized correctly, the sync indicator will light green. If this indicator is blinking green, synchronization has not been achieved. In this case, check that the sample rate of the connected digital device matches the sample rate selected by the FA-101's sample rate switch.

Direct monitor volume

This adjusts the monitor volume.

Adjusting the direct monitor volume will not affect the recording level.

Connecting various types of equipment

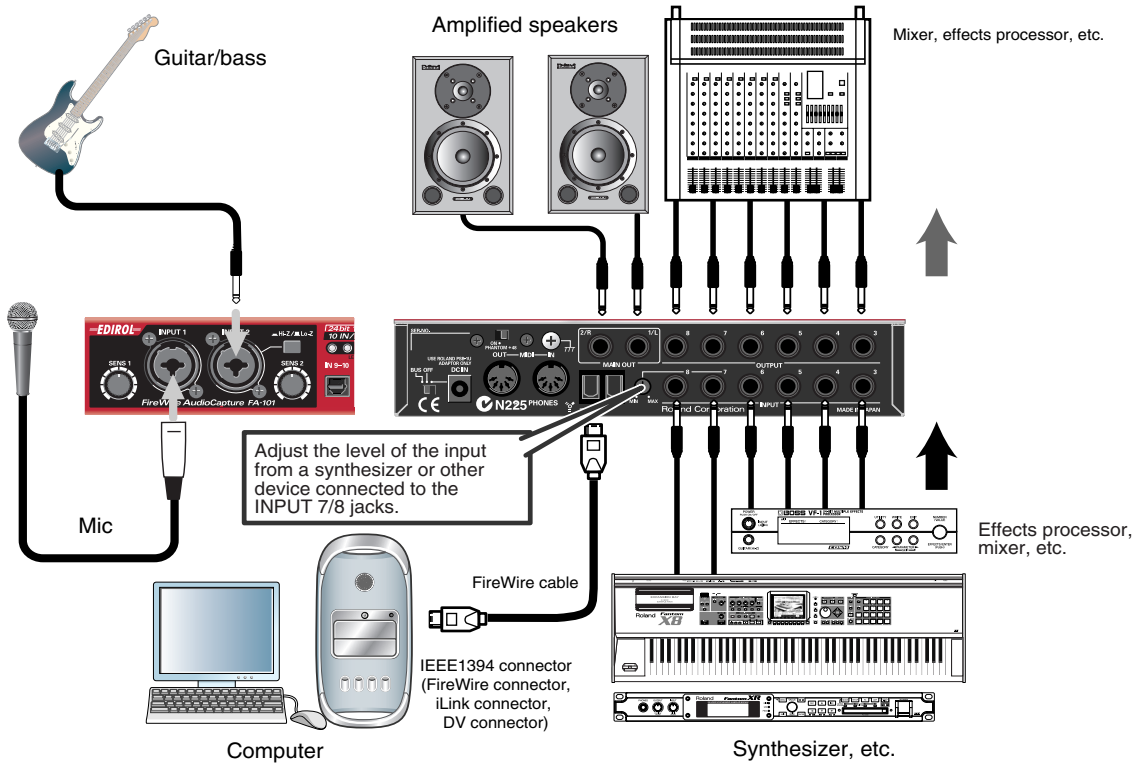

Connections

- Connect output jacks 3–8 to your external mixer or other device.
- Connect the outputs of your external mixer or other device to input jacks 3–6.
- Connect the outputs of your synthesizer or other device to input jacks 7–8.

Direct monitor volume

- This adjusts the monitor volume.
- Adjusting the direct monitor volume will not affect the recording level.

Software settings

You will need to make audio and MIDI device settings for the software you're using. Here are some examples for typical software applications.

SONAR 3

In this example we are using SONAR 3 Producer Edition.



You must make the following settings if you have switched the FA-101's sample rate or have changed the buffer size in the FA-101 Driver settings dialog box.

1. Power up the FA-101, and then start up SONAR.
2. From SONAR's **Options** menu, choose **Audio** to open the **Audio Options** dialog box.
3. Click the **Advanced** tab.
In the **Playback and Recording** area, verify that **Driver Mode** is set to **Use Default** or **WDM/KS**.
If you change this setting, click **[OK]** and restart SONAR.
4. Restart SONAR, and from the **Options** menu, choose **Audio** to open the **Audio Options** dialog box.
5. In the **General** tab, set **Audio Driver Bit Depth** to **24**.
Set the **Sampling Rate** to the same setting as the FA-101's sample rate select switch.
If you change this setting, click **[OK]** and exit SONAR.

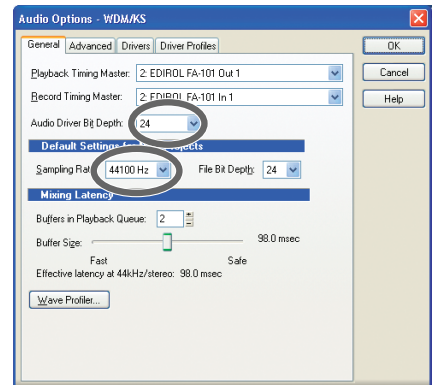

* If the **Audio Driver Error** dialog box appears, click **[Use Anyway]**.
If you click **[Disable]**, the setting will be discarded.

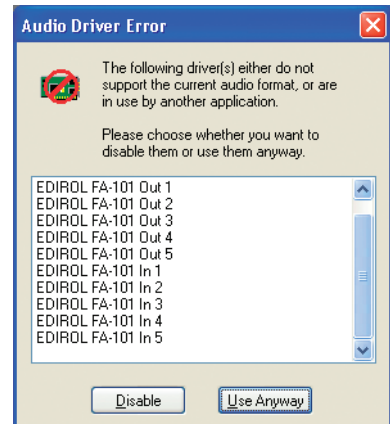

6. Restart SONAR, and from SONAR's **Options** menu, choose **Audio** to open the **Audio Options** dialog box.
7. In the **General** tab, click **Wave Profiler**.
When **Wave Profiler** is finished, click **[OK]**.

8. Click the **Drivers** tab.

In the lists of **Input Drivers** and **Output Drivers**, click the following devices to highlight them (white characters on blue background), and un-highlight all other devices. Click **[OK]**.

Input devices	Output devices
EDIROL FA-101 In 1	EDIROL FA-101 Out 1
EDIROL FA-101 In 2	EDIROL FA-101 Out 2
EDIROL FA-101 In 3	EDIROL FA-101 Out 3
EDIROL FA-101 In 4	EDIROL FA-101 Out 4
EDIROL FA-101 In 5	EDIROL FA-101 Out 5

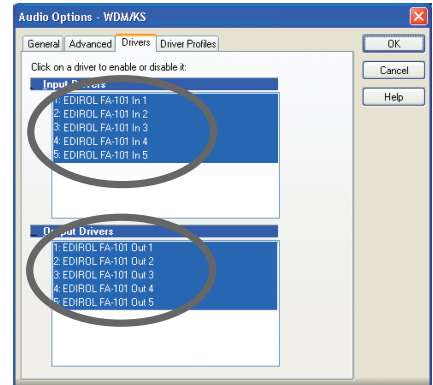

9. Restart SONAR, and from SONAR's **Options** menu, choose **Audio** to open the **Audio Options** dialog box.

10. In the **General** tab, make sure that **Playback Timing Master** is set to **EDIROL FA-101 OUT**, and **Record Timing Master** is set to **EDIROL FA-101 IN**.

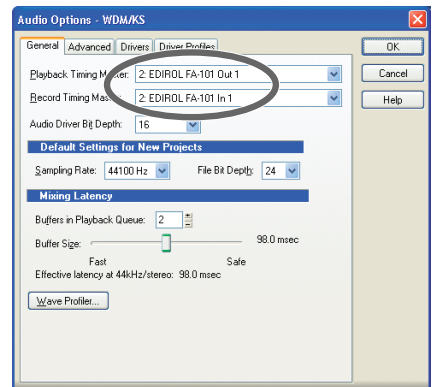

11. Click the **Driver Profiles** tab.

Select **EDIROL FA-101 (5 in, 5 out)** as the setting for “**Show Profile for,**” and then select “**32 bit PCM, left-justified**” as the setting for “**Stream > 16 bit data as.**”

12. Click **[OK]** to close the **Audio Options** dialog box.

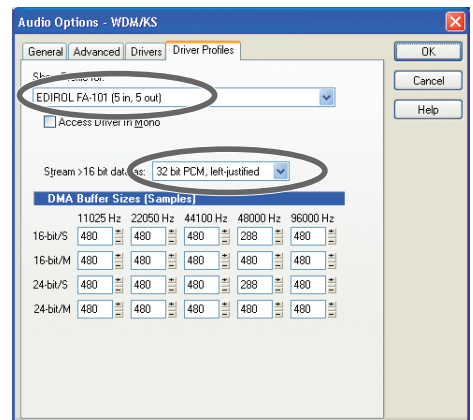

13. From SONAR's **Options** menu, choose **MIDI Devices** to open the **MIDI Devices** dialog box.

14. In the **MIDI Devices** dialog box, choose the FA-101 in the **Inputs** area and the **Outputs** area.

15. Restart SONAR.

16. Open the **Audio Options** dialog box once again as described in step 2. Verify that the audio device settings are correct.

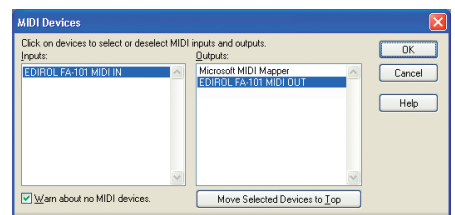

Digital Performer

In this example we are using Digital Performer 4.12.

1. Power up the FA-101, and then start up Digital Performer.
2. From Digital Performer's **Setup** menu, choose **Audio System**, and verify that **MOTU Audio System** is checked.
3. From the **Setup** menu, choose **Configure Audio System - Configure Hardware Driver**.
The **Configure Hardware Driver** dialog box will appear.
4. In the list, click **EDIROL FA-101** to select it, and then click **[OK]**.

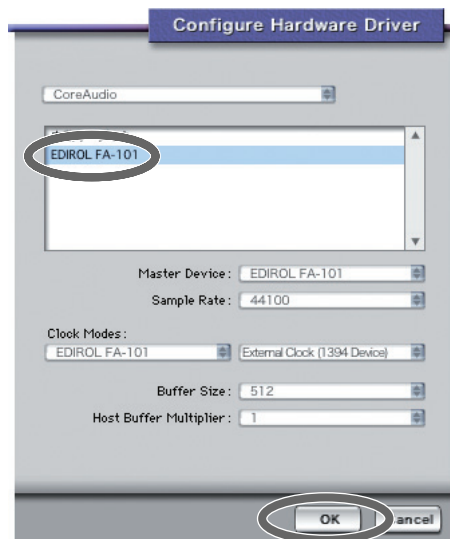

Cubase SX/SL

In this example we are using the Macintosh version of Cubase SX/SL.

1. Power up the FA-101, and then start up Cubase.
2. From the **Devices** menu, choose **Device Setup** to open the **Device Setup** dialog box.
3. In the **Devices** list at the left side of the dialog box, choose **VST Multitrack**.
4. Select the **Setup** tab in the right side of the dialog box.
5. From the drop-down list for **ASIO Driver**, choose **EDIROL FA-101**.
6. Click **[OK]** to close the **Device Setup** dialog box.

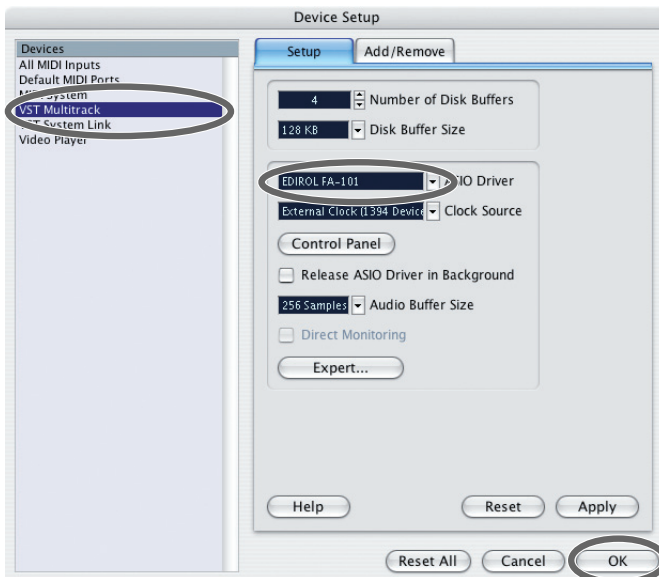

If you experience clicks or pops in the sound, click **[Expert]** to open the **VST Engine Expert Settings** dialog box. Setting the **Audio Priority** to **“Very High”** may reduce clicks and pops.

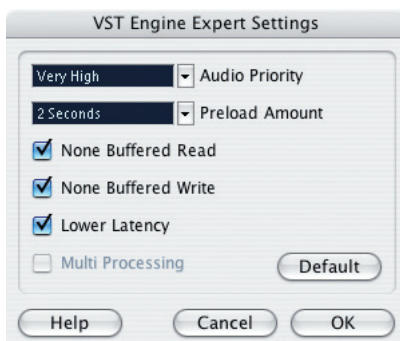

Logic

Here is an example using Logic Platinum 6.

1. Power up the FA-101, and then start up Logic.
2. From the **Logic Platinum** menu, choose **Preferences - Audio Hardware & Driver** to open the **Preferences** dialog box.
3. In the **Core Audio** section, set **Driver** to **EDIROL FA-101**.
4. Select (add a check mark to) the checkbox located at the left of **Core Audio**.
5. If a dialog box like the following appears, click [**Try (Re)Launch**].

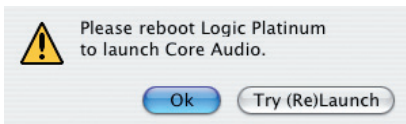

6. Click [**OK**] to close the dialog box.

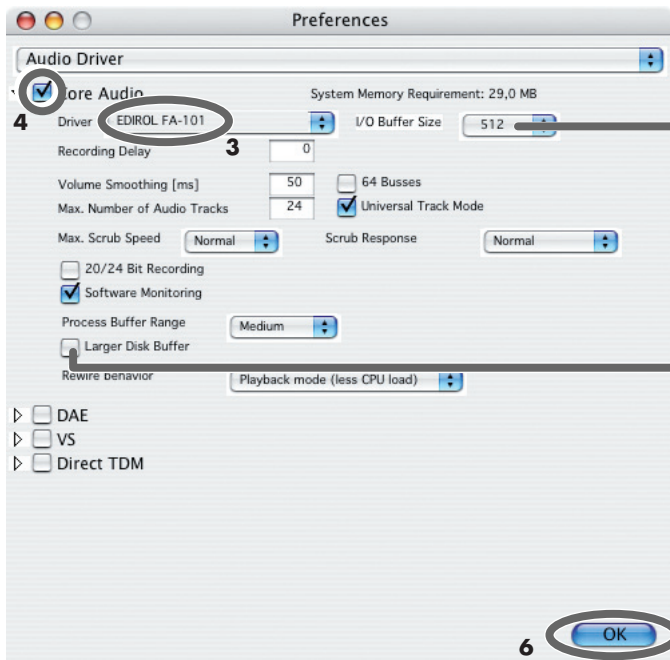

I/O Buffer Size
[Example setting for use at 96 kHz]
As a general guideline, use the following setting:
PowerPC G4 1 GHz or higher 512
PowerPC G4 1 GHz or lower 1024

Larger Disk Buffer
Check this box if a warning dialog box such as "Disk is too slow" is displayed.

FA-101 Driver Settings dialog box (Windows)



There is no FA-101 Driver Settings dialog box on Macintosh.
Make settings from within your software.

You can adjust the audio latency by changing the FA-101 driver settings.

Decreasing the buffer size will shorten the latency.

Increasing the buffer size may eliminate problems such as clicks or pops in the sound.

* **Latency** is the time delay from when the software plays back audio data until sound is actual heard from an audio device such as the FA-101.

Here's how to adjust the buffer size.

1. Close any software that is using the FA-101.
 2. From the Windows **start** menu, choose **Control Panel**.
 3. Click "**Switch to Classic View**" to select the **Classic view**.
Depending on your system, the Classic view may already be selected. If so, proceed to the next step.
 4. In the **Control Panel**, double-click the **EDIROL FA-101** icon.
The **EDIROL FA-101 Driver settings** dialog box will appear.
- 
EDIROL
FA-101
5. Set **WDM** and **ASIO** to **Normal**.
 6. Move the Buffer Size slider to the far left (Min).
If clicks or pops occur with the current setting, move the slider one step toward the right from its current value.
 7. Click **[OK]** to close the dialog box.
 8. Turn the power of the FA-101 off, then on again.
At this time, be sure to close all software before you turn the FA-101's power off.
* *If you power of the FA-101 off while using your software, it may not operate correctly.*
 9. Re-start the software that is using the FA-101.
If your software includes a function for testing audio devices, execute the test function after re-starting the software.
* *Settings are not applied until you restart your software.*
 10. Play back audio data on your software.
If you hear clicks or pops, close the software, and repeat steps 4–10 until you no longer hear clicks or pops.

This completes the basic settings.

If you are using WDM or ASIO compatible software, and you still experience clicks or pops in the sound even after making the above setting, or if you want to make the latency even shorter, you can change the settings from the pulldown menu.

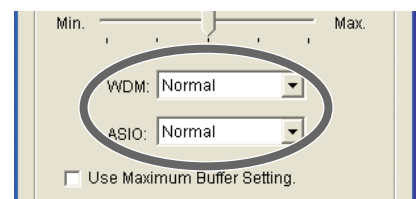
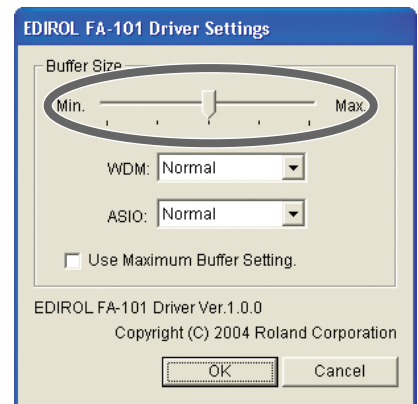

WDM

When using the FA-101 with the following software

- Conventional software such as Media Player
- When using an application such as SONAR in WDM driver mode
- When using DirectSound software

Normal	normal size
Smaller	smaller buffer than Normal (shorter latency)

ASIO

When using the FA-101 with ASIO-compatible software such as Cubase

Normal	normal size
Smaller	smaller buffer than Normal (shorter latency)
Larger	larger buffer than Normal (if clicks or pops occur)

If you still experience clicks or pops even though you have specified the largest buffer size, check **Use Maximum Buffer Setting**. If this item is checked, the slider and the settings of the WDM and ASIO items will be ignored, and an even larger buffer size will be used.

If you still experience clicks or pops even after doing this, the problem may lie elsewhere. Please refer to the Troubleshooting section.

* *Depending on your software, there may also be a buffer size and latency adjustment in the audio settings of your software. For details, refer to the owner's manual for your software.*

Troubleshooting

If you experience problems, read this chapter first/ It contains tips for solving most problems.

Driver-related problems (Windows)

Can't install the driver correctly

You attempted to install as described in "Installing the driver," but did not succeed.

Install the FA-101 driver once again as described in "Installing the driver (Windows)" (p. 17). Also check the Device Manager to see whether "Other device," "Unknown device," "?," "I," or "x" is shown for any device. If you see such a device, delete it.

Does the Device Manager show "Other device," "Unknown device," or any device marked with "?," "I," or "x"?

If driver installation did not end successfully, the installed driver may remain in an incomplete state. Install the FA-101 driver once again as described in "Installing the driver (Windows)" (p. 17).

Is the FA-101 connected correctly?

Make sure that you have used a FireWire (IEEE 1394) cable to correctly connect the FA-101 to the FireWire (IEEE 1394) connector of your computer.

Is the FA-101 powered up?

Make sure that the FA-101's power is on. Make sure that the POWER switch is on.

Could the FA-101's power switch be set to BUS?

Even if you normally use the FA-101 on bus power, you should connect the AC adaptor and set the power switch to the DC IN position while installing the driver (so that the power supply does not become unstable).

Could other FireWire (IEEE 1394) devices be connected?

When installing, all FireWire (IEEE 1394) devices other than the FA-101 should be disconnected from your computer.

If you have connected the FA-101 to an external FireWire (IEEE 1394) hard disk, please connect the FA-101 directly to an IEEE 1394 connector (FireWire connector, iLink connector, DV connector) on the computer itself.

Could other applications or resident software (such as an anti-virus program) be running?

Installation may not occur correctly if other programs are running. Be sure to close all other programs before installing.

Are you attempting to install from a networked CD-ROM drive?

You cannot install from a networked CD-ROM drive.

Could the CD-ROM or the lens of your CD-ROM drive be dirty?

If the CD-ROM or the lens of your CD-ROM drive are dirty, the installer may not work correctly. Use a commercially available CD cleaner or lens cleaner to clean the CD-ROM and/or lens.

Are the power conservation settings of your computer turned off?

If power conservation settings are turned on for your computer, disable these settings. (For details on how to disable them, refer to the owner's manual of your computer.)

Is there enough free space on your hard disk?

Delete unneeded files to increase the amount of free space.
After deleting the file(s), empty the recycling bin.

Is the FireWire (IEEE 1394) connector enabled on your computer?

Refer to the owner's manual for your computer, and verify that the FireWire (IEEE 1394) connector of your computer is enabled. The driver cannot be installed unless the FireWire (IEEE 1394) connector is enabled.

Does your computer or FireWire (IEEE 1394) repeater hub have a sufficient power supply?

If you are using bus power, the FA-101 cannot be connected if insufficient power is being supplied to it. Check whether the following cases might apply.

- If you are using a notebook computer running on its battery, operation may be unstable with some computers. If this is the case, connect your computer to its AC adaptor.
- The power conservation mode of your computer may be limiting the power it supplies to the FireWire (IEEE 1394) connector. Re-examine the settings of your computer.
- The FA-101 cannot be used with some bus-powered repeater hubs (hubs that do not have their own power supply). Use a self-powered hub (a repeater hub that has its own power supply).

Does your computer meet the FireWire (IEEE 1394) specification?

Operation may be unstable if you are using a computer that does not electrically meet the FireWire (IEEE 1394) specification. If so, you may be able to solve the problem by connecting a FireWire (IEEE 1394) repeater hub that has its own power supply.

Can't install/uninstall the driver

Did you log onto Windows as a user with administrative privileges?

In order to install/uninstall/reinstall the FA-101 driver in Windows, you must log onto Windows as a user with administrative privileges, such as Administrator.

Did you make the "Driver Signing Options" setting?

You must set "Driver Signing Options" in order to install/reinstall the driver. (p. 17)

Windows displays an "Installing Hardware," "Did not find digital signature" dialog box.

Did you make the "Driver Signing Options" setting?

You must set "Driver Signing Options" in order to install/reinstall the driver. (p. 17)

The "Welcome to the Found New Hardware Wizard" dialog box appears even though you installed the driver.

Did you connect the FA-101 to a different FireWire (IEEE 1394) connector than the one you used when installing the driver?

If your computer or FireWire (IEEE 1394) hub has two or more FireWire (IEEE 1394) connectors, and you connect the FA-101 to a FireWire (IEEE 1394) connector to which you have not previously connected it, this dialog box may appear even though you have already installed the driver. (This is not a malfunction.)

Install the FA-101 driver once again as described in "Installing the driver (Windows)" (p. 17).

No sound

Can't record or play back audio or MIDI No sound

Are the volume controls of the FA-101 set appropriately?

Adjust the headphone volume knob and direct monitor volume of the FA-101's front panel.

Is your audio playback system (e.g., stereo) connected correctly?

Make sure that the FA-101's output jacks are correctly connected using audio cables to the input jacks of your audio playback system. For details on connections, refer to "Basic connections" (p. 25).

Did you connect/disconnect the FireWire (IEEE 1394) cable or cycle the power to the FA-101 while your software was running?

You must close all software that uses the FA-101 before powering off the FA-101.

If you start up your computer with the FA-101 connected, operation may become unstable for some computers. In this case, connect the FA-101 after starting up your computer.

Could your computer have entered Standby (Suspend) or Sleep mode?

After your computer wakes up, close all software that had been using the FA-101, and then cycle the power to the FA-101.

Have you specified the audio and MIDI data output destination in the operating system?

Depending on the software you are using, you may need to specify the FA-101 as the audio data output destination for your computer. For details on this setting, refer to "Driver settings" (→Macintosh, p. 14 / Windows, p. 22).

Is the driver installed correctly?

In order to use the FA-101 to play back audio/MIDI data, the driver must be installed. For details on installation and settings, refer to "Installing the driver" (→Macintosh, p. 14 / Windows, p. 17).

Are you running numerous software programs?

An error message may appear if numerous software programs are running simultaneously. If this occurs, close the software you are not using.

In Windows, a program is still running if it remains in the taskbar even after you close its window; close any unneeded software shown in the taskbar.

Is the FA-101's sample rate set to a rate other than 192 kHz?

If the FA-101's **sample rate select switch** is set to 192 kHz, **output jacks 7–8**, **input jacks 7–8**, the **digital output connector**, and the **digital input connector** are not available.

Are your input/output devices connected correctly?

In order to play back audio/MIDI using the FA-101, you must make the appropriate input/output device settings. For details on making these settings, refer to "Driver settings" (→Macintosh, p. 14 / Windows, p. 22).

If you are using the 192 kHz sample rate on Windows XP, the FA-101 may not appear in the **Sounds** tab of the **Sounds and Audio Devices** Properties dialog box. If so, please update your system to Windows XP Service Pack 1.

Could the FA-101 have been connected when you started up the computer?

Start up the computer with the FA-101 disconnected, and then connect the FA-101.

Depending on the type of computer you are using, starting up the computer when the FA-101 is already connected may cause operation to be unstable. In this case, start up your computer and then connect the FA-101.

A device connected to the input jacks can't be heard through headphones

Are the input sensitivity knobs and direct monitor volume knob set appropriately?

Turn the knobs toward the right to adjust the volume.

Is the headphone volume knob raised appropriately?

Turn the knob toward the right to adjust the volume.

Could the sample rate select switch be set to 192 kHz?

If you are using the FA-101 at 192 kHz, only the signal input via the combo input jacks can be monitored.

Sounds from the computer are not heard from the FA-101

If the main volume level of your Macintosh raised?

In **System Preferences – Sound**, make sure that **Output Volume** is raised (toward the right).

Have you specified the audio data output destination in your playback software?

You need to make settings in your software to select the FA-101 as the destination for the output of audio data.

For details on how to make this setting, refer to the owner's manual for the software you are using.

Could your computer have entered Standby (Suspend) mode or Sleep mode?

In this case, after your computer wakes up, close all software that had been using the FA-101, and then cycle the power to the FA-101.

If this does not solve the problem, close your software and then restart your computer.

We also recommend that you set your computer so that it does not enter Sleep mode.

Recording produces a silent file

Did you specify the correct audio data input source within the operating system?

Depending on the software you are using, you may need to specify the FA-101 as the audio data input source for your computer. For details on this setting, refer to “**Driver settings**” (→Macintosh, p. 14 / Windows, p. 22).

Can't record from a digital connection

When capturing audio data from a CD or MD into your computer, is the digital input switch “on”?

Turn on the digital input switch.

Does the sample rate of your software match the sample rate of the digital audio device connected to the digital in connector?

Set the sample rate to the same setting.

If you switch the FA-101's sample rate, you must turn the power of the FA-101 off, then on again to get the setting to take effect.

Can't play/record 24-bit audio data

Does your software support 24-bit audio data?

You will need to use software that supports 24-bit audio data.

Is your software set to record/play 24-bit audio data?

Set your software to 24-bit.

Can't record/play MIDI

Have you correctly specified the MIDI device you want to use?

In order to record/play MIDI tracks via the FA-101, you must install the FA-101 driver correctly (→ “**Installing the driver**” (Macintosh, p. 14 / Windows, p. 17)).

You must also specify the MIDI device that you want to use with your software. For details on this setting, refer to “**Driver settings**” (→Macintosh, p. 14 / Windows, p. 22).

Noise or pops are heard when recording/playing on your computer

Noise is heard during audio playback
Pops/clicks occur during audio playback
Noise is heard in the recorded sound

In Windows, did you make the setting described in “Giving priority to background services”?

In order to ensure that audio/MIDI processing occurs smoothly, make the setting described in “Giving priority to background services.” (→ “Giving priority to background services” (p. 21))

In Macintosh, check the Energy Saver settings.

In the Mac OS System Setup, set Energy Saver as follows.

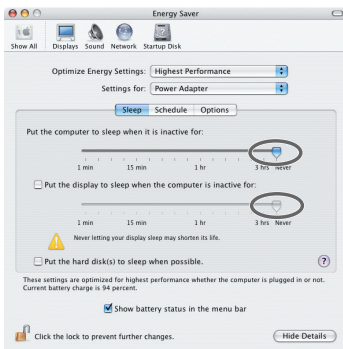

Click the **Sleep** tab.

Set “Put the computer to sleep when it is inactive for:” to **Never**.

Set “Put the display to sleep when the computer is inactive for:” to **Never**.

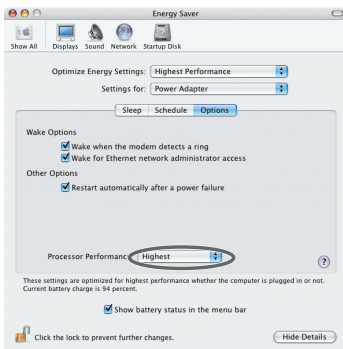

Click the **Options** tab.

If there is a **Processor Performance** setting, set it to **Highest**.

In Windows, Power Management settings in the Control Panel may cause clicks or pops to occur in the audio playback.

The power management properties that appear when you double-click Power Management will differ depending on your computer system. The explanation that follows is for a typical situation, but you should refer to the owner’s manual for your computer to verify these settings.

Some computers may not have the following items.

1. In the Windows **Control Panel**, double-click the **System** icon. The **System Properties** dialog box will appear.
2. Click the **Hardware** tab.
3. Click **Device Manager** to see the list of devices.
4. From the list, choose **Advanced Power Management Support**, and click **Properties**. The **Advanced Power Management Support Properties** dialog box will appear.
5. Click the **Settings** tab, and in **Troubleshooting**, check the “**Don’t Poll Power Supply Status**” check box. Then click **[OK]**.
6. In the **System Properties** dialog box, click **[OK]**.
7. Restart Windows.

Could two or more computers be connected to the FA-101 or to your mixer or audio devices?

Try connecting the FA-101 to only one computer. Check whether the noise disappears when the FA-101 is connected to only one computer. Connecting numerous audio devices to a computer may produce noise in some situations. If this occurs, connect only the FA-101 to your computer.

Are you using a FireWire (IEEE 1394) device in addition to the FA-101?

Try switching off FireWire (IEEE 1394) audio devices other than the FA-101.

If you have connected the FA-101 to an external FireWire (IEEE 1394) hard disk, please connect the FA-101 directly to an IEEE 1394 connector (FireWire connector, iLink connector, DV connector) on the computer itself.

In Windows, you may be able to solve the problem by adjusting the buffer size in the FA-101 Driver Settings dialog box.

Adjust the buffer size as described in “FA-101 Driver Settings dialog box (Windows)” (p. 35).

** After changing the buffer size, you must restart any software that uses the FA-101. If your software has an audio device test function, execute the test function.*

Use the Windows Device Manager to disable the 1394 Net Adaptor.

1. In the Windows **Control Panel**, double-click the **System** icon. The **System Properties** dialog box will appear.
2. Click the **Hardware** tab.
3. Click **Device Manager** to see the list of devices.
4. In the list, double-click **Network Adapters**.
The **1394 Net Adaptor** will appear.
5. Double-click **1394 Net Adaptor**.
The **1394 Net Adaptor Properties** dialog box will appear.
6. In **Device Usage**, choose “**Do not use this device (disable)**.”
7. Click **[OK]**.
8. Close the Device Manager.
9. In the **System Properties** dialog box, click **[OK]** to close the dialog box.

Are numerous software programs running?

Playback may be interrupted if numerous software programs are running at the same time, or when you start up another software program. Close any unneeded software, and try again. If this does not solve the problem, try restarting your computer.

Clicks or pops may occur in the sound if a LAN is operating.

Try disabling the LAN in the Device Manager. If this eliminates the clicks or pops, you may be able to solve the problem by updating your LAN driver or BIOS.

Is the sample rate setting in your software the same as the FA-101's sample rate select switch setting?

Set your software and the FA-101 to the same sample rate.

If you switch the FA-101's sample rate, you must turn the power of the FA-101 off, then on again to get the setting to take effect.

Try adding memory.

Adding memory will improve the processing capability of your computer. For details on how to add memory, refer to the owner's manual of your computer.

If you are using a Macintosh, try pressing the FA-101's digital input switch.

Even if you aren't making use of digital input/output, problems with noise and sound dropout can sometimes be alleviated by switching the FA-101's **digital input switch** on and off.

Is the FA-101 connected to a FireWire (IEEE 1394) hub?

Try connecting the FA-101 directly to the FireWire (IEEE 1394) connector of your computer itself.

Noise may be entering via the line inputs or mic inputs.

If a MIDI sound module with a FireWire (IEEE 1394) connector is connected via FireWire (IEEE 1394) to the same computer as the FA-101, and the output of the MIDI sound module is connected to the input jacks of the FA-101, noise from the computer may be heard via the MIDI sound module from the FA-101. In this case, you can either connect the MIDI sound module and FA-101 in parallel via a self-powered hub, or connect the MIDI sound module in series or via a MIDI interface.

Playback/recording stops midway, and subsequent playback/recording is not possible**While you were using the FA-101, could your computer have performed a task with a heavy processing load, such as accessing a CD-ROM drive or network?**

If a heavy processing load occurs while the FA-101 is being used, it may not work correctly. In this case, stop playback/recording, and then start playback/recording once again. If you are still unable to play/record correctly, close all software that had been using the FA-101, and re-connect the FA-101.

Digitally recorded sound has distortion, the wrong pitch, or contains noise**Is the sample rate setting in your software the same as the sample rate of the digital device connected to the digital input connector?**

Set your software and the FA-101 to the same sample rate.

If you switch the FA-101's sample rate, you must turn the power of the FA-101 off, then on again to get the setting to take effect.

Noise or distortion occurs when the FA-101 is not connected to your computer The sound is too weak

Has a mic or guitar been left connected?

If a mic or guitar is connected to the FA-101, disconnect the mic or guitar and turn the input sensitivity knob all the way toward the left (lowering the input level).

Have you connected the grounding terminal?

Connecting the chassis of your computer or the grounding terminal of your computer's AC power cord to an electrical ground may solve the problem. Also, make sure that a device that produces a strong magnetic field, such as a television or microwave oven, is not located nearby.

Could numerous audio devices be connected?

Noise may occur if numerous audio devices are connected. Do not connect audio devices you are not using.

Sound is distorted

Is the output level indicator lit red?

If you are inputting sound via the **combo input jacks**, use the FA-101's input sensitivity knobs to lower the input level.

Sound of a device connected to the input jacks is distorted Insufficient volume from a device connected to the audio input/output jacks

Is the input level appropriate?

If you are inputting audio via **input jacks 7 and 8**, use the FA-101's **input level adjustment knob** (rear panel) to adjust the input level. If you are inputting audio via the **combo input jacks**, use the **input sensitivity knobs** (front panel) to adjust the input level.

If you are inputting audio via the **INPUT2 combo input jack**, check the setting of the **input impedance select switch**.

Is the direct monitor volume set appropriately?

Adjust the volume as described in **Direct Monitor Volume** (p. 11).

A substantial amount of noise is present in the guitar sound

Does the noise decrease when you turn down the volume of your guitar?

If the noise decreases when you turn down the volume of your guitar, the guitar pickup may be affected by noise from your computer or display. Try locating the guitar as far away from the computer as possible.

Insufficient volume from your guitar

Are you using the correct jack?

Connect your guitar to the **INPUT 2** combo input jack.

Is the input impedance select switch set correctly?

Set the **input impedance select switch** to **Hi-Z**.

Insufficient volume from a mic

Is the input level appropriate?

Turn the **input sensitivity knob** toward the right to adjust the input volume.

Others

Can't start the Cubase

The first time you use the FA-101 with Cubase, turn on the power with the FA-101's sample rate select switch at the 44.1 kHz position.

If this switch is not set to 44.1 kHz, it may be impossible to start Cubase.

Main Specifications

● Number of Audio Record/

Playback Channels

<44.1/48/88.2/96 kHz> (Full duplex)

Record: 10 channels

Playback: 10 channels

<192 kHz> (Full duplex)

Record: 6 channels

Playback: 6 channels

* Some computers may not have sufficient performance.

● Signal Processing

PC interface: 24 bits

AD/DA Conversion: 24 bits (linear)

● Sampling Frequency

Digital output: 44.1/48/88.2/96 kHz

Digital input: 44.1/48/88.2/96 kHz

AD/DA Conversion: 44.1/48/88.2/96/192 kHz

● Frequency Response

96.0 kHz : 20 Hz to 40 kHz (+0/-2 dB)

88.2 kHz : 20 Hz to 40 kHz (+0/-2 dB)

48.0 kHz : 20 Hz to 22 kHz (+0/-2 dB)

44.1 kHz : 20 Hz to 20 kHz (+0/-2 dB)

● Nominal Input Level

Input Jack 1-2 (XLR type)

-50 to -10 dBu

Input Jack 1-2 (1/4 inch TRS phone type)

-35 to +4 dBu

Input Jack 3-6

+4 dBu (balanced)

Input Jack 7-8

-10 dBu to +4dBu(balanced)

● Nominal Output Level

Output Jack 1-8

+4 dBu (balanced)

● Residual Noise Level

(input terminated with 1 k ohms,

MAIN VOLUME: 0 dB,

INPUT SENS: +4 dBu,

DIRECT MONITOR VOLUME: OUT1/2 position,

IHF-A typ., Balanced)

Output Jack 1-2

98 dBu

● SN RATIO (Typical)

OUTPUT: 108 dB (typ.)

INPUT: 102 dB (typ.)

* In the interest of product improvement, the specifications and/or appearance of this unit are subject to change without prior notice.

● Interface

Firewire (IEEE1394)

Digital input/output

Optical type (conforms to IEC60958)

MIDI IN/OUT

● Connectors

<Front Panel>

Input Jack 1-2 (XLR type / 1/4 inch TRS phone type)

XLR type (balanced / phantom power +48V)

1/4 inch TRS phone type (balanced)

* INPUT2 jack: high impedance is supported

Digital In Connector (Optical type)

Digital Out Connector (Optical type)

Headphones Jack (Stereo 1/4 inch phone type)

<Rear Panel>

Input Jack 3-8

(1/4 inch TRS phone type (balanced))

Output Jack 1-8

(1/4 inch TRS phone type (balanced))

MIDI Connectors (In, Out)

FireWire (IEEE1394) Connectors

● Power Supply

DC 9V (AC adaptor)

● Current Draw

900 mA

● Dimensions

218 (W) x 137 (D) x 46.5 (H) mm

8-5/8 (W) x 5-7/16 (D) x 1-7/8 (H) inches

● Weight

0.95 kg / 2 lbs 2 oz

● Accessories

Owner's Manual

CD-ROM

AC Adaptor

FireWire (IEEE1394) cable (6 pins to 6 pins)

FireWire (IEEE1394) cable (6 pins to 4 pins)

(0 dBu = 0.775 V rms)

Index

Numerics

- 4-pin 12
- 6-pin 12

A

- AC adaptor jack 12
- ASIO 22, 35–36
- Audio devices 22
- Audio MIDI Setup 15

B

- background services 21
- BUS 12

C

- Combo input jacks 9
- Cubase 33

D

- Digital input connector 10
- Digital input switch 10, 28
- Digital output connector 10
- Digital Performer 32
- direct monitor mixer section 11
- direct monitor section 11
- Direct monitor soft control switch 11, 26
- Direct monitor volume 11, 26, 28–29
- driver 17
- Driver Settings dialog box 35
- Driver Signing Options 17

E

- Energy Saver 14

F

- FireWire (IEEE 1394) connectors 13
- FireWire (IEEE 1394) indicator 11

G

- Grounding terminal 13
- guitar 26

H

- Headphone jack 11
- Headphone volume 11

I

- Input impedance select switch 9, 26
- Input jacks 13
- Input level adjustment knob 13
- Input sensitivity knob 9, 27
- Input/output level indicators 10
- iTunes 16

L

- Logic 34

M

- Main output jacks 13
- mic 26
- MIDI devices 22
- MIDI IN/OUT connectors 13
- MIDI music playback 23

N

- New External Device 15

O

- optical 10
- Output jacks 13

P

- Phantom power switch 12, 26
- Power indicator 11
- Power switch 12

S

- Sample rate select switc 26
- Sample rate select switch 11, 28
- SONAR 3 30
- Sound playback 23
- Sound recording 23
- STEREO/MONO select switch 11, 26
- Sync indicator 10

U

- User Maximum Buffer Setting 36

W

- WDM 22, 35–36

Information

When you need repair service, call your nearest EDIROL/Roland Service Center or authorized EDIROL/Roland distributor in your country as shown below.



EUROPE
EDIROL (Europe) Ltd.
Studio 3.4 114 Power Road
London W4 5PY
U. K.
TEL: +44 (0)20 8747 5949
FAX: +44 (0)20 8747 5948
http://www.edirol.com/europe

Deutschland
TEL: 0700 33 47 65 20
France
TEL: 0810 000 371
Italia
TEL: 02 93778329

Roland

NORTH AMERICA

CANADA
Roland Canada Music Ltd.
(Head Office)
5480 Parkwood Way Richmond
B. C., V6V 2M4 CANADA
TEL: (604) 270 6626

Roland Canada Music Ltd.
(Toronto Office)
170 Admiral Boulevard
Mississauga On L5T 2N6
CANADA
TEL: (905) 362 9707

U. S. A.
Roland Corporation U.S.
5100 S. Eastern Avenue
Los Angeles, CA 90040-2938,
U. S. A.
TEL: (323) 890 3700

AFRICA

EGYPT
Al Fanny Trading Office
9, EBN Hagar At Askalany
Street,
ARD El Golf, Heliopolis,
Cairo 11341, EGYPT
TEL: 20-2-417-1828

REUNION
Maison FO - YAM Mareel
25 Rue Jules Hermann,
Chaudron - BP799 97 491
Ste Clotilde Cedex,
REUNION ISLAND
TEL: (0262) 218-429

SOUTH AFRICA
Paul Bothner(PTY)Ltd.
Royal Cape Park, Unit 24
Londonderry Road, Ottery 7800
Cape Town, SOUTH AFRICA
TEL: (021) 799 4900

ASIA

CHINA
Roland Shanghai Electronics Co.Ltd.
5F, No.1500 Pingliang Road
Shanghai 200090, CHINA
TEL: (021) 5580-0800

Roland Shanghai Electronics Co.Ltd.
(BEIJING OFFICE)
10F, No.18 3 Section Anhuaxili
Chaoyang District Beijing
100011 CHINA
TEL: (010) 6426-5050

Roland Shanghai Electronics Co.Ltd.
(GUANGZHOU OFFICE)
2/F, No.30 Si You Nan Er Jie
Yi Xiang, Wu Yang Xin Cheng,
Guangzhou 510600, CHINA
TEL: (020) 8736-0428

HONG KONG
Parsons Music Ltd.
8th Floor, Railway Plaza, 39
Chatham Road South, T.S.T,
Kowloon, HONG KONG
TEL: 2333 1863

INDIA
Rivera Digitech (India) Pvt. Ltd.
409, Nirman Kendra
Mahalaxmi Flats Compound
Off. Dr. Edwin Moses Road,
Mumbai-400011, INDIA
TEL: (022) 2493 9051

INDONESIA
PT Citra IntiRama
Jl. Cideng Timur No. 15J-150
Jakarta Pusat,
INDONESIA
TEL: (021) 6324170

KOREA
Cosmos Corporation
1461-9, Seocho-Dong,
Seocho Ku, Seoul, KOREA
TEL: (02) 3486-8855

MALAYSIA/ SINGAPORE
Roland Asia Pacific Sdn. Bhd.
45-1, Block C2, Jalan PUJ 1/39,
Dataran Prima, 47301 Petaling
Jaya, Selangor, MALAYSIA
TEL: (03) 7805-3263

PHILIPPINES
G.A. Yunganco & Co. Inc.
339 Gil J. Puyat Avenue
Makati, Metro Manila 1200,
PHILIPPINES
TEL: (02) 899 9801

TAIWAN
ROLAND TAIWAN
ENTERPRISE CO., LTD.
Room 5, 9th, No. 112 Chung
Shan N.Road Sec.2, Taipei,
TAIWAN, R.O.C.
TEL: (02) 2561 3339

THAILAND
Theera Music Co., Ltd.
330 Soi Veg NakhomKasem,
New Road, Sumpantawongse,
Bangkok 10100, THAILAND
TEL: (02) 224-8821

VIETNAM
SAIGON MUSIC DISTRIBUTOR (TAN DINH MUCI)
138 Tran Quang Khai Street
Dist. 1, Ho Chi Minh City
VIETNAM
TEL: (08) 848-4068

AUSTRALIA/ NEW ZEALAND

AUSTRALIA/ NEW ZEALAND
Roland Corporation
Australia Pty. Ltd.
38 Campbell Avenue
Dee Why West, NSW 2099
AUSTRALIA

For Australia
Tel: (02) 9982 8266
For New Zealand
Tel: (09) 3098 715

CENTRAL/LATIN AMERICA

ARGENTINA
Instrumentos Musicales S.A.
Av. Santa Fe 2055
(1123) Buenos Aires
ARGENTINA
TEL: (011) 4508-2700

BARBADOS
A&B Music Supplies LTD
12 Webster Industrial Park
Wilkey, St.Michael, Barbados
TEL: (246)430-1100

BRAZIL
Roland Brasil Ltda.
Rua San Jose, 780 Sala B
Parque Industrial San Jose
Cotia - Sao Paulo - SP, BRAZIL
TEL: (011) 4615 5666

CHILE
Comercial Fancy II S.A.
Rut.: 96.919.420-1
Nataaniel Cox #739, 4th Floor
Santiago - Centro, CHILE
TEL: (02) 688-9540

COLOMBIA
Centro Musical Ltda.
Cra 43 B No 25 A 41 Bododega 9
Medellin, Colombia
TEL: (574)3812529

CURACAO
Zeelandia Music Center Inc.
Oronoweg 30
Curacao, Netherland Antilles
TEL:(305)5926866

DOMINICAN REPUBLIC
Instrumentos Fernando Giraldez
Calle Proyecto Central No.3
Ens.La Esperilla
Santo Domingo,
Dominican Republic
TEL:(809) 683 0305

ECUADOR
Mas Musica
Rumichaca 822 y Zaruma
Guayaquil - Ecuador
TEL:(593-4)2302364

GUATEMALA
Casa Instrumental
Calle Roosevelt 34-01, zona 11
Ciudad de Guatemala
Guatemala
TEL:(502) 599-2888

HONDURAS
Almacen Pajaro Azul S.A. de C.V.
BO.Paz Barahona
3 Ave.11 Calle S.O
San Pedro Sula, Honduras
TEL: (504) 553-2029

MARTINIQUE
Musique & Son
Z.LLes Mangle
97232 Le Lamantin
Martinique F.W.I.
TEL: 596 596 426680

Gigamusic SARL
10 Rue De La Folle
97200 Fort De France
Martinique F.W.I.
TEL: 596 596 715222

MEXICO
Casa Veerkamp, s.a. de c.v.
Av. Toluca No. 323, Col. Olivar
de los Padres 01780 Mexico
D.F. MEXICO
TEL: (55) 5668-6999

NICARAGUA
Bansbach Instrumentos
Musicales Nicaragua
Altamira D'Este Calle Principal
de la Farmacia Sta.Avenida
1 Cuadra al Lago.#503
Managua, Nicaragua
TEL: (505)277-2557

PERU
Audionet
Distribuciones Musicales SAC
Juan Fanning 530
Miraflores
Lima - Peru
TEL: (511) 4461388

TRINIDAD
AMR Ltd
Ground Floor
Maritime Plaza
Barataria Trinidad W.I.
TEL: (868)638 6385

URUGUAY
Todo Musica S.A.
Francisco Acuna de Figueroa 1771
C.P.: 11.800
Montevideo, URUGUAY
TEL: (02) 924-2335

VENEZUELA
Instrumentos Musicales
Allegro,C.A.
Av.las industrias edf.Guitar
import
#7 zona Industrial de Turumo
Caracas, Venezuela
TEL: (212) 244-1122

EUROPE

AUSTRIA
Roland Elektronische
Musikinstrumente HmbH.
Austrian Office
Eduard-Bodem-Gasse 8,
A-6020 Innsbruck, AUSTRIA
TEL: (0512) 26 44 260

BELGIUM/FRANCE/ HOLLAND/ LUXEMBOURG
Roland Central Europe N.V.
Houtstraat 3, B-2260, Oevel
(Westerlo) BELGIUM
TEL: (014) 575811

CZECH REP.
K-AUDIO
Kardarsovska 626,
CZ-198 00 Praha 9,
CZECH REP.
TEL: (2) 666 10529

DENMARK
Roland Scandinavia A/S
Nordhavnsvej 7, Postbox 880,
DK-2100 Copenhagen
DENMARK
TEL: 3916 6200

FINLAND
Roland Scandinavia As, Filial
Finland
Elannontie 5
FIN-01510 Vantaa, FINLAND
TEL: (09) 68 24 020

GERMANY
Roland Elektronische
Musikinstrumente HmbH.
Osttrasse 96, 22844
Nordstedt, GERMANY
TEL: (040) 52 60090

GREECE
STOLLAS S.A.
Music Sound Light
155, New National Road
Patras 26442, GREECE
TEL: 2610 435400

HUNGARY
Roland East Europe Ltd.
Warehouse Area 'DEPO' Pf.83
H-2046 Torokbalint,
HUNGARY
TEL: (23) 511011

IRELAND
Roland Ireland
G2 Calmout Park, Calmout
Avenue, Dublin 12
Republic of IRELAND
TEL: (01) 4294444

ITALY
Roland Italy S. p. A.
Viale delle Industrie 8,
20020 Arese, Milano, ITALY
TEL: (02) 937-78300

NORWAY
Roland Scandinavia Avd.
Kontor Norge
Lilleservietten 2 Postboks 95
Lilleaker N-0216 Oslo
NORWAY
TEL: 2273 0074

POLAND
MX MUSIC SP.Z.O.O.
UL. Gibraltarska 4,
PL-03664 Warszawa POLAND
TEL: (22) 608 00 60

PORTUGAL
Roland Iberia, S.L.
Portugal Office
Cais das Pedras, 8/9-1 Dto
4050-465, Porto, PORTUGAL
TEL: (21) 208 00 60

ROMANIA
FBS LINES
Piata Libertatii 1,
535500 Gheorgheni,
ROMANIA
TEL: (266) 364 609

RUSSIA
MuTeK
Dorozhnaya ul.3,korp.6
117 545 Moscow, RUSSIA
TEL: (095) 981-4967

SPAIN
Roland Iberia, S.L.
Paseo Garcia Faria, 33-35
08005 Barcelona SPAIN
TEL: 93 493 91 00

SWEDEN
Roland Scandinavia A/S
SWEDISH SALES OFFICE
Danvik Center 28, 2 tr.
S-131 30 Nacka SWEDEN
TEL: (08) 702 00 20

SWITZERLAND
Roland (Switzerland) AG
Landstrasse 5, Postfach,
CH-4452 Hingen,
SWITZERLAND
TEL: (061) 927-8383

UKRAINE
TIC-TAC
Mira Str. 19/108
P.O. Box 180
295400 Mukachevo,
UKRAINE
TEL: (03131) 414-40

UNITED KINGDOM
Roland (U.K.) Ltd.
Atlantic Close, Swansea
Enterprise Park, SWANSEA
SA7 9FJ,
UNITED KINGDOM
TEL: (01792) 702701

MIDDLE EAST

BAHRAIN
Moon Stores
No.16, Bab Al Bahrain Avenue,
P.O.Box 247, Manama 304,
State of BAHRAIN
TEL: 17 211 005

CYPRUS
Radex Sound Equipment Ltd.
17, Diagourou Street, Nicosia,
CYPRUS
TEL: (022) 66-9426

IRAN
MOCO INC.
No.41 Nike St., Dr.Shariyati Av.,
Roberoy Ceraha Mirdamad
Tehran, IRAN
TEL: (021) 285-4169

ISRAEL
Halilit P. Greenspoon & Sons Ltd.
8 Retzif Ha'aliya Hashnya St.
Tel-Aviv-Yafo ISRAEL
TEL: (03) 6823666

JORDAN
MUSIC HOUSE CO. LTD.
FREDDY FOR MUSIC
P. O. Box 922846
Amman 11192 JORDAN
TEL: (06) 5692696

KUWAIT
EASA HUSAIN AL-YOUSIFI
& SONS CO.
Abdullah Salem Street,
Safat, KUWAIT
TEL: 243-6399

LEBANON
Chahine S.A.L.
Gerge Zeidan St., Chahine
Bldg., Achrafieh, P.O.Box: 16-
5857
Beirut, LEBANON
TEL: (01) 20-1441

OMAN
TALENTZ CENTRE L.L.C.
Malatan House No.1
Al Noor Street, Ruwi
SULTANATE OF OMAN
TEL: 2478 3443

QATAR
Badie Studio & Stores
P.O. Box 62,
Doha, QATAR
TEL: 423554

SAUDI ARABIA
aDawiah Universal
Electronics APL
Corniche Road, Aldossary
Bldg., 1st Floor, Alkhobar,
SAUDI ARABIA

P.O.Box 2154, Alkhubar 31952
SAUDI ARABIA
TEL: (03) 898 2081

SYRIA
Technical Light & Sound Center
Rawda, Abdul Qader Jazairi St.
Bldg. No. 21, P.O.BOX 13520,
Damascus, SYRIA
TEL: (011) 223-5384

TURKEY
ZUHAI DIS TICARET A.S.
Galip Dede Cad. No.37
Beyoglu - Istanbul / TURKEY
TEL: (0212) 249 85 10

U.A.E.
Zak Electronics & Musical Instruments Co. L.L.C.
Zabeel Road, Al Sherooq Bldg.,
No. 14, Grand Floor, Dubai,
U.A.E.
TEL: (04) 3360715

As of December 10, 2005 (EDIROL-1)



Free Manuals Download Website

<http://myh66.com>

<http://usermanuals.us>

<http://www.somanuals.com>

<http://www.4manuals.cc>

<http://www.manual-lib.com>

<http://www.404manual.com>

<http://www.luxmanual.com>

<http://aubethermostatmanual.com>

Golf course search by state

<http://golfingnear.com>

Email search by domain

<http://emailbydomain.com>

Auto manuals search

<http://auto.somanuals.com>

TV manuals search

<http://tv.somanuals.com>