

EDIROL

4-CHANNEL PORTABLE RECORDER and WAVE EDITOR **R-4**

Owner's Manual

Before using this unit, carefully read the sections entitled: "USING THE UNIT SAFELY" and "IMPORTANT NOTES" (p. 3–p. 6). These sections provide important information concerning the proper operation of the unit. Additionally, in order to feel assured that you have gained a good grasp of every feature provided by your new unit, Owner's Manual should be read in its entirety. The manual should be saved and kept on hand as a convenient reference.



Copyright © 2005 ROLAND CORPORATION

All rights reserved. No part of this publication may be reproduced in any form without the written permission of ROLAND CORPORATION.

For EU Countries

Apparatus containing Lithium batteries

ADVARSEL!

Lithumbatteri - Eksplosionsfare ved fejlagtig håndtering. Udskiftning må kun ske med batteri af samme fabrikat og type. Levér det brugte batteri tilbage til leverandøren.

ADVARSEL

Eksplosjonsfare ved feilaktig skifte av batteri. Benytt samme batteritype eller en tilsvarende type anbefalt av apparatfabrikanten. Brukte batterier kasseres i henhold til fabrikantens instruksjoner.

CAUTION

Danger of explosion if battery is incorrectly replaced. Replace only with the same or equivalent type recommended by the manufacturer. Discard used batteries according to the manufacturer's instructions.

VARNING

Explosionsfara ved felaktigt batteribyte. Använd samma batterityp eller en ekvivalent typ som rekommenderas av apparatillverkaren. Kassera använt batteri enligt fabrikantens instruktion.

VAROITUS

Paristo voi räjähtää, jos se on virheellisesti asennettu. Vaihda paristo ainoastaan laitevalmistajan suosittelemaan tyyppiin. Hävitä käytetty paristo valmistajan ohjeiden mukaisesti.

For EU Countries



This product complies with the requirements of European Directive 89/336/EEC.

For the USA

FEDERAL COMMUNICATIONS COMMISSION RADIO FREQUENCY INTERFERENCE STATEMENT

This equipment has been tested and found to comply with the limits for a Class B digital device, pursuant to Part 15 of the FCC Rules. These limits are designed to provide reasonable protection against harmful interference in a residential installation. This equipment generates, uses, and can radiate radio frequency energy and, if not installed and used in accordance with the instructions, may cause harmful interference to radio communications. However, there is no guarantee that interference will not occur in a particular installation. If this equipment does cause harmful interference to radio or television reception, which can be determined by turning the equipment off and on, the user is encouraged to try to correct the interference by one or more of the following measures:

- Reorient or relocate the receiving antenna.
- Increase the separation between the equipment and receiver.
- Connect the equipment into an outlet on a circuit different from that to which the receiver is connected.
- Consult the dealer or an experienced radio/TV technician for help.

This device complies with Part 15 of the FCC Rules. Operation is subject to the following two conditions:

- (1) This device may not cause harmful interference, and
- (2) This device must accept any interference received, including interference that may cause undesired operation.

Unauthorized changes or modification to this system can void the users authority to operate this equipment. This equipment requires shielded interface cables in order to meet FCC class B Limit.

For Canada

NOTICE

This Class B digital apparatus meets all requirements of the Canadian Interference-Causing Equipment Regulations.



AVIS

Cet appareil numérique de la classe B respecte toutes les exigences du Règlement sur le matériel brouilleur du Canada.







USING THE UNIT SAFELY

INSTRUCTIONS FOR THE PREVENTION OF FIRE, ELECTRIC SHOCK, OR INJURY TO PERSONS

About  WARNING and  CAUTION Notices







 WARNING	Used for instructions intended to alert the user to the risk of death or severe injury should the unit be used improperly.
 CAUTION	Used for instructions intended to alert the user to the risk of injury or material damage should the unit be used improperly. * Material damage refers to damage or other adverse effects caused with respect to the home and all its furnishings, as well to domestic animals or pets.

About the Symbols







	The  symbol alerts the user to important instructions or warnings. The specific meaning of the symbol is determined by the design contained within the triangle. In the case of the symbol at left, it is used for general cautions, warnings, or alerts to danger.
	The  symbol alerts the user to items that must never be carried out (are forbidden). The specific thing that must not be done is indicated by the design contained within the circle. In the case of the symbol at left, it means that the unit must never be disassembled.
	The  symbol alerts the user to things that must be carried out. The specific thing that must be done is indicated by the design contained within the circle. In the case of the symbol at left, it means that the power-cord plug must be unplugged from the outlet.

ALWAYS OBSERVE THE FOLLOWING







WARNING

- Before using this unit, make sure to read the instructions below, and the Owner's Manual. 
- Do not open (or modify in any way) the unit or its AC adaptor. 
- Do not attempt to repair the unit, or replace parts within it (except when this manual provides specific instructions directing you to do so). Refer all servicing to your retailer, the nearest Roland Service Center, or an authorized Roland distributor, as listed on the "Information" page. 
- Never use or store the unit in places that are:
 - Subject to temperature extremes (e.g., direct sunlight in an enclosed vehicle, near a heating duct, on top of heat-generating equipment); or are 
 - Damp (e.g., baths, washrooms, on wet floors); or are 
 - Humid; or are
 - Exposed to rain; or are
 - Dusty; or are
 - Subject to high levels of vibration.
- Make sure you always have the unit placed so it is level and sure to remain stable. Never place it on stands that could wobble, or on inclined surfaces. 
- Be sure to use only the AC adaptor supplied with the unit. Also, make sure the line voltage at the installation matches the input voltage specified on the AC adaptor's body. Other AC adaptors may use a different polarity, or be designed for a different voltage, so their use could result in damage, malfunction, or electric shock. 







WARNING

- Use only the attached power-supply cord. Also, the supplied power cord must not be used with any other device. 
- Do not excessively twist or bend the power cord, nor place heavy objects on it. Doing so can damage the cord, producing severed elements and short circuits. Damaged cords are fire and shock hazards! 
- This unit, either alone or in combination with an amplifier and headphones or speakers, may be capable of producing sound levels that could cause permanent hearing loss. Do not operate for a long period of time at a high volume level, or at a level that is uncomfortable. If you experience any hearing loss or ringing in the ears, you should immediately stop using the unit, and consult an audiologist. 
- Do not allow any objects (e.g., flammable material, coins, pins); or liquids of any kind (water, soft drinks, etc.) to penetrate the unit. 

- Immediately turn the power off, remove the AC adaptor from the outlet, and request servicing by your retailer, the nearest Roland Service Center, or an authorized Roland distributor, as listed on the "Information" page when:
 - The AC adaptor, the power-supply cord, or the plug has been damaged; or
 - If smoke or unusual odor occurs
 - Objects have fallen into, or liquid has been spilled onto the unit; or
 - The unit has been exposed to rain (or otherwise has become wet); or
 - The unit does not appear to operate normally or exhibits a marked change in performance.









WARNING

- In households with small children, an adult should provide supervision until the child is capable of following all the rules essential for the safe operation of the unit. 
- Protect the unit from strong impact. (Do not drop it!) 
- Do not force the unit's power-supply cord to share an outlet with an unreasonable number of other devices. Be especially careful when using extension cords—the total power used by all devices you have connected to the extension cord's outlet must never exceed the power rating (watts/amperes) for the extension cord. Excessive loads can cause the insulation on the cord to heat up and eventually melt through. 
- Before using the unit in a foreign country, consult with your retailer, the nearest Roland Service Center, or an authorized Roland distributor, as listed on the "Information" page. 
- Batteries must never be recharged, heated, taken apart, or thrown into fire or water. 

CAUTION

- The unit and the AC adaptor should be located so their location or position does not interfere with their proper ventilation. 
- Always grasp only the plug on the AC adaptor cord when plugging into, or unplugging from, an outlet or this unit. 
- At regular intervals, you should unplug the AC adaptor and clean it by using a dry cloth to wipe all dust and other accumulations away from its prongs. Also, disconnect the power plug from the power outlet whenever the unit is to remain unused for an extended period of time. Any accumulation of dust between the power plug and the power outlet can result in poor insulation and lead to fire. 
- Try to prevent cords and cables from becoming entangled. Also, all cords and cables should be placed so they are out of the reach of children. 
- Never climb on top of, nor place heavy objects on the unit. 
- Never handle the AC adaptor or its plugs with wet hands when plugging into, or unplugging from, an outlet or this unit. 

CAUTION

- Before moving the unit, disconnect the AC adaptor and all cords coming from external devices. 
- Before cleaning the unit, turn off the power and unplug the AC adaptor from the outlet. 
- Whenever you suspect the possibility of lightning in your area, disconnect the AC adaptor from the outlet. 
- If used improperly, batteries may explode or leak and cause damage or injury. In the interest of safety, please read and observe the following precautions (p. 25). 

 - Carefully follow the installation instructions for batteries, and make sure you observe the correct polarity. 
 - Avoid using new batteries together with used ones. In addition, avoid mixing different types of batteries.
 - Remove the batteries whenever the unit is to remain unused for an extended period of time.
 - If a battery has leaked, use a soft piece of cloth or paper towel to wipe all remnants of the discharge from the battery compartment. Then install new batteries. To avoid inflammation of the skin, make sure that none of the battery discharge gets onto your hands or skin. Exercise the utmost caution so that none of the discharge gets near your eyes. Immediately rinse the affected area with running water if any of the discharge has entered the eyes.
 - Never keep batteries together with metallic objects such as ballpoint pens, necklaces, hairpins, etc.
- Used batteries must be disposed of in compliance with whatever regulations for their safe disposal that may be observed in the region in which you live. 
- Should you remove the ground terminal screw, keep them in a safe place out of children's reach, so there is no chance of them being swallowed accidentally. 
- Always turn the phantom power off when connecting any device other than condenser microphones that require phantom power. You risk causing damage if you mistakenly supply phantom power to dynamic microphones, audio playback devices, or other devices that don't require such power. Be sure to check the specifications of any microphone you intend to use by referring to the manual that came with it. This instrument's phantom power: 48V DC, 8 mA Max (total of all channels must be 25 mA or less) 

Important Notes

In addition to the items listed under “USING THE UNIT SAFELY” on page 3, please read and observe the following:

Power Supply: Use of Batteries

- Do not connect this unit to same electrical outlet that is being used by an electrical appliance that is controlled by an inverter (such as a refrigerator, washing machine, microwave oven, or air conditioner), or that contains a motor. Depending on the way in which the electrical appliance is used, power supply noise may cause this unit to malfunction or may produce audible noise. If it is not practical to use a separate electrical outlet, connect a power supply noise filter between this unit and the electrical outlet.
- The AC adaptor will begin to generate heat after long hours of consecutive use. This is normal, and is not a cause for concern.
- The use of an AC adaptor is recommended as the unit’s power consumption is relatively high. Should you prefer to use batteries, please use the alkaline or nickel metal hydride type.
- When installing or replacing batteries, always turn off the power on this unit and disconnect any other devices you may have connected. This way, you can prevent malfunction and/or damage to speakers or other devices.
- Before connecting this unit to other devices, turn off the power to all units. This will help prevent malfunctions and/or damage to speakers or other devices.

Placement

- Using the unit near power amplifiers (or other equipment containing large power transformers) may induce hum. To alleviate the problem, change the orientation of this unit; or move it farther away from the source of interference.
- This device may interfere with radio and television reception. Do not use this device in the vicinity of such receivers.
- Noise may be produced if wireless communications devices, such as cell phones, are operated in the vicinity of this unit. Such noise could occur when receiving or initiating a call, or while conversing. Should you experience such problems, you should relocate such wireless devices so they are at a greater distance from this unit, or switch them off.
- Do not expose the unit to direct sunlight, place it near devices that radiate heat, leave it inside an enclosed vehicle, or otherwise subject it to temperature extremes. Excessive heat can deform or discolor the unit.
- When moved from one location to another where the temperature and/or humidity is very different, water droplets (condensation) may form inside the unit. Damage or malfunction may result if you attempt to use the unit in this condition. Therefore, before using the unit, you must allow it to stand for several hours, until the condensation has completely evaporated.

Maintenance

- For everyday cleaning wipe the unit with a soft, dry cloth or one that has been slightly dampened with water. To remove stubborn dirt, use a cloth impregnated with a mild, non-abrasive detergent. Afterwards, be sure to wipe the unit thoroughly with a soft, dry cloth.
- Never use benzene, thinners, alcohol or solvents of any kind, to avoid the possibility of discoloration and/or deformation.

Repairs and Data

- Please be aware that all data contained in the unit’s memory may be lost when the unit is sent for repairs. Important data should always be backed up on a CompactFlash, your computer, or written down on paper (when possible). During repairs, due care is taken to avoid the loss of data. However, in certain cases (such as when circuitry related to memory itself is out of order), we regret that it may not be possible to restore the data, and Roland assumes no liability concerning such loss of data.

Memory Backup

- The R-4 contains a battery that keeps the internal clock running even when the power is turned off. When this battery runs low, the message shown below will appear in the display. Replace the battery as soon as possible, since the clock will not keep the correct time if the battery is low. To have the battery replaced, consult with your retailer, the nearest Roland Service Center, or an authorized Roland distributor, as listed on the “Information” page.
Int-Batt Low!

Additional Precautions

- Please be aware that the contents of memory can be irretrievably lost as a result of a malfunction, or the improper operation of the unit. To protect yourself against the risk of losing important data, we recommend that you periodically save a backup copy of important data you have stored in the unit’s memory on a CompactFlash or your computer.
- Unfortunately, it may be impossible to restore the contents of data that was stored on a hard disk, or a CompactFlash once it has been lost. Roland Corporation assumes no liability concerning such loss of data.
- Use a reasonable amount of care when using the unit’s buttons, sliders, or other controls; and when using its jacks and connectors. Rough handling can lead to malfunctions.
- Never strike or apply strong pressure to the display.
- When connecting / disconnecting all cables, grasp the connector itself—never pull on the cable. This way you will avoid causing shorts, or damage to the cable’s internal elements.

Important Notes

- To avoid disturbing your neighbors, try to keep the unit's volume at reasonable levels. You may prefer to use headphones, so you do not need to be concerned about those around you (especially when it is late at night).
- When you need to transport the unit, package it in the box (including padding) that it came in, if possible. Otherwise, you will need to use equivalent packaging materials.
- Use a cable from Roland to make the connection. If using some other make of connection cable, please note the following precautions.
 - Some connection cables contain resistors. Do not use cables that incorporate resistors for connecting to this unit. The use of such cables can cause the sound level to be extremely low, or impossible to hear. For information on cable specifications, contact the manufacturer of the cable.

Before Using Cards

- Carefully insert the DATA card all the way in—until it is firmly in place.

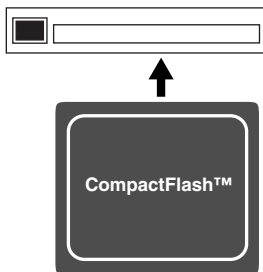

- Never touch the terminals of the DATA card. Also, avoid getting the terminals dirty.
- This unit's memory card slot accepts CompactFlash memory cards. Microdrive storage media are not compatible.

Handling Hard Disks

- Once a hard disk fails to function normally, all data that has been stored on it could be destroyed. **All hard disks eventually wear out.** We recommend that you consider the hard disk not as a permanent storage site, but as a place to store data temporarily. We also recommend that you back up important performance and image data that cannot be recorded again onto the external media that is supported by your device. For instructions on how to make such backups, refer to the owner's manual for your device.
Note that Roland assumes no liability whatsoever, including monetary compensation, for the loss of any recorded content in the event of the malfunction of, or physical damage to the hard disk, or for any direct or incidental damages resulting from the loss of such data.

Precautions Regarding Setup and Use

- Certain hard disk setup procedures and usage conditions may result in the corruption of recorded data, malfunctioning, or physical damage to the disk, so be sure to observe the following precautions.
 - Do not subject the hard disk to vibration or shock, especially while the unit is in operation.
 - Do not set up the unit in any location where it may be affected by vibration from external sources, or on any surface that is not stable and level.
 - If the device includes a cooling fan, ensure that the fan and the side panel air vents remain unobstructed.
 - Do not leave the unit in any environment subject to temperature extremes; for example, in a closed automobile in summer or outdoors during winter.
 - Do not use the unit in conditions of high temperature and humidity or in any location subject to rapid temperature changes.
 - Do not unplug the power cord or switch off any circuit breakers in the circuit to which the unit is connected while the power is turned on.

Emergency Procedures

- * The following procedures are to be used as emergency measures only, and are not recommended for normal operation.
- If the device fails to respond to operational commands or does not complete operations, turn off the power. If the power does not shut off following normal shutdown procedures, disconnect the power plug.
If the unit does not operate normally when the power is turned on again, it may mean that the hard disk has been damaged. In such instances, consult your dealer or the nearest Roland Service Center. Note, however, that it may not be possible to recover any data from the hard disk once it has been lost.

Copyright

- Unauthorized recording, distribution, sale, lending, public performance, broadcasting, or the like, in whole or in part, of a work (musical composition, video, broadcast, public performance, or the like) whose copyright is held by a third party is prohibited by law.
- When exchanging audio signals through a digital connection with an external instrument, this unit can perform recording without being subjected to some of the restrictions of the Serial Copy Management System (SCMS). This is because the unit is intended solely for musical production, and is designed not to be subject to restrictions as long as it is used to record works (such as your own compositions) that do not infringe on the copyrights of others. (SCMS is a feature that prohibits second-generation and later copying through a digital connection. It is built into MD recorders and other consumer digital-audio equipment as a copyright-protection feature.)
- Do not use this unit for purposes that could infringe on a copyright held by a third party. We assume no responsibility whatsoever with regard to any infringements of third-party copyrights arising through your use of this unit.

Contents

Checking the included items	8	Application guide	75
Introducing the R-4	9	Connecting an external mic for CD-quality stereo recording	75
The R-4's controls and connectors	9	Recording birdsongs outdoors	76
Display	18	Recording audio while shooting video	77
What is a project?	21	Recording audio memos using just the R-477 Simultaneously recording environmental sounds (ambience).....	78
Getting ready to use the R-4 ...	23	Simultaneously recording at different input levels	78
Basic connection examples	23	Messages	79
Connecting the AC adaptor and turning the power on	24	Troubleshooting.....	80
Installing batteries and turning the power on	25	Computer-related problems	80
Recording	27	Recording-related problems	80
Recording from a connected mic	27	Playback-related problems	82
Recording from the internal mics	30	Problems with the R-4's operation.....	83
Recording digital audio from a digital device	31	Main specifications	84
Recording analog audio	32	Block diagram	86
Playing back.....	34	<i>Deutsch</i>	
Connections before playback	34	Beschreibung des R-4	88
Settings before playback	36	<i>Français</i>	
Playing back.....	38	Présentation du R-4	94
The Finder screen	41	<i>Italiano</i>	
Selecting a project (Select).....	41	Presentazione dell'R-4	100
Deleting a project (Delete)	42	<i>Español</i>	
Renaming a project (Rename)	43	Presentación del R-4	106
Copying a project (Copy).....	44		
Moving a project (Move).....	45		
Creating a new folder (Make Folder).....	46		
Editing	48		
Editing procedure	48		
Effects setting	55		
Effects.....	56		
Using effects.....	58		
System settings	60		
System Menu	60		
Example operations	65		
Appendix.....	70		
Handling memory cards	70		
Connection to a computer.....	72		
Connecting a video device that has a LANC connector	74		
		Index	112

Checking the included items

The R-4 comes with the following items. Immediately after opening the package, please check that you have all of these items. If any items are missing, please contact the dealer where you purchased the R-4.

■ R-4

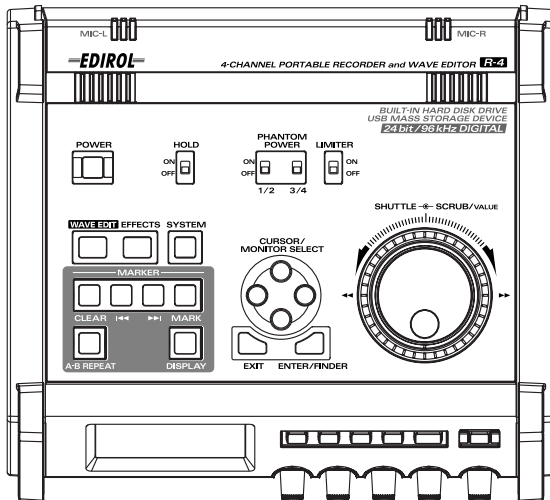

■ AC adaptor

This AC adaptor is designed specifically for the R-4. Do not attempt to use any other adaptor with the R-4.



“Connecting the AC adaptor and turning the power on” (p. 24)

■ USB cable (1 meter)

You can use this cable to connect the R-4 to the USB connector of your computer.



“Connection to a computer” (p. 72)

* If the AC adaptor or USB cable becomes damaged or if you need a replacement for any reason, please contact one of the Service Centers listed in the “Information” section at the end of this manual.

* Don't remove the ferrite core that's attached to the USB cable.

■ Carrying case

You can use this case to protect the R-4 while it is being transported or stored.

■ Owner's manual

This is the document you're reading. Keep it at hand for easy reference.

Introducing the R-4

The R-4's controls and connectors

Top panel

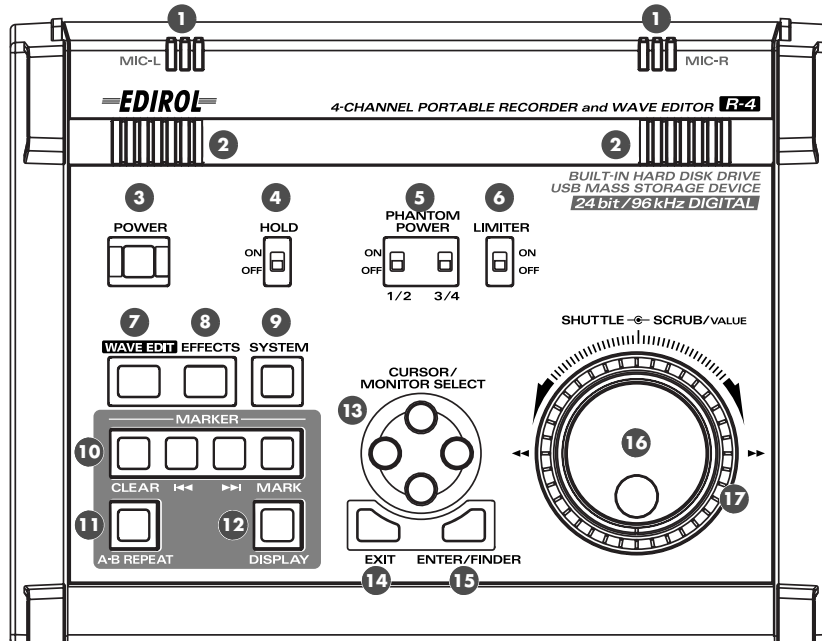

1 Internal mics [MIC-L, MIC-R]

These are stereo mics built into the R-4. The audio entering MIC-L is recorded on the 1L channel, while audio picked up by MIC-R is recorded on the 1R channel. If you're recording via the internal mics, set the System Settings menu item **Recording Setup** to **Int-Mic**. For details, refer to "**Recording from the internal mics**" (p. 30).

* Don't connect anything to input jacks you're not using.

2 Internal speakers

These are built-in speakers for monitoring. If you want sound to be heard from the internal speakers, set the System Settings menu item **Speaker** to **ON**. For details, refer to "**Playing back**" (p. 34).

* No sound will be heard from the internal speakers if you've connected headphones to the **Headphone jack** (37). Nor will sound be heard from the internal speakers while recording or in recording-standby mode; this prevents acoustic feedback from occurring.

3 Power switch [POWER]

This turns the power on/off. To turn the power on or off, press and hold the power switch for about two seconds. The power switch is lit green when the power is on. Don't turn the power off during recording or playback. Before you turn off the power, you must make sure that recording or playback is stopped.

* If you accidentally turn off the power during recording, the data that was being recorded will not be stored on the hard disk.

* The hard disk may be damaged if you turn off the power of the R-4 while data is being read from or written to the hard disk (such as during recording or playback). You must also be careful not to turn off the power while data is being transferred between the hard disk and the CompactFlash card.

* Never turn off the power while the R-4's display indicates **Now Connecting...** or **Now Processing!** Doing so will cause the R-4 to become unstable, and could even damage the internal hard disk.

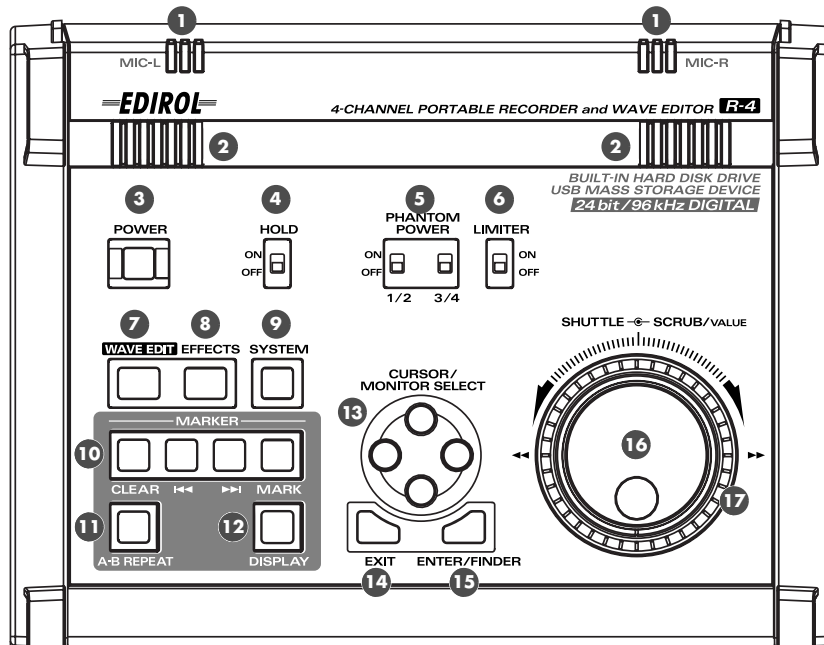

4 Hold switch [HOLD]

By selecting the **HOLD ON** position, you can disable the panel buttons so that unwanted operations will not occur if a button is pressed accidentally.

However, even if this switch is set to **HOLD ON**, the **phantom power switches** 5, **limiter switch** 6, **input level select switches** 38, **Input level knobs** 25, and **Monitor level knob** 26 will still be operable.

5 Phantom power switches [PHANTOM POWER]

These switch the phantom power on/off for the XLR type connectors of the combo input jacks located on the right panel. Since separate switches are provided for channels 1/2 and channels 3/4, you can turn phantom power on/off separately for these channels.

** Always turn the phantom power off when connecting any device other than condenser microphones that require phantom power. You risk causing damage if you mistakenly supply phantom power to dynamic microphones, audio playback devices, or other devices that don't require such power. Be sure to check the specifications of any microphone you intend to use by referring to the manual that came with it.*

*This instrument's phantom power: 48 V DC, 8 mA Max
(total of all channels must be 25 mA or less)*

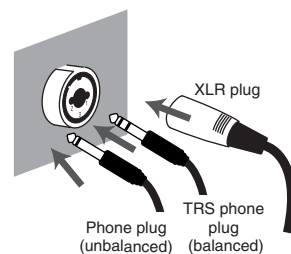

6 Limiter switch [LIMITER]

This is an on/off switch for an input level limiter in the analog circuitry.

When the input level is too high, the limiter compresses the input level appropriately to prevent distortion. The limiter switch turns limiting on/off for all channels 1-4 together. However, the input level is detected separately for each channel. You cannot turn the limiter on/off separately for each channel.

7 Wave edit button [WAVE EDIT]

This button takes you to Wave Edit mode, where you can edit the waveform using operations such as Trim, Divide, Combine, and Merge. For details, refer to “Editing” (p. 48). You won't be able to enter Wave Edit mode during playback or recording, or if the R-4's hard disk contains no files that the R-4 can handle. WAV files are the only type of files that the R-4 can handle.

8 Effect button [EFFECTS]

This button takes you to Effect mode, where you can make effect settings. For details, refer to “Effects setting” (p. 55).

9 System button [SYSTEM]

This button takes you to a mode where you can make various settings for the R-4. For details, refer to “System settings” (p. 60).

10 Marker [MARKER]

Clear button [CLEAR]

This button deletes a marker you assigned using the **Mark button**. Markers will be deleted successively, starting at the marker located immediately before the current location.

◀◀ button

This button moves you to the marker that is immediately before the current location (the previous marker).

▶▶ button

This button moves you to the marker that is immediately after the current location (the next marker).

Mark button [MARK]

By pressing this button you can assign a marker to a desired location in the project file. Markers are numbered sequentially starting at the beginning of the project.

11 A-B Repeat button [A-B REPEAT]

This button lets you repeatedly play back the region between two points (A and B) in the project. Simply assign marker A and marker B while the project is playing, and playback will repeat between markers A and B.

1. During playback, press the **A-B Repeat button** once. That point becomes the beginning (marker A) of repeat playback.

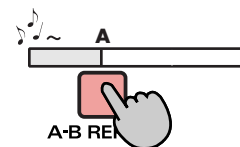

2. Press the **A-B Repeat button** once again. That point will be the end (marker B) of repeat playback.

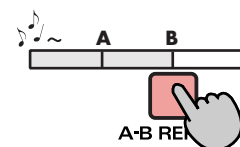

The region you specified in steps 1 and 2 will play repeatedly. To cancel repeat playback, press the **A-B Repeat button** once again.

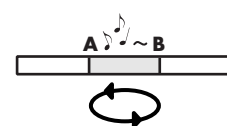

12 Display button [DISPLAY]

This button switches the contents of the R-4's display. For details, refer to “Display” (p. 18).

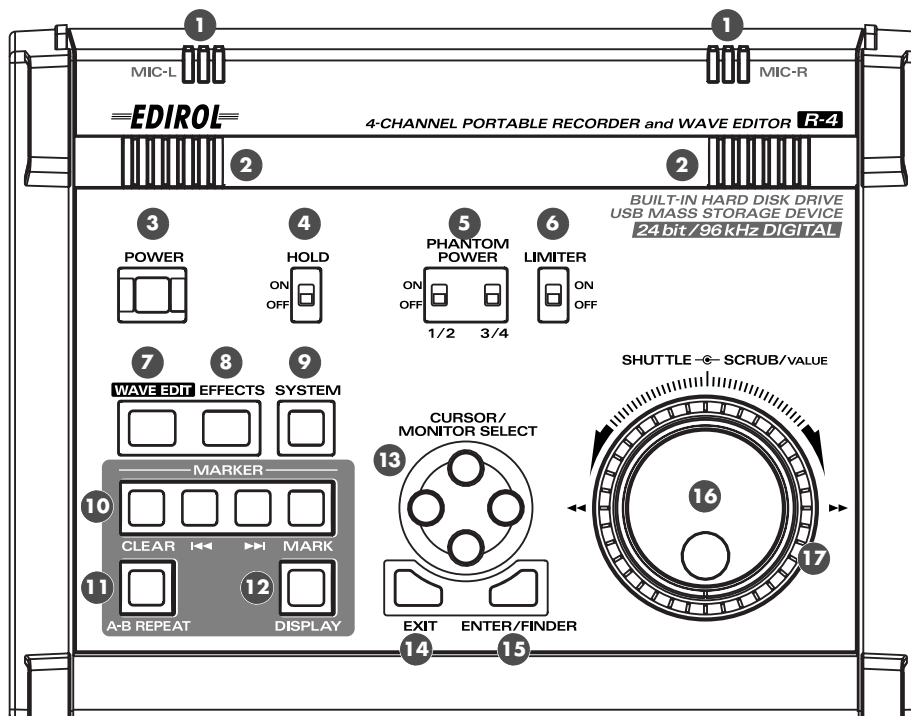

13 Cursor/Monitor Select buttons [CURSOR/MONITOR SELECT]

Use these buttons to select items shown in the display. When you're in the main screen, you can press the up/down buttons to select the channel that you want to monitor. For details, refer to "Display" (p. 18).

14 Exit button [EXIT]

Use this button to return to the previous screen or to cancel an operation.

15 Enter/Finder button [ENTER/FINDER]

Use this button to confirm a setting or finalize a value. You can also press this when you want to use the Finder function. For more about the Finder function, refer to "The Finder screen" (p. 41).

16 Scrub dial [SCRUB/VALUE]

Use this dial to select among items for which settings are made, or to modify a value. While stopped or when playback is paused, you can turn the scrub dial to move the current location forward or backward.

17 Shuttle dial [SHUTTLE]

While the project is playing, turn this dial clockwise to play rapidly forward, or counterclockwise to play rapidly backward. When the project is stopped, this dial advances the time counter.

Front panel

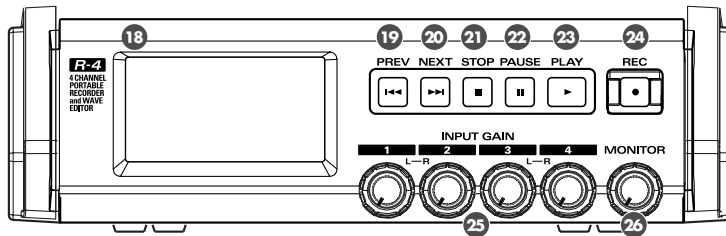

18 Display

This shows various information about the R-4's status. For details, refer to “Display” (p. 18).

19 PREV button [PREV]

Pressing the **PREV button** while a project is playing or stopped will take you to the beginning of the project (00:00:00). Pressing this button at the beginning of a project will take you to the preceding project. You can also press and hold down this button to rewind. This is available both while playing and while stopped.

* If the system setting **Player Setup** parameter **Play Mode** is set to **Single**, you can't move to the previous or next project during playback.

20 NEXT button [NEXT]

Pressing the **NEXT button** will take you to the next project. You can also press and hold this button to fast-forward. This is available both while playing and while stopped.

* If the system setting **Player Setup** parameter **Play Mode** is set to **Single**, you can't move to the previous or next project during playback.

21 Stop button [STOP]

This button stops playback or recording. If you press the **STOP button** during playback, the counter will maintain the time at which you pressed the **STOP button**.

22 Pause button [PAUSE]

This button pauses playback or recording.

23 Play button [PLAY]

This button starts playback. The **PLAY button** is lit blue during playback.

During playback, you can press the **PLAY button** once again to play at double-speed. During double-speed playback, press the **PLAY button** once again to return to normal playback. During double-speed playback, the lower part of the display will indicate **PLAY X2**. Double-speed playback will change the pitch.

* If you want to turn off the double-speed playback feature, go to the System Settings menu and in **Player Setup**, turn **X2 Play OFF**. For details, refer to “2 Player Setup” (p. 62).

24 Record button [REC]

Recording will begin immediately when you press the **REC button**. The **REC button** is lit red during recording. If you hold down the **PAUSE button** and press the **REC button**, the **REC button** will blink red, and the R-4 enters recording-standby mode. Recording will begin when you then press the **REC button** or **PAUSE button**.

25 Input level knobs 1–4 [INPUT GAIN]

These knobs adjust the input level of **combo input jacks 1–4** (39). Input levels of the **internal mics** (1) are adjusted by **knob 1** (MIC-L) and **knob 2** (MIC-R).

26 Monitor level knob [MONITOR]

This adjusts the output volume of the **internal speakers** (2) and the **headphone jack** (37).

You can't adjust the volume of the **line output jacks** (40). If you need to adjust the volume of the line output jacks, adjust the controls of the external speakers or playback system connected to the line output jacks.

Side panel (left)

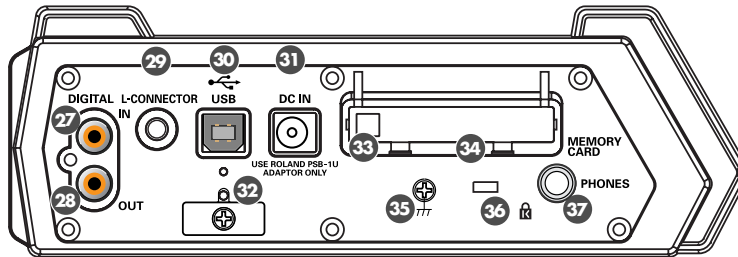

27 Digital input connector [DIGITAL IN]

If you want to record a digital signal, connect a coaxial-type cable to this connector. The digital input signal is recorded in stereo on channels 1L and 1R. If you want to record in monaural, you'll need to change the **Rec Mode** setting in the System Settings menu. For details, refer to “**1 Recording Setup**” (p. 60).

28 Digital output connector [DIGITAL OUT]

This connector outputs a digital signal. You can use a coaxial-type cable to connect this to a digital recording device such as a DAT or MD recorder. This connector provides the same audio signal as the **line output jacks** (40) and **headphone jack** (37), but in digital form.

29 L connector [L-CONNECTOR]

You can use a stereo mini-mini-plug LANC cable to connect this to a video device that is equipped with a LANC connector. When you begin recording on your video device, the R-4 will begin recording in tandem. When you stop recording on your video device, the R-4 will also stop recording. For details, refer to “**Connecting a video device that has a LANC connector**” (p. 74).

30 USB connector [USB]

Use the included USB cable to connect this to your computer. Projects recorded on the R-4 can be moved or copied to your computer. Files from your computer can also be moved or copied to the R-4's hard disk.

31 AC adaptor jack [DC IN]

Connect the included AC adaptor to this jack.

32 Cord hook

Use this to secure the AC adaptor cable.

33 Eject button

Press this when you want to remove the CompactFlash card inserted in the **memory card slot** 34 .

34 Memory card slot [MEMORY CARD]

You can insert a CompactFlash card into this slot.

Projects you record on the R-4 can be copied to a CompactFlash card for backup or to transfer them to a computer.

The R-4 is able to use only TYPE 1 CompactFlash memory cards. Microdrive cards are not supported. For details on handling CompactFlash cards, refer to “**Handling memory cards**” (p. 70).

35 Grounding terminal

Depending on the circumstances of a particular setup, you may experience a discomforting sensation, or perceive that the surface feels gritty to the touch when you touch this device, microphones connected to it, or the metal portions of other objects. This is due to an infinitesimal electrical charge, which is absolutely harmless. However, if you are concerned about this, connect the ground terminal (see figure) with an external ground. When the unit is grounded, a slight hum may occur, depending on the particulars of your installation. If you are unsure of the connection method, contact the nearest Roland Service Center, or an authorized Roland distributor, as listed on the "Information" page.



Unsuitable places for connection

- Water pipes (may result in shock or electrocution)
- Gas pipes (may result in fire or explosion)
- Telephone-line ground or lightning rod (may be dangerous in the event of lightning)

36 Security Slot []

<http://www.kensington.com/>

37 Headphone jack [PHONES]

Connect a set of headphones to this jack. Use the **monitor level knob** () to adjust the volume. If you connect headphones, sound will not be heard from the **internal speakers** ().

Side panel (right)

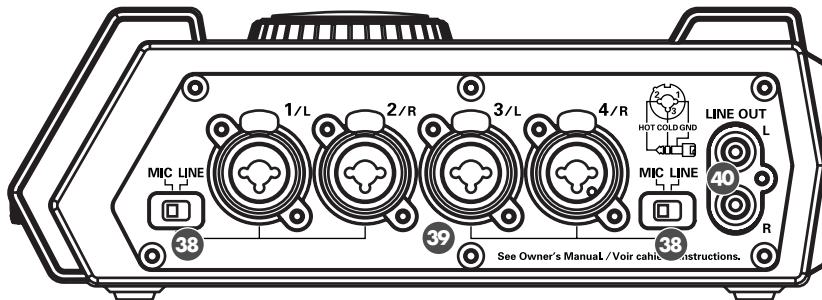

38 Input level select switches

Set these switches to either the MIC or LINE position depending on the type of device connected to channels 1/L and 2/R or channels 3/L and 4/R.

MIC	If a mic is connected
LINE	If an audio device is connected via an analog connection

39 Combo input jacks 1-4

These are standard audio input jacks compatible with mic preamps. They accept either XLR or 1/4" phone plugs; you can use whichever is most convenient for the equipment you're connecting. Balanced or unbalanced signals can be connected.

You can use combo input jacks 1-4 as four channels of monaural input or as two stereo pairs, 1/2 and 3/4. For details, refer to "1 Recording Setup" (p. 60).

* The XLR type jacks can provide 48 V phantom power, allowing you to connect phantom-powered condenser mics. In this case, turn on the **phantom power switch** (5).

This instrument is equipped with balanced (XLR/TRS) type jacks. Wiring diagrams for these jacks are shown below. Make connections after first checking the wiring diagrams of other equipment you intend to connect.



1:GND
2:HOT
3:COLD

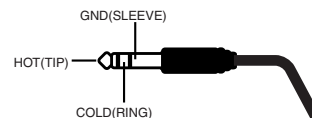

40 Line output jacks [LINE OUT]

These jacks output an analog audio signal. You can use RCA phono cables to connect them to powered speakers, audio equipment, a mixer, etc. These jacks output the same signal as the **digital output connector** (29) and the **headphone jack** (37).

The nominal output level is fixed at -10 dBV, and the volume of these jacks cannot be adjusted.

Bottom panel

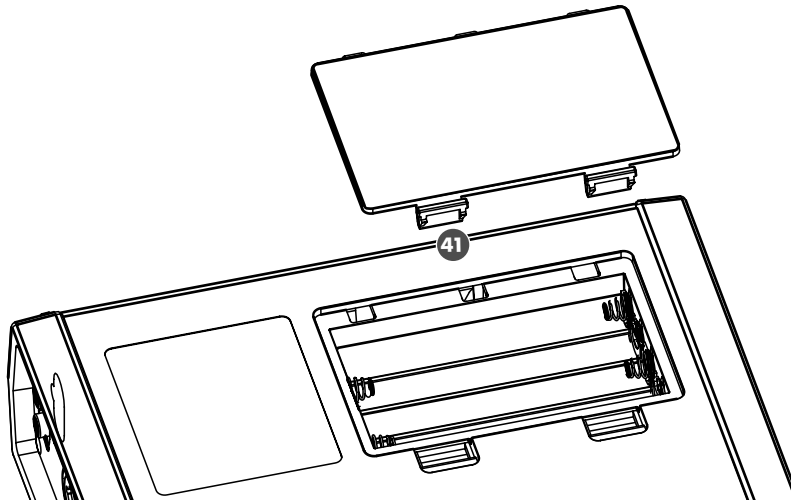

41 Battery compartment

Install batteries here if you want to operate the R-4 on battery power.

The orientation in which you must insert the batteries is shown on the side of the battery compartment.

Be sure to observe the correct polarity when installing the batteries.

If you're using the AC adaptor, there's no need to install batteries.

Make sure to switch off the R-4's power before you change from AC adaptor operation to battery operation, or vice versa.

For details, refer to "Installing batteries and turning the power on" (p. 25).

Display

While playing or stopped

The main screen

The R-4's main screen provides information about the project and the operational status of the R-4. You can press the **[DISPLAY]** button to switch the contents of the display.

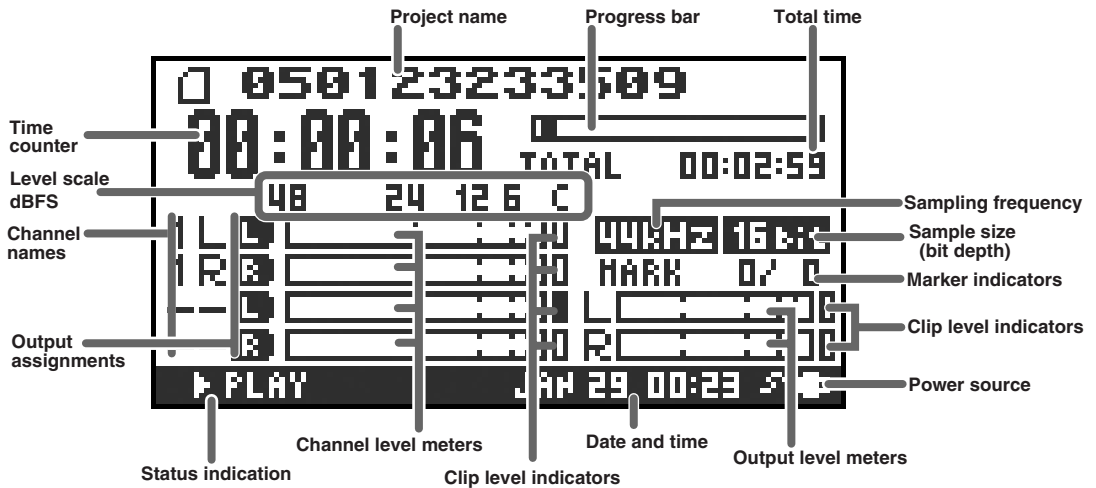

Project name	Indicates the name of the project. If you copy WAV files from your computer via USB to the R-4's internal hard disk, this will show the file name. File names containing double-byte characters (e.g., Japanese) will not be displayed correctly, but they can be played.
Time counter	Indicates the time that has elapsed from the beginning of the project to the current location. Indicated in terms of hours: minutes: seconds.
Progress bar	Indicates the current playback location relative to the entire project.
Total time	Indicates the total time of the entire project.
Level scale	Shows the audio level of each channel in real time. The markings are relative to 0 dBFS (Full Scale) of the digital signal. For example, 12 means -12 dBFS. C is clipping level (0 dBFS).
Clip level indicators	
Channel level meters	
Channel names	This area shows up to four channel names. If you're using one stereo channel, this will indicate 1L and 1R. If you're using two stereo channels, this will indicate 1L, 1R, 2L, 2R. For a monaural project, this area will show 1, 2, 3, and 4 according to the number of channels.
Output assignments	These show how the audio of each channel is assigned to the L/R output channels. L means that the audio is assigned to the left channel, R to the right channel, and LR to both left and right channels. Channels for which no indication appears will not be output. When you're in the main screen, you can press the [CURSOR] up/down buttons to select the channel that you want to monitor. The output is sent to the PHONES jack, line output jacks, and digital output connector.
Sampling frequency	Indicates the sampling frequency and sample size (bit depth) of the currently selected project.
Sample size	
Marker indicators	The number at the left indicates the marker located immediately before the current time counter value. The number at the right indicates the total number of markers assigned in the currently selected project.

Output level meters	These are the output level meters. They show the final output levels of the L and R channels, to which the various channels have been mixed. You can use the monitor level sliders of the mixer screen to adjust the level of each channel. From the left, the level meter is calibrated at -36, -24, -12, and -6 dBFS.
Clip level indicators	
Power source	Indicates how power is being supplied to the R-4. The plug icon is shown if power is being supplied by the AC adaptor, and the battery icon is shown if power is being supplied by batteries.

In the main screen, you can press the **[DISPLAY]** button to switch the progress bar area so it shows the remaining project time (REMAIN).

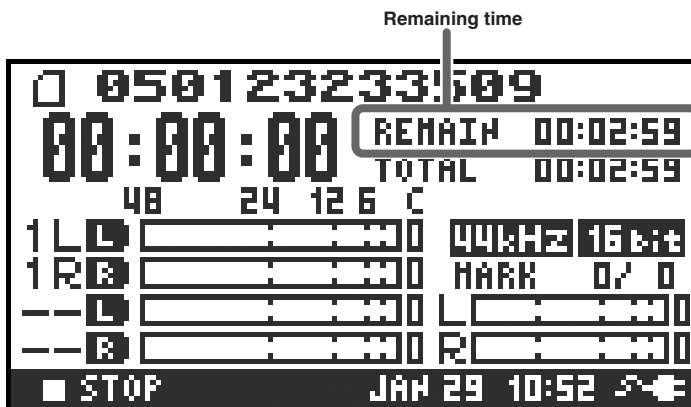

Remaining time	During playback, this indicates the remaining time from the current location to the end of the project.
-----------------------	---------------------------------------------------------------------------------------------------------

The mixer screen

From the main screen, press the **[DISPLAY]** button twice to move to the Mixer screen. This screen lets you adjust the volume balance for monitoring.

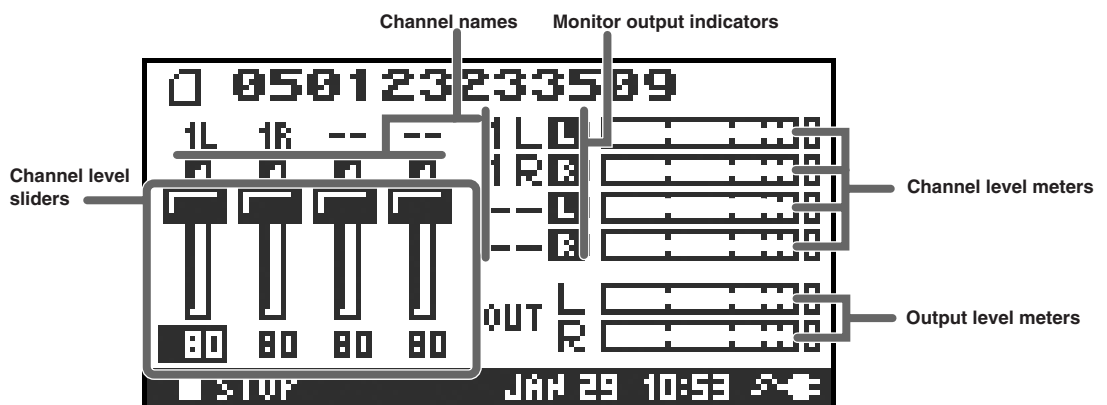

Channel level sliders	<p>Use these to adjust the playback level of each channel. Use the left/right [CURSOR/FINDER] buttons to select a slider, and turn the [SCRUB/VALUE] dial to adjust the value. Each slider provides adjustment within the range 0–120. The default value is 100.</p> <p>* The settings are not stored in the project; they are remembered by the R-4 itself. When you turn off the power, the settings will revert to their default values.</p> <p>* These settings do not affect the recording levels.</p>
------------------------------	---------------------------------------------------------------------------------------------------------------------------------------------------------------------------------------------------------------------------------------------------------------------------------------------------------------------------------------------------------------------------------------------------------------------------------------------------------------------------------------------------------------------------

While recording

The main screen

The R-4's main screen provides information about the project and the operational status of the R-4. You can press the **[DISPLAY]** button to switch the contents of the display.

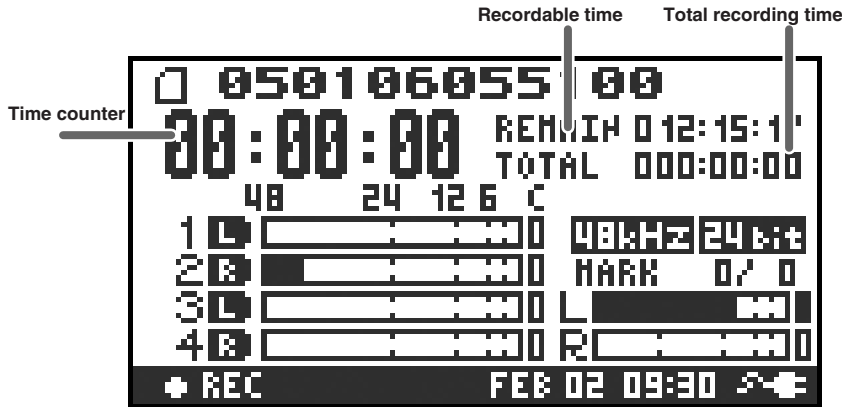

Time counter	Indicates the elapsed time from the beginning of the project you're recording until the current location. Indicated in terms of hours: minutes: seconds.
Recordable time	During recording, this indicates the remaining time that recording to the hard disk can take place. The remaining time will depend on the sampling frequency (Sample Freq.), sample size (Rec Bit), and recording mode (Rec Mode) settings. The indication shows how much longer you can record with the current settings.
Total recording time	Indicates the total time from the beginning of recording to the current location. * Even if you record continuously, another new project will be created automatically when the project reaches 2 GB in size, and recording will continue. Even for a recording that spans multiple projects in this way, the elapsed time since you first pressed the [REC] (record) button will be shown here.

* For an explanation of the other indications, refer to "While playing or stopped" (p. 18).

From the main screen, you can press the **[DISPLAY]** button to make the recordable time area show the remaining hard disk capacity instead.

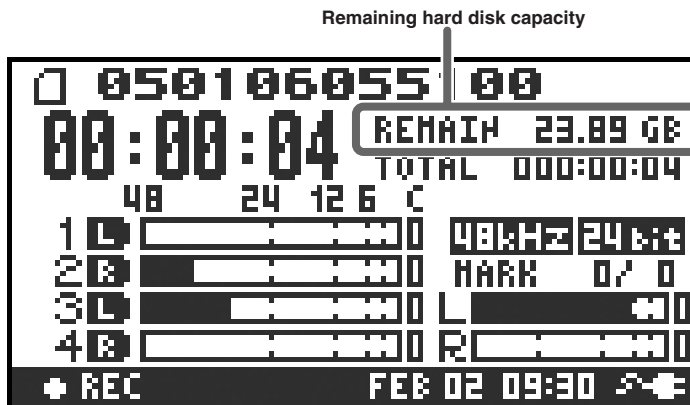

Remaining hard disk capacity	Indicates the remaining free capacity on the internal hard disk.
-------------------------------------	------------------------------------------------------------------

What is a project?

On the R-4, the data that you record and play back is handled as “projects.” On the hard disk, each project actually consists of a folder with one or more files, in the structure shown below.

If you connect the R-4 to your computer, you’ll be able to see how these folders and files are organized.

However, if you change, delete, or rename the files within a project, the R-4 may be unable to play back that project. Please use caution.

In the system settings, the **Recording Setup** parameter Rec Mode (p. 61) lets you specify the type of project you want to record.

Monaural projects

Type	Structure
MONOx1	If there is only one channel, a monaural WAV file will be created with a name consisting of the project name plus an extension of .wav .
MONOx2 MONOx3 MONOx4	If there are 2–4 channels, a folder will be created with a name consisting of the project name plus an extension of .pjt , and within that folder will be created monaural WAV files with names consisting of the channel number plus an extension of .wav .

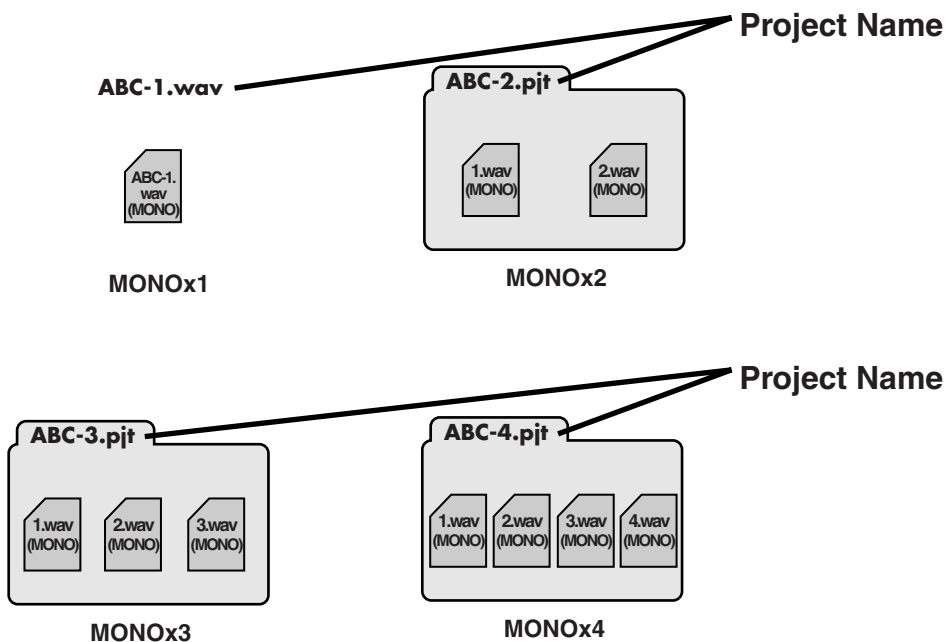

Stereo projects

Type	Structure
STEREOx1	If there is only one channel, a stereo WAV file will be created with a name consisting of the project name plus an extension of .wav .
STEREOx2	If there are two channels, a folder will be created with a name consisting of the project name plus an extension of .pjt , and within that folder will be created stereo WAV files with names consisting of the channel number plus an extension of .wav .

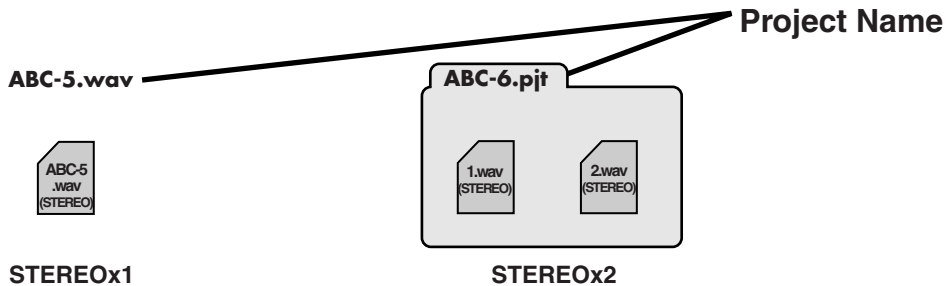

Four-channel projects

Type	Structure
4CH	A four-channel WAV file will be created with a name consisting of the project name plus an extension of .wav .

ABC-7.wav — Project Name



4CH

* If you want to load such files into your computer, make sure that your waveform editing software supports four-channel files.

Limitations on file size

The R-4 can handle files up to 2 GB in size. If the file size reaches 2 GB during recording, the file will be closed. Then, a new file will be created and recording will continue. When you finish recording, these files will appear as separate projects.

About BWF

Each WAV file within a project is in BWF format. In addition to the conventional WAV data, the file contains information about the recording time, recorder (EDIROL R-4), and marker data. Of course, these files can be loaded into players or waveform editing software in the same way as conventional WAV files.

Caution when copying files from your computer

Please note the following cautions when copying files from your computer into the R-4's internal hard disk.

- The R-4 can only record linear PCM WAV files at sampling frequencies of 44.1, 48, or 96 kHz and bit depths of 16 or 24 bits. It cannot play back any other type of file.
- File names and folder names containing double-byte characters (e.g., Japanese) will not be displayed correctly.
- Any files other than WAV files cannot be recognized by the R-4, and will be ignored.
- Files beginning with "." (dot) will be ignored.
- You must not copy files larger than 2 GB into the R-4's internal hard disk. Doing so will make the R-4's operation unstable, and in the worst case might even damage the files in the internal hard disk.

Getting ready to use the R-4

Basic connection examples

Before you make connections to other equipment, turn down the volume of all your equipment and turn off the power to prevent malfunctions or speaker damage.

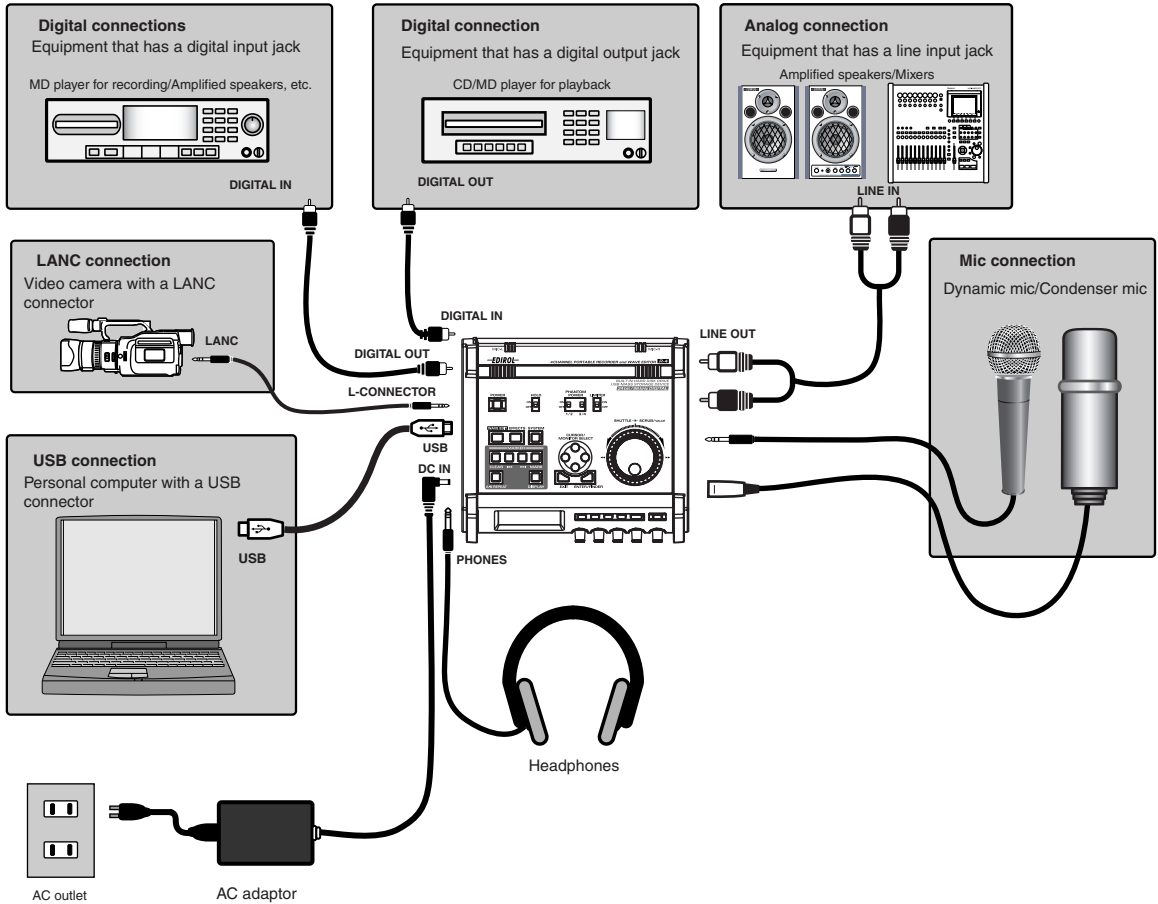

For more about connections, refer to “**Recording**” (p. 27) and “**Playing back**” (p. 34).

Connecting the AC adaptor and turning the power on

- * After you've made connections correctly, you must turn on the power using the steps below. If you don't follow the correct order, you may cause malfunctions or damage your speakers.
- * Due to a circuitry protection feature, this unit requires a few moments after power-up before it is ready for normal operation.
- * If you connect the AC adaptor when batteries are installed, the power will be supplied from the AC adaptor.

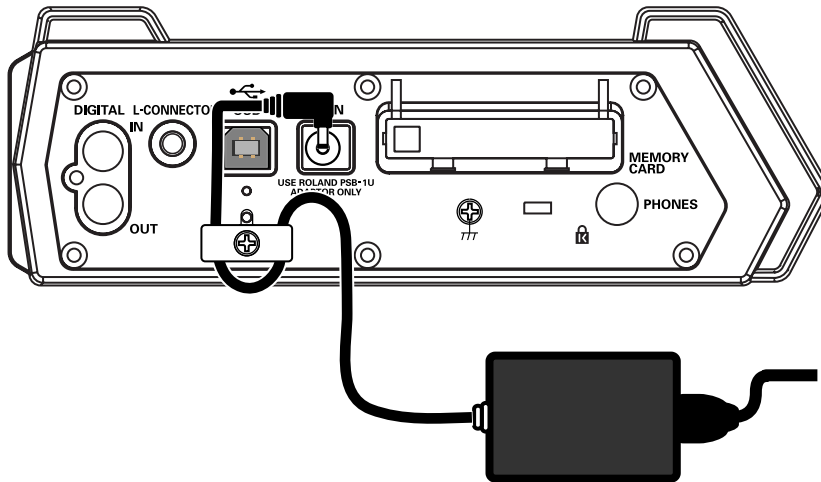

Turning the power on

- 1 Connect the DC plug of the AC adaptor to the AC adaptor jack located on the left side panel of the R-4.
 - * Use only the included AC adaptor.
- 2 Plug the AC adaptor into an AC power outlet.
 - * To prevent the inadvertent disruption of power to your unit (should the plug be pulled out accidentally), and to avoid applying undue stress to the AC adaptor jack, anchor the power cord using the cord hook, as shown in the illustration.
- 3 To turn the power on, press and hold the R-4's **[POWER] switch** for about two seconds. Wait until the main screen appears.

Turning the power off

- 1 From the main screen, press and hold the R-4's **[POWER] switch** for about two seconds to turn the power off.
 - * If you disconnect or reconnect the AC adaptor, the power will turn off even if batteries are installed. Please turn off the power on the R-4 itself before you change between AC adaptor power and battery power.

Installing batteries and turning the power on

Types of batteries you can use

- AA alkaline batteries (LR6)
 - AA nickel metal-hydride (HR15/51)
(The R-4 cannot recharge nickel metal-hydride batteries. You'll need to use a separate charger.)
- * You must set the R-4's **System Settings menu** item "**5 System Setup**" (p. 63) to specify the type of batteries you've installed. The R-4 will not operate correctly if you've specified a battery type that does not match the batteries you've actually installed.

- 1 Make sure that the R-4 is turned off, and disconnect the AC adaptor from the AC adaptor jack.
- 2 Detach the battery cover from the bottom panel of the R-4.
* When turning the unit upside-down, handle with care to avoid dropping it, or allowing it to fall or tip over.
- 3 Insert eight AA batteries into the battery compartment, making sure to observe the correct polarity (+ and - symbols).
- 4 Replace the battery cover.
- 5 Turn on the R-4.
- 6 Press the **[SYSTEM]** button.
- 7 Use the **[CURSOR]** up/down buttons to select **5 System Setup**.
- 8 Press the **[ENTER]** button.
- 9 Using the **[SCRUB/VALUE]** dial, set the **Battery Type** to **Alkaline** if you've installed alkaline batteries, or to **Ni-MH** if you've installed nickel metal-hydride batteries. The setting is activated as soon as you select it.
- 10 When you've finished making settings, press the **[EXIT]** button. You're returned to the previous screen.
- 11 When you're back in the **System Menu** screen, press the **[EXIT]** button once again.
Although the indication **[ENTER]** will be blinking in the display, if you don't need to make additional settings, press the **[EXIT]** button to return to the main screen.

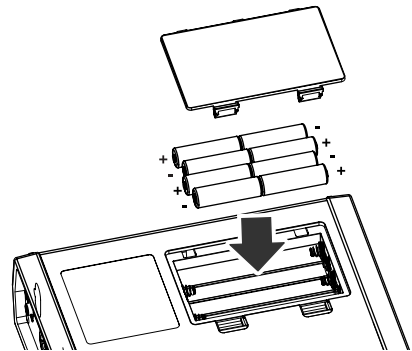

Caution when using the R-4 on battery power

- If you operate on battery power for an extended time, the batteries will become hot. Be careful not to burn yourself.
- We recommend that you use alkaline batteries, which have a longer life.
- Don't mix new batteries with used batteries, and don't mix batteries of differing types.
- If you won't be using the R-4 for an extended time, we recommend that you remove the batteries to prevent leakage or other accidents.
- When using a USB cable to connect the R-4 to your computer, you must use the AC adaptor to prevent the loss of power while the connection is active.

Battery status indication

If you're using the R-4 on battery power, a battery icon is shown in the lower right of the display. As the battery runs down, the battery icon will change as follows.

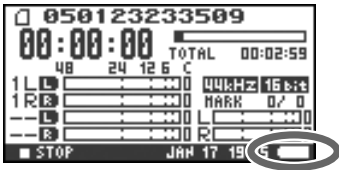
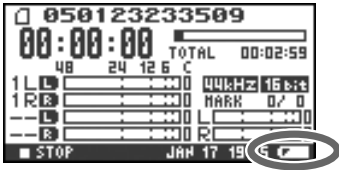
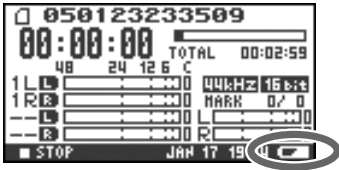
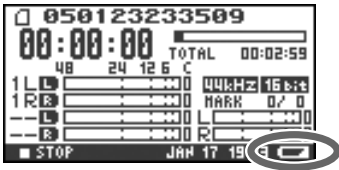
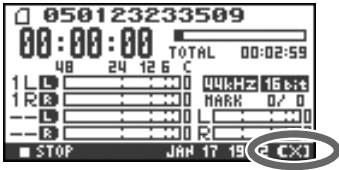
Remaining amount	Display
Level 4 (sufficient)	
Level 3	
Level 2	
Level 1	
Level 0 (little remaining)	

When the battery reaches Level 0, the message shown will appear. Replace the batteries as soon as possible. If you continue using the R-4 when the batteries have run low, the screen shown here will appear, and then the power will automatically turn off shortly thereafter.



Battery life

(When using alkaline batteries, 44.1 kHz, 16-bit, stereo, phantom power off)

Continuous playback	approximately 3.5 hours
Continuous recording	approximately 2 hours

* The values for battery life shown above are only approximate; they will vary depending on your system and conditions of use.

* The life of the battery will be shortened if you leave the display backlighting turned on or if you make heavy use of effects. There is a System setting that allows you to specify the length of time that the backlight is to remain on. For details, refer to "4 LCD Setup" (p. 62).

Recording

Recording from a connected mic

Here's how to record an audio source from a mic connected to the R-4's combo input jack.

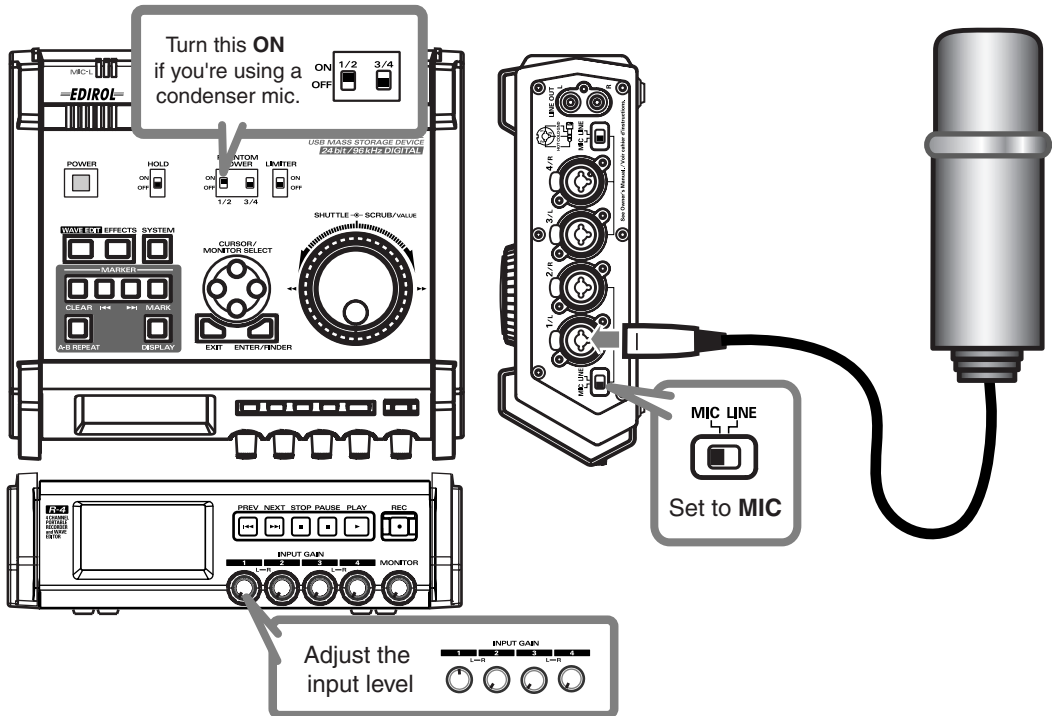

● Connections

Connect your mic to the **combo input jack**.

If you're monitoring through external speakers, acoustic feedback (a screech or whine) may occur, depending on the position of the mic relative to the speakers. If this occurs, take the following actions.

1. Point the mic in a different direction
2. Move the mic away from the speakers
3. Lower the monitoring volume

● Input level select switch

Set this to the **MIC** position.

● Phantom power switch

If you've connected a phantom-powered condenser mic, turn this ON.

● System settings

Press the R-4's **[SYSTEM]** button.

In **1 Recording Setup**, set Input Select to **Analog**.

Set the other items in 1 Recording Setup as appropriate for the recording you want to make.

* For more about system settings, refer to "**System settings**" (p. 60).

● Limiter

Turn this ON if you want to prevent unexpectedly loud sounds or strong attacks from producing clipping noise.

The limiter threshold is -10 dB relative to digital full scale, and the compression ratio is 1:3.

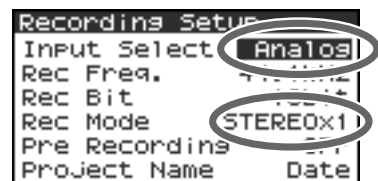

● Input level knobs

These knobs adjust the input levels.

If you're recording in stereo, these knobs control the following signals.

Channel 1	STEREO 1 L-channel	INPUT GAIN 1 knob
Channel 2	STEREO 1 R-channel	INPUT GAIN 2 knob
Channel 3	STEREO 2 L-channel	INPUT GAIN 3 knob
Channel 4	STEREO 2 R-channel	INPUT GAIN 4 knob

Adjusting the input level

1. Hold down the [PAUSE] button and press the [REC] (record) button.

The R-4 will enter recording-standby mode. In recording-standby mode, the [REC] (record) button will blink, and the display will indicate **REC STANDBY**.

2. Play sound into the microphone at the actual volume that you expect to record.

3. Gradually turn the **input level knob** toward the right.

4. Adjust the level so that the level meter shown in the display reaches a point slightly before **C (clip level)**. If the recording level is too low, quiet sounds will not be recorded. If the recording level is too high, soft sounds will be distorted, producing a crackling noise in the recording.

* The level meter indicates the clip level (C) at 0 dBFS (FS = full scale). For example, **12** indicates -12 dBFS.

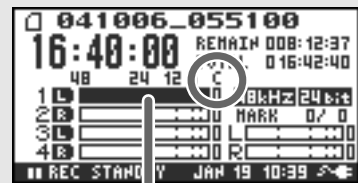

level meter (dBFS)

● Record button [REC]

If you want to begin recording immediately, press the [REC] (record) button. Recording will begin.

Recording-standby

If you want to put the R-4 in recording-standby mode so that you can prepare for recording, hold down the [PAUSE] button and press the [REC] (record) button.

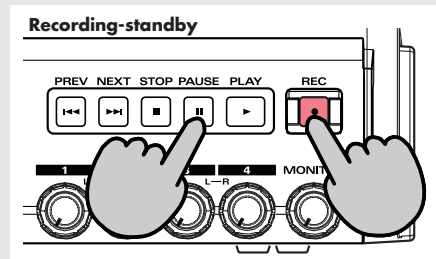

In recording-standby mode, the [REC] (record) button will blink and the display will indicate **REC PAUSE**.

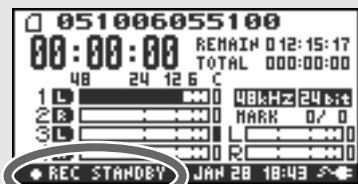

Recording will begin immediately when you press the [REC] (record) button or the [PAUSE] button in recording-standby mode or while paused.

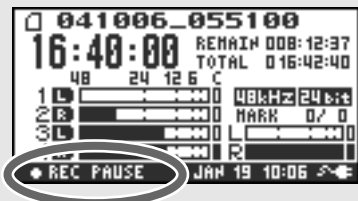

● Other settings

If you want to monitor the sound that's being recorded, connect headphones to the PHONES jack and use the monitor level knob to adjust the volume.

Adjusting the monitor level knob won't affect the level of the sound that's actually being recorded.

To play back the recorded sound, refer to **"Playing back"** (p. 34).

Caution regarding placement and handling while recording

The internal hard disk is a precision device. If you subject the hard disk to impacts such as the following, the data may not be read or written successfully, causing recording or playback to be unsuccessful. In the worst case, irreparable damage may occur.

Please be careful not to subject the R-4 to strong impact or continued vibration while using it.

The following actions will cause malfunctions

- Subjecting the unit to impact, such as dropping it from a table onto a hard floor.
- Subjecting the unit to continuous vibration, such as by leaving it on an uncushioned surface like the floor of a moving automobile.

Recording from the internal mics

Here's how to record an audio source via the R-4's internal mics.

- **Phantom power switch**

Turn this **OFF**.

- **System settings**

Press the R-4's **[SYSTEM]** button.

In **1 Recording Setup**, set **Input Select** to **Int-Mic**.

Set the other items in **1 Recording Setup** as appropriate for the recording you want to make.

* For more about system settings, refer to "**System settings**" (p. 60).

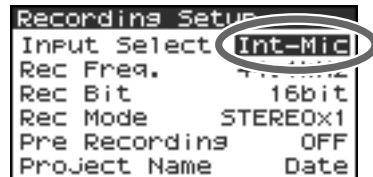

- **Input level knobs**

Adjust the input level.

Refer to "**Adjusting the input level**" (p. 28).

Input levels of the **internal mics** are adjusted by **knob 1** (MIC-L) and **knob 2** (MIC-R).

- **Record button [REC]**

Press the **[REC]** (**record**) button to begin recording.

For details on recording-standby, refer to "**Recording-standby**" (p. 28).

- **Other settings**

If you want to monitor the sound that's being recorded, connect headphones to the PHONES jack and use the monitor level knob to adjust the volume.

Adjusting the monitor level knob won't affect the level of the sound that's actually being recorded.

To play back the recorded sound, refer to "**Playing back**" (p. 34).

Recording digital audio from a digital device

Here's how to record from a digital device connected to the R-4's digital input jack.

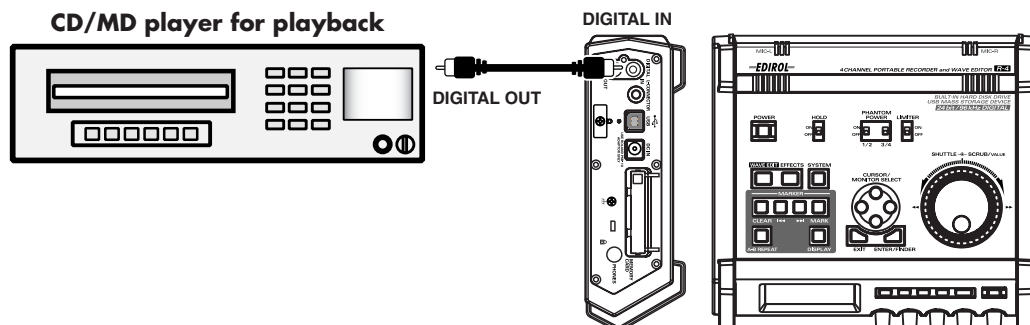

● Connections

Connect your digital device to the **digital input jack**. You'll need a separately available coaxial-type cable to connect your device to the R-4's digital input jack.

● System settings

Press the R-4's **[SYSTEM]** button.

In **1 Recording Setup**, set **Input Select** to **Digital**.

Set the other items in **1 Recording Setup** as appropriate for the recording you want to make.

* For more about system settings, refer to "**System settings**" (p. 60).

* The R-4 is not able to synchronize to the clock signal of the digital input connector. Regardless of the sampling frequency that is being input, the incoming digital audio data will be converted to the sampling frequency (Rec Freq.) and sample size (Rec Bit) that are specified in **Recording Setup**.

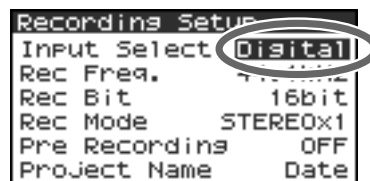

● Record button [REC]

Press the **[REC] (record) button** to begin recording.

For details on recording-standby, refer to "**Recording-standby**" (p. 28).

● Other settings

If you want to monitor the sound that's being recorded, connect headphones to the PHONES jack and use the monitor level knob to adjust the volume.

Adjusting the monitor level knob won't affect the level of the sound that's actually being recorded.

* If you're recording the digital input, you can't use the input level knob to adjust the input level.

To play back the recorded sound, refer to "**Playing back**" (p. 34).

Recording analog audio

Here's how to record from an audio device connected to the R-4's combo input jacks.

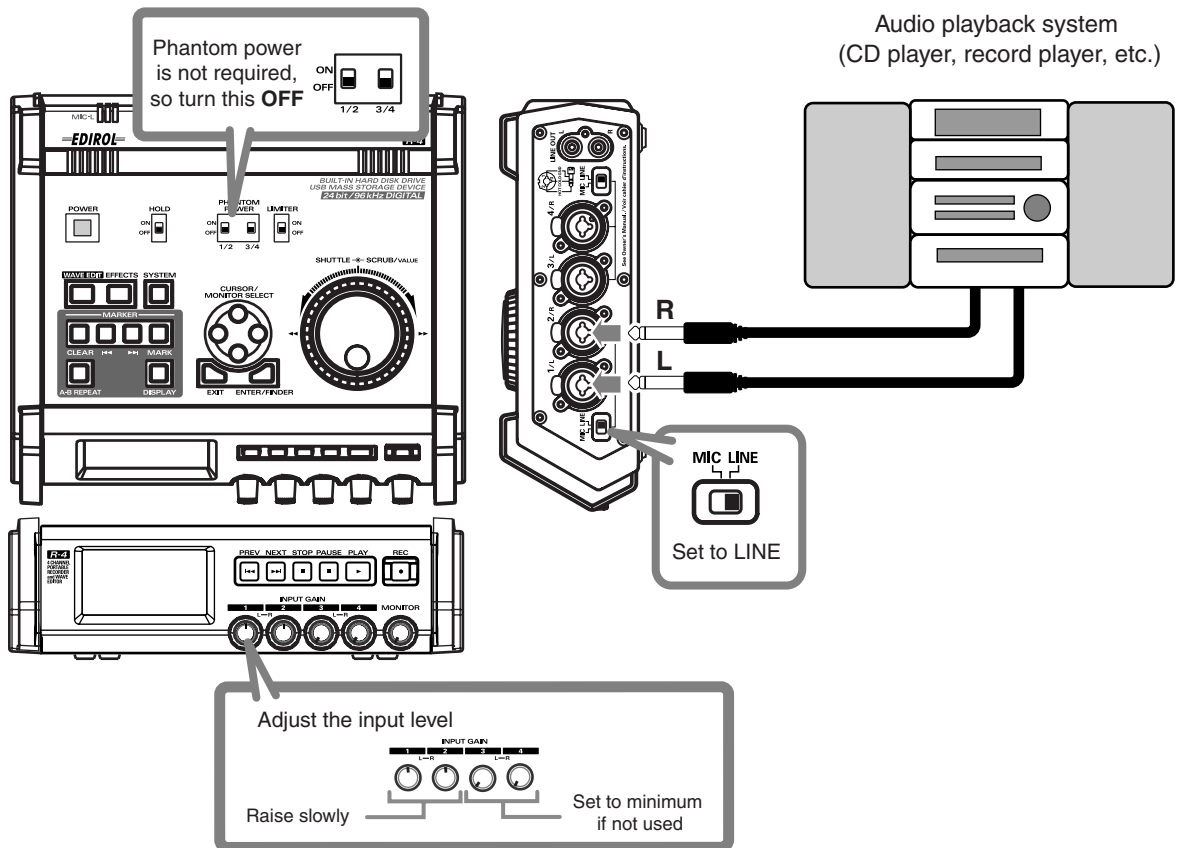

● Connections

Connect your audio device to the combo input jacks.
You'll need to use phone-jack audio cables (sold separately).

* When connection cables with resistors are used, the volume level of equipment connected to the combo input jacks may be low. If this happens, use connection cables that do not contain resistors, such as those from the Roland PCS series.

● Input level select switch

Set to **LINE**.

● Phantom power switch

Turn this **OFF**.

● System settings

Press the R-4's **[SYSTEM]** button.

In **1 Recording Setup**, set **Input Select** to **Analog**.

Set the **Rec Mode** to **STEREOx1**.

Set the other items in **1 Recording Setup** as appropriate for the recording you want to make.

* For more about system settings, refer to "**System settings**" (p. 60).

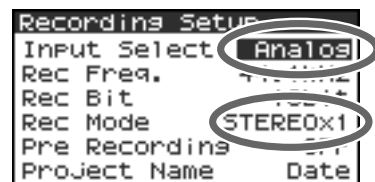

● Input level knobs

Adjust the input level 1 (L) and 2 (R) knobs. If there are channels to which you have not connected anything, turn their input level knobs to the minimum position.

Refer to “**Adjusting the input level**” (p. 28).

● Record button [REC]

Press the **[REC] (record) button** to begin recording.

For details on recording-standby, refer to “**Recording-standby**” (p. 28).

● Limiter

Turn this **OFF** if you’re recording an audio source whose levels have already been regularized (in contrast to a live audio source whose levels might change unpredictably), or if you have already checked the maximum volume levels that are going to occur.

Turn this **ON** if you need to prevent clipping (distortion) that might be caused by unexpectedly loud volumes or strong attacks.

● Other settings

If you want to monitor the sound that’s being recorded, connect headphones to the PHONES jack and use the monitor level knob to adjust the volume.

Adjusting the monitor level knob won’t affect the level of the sound that’s actually being recorded.

To play back the recorded sound, refer to “**Playing back**” (p. 34).

Playing back

This section explains various procedures and methods by which you can play back the projects in the R-4's internal hard disk and the audio material you recorded on the R-4. \Make the correct settings and connections before you play anything back.

- **Connections before playback**..... (p. 34)
- **Settings before playback**..... (p. 36)
- **Playing back**..... (p. 38)

Connections before playback

Connecting headphones

Headphones are a convenient way to monitor while you're recording or immediately after recording.

1. Turn the **[MONITOR] level knob** all the way to the left to minimize the volume.
2. Connect your headphones to the **PHONES jack**.
3. Slowly turn the **[MONITOR] level knob** toward the right to adjust the volume.

Connecting amplified speakers

Here's how to connect amplified speakers that have line input jacks or a digital input jack.

1. Switch off the power on the R-4.
2. Minimize the volume of the speakers you want to connect, and turn off their power.
3. Depending on the type of speakers you are using, connect the R-4's **[LINE OUT] line input jacks** or **[DIGITAL OUT] digital output jack** to your amplified speakers.
4. Switch on the R-4's power.
5. Next, switch on your speakers, and gradually increase the volume to the desired level.

* *The R-4 does not provide a way to adjust the volume of the audio that is output from its line output jacks.*

Connecting a mixer or other analog device (analog connection: line output jacks)

Here's how to connect a mixer or other audio device that has line input jacks.

1. Switch off the power on the R-4.
2. Minimize the volume of the mixer or other device you're going to connect.
3. Connect the R-4's **[LINE OUT] line input jacks** to your mixer.
You'll need separately available audio cables (not included) for connecting to the R-4's line output jacks.
4. Switch on the R-4's power.
5. Next, switch on your mixer, and gradually increase the volume to the desired level.

* *The R-4 does not provide a way to adjust the volume of the audio that is output from its line output jacks.*

Connecting an MD recorder or other digital recording device (digital connection: digital output connector)

You can connect an MD recorder or other device that has a digital input connector, and use it to record the sound played back by the R-4.

The sampling frequency of the project you're playing back will be the sampling frequency of the audio that's output from the digital output connector.



1. Switch off the power on the R-4.
2. Switch off your MD recorder.
3. Connect the R-4's **[DIGITAL OUT] jack** to the digital input jack of your MD recorder.
 - * You'll need a separately available coaxial-type cable (not included) for connecting the R-4's **digital output jack** to your digital device.
4. Switch on the R-4's power.
5. Next, switch on your MD recorder.
 - * The R-4 does not provide a way to adjust the volume of the digital audio signal.

Settings before playback

Player Setup

- 1 Press the R-4's **[SYSTEM]** button.
The system menu screen appears in the display.

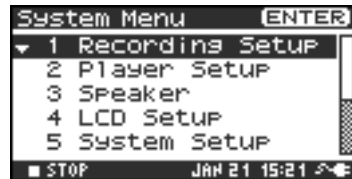

- 2 Use the **[CURSOR]** buttons to choose **2 Playing Setup**, and press the **[ENTER]** button.
The Recording Setup screen appears.



- 3 Use the **[SCRUB/VALUE]** dial to choose the **Play Mode** value.
* The setting is applied as soon as you select it. You don't need to press the **[ENTER]** button.

Make settings for the following items as well.

Menu	Player Setup settings	Playback method
Play Mode	Single	Selects the playback mode. Only the selected project will play.
	Sequential	The projects in the folder containing the currently selected project will play consecutively.
Repeat	OFF, ON	Selects whether playback will repeat. If Play Mode is Single , only that project will play repeatedly. If it is Sequential , the projects in the folder containing the currently selected project will play consecutively, and then the projects in the same folder will again play consecutively from the beginning.
X2 Play	OFF, ON	This enables/disables the function that provides double-speed playback when you press the [PLAY] button a second time during playback (i.e., when you press [PLAY] twice). The indication PLAY X2 will appear in the lower part of the display. Normal playback will resume when you press the [PLAY] button once again.

* For more about system settings, refer to “**System settings**” (p. 60).

Speaker

You can use the R-4's built-in speakers to monitor the sound without having to connect headphones or other equipment.

- 1 Press the R-4's **[SYSTEM]** button.
The system menu screen appears in the display.

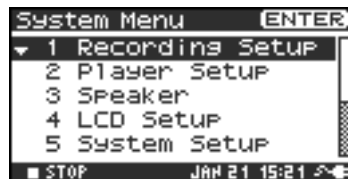

- 2 Use the **[CURSOR]** buttons to choose **3 Speaker Switch**, and press the **[ENTER]** button.
The Speaker screen appears.



Speaker Switch setting	Output destination
ON	Internal speakers Line output jacks Digital output jack
OFF	Line output jacks Digital output jack

* You can't monitor via the internal speakers while recording. You'll need to monitor through headphones. Note that sound will not be output from the speakers if headphones are connected. If you want to use the internal speakers, you must disconnect the headphones.

* For more about system settings, refer to "**System settings**" (p. 60).

Playing back

Normal playback

After you've performed the steps described in “**Connections before playback**” (p. 34) and “**Settings before playback**” (p. 36), proceed as follows.

1

Select the project that you want to play.

In the main screen, press the **[ENTER/FINDER]** button. In the Finder screen that appears, use the up/down **[CURSOR]** buttons and the **[SCRUB]** dial to select a project. For more about the Finder screen, refer to “**The Finder screen**” (p. 41).

Alternatively, you can use the front panel's **[PREV]** button or **[NEXT]** button to select the project you want to play. The projects are in alphabetical order.

2

Press the **[PLAY]** button.

The selected project will play.

3

Slowly raise the **[MONITOR]** level knob to the desired volume for listening.

* *Projects with names beginning with “.” are ignored, and will not be shown.*

* *The project name will not be displayed correctly if the project name contains double-byte characters (e.g., Japanese). To ensure that you can view the file name correctly, don't use double-byte characters in the filename.*

* *Projects whose filename extension is other than .pjt or .wav will be ignored, and will not be shown.*

Mark

You can assign markers at desired locations in a project. Then you can use the **⏮** button or **⏭** button to move backward or forward to the location of a marker.

You can use the Mark function either while playing or while recording.

- 1 Use the **[NEXT]** button or the **[SHUTTLE]** dial to find the location at which you want to assign a marker.
Play, fast-forward, or rewind the project to the location at which you want to assign a marker.

- 2 Press the **[MARK]** button at the location at which you want to assign a marker.

You can assign markers while playing, recording, or stopped.

The display indicates the number of markers as shown at right. Marks are numbered sequentially starting at the beginning of the project.

You can assign up to 99 markers.

Repeat steps 1 and 2 to assign markers as desired.

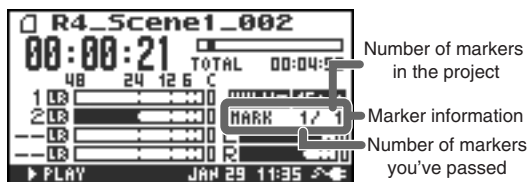

Number of markers in the project

Marker information

Number of markers you've passed

- 3 When you've assigned one or more markers, proceed as follows.

You can use these operations either while playing or while stopped.

⏮ button

Moves to the marker immediately before the current location (previous marker).

⏭ button

Moves to the marker immediately following the current location (next marker).

CLEAR button

Deletes the marker you specified using the **[Mark]** buttons. Marks are deleted consecutively, starting with the marker immediately before the current location.

Repeat playback (A-B REPEAT)

You can repeatedly play back between two points (A-B) in the project. Simply assign points A and B during playback, and the playback will repeat between points A and B.

1 Play back the project.

During playback, press the **[A-B REPEAT]** button once. The **[A-B REPEAT]** button will blink, and that location will be remembered as the starting point (A) for repeat playback.

* If, after assigning point **A**, you press the **STOP** button before assigning point **B**, point **A** will be cleared.

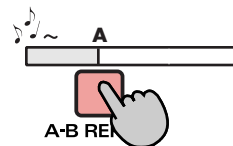

2 Press the **[A-B REPEAT]** button once again. The **[A-B REPEAT]** button will change from blinking to solidly lit, and that location will be remembered as the end point (B) for repeat playback.

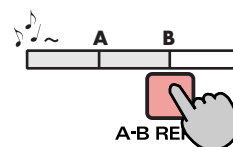

Playback will automatically repeat between the points you specified in steps 1 and 2.

To cancel repeat playback, press the **[A-B REPEAT]** button when points A and B have already been assigned. The **[A-B REPEAT]** button will go out, and repeat playback will be cancelled.

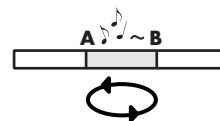

Please note

- * If, after assigning point **A**, you press the **STOP** button before assigning point **B**, point **A** will be cleared.
- * If the song plays all the way to the end after you've assigned point **A**, playback will repeat between point **A** and the end of the song.
- * If you press the **[STOP]** button during repeat playback, playback will stop and the repeat region (A-B) settings will be cleared.

The Finder screen

The R-4 saves projects as files on its internal hard disk. If there are numerous folders or projects within folders, you can use the Finder screen to select the project that you want to play. In this screen you can also perform operations such as deleting an unwanted project or copying a project to a CompactFlash card.

Finder functions

No.	Menu	Operation	See
1	Select	Select and load a project.	p. 41
2	Delete	Delete a project.	p. 42
3	Rename	Rename a project.	p. 43
4	Copy	Copy the selected project.	p. 44
5	Move	Move the selected project to a different folder.	p. 45
6	Make Folder	Create a new folder.	p. 46

Selecting a project (Select)

- 1 With project playback stopped and the main screen (p. 18) shown in the display, press the **[ENTER/FINDER]** button. The Finder screen shown in the illustration will appear.
Projects are shown in descending alphabetical order.

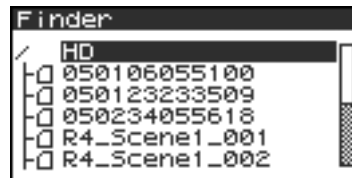

- 2 In the Finder screen, use the **[CURSOR]** up/down buttons or the **[SCRUB]** dial to select the desired project. Then press the **[ENTER]** button.

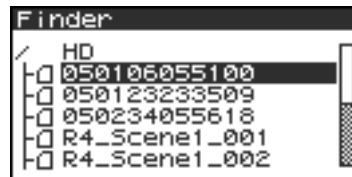

MEMO

If the desired project is in a folder, the hard disk (HD), or the CompactFlash card (CF), you can press the **[CURSOR]** right button to move into the selected folder (i.e., move to a lower-level folder).

If you want to move back to the upper-level folder, press the **[CURSOR]** left button.

- 3 When the screen at right appears, use the **[CURSOR]** buttons to choose **1 Select**.

The project will be selected, and you will return to the main screen.

Alternatively, with a project selected (step 2), you can press the **[PLAY]** button (instead of pressing the **[ENTER]** button) to play the selected project. You will return to the main screen when playback begins.

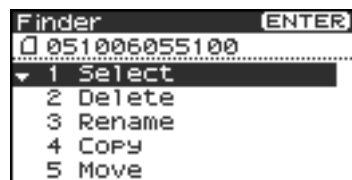

* Since you cannot directly play back projects from the CompactFlash card, you won't be able to select them. You will have to copy the desired project to the R-4's internal hard disk before you can select it.

Deleting a project (Delete)

- With the main screen shown in the display, press the **[ENTER/ FINDER]** button. The Finder screen shown in the illustration will appear.
Projects are shown in descending alphabetical order.

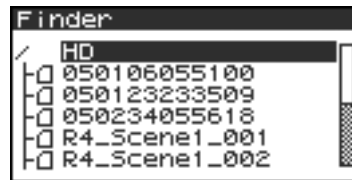

- In the Finder screen, use the **[CURSOR] up/down buttons** or the **[SCRUB] dial** to select the project you want to delete. Then press the **[ENTER] button**.

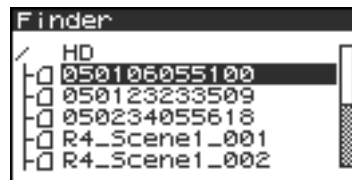

If the desired project is in a folder, the hard disk (HD), or the CompactFlash card (CF), you can press the **[CURSOR] right button** to move into the selected folder (i.e., move to a lower-level folder). If you want to move back to the upper-level folder, press the **[CURSOR] left button**.

- * If you want to select the CompactFlash card, select the hard disk (HD) and then press the **[CURSOR] right button**; the contents of the CompactFlash card will appear. However, this will not be displayed if no CompactFlash card is inserted.

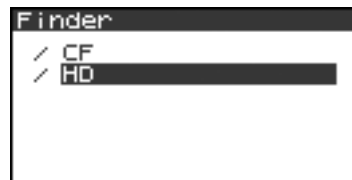

- When the screen shown in the illustration appears, use the **[CURSOR] buttons** to choose **2 Delete**.

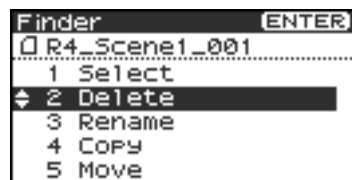

- The screen shown in the illustration will appear. Press the **[ENTER] button** to execute the Delete operation.

- * If you decide to cancel without executing, press the **[EXIT] button** before you press the **[ENTER] button**.

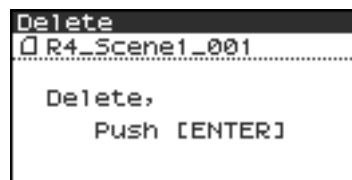

Don't turn off the power while a project is being deleted.

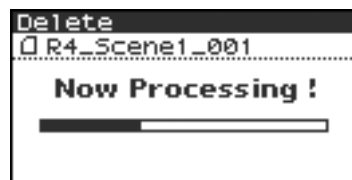

Renaming a project (Rename)

- 1 With the main screen shown in the display, press the **[ENTER/FINDER]** button. The Finder screen shown in the illustration will appear.
Projects are shown in descending alphabetical order.

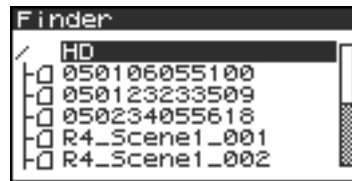

- 2 In the Finder screen, use the **[CURSOR] up/down** buttons or the **[SCRUB] dial** to select the project you want to rename. Then press the **[ENTER]** button.

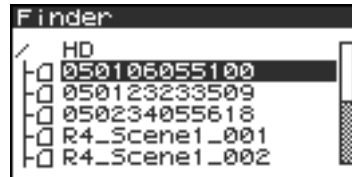

MEMO

If the desired project is in a folder, the hard disk (HD), or the CompactFlash card (CF), you can press the **[CURSOR] right** button to move into the selected folder (i.e., move to a lower-level folder). If you want to move back to the upper-level folder, press the **[CURSOR] left** button.

- * If you want to select the CompactFlash card, select the hard disk (HD) and then press the **[CURSOR] right** button; the contents of the CompactFlash card will appear. However, this will not be displayed if no CompactFlash card is inserted.

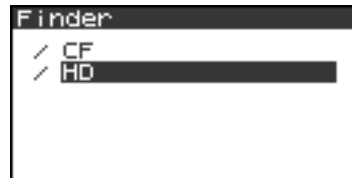

- 3 When the screen shown in the illustration appears, use the **[CURSOR] buttons** to choose **3 Rename**.

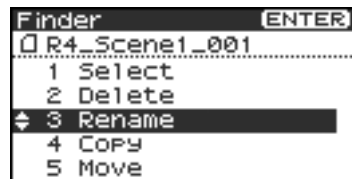

- 4 Use the **[CURSOR] left/right** buttons to move the cursor through the characters of the project name or folder name shown in the display. Place the cursor at the character that you want to change, and then use the **[CURSOR] up/down** buttons or the **[SCRUB/VALUE] dial** to change the character.

Use the **[CLEAR]** button to delete a character, or the **[Mark] button** to insert a character. Use these buttons to edit the name as desired.

When you've finished editing the name, press the **[ENTER]** button.

- * If you decide to cancel without renaming, press the **[EXIT]** button before you press the **[ENTER]** button.

Don't turn off the power while a project is being renamed.

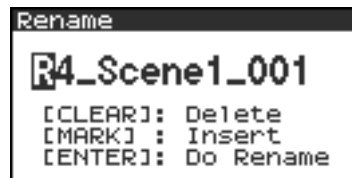

Copying a project (Copy)

- With the main screen shown in the display, press the **[ENTER/FINDER]** button. The Finder screen shown in the illustration will appear.
Projects are shown in descending alphabetical order.

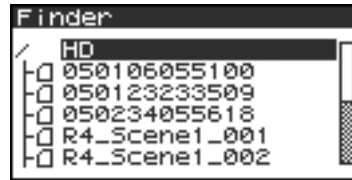

- In the Finder screen, use the **[CURSOR] up/down buttons** or the **[SCRUB] dial** to select the copy-source project (the project you want to copy). Then press the **[ENTER]** button.

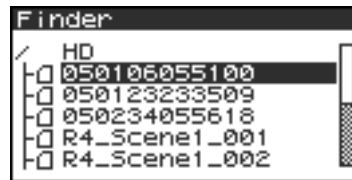

MEMO

If the desired project is in a folder, the hard disk (HD), or the CompactFlash card (CF), you can press the **[CURSOR] right button** to move into the selected folder (i.e., move to a lower-level folder).
If you want to move back to the upper-level folder, press the **[CURSOR] left button**.

* If you want to select the CompactFlash card, select the hard disk (HD) and then press the **[CURSOR] right button**; the contents of the CompactFlash card will appear. However, this will not be displayed if no CompactFlash card is inserted.

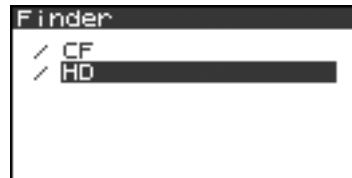

- When the screen shown in the illustration appears, use the **[CURSOR] buttons** to choose **4 Copy**.

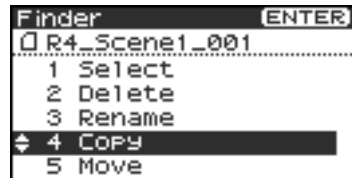

- Use the **[CURSOR] up/down buttons** or the **[SCRUB/VALUE] dial** to select the copy-destination folder (the folder to which you want to copy the project). Then press the **[ENTER]** button to execute the Copy operation. As the copy destination, you may also select **HD** (hard disk) or **CF** (CompactFlash).

* If you decide to cancel without executing, press the **[EXIT]** button.



Don't turn off the power while a project is being copied.

* If the copy destination contains an identically named project, a number such as **-1** or **-2**. will be appended to the name of the copied project.

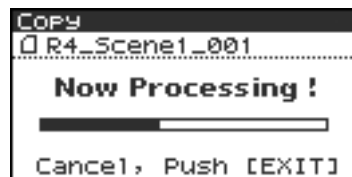

Moving a project (Move)

* You can't move a project between the hard disk and the CompactFlash card. If you need to do this, you can first copy the project, and then delete the copy-source project.

- 1 With the main screen shown in the display, press the **[ENTER/FINDER]** button. The Finder screen shown in the illustration will appear.
Projects are shown in descending alphabetical order.

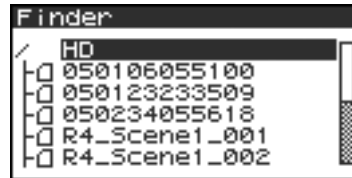

- 2 In the Finder screen, use the **[CURSOR] up/down** buttons or the **[SCRUB] dial** to select the project that you want to move. Then press the **[ENTER] button**.

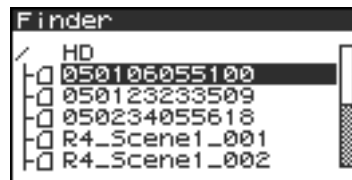

If the desired project is in a folder, the hard disk (HD), or the CompactFlash card (CF), you can press the **[CURSOR] right button** to move into the selected folder (i.e., move to a lower-level folder).

If you want to move back to the upper-level folder, press the **[CURSOR] left button**.

* If you want to select the CompactFlash card, select the hard disk (HD) and then press the **[CURSOR] right button**; the contents of the CompactFlash card will appear. However, this will not be displayed if no CompactFlash card is inserted.

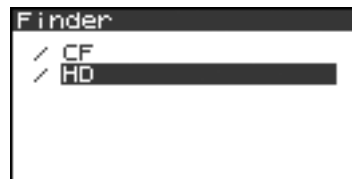

- 3 When the screen shown in the illustration appears, use the **[CURSOR] buttons** to choose **5 Move**.

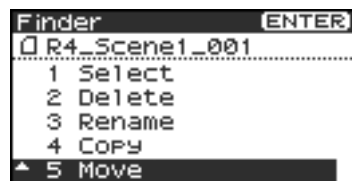

- 4 Use the **[CURSOR] up/down** buttons or the **[SCRUB/VALUE] dial** to select the destination folder (the folder to which you want to move the project). Then press the **[ENTER] button** to execute the Move operation. You may also select HD (hard disk) as the destination.

* If you decide to cancel without executing, press the **[EXIT] button**.



Don't turn off the power while a project is being moved.



Creating a new folder (Make Folder)

- With the main screen shown in the display, press the **[ENTER/ FINDER] button**. The Finder screen shown in the illustration will appear.
Projects are shown in descending alphabetical order.

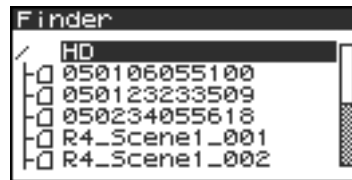

- In the Finder screen, use the **[CURSOR] up/down buttons** or the **[SCRUB] dial** to select **HD** (hard disk) located at the top level.
Then press the **[ENTER] button**.

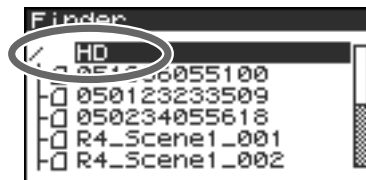

If the desired project is in a folder, the hard disk (HD), or the CompactFlash card (CF), you can press the **[CURSOR] right button** to move into the selected folder (i.e., move to a lower-level folder).
If you want to move back to the upper-level folder, press the **[CURSOR] left button**.

* If you want to select the CompactFlash card, select the hard disk (HD) and then press the **[CURSOR] right button**; the contents of the CompactFlash card will appear. However, this will not be displayed if no CompactFlash card is inserted.

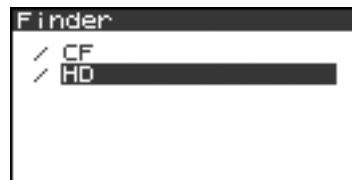

- When the screen shown in the illustration appears, use the **[CURSOR] buttons** to choose **2 Make Folder**.

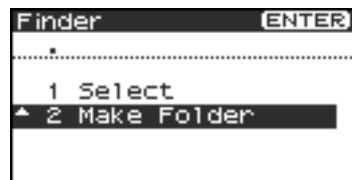

- When the screen shown in the illustration appears, press the **[ENTER] button** to confirm the operation.

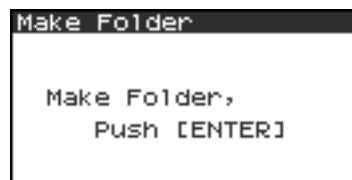

Don't turn off the power while a folder is being created.



5

A folder named NewFolder will be created.

Projects are shown in alphabetical order, and folders are shown in alphabetical order after the projects.

Use the **[CURSOR] up/down** or the **[SCRUB] dial** to verify that the new folder was created.

If an identically named folder already exists, a number will be added to the name of the newly created folder; e.g., NewFolder-1, NewFolder-11, NewFolder-111, etc.

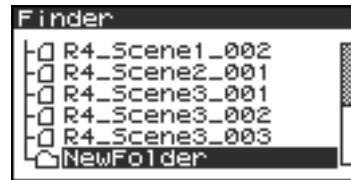

Editing

Projects you record using the R-4 can be edited directly on the R-4.

No.	Editing command	Result	See
1	Trim	Specify two points in the waveform, extract the region, and create a new project using that region.	p. 48
2	Divide	Specify one point in the waveform, and divide the project at that point. Two new projects will be created.	p. 50
3	Combine	Append another project following the end of the currently selected project. The two files will be joined to create a single new file.	p. 52
4	Merge	A project consisting of multiple files will be merged into a single channel.	p. 54

* Executing any of these editing commands will leave the original project file unchanged.

* There is no Undo function.

Editing procedure

Trim

This command extracts the region between the two points you specify in the waveform, and creates a new project using this extracted region.

You can perform playback, stop, or operate the scrub dial and shuttle dial even while using this command. However, you cannot perform A-B Repeat or marker-related operations.

- 1 Press the R-4's **[WAVE EDIT]** button. The Wave Edit Menu screen appears in the display.
- 2 Use the **[CURSOR]** buttons to choose **1 Trim**, and press the **[ENTER]** button.



The editing screen shown at the right will appear.

Time axis zoom (1/1–1/65536)

Use the **[CURSOR]** left/right buttons to adjust this

Waveform level zoom (x1–x64)

Use the **[CURSOR]** up/down buttons to adjust this

* If you decide not to adjust the settings, press the **[EXIT]** button.

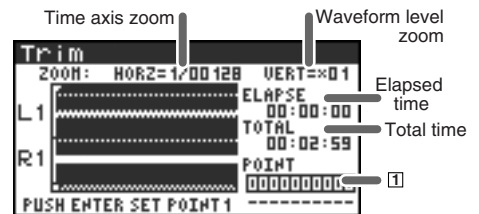

- 3 While playing or fast-forwarding, press the **[ENTER]** button when you reach the beginning (point [1]) of the region you want to extract.

Alternatively, you can use the scrub dial or shuttle dial to specify the point instead of doing so during playback.

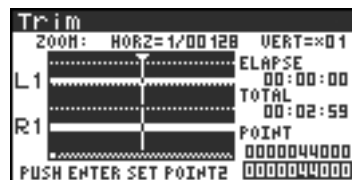

* The value of point [1] is shown in terms of samples (data).

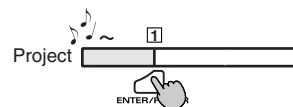

- 4 In the same way, move to the end (point 2) of the region you want to extract, and press the **[ENTER]** button.

* The value of point 2 is shown in terms of samples (data).

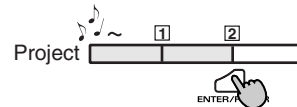
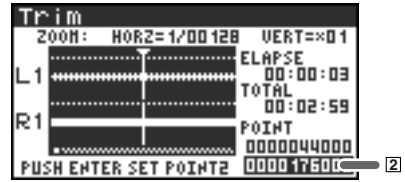

- 5 A screen asking you to confirm the specified points will appear.

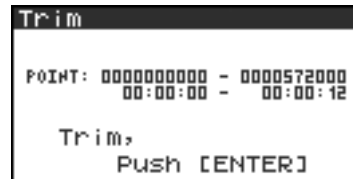

If you are satisfied with the points you specified, press the **[ENTER]** button to confirm the settings. If you decide to try again, you can press the **[EXIT]** button once and re-specify the end of the region (point 2). You can then press the **[EXIT]** button once again and re-specify the beginning of the region (point 1). Even when the screen shown at the right is displayed, you can halt execution by pressing the **[EXIT]** button.

* Don't turn off the power while a project is being saved or while processing is being performed.



- 6 The extracted region will be saved as a new project with the same name as the original project but with "-1" appended to it. The original project will remain unchanged.

For example, if the original project is named **Project**, the new project will be named **Project-1**.

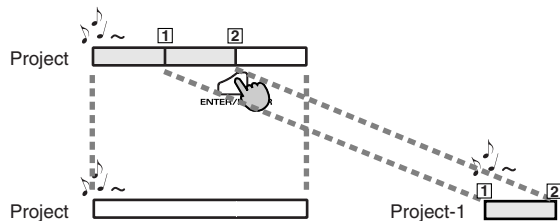

Media Full!

If the internal hard disk does not have enough space to save the project, a message of "**Media Full!**" will appear.

Divide

This command divides the project at the point you specify in the waveform. Two new projects will be created.

You can perform playback, stop, or operate the scrub dial and shuttle dial even while using this command. However, you cannot perform A-B Repeat or marker-related operations.

- 1 Press the R-4's **[WAVE EDIT] button**. The Wave Edit Menu screen appears in the display.
- 2 Use the **[CURSOR] buttons** to choose **2 Divide**, and press the **[ENTER] button**.
The editing screen shown at the right will appear.

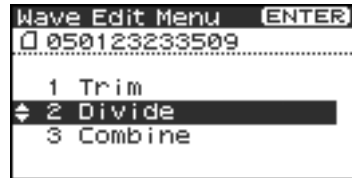

Time axis zoom (1/1-1/65536)

Use the **[CURSOR] left/right buttons** to adjust this

Waveform level zoom (x1-x64)

Use the **[CURSOR] up/down buttons** to adjust this

* If you decide not to adjust the settings, press the **[EXIT] button**.

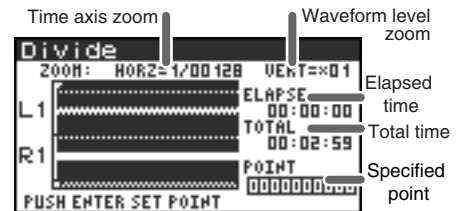

- 3 While playing or fast-forwarding, press the **[ENTER] button** when you reach the point at which you want to divide the project.
Alternatively, you can use the scrub dial or shuttle dial to specify the point instead of doing so during playback.

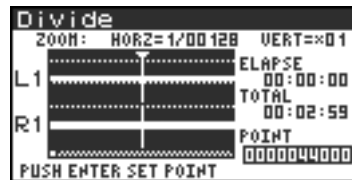

- 4 A screen asking you to confirm the specified point will appear.

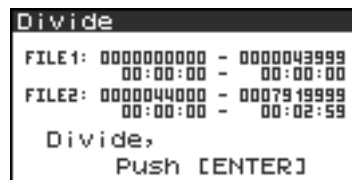

To execute the Divide operation at the point you specified, press the **[ENTER] button**.

If you decide not to execute the Divide operation, press the **[EXIT] button**.

Even when the screen shown at the right is displayed, you can halt execution by pressing the **[EXIT] button**.

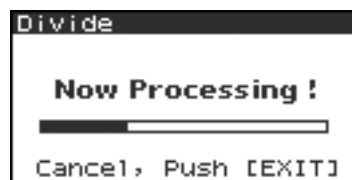

* Don't turn off the power while a project is being saved or while processing is being performed.

* It may take some time to save the project if it contains a large amount of data.

- 5 The divided project will be saved as two new projects with the same name as the original project but with “-1” and “-2” appended to the names. The original project will remain unchanged.

For example, if the original project is named Project, the new projects will be named **Project-1** and **Project-2**.

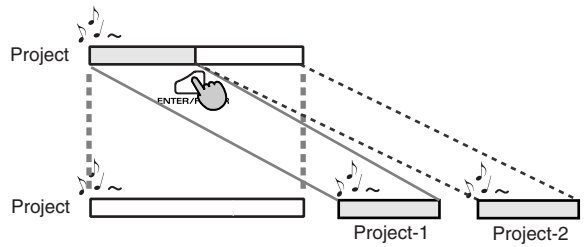

Media Full!

If the internal hard disk does not have enough space to save the project, a message of “**Media Full!**” will appear.

Combine

This command appends another project (of the same format) onto the end of the currently selected project. The two files will be joined to create a single new file.

You cannot perform playback, stop, or operate the scrub dial or shuttle dial while using this command.

- 1 Select the project (the "base project") to which you want to append another project.
In the main screen, use the **[NEXT] button** or **[PREV] button** to select the desired project. Alternatively, you can use the cursor buttons in the Finder screen.

- 2 Press the R-4's **[WAVE EDIT] button**. The display shows the Wave Edit Menu screen.



- 3 Use the **[CURSOR] buttons** to choose **3 Combine**, and press the **[ENTER] button**.

The display shows an editing screen like the one at right.

* If you decide to cancel the operation, press the **[EXIT] button**.

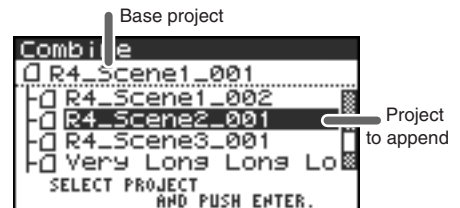

- 4 Use the **[CURSOR] buttons** to select the project that you want to append, and press the **[ENTER] button**.

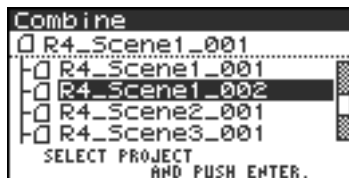

If you decide to cancel the operation, press the **[EXIT] button**. Even when the screen shown at right is displayed, you can halt execution by pressing the **[EXIT] button**.

* Don't turn off the power while a project is being saved or while processing is being performed.

* It may take some time to save the project if it contains a large amount of data.

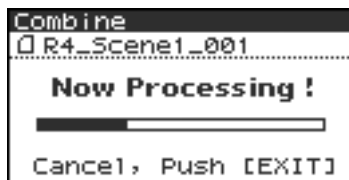

The "base project" and the "project to be appended" must have the same sampling frequency, sample size (bit depth), and number of channels.



If you select a project that cannot be appended, the message shown here will appear.

- 5 The combined projects will be saved as a new project with the same name as the original project but with “-1” appended to it. The original project will remain unchanged. For example, if the original project is named **Project**, the new project will be named **Project-1**.

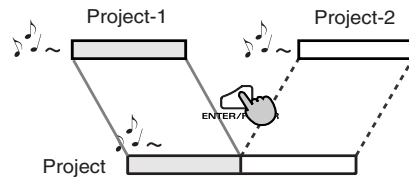

Media Full!

If the internal hard disk does not have enough space to save the project, a message of “**Media Full!**” will appear.

Merge

If the currently selected project consists of multiple files (MONO x2, MONO x3, MONO x4, STEREO x2), this command merges them into a single channel.

How Rec Mode will change

Before Merge	After Merge
MONOx2	MONOx1
MONOx3	
MONOx4	
STEREOx2	STEREOx1

* Since MONO x1, STEREO x1, or 4 ch. projects cannot be merged, the Merge command will not appear in the menu if you've selected this type of project.

- 1 Press the R-4's **[WAVE EDIT]** button. The Wave Edit Menu screen will appear.
- 2 Use the **[CURSOR]** buttons to choose 4 Merge, and press the **[ENTER]** button.



The editing screen shown at right will appear.

If you want to adjust the level (Mix Level) of the channels in the project, you can do so. Use the **[CURSOR] up/down buttons** or the **[SCRUB] dial** to specify the value.

For example, in a stereo two-channel project (STEREO x2), you might set the Mix Level to -6.0 dB so that the level of each channel will be lowered by 6 dB when they are merged.

* If you decide to cancel, press the **[EXIT]** button.

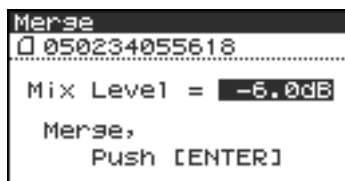

- 3 To execute, press the **[ENTER]** button.
If you decide not to use the Merge command, press the **[EXIT]** button.
Even when the screen shown at the right is displayed, you can halt execution by pressing the **[EXIT]** button.

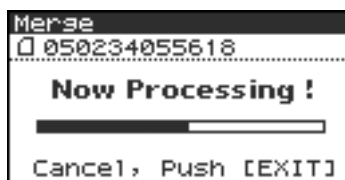

* Don't turn off the power while a project is being saved or while processing is being performed.

* It may take some time to save the project if it contains a large amount of data.



Media Full!

If the internal hard disk does not have enough space to save the project, a message of "Media Full!" will appear.

Effects setting

The R-4 provides five types of effects. You can apply an effect to the incoming sound as it's being recorded, or you can apply an effect to the playback. You can also change the effect settings for each channel.

* *Effects are not available when the R-4 is operating at 96 kHz.*

Effect types provided on the R-4

No.	Effect name	Effect
0	No Effect	No effect will be applied. Use this setting if you want to preserve the effect on/off setting of each channel, but don't want an effect to be applied.
1	3-Band EQ	Three-band equalizer.
2	Graphic EQ	You can adjust the gain of six fixed-frequency bands.
3	Noise Gate	This effect minimizes the noise that might be heard in silent regions, as well as low-frequency noise.
4	Enhancer	By adding a phase-shifted sound to the direct sound, this effect sharpens the definition of the sound and pushes it toward the foreground.
5	Comp&DeEsser	This cuts the sibilance that can be obtrusive in a vocal, making the sound smoother. It also reduces the difference between loud and soft sounds, making the level more consistent. A compressor evens out the level differences between loud and soft sounds. A de-esser reduces the unpleasant sibilance (exaggerated "s" sound) that is sometimes present in a vocal.

If you apply an effect while recording, the volume and tone of the recorded sound will be different than the original sound.

Before applying an effect aggressively during recording, it's a good idea to monitor the sound through headphones in recording-standby mode to make sure that the sound is not clipping or distorting. It's also a good idea to make a test recording beforehand with those settings.

For details on the procedure, refer to "**Using effects**" (p. 58).

? What is an effect?

On the R-4, an "effect" is a process that digitally transforms the sound, giving it greater clarity or impact. Effects can also make the sound more intelligible, or reduce undesired noise.

? What is clipping?

Applying an effect or boosting the level may increase the audio level (volume) beyond the maximum that a device can handle; this occurrence is called clipping. Clipping is occurring when you notice that loud sounds are distorted or crackly.

Effects

1: 3-Band EQ

No.	Parameter name	Range of values	Default values	Explanation
1	LOW GAIN	-12dB-0dB+12dB	0dB	Adjusts the gain of the low-range equalizer.
2	MID FREQ.	200Hz, 250Hz, 315Hz, 400Hz, 500Hz, 630Hz, 800Hz, 1kHz, 1.25Hz, 1.6kHz, 2kHz, 2.5kHz, 3.15kHz, 4kHz, 5kHz, 6.3kHz	1kHz	Specifies the center frequency of the mid-range equalizer.
3	MID Q	0.5, 1.0, 2.0, 4.0, 8.0	2.0	Specifies the width of the region centered on the Mid Freq for which the gain will change. Higher Q settings will narrow the region in which the change occurs.
4	MID GAIN	-12dB-0dB+12dB	0dB	Adjusts the gain of the mid-range equalizer.
5	HIGH GAIN	-12dB-0dB+12dB	0dB	Adjusts the gain of the high-range equalizer.
6	LEVEL	0 - 120	100	Adjusts the overall volume.

2: Graphic EQ

No.	Parameter name	Range of values	Default values	Explanation
1	125Hz	-12dB-0dB+12dB	0dB	Adjusts the gain at 125 Hz.
2	250Hz	-12dB-0dB+12dB	0dB	Adjusts the gain at 250 Hz.
3	500Hz	-12dB-0dB+12dB	0dB	Adjusts the gain at 500 Hz.
4	1kHz	-12dB-0dB+12dB	0dB	Adjusts the gain at 1 kHz.
5	2kHz	-12dB-0dB+12dB	0dB	Adjusts the gain at 2 kHz.
6	4kHz	-12dB-0dB+12dB	0dB	Adjusts the gain at 4 kHz.
7	Level	0-120	100	Adjusts the overall volume.

3: Noise Gate

No.	Parameter name	Range of values	Default values	Explanation
1	LO-CUT	OFF, 40Hz, 55Hz, 63Hz, 80Hz, 100Hz, 125Hz, 160Hz, 200Hz, 250Hz, 315Hz, 400Hz, 500Hz, 630Hz, 800Hz, 1kHz	100Hz	Cuts unwanted low-frequency noise such as wind.
2	THRESHOLD	OFF,1-100	20	Specifies the volume threshold below which the sound will be cut.
3	LEVEL	0-120	100	Adjusts the overall volume.

4: Enhancer

No.	Parameter name	Range of values	Default values	Explanation
1	SENSE	0-100	50	Adjusts the sensitivity of the enhancer effect.
2	MIX	0-100	50	Adjusts the amount of phase-shifted sound that is to be mixed with the input.
3	LEVEL	0-120	100	Adjusts the overall volume.

5: Comp&DeEsser

No.	Parameter name	Range of values	Default values	Explanation
1	DE-ESSER SW.	OFF, ON	ON	Turn this ON to reduce unpleasant sibilance.
2	THRESHOLD	0-100	50	Specifies the volume (threshold level) at which the compressor will begin to operate. Compression will be applied to the input when it exceeds this level. Lower threshold settings mean that the compressor will be applied even at lower levels.
3	RATIO	1.0:1, 1.2:1, 1.5:1, 2.0:1, 2.8:1, 4.0:1, 8.0:1, 16.0:1, Inf:1	4.0:1	Adjusts the ratio at which the sound will be compressed when the input exceeds the threshold level. Higher ratios mean that the sound will be compressed more strongly.
4	ATTACK	0.25-100ms	10ms	Adjusts the time over which the amount of compression specified by Ratio will be reached once compression is triggered by the input exceeding the threshold level. Higher settings of Attack mean that compression will be applied more slowly.
5	RELEASE	50-5000ms	100ms	Adjusts the time over which compression will be removed once the input falls below the threshold level. Higher settings of Release mean that the sound will revert to its uncompressed state more slowly.
6	GAIN	-6.0dB+18.0dB (The value will change in steps of 0.5dB)	0.0dB	Adjusts the gain following compression.
7	LEVEL	0-120	100	Adjusts the overall volume.

Using effects

You can adjust the R-4's effects not only while standing-by for recording or playback, but also while you listen to the sound during actual playback or recording. This section explains how to adjust the effect settings while playing back or in recording-standby mode.

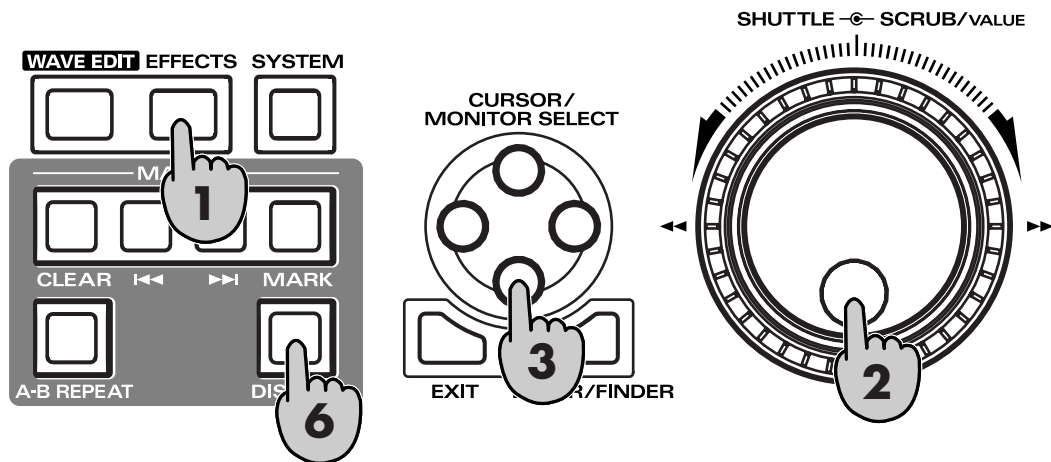

- 1 Press the R-4's **[EFFECTS]** button.
The effect setting screen will appear in the display.

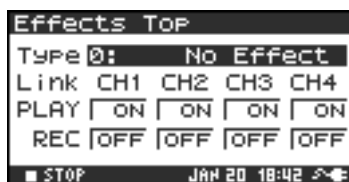

- 2 Use the **[SCRUB/VALUE]** dial to select the desired effect type.
For details on each effect type, refer to "Effects" (p. 56).



- 3 Press the **[CURSOR]** down button. The cursor will move to the "Link" setting.



CH1 CH2 CH3 CH4	The effect on/off setting and effect parameter settings will be independent for each channel.
CH1+2 CH3+4	The effect on/off setting and effect parameter settings will be linked for channels 1 and 2, and for channels 3 and 4. Choose this setting if the project uses channels 1 and 2 and channels 3 and 4 as stereo pairs.
CH1+2+3+4	The effect on/off setting and effect parameter settings will be linked for all channels.

- 4 Use the **[SCRUB/VALUE] dial** to specify the channels for which effect settings will be linked.

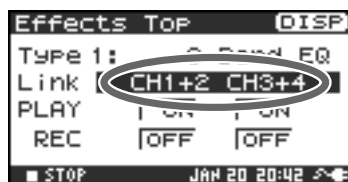

- 5 In the same way, make the desired settings for "PLAY" and "REC"

PLAY

OFF	The effect will not be applied during playback
ON	The effect will be applied during playback

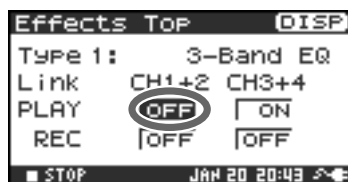
**REC**

OFF	The effect will not be applied during recording
ON	The effect will be applied during recording

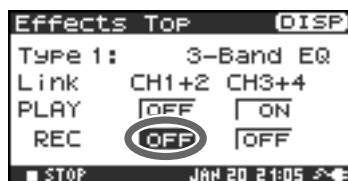

- 6 Press the **[DISPLAY] button**.

The effect parameter screen will appear.

* The effect parameter screen won't appear if you've selected 0: No Effect as the Type.

- 7 Use the **[CURSOR] buttons** and the **[SCRUB/VALUE] dial** to set each effect parameter.

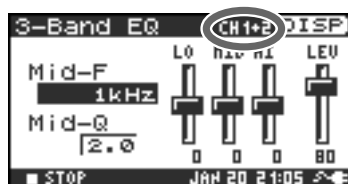

- 8 If you selected "CH1 CH2 CH3 CH4" or "CH1+2 CH3+4" as the "Link" setting, press the **[DISPLAY] button**.

The next channel (or pair of channels) will appear in the display.

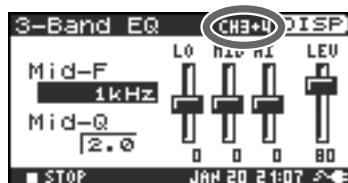

While setting effect parameters, you can return to the previous screen by pressing the **[EXIT]** button. The effect settings you make are remembered until you change them. However, if you change the Type of effect, the settings you made will revert to the default values.

- 9 When you've finished making the desired effect settings, press the **[EXIT] button** to return to the main screen.

Each effect has various settings ("parameters") that you can adjust to alter the character of the effect. The settings you make are remembered even while the R-4's power is switched off. However, if you change the effect type, these settings will be reset to the default values.

System settings

Here you can make various settings that apply to the entire system of the R-4 as a whole, such as basic settings for recording or playback.

No.	Menu item	Summary	Refer to
1	Recording Setup	Make various settings related to recording.	p. 65
2	Player Setup	Make various settings related to playback.	p. 65
3	Speaker	Turn the speaker on/off.	p. 65
4	LCD Setup	Make settings related to the display.	p. 65
5	System Setup	Make settings to specify how the R-4 operates.	p. 65
6	Date & Time	Set the date and time of the R-4's internal calendar. You can specify the year, month, and date (day of the week).	p. 66
7	Project Name	The R-4 can automatically assign a name to a project file that is created by recording. You can specify how this name will be assigned.	p. 67
8	HDD Utility	Perform various utility commands with respect to the R-4's internal hard disk.	p. 68
9	CF Utility	Perform various utility commands with respect to a CompactFlash card inserted in the R-4.	p. 68
10	Factory Reset	Return the R-4 to the factory-set state.	p. 69

System Menu

1 Recording Setup

The values in boldface are the default values.

* You can't change the Recording Setup settings during recording or playback.

Menu item	Value	Function
Input Select	Analog	This selects the type of input that is to be recorded. Choose this setting if you want to record the analog input. This is the most common setting. Connect your mic or analog audio device to the combo input jacks. With this setting, any input from the internal mics or the digital input jack will be ignored.
	Int-Mic	Choose this setting if you want to record via the internal mics.
	Digital	Choose this setting if you want to record via the digital input. The signal from a digital device connected to the digital input jack will be recorded. With this setting, any input from the internal mics or the line input jacks will be ignored. The sampling frequency is specified by the Rec Freq. setting, and the bit depth by the Rec Bit setting.
Rec Freq.	44.1 kHz , 48.0 kHz, 96 kHz	This selects the sampling frequency for recording. Higher sampling frequencies allow higher-quality recording but will produce a larger project file, meaning that there will be less available recording time on the hard disk. The 44.1 kHz setting is sufficient when recording audio that falls within the normally audible range. This is also the most suitable frequency to use if you're going to load the recorded file into your computer and create a music CD from it. You can use the 48 kHz or 96 kHz settings when recording audio that contains a significant amount of high-frequency content, from instruments such as cymbals, or when you want to capture the brightness and transparency of a natural environment.
Rec Bit	16 bit , 24 bit	This selects the sample size (bit depth) for recording. A larger sample size allows the sound to be captured in greater detail but will produce a larger project file, meaning that there will be less available recording time on the hard disk. Use the 16-bit setting for normal recording. This allows the broadest compatibility when loading the recorded file into your computer for playback. Use the 24-bit setting if you want to capture the tonal character and ambience in greater detail, such as when recording an instrumental or vocal performance.

Menu item	Value	Function																																					
Rec Mode	MONOx1	One-channel recording to one monaural file	<p>This selects the structure of the project file that is created when you record. A monaural WAV file will be created for each channel. Choose these settings if you're using a separate mic for the vocal and performance or each speaker in a conversation, so that a separate file will be created for each channel. These settings will create monaural WAVE files. If Input Select is Analog, up to four monaural files will be created. If Input Select is Int-Mic or Digital, up to two monaural files will be created.</p> <p>* You can't select MONO x3, or MONO x4, or STEREO x2 if Input Select is Int-Mic or Digital.</p> <p>* You can't select MONO x3 or MONO x4 if Rec Freq. is 96 kHz.</p>																																				
	MONOx2	Two-channel recording to two monaural files																																					
	MONOx3	Three-channel recording to three monaural files																																					
	MONOx4	Four-channel recording to four monaural files																																					
	STEREOx1	Two-channel recording to one stereo file																																					
	STEREOx2	Four-channel recording to two stereo files																																					
4CHx1	Four-channel recording to one four-channel file	<p>Channels 1–4 will be recorded as a single WAVE file. Be aware that not all computer software is able to handle four-channel WAV files.</p> <p>* You can't select 4CH x1 if Int-Mic is set to Digital.</p>																																					
<table border="1"> <thead> <tr> <th></th> <th>MONOx1</th> <th>MONOx2</th> <th>MONOx3</th> <th>MONOx4</th> <th>STEREOx1</th> <th>STEREOx2</th> <th>4CH</th> </tr> </thead> <tbody> <tr> <td>44.1kHz</td> <td>○</td> <td>○</td> <td>○ *</td> <td>○ *</td> <td>○</td> <td>○ *</td> <td>○ *</td> </tr> <tr> <td>48kHz</td> <td>○</td> <td>○</td> <td>○ *</td> <td>○ *</td> <td>○</td> <td>○ *</td> <td>○ *</td> </tr> <tr> <td>96kHz</td> <td>○</td> <td>○</td> <td>×</td> <td>×</td> <td>○</td> <td>○ *</td> <td>○ *</td> </tr> </tbody> </table>					MONOx1	MONOx2	MONOx3	MONOx4	STEREOx1	STEREOx2	4CH	44.1kHz	○	○	○ *	○ *	○	○ *	○ *	48kHz	○	○	○ *	○ *	○	○ *	○ *	96kHz	○	○	×	×	○	○ *	○ *				
	MONOx1	MONOx2	MONOx3	MONOx4	STEREOx1	STEREOx2	4CH																																
44.1kHz	○	○	○ *	○ *	○	○ *	○ *																																
48kHz	○	○	○ *	○ *	○	○ *	○ *																																
96kHz	○	○	×	×	○	○ *	○ *																																
<p>The "*" symbol means that this is not available if Input Select is set to Int-Mic or Digital.</p>																																							
Pre Recording	OFF, 1–29 sec	<p>You can specify the length of time that the sound will be captured "retroactively," starting from before the moment you pressed the [REC] (record) button. This setting specifies the number of seconds that will be captured retroactively.</p> <p>* The maximum time will depend on the sampling frequency, the sample size (bit depth), and the mode setting.</p> <table border="1"> <thead> <tr> <th>Rec Freq.</th> <th>Rec Bit</th> <th>Rec Mode</th> <th>Pre Recording</th> </tr> </thead> <tbody> <tr> <td>44.1</td> <td>16</td> <td>STEREO x1</td> <td>29</td> </tr> <tr> <td>44.1</td> <td>16</td> <td>STEREO x2</td> <td>14</td> </tr> <tr> <td>48</td> <td>16</td> <td>STEREO x1</td> <td>27</td> </tr> <tr> <td>48</td> <td>16</td> <td>STEREO x2</td> <td>13</td> </tr> <tr> <td>48</td> <td>24</td> <td>STEREO x1</td> <td>18</td> </tr> <tr> <td>48</td> <td>24</td> <td>STEREO x2</td> <td>9</td> </tr> <tr> <td>96</td> <td>24</td> <td>STEREO x1</td> <td>9</td> </tr> <tr> <td>96</td> <td>24</td> <td>STEREO x2</td> <td>4</td> </tr> </tbody> </table> <p>* The R-4 consumes power even during pre-recording. If you're running on batteries, you'll need to pay attention to the remaining battery amount.</p>	Rec Freq.	Rec Bit	Rec Mode	Pre Recording	44.1	16	STEREO x1	29	44.1	16	STEREO x2	14	48	16	STEREO x1	27	48	16	STEREO x2	13	48	24	STEREO x1	18	48	24	STEREO x2	9	96	24	STEREO x1	9	96	24	STEREO x2	4	
Rec Freq.	Rec Bit	Rec Mode	Pre Recording																																				
44.1	16	STEREO x1	29																																				
44.1	16	STEREO x2	14																																				
48	16	STEREO x1	27																																				
48	16	STEREO x2	13																																				
48	24	STEREO x1	18																																				
48	24	STEREO x2	9																																				
96	24	STEREO x1	9																																				
96	24	STEREO x2	4																																				

System settings

Menu item	Value	Function
Project Name	Date , Name1–8	<p>This specifies how names will be assigned to the project files that are recorded. You can specify that the name will be based on the date and time, or on the Project Name you specify.</p> <p>If you choose Date, a project recorded at one twenty-three (and 45 seconds) a.m. on January 1, 2005 will be given a name of "050101012345".</p> <p>If you use the Date setting, the name of the project will tell you the time at which it was recorded; this is convenient when you've recorded a large number of projects and are looking for a specific one.</p> <p>If you use the Name setting, the project name will be the name you specified in "7 Project Name" (p. 63) plus an ascending serial number. If you specify a clearly identifiable project name, the names will follow an easily recognizable order, such as : SCENE001, SCENE002, ... etc.</p>

2 Player Setup

Menu item	Value	Function
Play Mode	Single	This selects the playback mode. Only the selected project will play.
	Sequential	All projects in the folder that contains the currently selected project will play sequentially.
Repeat	OFF , ON	This selects whether playback will repeat. If Play Mode is Single , only that project will be played repeatedly. If Play Mode is Sequential , each project in the folder that contains the currently selected project will play sequentially, and then the projects in that same folder will play sequentially again.
X2 Play	OFF, ON	This enables/disables the double-speed playback function that is activated by pressing the [PLAY] button twice. An indication of PLAY x2 will appear at the bottom of the display. Press the [PLAY] button once again to return to normal playback.

3 Speaker

Menu item	Value	Function
Speaker Switch	OFF , ON	This switches the internal speaker on/off. * Even if this setting is on, no sound will be produced by the internal speakers during recording-standby or recording if the Recording Setup parameter Input Select is set to Int-Mic; the speakers also will remain silent while headphones are being used.

4 LCD Setup

Menu item	Value	Function
Contrast	1–5–10	This adjusts the contrast of the LCD. Higher settings will emphasize the white areas of the display.
BackLight	OFF, 1–10	This adjusts the brightness of the LCD backlight. The OFF setting turns the backlight off. Higher settings will make the backlight brighter, and will consume more power. If you're operating the R-4 on battery power, pay attention to the remaining amount of battery capacity.
BackLight Timer	OFF , 2 sec, 5 sec, 10 sec, 20 sec	Specifies the time after which the display backlight will be turned off when the R-4 has not been operated for a certain length of time. If you're operating the R-4 on battery power, use this setting to conserve battery life.

5 System Setup

Menu item	Value	Function
Battery Time	Alkaline , Ni-MH	Set this to the type of batteries you're using. Choose the Alkaline setting if you're using alkaline batteries, or Ni-MH if you're using nickel metal-hydrate batteries. * If you choose a setting that does not match the type of batteries that are actually installed, the remaining battery power indication will not be correct.
L-Connector	Disable , Enable	This setting Enables or Disables the function that lets the R-4 be controlled by a device connected to the L-connector.

6 Date & Time

Here you can specify the date and time.

If **Project Name** is set to **Date**, the time you specify here will be used to specify the date in the project name.

This setting is also used for the date and time shown in the main screen.

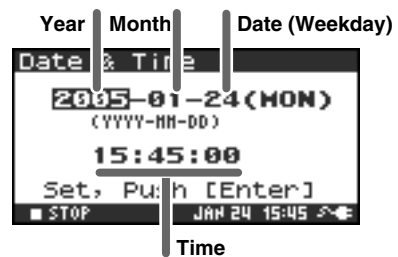

7 Project Name

You can use **Name 1–8** to specify eight different names. The project name will consist of this name plus a consecutive number of 001, 002, 003 ... appended to it. For example, in the case of the default setting **R4_Scene1**, the project name will be **R4_Scene1_001**.

In order to use a name you've specified here, you'll need to set the **Recording Setup** parameter **Project Name** to **Name 1–8**.

Available characters

(space) !#\$%&'()*+,-.0123456789;=@

ABCDEFGHIJKLMNOPQRSTUVWXYZ[]^_`abcdefghijklmnopqrstuvwxyz}

8 HDD Utility

Here you can execute various utility commands with respect to the R-4's internal hard disk. You can't execute HDD Utility commands during recording or playback.

Command	Explanation
Format	Formats the internal hard disk. All projects and folders in the internal hard disk will be erased; afterwards, the hard disk will be empty. * Be sure to back up your projects before you execute this command.
Check	Checks the internal hard disk, and after reorganization, frees up any hard disk space not used by R-4 projects. * There is no guarantee that this command will restore the internal hard disk to a normal operating state. Since this command directly affects the storage area of the hard disk, it is possible that projects may be affected. Be sure to back up your projects before you execute this command.

9 CF Utility

Here you can execute various utility commands with respect to a CompactFlash card inserted on the R-4. You can't execute CF Utility commands during recording or playback.

Command	Explanation
Format	Formats the CompactFlash card. All projects and folders on the CompactFlash card will be erased; afterwards, the card will be empty. * Be sure to back up your projects before you execute this command.
Check	Checks the CompactFlash card, and after reorganization, frees up any space on the card not used by R-4 projects. * There is no guarantee that this command will restore the CompactFlash card to a normal operating state. Since this command directly affects the storage area of the CompactFlash card, it is possible that projects may be affected. Be sure to back up your projects before you execute this command.

10 Factory Reset

This command resets the following settings to their factory-set state. You can't execute Factory Reset during recording or playback.

Recording Setup

Player Setup

Speaker

LCD Setup

System Setup

Project Name

HDD Utility

Effects (Type, Link, Play, Rec, Parameters)

Example operations

Recording Setup settings

You can use the same procedure to make the settings listed below. As an example, we'll show how to make **Recording Setup** settings.

Recording Setup
 Player Setup
 Speaker
 LCD Setup
 System Setup

- 1 Press the R-4's **[SYSTEM]** button.
 The system menu screen appears in the display.

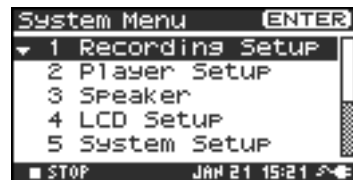

- 2 Use the **[CURSOR]** buttons to choose **1 Recording Setup**, and press the **[ENTER]** button.
 The Recording Setup screen appears.

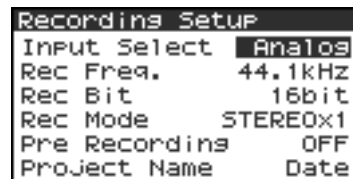

- 3 Use the **[SCRUB/VALUE]** dial to choose the **Input Select** value.
 The setting is applied as soon as you select it.
 You don't need to press the **[ENTER]** button.

- 4 Use the **[CURSOR]** buttons to choose **Rec Freq.**

- 5 Use the **[SCRUB/VALUE]** dial to select the **Rec Freq.** value.

- 6 In the same way, use the **[CURSOR]** buttons and the **[SCRUB/VALUE]** dial to choose and set the remaining items.

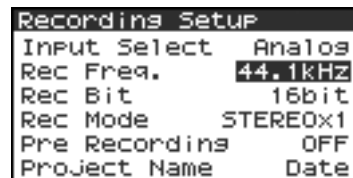

- 7 When you've finished making settings, press the **[EXIT]** button.
 You're returned to the System Menu screen.

- 8 Press the **[EXIT]** button once again to return to the main screen.

If you want to make other system-related settings, use the **[CURSOR]** buttons to select the desired menu item.

Date & Time settings

- 1 Press the R-4's **[SYSTEM]** button.
The system menu screen appears in the display.

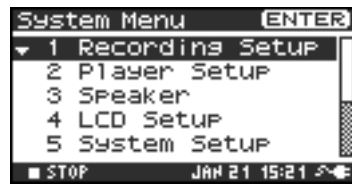

- 2 Use the **[CURSOR]** buttons to choose **6 Date & Time**, and press the **[ENTER]** button.
The Date & Time screen appears.



- 3 Use the **[CURSOR]** buttons and the **[SCRUB/VALUE]** dial to specify the date and time.
When you've finished making settings, press the **[EXIT]** button.
You're returned to the System Menu screen.
** If you decide to cancel, press the **[EXIT]** button.*

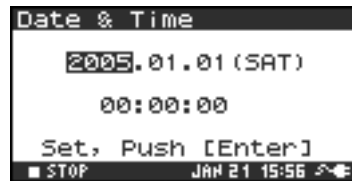

- 4 Press the **[EXIT]** button once again to return to the main screen.

If you want to make other system-related settings, use the **[CURSOR]** buttons to select the desired menu item.

Project Name settings

- 1 Press the R-4's **[SYSTEM]** button.
The system menu screen appears in the display.



- 2 Use the **[CURSOR]** buttons to choose **7 Project Name**, and press the **[ENTER]** button.
The Project Name screen appears.

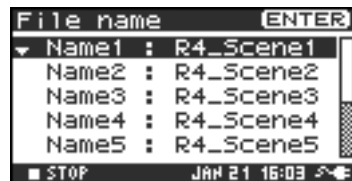

- 3 Use the **[CURSOR]** buttons to choose the Name you want to edit, and press the **[ENTER]** button.
A screen for editing the project name appears.

- 4 Use the **[CURSOR]** buttons, **[SCRUB/VALUE]** dial, **[CLEAR]** button, and **[MARK]** button to edit the name.

When you're finished, press the **[ENTER]** button.
You're returned to the Project Name screen.

* If you decide to cancel, press the **[EXIT]** button.

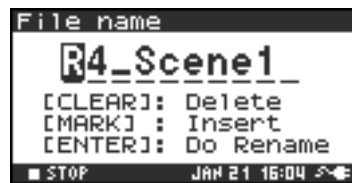

Available characters

(space) !#\$%&'()*+,-.01234546789;=@
ABCDEFGHIJKLMNOPQRSTUVWXYZ[^_`abcdefghijklmnopqrstuvwxyz{}

- 5 Press the **[EXIT]** button once again to return to the main screen.

If you want to make other system-related settings, use the **[CURSOR]** buttons to select the desired menu item.

Executing HDD Utility or CF Utility commands

As an example, we'll show how to execute HD Utility commands. You can also use the same procedure to execute CF Utility commands.

- 1 Press the R-4's **[SYSTEM]** button.
The system menu screen appears in the display.



- 2 Use the **[CURSOR]** buttons to choose **8 HDD Utility**, and press the **[ENTER]** button.
The HDD Utility screen appears.
If you want to execute a CF Utility command, choose **9 CF Utility**.
** If you decide to cancel, press the **[EXIT]** button.*



** If no CompactFlash card is inserted, the message shown at right will appear.*

- 3 Use the **[CURSOR]** buttons to choose either "Format" or "Check," and press the **[ENTER]** button.

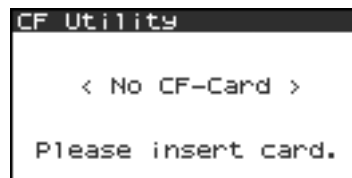

- 4 The display will ask "Are you sure?" Use the **[CURSOR]** buttons to select "Yes" if you are sure you want to execute (or "No" if you decide to cancel without executing).
Then press the **[ENTER]** button.

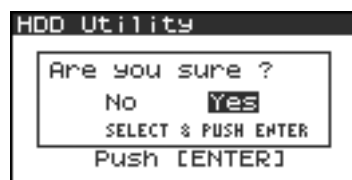

The message shown at right will appear while processing is being performed.
Don't turn off the power while processing is being performed.

When processing has been completed, you will automatically return to the System Menu screen.

- 5 Press the **[EXIT]** button once again to return to the main screen.

If you want to make other system-related settings, use the **[CURSOR]** buttons to select the desired menu item.



Executing Factory Reset (Restoring the factory settings)

- 1 Press the R-4's **[SYSTEM]** button.
The system menu screen appears in the display.
- 2 Use the **[CURSOR]** buttons to choose **10 Factory Reset**, and press the **[ENTER]** button.
The Factory Reset screen appears.
- 3 Press the **[ENTER]** button if you want to execute Factory Reset.
** If you decide to cancel, press the **[EXIT]** button.*
- 4 The display will ask "Are you sure?" Use the **[CURSOR]** buttons to select "Yes" if you are sure you want to execute (or "No" if you decide to cancel without executing).
Then press the **[ENTER]** button.
When processing has been completed, you will automatically return to the System Menu screen.
- 5 Press the **[EXIT]** button once again to return to the main screen.

If you want to make other system-related settings, use the **[CURSOR]** buttons to select the desired menu item.

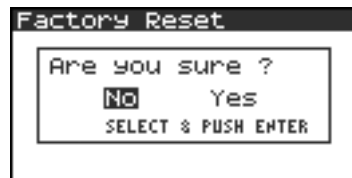
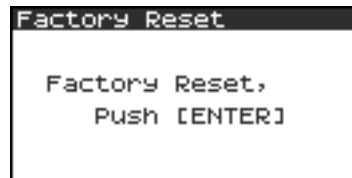
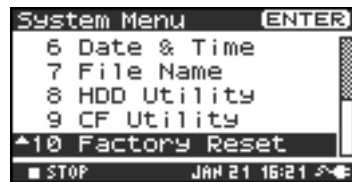

Appendix

Handling memory cards

You can use CompactFlash memory cards to transfer project files from the R-4's internal hard disk to your computer, or WAV files from your computer to the R-4's hard disk.

- * *You can also transfer files directly via a USB connection. For details, refer to “**Connecting the R-4 to your computer**” (p. 72).*
- * *You cannot record directly onto a CompactFlash card, or play back files from a CompactFlash card.*

Types of CompactFlash card you can use

- You can use CompactFlash cards of up to 2 GB (gigabytes) in capacity.
 - Some models or makes of CompactFlash card may not work correctly with the R-4.
 - Microdrives cannot be used.
- * *Don't insert or remove a CompactFlash card while it is being accessed. Doing so may damage the data in the R-4 or in the CompactFlash card, and may damage the card itself.*
- * *Carefully insert the CompactFlash card all the way in-until it is firmly in place.*

Inserting and removing a card

Inserting

- 1 Switch off the R-4's power.
- 2 Open the **[MEMORY CARD] slot** cover, and insert the CompactFlash card with its top surface facing upward.
Insert the CompactFlash card all the way into the slot.
** If you attempt to forcibly insert the card in the wrong direction, the R-4 and the CompactFlash card may be damaged. Use caution.*
- 3 Close the **[MEMORY CARD] slot** cover.

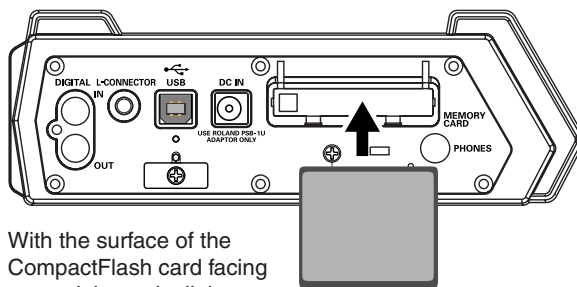

With the surface of the CompactFlash card facing upward, insert it all the way into the slot

Removing

- 1 Switch off the R-4's power.
- 2 Make sure that data is not being written to or read from the CompactFlash card.
- 3 Open the **[MEMORY CARD] slot** cover, press the eject button, and remove the CompactFlash card.

Formatting a CompactFlash card

Before you use a CompactFlash card with the R-4, you'll need to format the card. For the formatting procedure, refer to page 68 of "**Executing HDD Utility or CF Utility commands**" (p. 68). CompactFlash cards formatted on a device other than the R-4 may not work correctly on the R-4. The CompactFlash card must be formatted in FAT16 format.



As an exception, you should use your Macintosh (not the R-4) to format the CompactFlash card if you will be using the card in Mac OS 9.

Connection to a computer

Connecting the R-4 to your computer

A project you recorded on the R-4 can be moved or copied to your computer. Likewise, files from your computer can be moved or copied to the R-4's hard disk.

Using battery power will not cause a malfunction, but we recommend that you always use the AC adaptor to prevent damage to the contents of the hard disk, which could occur if the batteries fail while the R-4 is connected to your computer.

1 Turn on the R-4's **power switch**.

2 Use a USB cable to connect the R-4 to your computer.

The computer will detect the R-4, and the screen shown at right will appear.

It may take several seconds for detection to occur.

* If you see a dialog box asking you to **"Windows can perform the same action each time you insert a disk or connect a device with this kind of file,"** click **[Cancel]**.



The computer will detect the R-4 as follows.

Windows	When viewed from My Computer or Explorer, the R-4 will appear as EDIROL R-4 .
Mac OS	The R-4 will appear as EDIROL R-4 on the desktop.

3 You can copy WAV files from the R-4 to your computer, or from your computer to the R-4. To copy a file, drag and drop it.

Disconnecting the R-4 from your computer

Here's how to close the connection between your computer and the R-4. You must use the procedure described below to close the connection before you disconnect the USB cable.



Don't disconnect the USB cable or power down the R-4 while it's connected to your computer.

Windows

- 1 Close all software and windows (such as Explorer) that are referencing the R-4's hard disk.
 - * *If any software or windows (such as Explorer) that are referencing the R-4's hard disk are open when you close the USB connection between your computer and the R-4, an error will occur and the connection will not be closed correctly.*

- 2 In the Windows task tray, double-click the **Safely Remove Hardware icon** (). The **Safely Remove Hardware** dialog box will appear.

- 3 Select the item that indicates the R-4.

Item indicating the R-4

Windows XP, 2000	USB Mass Storage Device
Windows Me	USB Disk



- 4 In the dialog box, click [**Stop**].
- 5 When the **Stop a Hardware Device** dialog box appears, select the item that indicates the R-4, and click [**OK**].

- 6 When your computer indicates "**Safe To Remove Hardware**," you can disconnect the USB cable between the R-4 and your computer. Alternatively, you can switch off power to the R-4. When you disconnect the cable, the screen shown at right will appear.

* *Never switch off the R-4's power or disconnect the USB cable before you have closed the connection. Doing so may damage the internal hard disk.*



Macintosh

- 1 Cancel the connection with the R-4 displayed on the desktop.
 - If you're using **Mac OS X**, drag the **EDIROL R-4** icon into  in the dock. Normally, when you drag to the trash can located at the right edge of the dock, the indication will change from the trash can to  allowing you to cancel the connection.
 - If you're using **Mac OS 9**, drag the **EDIROL R-4** icon into the trash.
- 2 When the icon has disappeared from the desktop, you can disconnect the USB cable between the R-4 and your computer. Alternatively, you can switch off power to the R-4.

Connecting a video device that has a LANC connector

You can connect the R-4's L connector to a video device that has a LANC connector, and make the R-4 operate in synchronization with the video device.

* *The R-4 does not record or synchronize to time code. Also, the recording time on the video device and the recording time on the R-4 may drift during long recordings.*

LANC connection settings

- 1 Press the R-4's **[SYSTEM]** button.
The System Menu screen appears.

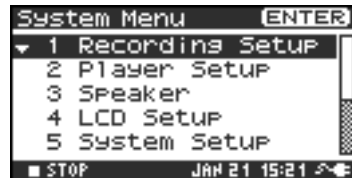

- 2 Use the **[CURSOR]** buttons to choose **5 System Setup**, and press the **[ENTER]** button.

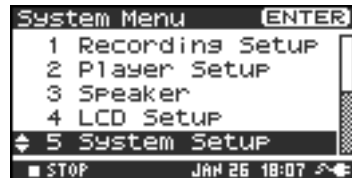

- 3 The **System Setup** screen appears.
Use the **[CURSOR]** buttons to choose **L-Connector**.

- 4 Use the **[SCRUB/VALUE]** dial to select **Enable**.
The setting is applied when you select it. You don't need to press the **[ENTER]** button.



- 5 Press the **[EXIT]** button.

You're returned to the System Menu screen. Press the **[EXIT]** button once again to return to the main screen.

In this state, the R-4 will operate in synchronization with your video device. For details on settings and operation for your video device, refer to the manual of your video device.

Using the LANC connection

- 1 Use the special cable to connect the LANC connector of your video device to the R-4's **[L-CONNECTOR]**.
- 2 Power up your video device.
- 3 When your video device enters recording-standby mode, the R-4 will also enter recording-standby mode.
- 4 When you begin (or stop) recording on your video device, the R-4 will also begin (or stop) recording.

Application guide

Before you record using the R-4, you'll need to make a variety of settings so it's set up in a way that's appropriate for your recording situation and purposes. This section gives several actual examples of applications. For details on connections refer to "Recording" (p. 27). Here we will explain the settings you'll need to make on the R-4.

Connecting an external mic for CD-quality stereo recording

This is a basic form of recording.

■ Panel settings

Input level select switch	MIC
Phantom power switch	ON if you're using a condenser mic that requires phantom power; otherwise OFF

■ Recording Setup

Input Select	Analog
Rec Freq.	44.1 kHz
Rec Bit	16 bit
Rec Mode	STEREOx1
Pre Recording	OFF
Project Name	Date

Recording birdsongs outdoors

Here are basic settings for recording birdsongs or similar sounds outdoors. Since you'll need to run on batteries outdoors, the settings take power conservation into account.

■ Panel settings

Input level select switch	MIC
Phantom power switch	ON if you're using a condenser mic that requires phantom power; otherwise OFF

■ Recording Setup

Input Select	Analog	By lowering the sampling frequency (Rec Freq.) and limiting the number of tracks, you can minimize the size of the file to be written. This will decrease the amount of access to the hard disk, thereby conserving power.
Rec Freq.	44.1 kHz	
Rec Bit	16 bit	
Rec Mode	STEREOx1, MONOx1	Set to match the mics that are connected.
Pre Recording	4 sec	The pre-recording setting lets you press the record button when you hear birdsong; sounds that occurred several seconds earlier will be captured retroactively. If you're trying to capture birdsong, a setting of four seconds will be sufficient. In comparison to allowing recording to continue, this method will minimize the number of accesses to the internal hard disk. However, with any pre-recording setting other than OFF, recording will always be occurring internally.
Project Name	Date	Using the Date setting will make it easy to tell the date and time that the recording was made.

■ LCD Setup

BackLight Timer	5 sec
------------------------	-------

■ System Setup

Battery Type	Set to the type of batteries you've installed
---------------------	-----------------------------------------------

Recording audio while shooting video

Here are the basic settings for using the R-4 to record audio while you're shooting video. If you're recording outdoors, the settings for "**Recording birdsongs outdoors**" (p. 76) can be used in this case as well, but other settings specific to video will also be necessary.

■ Panel settings

Input level select switch	MIC
Phantom power switch	ON if you're using a condenser mic that requires phantom power; otherwise OFF

■ Recording Setup

Input Select	Analog	The number of mics will depend on the video you're shooting. If you're simply recording the background sound, use two mics and record in stereo. If you're recording a play or an instrumental performance, you'll probably want to set up one mic for each actor or instrument. You can record up to four mics simultaneously.
Rec Freq.	48 kHz	If you're going to shoot video with a video camera, and later use a video editing system to bring in the audio tracks recorded by the R-4, it's a good idea to record at 48 kHz.
Rec Bit	16 bit	If you're capturing audio for use in a production in which the video is the main element, 16-bit recording provides sufficient quality.
Rec Mode	Set this to match the mic(s) you're using. Choose the MONO setting if each mic is assigned to a different actor or instrument. With the MONO setting, a separate WAV file will be created for each mic. In other cases you will generally use the STEREO setting.	
Pre Recording	OFF	Turn this OFF, since you'll be synchronizing to the video device.
Project Name	Name	It's convenient to assign a unique name to the project so that each recorded project will be easily identifiable; e.g., SCENE001, SCENE002, ... etc.

■ System Setup

L-Connector	Enable	Set this to Enable if you're synchronizing the R-4 with a video camera that is equipped with a LANC connector.
--------------------	--------	----------------------------------------------------------------------------------------------------------------

Recording audio memos using just the R-4

You can use the internal mics to record on just the R-4 without needing any external equipment. However, the recording quality will be unavoidably less than when using good-quality external mics. The sound of the R-4's button operations or internal mechanism may also be present in the recording.

Input Select	Int-Mic
Rec Freq.	44.1 kHz
Rec Bit	16 bit
Rec Mode	STEREOx1
Pre Recording	OFF
Project Name	Date

Simultaneously recording environmental sounds (ambience)

You can take advantage of the R-4's ability to record four channels simultaneously. You might use channels 1 and 2 to record the stage performance via line inputs, and channels 3 and 4 to record the sounds of the room or audience via mics.

■ Panel settings

Input level select switch	LINE (CH1 and 2), MIC (CH3 and 4)
Phantom power switch	ON if you're using a condenser mic that requires phantom power; otherwise OFF

■ Recording Setup

Input Select	Analog	Set this to Analog since you're recording from the combo input jacks.
Rec Freq.	44.1 kHz	If you'll be using a computer to edit the waveforms after recording, you may wish to use a higher sampling frequency.
Rec Bit	16 bit	
Rec Mode	STEREOx2	Choose the STEREO x2 setting so that you can record two stereo pairs; one pair is the line feed from the stage and the other pair is the ambience mics.
Pre Recording	OFF, 1–29 sec	Specify the pre-recording time as desired.
Project Name	Date, Name	Specify a name that will help you manage the projects when you've finished recording. Date... Using the Date setting will make it easy to tell the date and time that the recording was made. Name... Assigning a unique project name, so that the projects have names such as SCENE001, SCENE002, and so forth, will make it easy to see which projects belong together.

Simultaneously recording at different input levels

These settings are useful when you cannot afford mistakes, such as when recording an event or other non-repeatable occasion. Even if you've set the input levels appropriately, there may be cases in which an unexpectedly loud sound causes clipping to occur; or conversely, in which the sound stays at an unexpectedly low level.

In such cases, you can use two pairs of mics and channels, each set to differing input levels, and record them simultaneously. Afterward, you can choose the best pair.

■ Panel settings













Input level select switch	MIC
Phantom power switch	ON if you're using a condenser mic that requires phantom power; otherwise OFF
Input level knobs	Set channels 1 and 2 to appropriate levels. Set channels 3 and 4 to slightly lower input levels; for example, about -12 dB lower than channels 1 and 2.

■ Recording Setup

Input Select	Analog
Rec Freq.	44.1 kHz
Rec Bit	16 bit
Rec Mode	STEREOx2
Pre Recording	OFF
Project Name	Date

Messages

This section explains the most important messages that may appear in the R-4's display

Message	Status
 Int-Batt Low!	Int-Batt Low! The internal battery has run low. The internal battery must be replaced. If it runs low, the internal clock will become inaccurate. Please contact one of the service locations listed on the warranty card to have the battery replaced.
 Battery Low!	Battery Low! The batteries have run low. Install fresh batteries, or use the AC adaptor.
 HDD Slow!	HDD Slow! Data could not be written to the hard disk fast enough. This message may be encountered after you've repeatedly written and erased project files, and have thus caused the files on the hard disk to become fragmented, slowing down the access speed.
 Media Full!	Media Full! There is insufficient free space on the hard disk or CompactFlash card. Transfer project files to your computer to free up more space.
 Over 2GB	Over 2GB The project is too large. This message will appear if the project newly created by appending an existing project exceeds 2 GB. The R-4 can handle files up to 2 GB in size.
 Project exists!	Project exists! An identically named project already exists. Create the project using a different name.
 File-Sys Error!	File-Sys Error! A problem has occurred with the file system.
 Name too long!	Name too long! The project name is too long. This message will appear if the project name newly created when you use Trim, Combine, or copy a project is too long. You'll need to shorten the name of the source project.
 Improper Proj.	Improper Proj. The R-4 cannot handle this project.
 HOLD ON	HOLD ON The HOLD switch is on. This message will appear if you attempt to operate the R-4 while the HOLD switch is on.
 Now Recording	Now Recording The R-4 is recording now. This message will appear if you attempt to operate the R-4 during recording. If you need to perform an operation, you must first stop recording.
 Now Playing	Now Playing The R-4 is playing now. This message will appear if you attempt to operate the R-4 during playback. If you need to perform an operation, you must first stop recording.
 LANC Offline	LANC Offline The connection with the L connector has been broken. This message will appear if signals from the L connector are interrupted, or if the cable is disconnected.

Troubleshooting

If you experience difficulties, read this section first. It contains tips on how to resolve various problems.

Computer-related problems

Can't close the connection with the R-4

If you're using Windows, and Explorer or any other software that is referencing the R-4's hard disk is open when you attempt to close the USB connection between the R-4 and your computer, the error message "An error occurred while removing USB mass storage device – Unable to close device 'unspecified volume'.

Please execute Stop Device again later." will appear, and you will be unable to disconnect the R-4.

Close all software or windows that are referencing the R-4's hard disk. Then execute "Safely remove hard disk" once again.

CompactFlash card inserted in the R-4 is not visible from the computer

The CompactFlash card inserted in the R-4 will not be directly visible from the computer. This means that you won't be able to manipulate projects within the CompactFlash.

Recording-related problems

Can't record

You won't be able to record correctly if the input level you specified using the input level knob is too low. Please set the input level correctly.

Refer to: "Adjusting the input level" (p. 28)

Nor will you be able to record correctly if the input level select switch is set incorrectly. Please set the input level switch correctly.

Refer to: "Input level select switches" (p. 16)

If you're recording from a connected mic, make sure that the mic is correctly connected to the combo input jack.

Also check the setting of the input level select switch and the phantom power switch.

Refer to: "Phantom power switches [PHANTOM POWER]" (p. 10)

"Input level select switches" (p. 16)

You also won't be able to record correctly if the system setting Input Select is wrong.

Refer to: "System settings" (p. 60)

Strange sounds are heard during the recording

If you've recorded via the internal mics, you may hear metallic, mechanical clicks in the recording. These sounds are the operating noises of the R-4's internal hard disk. Due to how the R-4 is constructed, the hard disk operating sounds may affect the recording.

You can alleviate this somewhat by using the **Graphic EQ** effect on the **REC** side to lower the 2 kHz and 4 kHz levels.

Recorded sound is distorted

The sound will be distorted if the input level is too high. Refer to "Adjusting the input level" (p. 28), and use the input level knob to adjust the level appropriately.

In some cases, the sound may be distorted because you've applied an effect while recording. You should adjust the input level with the effect applied. Adjust the effect parameters so that distortion does not appear.

Pan (stereo image) is not recorded correctly

If the limiter is turned on, it will respond to the levels of each channel, meaning that when the level of a sound located toward the right (or left) side increases, the limiter for that channel will limit the volume. If you're recording in stereo, the result will be that the left and right volume difference will diminish, causing the pan (stereo image) to move toward the center.

The limiter cannot be applied to multiple channels as a group.

If you're using the **Comp&DeEsser** effect with channel linking (LINK) set separately for CH1, CH2, CH3, and CH4, and the compressor begins to operate on CH1 (left), this will eliminate the level difference with CH2 (right), causing the pan (stereo image) to move toward the center.

In this case, set the LINK setting to CH1+2 or CH3+4 so that whenever compression starts being applied to CH1 (left), it will be applied to CH2 (right) at the same time.

Also, the stereo image will not be recorded correctly if the input level knob settings differ significantly between L and R, so that the levels are not balanced correctly.

Even though you've set the recording levels, the sound is distorted when you turn on an effect

Since some effects work by emphasizing a portion of the sound, this may increase the volume of the overall song, thereby causing clipping (distortion). You may take either of the following two actions.

- Lower the level (LEV) values for each effect parameter
The overall volume will decrease, but the character of the effect will be maintained.
Refer to: "Effects setting" (p. 55)
- Lower the input level to decrease the volume before applying the effect
This adjustment is easy to make, but may change the resulting character of the effect.

A message of HDD Slow! appears

Writing access to the hard disk has slowed down.

As you repeatedly write and delete project files, the files on the hard disk will become fragmented, and this will slow down the processing speed.

If you are making important recordings, you should consistently delete all projects together when you're finished with them. Repeated deletion of smaller pieces of data will cause the disk to become fragmented, possibly causing recording to fail.

Playback-related problems

No sound

If the monitor level knob is turned too far down, the volume may be too low for you to hear. Gradually raise the monitor level knob.

Refer to: “**Monitor level knob [MONITOR]**” (p. 13)

Make sure that your headphones or speakers are connected correctly.

No sound from the internal speakers

In the system settings for Speaker, make sure that Speaker Switch is ON. No sound is output from the internal speakers if this setting is OFF.

No sound is output from the internal speakers if headphones are connected.

To prevent acoustic feedback, no sound is output from the internal speakers during recording or recording-standby.

The CompactFlash card contains a file, but the R-4 won't play it

The R-4 can't directly play files from the CompactFlash card.

In order to play a file located on the CompactFlash card, use the Finder screen to copy the file onto the R-4's hard disk, and then play it.

Refer to: “**Copying a project (Copy)**” (p. 44)

A skip of several seconds occurs in the project playback

If the R-4 is subjected to vibration or impact, writing to the hard disk may not occur in time, meaning that that portion of sound will not be recorded. When you listen to the recorded project, the time count during playback will not skip, but there will be a skip of several seconds in the sound of the project.

During recording, please be careful that the R-4 is not subjected to impact.

The sound skips when you play back through the internal speakers

Vibration produced by the internal speakers may cause reading from the hard disk to fail, and this may cause skips in the sound.

Try turning the monitor level knob toward the left to lower the volume of the internal speakers.

Alternatively, you can monitor through headphones.

Skips occur in the sound

As you repeatedly write and delete project files, the files on the hard disk will become fragmented, and this will slow down the processing speed. If you continue recording in this state, a message of “HDD Slow!” will appear, and skips may occur in the recorded project.

If you are making important recordings, you should consistently delete all projects together when you're finished with them. Repeated deletion of smaller pieces of data will cause the disk to become fragmented, possibly causing recording to fail.

Problems with the R-4's operation

Power does not turn on

Make sure that the AC adaptor is correctly connected.

If you're using batteries, make sure that each battery is securely in place and in the correct orientation. It's also possible that the batteries have run down, so you should obtain a new set of batteries.

Refer to: "Connecting the AC adaptor and turning the power on" (p. 24)
"Installing batteries and turning the power on" (p. 25)

Make sure that the HOLD switch is turned off. If it is on, the panel buttons and the scrub and shuttle dials will be inoperable.

Refer to: "Hold switch [HOLD]" (p. 10)

Finder operation is sluggish

If a folder contains a large number of files, operation will be sluggish when you open the Finder, and the screen will not scroll easily.

If there is a large number of files, operations in the Finder will take more time. Try moving projects in the folder to a different folder so that the folder contains fewer projects.

Device connected to the L connector does not work correctly

The R-4's L connector is only for reception. You cannot connect it to a controller that requires transmission functionality or power supply, and use it to operate the R-4.

Backlight turns off

The Backlight setting in **LCD Setup** may be set to turn off the backlight when the unit has not been operated for a while.

Refer to: "4 LCD Setup" (p. 62)

Settings you made have disappeared

If effect settings or system settings you made have reverted to their original state, it's possible that you inadvertently reset the R-4 to its factory-set condition.

Refer to: "Executing Factory Reset (Restoring the factory settings)" (p. 69)

Effect parameters you set have been initialized

Effect parameter values will be remembered as long as you don't change the effect type; they will return to the default values if you change the effect type. If you've made precise settings, it's a good idea to make a note of those settings if you want to use them again.

Refer to: "Effects setting" (p. 55)

Can't operate the panel

Make sure that the HOLD switch is turned off.

If this is on, the panel buttons and the scrub and shuttle dials will be inoperable.

Refer to: "Hold switch [HOLD]" (p. 10)

Project names and folder names in the main switch or Finder are garbled

WAVE file or folder names that contain double-byte characters (e.g., Japanese) are not displayed correctly. In some cases, it will not be possible to Rename them successfully.

Refer to: "Available characters" (p. 63)

Main specifications

Recorder Part

● Channels

4

● Signal Processing

AD/DA Conversion: 24 bits
Sampling Frequency: 44.1/48/96 kHz

● Data Type

Format: WAV
Sampling Frequency: 44.1/48/96 kHz
Bit Depth: 16/24 bits

● Media

Internal Hard Disk Drive (40 GB)
CompactFlash (supports 32 MB–2 GB)

● Recording Time

16 bit/44.1 kHz (Stereo): 58 hours
16 bit/48 kHz (Stereo): 53 hours
24 bit/48 kHz (Stereo): 35 hours
16 bit/96 kHz (Stereo): 17 hours

* These recording times are approximate. Your actual results may vary somewhat.

* If more than one recorded file exists, the total recordable time will be less than these.

Audio Input and Output Part

● Analog Inputs

Channel 1–4:
XLR type (phantom powered),
1/4 inch TRS phone type (balanced/unbalanced)
Internal Microphone (Stereo)

● Analog Outputs

LINE Out:
1/4 inch phone type (L, R),
RCA phono type (L, R)
Headphones:
Stereo 1/4 inch phone type

● Digital Input/Output

Coaxial type (conforms to IEC60958)

● Input Impedance

4 k ohms

● Nominal Input Level (Variable)

Line Level: -33– +4 dBu
MIC Level: -60– -23 dBu

● Output Impedance

LINE Out: 950 ohms
Headphones: 10 ohms

● Output Level:

LINE Out: -10 dBV
Headphones: 40 mW + 40 mW

● Limiter threshold level

-10 dB (relative to digital full-scale),
maximum compression ratio 1:3

● Residual Noise Level

LINE Out: -85 dBu
Digital Data: -90 dBFS
(fs = 96 kHz, Input: 1 k ohms terminated,
Level Switch: MIC,
Input Level Knob: Min. Input: 4 channels simultaneously)

● Total Harmonic Distortion (THD + N)

0.03 %
(fs = 96 kHz, Input: 1 k ohms terminated, Level Switch:
LINE, Input Level Knob: Min. Input: 4 channels
simultaneously, Band Width: 22 kHz)

● Recommended Load Impedance for Headphones

32 ohms

● Frequency Response

10 Hz–40 kHz (0– -3 dB)

● Phantom Power

48+/-2 V / 8 mA
Available 4 Channels simultaneously
(total of all channels must be 25 mA or less)

* 0 dBu = 0.775 Vrms

Other Input/Output Part

● USB Interface

B Type Connector
Supports USB 1.1 and 2.0 Mass Storage Device Class.

● CompactFlash Slot

Supports Type I only.

● L Connector

Receiving only.
Supports Start/Stop Sync only.
Not Supports Timecode.

Effect Unit Part

Effect Type:
3-BAND SHELVING EQ, 6-BAND GRAPHIC EQ, NOISE
GATE, ENHANCER, COMPRESSOR AND DE-ESSER, NO
EFFECT

* Available to either recording or playing

* Not available to recording in 96 kHz sampling frequency.

Control

- Power Switch
- Hold Switch
- Input Gain Knobs: CH1-CH4
- Monitor Level knob
- Input Level Switches:
CH1/2, CH3/4 (LINE/MIC Level)
- Phantom Power Switches: CH1/2, CH3/4
- Limiter Switch
- Scrub (Value)/Shuttle Dial
- Transport Buttons:
PREV, NEXT, STOP, PLAY, PAUSE, REC
- Marker Buttons: CLEAR, PREV, NEXT, MARK
- Function Buttons: WAVE EDIT, EFFECTS, SYSTEM
- A-B Repeat Button
- Display Button

Others

● Display

128 x 64 dots Graphic LCD (backlit LCD)

● Power Supply

AC Adaptor, Alkaline dry battery LR6 (AA) type x 8, or
Nickel Hydrogen battery (HR15/51) x 8

● Power Consumption

2000 mA

● Dimensions

240 (W) x 217.4 (D) x 77.1 (H) mm
9-1/2 (W) x 8-9/16 (D) x 3-1/16 (H) inches

● Weight (with batteries)

1.7 kg
3 lbs 12 oz

● Accessories

Owner's Manual
AC Adaptor
USB cable
Carrying Case

* In the interest of product improvement, the specifications and/or appearance of this unit are subject to change without prior notice.

Block diagram

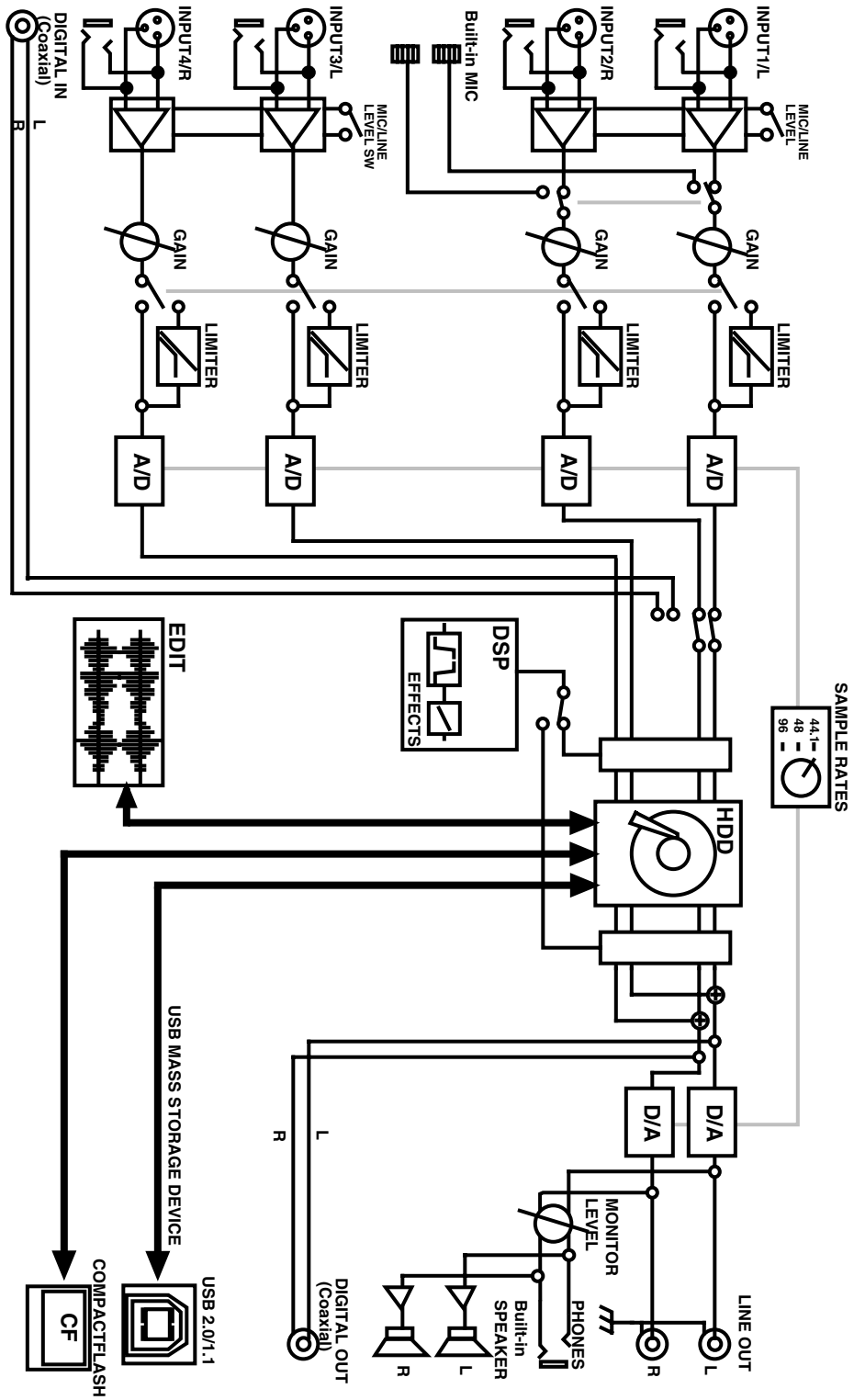

Deutsch

Beschreibung des R-4 p. 88

Français

PrésentatioFrancaisn du R-4 p. 94

Italiano

Presentazione dell'R-4 p. 100

Español

Presentación del R-4 p. 106

Beschreibung des R-4

Oberseite

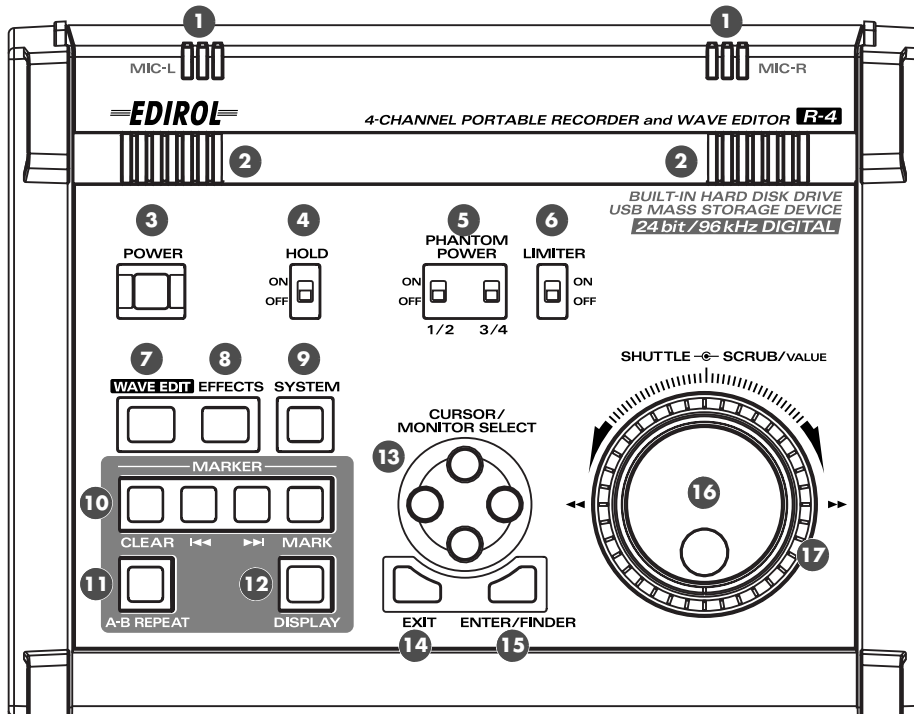

1 Interne Mikrofone (MIC-L, MIC-R)

Sounds vom MIC-L werden auf dem 1L-Kanal aufgenommen und Sounds vom MIC-R auf dem 1R-Kanal. Wenn Sie Aufnahmen mit den internen Mikrofonen machen, stellen Sie in den Systemeinstellungen **Recording Setup** auf **Int-Mic**. Weitere Details finden Sie unter **“Recording from the internal mics”** (S. 30).

* Schließen Sie nichts an die Eingänge an, die Sie nicht verwenden.

2 Interne Lautsprecher

Wenn die Wiedergabe über die internen Lautsprecher erfolgen soll, stellen Sie in den Systemeinstellungen **Speaker** auf **ON**. Weitere Details finden Sie unter **“Playing back”** (S. 34). (S. 54).

* Wenn Sie Kopfhörer an die **Kopfhörerbuchse** (17) angeschlossen haben, sind die internen Lautsprecher abgeschaltet. Bei der Aufnahme oder bei Aufnahmebereitschaft (Standby-Modus) erfolgt ebenfalls keine Wiedergabe über die internen Lautsprecher, um Rückkopplungen zu vermeiden.

3 Netzschalter (POWER)

Schaltet das Gerät an und aus. Hierzu drücken Sie die Taste und halten Sie etwa zwei Sekunden lang gedrückt. Wenn das Gerät eingeschaltet ist, leuchtet die Taste grün. Bei Aufnahme oder Wiedergabe darf das Gerät nicht ausgeschaltet werden. Vergewissern Sie sich vor dem Ausschalten, dass Wiedergabe oder Aufnahme gestoppt sind.

* Falls Sie das Gerät während einer Aufnahme versehentlich ausschalten, werden die aufgenommenen Daten nicht auf der Festplatte gespeichert.

* Die Festplatte kann beschädigt werden, wenn Sie das R-4 ausschalten, während Daten auf der Festplatte gespeichert oder von ihr gelesen werden (wie dies bei Aufnahme oder Wiedergabe der Fall ist). Außerdem darf das R-4 während der Datenübertragung von der Festplatte auf die CompactFlash-Karte nicht ausgeschaltet werden.

* Das R-4 darf nicht abgeschaltet werden, wenn das Display **“Now Connecting...”** oder **“Now Processing”** anzeigt! Hierdurch wird das R-4 instabil, außerdem kann dadurch die interne Festplatte beschädigt werden.

4 Hold-Schalter (HOLD)

Durch Stellen des Schalters auf **HOLD ON** werden die Tasten des Bedienfeldes gesperrt, damit durch versehentliches Drücken keine unerwünschten Operationen ausgelöst werden.

In der Schalterposition **HOLD ON** sind die folgenden Bedienelemente jedoch immer noch in Funktion, also nicht gesperrt: **Phantomspannungsschalter**, **Begrenzer-Schalter**, **Eingangswahlschalter**, **Eingangspegel** und **Ausgangspegel**.

5 Phantomspannungsschalter (PHANTOM POWER)

Diese Schalter schalten die Phantomspannung für die XLR-Anschlüsse der Combo/Eingangsbuchsen an der rechten Seite ein und aus. Es gibt separate Schalter für die Kanäle 1/2 und die Kanäle 3/4, Sie können die Phantomspannung für die Kanäle also separat wählen.

6 Begrenzer-Schalter (LIMITER)

Dieser Schalter schaltet einen Eingangspegelbegrenzer für den analogen Schaltkreis ein und aus.

Wenn der Eingangspegel zu hoch ist, komprimiert der Begrenzer den Eingangspegel, um Verzerrungen vorzubeugen.

Der Schalter schaltet den Begrenzer für alle Kanäle 1 bis 4 gemeinsam ein und aus. Der Eingangspegel wird jedoch für jeden einzelnen Kanal separat ermittelt. Sie können den Begrenzer nicht separat für jeden Kanal ein- und ausschalten.

7 Wave-Edit-Taste (WAVE EDIT)

Mit dieser Taste aktivieren Sie den Wave-Edit-Modus, in dem Sie Operationen wie Trim (Trimmen), Divide (Teilen), Combine (Kombinieren) und Merge (Zusammenführen) ausführen können. Details hierzu finden Sie unter **“Editing”** (S. 48).

Sie können den Wave-Edit-Modus nicht aufrufen, wenn auf der Festplatte des R-4 keine Dateien gespeichert sind, die das R-4 verarbeiten kann. WAV-Dateien sind die einzigen Dateitypen, die das R-4 verarbeiten kann.

8 Effekt-Taste (EFFECTS)

Details finden Sie unter **“Effects setting”** (S. 55)

9 Systemtaste (SYSTEM)

Details finden Sie unter **“System settings”** (S. 60).

10 Marker (MARKER)

Löschtaste (CLEAR)

Mit dieser Taste löschen Sie einen Marker, den Sie mit der **Mark-Taste** gesetzt haben. Die Marker werden nacheinander gelöscht, und zwar beginnend mit dem Marker, der sich unmittelbar vor der aktuellen Position befindet.

◀◀Taste

Mit dieser Taste kommen Sie zu dem Marker, der sich unmittelbar vor der aktuellen Position befindet (der vorangegangene Marker).

▶▶Taste

Mit dieser Taste kommen Sie zu dem Marker, der sich unmittelbar hinter der aktuellen Position befindet (der nächste Marker).

Mark-Taste (MARK)

Durch Drücken dieser Taste können Sie an einer gewünschten Position in der Projektdatei einen Marker setzen. Die Marker werden vom Startpunkt des Projekts an nacheinander durchnummeriert.

11 A-B Wiederholtaste (A-B REPEAT)

Mit dieser Taste können Sie wiederholt Teile des Projekts zwischen zwei Punkten (A und B) wiedergeben. Hierzu weisen Sie einfach Marker A und Marker B beim Abspielen des Projekts zu. Die Wiedergabe erfolgt dann zwischen den Markern A und B.

1. Drücken Sie während der Wiedergabe einmal die **A-B Repeat-Taste**.

Dieser Punkt (Marker A) wird der Startpunkt der wiederholten Wiedergabe.

2. Drücken Sie nochmals die **A-B Repeat-Taste**. Dieser Punkt wird der Endpunkt B (Marker B) der wiederholten Wiedergabe.

Der in den Schritten 1 und 2 festgelegte Abschnitt wird wiederholt abgespielt. Zum Stornieren der Abspielwiederholung drücken Sie nochmals die **A-B Repeat-Taste**.

12 **Display-Taste (DISPLAY)**

Mit dieser Taste wird der Anzeigehalt des R-4 gewechselt. Details hierzu finden Sie unter **“Display”** (S. 18).

13 **Cursor/Monitor Auswahlstasten (CURSOR / MONITOR SELECT)**

Mit diesen Tasten wählen Sie, was im Display angezeigt wird. Wenn Sie sich in der Hauptanzeige befinden, können Sie mit den Tasten AUF/AB den Kanal wählen, den Sie sehen möchten. Details hierzu finden Sie unter **“Display”** (S. 18).

14 **Exit-Taste (EXIT)**

Mit dieser Taste gehen Sie zur vorangegangenen Anzeige zurück oder stornieren Sie eine Operation.

15 **Enter/Finder-Taste (ENTER/FINDER)**

Mit dieser Taste bestätigen Sie eine Einstellung oder schließen Sie eine Eingabe ab. Die Taste dient auch zur Nutzung der Finder-Funktion. Informationen zur Finder-Funktion finden Sie unter **“The Finder screen”** (S. 41).

16 **Drehregler (SCRUB/VALUE)**

Mit diesem Drehregler wählen Sie Teile aus, für die Einstellungen vorgenommen werden sollen. Er dient auch zum Verändern eines Wertes. Wenn die Wiedergabe gestoppt oder unterbrochen ist, können Sie mit dem Drehregler die aktuelle Position nach vorn oder nach hinten verschieben.

17 **Shuttle-Regler (SHUTTLE)**

Beim Abspielen wird durch Drehen des Reglers im Uhrzeigersinn schneller vorwärts und durch Drehen gegen den Uhrzeigersinn schneller rückwärts abgespielt. Wenn das Projekt gestoppt ist, stellt dieser Regler den Zeitähler vor.

Vorderseite

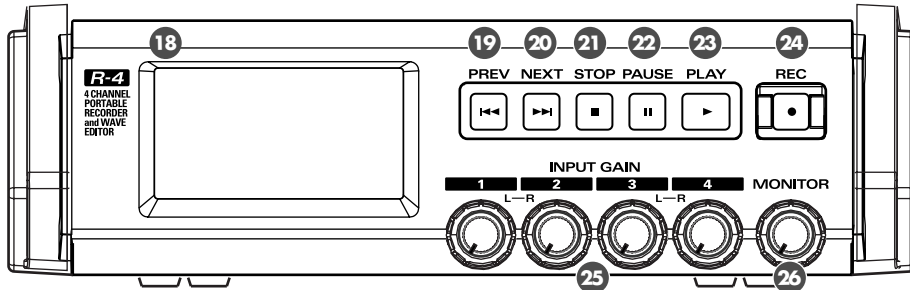
**18 Anzeige****19 PREV-Taste (PREV)**

Durch Drücken der **PREV-Taste** während des Abspielens oder Stopps eines Projekts gelangen Sie an den Anfang des Projekts (00:00:00). Wenn Sie diese Taste am Anfang eines Projekts drücken, gelangen Sie zum vorangegangenen Projekt.

Mit kontinuierlichem Druck auf diese Taste können Sie zurückspulen. Dies gilt sowohl beim Abspielen als auch beim Stopp.

* Wenn unter **Player Setup** in den **Systemeinstellungen (Settings)**, der **Abspielmodus (Play Mode)** auf **Single** eingestellt wurde, kommen Sie nicht zum vorangegangenen oder nächsten Projekt.

20 NEXT-Taste (NEXT)

Durch Drücken der **NEXT-Taste** kommen Sie zum nächsten Projekt. Mit kontinuierlichem Druck auf diese Taste können Sie vorspulen. Dies gilt sowohl beim Abspielen als auch beim Stopp.

21 Stopp-Taste (STOP)**22 Pause-Taste (PAUSE)****23 Play-Taste (PLAY)**

Diese Taste startet die Wiedergabe. Die **PLAY-Taste** ist bei der Wiedergabe blau erleuchtet. Bei der Wiedergabe können Sie die **PLAY-Taste** erneut drücken, um mit doppelter Geschwindigkeit abzuspielen. Wenn Sie die **PLAY-Taste button** beim Abspielen mit doppelter Geschwindigkeit erneut drücken, wird wieder mit normaler Geschwindigkeit abgespielt. Beim Abspielen mit doppelter Geschwindigkeit wird im unteren Teil des Displays **PLAY X2** angezeigt. Die Wiedergabe mit doppelter Geschwindigkeit verändert die Tonhöhe.

* Wenn Sie die Option des Abspielens mit doppelter Geschwindigkeit ausschalten möchten, stellen Sie in den System-einstellungen unter **Player Setup X2 Play OFF** ein. Weitere Details finden Sie unter **“2 Player Setup”** (S. 62).

24 Aufnahmetaste (REC)

Die Aufnahme erfolgt unmittelbar nachdem Sie die **REC-Taste** gedrückt haben. Die **REC-Taste** leuchtet bei der Aufnahme rot. Wenn Sie die **PAUSE-Taste** gedrückt halten und gleichzeitig die **REC-Taste** drücken, blinkt die **REC-Taste** rot und zeigt die Aufnahmebereitschaft des R-4 an. Die Aufnahme erfolgt unmittelbar, wenn Sie dann die **REC-Taste** oder die **PAUSE-Taste** drücken.

25 Eingangspegel-Regler 1–4 (INPUT GAIN)

Mit diesen Drehknöpfen werden die Eingangspegel der **Combo-Eingangsbuchsen 1–4** (39) eingestellt. Die Eingangspegel der **internen Mikrofone** (1) werden mit **Drehknopf 1** (MIC-L) und **Drehknopf 2** (MIC-R) eingestellt.

26 Monitor-Lautstärkeregler (MONITOR)

Mit diesem Drehknopf wird die Lautstärke der **internen Lautsprecher** (2) und der Ausgangspegel der **Kopfhörerbuchse** (37) geregelt.

Der Ausgangspegel der **Line-Ausgangsbuchsen** (40) ist nicht regelbar. Wenn Sie die Lautstärke der Line-Ausgangsbuchsen verändern wollen, müssen Sie diese Einstellung an der Lautstärkeregelung der externen Lautsprecher oder am Wiedergabesystem vornehmen.

Linke Seite

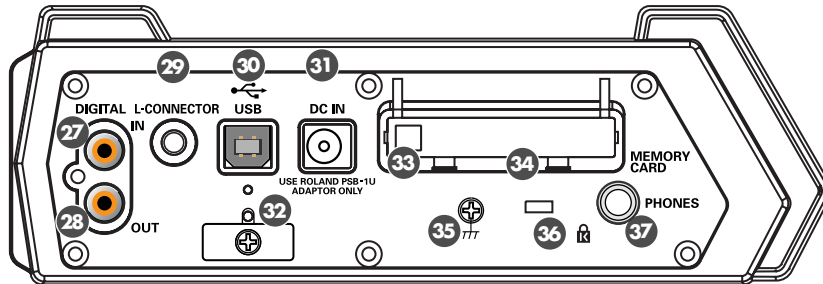

27 Digitale Eingangsbuchse (DIGITAL IN)

Wenn Sie ein digitales Signal aufzeichnen wollen, schließen Sie ein Koaxialkabel an diese Buchse an. Das digitale Eingangssignal wird in Stereo auf den Kanälen 1L und 1R aufgezeichnet. Wenn Sie in Mono aufzeichnen wollen, müssen Sie in der Systemeinstellung den **Rec Mode (Aufzeichnungsmodus)** ändern. Weitere Details finden Sie unter "1 Recording Setup" (S. 60).

28 Digitale Ausgangsbuchse (DIGITAL IN)

Diese Buchse liefert dasselbe Audiosignal wie die **Line-Ausgangsbuchsen** (40) und die **Kopfhörerbuchse** (37), allerdings in digitaler Form.

29 L-Anschluss (L-CONNECTOR)

Mit einem Mini-Stereokabel können Sie diesen Anschluss mit einem Videogerät verbinden, das einen LANC-Anschluss hat. Wenn Sie mit dem Videogerät aufzeichnen, nimmt das R-4 parallel ebenfalls auf. Wenn Sie die Aufzeichnung am Videogerät anhalten, stoppt das R-4 ebenfalls die Aufnahme. Detaillierte Informationen finden Sie unter "Connecting a video device that has a LANC connector" (S. 74).

30 USB-Anschluss (USB)

31 AC-Netzgeräteeingangsanschluss (DC IN)

32 Kabelklemme

33 Auswurfmechanismus

34 Speicherkarteneinlage (MEMORY CARD)

Das R-4 kann nur CompactFlash Speicherkarten TYPE 1 verwenden. Microdrive-Karten werden nicht unterstützt.

Details zur Handhabung von CompactFlash-Karten finden Sie unter "Handling memory cards" (S. 70).

35 Erdungsanschluss

36 Sicherheitsschlitz ()

<http://www.kensington.com/>

37 Kopfhörerbuchse (PHONES)

Schließen Sie Ihre Kopfhörer an diese Buchse an. Mit dem **Monitor-Lautstärkeregel** (26) stellen Sie die Lautstärke ein. Wenn Sie Kopfhörer angeschlossen haben, sind die **internen Lautsprecher** (2) ausgeschaltet.

Rechte Seite

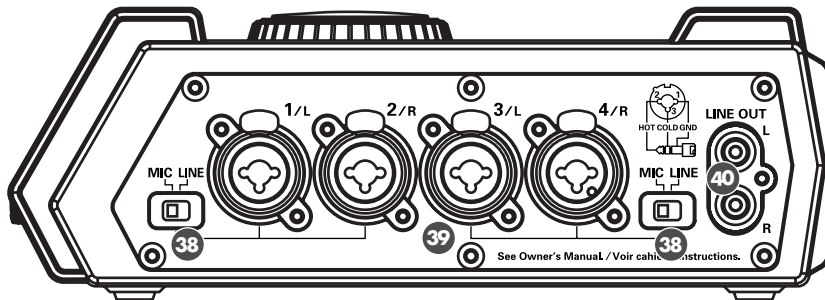
**38 Eingangspegel-Auswahlschalter**

Stellen Sie diese Schalter entweder auf MIC oder LINE, je nachdem welcher Gerätetyp an die Kanäle 1/L und 2/R oder die Kanäle 3/L und 4/R angeschlossen ist.

MIC	Wenn ein Mikrofon angeschlossen ist.
LINE	Wenn ein Audiogerät über eine analoge Verbindung angeschlossen ist.

39 Combo-Eingangsbuchsen 1-4

Dies sind Buchsen mit Mikrofon-Vorverstärkern für analogen Audioeingang. Sie können sowohl XLR als auch 1/4" Stecker verwenden, je nachdem welche Ausrüstung Sie anschließen. Es können Signalquellen mit oder ohne Balanceregulierung angeschlossen werden.

Sie können die Combo-Eingangsbuchsen 1-4 als vier Mono-Eingänge oder als zwei Stereoeingänge 1/2 und 3/4 nutzen. Hinweise hierzu finden Sie unter "1 Recording Setup" (S. 60).

40 Line-Ausgangsbuchsen (LINE OUT)

Diese Buchsen geben dasselbe Signal aus wie der **digitale Ausgang** (29) und die **Kopfhörerbuchse** (37).

Der nominale Ausgangspegel ist fest auf -10 dBV eingestellt, die Lautstärke dieser Ausgangsbuchsen ist nicht veränderbar.

Unterseite

41 Batteriefach

Legen Sie hier bitte Batterien ein, wenn Sie das R-4 netzunabhängig nutzen möchten. Wenn Sie das Netzgerät anschließen, benötigen Sie keine Batterien.

Bitte schalten Sie das R-4 aus, bevor Sie von Netzbetrieb zu Batteriebetrieb oder umgekehrt wechseln.

Detaillierte Informationen finden Sie unter "Installing batteries and turning the power on" (S. 25).

Présentation Française du R-4

Face supérieure

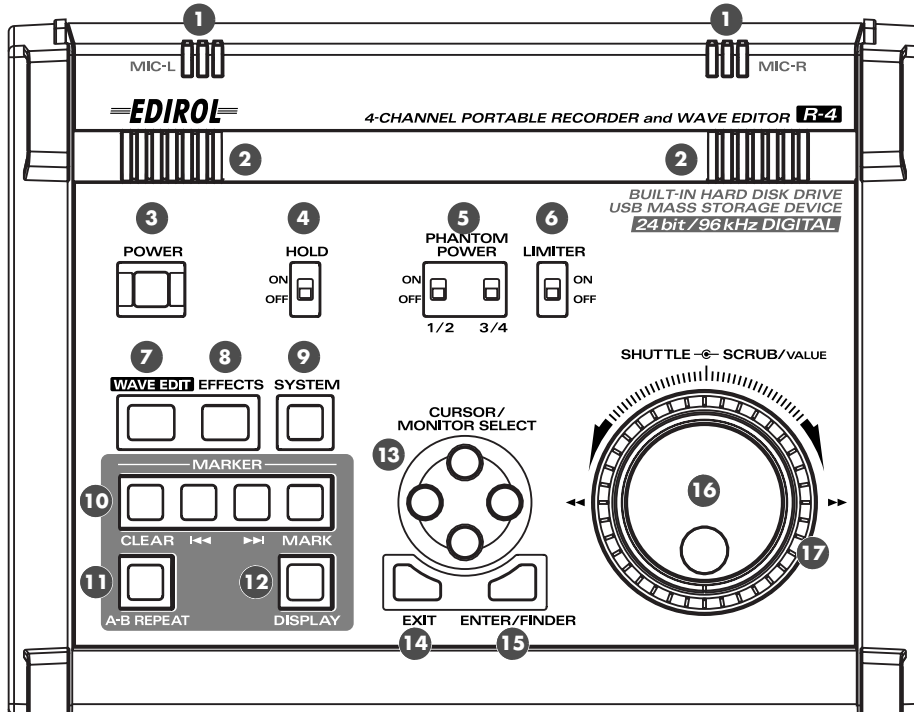

1 Micros internes (MIC-L, MIC-R)

La source audio sur MIC-L est enregistrée sur le canal 1L et la source MIC-R, sur le canal 1R. Pour les enregistrements par micros internes, régler le paramètre **Paramètres d'enregistrement** du menu Paramètres Système sur **Int-Mic**. Pour plus de détails, voir "**Recording from the internal mics**" (p. 30).

* Ne rien connecter à des prises jack d'entrées inutilisées.

2 Haut-parleurs internes

Pour reproduire du son via les haut-parleurs internes, régler le paramètre **Haut-parleur** du menu Paramètres Système sur **ON**. Pour plus de détails, voir "**Playing back**" (p. 34).

* **Aucun son ne sera reproduit par les haut-parleurs internes si un casque d'écoute est connecté sur la Prise pour casque (37). De même, les haut-parleurs internes ne produiront aucun son pendant l'enregistrement ou en mode pause enregistrement.**

3 Interrupteur principal (POWER)

Cet interrupteur met l'appareil sous tension et hors tension. Pour allumer ou éteindre l'appareil, appuyer pendant environ deux secondes sur l'interrupteur. Celui-ci est éclairé en vert lorsque l'appareil est sous tension.

Ne pas mettre l'appareil hors tension pendant l'enregistrement ou la lecture. Interrompre impérativement la lecture et l'enregistrement avant toute mise hors tension.

* **En cas de mise hors tension accidentelle en cours d'enregistrement, les données enregistrées ne sont pas mémorisées sur le disque dur.**

* **La mise hors tension du R-4 pendant une phase d'accès au disque dur (par exemple pendant l'enregistrement ou la lecture) est susceptible d'endommager celui-ci. Veiller également à ne pas mettre l'appareil hors tension pendant le transfert de données entre le disque dur et la carte CompactFlash.**

* **Pour ne pas créer d'instabilité ou d'endommager le disque dur, ne jamais mettre le R-4 hors tension lorsque son écran affiche Connexion en cours ou Traitement en cours !**

4 Commutateur HOLD

Pour éviter toute manœuvre accidentelle, il est possible de désactiver les touches de commande en sélectionnant la position **HOLD ON**.

Toutefois, même lorsque la commande HOLD ON est activée, les commandes **alimentation fantôme**, **limiteur**, **sélecteur d'entrée**, **volume d'entrée** et **volume de sortie** restent opérationnelles.

5 Commutateurs d'alimentation fantôme (PHANTOM POWER)

Ces commutateurs commandent la mise sous/hors tension de l'alimentation fantôme pour les connecteurs type XLR des prises jack d'entrée combo situés sur le panneau de droite. L'alimentation fantôme peut être mise sous/hors tension séparément pour les canaux 1/2 et 3/4, ceux-ci étant dotés de commutateurs séparés.

6 Limiteur (LIMITER)

Il s'agit ici d'un interrupteur marche/arrêt pour limiteur de niveau d'entrée des circuits analogiques. Lorsque le niveau d'entrée est trop élevé, le limiteur le comprime à un niveau approprié pour éviter la distorsion.

Le limiteur agit simultanément sur les canaux 1-4. Toutefois, le niveau d'entrée est détecté séparément pour chaque canal. Il n'est pas possible d'activer ou désactiver le limiteur par canal.

7 Touche WAVE EDIT

Cette touche active le mode Wave Edit qui permet de modifier la courbe d'onde à l'aide d'opérations telles que Trim, Divide, Combine et Merge (compenser, diviser, combiner et fusionner). Pour plus d'informations, voir "Editing" (p. 48).

Il est impossible d'entrer en mode Wave Edit lorsque le disque dur ne contient pas de fichiers susceptibles d'être pris en charge par le R-4. Seuls les fichiers au format WAV sont pris en charge par le R-4.

8 Touche d'effets (EFFECTS)

Pour plus de détails, voir le "Effects setting" (p. 55).

9 Touche système (SYSTEM)

Pour plus de détails, voir le "System settings" (p. 60).

10 Marqueur (MARKER)

Touche Effacer (CLEAR)

Cette touche supprime un marqueur inséré à l'aide de la **touche Marqueur**. Les marqueurs sont effacés successivement, en commençant par celui situé immédiatement devant le curseur.

◀◀ touche

Cette touche déplace le curseur jusqu'au marqueur situé devant la plage en cours (le marqueur précédent).

▶▶ touche

Cette touche déplace le curseur jusqu'au marqueur situé derrière la plage en cours (le marqueur suivant).

Touche Marqueur (MARK)

Cette touche permet d'insérer un marqueur à un endroit précis du fichier projet. Les marqueurs sont numérotés par ordre croissant, en commençant au début du projet.

11 Touche Répétition A-B (A-B REPEAT)

Cette touche permet de reproduire en boucle la plage située entre deux points (A et B) du projet. Il suffit d'insérer un marqueur A et un marqueur B pendant la lecture du projet ; la plage ainsi délimitée sera lue en boucle.

1. En cours de lecture, appuyer une fois sur la **touche A-B REPEAT**

Ce point (marqueur A) correspond au début de la plage de lecture en boucle.

2. Appuyer une nouvelle fois sur la **touche A-B REPEAT** pour définir la fin (marqueur B) de la lecture en boucle.

La zone sélectionnée lors des étapes 1 et 2 se répétera indéfiniment. Une troisième pression sur la touche **A-B Repeat** annule la lecture en boucle.

12 Touche d'affichage (DISPLAY)

Cette touche commute les différents menus de l'écran du R-4.
Pour plus d'informations, voir "Display" (p. 18).

13 Touches Curseur/Sélection du moniteur (CURSOR / MONITOR SELECT)

Ces touches permettent de sélectionner les éléments affichés. Dans le menu principal, une pression sur les touches haut/bas permet de sélectionner le canal à monitorer.
Pour plus d'informations, voir "Display" (p. 18).

14 Touche Retour (EXIT)

Cette touche permet de retourner au menu précédent ou d'annuler une opération.

15 Touche Entrée/Recherche (ENTER/FINDER)

Cette touche permet de confirmer un paramètre ou de finaliser une valeur. Vous pouvez également appuyer sur cette touche pour utiliser la fonction Recherche. Pour en savoir plus sur la fonction Recherche, voir "The Finder screen" (p. 41).

16 Touche Scrub (SCRUB/VALUE)

Cette touche permet de modifier une valeur ou de naviguer parmi les éléments paramétrés. Lorsque l'appareil est arrêté ou que la lecture est sur pause, la touche Scrub permet de déplacer le curseur vers l'avant ou l'arrière.

17 Touche Shuttle (SHUTTLE)

Lorsque le projet est en cours de lecture, tourner la touche vers la droite pour avancer rapidement ou vers la gauche pour reculer rapidement. Lorsque le projet est à l'arrêt, cette touche agit sur le compteur horaire.

Face avant

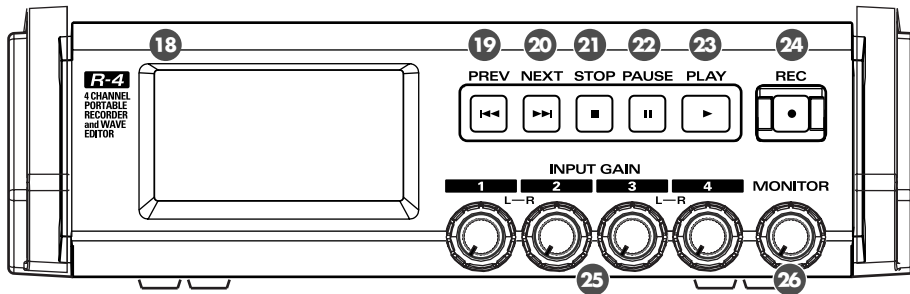
**18** Ecran d'affichage**19** Touche PREV

Pour retourner au début du projet (00:00:00) lorsque celui-ci est en cours de lecture ou à l'arrêt, appuyer sur la touche **PREV**. Une pression sur cette touche au début d'un projet renvoie au projet précédent. Il est également possible de retourner en arrière en gardant cette touche enfoncée. Cette commande est disponible tant pendant la lecture qu'à l'arrêt.

* Lorsque dans le sous-menu **Paramètres du lecteur** du menu **Paramètres Système**, le **Mode Lecture** est paramétré sur **Single**, il n'est pas possible de passer au projet précédent ou suivant.

20 Touche NEXT

Une pression sur le **bouton NEXT** permet d'accéder au projet suivant. Une pression prolongée sur cette touche permet l'avance rapide. Cette commande est disponible tant pendant la lecture qu'à l'arrêt.

21 Touche STOP**22** Touche PAUSE**23** Touche Lecture (PLAY)

Cette touche permet de lancer la lecture. La **touche PLAY** est éclairée en bleu pendant la lecture.

En cours de lecture, une seconde pression sur la **touche PLAY** déclenche la lecture à double vitesse. Pendant la lecture à double vitesse, une nouvelle pression sur la **touche PLAY** permet de revenir au mode de lecture normale. Pendant la lecture à double vitesse, la partie inférieure de l'écran affiche **PLAY X2**. Pendant la lecture à double vitesse, la tonalité est modifiée.

* Pour désactiver la fonction de lecture à double vitesse, ouvrir le menu **Paramétrage Système** et sélectionner **X2 Play OFF** dans le menu **Paramètres de lecture**. Pour plus de détails, voir "**2 Player Setup**" (p. 62).

24 Bouton d'enregistrement (REC)

L'enregistrement débute dès que la **touche REC** est enfoncée. La **touche REC** devient rouge durant l'enregistrement. En appuyant sur la **touche PAUSE** et sur la **touche REC**, la **touche REC** devient rouge et le R-4 passe en mode pause. Pour reprendre l'enregistrement, appuyer sur la **touche REC** ou la **touche PAUSE**.

25 Boutons de niveau d'entrée 1-4 (INPUT GAIN)

Ces boutons permettent de régler le niveau des **jacks d'entrée combo 1-4** (39). Le niveau d'entrée des **micros internes** (1) se règle au moyen du **bouton 1** (MIC-L) et du **bouton 2** (MIC-R).

26 Bouton niveau du moniteur (MONITOR)

Il permet de régler le volume de sortie des **haut-parleurs internes** (2) et de la **prise casque** (37). Il n'est pas possible de régler le volume des **prises de sortie de ligne** (40). Si ce type de réglage s'avère malgré tout nécessaire, régler les haut-parleurs internes ou le système de lecture connectés aux prises de sortie de ligne.

Panneau latéral (gauche)

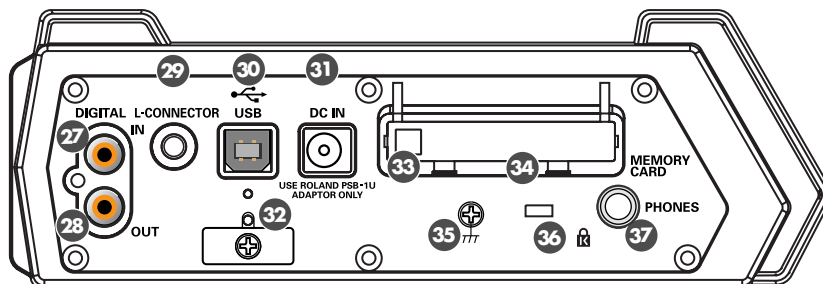

27 Connecteur d'entrée numérique (DIGITAL IN)

Pour enregistrer un signal numérique, brancher un câble de type coaxial sur ce connecteur. Le signal d'entrée numérique est enregistré en stéréo sur les canaux 1L et 1R. Pour enregistrer en mode mono, modifier le paramètre de **Mode Rec** dans le menu Paramètres Système. Pour plus de détails, voir "1 Recording Set-up" (p. 60).

28 Connecteur de sortie numérique (DIGITAL OUT)

Le connecteur produit le même signal audio que les **prises de sortie de ligne** (40) et **prise casque** (37), mais sous forme numérique.

29 Connecteur L (L-CONNECTOR)

Un câble de type mini stéréo peut être utilisé pour brancher cet équipement à un équipement vidéo disposant d'un connecteur LANC. Le R-4 se met à enregistrer en tandem au moment où l'équipement vidéo débute l'enregistrement. De même, le R-4 arrête l'enregistrement en même temps que l'équipement vidéo. Pour plus d'informations, voir "Connecting a video device that has a LANC connector" (p. 74).

30 Connecteur USB

31 Prise adaptateur AC (DC IN)

32 Réducteur de tension

33 Touche EJECT

34 Fente carte mémoire (MEMORY CARD)

Le R-4 n'est compatible qu'avec les cartes mémoire CompactFlash TYPE 1. Les cartes Microdrive ne sont pas prises en charge. Pour plus d'informations sur les cartes CompactFlash, voir "Handling memory cards" (p. 70).

35 Borne de mise à la terre

36 Verrouillage ()

<http://www.kensington.com/>

37 Prise casque (PHONES)

Cette prise permet de connecter un casque audio. Le volume se règle au moyen du **bouton de niveau de monitoring** (26). Lorsqu'un casque est branché, les **haut-parleurs internes** (2) ne produisent aucun son.

Panneau latéral (droit)

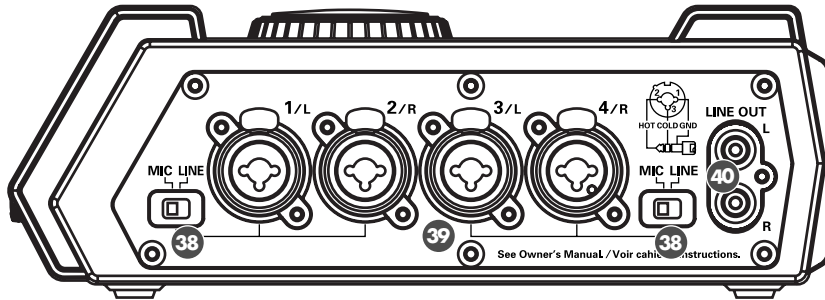

38 Sélecteurs de niveau d'entrée

Régler ces sélecteur sur MIC ou LINE selon le type d'appareil connecté aux canaux 1/L et 2/R ou 3/L et 4/R.

MIC	Si un micro est connecté
LINE	Si un équipement audio est connecté de manière analogique

39 Prises d'entrée combo 1-4

Entrées jacks audio analogiques avec préampli micro, adaptées pour les fiches XLR ou téléphone 1/4" et se branchant sur de nombreux équipements. Possibilité de connexion de signaux symétriques ou asymétriques.

Il est également possible d'utiliser des prises jack d'entrée combo 1-4 comme quatre canaux d'entrée mono ou comme deux paires stéréo, 1/2 et 3/4. Pour plus de détails, voir "1 Recording Setup" (p. 60).

40 Prises de sortie de ligne (LINE OUT)

Ces prises produisent le même signal que le **connecteur de sortie numérique** (29) et la **prise casque** (37).

Le niveau de sortie nominale est fixé à -10 dBV. Le volume de ces prises n'est pas réglable.

Face inférieure

41 Logement des piles

Si le R-4 doit fonctionner sans être branché sur le secteur, insérer les piles dans le compartiment prévu à cet effet. Il n'est pas utile d'installer des piles lorsqu'un adaptateur AC est utilisé.

Veiller à mettre le R-4 hors tension pour passer d'une alimentation par adaptateur AC au mode piles et vice versa.

Pour plus d'informations, voir "Installing batteries and turning the power on" (p. 25).

Presentazione dell'R-4

Pannello frontale

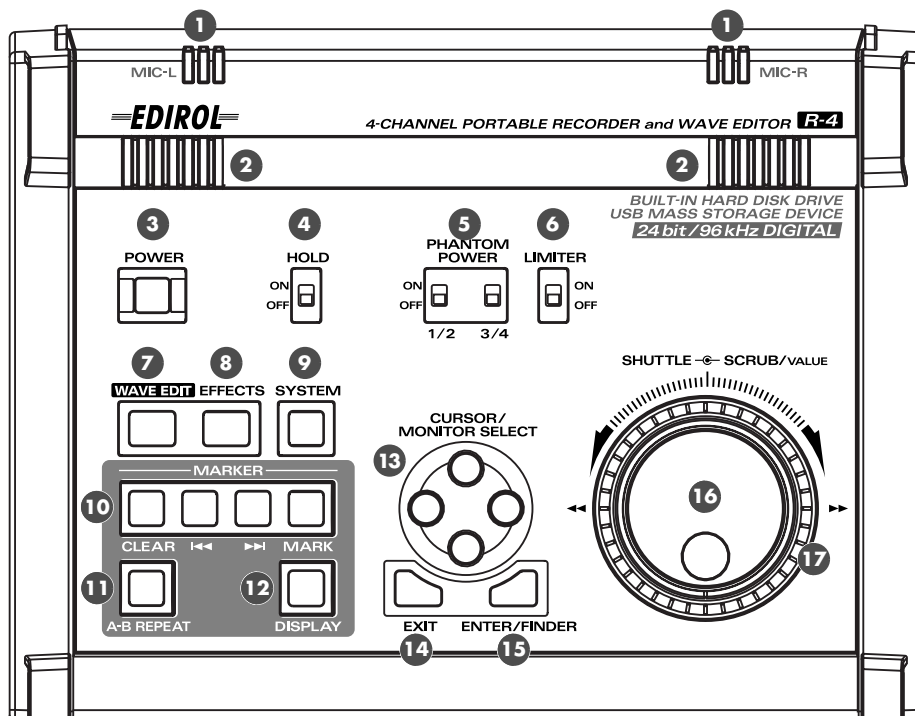

1 Microfoni interni (MIC-L, MIC-R)

I suoni che arrivano al MIC-L sono registrati sul canale 1L, mentre i suoni captati dal MIC-R sono registrati sul canale 1R. Nel caso in cui la registrazione sia eseguita mediante i microfoni interni, impostare la voce **Impostazioni di registrazione** su **Int-Mic** nel menu Impostazioni del sistema. Per maggiori informazioni fare riferimento alla sezione **“Recording from the internal mics”** (p. 30).

* Non effettuare connessioni ai jack di ingresso non utilizzati.

2 Diffusori interni

Se si desidera che il suono venga emesso dai diffusori interni, impostare la voce **Speaker** su **ON** nel menu Impostazioni del sistema. Per maggiori informazioni fare riferimento alla sezione **“Playing back”** (p. 34).

* Nel caso in cui siano collegate delle cuffie al **jack delle cuffie** (37), non verrà emesso alcun suono dai diffusori interni. Non verrà emesso alcun suono dai diffusori interni neanche durante la registrazione o in modo standby di registrazione, al fine di impedire un eventuale ritorno acustico.

3 Interruttore di alimentazione (POWER)

Accende/spigne l'apparecchio. Per accendere o spegnere l'apparecchio, premere e tenere premuto l'interruttore di alimentazione per due secondi circa. L'interruzione di alimentazione si illumina di verde quando l'apparecchio è acceso.

Non spegnere l'apparecchio durante la registrazione o la riproduzione. È necessario assicurarsi che la riproduzione o la registrazione siano terminate prima di spegnere l'apparecchio.

* Se l'apparecchio viene spento accidentalmente durante la registrazione, i dati in registrazione non vengono salvati sul disco fisso.

* Il disco fisso potrebbe risultare danneggiato nel caso in cui l'R-4 sia spento durante la lettura o la scrittura di dati sul disco fisso (come durante la registrazione o la riproduzione). Fare inoltre attenzione a non spegnere l'apparecchio durante il trasferimento dei dati tra il disco fisso e la scheda CompactFlash.

* Non spegnere l'apparecchio quando il display dell'R-4 indica **Now Connecting...** oppure **Now Processing!** Questa operazione potrebbe rendere l'R-4 instabile e anche danneggiare il disco fisso interno.

4 Interruttore Hold (HOLD)

Impostando **HOLD** in posizione ON è possibile disattivare i pulsanti del pannello in modo che non si verifichino operazioni non desiderate nel caso venisse premuto accidentalmente un pulsante. Anche se questo interruttore HOLD è impostato su ON, sarà comunque possibile azionare gli **interruttori phantom power**, l' **interruttore limiter**, l' **interruttore input select**, il **volume di ingresso** e il **volume di uscita**.

5 Interruttori phantom power (PHANTOM POWER)

Questi interruttori accendono e spengono il phantom power per i connettori di tipo XLR della serie jack di ingresso sul pannello destro. Dal momento che vengono forniti interruttori distinti per i canali 1/2 e i canali 3/4, è possibile accendere e spegnere il phantom power separatamente per questi canali.

6 Interruttore limiter (LIMITER)

È un interruttore on/off per il limiter del livello di ingresso nei circuiti analogici. Quando il livello di ingresso è troppo elevato, il limiter comprime in modo opportuno il livello di ingresso in modo da impedire che si verifichino distorsioni. L'interruttore limiter attiva e disattiva la funzione di limiting per tutti i canali 1-4 contemporaneamente. Il livello di ingresso viene comunque rilevato separatamente per ciascun canale. Non è possibile accendere o spegnere il limiter separatamente per ciascun canale.

7 Pulsante wave edit (WAVE EDIT)

Questo pulsante attiva il Wave Edit mode, in cui è possibile modificare la forma d'onda mediante operazioni quali Trim, Divide, Combine e Merge. Per maggiori informazioni fare riferimento alla sezione "Editing" (p. 48).

Non è possibile attivare il Wave Edit mode se il disco fisso dell'R-4 non contiene nessun file compatibile con l'R-4. I file WAV sono l'unico tipo di file compatibili con l'R-4.

8 Pulsante effects (EFFECTS)

Per maggiori informazioni fare riferimento alla sezione "Effects setting" (p. 55).

9 Pulsante system (SYSTEM)

Per maggiori informazioni fare riferimento alla sezione "System settings" (p. 60).

10 Marker (MARKER)

Pulsante clear (CLEAR)

Questo pulsante cancella un marker assegnato mediante il **pulsante mark**. I marker saranno cancellati in successione, iniziando dal marker posto immediatamente prima della posizione attuale.

◀◀ pulsante

Questo pulsante consente di passare al marker immediatamente precedente alla posizione attuale (il marker precedente).

▶▶ pulsante

Questo pulsante consente di passare al marker immediatamente successivo alla posizione attuale (il marker successivo).

Pulsante mark (MARK)

Premendo questo pulsante è possibile assegnare un marker alla posizione desiderata nel file del progetto. I marker sono numerati in sequenza a cominciare dall'inizio del progetto.

11 Pulsante A-B repeat (A-B REPEAT)

Questo pulsante consente di riprodurre ripetutamente una parte tra due punti (A e B) nel progetto. È sufficiente assegnare un marker A e un marker B durante la riproduzione del progetto, e la parte tra i marker A e B sarà ripetuta.

1. Durante la riproduzione, premere una volta il **pulsante A-B repeat**. Questo punto sarà l'inizio (marker A) della riproduzione ripetuta.
2. Premere ancora una volta il **pulsante A-B repeat**. Questo punto sarà la fine (marker B) della riproduzione ripetuta.

La parte specificata nelle fasi 1 e 2 sarà riprodotta ripetutamente. Per annullare la riproduzione ripetuta, premere di nuovo il **pulsante A-B repeat**.

12 Pulsante display (DISPLAY)

Questo pulsante cambia il contenuto di ciò che viene visualizzato sul display dell'R-4. Per maggiori informazioni fare riferimento alla sezione "Display" (p. 18).

13 Pulsanti cursor/monitor select (CURSOR / MONITOR SELECT)

Utilizzare questi pulsanti per selezionare le voci visualizzate sul display. Dalla schermata principale è possibile premere i pulsanti su/giù per selezionare il canale che si desidera controllare. Per maggiori informazioni fare riferimento alla sezione "Display" (p. 18).

14 Pulsante exit (EXIT)

Utilizzare questo pulsante per tornare alla schermata precedente o per annullare un'operazione.

15 Pulsante enter/finder (ENTER/FINDER)

Utilizzare questo pulsante per confermare un'impostazione o un valore. È anche possibile premere questo pulsante per utilizzare la funzione finder. Per maggiori informazioni sulla funzione finder, fare riferimento alla sezione "The Finder screen" (p. 41).

16 Potenzimetro scrub (SCRUB/VALUE)

Utilizzare questo potenziometro per selezionare le voci da impostare o per modificare un valore. In fase inattiva o quando la riproduzione è in pausa, è possibile ruotare il potenziometro scrub per spostare avanti o indietro la posizione attuale.

17 Potenzimetro shuttle (SHUTTLE)

Durante la riproduzione del progetto, ruotare questo potenziometro in senso orario per l'avanzamento rapido oppure in senso antiorario per il riavvolgimento rapido. Quando il progetto è in fase inattiva, questo potenziometro fa avanzare il contatore.

Pannello frontale

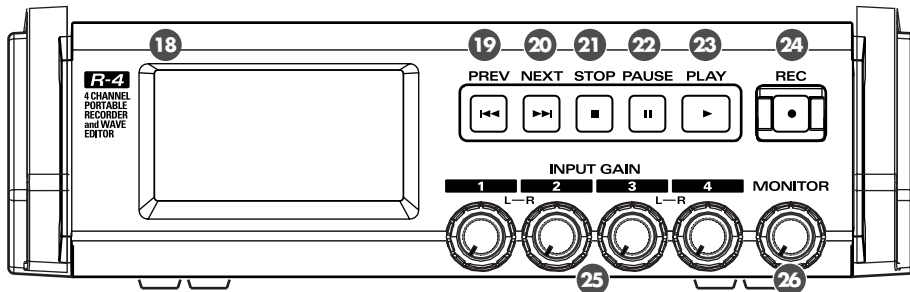

18 Display

19 Pulsante PREV (PREV)

La pressione del **pulsante PREV** quando il progetto è in riproduzione o in fase inattiva consente di passare all'inizio del progetto (00:00:00). La pressione di questo pulsante all'inizio del progetto consente di passare al progetto precedente.

È anche possibile premere questo pulsante e tenerlo premuto per il riavvolgimento rapido. Questa funzione è disponibile sia durante la riproduzione sia in fase inattiva.

* Se la **Modalità di riproduzione** è impostata su **Single** nelle **Impostazioni del riproduttore delle Impostazioni del sistema**, non sarà possibile passare al progetto precedente o successivo.

20 Pulsante NEXT (NEXT)

La pressione del **pulsante NEXT** consente di passare al progetto successivo. È anche possibile premere questo pulsante e tenerlo premuto per l'avanzamento veloce. Questa funzione è disponibile sia durante la riproduzione sia in fase inattiva.

21 Pulsante stop (STOP)

22 Pulsante pause (PAUSE)

23 Pulsante play (PLAY)

Questo pulsante avvia la riproduzione. Il **pulsante PLAY** si illumina di blu durante la riproduzione. Durante la riproduzione è possibile premere di nuovo il **pulsante PLAY** per avviare la riproduzione a doppia velocità. Durante la riproduzione a doppia velocità premere di nuovo il **pulsante PLAY** per tornare alla riproduzione normale. Durante la riproduzione a doppia velocità, nella parte inferiore del display verrà visualizzata la scritta **PLAY X2**. La riproduzione a doppia velocità modificherà il tono.

* Per disattivare la funzione di riproduzione a doppia velocità, passare alle **Impostazioni del riproduttore** nel menu **Impostazioni del sistema** e impostare **X2 PLAY** su OFF. Per maggiori informazioni fare riferimento alla sezione **"2 Player Setup"** (p. 62).

24 Pulsante record (REC)

Quando si preme il **pulsante REC**, verrà avviata immediatamente la registrazione. Il **pulsante REC** si illumina di rosso durante la registrazione. Se si tiene premuto il **pulsante PAUSE** e si preme il **pulsante REC**, il **pulsante REC** si illumina di rosso e l'R-4 entra in modo standby di registrazione. La registrazione verrà avviata alla pressione del **pulsante REC** oppure del **pulsante PAUSE**.

25 Manopole del livello di ingresso 1-4 (INPUT GAIN)

Queste manopole regolano il livello di ingresso della **serie jack di ingresso 1-4** (39). I livelli di ingresso dei **microfoni interni** (1) sono regolati dalla **manopola 1** (MIC-L) e dalla **manopola 2** (MIC-R).

26 Manopola del livello di controllo (MONITOR)

Questa manopola regola il volume di uscita dei **diffusori interni** (2) e del **jack delle cuffie** (37). Non è possibile regolare il volume dei **jack di uscita di linea** (40). Se si desidera regolare il volume dei jack di uscita di linea, regolare i controlli dei diffusori esterni o del sistema di riproduzione collegato ai jack di uscita di linea.

Pannello laterale (sinistro)

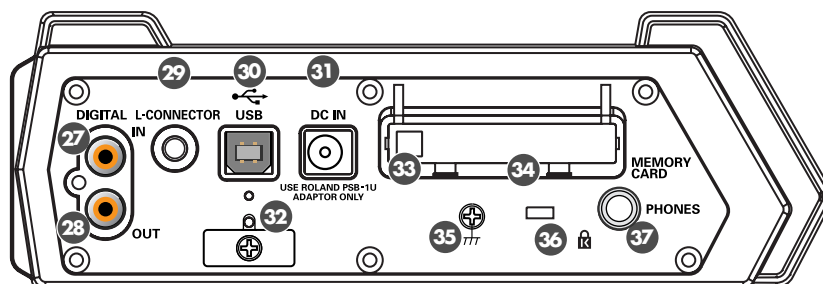

27 Connettore dell'ingresso digitale (DIGITAL IN)

Se si desidera registrare un segnale digitale, collegare un cavo di tipo coassiale a questo connettore. Il segnale di ingresso digitale viene registrato in stereo sui canali 1L e 1R. Se si desidera effettuare una registrazione monofonica, è necessario modificare l'impostazione **Rec Mode** nel menu Impostazioni del sistema. Per maggiori informazioni fare riferimento alla sezione "1 Recording Setup" (p. 60).

28 Connettore di uscita digitale (DIGITAL OUT)

Questo connettore fornisce lo stesso segnale audio dei **jack di uscita di linea** (40) e del **jack delle cuffie** (37), ma in formato digitale.

29 Connettore L (L-CONNECTOR)

È possibile utilizzare un cavo stereo tipo mini per il collegamento ad un dispositivo video dotato di connettore LANC. Quando si avvia la registrazione sul dispositivo video, l'R-4 avvierà la registrazione in serie. Quando si termina la registrazione sul dispositivo video, anche l'R-4 terminerà la registrazione. Per maggiori informazioni fare riferimento alla sezione "Connecting a video device that has a LANC connector" (p. 74).

30 Connettore USB (USB)

31 Jack dell'adattatore AC (DC IN)

32 Fermo del cavo

33 Pulsante Eject

34 Alloggiamento per la scheda di memoria (MEMORY CARD)

L'R-4 supporta solamente schede di memoria CompactFlash TYPE 1. Le schede Microdrive non sono supportate.

Per maggiori informazioni sulla gestione delle schede CompactFlash, fare riferimento alla sezione "Handling memory cards" (p. 70).

35 Terminale di messa a terra

36 Fessura di Sicurezza (Kensington Lock)

<http://www.kensington.com/>

37 Jack delle cuffie (PHONES)

Collegare delle cuffie al questo jack. Utilizzare la **manopola del livello di controllo** (26) per regolare il volume. Se si collegano delle cuffie, non verrà emesso alcun suono dai **diffusori interni** (2).

Pannello laterale (destro)

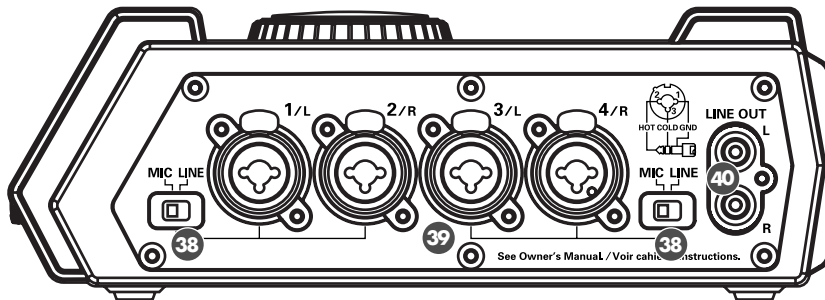

38 Interruttori di selezione del livello di ingresso

Impostare questi interruttori in posizione MIC oppure LINE a seconda del tipo di dispositivo collegato ai canali 1/L e 2/R o ai canali 3/L e 4/R.

MIC	Se è collegato un microfono
LINE	Se è collegato un dispositivo audio mediante una connessione analogica

39 Serie jack di ingresso 1-4

Si tratta di jack di ingresso audio analogici compatibili con mic preamp. È possibile collegarvi jack XLR oppure phone jack da 1/4" a seconda dei dispositivi da collegare. Possono essere collegati segnali bilanciati o sbilanciati.

È possibile utilizzare la serie jack di ingresso 1-4 come quattro canali di ingresso monofonico o come due coppie stereo, 1/2 e 3/4. Per maggiori informazioni fare riferimento alla sezione "1 Recording Setup" (p. 60).

40 Jack di uscita di linea (LINE OUT)

Questi jack trasmettono lo stesso segnale del **connettore di uscita digitale** (29) e del **jack delle cuffie** (37).

Il livello nominale di uscita è fissato a -10 dBV e il volume di questi jack non può essere regolato.

Pannello inferiore

41 Vano batterie

Inserire le batterie in questo vano se si desidera alimentare l'R-4 mediante batterie. Se si utilizza l'adattatore AC, non è necessario inserire le batterie.

Assicurarsi di avere spento l'R-4 prima di passare dall'alimentazione con l'adattatore AC all'alimentazione a batterie o viceversa.

Per maggiori informazioni fare riferimento alla sezione "Installing batteries and turning the power on" (p. 25).

Presentación del R-4

Panel superior

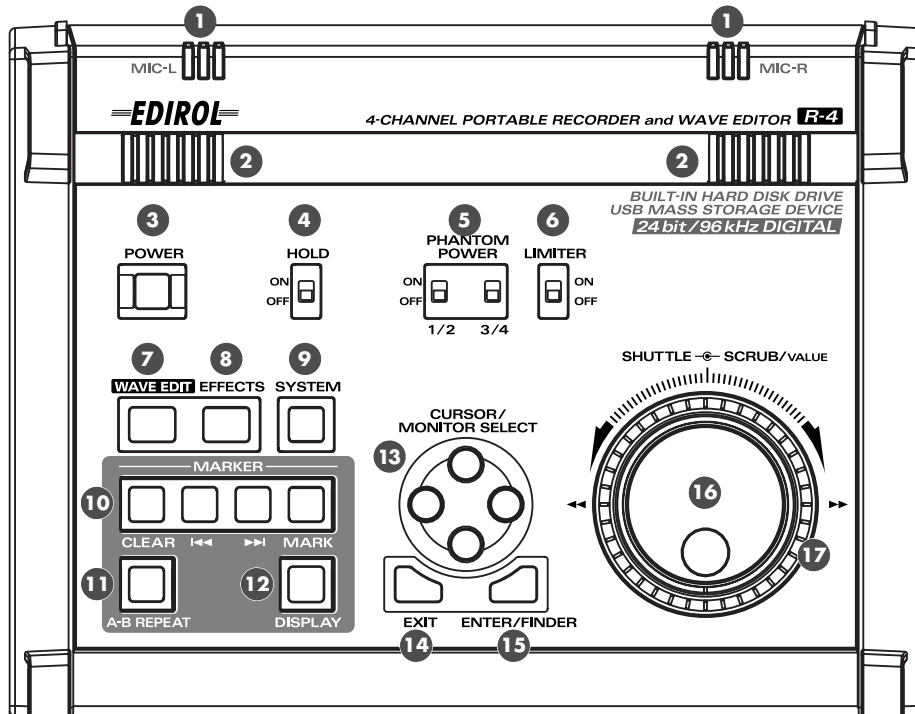

1 Micrófonos internos (MIC-L, MIC-R)

El audio que entra a través de MIC-L se graba en el canal 1L, mientras que el audio que recoge el micrófono MIC-R se graba en el canal 1R. Si está realizando una grabación a través de los micrófonos internos, ajuste la opción **Recording Setup** (configuración de la grabación) del menú **System Settings** (configuración del sistema) en **Int-Mic** (micrófono interno). Para obtener más detalles, consulte **“Recording from the internal mics”** (pág. 30).

* No conecte nada a las clavijas de entrada que no utilice.

2 Altavoces internos

Si desea que el sonido se escuche desde los altavoces internos, establezca la opción **Speaker** (altavoz) del menú **System Settings** (configuración del sistema) en **ON** (activado). Para obtener más detalles, consulte **“Playing back”** (pág. 34).

* No se escuchará sonido de los altavoces internos si ha conectado unos auriculares al **jack de auriculares** (37). Tampoco se escuchará ningún sonido de los altavoces internos mientras se está grabando o se encuentra en modo de grabación interrumpida: de este modo se evita que se produzca retorno acústico.

3 Interruptor de alimentación (POWER)

Este interruptor se utiliza para encender y apagar la unidad. Para encender o apagar la alimentación, mantenga pulsado este interruptor durante dos segundos aproximadamente. El interruptor de alimentación se encenderá en verde cuando la unidad esté encendida.

No apague la alimentación durante una grabación o una reproducción. Antes de apagar la unidad, debe asegurarse de que la reproducción o la grabación se han detenido.

* Si, de forma accidental, apaga la unidad durante la grabación, los datos que se estaban grabando no se guardarán en el disco duro.

* El disco duro puede sufrir daños si apaga la alimentación del R-4 mientras se están leyendo datos del disco duro o bien se están escribiendo datos en él (como durante la grabación o la reproducción). También deberá tener cuidado para no apagar la alimentación mientras se están transfiriendo datos entre el disco duro y la tarjeta CompactFlash.

* No apague nunca la alimentación mientras la pantalla del R-4 indique **Now Connecting...** (conexión en curso...) o **Now Processing** (proceso en curso). De lo contrario, el R-4 podría sufrir problemas de estabilidad e incluso podría dañarse el disco duro interno.

4 Interruptor de bloqueo (HOLD)

Al seleccionar la posición **HOLD ON** (bloqueo activado), puede desactivar los botones del panel para que no se produzcan operaciones no deseadas si se pulsa un botón accidentalmente. Sin embargo, incluso si este interruptor está seleccionado en **HOLD ON** (bloqueo activado), los **interruptores de alimentación fantasma, el interruptor Limiter (limitador), el interruptor de selección de entrada, el volumen de entrada, y el volumen de salida** continúan estando operativos.

5 Interruptores de alimentación fantasma (PHANTOM POWER)

Estos interruptores encienden y apagan la alimentación fantasma en los conectores tipo XLR de los jacks de entrada combinados situados en el panel derecho. Como se incluyen interruptores separados para los canales 1/2 y los canales 3/4, puede activar y desactivar la alimentación fantasma por separado en estos canales.

6 Interruptor del limitador (LIMITER)

Se trata de un interruptor de encendido y apagado de un limitador de nivel de entrada en los circuitos analógicos.

Cuando el nivel de entrada es demasiado alto, el limitador comprime el nivel de entrada cuanto sea necesario para evitar la distorsión.

El interruptor Limiter (limitador) activa y desactiva la limitación para todos los canales, del 1 a 4. Sin embargo, el nivel de entrada se detecta por separado en cada canal. No puede activar y desactivar el limitador por separado en cada canal.

7 Botón de modificación de onda (WAVE EDIT)

Con este botón, accede al modo Wave Edit (modificación de onda), en el que puede modificar la forma de onda mediante operaciones como Trim (adornar), Divide (dividir), Combine (combinar) y Merge (fusionar). Para obtener más detalles, consulte “**Editing**” (pág. 48).

No podrá acceder al modo Wave Edit (modificación de onda) si el disco duro del R-4 no contiene archivos que admita el R-4. Los archivos WAV son el único tipo de archivo que admite el R-4.

8 Botón de efectos (EFFECTS)

Para obtener más detalles, consulte “**Effects setting**” (pág. 55).

9 Botón de sistema (SYSTEM)

Para obtener más detalles, consulte “**System settings**” (pág. 60).

10 Marcador (MARKER)

Botón de borrado (CLEAR)

Este botón borra un marcador que haya asignado mediante el botón **Mark (marcar)**. Los marcadores se borrarán sucesivamente, comenzando con el marcador situado inmediatamente antes de la ubicación actual.

◀◀ botón

Con este botón se desplaza hasta el marcador que se encuentra inmediatamente antes de la ubicación actual (el marcador anterior).

▶▶ botón

Con este botón se desplaza hasta el marcador que se encuentra inmediatamente después de la ubicación actual (el siguiente marcador).

Botón para marcar (MARK)

Al presionar este botón, puede asignar un marcador a la ubicación que desee en el archivo del proyecto. Los marcadores se numeran secuencialmente, comenzando al principio del proyecto.

11 Botón de repetición A-B (A-B REPEAT)

Con este botón puede reproducir repetidamente un fragmento entre dos puntos (A y B) en el proyecto. Simplemente asigne un marcador A y un marcador B mientras se esté reproduciendo el proyecto, y la reproducción se repetirá entre los marcadores A y B.

1. Durante la reproducción, pulse una vez el botón **A-B Repeat** (repetición A-B). Ese punto será el comienzo (marcador A) del fragmento de la reproducción repetida.
2. Pulse de nuevo el botón **A-B Repeat** (repetición A-B). Ese punto constituirá el final (marcador B) del fragmento de la reproducción repetida.

El fragmento que ha especificado en los pasos 1 y 2 se reproducirá repetidamente. Para cancelar la repetición de la reproducción, pulse de nuevo el **botón A-B Repeat** (repetición A-B).

12 Botón de la pantalla (DISPLAY)

Con este botón se cambia el contenido de la pantalla de la unidad R-4.
Para obtener más detalles, consulte “Display” (pág. 18).

13 Botones de selección del cursor y del monitor (CURSOR / MONITOR SELECT)

Utilice estos botones para seleccionar elementos que aparezcan en la pantalla. Cuando se encuentre en la pantalla principal, puede pulsar los botones de arriba/abajo para seleccionar el canal que desea controlar. Para obtener más detalles, consulte “Display” (pág. 18).

14 Botón de salida (EXIT)

Utilice este botón para volver a la pantalla anterior o para cancelar una operación.

15 Botón Intro y de búsqueda (ENTER/FINDER)

Utilice este botón para confirmar un ajuste o aceptar un valor. También puede pulsarlo cuando desee utilizar la función Finder (búsqueda). Para obtener más información sobre la función Finder (búsqueda), consulte “The Finder screen” (pág. 41).

16 Mando de selección (SCRUB/VALUE)

Utilice este mando para realizar selecciones entre los elementos de una configuración o para modificar un valor. Cuando la reproducción se ha detenido o se ha interrumpido, puede girar este mando para avanzar o retroceder desde la ubicación actual.

17 Mando de avance o retroceso rápido (SHUTTLE)

Mientras se está reproduciendo el proyecto, gire este mando hacia la derecha para reproducir rápidamente hacia delante o hacia la izquierda para reproducir rápidamente hacia atrás. Cuando el proyecto se detiene, este mando hace que avance el contador de tiempo.

Panel frontal

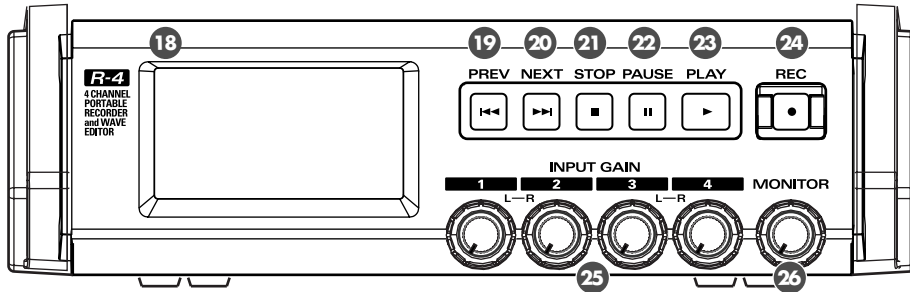
**18 Pantalla****19 Botón de retroceso (PREV)**

Al pulsar el botón **PREV** (retroceso) mientras se está reproduciendo un proyecto o mientras está detenido, se desplazará al comienzo del proyecto (00:00:00). Si se pulsa este botón al comienzo de un proyecto, se desplazará hasta el proyecto anterior.

Para retroceder, pulse y mantenga pulsado este botón. Esta función se encuentra disponible cuando se está reproduciendo y cuando se ha detenido la reproducción.

* Sin en **Player Setup** (configuración del reproductor) en **System Settings** (configuración del sistema), se ha establecido **Play Mode** (modo de reproducción) en **Single** (único), no podrá desplazarse al proyecto anterior ni al siguiente.

20 Botón de avance (NEXT)

Al pulsar el botón **NEXT** (avance), se desplazará al siguiente proyecto. Para avanzar, pulse y mantenga pulsado este botón. Esta función se encuentra disponible cuando se está reproduciendo y cuando se ha detenido la reproducción.

21 Botón de parada (STOP)**22 Botón de pausa (PAUSE)****23 Botón de reproducción (PLAY)**

Este botón inicia la reproducción. El botón **PLAY** (reproducción) se enciende en azul durante la reproducción.

Durante la reproducción, puede pulsar de nuevo el botón **PLAY** (reproducción) para reproducir a doble velocidad. Durante la reproducción a doble velocidad, pulse de nuevo el botón **PLAY** (reproducción) para volver a la reproducción normal. Durante la reproducción a doble velocidad, en la parte inferior de la pantalla aparecerá **PLAY X2** (reproducción a doble velocidad). La reproducción a doble velocidad cambiará el tono.

* Si desea desactivar la función de reproducción a doble velocidad, vaya al menú **System Settings** (configuración del sistema) y en **Player Setup** (configuración del reproductor), desactive **X2 Play** (reproducción a doble velocidad). Para obtener más detalles, consulte "**2 Player Setup**" (pág. 62).

24 Botón de grabación (REC)

La grabación comenzará inmediatamente cuando pulse el botón **REC** (grabar). El botón **REC** (grabar) permanece encendido en rojo durante la grabación. Si mantiene pulsado el botón **PAUSE** (pausa) y pulsa el botón **REC** (grabar), el botón **REC** (grabar) parpadeará en rojo, y el R-4 pasa al modo de grabación interrumpida. La grabación comenzará cuando pulse el botón **REC** (grabar) o el botón **PAUSE** (pausa).

25 Botones de ajuste del nivel de entrada 1-4 (INPUT GAIN)

Con estos botones se ajusta el nivel de entrada de los **jacks de entrada combinados 1-4** (39). Los niveles de entrada de los **micrófonos internos** (1) se ajustan con el **botón 1** (MIC-L) y con el **botón 2** (MIC-R).

26 Botón de ajuste del nivel del monitor (MONITOR)

Este botón ajusta el volumen de salida de los **altavoces internos** (2) y el **jack de auriculares** (37). No puede ajustar el volumen de los **jacks de salida de línea** (40). Si tiene que ajustar el volumen de los jacks de salida de línea, ajuste los controles de los altavoces externos o del sistema de reproducción conectado a los jacks de salida de línea.

Deutsch

Français

Italiano

Español

Panel lateral (izquierda)

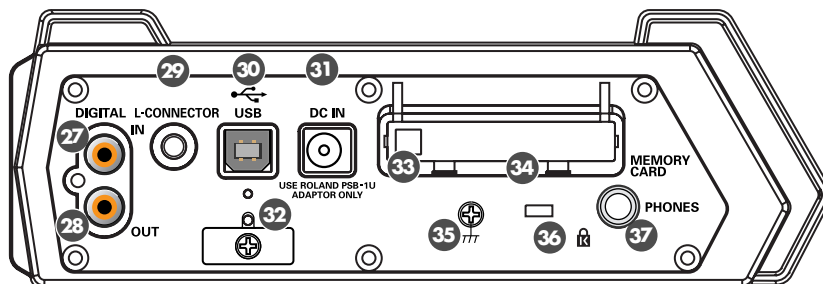

27 Conector de entrada digital (DIGITAL IN)

Si desea grabar una señal digital, conecte un cable de tipo coaxial a este conector. La señal de entrada digital se graba en estéreo en los canales 1L y 1R. Si desea grabar en monoaural, tendrá que cambiar el ajuste de **Rec Mode** (modo de grabación) en el menú System Settings (configuración del sistema). Para obtener más detalles, consulte “1 Recording Setup” (pág. 60).

28 Conector de salida digital (DIGITAL OUT)

Este conector ofrece la misma señal de audio que los **jacks de salida de línea** (40) y el **jack de auriculares** (37), pero en formato digital.

29 Conector L (L-CONNECTOR)

Puede utilizar un cable estéreo mini para conectarlo a un dispositivo de vídeo que esté equipado con un conector LANC. Al comenzar la grabación en el dispositivo de vídeo, el R-4 comenzará a grabar también. Cuando detenga la grabación en el dispositivo de vídeo, el R-4 también detendrá la grabación. Para obtener más detalles, consulte “Connecting a video device that has a LANC connector” (pág. 74).

30 Conector USB (USB)

31 Jack del adaptador de CA (DC IN)

32 Gancho de seguridad del cable

33 Botón de expulsión

34 Ranura de la tarjeta de memoria (MEMORY CARD)

El R-4 sólo puede utilizar tarjetas de memoria CompactFlash de tipo 1. No admite tarjetas Microdrive. Para obtener más detalles sobre la utilización de tarjetas CompactFlash, consulte “Handling memory cards” (pág. 70).

35 Terminal de toma de tierra

36 Ranura de seguridad (K)

<http://www.kensington.com/>

37 Jack de auriculares (PHONES)

En este jack se conectan los auriculares. Utilice el **botón de ajuste del nivel del monitor** (26) para ajustar el volumen. Si conecta los auriculares, el sonido no se escuchará desde los **altavoces internos** (2).

Panel lateral (derecha)

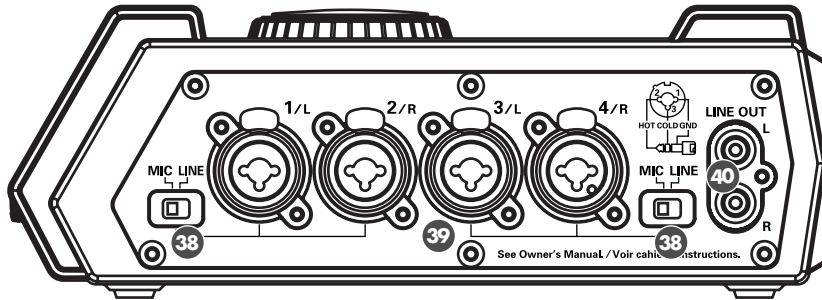

38 Interruptores de selección de entrada

Establezca estos interruptores en la posición MIC o LINE, dependiendo del tipo de dispositivo conectado a los canales 1/L y 2/R o a los canales 3/L y 4/R.

MIC	Si está conectado un micrófono
LINE	Si está conectado un dispositivo de audio a través de una conexión analógica

39 Jacks de entrada combinados 1-4

Se trata de jacks de entrada de audio analógico compatibles con preamplificadores de micrófono. Admiten clavijas XLR o telefónicas de 1/4" y puede utilizar la que resulte de más utilidad para el equipo que esté conectando. Se pueden conectar señales tanto equilibradas como desequilibradas.

Puede utilizar los jacks de entrada combinados 1-4 como cuatro canales de entrada monoaural o como dos pares estéreo, 1/2 y 3/4. Para obtener más detalles, consulte "1 Recording Setup" (pág. 60).

40 Jacks de salida de línea (LINE OUT)

Estos jacks producen la misma señal que el **conector de salida digital** (29) y el **jack de auriculares** (37).

El nivel de salida nominal se fija en -10 dBV, y el volumen de estos jacks no se puede ajustar.

Panel inferior

41 Compartimento de las pilas

Coloque las pilas en este lugar si desea que el R-4 funcione con pilas. Si está utilizando el adaptador de CA, no es necesario instalar las pilas.

Asegúrese de que apaga el R-4 antes de cambiar la alimentación con el adaptador de CA a la alimentación con pilas y viceversa.

Para obtener más detalles, consulte "Installing batteries and turning the power on" (pág. 25).

Deutsch

Français

Italiano

Español

Index

Numerics

3-Band EQ	56
4CH	22

A

A-B REPEAT	11, 40
A-B Repeat button	11
AC adaptor	8, 24
AC adaptor jack	14
Adjusting the input level	28
Alkaline	25, 63
amplified speakers	34
Analog	60, 76
analog device	34

B

BackLight	62
BackLight Timer	62, 76
batteries	25
Battery compartment	17
Battery life	26
Battery Low	79
Battery Time	63
Battery Type	76
Block diagram	86
Bottom panel	17
BWF	22

C

Carrying case	8
CF Utility	64, 68
Channel level meters	18
Channel level sliders	19
Channel names	18
Check	63–64
CLEAR	11
Clear button	11
Clip level indicators	18–19
Combine	52
Combo input jacks	16
Comp&DeEsser	57
CompactFlash	68, 70
computer	72
Contrast	62
Copy	44
Cord hook	14
CURSOR/MONITOR SELECT	12
Cursor/Monitor Select buttons	12

D

Date	62
Date & Time	63, 66
DC IN	14
Delete	42
Digital	60
digital device	31

DIGITAL IN	14
Digital input connector	14
DIGITAL OUT	14
Digital output connector	14
digital recording device	35
DISPLAY	11
Display	13, 18
Display button	11
Divide	50

E

Effect button	11
EFFECTS	11
effects	55, 58
Eject button	14
Enhancer	57
ENTER/FINDER	12
Enter/Finder button	12
EXIT	12
Exit button	12

F

Factory Reset	64, 69
File-Sys Error	79
Format	63–64, 68, 71
Four-channel projects	22
Front panel	13

G

Graphic EQ	56
Grounding terminal	15

H

HDD Slow	79, 81
HDD Utility	63, 68
Headphone jack	15
headphones	34
HOLD	10
HOLD ON	79
Hold switch	10

I

Improper Proj.	79
INPUT GAIN	13
Input level knobs	13, 28, 30, 33, 78
Input level select switch	16, 27, 32, 75–78
Input Select	60, 75–78
Inserting	71
Int-Batt Low	79
Internal mics	9
Internal speakers	9
Int-Mic	60

L

L connector	14
LANC	74
LANC Offline	79
LCD Setup	62
L-CONNECTOR	14
L-Connector	63, 77
Level	18
Level scale	18
LIMITER	10
Limiter	27, 33
Limiter switch	10
LINE OUT	16
Line output jacks	16

M

Macintosh	73
main screen	18, 20
Make Folder	46
MARK	11, 39
Mark button	11
MARKER	11
Marker	11
Marker indicators	18
Media Full	49, 51, 53–54, 79
MEMORY CARD	14
Memory card slot	14
Merge	54
MIC	27
MIC-L	9
MIC-R	9
mixer screen	19
Monaural projects	21
MONITOR	13
Monitor level knob	13
MONOx1	21
MONOx2	21
MONOx3	21
MONOx4	21
Move	45

N

Name	62, 79
Name too long	79
NEXT	13
NEXT button	13
nickel metal-hydride	25
Ni-MH	63
Noise Gate	56
Now Playing	79
Now Recording	79

O

Output assignments	18
Output level meters	19
Over 2GB	79

P

PAUSE	13
Pause button	13
PHANTOM POWER	10
Phantom power switch	10, 27, 30, 32, 75–78
PHONES	15
pjt	22
PLAY	13
Play button	13
Play Mode	36, 62
Player Setup	36, 62
POWER	9, 24
Power source	19
Power switch	9
Pre Recording	61, 75–78
PREV	13
PREV button	13
Progress bar	18
Project exists	79
Project Name	18, 62–63, 67, 75–78

R

REC	13
Rec Bit	60, 75–78
Rec Freq.	60, 75–78
Rec Mode	61, 75–78
Record button	13, 28, 30–31, 33
Recordable time	20
Recording Setup	65
Recording-standby	28
Remaining hard disk capacity	20
Remaining time	19
Removing	71
Rename	43
Repeat	36, 62

S

Sample size	18
Sampling frequency	18
Scrub dial	12
SCRUB/VALUE	12
Security Slot	15
Select	41
Sequential	62
SHUTTLE	12
Shuttle dial	12
Side panel	14, 16
Single	62
Speaker	37, 62
Speaker Switch	62
Stereo	22
Stereo projects	22
STEREOx1	22
STEREOx2	22
STOP	13
Stop button	13
SYSTEM	11
System button	11
System settings	27, 30–32, 60
System Setup	63

T

Time counter	18, 20
Top panel	9
Total recording time	20
Total time	18
Trim	48

U

USB	14
USB cable	8
USB connector	14

W

wav	22
WAVE EDIT	11
Wave edit button	11
Windows	73

X

X2 Play	36, 62
---------------	--------

For the U.K.

IMPORTANT: THE WIRES IN THIS MAINS LEAD ARE COLOURED IN ACCORDANCE WITH THE FOLLOWING CODE.

BLUE: NEUTRAL
BROWN: LIVE



As the colours of the wires in the mains lead of this apparatus may not correspond with the coloured markings identifying the terminals in your plug, proceed as follows:

The wire which is coloured BLUE must be connected to the terminal which is marked with the letter N or coloured BLACK.
The wire which is coloured BROWN must be connected to the terminal which is marked with the letter L or coloured RED.
Under no circumstances must either of the above wires be connected to the earth terminal of a three pin plug.

For the USA

DECLARATION OF CONFORMITY Compliance Information Statement

Model Name : R-4
Type of Equipment : 4-CHANNEL PORTABLE RECORDER and WAVE EDITOR
Responsible Party : Edirol Corporation North America
Address : 425 Sequoia Drive, Suite 114, Bellingham, WA 98226
Telephone : (360) 594-4276

- * Microsoft and Windows are registered trademarks of Microsoft Corporation.
- * Windows® is known officially as: "Microsoft® Windows® operating system."
- * Apple and Macintosh are registered trademarks of Apple Computer, Inc.
- * Mac OS is a trademark of Apple Computer, Inc.
- * All product names mentioned in this document are trademarks or registered trademarks of their respective owners.
- * CompactFlash and  are trademarks of SanDisk Corporation and licensed by CompactFlash association.
- * Roland Corporation is an authorized licensee of the CompactFlash™ and CF logo () trademarks.
- * Fugue © 2005 Kyoto Software Research, Inc. All rights reserved.



Information

When you need repair service, call your nearest EDIROL/Roland Service Center or authorized EDIROL/Roland distributor in your country as shown below.

EDIROL

EUROPE
EDIROL (Europe) Ltd.
 Studio 3.4 114 Power Road
 London W4 5PY
 U. K.
 TEL: +44 (0)20 8747 5949
 FAX: +44 (0)20 8747 5948
 http://www.edirol.com/europe

Deutschland
 TEL: 0700 33 47 65 20

France
 TEL: 0810 000 371

Italia
 TEL: 02 93778329

U. S. A. / CANADA

EDIROL Corporation
North America
 425 Sequoia Drive, Suite 114
 Bellingham, WA 98226
 U. S. A.
 TEL: (360) 594-4273
 FAX: (360) 594-4271
 http://www.edirol.com/

Roland

AFRICA

EGYPT
Al Fanny Trading Office
 9, EBN Hagar Al Askalany
 Street,
 ARD El Golf, Heliopolis,
 Cairo 11341, EGYPT
 TEL: 20-2-417-1828

REUNION
Maison FO - YAM Marcel
 25 Rue Jules Hermann,
 Chaudron - BP79 97 491
 Ste Clotilde Cedex,
 REUNION ISLAND
 TEL: (0262) 218-429

SOUTH AFRICA
Paul Bothner(PTY)Ltd.
 17 Werdmuller Centre,
 Main Road, Claremont 7708
 SOUTH AFRICA
 TEL: (021) 674 4030

ASIA

CHINA
Roland Shanghai Electronics
Co.,Ltd.
 5F, No.1500 Pingliang Road
 Shanghai 200090, CHINA
 TEL: (021) 5580-0800

Roland Shanghai Electronics
Co.,Ltd.
(BEIJING OFFICE)
 10F, No.18 3 Section Anhuaxili
 Chaoyang District Beijing
 100011 CHINA
 TEL: (010) 6426-5050

Roland Shanghai Electronics
Co.,Ltd.
(GUANGZHOU OFFICE)
 2/F, No.30 Si You Nan Er Jie
 Yi Xiang, Wu Yang Xin Cheng,
 Guangzhou 510600, CHINA
 TEL: (020) 8736-0428

HONG KONG
Parsons Music Ltd.
 409, Nirman Kendra
 Mahalaxmi Flats Compound
 Off. Dr. Edwin Moses Road,
 Mumbai-400011, INDIA
 TEL: (022) 2493 9051

INDIA
Rivers Digitec (India) Pvt. Ltd.
 409, Nirman Kendra
 Mahalaxmi Flats Compound
 Off. Dr. Edwin Moses Road,
 Mumbai-400011, INDIA
 TEL: (022) 2493 9051

INDONESIA
PT Citra IntiRama
 Jl. Cideng Timur No. 15f-150
 Jakarta Pusat
 INDONESIA
 TEL: (021) 6324170

KOREA
Cosmos Corporation
 1461-9, Seocho-Dong,
 Seocho Ku, Seoul, KOREA
 TEL: (02) 3486-8855

MALAYSIA/ SINGAPORE
Roland Asia Pacific Sdn. Bhd.
 45-1, Block C2, Jalan PJU 1/39,
 Dataran Prima, 47301 Petaling
 Jaya, Selangor, MALAYSIA
 TEL: (03) 7805-3643

PHILIPPINES
G.A. Yupango & Co. Inc.
 339 Gil J, Puyat Avenue
 Makati, Metro Manila 1200,
 PHILIPPINES
 TEL: (02) 899 9801

TAIWAN
ROLAND TAIWAN
ENTERPRISE CO., LTD.
 Room 5, 9fl. No. 112 Chung
 Shan N.Road Sec.2, Taipei,
 TAIWAN, R.O.C.
 TEL: (02) 2561 3339

THAILAND
Theera Music Co., Ltd.
 330 Verng NakornKasem, Soi
 2, Bangkok 10100, THAILAND
 TEL: (02) 2248821

VIETNAM
Saigon Music
 Suite DP-8
 40 Ba Huyen Thanh Quan
 Street,
 Hochiminh City, VIETNAM
 TEL: (08) 930-1969

AUSTRALIA/ NEW ZEALAND

AUSTRALIA/ NEW ZEALAND
Roland Corporation
Australia Pty.,Ltd.
 38 Campbell Avenue
 Dee Why West, NSW 2099
 AUSTRALIA

For Australia
 TEL: (02) 9982 8266
 For New Zealand
 TEL: (09) 3098 715

CENTRAL/LATIN AMERICA

ARGENTINA
Instrumentos Musicales S.A.
 Av.Santa Fe 2055
 (1123) Buenos Aires
 ARGENTINA
 TEL: (011) 4508-2700

BARBADOS
A&B Music Supplies LTD
 12 Webster Industrial Park
 Wildey, St.Michael, Barbados
 TEL: (246)430-1100

BRAZIL
Roland Brasil Ltda.
 Rua San Jose, 780 Sala B
 Parque Industrial San Jose
 Cotia - Sao Paulo - SP, BRAZIL
 TEL: (011) 4615 5666

CHILE
Comercial Fancy II S.A.
 Rut.: 96.919.420-1
 Nataniel Cox #739, 4th Floor
 Santiago - Centro, CHILE
 TEL: (02) 688-9540

COLOMBIA
Centro Musical Ltda.
 Cra 43 B No 25 A 41 Bododega 9
 Medellin, Colombia
 TEL: (574)3812529

CURACAO
Zeelandia Music Center Inc.
 Orionweg 30
 Curacao, Netherland Antilles
 TEL:(305)5926866

DOMINICAN REPUBLIC
Instrumentos Fernando Galdez
 Calle Proyecto Central No.3
 Ens.La Esperilla
 Santo Domingo,
 Dominican Republic
 TEL:(809) 683 0305

ECUADOR
Mas Musica
 Rumichaca 822 y Zaruma
 Guayaquil - Ecuador
 TEL:(593-4)2302364

GUATEMALA
Casa Instrumental
 Calzada Roosevelt 34-01,zona 11
 Ciudad de Guatemala
 Guatemala
 TEL:(502) 599-2888

HONDURAS
Almacen Pajaro Azul S.A. de C.V.
 BO.Faz Barahona
 3 Ave.11 Calle S.O
 San Pedro Sula, Honduras
 TEL: (504) 553-2029

MARTINIQUE
Musique & Son
 Z.I.Les Mangle
 97232 Le Lamantin
 Martinique F.W.I.
 TEL: 596 596 426860

Gigamusik SARL
 10 Rte De La Folie
 97200 Fort De France
 Martinique F.W.I.
 TEL: 596 596 715222

MEXICO
Casa Veerkamp, s.a. de c.v.
 Av. Toluca No. 323, Col. Olivar
 de los Padres 01780 Mexico
 D.F. MEXICO
 TEL: (55) 5668-6699

NICARAGUA
Bansbach Instrumentos
Musicales Nicaragua
 Altamira D'Este Calle Principal
 de la Farmacia Sta.Avenida
 1 Cuadra al Lago.#503
 Managua, Nicaragua
 TEL: (505)277-2557

PERU
Audionet
 Distribuciones Musicales SAC
 Juan Fanning 530
 Miraflores
 Lima - Peru
 TEL: (511) 4461388

TRINIDAD
AMR Ltd
 Ground Floor
 Maritime Plaza
 Barataria Trinidad W.I
 TEL: (868)638 6385

URUGUAY
Todo Musica S.A.
 Francisco Acuna de Figueroa 1771
 C.P.: 11.800
 Montevideo, URUGUAY
 TEL: (02) 924-2335

VENEZUELA
Instrumentos Musicales
Allegro,C.A.
 Av.las industrias edf.Guitar
 import
 #7 zona Industrial de Turumo
 Caracas, Venezuela
 TEL: (212) 244-1122

EUROPE

AUSTRIA
Roland Elektronische
Musikinstrumente HmbH.
Austrian Office
 Eduard-Bodem-Gasse 8,
 A-6020 Innsbruck, AUSTRIA
 TEL: (0512) 26 44 260

BELGIUM/FRANCE/ HOLLAND/ LUXEMBOURG
Roland Central Europe N.V.
 Houtstraat 3, B-2260, Oevel
 (Westerlo) BELGIUM
 TEL: (014) 575811

CZECH REP.
K-AUDIO
 Kardasovska 626,
 CZ-198 00 Praha 9,
 CZECH REP.
 TEL: (2) 666 10529

DENMARK
Roland Scandinavia A/S
 Nordhavnsvej 7, Postbox 880,
 DK-2100 Copenhagen
 DENMARK
 TEL: 3916 6200

FINLAND
Roland Scandinavia As, Filial
Finland
 Elanontie 5
 FIN-01510 Vantaa, FINLAND
 TEL: (09) 68 24 020

GERMANY
Roland Elektronische
Musikinstrumente HmbH.
 Oststrasse 96, 22844
 Nordstedt, GERMANY
 TEL: (040) 52 60090

GREECE
STOLLAS S.A.
Music Sound Light
 155, New National Road
 Patras 26442, GREECE
 TEL: 2610 435400

HUNGARY
Roland East Europe Ltd.
 Warehouse Area "DEPO" Pf.83
 H-2046 Torokbalint,
 HUNGARY
 TEL: (23) 511011

IRELAND
Roland Ireland
 G2 Calmout Park, Calmout
 Avenue, Dublin 12
 Republic of IRELAND
 TEL: (01) 4294444

ITALY
Roland Italy S. p. a.
 Viale delle Industrie 8,
 20020 Arese, Milano, ITALY
 TEL: (02) 937-78300

NORWAY
Roland Scandinavia Avd.
Kontor Norge
 Lilleakerveien 2 Postboks 95
 Lilleaker N-0216 Oslo
 NORWAY
 TEL: 2273 0074

POLAND
MX MUSIC SP.Z.O.O.
 UL. Gibraltarska 4,
 PL-03664 Warszawa POLAND
 TEL: (022) 679 44 19

PORTUGAL
Roland Iberia, S.L.
Portugal Office
 Cais das Pedras, 8/9-1 Dto
 4050-465, Porto, PORTUGAL
 TEL: 22 608 00 60

ROMANIA
FBS LINES
 Piata Libertatii 1,
 535500 Gheorgheni,
 ROMANIA
 TEL: (266) 364 609

RUSSIA
MuTeK
 3-Bogatyrskaya Str. 1.k.1
 107 564 Moscow, RUSSIA
 TEL: (095) 169 5043

SPAIN
Roland Iberia, S.L.
 Paseo Garcia Faria, 33-35
 08005 Barcelona SPAIN
 TEL: 93 493 91 00

SWEDEN
Roland Scandinavia A/S
SWEDISH SALES OFFICE
 Danvik Center 28, 2 tr.
 S-131 30 Nacka SWEDEN
 TEL: (08) 702 00 20

SWITZERLAND
Roland (Switzerland) AG
 Landstrasse 5, Postfach,
 CH-4452 Ittingen,
 SWITZERLAND
 TEL: (061) 927-8383

UKRAINE
TIC-TAC
 Mira Str. 19/108
 P.O. Box 180
 295400 Mukachevo,
 UKRAINE
 TEL: (03131) 414-40

UNITED KINGDOM
Roland (U.K.) Ltd.
 Atlantic Close, Swansea
 Enterprise Park, SWANSEA
 SA7 9JF,
 UNITED KINGDOM
 TEL: (01792) 702701

MIDDLE EAST

BAHRAIN
Moon Stores
 No.16, Bab Al Bahrain Avenue,
 P.O.Box 247, Manama 304,
 State of BAHRAIN
 TEL: 17 211 005

CYPRUS
Radex Sound Equipment Ltd.
 17, Diagorou Street, Nicosia,
 CYPRUS
 TEL: (022) 66-9426

IRAN
MOCO INC.
 No.41 Nike St., Dr.Shariyati Ave.,
 Roberoye Cerabe Mirdamad
 Tehran, IRAN
 TEL: (021) 285-4169

ISRAEL
Haliit P. Greenspoon & Sons Ltd.
 8 Retzif Ha'aliya Hashnya St.
 Tel-Aviv-Yafo ISRAEL
 TEL: (06) 6823666

JORDAN
AMMAN Trading Agency
 245 Prince Mohammad St.,
 Amman 1118, JORDAN
 TEL: (06) 464-1200

KUWAIT
EASA HUSAIN AL-YOUSIFI
& SONS CO.
 Abdullah Salem Street,
 Safat, KUWAIT
 TEL: 243-6399

LEBANON
Chahine S.A.L
 Gerge Zeidan St., Chahine
 Bldg., Achrafieh, P.O.Box: 16-
 5857
 Beirut, LEBANON
 TEL: (01) 20-1441

OMAN
TALENTZ CENTRE L.L.C.
 P.O. BOX 37, MUSCAT,
 POSTAL CODE 113
 TEL: 931-3705

QATAR
Batie Studio & Stores
 P.O. Box 62,
 Doha, QATAR
 TEL: 423554

SAUDI ARABIA
aDawlah Universal
Electronics APL
 Corniche Road, Aldorsay
 Bldg., 1st Floor, Alkhobar,
 SAUDI ARABIA

P.O.Box 2154, Alkhobar 31952
 SAUDI ARABIA
 TEL: (03) 898 2081

SYRIA
Technical Light & Sound
Center
 Rawda, Abdul Qader Jazairi St.
 Bldg. No. 21, P.O.BOX 13520,
 Damascus, SYRIA
 TEL: (011) 223-5384

TURKEY
Ant Muzik aletleri ithalat ve
ihracat Ltd Sti
 Siraselviler Caddesi
 Siraselviler Pasaji No:74/20
 Taksim - Istanbul, TURKEY
 TEL: (0212) 249624

U.A.E.
Zak Electronics & Musical
Instruments Co. L.L.C.
 Zabeel Road, Al Sherooq Bldg.,
 No. 14, Grand Floor, Dubai,
 U.A.E.
 TEL: (04) 3360715

As of January 15, 2005 (EDIROL-1)

Free Manuals Download Website

<http://myh66.com>

<http://usermanuals.us>

<http://www.somanuals.com>

<http://www.4manuals.cc>

<http://www.manual-lib.com>

<http://www.404manual.com>

<http://www.luxmanual.com>

<http://aubethermostatmanual.com>

Golf course search by state

<http://golfingnear.com>

Email search by domain

<http://emailbydomain.com>

Auto manuals search

<http://auto.somanuals.com>

TV manuals search

<http://tv.somanuals.com>