



**4-CHANNEL
PORTABLE RECORDER
and WAVE EDITOR**

R-4 Pro

Owner's Manual

Apparatus containing Lithium batteries

ADVARSEL!

Lithiumbatteri - Eksplosionsfare ved fejlagtig håndtering.
Udskiftning må kun ske med batteri af samme fabrikat og type.
Levér det brugte batteri tilbage til leverandøren.

ADVARSEL

Eksplosjonsfare ved feilaktig skifte av batteri.
Benytt samme batteritype eller en tilsvarende type anbefalt av apparatfabrikanten.
Brukte batterier kasseres i henhold til fabrikantens instruksjoner.

CAUTION

Danger of explosion if battery is incorrectly replaced.
Replace only with the same or equivalent type recommended by the manufacturer.
Discard used batteries according to the manufacturer's instructions.

VARNING

Explosionsfara ved felaktigt batteribyte.
Använd samma batterityp eller en ekvivalent typ som rekommenderas av apparattillverkaren.
Kassera använt batteri enligt fabrikantens instruktion.

VAROITUS

Paristo voi räjähtää, jos se on virheellisesti asennettu.
Vaihda paristo ainoastaan laitevalmistajan suosittelemaan tyyppiin. Hävitä käytetty paristo valmistajan ohjeiden mukaisesti.



This product complies with the requirements of European Directive 89/336/EEC.

FEDERAL COMMUNICATIONS COMMISSION RADIO FREQUENCY INTERFERENCE STATEMENT

This equipment has been tested and found to comply with the limits for a Class B digital device, pursuant to Part 15 of the FCC Rules. These limits are designed to provide reasonable protection against harmful interference in a residential installation. This equipment generates, uses, and can radiate radio frequency energy and, if not installed and used in accordance with the instructions, may cause harmful interference to radio communications. However, there is no guarantee that interference will not occur in a particular installation. If this equipment does cause harmful interference to radio or television reception, which can be determined by turning the equipment off and on, the user is encouraged to try to correct the interference by one or more of the following measures:

- Reorient or relocate the receiving antenna.
- Increase the separation between the equipment and receiver.
- Connect the equipment into an outlet on a circuit different from that to which the receiver is connected.
- Consult the dealer or an experienced radio/TV technician for help.

This device complies with Part 15 of the FCC Rules. Operation is subject to the following two conditions:

- (1) This device may not cause harmful interference, and
- (2) This device must accept any interference received, including interference that may cause undesired operation.

Unauthorized changes or modification to this system can void the users authority to operate this equipment.
This equipment requires shielded interface cables in order to meet FCC class B Limit.

NOTICE

This Class B digital apparatus meets all requirements of the Canadian Interference-Causing Equipment Regulations.



AVIS

Cet appareil numérique de la classe B respecte toutes les exigences du Règlement sur le matériel brouilleur du Canada.







USING THE UNIT SAFELY

INSTRUCTIONS FOR THE PREVENTION OF FIRE, ELECTRIC SHOCK, OR INJURY TO PERSONS

About  WARNING and  CAUTION Notices







 WARNING	Used for instructions intended to alert the user to the risk of death or severe injury should the unit be used improperly.
 CAUTION	Used for instructions intended to alert the user to the risk of injury or material damage should the unit be used improperly. * Material damage refers to damage or other adverse effects caused with respect to the home and all its furnishings, as well to domestic animals or pets.

About the Symbols







	The  symbol alerts the user to important instructions or warnings. The specific meaning of the symbol is determined by the design contained within the triangle. In the case of the symbol at left, it is used for general cautions, warnings, or alerts to danger.
	The  symbol alerts the user to items that must never be carried out (are forbidden). The specific thing that must not be done is indicated by the design contained within the circle. In the case of the symbol at left, it means that the unit must never be disassembled.
	The  symbol alerts the user to things that must be carried out. The specific thing that must be done is indicated by the design contained within the circle. In the case of the symbol at left, it means that the

ALWAYS OBSERVE THE FOLLOWING







WARNING

- Before using this unit, make sure to read the instructions below, and the Owner's Manual. 
- Do not open (or modify in any way) the unit or its AC adaptor. 
- Do not attempt to repair the unit, or replace parts within it (except when this manual provides specific instructions directing you to do so). Refer all servicing to your retailer, the nearest Roland Service Center, or an authorized Roland distributor, as listed on the "Information" page. 
- Never use or store the unit in places that are:
 - Subject to temperature extremes (e.g., direct sunlight in an enclosed vehicle, near a heating duct, on top of heat-generating equipment); or are 
 - Damp (e.g., baths, washrooms, on wet floors); or are 
 - Humid; or are
 - Exposed to rain; or are
 - Dusty; or are
 - Subject to high levels of vibration.
- Make sure you always have the unit placed so it is level and sure to remain stable. Never place it on stands that could wobble, or on inclined surfaces. 
- Be sure to use only the AC adaptor supplied with the unit. Also, make sure the line voltage at the installation matches the input voltage specified on the AC adaptor's body. Other AC adaptors may use a different polarity, or be designed for a different voltage, so their use could result in damage, malfunction, or electric shock. 







WARNING

- Use only the attached power-supply cord. Also, the supplied power cord must not be used with any other device. 
- Do not excessively twist or bend the power cord, nor place heavy objects on it. Doing so can damage the cord, producing severed elements and short circuits. Damaged cords are fire and shock hazards! 
- This unit, either alone or in combination with an amplifier and headphones or speakers, may be capable of producing sound levels that could cause permanent hearing loss. Do not operate for a long period of time at a high volume level, or at a level that is uncomfortable. If you experience any hearing loss or ringing in the ears, you should immediately stop using the unit, and consult an audiologist. 
- Do not allow any objects (e.g., flammable material, coins, pins); or liquids of any kind (water, soft drinks, etc.) to penetrate the unit. 

- Immediately turn the power off, remove the AC adaptor from the outlet, and request servicing by your retailer, the nearest Roland Service Center, or an authorized Roland distributor, as listed on the "Information" page when: 
 - The AC adaptor, the power-supply cord, or the plug has been damaged; or
 - If smoke or unusual odor occurs
 - Objects have fallen into, or liquid has been spilled onto the unit; or
 - The unit has been exposed to rain (or otherwise has become wet); or
 - The unit does not appear to operate normally or exhibits a marked change in performance.











WARNING

- In households with small children, an adult should provide supervision until the child is capable of following all the rules essential for the safe operation of the unit. 
- Protect the unit from strong impact. (Do not drop it!) 
- Do not force the unit's power-supply cord to share an outlet with an unreasonable number of other devices. Be especially careful when using extension cords—the total power used by all devices you have connected to the extension cord's outlet must never exceed the power rating (watts/amperes) for the extension cord. Excessive loads can cause the insulation on the cord to heat up and eventually melt through. 
- Before using the unit in a foreign country, consult with your retailer, the nearest Roland Service Center, or an authorized Roland distributor, as listed on the "Information" page. 
- Batteries must never be recharge, heated, taken apart, or thrown into fire or water. 

CAUTION

- The unit and the AC adaptor should be located so their location or position does not interfere with their proper ventilation. 
- Always grasp only the plug on the AC adaptor cord when plugging into, or unplugging from, an outlet or this unit. 
- At regular intervals, you should unplug the AC adaptor and clean it by using a dry cloth to wipe all dust and other accumulations away from its prongs. Also, disconnect the power plug from the power outlet whenever the unit is to remain unused for an extended period of time. Any accumulation of dust between the power plug and the power outlet can result in poor insulation and lead to fire. 
- Try to prevent cords and cables from becoming entangled. Also, all cords and cables should be placed so they are out of the reach of children. 
- Never climb on top of, nor place heavy objects on the unit. 
- Never handle the AC adaptor or its plugs with wet hands when plugging into, or unplugging from, an outlet or this unit. 

CAUTION

- Disconnect all cords coming from external devices before moving the unit. 
- Before cleaning the unit, turn off the power and unplug the AC adaptor from the outlet (p.25). 
- Whenever you suspect the possibility of lightning in your area, disconnect the AC adaptor from the outlet. 
- If used improperly, batteries may explode or leak and cause damage or injury. In the interest of safety, please read and observe the following precautions (p.26). 

 - Carefully follow the installation instructions for batteries, and make sure you observe the correct polarity.
 - Avoid using new batteries together with used ones. In addition, avoid mixing different types of batteries.
 - Remove the batteries whenever the unit is to remain unused for an extended period of time.
 - If a battery has leaked, use a soft piece of cloth or paper towel to wipe all remnants of the discharge from the battery compartment. Then install new batteries. To avoid inflammation of the skin, make sure that none of the battery discharge gets onto your hands or skin. Exercise the utmost caution so that none of the discharge gets near your eyes. Immediately rinse the affected area with running water if any of the discharge has entered the eyes.
 - Never keep batteries together with metallic objects such as ballpoint pens, necklaces, hairpins, etc.
- Used batteries must be disposed of in compliance with whatever regulations for their safe disposal that may be observed in the region in which you live. 
- Should you remove Grounding terminal screw, keep them in a safe place out of children's reach, so there is no chance of them being swallowed accidentally. 
- The batteries may become hot, so take care to avoid burns. 
- Always turn the phantom power off when connecting any device other than condenser microphones that require phantom power. You risk causing damage if you mistakenly supply phantom power to dynamic microphones, audio playback devices, or other devices that don't require such power. Be sure to check the specifications of any microphone you intend to use by referring to the manual that came with it. This instrument's phantom power: 48 V DC, 8 mA Max (total of all channels must be 25 mA or less) 

Important Notes

In addition to the items listed under “USING THE UNIT SAFELY” on page 3 and 4, please read and observe the following:

Power Supply: Use of Batteries

- Do not connect this unit to same electrical outlet that is being used by an electrical appliance that is controlled by an inverter (such as a refrigerator, washing machine, microwave oven, or air conditioner), or that contains a motor. Depending on the way in which the electrical appliance is used, power supply noise may cause this unit to malfunction or may produce audible noise. If it is not practical to use a separate electrical outlet, connect a power supply noise filter between this unit and the electrical outlet.
- The AC adaptor will begin to generate heat after long hours of consecutive use. This is normal, and is not a cause for concern.
- The use of an AC adaptor is recommended as the unit’s power consumption is relatively high. Should you prefer to use batteries, please use the alkaline type.
- When installing or replacing batteries, always turn off the power on this unit and disconnect any other devices you may have connected. This way, you can prevent malfunction and/or damage to speakers or other devices.
- Before connecting this unit to other devices, turn off the power to all units. This will help prevent malfunctions and/or damage to speakers or other devices.

Placement

- Using the unit near power amplifiers (or other equipment containing large power transformers) may induce hum. To alleviate the problem, change the orientation of this unit; or move it farther away from the source of interference.
- This device may interfere with radio and television reception. Do not use this device in the vicinity of such receivers.
- Noise may be produced if wireless communications devices, such as cell phones, are operated in the vicinity of this unit. Such noise could occur when receiving or initiating a call, or while conversing. Should you experience such problems, you should relocate such wireless devices so they are at a greater distance from this unit, or switch them off.
- Do not expose the unit to direct sunlight, place it near devices that radiate heat, leave it inside an enclosed vehicle, or otherwise subject it to temperature extremes. Excessive heat can deform or discolor the unit.

- When moved from one location to another where the temperature and/or humidity is very different, water droplets (condensation) may form inside the unit. Damage or malfunction may result if you attempt to use the unit in this condition. Therefore, before using the unit, you must allow it to stand for several hours, until the condensation has completely evaporated.
- Depending on the material and temperature of the surface on which you place the unit, its rubber feet may discolor or mar the surface.
You can place a piece of felt or cloth under the rubber feet to prevent this from happening. If you do so, please make sure that the unit will not slip or move accidentally.

Maintenance

- For everyday cleaning wipe the unit with a soft, dry cloth or one that has been slightly dampened with water. To remove stubborn dirt, use a cloth impregnated with a mild, non-abrasive detergent. Afterwards, be sure to wipe the unit thoroughly with a soft, dry cloth.
- Never use benzine, thinners, alcohol or solvents of any kind, to avoid the possibility of discoloration and/or deformation.

Additional Precautions

- Use a reasonable amount of care when using the unit’s buttons, sliders, or other controls; and when using its jacks and connectors. Rough handling can lead to malfunctions.
- Never strike or apply strong pressure to the display.
- When connecting / disconnecting all cables, grasp the connector itself—never pull on the cable. This way you will avoid causing shorts, or damage to the cable’s internal elements.
- To avoid disturbing your neighbors, try to keep the unit’s volume at reasonable levels. You may prefer to use headphones, so you do not need to be concerned about those around you (especially when it is late at night).
- When you need to transport the unit, package it in the box (including padding) that it came in, if possible. Otherwise, you will need to use equivalent packaging materials.
- Some connection cables contain resistors. Do not use cables that incorporate resistors for connecting to this unit. The use of such cables can cause the sound level to be extremely low, or impossible to hear. For information on cable specifications, contact the manufacturer of the cable.

Handling Hard Disks

Important Performance and Image Data

- Once a hard disk fails to function normally, all data that has been stored on it could be destroyed.
All hard disks eventually wear out. We recommend that you consider the hard disk not as a permanent storage site, but as a place to store data temporarily. We also recommend that you back up important performance and image data that cannot be recorded again onto the external media that is supported by your device. For instructions on how to make such backups, refer to the owner's manual for your device.
Note that Roland assumes no liability whatsoever, including monetary compensation, for the loss of any recorded content in the event of the malfunction of, or physical damage to the hard disk, or for any direct or incidental damages resulting from the loss of such data.

Precautions Regarding Setup and Use

- Certain hard disk setup procedures and usage conditions may result in the corruption of recorded data, malfunctioning, or physical damage to the disk, so be sure to observe the following precautions.
 - Do not subject the hard disk to vibration or shock, especially while the unit is in operation.
 - Do not place in locations that experience vibrations, unstable locations, locations that are not level, or places with extremely large sound pressure (110 dB or more, see below).
If recording is impossible due to vibration or sound pressure, a message is displayed in advance. (P. 21)
 - Do not set up the unit in any location where it may be affected by vibration from external sources, or on any surface that is not stable and level.
 - If the device includes a cooling fan, ensure that the fan and the side panel air vents remain unobstructed.
 - Do not leave the unit in any environment subject to temperature extremes; for example, in a closed automobile in summer or outdoors during winter.
 - Do not use the unit in conditions of high temperature and humidity or in any location subject to rapid temperature changes.
 - Do not unplug the power cord or switch off any circuit breakers in the circuit to which the unit is connected while the power is turned on.
 - Do not move the unit while the power is turned on or immediately after turning off the power. When transporting the unit, first turn off the power and confirm that the display screen has gone off, disconnect the power plug, then wait at least two minutes before moving the device.
- * Examples of places with extremely large sound pressure are under railroad bridges, within 2 meters of an automobile horn, or near a PA speaker.

Emergency Procedures

- * The following procedures are to be used as emergency measures only, and are not recommended for normal operation.
- If the device fails to respond to operational commands or does not complete operations, turn off the power. If the power does not shut off following normal shutdown procedures, disconnect the power plug.
If the unit does not operate normally when the power is turned on again, it may mean that the hard disk has been damaged. In such instances, consult your dealer or the nearest Roland Service Center. Note, however, that it may not be possible to recover any data from the hard disk once it has been lost.
If your device features drive check capabilities, use the drive check function to regularly confirm that there are no problems, even when the device is operating normally. For more detailed information on the shutdown and drive check procedures, refer to the Owner's Manual.

Copyright

- Recording, duplication, distribution, sale, lease, performance, or broadcast of copyrighted material (musical works, visual works, broadcasts, live performances, etc.) belonging to a third party in part or in whole without the permission of the copyright owner is forbidden by law.
- This product can be used to record or duplicate audio or visual material without being limited by certain technological copy-protection measures. This is due to the fact that this product is intended to be used for the purpose of producing original music or video material, and is therefore designed so that material that does not infringe copyrights belonging to others (for example, your own original works) can be recorded or duplicated freely.
- Do not use this unit for purposes that could infringe on a copyright held by a third party. We assume no responsibility whatsoever with regard to any infringements of third-party copyrights arising through your use of this unit.

Contents

Checking the included items	8
Introducing the R-4 Pro	9
The R-4 Pro's controls and connectors	9
Display	18
What is a project?	22
Getting ready to use the R-4 Pro	24
Basic connection examples	24
Connecting the AC adapter and turning the power on/off	25
Installing batteries and turning on the power	26
Recording	30
Recording from a connected mic	30
Recording from the internal mics	33
Recording digital audio from a digital device	34
Simultaneously recording sound from connected mics and a digital device	35
Simultaneously recording sound from connected external mics and the internal mics	36
Playing back	37
Connections before playback	37
Setup before playback	39
Playing back	41
Finder functions	44
Selecting a project (Select)	44
Deleting a project (Delete)	45
Renaming a project (Rename)	46
Copying a project (Copy)	47
Moving a project (Move)	48
Creating a new folder (Make Folder)	49
Editing	51
Editing procedure	51
Effects settings	59
Applying effects	60
Effects	62
System setup	64
Example operations	65
System Menu	72
Appendix	79
Handling external memory device	79
Connecting to a computer	82
Connecting to a video device with a timecode port	84
Application guide	89
Connecting an external mic for CD-quality stereo recording	89
Recording birdsongs outdoors	90
Recording audio while filming video	91
Recording audio memos using just the R-4 Pro	91
Simultaneously recording environmental sounds (ambience)	92
Simultaneously recording at different input levels	92
Recording comments simultaneously	93
Messages	94
Troubleshooting	95
Computer-related problems	95
Recording-related problems	95
Playback-related problems	97
Problems with the R-4 Pro operation	98
Main specifications	99
Recorder	99
Audio Input and Output	99
Other Input/Output Part	100
Effect Unit Part	100
Control	100
Others	100
Block diagram	101
Index	102

Before using this unit, carefully read the sections entitled: "USING THE UNIT SAFELY" and "IMPORTANT NOTES" (p.3–p.7). These sections provide important information concerning the proper operation of the unit. Additionally, in order to feel assured that you have gained a good grasp of every feature provided by your new unit, Owner's Manual should be read in its entirety. The manual should be saved and kept on hand as a convenient reference.

Copyright © 2006 ROLAND CORPORATION

All rights reserved. No part of this publication may be reproduced in any form without the written permission of ROLAND CORPORATION.

Checking the included items

The R-4 pro comes with the following items. Immediately after opening the package, please check that you have all of these items. If any items are missing, please contact the dealer where you purchased the R-4.

■ R-4 Pro

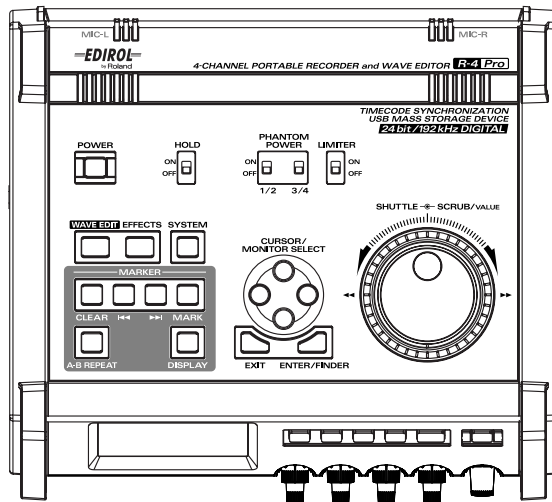

■ AC adapter

This AC adapter is designed specifically for the R-4 Pro. Do not attempt to use any other adapter with the R-4.

■ Power Conversion Cable

This is the R-4 Pro dedicated XLR connector (4-pin) and AC adapter conversion cable.



“Connecting the AC adapter and turning the power on/off” (p. 25)

■ USB cable (1 meter)

You can use this cable to connect the R-4 Pro to the USB connector of your computer.



“Connecting to a computer” (p. 82)

* If the AC adapter or USB cable becomes damaged or if you need a replacement for any reason, please contact one of the Service Centers listed in the “Information” section at the end of this manual.

* Don't remove the ferrite core that's attached to the USB cable.

■ Carrying case

You can use this case to protect the R-4 Pro while it is being transported or stored.

■ Owner's manual

This is the document you're reading. Keep it at hand for easy reference.

Introducing the R-4 Pro

The R-4 Pro's controls and connectors

Top panel

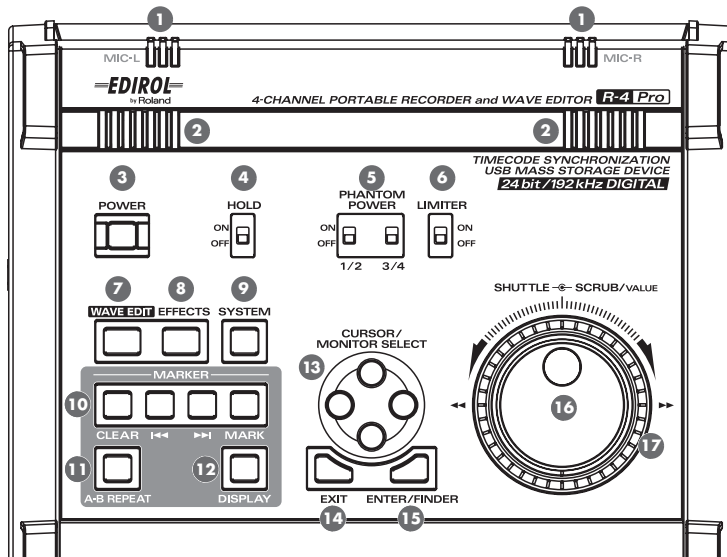

1 Internal mics [MIC-L, MIC-R]

These are stereo mics built into the R-4 Pro. The audio entering MIC-L is recorded on the 1L channel, while audio picked up by MIC-R is recorded on the 1R channel. If you're recording via the internal mics, set the System Settings menu item **Recording Setup** to **Int-Mic**. For details, refer to **"Recording from the internal mics"** (p. 33).

* Don't connect anything to input jacks you're not using.

2 Internal speakers

These are built-in speakers for monitoring. If you want sound to be heard from the internal speakers, set the System Settings menu item **Speaker** to **ON**. For details, refer to **"Playing back"** (p. 37).

* No sound will be heard from the internal speakers if you've connected headphones to the **Headphone jack** (34). Nor will sound be heard from the internal speakers while recording or in recording-standby mode; this prevents acoustic feedback from occurring. R-4 Pro

3 Power switch [POWER]

This turns the power on/off. To turn the power on or off, press and hold the power switch for about five seconds. The power switch is lit blue when the power is on.

Don't turn the power off during recording or playback. Before you turn off the power, you must make sure that recording or playback is stopped.

* If you accidentally turn off the power during recording, the data that was being recorded will not be stored on the hard disk.

* The hard disk may be damaged if you turn off the power of the R-4 Pro while data is being read from or written to the hard disk (such as during recording or playback). You must also be careful not to turn off the power while data is being transferred between the hard disk and an external memory device.

* Never turn off the power while the R-4 Pro's display indicates **Now Connecting...** or **Now Processing!** Doing so will cause the R-4 Pro to become unstable and may damage the internal hard disk.

* During recording, pressing the power switch will not turn off the power.

* The hard disk may be damaged if you turn off the power of the R-4 Pro while data on the hard disk is being written or read, such as during playback or waveform editing.

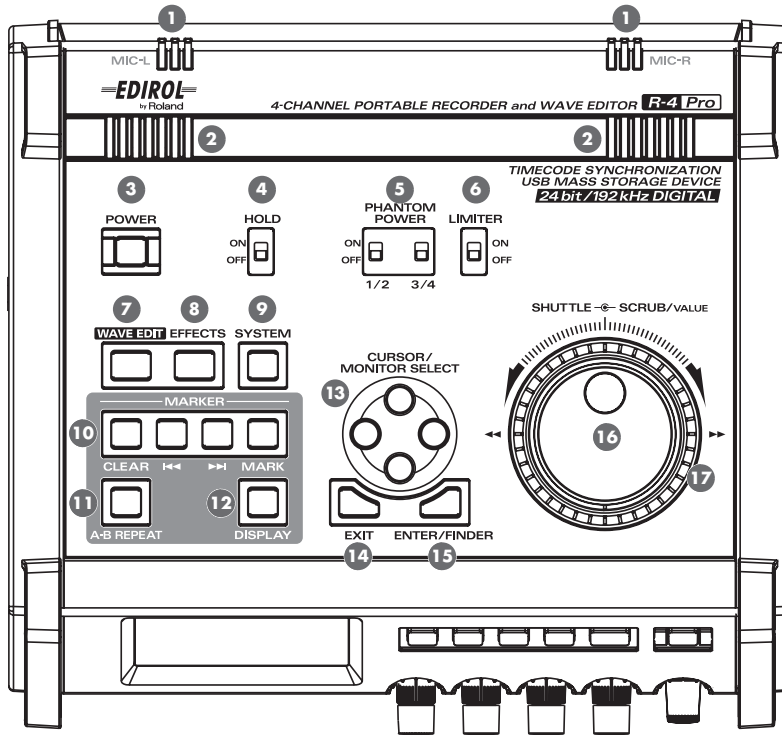

4 Hold switch [HOLD]

By selecting the **HOLD ON** position, you can disable the panel buttons so that unwanted operations will not occur if a button is pressed accidentally.

However, even if this switch is set to HOLD ON, the **phantom power switches** 5, **limiter switch** 6, **Input level knobs** 25, and **Monitor level knob** 26 will still be operable.

5 Phantom power switches [PHANTOM POWER]

These switch the phantom power on/off for the XLR type connectors located on the right panel. Since separate switches are provided for channels 1/2 and channels 3/4, you can turn phantom power on/off separately for these channels.

** Keep the phantom power turned off for any device other than condenser microphones that require phantom power. You risk causing damage if you mistakenly supply phantom power to dynamic microphones or other devices that don't require such power. Be sure to check the specifications of any microphone you intend to use by referring to the manual that came with it.*

*This instrument's phantom power: 48 V DC, 8 mA Max
(total of all channels must be 25 mA or less)*

6 Limiter switch [LIMITER]

This is an on/off switch for an input level limiter in the analog circuitry.

When the input level is too high, the limiter compresses the input level appropriately to prevent distortion. The limiter can be set to operate each channel independently or use channels 1-2 and 3-4 as pairs (linked). "Limiter Link" (P.71)

7 Wave edit button [WAVE EDIT]

This button takes you to Wave Edit mode, where you can edit the waveform using operations such as Trim, Divide, Combine, and Merge. For details, refer to “Editing” (p. 51).

You won't be able to enter Wave Edit mode during playback or recording, or if the R-4 Pro's hard disk contains no files that the R-4 Pro can handle.

WAV files are the only type of files that the R-4 Pro can handle.

8 Effect button [EFFECTS]

This button takes you to Effect mode, where you can make effect settings.

For details, refer to “Effects settings” (p. 59).

9 System button [SYSTEM]

This button takes you to a mode where you can make various settings for the R-4 Pro.

For details, refer to “System setup” (p. 64).

10 Marker [MARKER]

Clear button [CLEAR]

This button deletes markers you assigned using the *Mark button*. Markers are deleted successively, starting at the marker located immediately before the current location.

◀◀ button

This button moves you to the marker that is immediately before the current location (the previous marker). If the current playback location is earlier than the first marker, pressing this button will take you to the beginning of the project. You will also move to the beginning of the project if no markers have been set.

▶▶| button

This button moves you to the marker that is immediately after the current location (the next marker). If the current playback location is at the last marker, pressing this button will take you to the end of the project. You will also move to the end of the song if no markers have been set.

Mark button [MARK]

By pressing this button you can assign a marker to a desired location in the project file. Markers are numbered sequentially from the beginning of the project.

11 A-B Repeat button [A-B REPEAT]

This button lets you repeatedly play back the region between two points (A and B) in the project. Simply assign marker A and marker B while the project is playing, and playback will repeat between markers A and B.

1. During playback, press the *A-B Repeat button* once. That point becomes the beginning (marker A) of repeat playback.

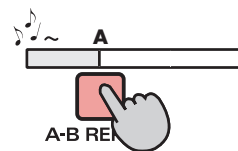

2. Press the *A-B Repeat button* once again. That point will be the end (marker B) of repeat playback.

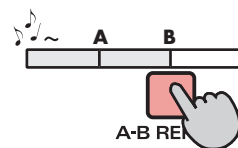

The region you specified in steps 1 and 2 will play repeatedly. To cancel repeat playback, press the *A-B Repeat button* once again.

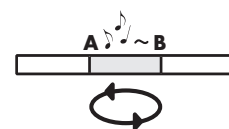

12 Display button [DISPLAY]

This button switches the contents of the R-4 Pro's display.

For details, refer to “Display” (p. 18).

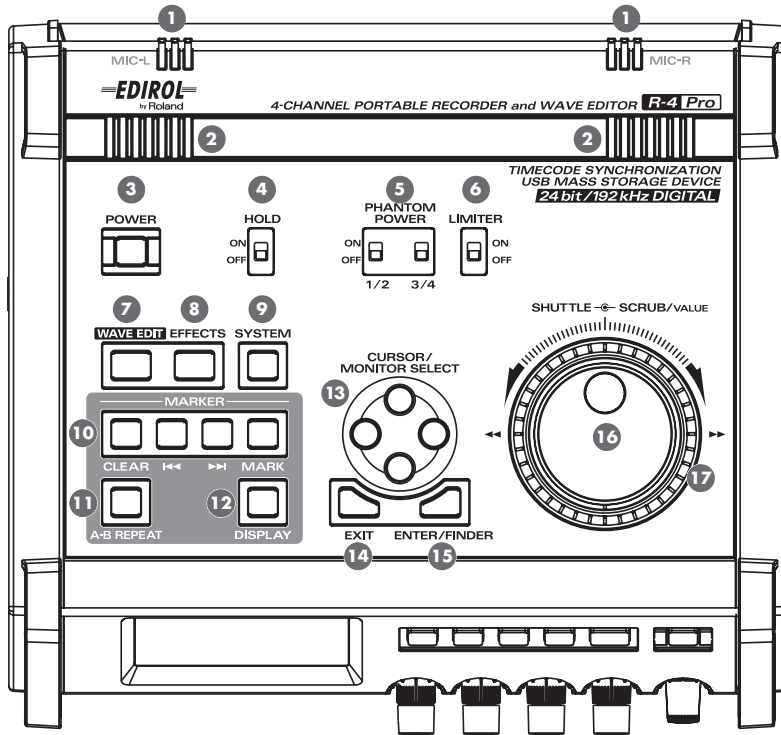

13 Cursor/Monitor Select buttons [CURSOR/MONITOR SELECT]

Use these buttons to select items shown in the display. When you're in the main screen, you can press the up/down buttons to select the channel that you want to monitor. For details, refer to **"Display"** (p. 18).

14 Exit button [EXIT]

Use this button to return to the previous screen or to cancel an operation.

15 Enter/Finder button [ENTER/FINDER]

Use this button to confirm a setting or set a value. You can also press this when you want to use the Finder function. For more about the Finder function, refer to **"Finder functions"** (p. 44).

16 Scrub dial [SCRUB/VALUE]

Use this dial to select a settings item or to modify a value. While stopped or when playback is paused, you can turn the scrub dial to move the current location forward or backward.

17 Shuttle dial [SHUTTLE]

While the project is playing, turn this dial clockwise to play rapidly forward, or counterclockwise to play rapidly backward. When the project is stopped, this dial advances the time counter.

Front panel

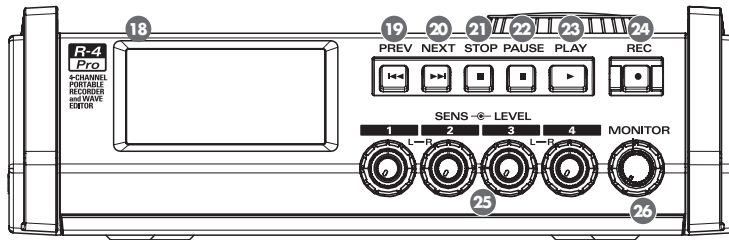

18 Display

This shows information about the R-4 Pro's status. For details, refer to **"Display"** (p. 18).

19 PREV button [PREV]

Pressing the **PREV button** while a project is playing or stopped will take you to the beginning of the project (00:00:00:00F). Pressing this button at the beginning of a project will take you to the preceding project. You can also press and hold down this button to rewind. This is available both while playing and while stopped.

* If **Play Mode** is set to **Single** in the **Player Setup** system setting, you can't move to the previous or next project during playback.

20 NEXT button [NEXT]

Pressing the **NEXT button** will take you to the next project. You can also press and hold this button to fast-forward. This is available both while playing and while stopped.

* If **Play Mode** is set to **Single** in the **Player Setup** system setting, you can't move to the previous or next project during playback.

21 Stop button [STOP]

This button stops playback or recording. If you press the **STOP button** during playback, the timer counter will display the time at which you pressed the **STOP button**.

22 Pause button [PAUSE]

This button pauses playback or recording.

23 Play button [PLAY]

This button starts playback. The **PLAY button** is lit blue during playback.

24 Record button [REC]

Recording will begin immediately when you press the **REC button**. The **REC button** is lit red during recording. If you hold down the **PAUSE button** and press the **REC button**, the **REC button** will blink red, and the R-4 Pro enters recording standby mode. Recording will begin when you then press the **REC button** or **PAUSE button**.

25 Input level knobs 1–4 [INPUT GAIN]/[SENS]

These knobs adjust the input level from each **XLR input connectors 1–4** (36). Input levels of the **internal mics** (1) are adjusted by **input level knob 1** (MIC-L) and **input level knob 2** (MIC-R).

You can adjust sensitivity to 11 levels: -56, -50, -44, -38, -32, -26, -20, -14, -8, -2, and +4 dBu. You can also set LEVEL from negative infinity to +8 dB, with the central position at 0 dB.

* When the internal mics are used, sensitivity cannot be adjusted (the knob settings are invalid).

26 Monitor level knob [MONITOR]

This adjusts the output volume from the **internal speakers** (2) and the **headphone jack** (37).

You can't adjust the volume from the **line output jacks** (40). If you want to adjust the volume of the line output jacks, adjust the controls of the external speakers or playback system connected to the line output jacks.

Side panel (left)

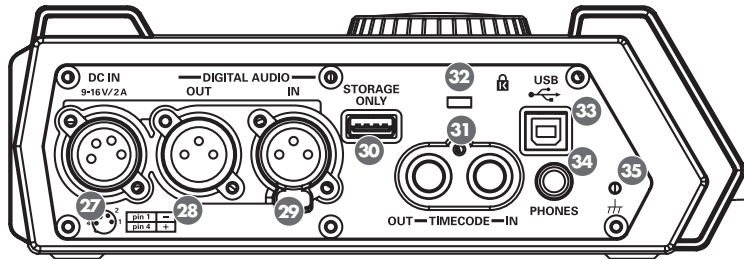

27 Power connector [DC IN]

You can connect either the included power conversion cable or a commercially available cable for an external power device.

28 Digital output connector [DIGITAL OUT]

This connector outputs a digital signal. You can connect digital devices, such as speakers or mixers, with an XLR type cable. This connector provides the same audio signal as the **headphone jack** (34), but in digital form. (AES/EBU, IEC 60958-4 compliant)

* *Volume cannot be adjusted with the monitor level knob.*

29 Digital input connector [DIGITAL IN]

If you want to record a digital signal, connect a XLR type cable to this connector. The digital input signal is recorded in stereo on channels 1L and 1R. If you want to record in monaural, you'll need to change the **Rec Mode** setting in the System Settings menu. For details, refer to "**1 Recording Setup**" (p. 72). (AES/EBU, IEC 60958-4 compliant)

30 USB Storage connector [STORAGE ONLY]

You can connect commercially available USB external memory devices to this connector. You can backup projects recorded with the R-4 Pro to USB memory or USB hard disks.

For details on external memory devices, see **Handling external memory device** (p. 79)

31 Timecode Connector [TIMECODE]

You can connect devices with a timecode port. This allows you to record the timecode in the R-4 Pro when the recording starts (IN) and to output the R-4 Pro internal timecode (OUT). For details on recording the timecode, see **Connecting to a video device with a timecode port** (p. 84).

32 Security Slot [K]

<http://www.kensington.com/>

33 USB connector [USB]

You can use the included USB cable to connect the R-4 Pro to your computer to move or copy projects that were recorded on the R-4 Pro. You can also move or copy files from your computer to the R-4 Pro's hard disk.

34 Headphone jack [PHONES]

You can connect a set of headphones with this jack. Use the **monitor level knob** (26) to adjust the volume. If you connect headphones, no sound is output from the **internal speakers** (2).

35 Grounding terminal

Depending on the circumstances of a particular setup, you may experience a discomforting sensation, or perceive that the surface feels gritty to the touch when you touch this device, microphones connected to it, or the metal portions of other objects, such as guitars. This is due to an infinitesimal electrical charge, which is absolutely harmless. However, if you are concerned about this, connect the ground terminal (see figure) with an external ground. When the unit is grounded, a slight hum may occur, depending on the particulars of your installation. If you are unsure of the connection method, contact the nearest Roland Service Center, or an authorized Roland distributor, as listed on the "Information" page.

Unsuitable places for connection

- Water pipes (may result in shock or electrocution)
- Gas pipes (may result in fire or explosion)
- Telephone-line ground or lightning rod (may be dangerous in the event of lightning)

Side panel (right)

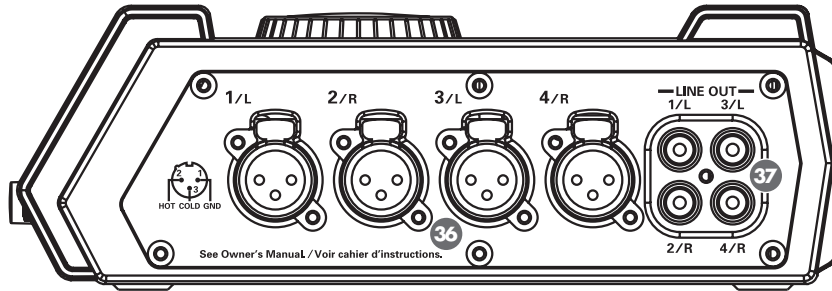

36 XLR input connectors 1-4

These are analog audio input connectors compatible with mic preamps. They accept either balanced or unbalanced connections.

You can use XLR input connectors 1-4 as four channels of monaural input or as two stereo pairs, 1/2 and 3/4. For details, refer to **"1 Recording Setup"** (p. 72).

* The XLR type connectors 1-4 can provide 48 V phantom power, allowing you to connect phantom-powered condenser mics. In this case, turn on the **phantom power switch** (5).

This R-4 pro is equipped with balanced (XLR) type connectors. Wiring diagrams for these jacks are shown below. Make connections after first checking the wiring diagrams of other equipment you intend to connect.



37 Line output jacks [LINE OUT]

These jacks output an analog audio signal. You can use RCA cables to connect powered speakers, audio equipment, mixers, and other devices.

The regulated output level is fixed at -10 dBu.

* The volume for each channel during playback can be adjusted on the mixer screen (p. 19).

* Line output can be output as 4-indiv or monitor. See **"5 System Setup"** in **System settings** (p. 75) for details.

Bottom panel

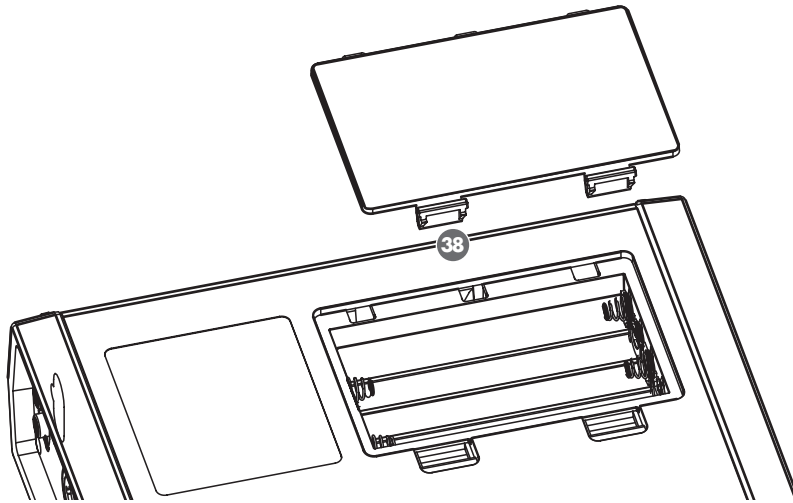

38 Battery compartment

Install batteries here if you want to operate the R-4 Pro on battery power.

The orientation in which you must insert the batteries is shown on the side of the battery compartment.

Be sure to observe the correct polarity when installing the batteries.

If you're using the AC adapter, there's no need to install batteries.

When the R-4 Pro has sufficiently charged batteries, the power source automatically switches between battery and external power when the external power connector is connected or disconnected.

For details, refer to **"Installing batteries and turning on the power"** (p. 26).

Display

While playing or stopped

The Main screen

The R-4 Pro Main screen shows information about the project and the operational status of the R-4 Pro. You can press the **[DISPLAY]** button to switch the contents of the display.

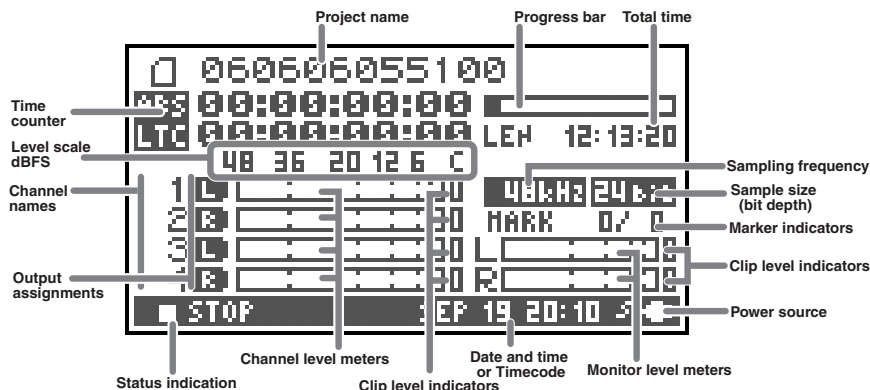

Project name		Displays the name of the project. The file name is shown when you copy WAV files from your computer via USB to the R-4 Pro's internal hard disk. File names containing double-byte characters (e.g., Japanese) are not displayed correctly, but they can be played.
Time counter	ABS	Displays the time elapsed from the beginning of the project to the current position (absolute time) in hours:minutes:seconds:frames format.
	LTC	Displays the timecode (p. 84) for the current position in hours: minutes:seconds: frames format.
Progress bar		Displays the current playback location relative to the entire project.
Total time (LEN: Length)		Displays the total time of the entire project.
Level scale		The sound level for each channel (after adjusting input levels) is shown in real time.
Clip level indicators		The markings are relative to 0 dBFS (Full Scale) of the digital signal. For example, 12 indicates -12 dBFS. C is the clipping level (0 dBFS).
Channel level meters		
Channel names		Displays up to four channel names. If you're using one stereo channel, 1L and 1R are shown. If you're using two stereo channels, 1L, 1R, 2L, and 2R are shown. For monaural project, 1, 2, 3, and 4 are shown according to the number of channels. When the sensitivity setting is too large and clipping occurs the display is shown in inverted black and white.
Output assignments		The output assignments show how the audio of each channel is assigned to the L/R output channels. L means that the audio is output to the left channel, R to the right channel, and LR to both left and right channels. Channels that are not shown are not output. From the main screen, you can use the [CURSOR] up/down buttons to select the channel that you want to monitor. The output is sent to the PHONES jack, line output jacks, and digital output connector. * When Output Sel (p. 75) in the system settings is set to "monitor," the line output jacks output sounds as set in the output assignments.
Sampling frequency		Displays the sampling frequency and sample size (bit depth) of the currently selected project.
Sample size		

Marker display	The number on the left is the number of marker located immediately before the current time counter value. The number on the right indicates the total number of markers assigned in the currently selected project. E indicates the end of the current project.
Monitor level meters	These are the output level meters. The output level assigned to the L/R channels of the monitor is displayed as the final output level after mixing the L and R channels separately. You can adjust the level of each channel with the channel level sliders from the mixer screen. The level meter is calibrated at -36, -20, -12, -6, and -3 dBFS from the left.
Clip level indicators	
Power source	Displays the power supply source for the R-4 Pro. When power is supplied via the AC adapter, a power plug icon is shown; when power is supplied via batteries or an external power supply device (see p. 29), a battery icon is displayed.
Date and time or timecode	Displays the current date and time or the timecode. To change the display, see Connecting to a video device with a time-code port (p. 84)

From the Main screen, you can press the **[DISPLAY] button** to switch the progress bar area so it shows the remaining project time (REM: REMAIN).

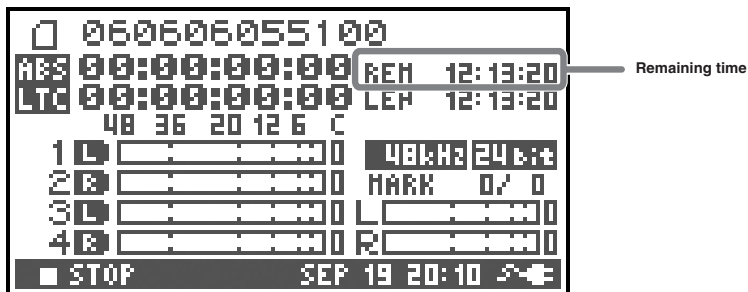

Remaining time	During playback, this displays the remaining time from the current location to the end of the project.
-----------------------	--

The Mixer screen

From the Main screen, press the **[DISPLAY] button** twice to show to the Mixer screen. This screen lets you adjust the volume balance for monitoring.

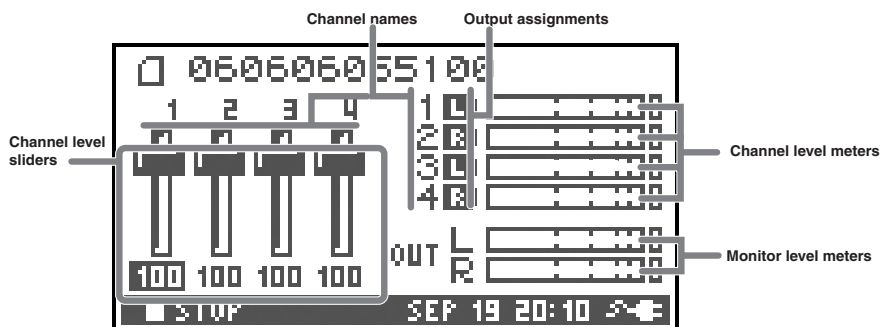

Channel level sliders	<p>These levers adjust the playback level for each channel. Use the left/right [CURSOR/FINDER] buttons to select a slider, and turn the [SCRUB/VALUE] dial to adjust the value. Each slider can be adjusted within the range 0–120. The default value is 100.</p> <ul style="list-style-type: none"> * The settings are stored by the R-4 Pro and not in the project. When you turn off the power, the settings revert to the default value. * These settings do not affect the recording levels.
------------------------------	---

While recording

The Main screen

The R-4 Pro Main screen displays information about the project and the operational status of the R-4 Pro. You can press the **[DISPLAY]** button to switch the contents of the display.

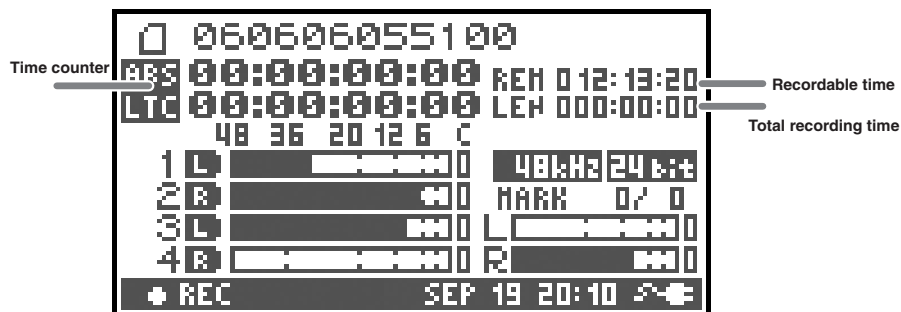

Time counter	ABS	Displays the time elapsed from the beginning of the project to the current position (absolute time) in hours:minutes:seconds:frames format.
	LTC	Displays the timecode (p. 84) for the current position in hours: minutes:seconds: frames format.
Recordable time		Displays the time that recording can take place.
Total recording time		Displays the total time from the beginning of recording to the current location. * Even if you record continuously, another new project will be created automatically when the project reaches 2 GB in size, and recording will continue. Even for recordings spanning multiple projects, the elapsed time since you first pressed the [REC] (record) button is shown here.

* For an explanation of the other displays, refer to **“While playing or stopped”** (p. 18).

From the Main screen, you can press the **[DISPLAY]** button to change the recordable time display to the remaining hard disk capacity display.

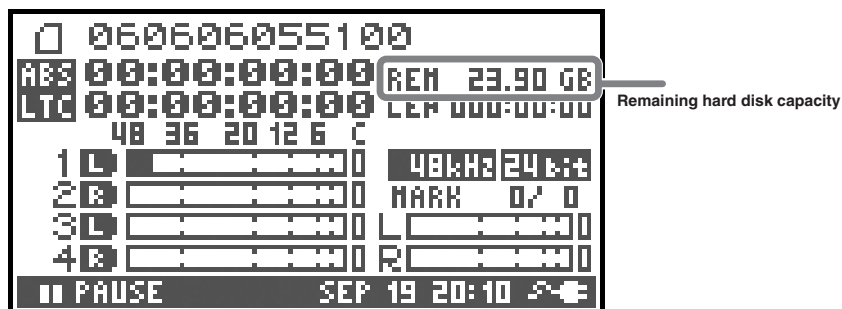

Remaining hard disk capacity	Displays the amount of free memory on the internal hard disk.
------------------------------	---

When the [DISPLAY] button is pressed twice while the Main screen is showing, the display changes to show the recording buffer capacity (BUF: buffer gauge).

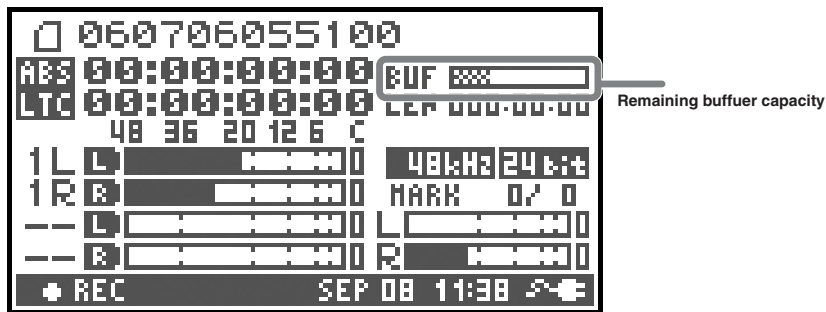

The recording buffer is memory that temporarily stores the input sound before it is written to the hard disk. The buffer gauge indicates how much of the recording buffer has been used. Normally, the recording buffer never reaches capacity because input sound is immediately written to the hard disk. However, if data cannot be written to the hard disk or if the hard disk processing capacity decreases and writing data to the hard disk is delayed due to the R-4 Pro use environment (vibrations or sound pressure), then the data may accumulate to an excess and the buffer may overflow. (The hard disk processing capacity may be affected if file arrangement on the disk becomes irregular due to project files being repeatedly written and deleted.)

- * When the recording buffer is close to capacity, the "HDD buffering" message is displayed. If vibration or sound pressure may be the cause, take the R-4 Pro to a location where there is no vibration or sound pressure and check if the recording buffer capacity is restored.
- * When the recording buffer reaches capacity, the buffer gauge moves all the way to the right edge and the "HDD Slow!" message is shown. Recording does not stop even if the "HDD Slow!" message is displayed, but some sound is not recorded. This message will not disappear until a button is pressed.
- * The same message is displayed if the hard disk processing capacity is diminished and writing to the hard disk is delayed even in a location where there is no vibration or sound pressure. For important recordings, we recommend formatting the hard disk before use.

What is a project?

On the R-4 Pro, the data that you record and play back is handled as a *project*. On the hard disk, each project actually consists of a folder with one or more files, as shown below.

If you connect the R-4 Pro to your computer, you'll be able to see how these folders and files are organized. However, if you change, delete, or rename the files within a project, the R-4 Pro may be unable to play back that project. Please use caution.

In the system settings, the **Recording Setup** parameter Rec Mode (p. 73) lets you specify the type of project you want to record.

Monaural projects

Type	Structure
MONOx1	If there is only one channel, a monaural WAV file will be created with a name consisting of the project name and a .wav extension.
MONOx2 MONOx3 MONOx4	If there are 2–4 channels, a folder will be created with a name consisting of the project name plus an extension of .pjt . In that folder, monaural WAV files will be created with names consisting of the channel number and a .wav extension.

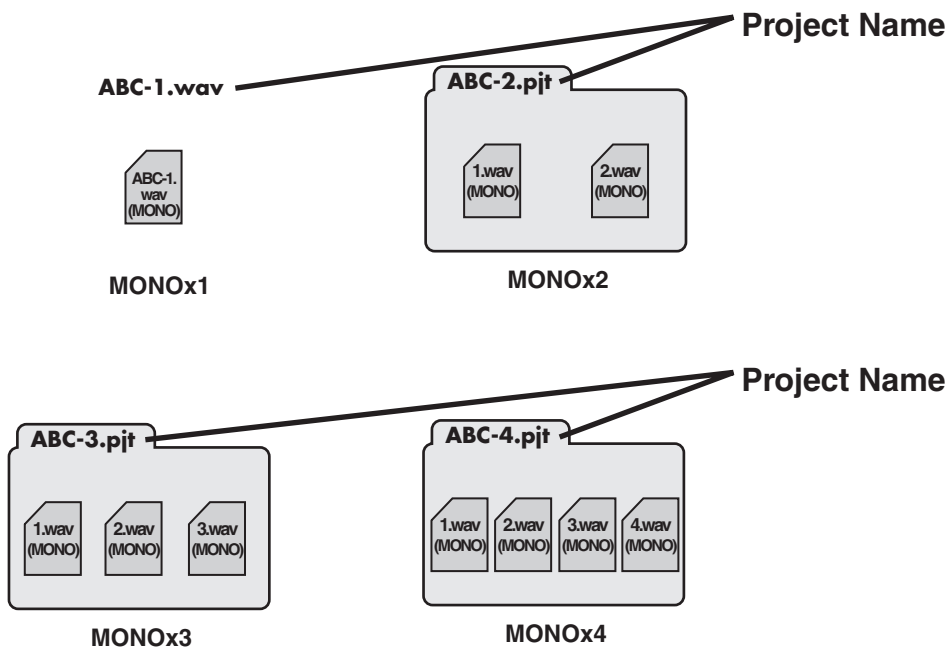

Stereo projects

Type	Structure
STEREOx1	If there is only one stereo channel pair, a stereo WAV file will be created with a name consisting of the project name and a.wav extension.
STEREOx2	If there are two stereo channel pairs, a folder will be created with a name consisting of the project name plus an extension of .pjt . In that folder, stereo WAV files will be created with names consisting of the channel number and a .wav extension.

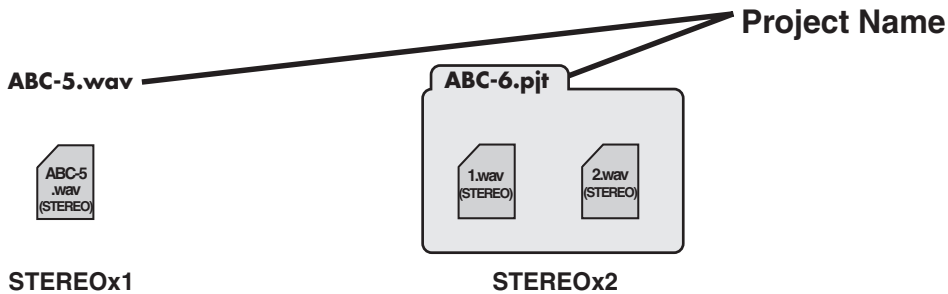

Four-channel projects

Type	Structure
4CH	A four-channel WAV file will be created with a name consisting of the project name and a .wav extension.

ABC-7.wav — Project Name



4CH

** If you want to load these files onto your computer, make sure that your waveform editing software supports four-channel files.*

Limitations on file size

The R-4 Pro can handle files up to 2 GB in size. If the file size reaches 2 GB during recording, the file is closed. Then, a new file is created and recording continues. When you finish recording, these files appear as separate projects.

About BWF

Files created during recording and editing are in BWF (Broadcast Wave Format). BWF files contain information about the recording time and recording device (EDIROL R-4 Pro) in addition to the data of a conventional WAV file. Of course, BWF files can be loaded by playback devices or audio editing software as conventional WAV files.

When the Setup-Mode for "6 Timecode" (p. 66) in the system settings is "OFF," files are created in WAV format.

Caution when copying files from your computer

Be aware of the following when copying files from your computer into the R-4 Pro's internal hard disk.

- The R-4 Pro can only record linear PCM WAV files at sampling frequencies of 44.1, 48, 88.2, 96, or 192 kHz and bit depths of 16 or 24 bits. It cannot play back any other type of file.
- File and folder names containing double-byte characters (e.g., Japanese) will not be displayed correctly.
- Any files other than WAV files cannot be recognized by the R-4 Pro, and will be ignored.
- Files beginning with "." (dot) will be ignored.
- You must not copy files larger than 2 GB into the R-4 Pro's internal hard disk. Doing so will make the R-4 Pro's operation unstable, and in the worst case might even damage the files in the internal hard disk.

Getting ready to use the R-4 Pro

Basic connection examples

To prevent malfunction and/or damage to speakers or other devices, always turn down the volume and turn off the power on all devices before making any connections.

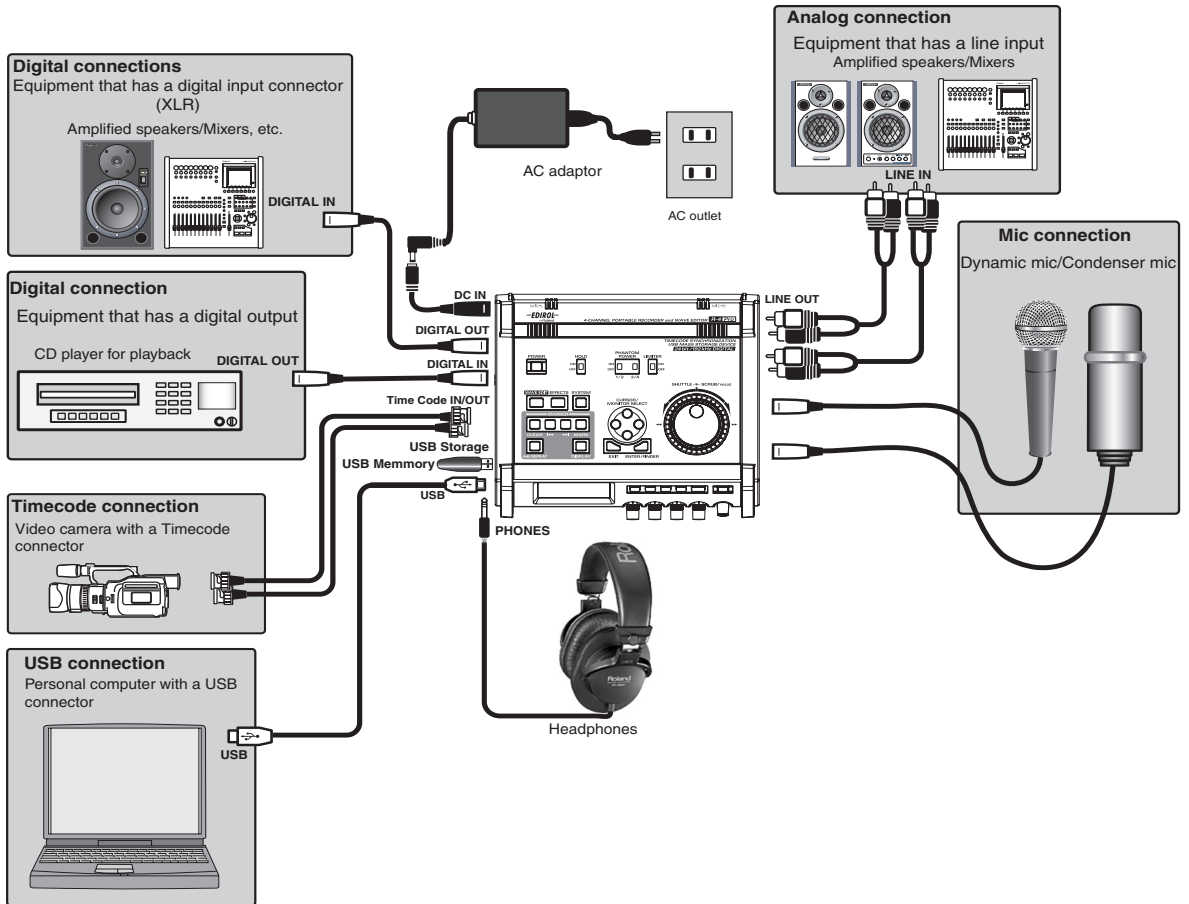

For more about connections, refer to both **“Recording”** (p. 30) and **“Playing back”** (p. 37).

When connection cables with resistors are used, the volume level of equipment connected to the inputs XLR input connector 1 – 4 may be low. If this happens, use connection cables that do not contain resistors.

Connecting the AC adapter and turning the power on/off

- * Once the connections have been completed, turn on power to your various devices in the order specified. By turning on devices in the wrong order, you risk causing malfunction and/or damage to speakers and other devices.
- * Reduce the volume before turning on power. Even when the volume is turned down, sound may be produced when turning on the power. This is not a defect.
- * If you connect the AC adapter when batteries are installed, the power will be supplied from the AC adapter.

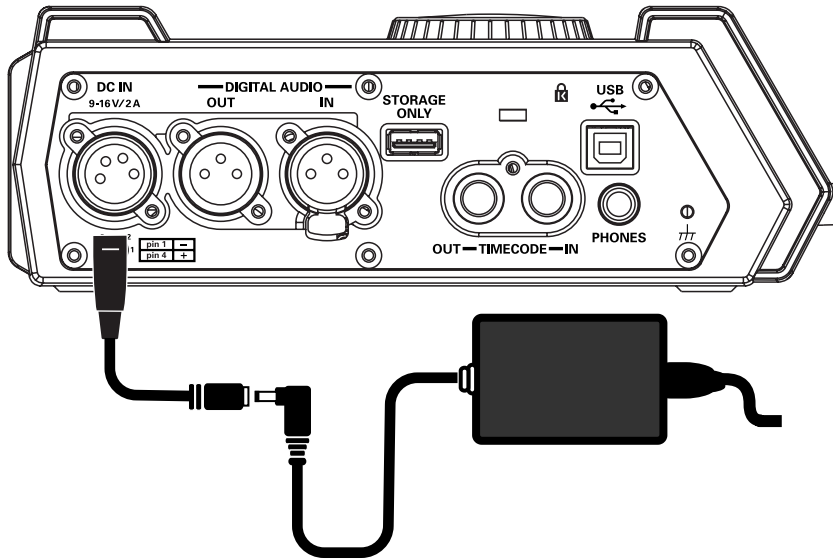

Turning on the power

- 1 Connect the power conversion cable and AC adapter.
 - * Use only the included AC adapter.
- 2 Plug the power conversion cable connector into the power connector on the R-4 Pro side panel (left).
- 3 Plug the AC adapter into an AC power outlet.
- 4 To turn the power on, press and hold the R-4 Pro **[POWER] switch** for about two seconds. Wait until the Main screen appears.

* This unit is equipped with a protection circuit. A brief interval (a few seconds) after power up is required before the unit will operate normally.

Turning off the power

- 5 From the Main screen, press and hold the R-4 Pro **[POWER] switch** for about five seconds to turn the power off.
 - * If there are batteries in the unit while an AC adaptor is being used, normal operation will continue should the line voltage be interrupted (power blackout or power cord disconnection).

Installing batteries and turning on the power

■ Types of batteries you can use

- AA alkaline batteries (LR6)
 - AA nickel metal-hydride (HR15/51)
(The R-4 Pro cannot recharge nickel metal-hydride batteries. You must use a separate charger.)
- * You must specify the type of batteries in the R-4 Pro **System Settings menu** item **"5 System Setup"** (p. 75). The R-4 Pro will not operate correctly if the specified battery type that does not match the actual batteries.

1 Make sure that the R-4 Pro is turned off, and disconnect the power conversion cable from the power connector on the R-4 pro side panel (left).

2 Detach the battery cover from the bottom panel of the R-4 Pro.

* When turning the unit upside-down, handle with care to avoid dropping it, or allowing it to fall or tip over.

* When turning the unit upside-down, get a bunch of newspapers or magazines, and place them under the four corners or at both ends to prevent damage to the buttons and controls. Also, you should try to orient the unit so no buttons or controls get damaged.

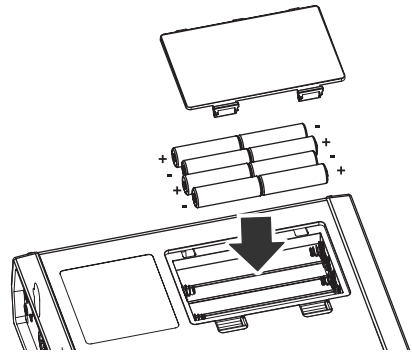

3 Insert eight AA batteries into the battery compartment, making sure to observe the correct polarity (+ and - symbols).

4 Replace the battery cover.

5 Turn on the R-4 Pro.

6 Press the **[SYSTEM]** button.

7 Use the **[CURSOR] up/down buttons** to select **5 System Setup**.

8 Press the **[ENTER]** button.

9 Using the **[SCRUB/VALUE]** dial, set the **Battery Type** to **Alkaline** if installing alkaline batteries or to **Ni-MH** if installing nickel metal-hydride batteries. The setting is activated as soon as you select it.

10 When finished with the setting, press the **[EXIT]** button to return to the previous screen.

11 When you have returned to the **System Menu** screen, press the **[EXIT]** button once again.

Although **[ENTER]** will be blinking in the display, if you do not need to make additional settings, press the **[EXIT]** button to return to the Main screen.

■ **Caution when using battery power on the R-4 Pro**

- If you operate on battery power for an extended time, the batteries will become hot. Be careful not to burn yourself.
- Please use alkaline batteries, which have a longer life.
- Do not mix new batteries with used batteries nor mix batteries of differing types.
- If you will not be using the R-4 Pro for an extended time, we recommend that you remove the batteries to prevent leakage or other accidents.
- When using a USB cable to connect the R-4 Pro to your computer, use the AC adapter to prevent the loss of power while the connection is active.

Battery status

When using the R-4 Pro on battery power, a battery icon is shown in the lower right of the display. As the battery runs down, the battery icon will change as follows.

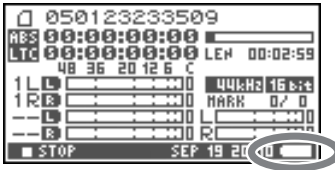
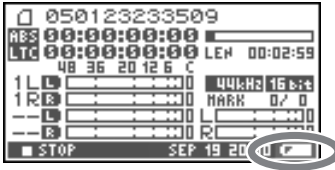
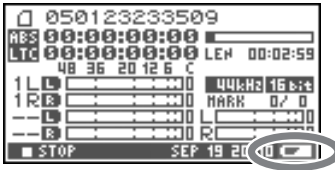
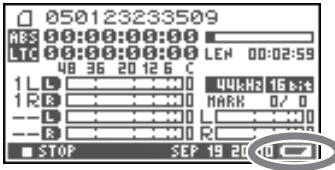
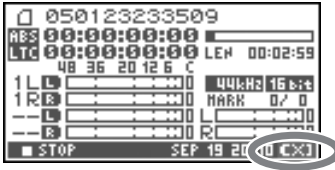
Remaining charge	Display
Level 4 (sufficient)	
Level 3	
Level 2	
Level 1	
Level 0 (little remaining)	

When the battery reaches Level 0, the message in the figure is shown. Replace the batteries as soon as possible.

If you continue using the R-4 Pro when the batteries are low, the screen is the figure is shown, and then the power automatically turns off shortly thereafter.



■ Battery life

(When using alkaline batteries, 44.1 kHz, 16-bit, stereo, with phantom power off)

Continuous playback	approximately 3.5 hours
Continuous recording	approximately 2 hours

* The values for battery life shown above are only approximate; they will vary depending on your system and conditions of use.

* Battery life is shortened if the display backlighting is left on or if you make heavy use of effects. You can specify how long the backlight is to remain on with the System settings. For details, refer to "4 LCD Setup" (p. 75).

Using external power sources

When using an external power supply, be sure to set the final voltage.

The final voltage refers to the voltage when voltage can no longer be supplied because the capacity of the external power source is reduced and voltage decreases as electricity is consumed.

If the final voltage is not properly set for the external power source, the remaining power display is not shown. See the user's manual for the external power source for the final voltage value.

Furthermore, when the "Battery Low" message is displayed, the recording automatically stops, but the power does not automatically turn off. Turn the R-4 Pro power off and change the external power source.

* If the final voltage is not set, the "Battery Low" message is not displayed and the power may cut off. Read the following to set the final voltage for the R-4 Pro.

■ Setting final voltage

- 1 Press the R-4 Pro **[SYSTEM]** button.
The display shows the System menu.



- 2 Use the **[CURSOR]** buttons to select 5 System Set Up, and press the **[ENTER]** button.
The System Setup screen is shown.

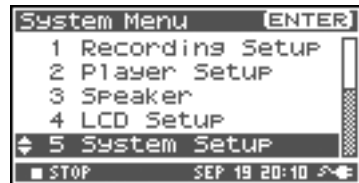

- 3 Use the **[CURSOR]** buttons to select the Ext-Power item.

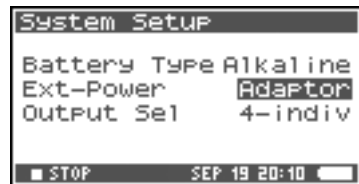

- 4 Use the **[SCRUB/VALUE]** dial to set the final voltage.
Final voltage values: 9.0/9.5/10.0/10.5/11.0/11.5/12.0 V

* The final voltage value will differ according to the external power source specifications. Check the specifications for the external power source being used for details.



- 5 Press the **[EXIT]** button twice to return to the Main screen.

This completes setting the final voltage.

Recording

Recording from a connected mic

The following describes how to record audio from a mic connected to a R-4 Pro XLR input connector.

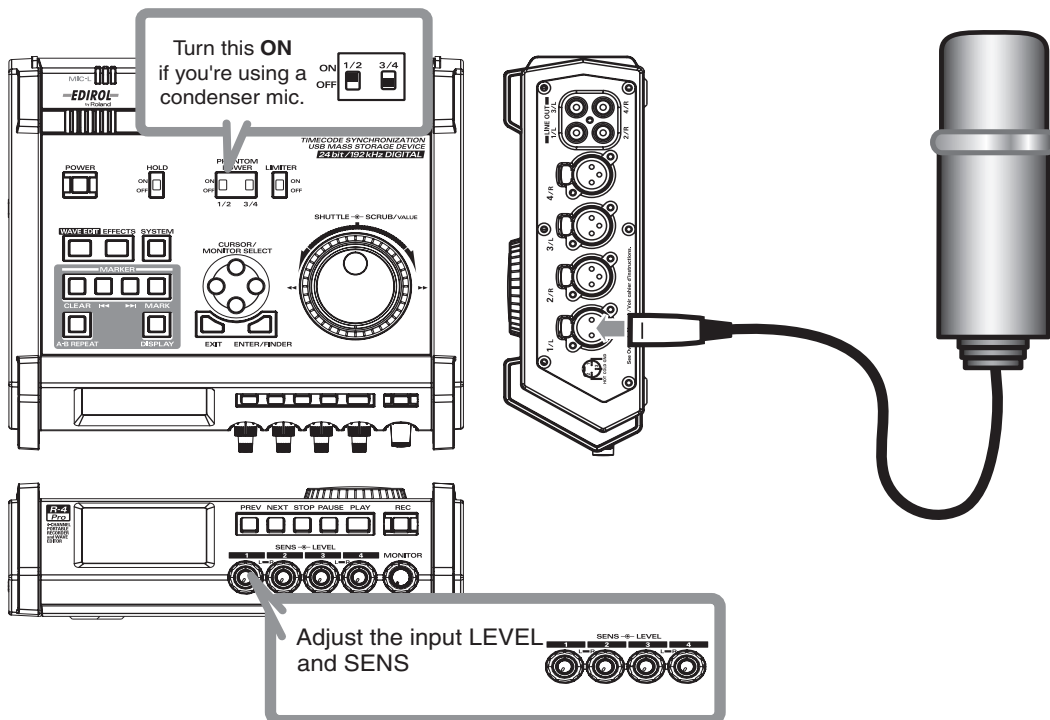

● Connections

Connect your mic to a **XLR input connector**.

Howling could be produced depending on the location of microphones relative to speakers. This can be remedied by:

1. Changing the orientation of the microphone(s).
2. Relocating microphone(s) at a greater distance from speakers.
3. Lowering volume levels.

● Phantom power switch

Turn this **ON** when connecting a phantom-powered condenser mic.

● System settings

Press the R-4 Pro **[SYSTEM]** button.

In **1 Recording Setup**, set **Input Select** to **Analog**.

Set the other items in **1 Recording Setup** as appropriate for the recording you want to make.

* For more about system settings, refer to **"System setup"** (p. 64).

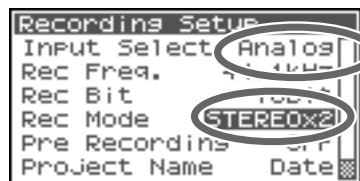

● Limiter

Turn this **ON** if you want to prevent unexpectedly loud sounds or strong attacks from producing clipped noise.

The limiter threshold is -10 dB relative to digital full scale.

The limiter can group and link each channel. See **Limiter link** (p. 74).

● sensitivity/Input level knobs

These knobs adjust sensitivity/input levels.

When recording in stereo x2, these knobs control the following signals.

Channel 1	STEREO 1 L-channel	SENS/INPUT LEVEL 1 knob
Channel 2	STEREO 1 R-channel	SENS/INPUT LEVEL 2 knob
Channel 3	STEREO 2 L-channel	SENS/INPUT LEVEL 3 knob
Channel 4	STEREO 2 R-channel	SENS/INPUT LEVEL 4 knob

Adjusting the input level

1. Turn the **input level knob [SENS]** (outer) all the way left.
2. Turn the **input level knobs [LEVEL]** (inner) to the center position. This signal is 0 dB.
3. Hold down the **[PAUSE] button** and press the **[REC] button**.
The R-4 Pro enters recording standby mode. During recording standby, the [REC] button blinks and the display alternates between **REC** and **STANDBY**.
4. Play the sound to be recorded into the microphone.
Gradually turn the **input level knob [SENS]** toward the right.
sensitivity has 11 steps of -56, -50, -44, -38, -32, -26, -20, -14, -8, -2, and +4 dBu.
* When the channel name display reverses, the input level has reached the clipping level. Set to the knob to the position just before the display reverses.

5. Adjust the level so that the level meter shown in the display reaches a point slightly before **C (clip level)**. If the recording level is too low, quiet sounds will not be recorded. If the recording level is too high, soft sounds will be distorted, producing a crackling noise in the recording.

- * If clipping occurs when adjusting SENS, clipping may occur even if the level meter does not reach the clip level. The channel name blinks in black and white
- * The level meter displays the clip level (C) as 0 dBFS (FS = full scale). For example, **12** indicates -12 dBFS.

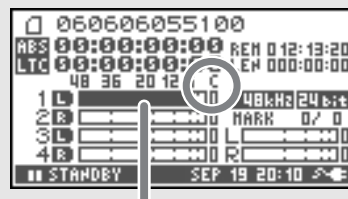

level meter (dBFS)

● Record button [REC]

If you want to begin recording immediately, press the **[REC]** button.

Recording standby

If you want to put the R-4 Pro in recording standby mode to be ready to record, hold down the **[PAUSE]** button and press the **[REC]** button.

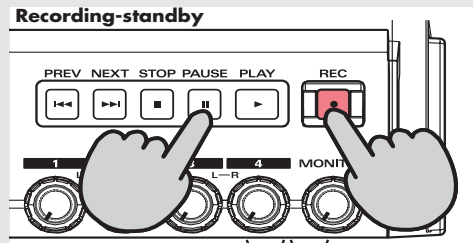

The R-4 Pro enters recording standby mode. During recording standby, the **[REC]** button blinks and the display alternates between **REC** and **STANDBY**.

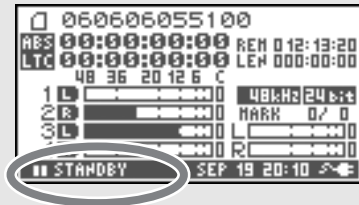

When recording is paused, the **[REC]** button blinks. In addition, the display alternates between REC and PAUSE.

Press the **[REC]** or **[PAUSE]** button during recording standby or while paused to start recording.

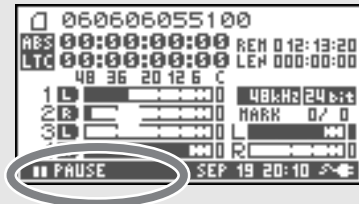

● Other settings

If you want to monitor the sound being recorded, connect headphones to the PHONES jack and use the monitor level knob to adjust the volume.

Adjusting the monitor level knob does not affect the level of the sound actually being recorded.

To play back the recorded sound, refer to “**Playing back**” (p. 37).

Caution regarding placement and handling while recording

The internal hard disk is a precision device. If you subject the hard disk to physical shock, such as the following, you may not be able to access the data on the disk, causing recording or playback to be unsuccessful. In the worst case, irreparable damage may occur.

Please avoid subjecting the R-4 Pro to strong impact or continuous vibration during use.

The following actions may cause malfunctions

- Subjecting the unit to impact, such as dropping it from a table onto a hard floor.
- Subjecting the unit to continuous vibration, such as by leaving it on an uncushioned surface like the floor of a moving automobile.

Recording from the internal mics

The following describes how to record an audio source via the R-4 Pro internal mics.

● Phantom power switch

Turn this **OFF**.

● System settings

Press the R-4 Pro **[SYSTEM]** button.

In **1 Recording Setup**, set **Input Select** to **IntMic**.

Set the other items in **1 Recording Setup** as appropriate for the recording you want to make.

* For more about system settings, refer to **"System setup"** (p. 64).

* The limiter and input level knob [SENS] settings are invalid.

* The internal mics cannot be used if the Rec Freq is set to 192.0 kHz. (They cannot be selected.)

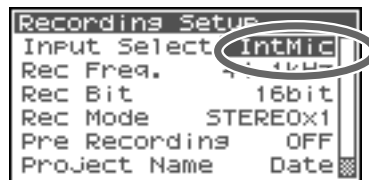

● Input level knobs

Adjust the input level.

1. Hold down the **[PAUSE]** button and press the **[REC]** button.

The R-4 Pro enters recording standby mode. During recording standby, the **[REC]** button blinks and the display alternates between REC and STANDBY.

2. Play the sound to be recorded into the microphone.
3. Gradually turn the **input level knob [LEVEL]** toward the right.
4. Adjust the level so that the level meter shown in the display reaches a point slightly before **C (clip level)**. If the recording level is too low, quiet sounds will not be recorded. If the recording level is too high, soft sounds will be distorted, producing a crackling noise in the recording.

* If the channel name blinks even before the level meter reaches C (clip level), the recording level is too high.

* The level meter displays the clip level (C) as 0 dBFS (FS = full scale). For example, **12** indicates -12 dBFS.

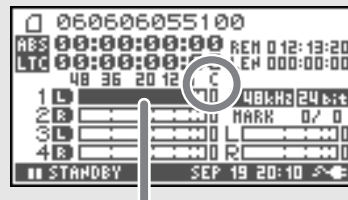

level meter (dBFS)

● Record button [REC]

Press the **[REC]** button to begin recording.

For details on recording standby, refer to **"Recording standby"** (p. 32).

● Other settings

If you want to monitor the sound being recorded, connect headphones to the PHONES jack and use the monitor level knob to adjust the volume.

Adjusting the monitor level knob does not affect the level of the sound actually being recorded.

To play back the recorded sound, refer to **"Playing back"** (p. 37).

Recording digital audio from a digital device

The following describes how to record from a digital device connected to the R-4 Pro digital input connector.

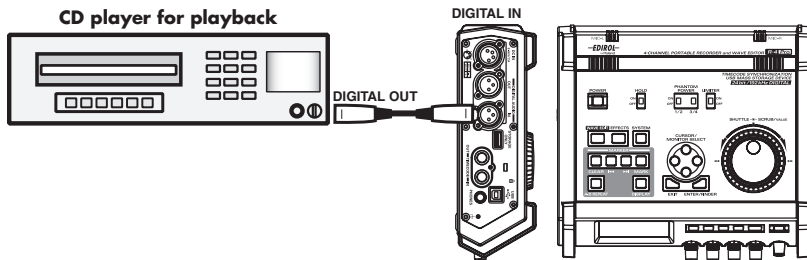

● Connections

Connect your digital device to the **digital input connector**. You will need a separately available XLR type cable to connect your device to the R-4 Pro digital input connector.

● System settings

1. Press the R-4 Pro **[SYSTEM]** button.
2. **1 Recording Setup**, set **Input Select** to **Digital**.
3. Set the sampling frequency to match the input source.
4. Set the other items in **1 Recording Setup** as appropriate for the recording you want to make.

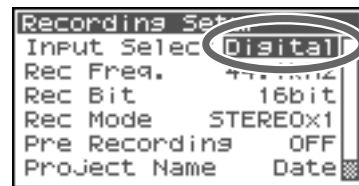

* For more about system settings, refer to **“System setup”** (p. 64).

* The R-4 Pro is able to synchronize to the clock signal of the digital input connector.

* When the input sampling frequency and set sample size differ, the sampling frequency display blinks and Mute data is generated.

● Record button [REC]

Press the **[REC]** button to begin recording.

For details on recording standby, refer to **“Recording standby”** (p. 32).

● Other settings

If you want to monitor the sound being recorded, connect headphones to the PHONES jack and use the monitor level knob to adjust the volume.

Adjusting the monitor level knob does not affect the level of the sound actually being recorded.

* When recording digital input, you can not use the input level knob to adjust the input level. The limiter and input level knobs [SENS] settings are also invalid.

To play back the recorded sound, refer to **“Playing back”** (p. 37).

Simultaneously recording sound from connected mics and a digital device

You can record sound from both mics connected to R-4 Pro XLR input connectors 3 and 4 and a digital device connected to the digital input connector.

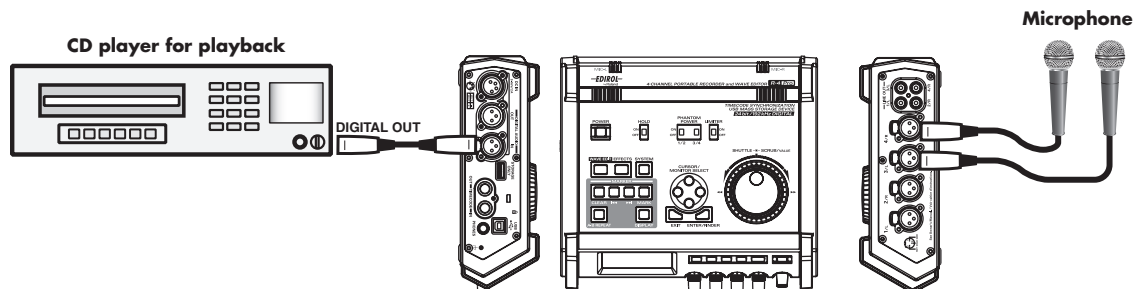

● System settings

Press the R-4 Pro **[SYSTEM]** button.

In **1 Recording Setup**, set **Input Select** to **Dig+Ana**.

Set the **Rec Mode** to **STEREOx2**.

Set the other items in **1 Recording Setup** as appropriate for the recording you want to make.

* For more about system settings, refer to **"System setup"** (p. 64).

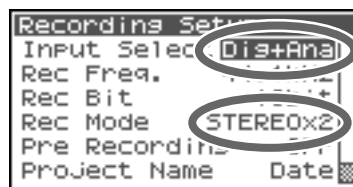

● Input level knobs

Adjust the input level.

Use the following to simultaneously record sound from mics and a digital device.

Channel 1	Digital input L channel	The input level and sensitivity cannot be adjusted with the input level knob.
Channel 2	Digital input R channel	
Channel 3	Analog input L channel	Input level, SENS knob 3
Channel 4	Analog input R channel	Input level, SENS knob 4

See **Adjusting the input level** (p. 31).

● Record button [REC]

Press the **[REC]** button to begin recording.

For details on recording standby, refer to **"Recording standby"** (p. 32).

● Limiter

Turn this **OFF** when recording an audio source whose levels have already been adjusted (in contrast to a live audio source whose levels might change unpredictably), or if you have already checked the maximum volume levels that are going to occur.

Turn this **ON** if you need to prevent clipping (distortion) that might be caused by unexpectedly loud volumes or strong attacks.

* The limiter and input level [SENS] knob settings are invalid for digital input.

● Other settings

If you want to monitor the sound being recorded, connect headphones to the PHONES jack and use the monitor level knob to adjust the volume.

Adjusting the monitor level knob does not affect the level of the sound actually being recorded.

To play back the recorded sound, refer to **"Playing back"** (p. 37).

Simultaneously recording sound from connected external mics and the internal mics

You can record sound both from the mics connected to R-4 Pro XLR input connectors 3 and 4 and the internal mics.

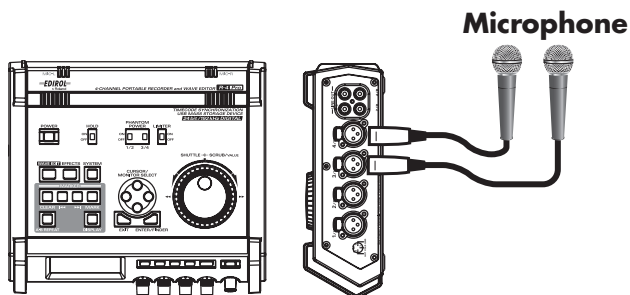

● System settings

Press the R-4 Pro **[SYSTEM]** button.

In **1 Recording Setup**, set **Input Select** to **Int+Ana**.

Set the **Rec Mode** to **STEREOx2**.

Set the other items in **1 Recording Setup** as appropriate for the recording you want to make.

* *The internal mics cannot be used if the Rec Freq is set to 192 kHz.*

If Rec Freq is set to 192 kHz after setting Int+Ana, the settings automatically change to Dig+Ana.

* *For more about system settings, refer to “System setup” (p. 64).*

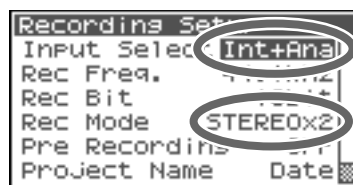

● Input level knobs

Adjust the input level.

Use the following to simultaneously record sound from internal mics and external mics.

Channel 1	Internal mic L channel	Input level knob 1
Channel 2	Internal mic R channel	Input level knob 2
Channel 3	Analog input L channel	Input level, SENS knob 3
Channel 4	Analog input R channel	Input level, SENS knob 4

* *The input level knob [SENS] settings are invalid for the internal mics.*

See **Adjusting the input level** (p. 31).

● Record button [REC]

Press the **[REC] (record) button** to begin recording.

For details on recording standby, refer to “Recording standby” (p. 32).

● Other settings

If you want to monitor the sound being recorded, connect headphones to the PHONES jack and use the monitor level knob to adjust the volume.

Adjusting the monitor level knob does affect the level of the sound actually being recorded.

To play back the recorded sound, refer to “Playing back” (p. 37).

Playing back

This section explains how to play back audio recorded on the R-4 Pro and projects on the R-4 Pro internal hard disk. Make the correct settings and connections before playing anything back.

- **Connections before playback**..... (p. 37)
- **Setup before playback**..... (p. 39)
- **Playing back**..... (p. 41)

Connections before playback

Connecting headphones

Headphones are a convenient way to monitor while recording or to check sound immediately after recording.

1. Turn the **[MONITOR] level knob** all the way to the left to minimize the volume.
2. Connect your headphones to the **PHONES jack**.
3. Slowly turn the **[MONITOR] level knob** toward the right to adjust the volume.

Connecting amplified speakers

The following describes how to connect amplified speakers that have line input jacks or a digital input jack.

1. Switch off the power to the R-4 Pro.
2. Minimize the volume of the speakers you want to connect, and then turn off the power.
3. Depending on the type of speakers you are using, connect the amplified speakers to the R-4 Pro **[LINE OUT] line output jacks** or **[DIGITAL OUT] digital output connector**.
4. Switch on the R-4 Pro power.
5. Switch on your speakers, and gradually increase the volume to the desired level.

* You cannot adjust the volume of the audio output from the R-4 Pro line output jacks.

Connecting a mixer or other analog device (analog connection: line output jacks)

The following describes how to connect a mixer or other audio device that has line input jacks.

1. Switch off the power to the R-4 Pro.
2. Minimize the volume of the mixer or other device being connected.
3. Connect the mixer to the R-4 Pro **[LINE OUT] line output jacks**.
You will need separately available audio cables (not included) to connect to the R-4 Pro line output jacks.

* Line output can be output as 4-indiv or monitor. See "System Setting" in "**5 System Setup**" (p. 75) for details.

4. Switch on the R-4 Pro power.
5. Switch on your mixer, and gradually increase the volume to the desired level.

* You cannot adjust the volume of the audio output from the R-4 Pro line output jacks.

Connecting a device having a digital input port (digital connection: R-4 Pro digital output connector)

The following describes how to connect devices with digital input ports, such as mixers, speakers, or recording devices.

The sampling frequency of the project playing back will be the sampling frequency of the audio output from the digital output connector.

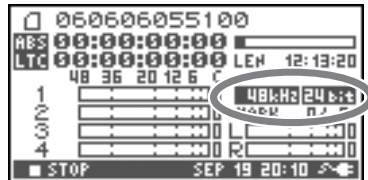

1. Switch off the power to the R-4 Pro.
2. Turn off power to the device with the digital input port.
3. Connect the R-4 Pro **digital output connector [DIGITAL OUT]** to the **digital input connector** of the device with digital input.
 - * You will need a separately available XLR type cable (not included) to connect your digital device to the R-4 Pro **digital output connector**.
4. Switch on the R-4 Pro power.
5. Turn on power to the device with the digital input port.
 - * You cannot adjust the volume of the R-4 Pro digital audio signal.

Setup before playback

Player Setup

- 1 Press the R-4 Pro **[SYSTEM]** button.
The system menu screen appears in the display.

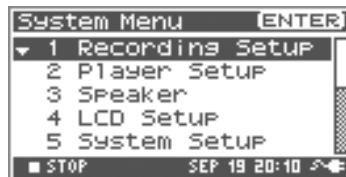

- 2 Use the **[CURSOR]** buttons to choose **2 Player Setup**, and press the **[ENTER]** button.
The Player Setup screen appears.



- 3 Use the **[SCRUB/VALUE]** dial to choose the **Play Mode** value.

* The setting is applied as soon as you select it. You do not need to press the **[ENTER]** button.

You can also setup the following items.

Menu	Player Setup settings	Playback method
Play Mode	Single	Selects the playback mode. Only the selected project will play.
	Sequential	The projects in the folder containing the currently selected project will play consecutively.
Repeat	OFF , ON	Selects whether playback will repeat. If Play Mode is Single , only that project will be repeated. If it is Sequential , the projects in the folder containing the currently selected project play consecutively, and then the projects in the same folder will be repeated consecutively from the beginning.

* The values in boldface are the default values.

* For more about system settings, refer to **"System setup"** (p. 64).

Speaker

You can use the R-4 Pro internal speakers to monitor the sound without having to connect headphones or other equipment.

- 1 Press the R-4 Pro **[SYSTEM]** button.
The system menu screen appears in the display.

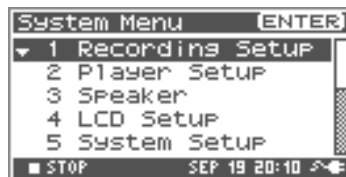

- 2 Use the **[CURSOR]** buttons to choose **3 Speaker**, and press the **[ENTER]** button.

The Speaker screen appears.



Speaker Switch setting	Output destination
ON	Internal speakers Line output jacks Digital output jack
OFF	Line output jacks Digital output jack

* The values in boldface are the default values.

* You cannot monitor with the internal speakers while recording. You will need to monitor through headphones. Note that sound will not be output from the internal speakers if headphones are connected. If you want to use the internal speakers, you must disconnect the headphones.

* For more about system settings, refer to "**System setup**" (p. 64).

Playing back

Normal playback

After performing the steps described in “**Connections before playback**” (p. 37) and “**Setup before playback**” (p. 39), proceed as follows.

- 1** ▶ Select the project that you want to play.

From the Main screen, press the **[ENTER/FINDER] button**. In the Finder screen that appears, use the **[CURSOR] up/down buttons** and the **[SCRUB] dial** to select a project. For more about the Finder screen, refer to “**Finder functions**” (p. 44).
Alternatively, you can use the **[PREV] button** or **[NEXT] button** on the front panel to select the project you want to play. The projects are in alphabetical order.
- 2** ▶ Press the **[PLAY] button**.

The selected project will play.
- 3** ▶ Slowly raise the **[MONITOR] level knob** to the desired volume for listening.

** Projects with names beginning with “.” are ignored, and will not be shown.*
** Projects whose filename extension is not .pjt or .wav will be ignored and will not be shown.*

Markers

You can assign markers at desired locations in a project. Then you can use the **◀◀ button** or **▶▶ button** to move backward or forward to a marker location.

You can use the Mark function either while playing or while recording.

- 1 Use the **[NEXT] button** or the **[SHUTTLE] dial** to find the location at which you want to assign a marker.

Play, fast-forward, or rewind the project to the location at which you want to assign a marker.

- 2 Press the **[MARK] button** at the location at which you want to assign a marker.

You can assign markers while playing, recording, or stopped.

The display indicates the number of markers as shown in the figure at right. Marks are numbered sequentially starting from the beginning of the project.

You can assign up to 99 markers.

Repeat steps 1 and 2 to assign markers as desired.



Number of markers in the project

Marker information

Number of markers you've passed

- 3 After assigning one or more markers, proceed as follows.

You can use these operations either while playing or while stopped.

◀◀ button

Moves to the marker immediately before the current location (previous marker).

▶▶ button

Moves to the marker immediately following the current location (next marker).

CLEAR button

Deletes the marker that you set with the **[Mark] button**. Markers are deleted consecutively, starting with the marker immediately before the current location.

Repeat playback (A-B REPEAT)

You can repeatedly play back between two points (A-B) in the project. Simply assign points A and B during playback, and the playback will repeat between points A and B.

- 1 Play the project.

During playback, press the **[A-B REPEAT] button** once. The **[A-B REPEAT] button** blinks, and that location becomes the starting point (A) for repeat playback.

* If you press the **STOP button** after assigning point **A** but before assigning point **B**, point **A** will be deleted.

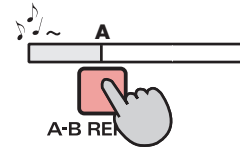

- 2 Press the **[A-B REPEAT] button** once again. The **[A-B REPEAT] button** stays lit, and that location becomes the end point (B) for repeat playback.

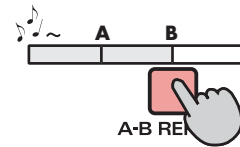

Playback automatically repeats between the points you specified in steps 1 and 2.

To cancel repeat playback, press the **[A-B REPEAT] button** when points A and B have already been assigned. The **[A-B REPEAT] button** goes out, and repeat playback is cancelled.

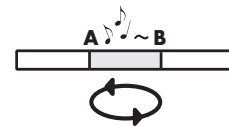

Please note

- * If you press the **STOP button** after assigning point **A** but before assigning point **B**, point **A** will be deleted.
- * If the song plays all the way to the end after assigning point **A**, playback will repeat between point **A** and the end of the song.
- * If you press the **[STOP] button** during repeat playback, playback stops and the repeat region (A-B) settings are cleared.

Finder functions

The R-4 Pro saves projects as files on its internal hard disk. You can use the Finder functions to select a project from numerous folders or projects within folders, to delete an unwanted project, or to copy a project to an external memory device.

Finder functions

No.	Menu	Operation	See
1	Select	Select and load a project.	p. 44
2	Delete	Delete a project.	p. 45
3	Rename	Rename a project.	p. 46
4	Copy	Copy the selected project.	p. 47
5	Move	Move the selected project to a different folder.	p. 48
6	Make Folder	Create a new folder.	p. 49

Selecting a project (Select)

- 1 With project playback stopped and the Main screen (p. 18) shown on the display, press the **[ENTER/FINDER]** button. The Finder screen shown in the figure is displayed.

Projects are shown in descending alphabetical order. HD represents the R-4 Pro hard disk, and EX represents an external memory device such as USB memory connected to the USB storage connector.

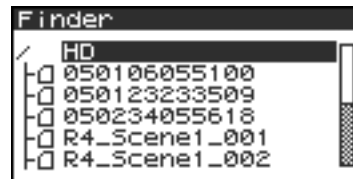

- 2 In the Finder screen, use the **[CURSOR] up/down** buttons or the **[SCRUB] dial** to select the desired project. Then press the **[ENTER]** button.

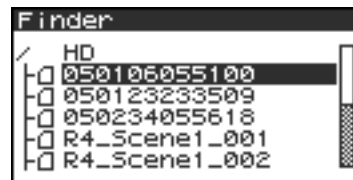

If the desired project is in a folder, the hard disk (HD), or the external memory device (EX), you can press the **[CURSOR] right** button to move into the selected folder (i.e., move to a lower-level folder).

If you want to move back to the upper-level folder, press the **[CURSOR] left** button.

- 3 When the screen at right is displayed, use the **[CURSOR] buttons** to select **1 Select**.

The project is selected, and you are returned to the Main screen.

Alternatively, with a project selected (step 2), you can press the **[PLAY] button** (instead of pressing the **[ENTER] button**) to play the selected project. You are returned to the Main screen when playback begins.

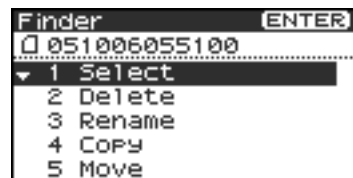

* Since you cannot directly play back projects from the external memory device, you cannot select them. You will have to copy the desired project to the R-4 Pro internal hard disk before you can select it.

Deleting a project (Delete)

- 1 While the Main screen is shown on the display, press the **[ENTER/FINDER]** button. The Finder screen shown in the figure is displayed.

Projects are shown in descending alphabetical order.

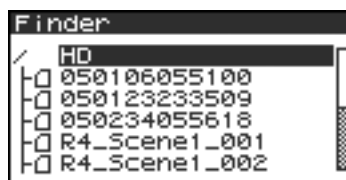

- 2 In the Finder screen, use the **[CURSOR]** up/down buttons or the **[SCRUB]** dial to select the project you want to delete. Then press the **[ENTER]** button.

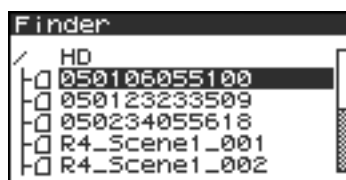

If the desired project is in a folder, the hard disk (HD), or the external memory device (EX), you can press the **[CURSOR]** right button to move into the selected folder (i.e., move to a lower-level folder). If you want to move back to the upper-level folder, press the **[CURSOR]** left button.

- * If you want to select the external memory device, select the hard disk (HD) and then press the **[CURSOR]** left button to show the external memory device (EX). However, if the external memory device is not mounted, it will not be displayed. See **Connection and removal** (p. 79)
- * Press the **[CURSOR]** right button after selecting EX to reference the external memory device contents.

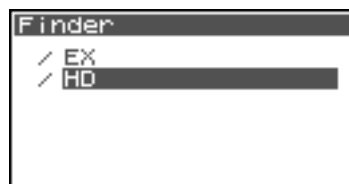

- 3 When the screen shown in the figure is displayed, use the **[CURSOR]** buttons to select **2 Delete**.

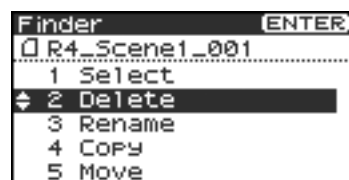

- 4 The screen shown in the figure is displayed. Press the **[ENTER]** button to execute the Delete operation.

- * If you decide to cancel without executing, press the **[EXIT]** button before you press the **[ENTER]** button.

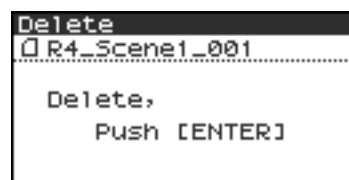

Do not turn off the power while a project is being deleted.



Renaming a project (Rename)

- While the Main screen is shown in the display, press the **[ENTER/FINDER]** button. The Finder screen shown in the figure is displayed.

Projects are shown in descending alphabetical order.

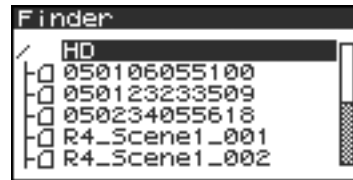

- In the Finder screen, use the **[CURSOR] up/down buttons** or the **[SCRUB] dial** to select the project you want to rename. Then press the **[ENTER]** button.

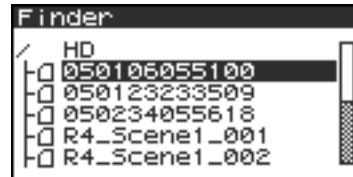

If the desired project is in a folder, the hard disk (HD), or the external memory device (EX), you can press the **[CURSOR] right button** to move into the selected folder (i.e., move to a lower-level folder). If you want to move back to the upper-level folder, press the **[CURSOR] left button**.

- * If you want to select the external memory device, select the hard disk (HD) and then press the **[CURSOR] left button** to show the external memory device (EX). However, if the external memory device is not mounted, it will not be displayed. See **Connection and removal** (p. 79)

- * Press the **[CURSOR] right button** after selecting EX to reference the external memory device contents.

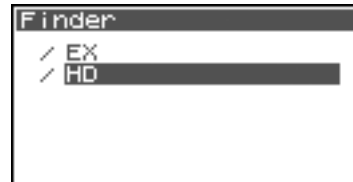

- When the screen shown in the figure is displayed, use the **[CURSOR] buttons** to choose **3 Rename**.

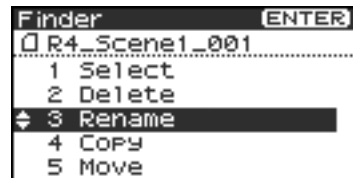

- Use the **[CURSOR] left/right buttons** to move the cursor through the characters of the project name or folder name shown in the display. Place the cursor on the character that you want to change, and then use the **[CURSOR] up/down buttons** or the **[SCRUB/VALUE] dial** to change the character.

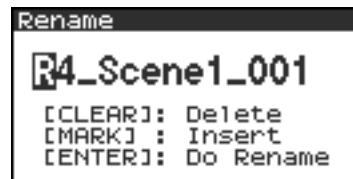

Use the **[CLEAR]** button to delete a character and the **[Mark]** button to insert a character. Use these buttons to edit the name as desired.

When finished editing the name, press the **[ENTER]** button.

- * If you decide to cancel without renaming, press the **[EXIT]** button before you press the **[ENTER]** button.

Do not turn off the power while a project is being renamed.



Copying a project (Copy)

- 1 While the Main screen is shown in the display, press the **[ENTER/FINDER]** button. The Finder screen shown in the figure is displayed.

Projects are shown in descending alphabetical order.

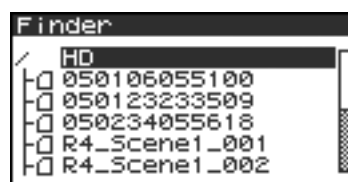

- 2 In the Finder screen, use the **[CURSOR]** up/down buttons or the **[SCRUB]** dial to select the copy source project (the project you want to copy). Then press the **[ENTER]** button.

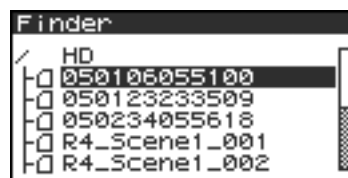

MEMO

If the desired project is in a folder, the hard disk (HD), or the external memory device (EX), you can press the **[CURSOR]** right button to move into the selected folder (i.e., move to a lower-level folder).

If you want to move back to the upper-level folder, press the **[CURSOR]** left button.

- * If you want to select the external memory device, select the hard disk (HD) and then press the **[CURSOR]** left button to show the external memory device (EX). However, if the external memory device is not mounted, it will not be displayed. See **Connection and removal** (p. 79)

- * Press the **[CURSOR]** right button after selecting EX to reference the external memory device contents.

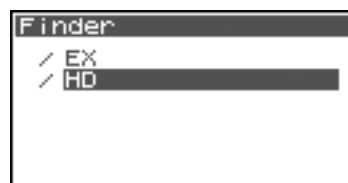

- 3 When the screen shown in the figure is displayed, use the **[CURSOR]** buttons to select **4 Copy**.

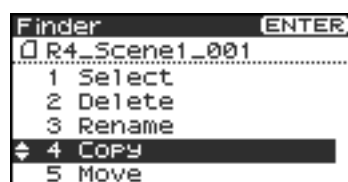

- 4 Use the **[CURSOR]** up/down buttons or the **[SCRUB/VALUE]** dial to select the copy destination folder (the folder to which you want to copy the project). Then press the **[ENTER]** button to execute the Copy operation. You can also select **HD** (hard disk) or **EX** (external memory device) as the copy destination,.



- * If you decide to cancel without copying, press the **[EXIT]** button.

Do not turn off the power while a project is being copied.

- * If the copy destination contains an identically named project, a number such as **-1** or **-2** is appended to the name of the copied project.

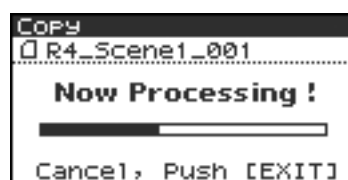

Moving a project (Move)

* You cannot move a project between the hard disk and an external memory device. If you need to do this, you can first copy the project, and then delete the copy source project.

- 1 While the Main screen is shown in the display, press the **[ENTER/FINDER]** button. The Finder screen shown in the figure is displayed.

Projects are shown in descending alphabetical order.

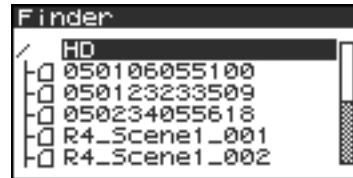

- 2 In the Finder screen, use the **[CURSOR]** up/down buttons or the **[SCRUB]** dial to select the project that you want to move. Then press the **[ENTER]** button.

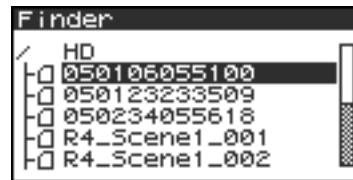

If the desired project is in a folder, the hard disk (HD), or the external memory device (EX), you can press the **[CURSOR]** right button to move into the selected folder (i.e., move to a lower-level folder).

If you want to move back to the upper-level folder, press the **[CURSOR]** left button.

- * If you want to select the external memory device, select the hard disk (HD) and then press the **[CURSOR]** left button to show the external memory device (EX). However, if the external memory device is not mounted, it will not be displayed. See **Connection and removal** (p. 79)
- * Press the **[CURSOR]** right button after selecting EX to reference the external memory device contents.

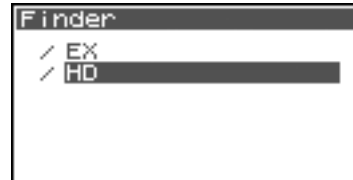

- 3 When the screen shown in the figure is displayed, use the **[CURSOR]** buttons to select **5 Move**.



- 4 Use the **[CURSOR]** up/down buttons or the **[SCRUB/VALUE]** dial to select the destination folder (the folder to which you want to move the project). Then press the **[ENTER]** button to execute the Move operation. You can also select HD (hard disk) as the destination.

* If you decide to cancel without moving, press the **[EXIT]** button.

Do not turn off the power while a project is being moved.



Creating a new folder (Make Folder)

- 1 While the Main screen is shown in the display, press the **[ENTER/FINDER]** button. The Finder screen shown in the illustration will appear.

Projects are shown in descending alphabetical order.

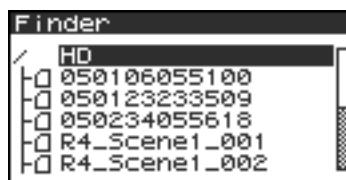

- 2 In the Finder screen, use the **[CURSOR]** up/down buttons or the **[SCRUB]** dial to select **HD** (hard disk) located at the top level.

Then press the **[ENTER]** button.

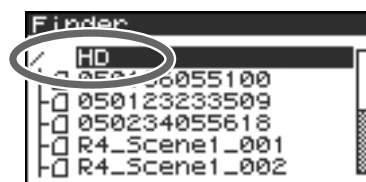

MEMO

If the desired project is in a folder, the hard disk (HD), or the external memory device (EX), you can press the **[CURSOR]** right button to move into the selected folder (i.e., move to a lower-level folder).

If you want to move back to the upper-level folder, press the **[CURSOR]** left button.

- * If you want to select the external memory device, select the hard disk (HD) and then press the **[CURSOR]** left button to show the external memory device (EX). However, if the external memory device is not mounted, it will not be displayed. See **Connection and removal** (p. 79)

- * Press the **[CURSOR]** right button after selecting EX to reference the external memory device contents.

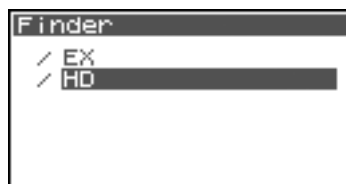

- 3 When the screen shown in the figure is displayed, use the **[CURSOR]** buttons to select **2 Make Folder**.

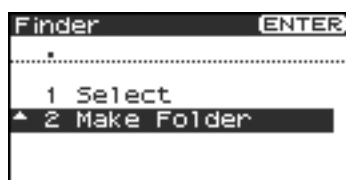

- 4 When the screen shown in the figure is displayed, press the **[ENTER]** button to confirm the operation.

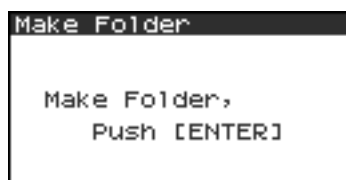

Do not turn off the power while a folder is being created.



- 5 A folder named NewFolder is created.

Projects are shown in alphabetical order, and folders are shown in alphabetical order after the projects.

Use the **[CURSOR] up/down** or the **[SCRUB] dial** to verify that the new folder was created.

If an identically named folder already exists, a number will be added to the name of the newly created folder, e.g., NewFolder-1, NewFolder-11, NewFolder-111, etc.



Editing

You can edit the projects that you have recorded with the R-4 Pro directly on the R-4 Pro.

No.	Editing command	Operation	See
1	Trim	Creates a new project from a region extracted between two specified points in a waveform.	p. 51
2	Divide	Creates two new projects by dividing the project at a specified point in a waveform.	p. 53
3	Combine	Appends a project to the end of the currently selected project. The two files are joined to create a single new file.	p. 55
4	Merge	Merges a project consisting of multiple files into a single channel.	p. 57

* Executing any of these editing commands leaves the original project file unchanged.

* There is no Undo function.

Editing procedure

Trim

This command extracts the region between the two points you specify in the waveform and creates a new project from the extracted region.

Playback, stop, scrub dial, shuttle dial, and marker operations may be performed even while using this command. However, operations related to A-B Repeat cannot be performed.

1 Press the R-4 Pro **[WAVE EDIT]** button. The Wave Edit Menu screen is shown in the display.



2 Use the **[CURSOR]** buttons to select **1 Trim**, and press the **[ENTER]** button.

The editing screen shown at the right is displayed.

Time axis zoom (1/1-1/65536)

Adjust with the **[CURSOR]** left/right buttons

Waveform level zoom (x1-x64)

Adjust with the **[CURSOR]** up/down buttons

* If you decide not to adjust the settings, press the **[EXIT]** button.

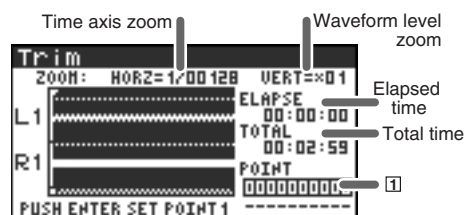

3 While playing or fast-forwarding, press the **[ENTER]** button when you reach the beginning (point [1]) of the region you want to extract.

Alternatively, you can use the scrub dial or shuttle dial to specify the point instead of doing so during playback.

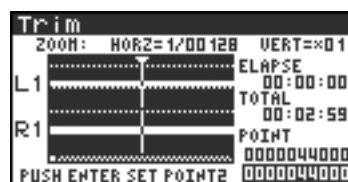

* The value of point [1] is displayed as a location in the sample (data).

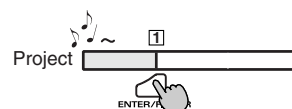

- 4 In the same way, move to the end (point 2) of the region you want to extract, and press the **[ENTER]** button.

* The value of point 2 is displayed as a location in the sample (data).

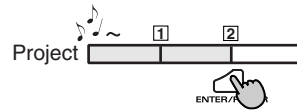
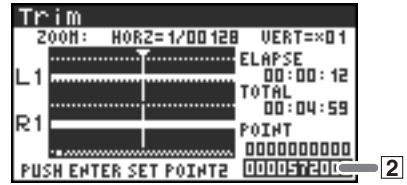

- 5 A screen asking you to confirm the specified points is shown.

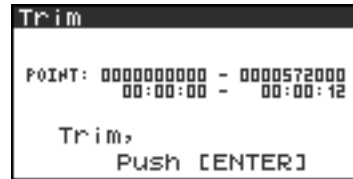

If you are satisfied with the points you specified, press the **[ENTER]** button to confirm the settings. If you decide to try again, you can press the **[EXIT]** button once and re-specify the end of the region (point 2). You can then press the **[EXIT]** button once again and re-specify the beginning of the region (point 1). Even when the screen shown at the right is displayed, you can cancel the process by pressing the **[EXIT]** button.

* Do not turn off the power while a project is being saved or while a process is running.



- 6 The extracted region is saved as a new project with the same name as the original project but with "-1" appended to it. The original project remains unchanged.

For example, if the original project is named **Project**, the new project is named **Project-1**.

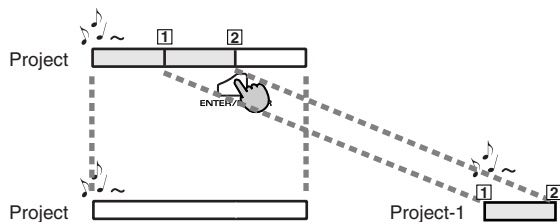

If the internal hard disk does not have enough space to save the project, a "Media Full!" message is shown.

Divide

This command divides a project at the point you specify in the waveform. Two new projects are created. Playback, stop, scrub dial, shuttle dial, and marker operations may be performed even while using this command. However, you cannot perform A-B Repeat operations.

1 Press the R-4 Pro **[WAVE EDIT]** button. The Wave Edit Menu screen is shown in the display.

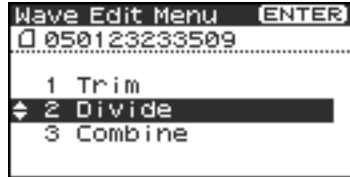

2 Use the **[CURSOR]** buttons to select **2 Divide**, and press the **[ENTER]** button.

The editing screen shown at the right is displayed.

Time axis zoom (1/1-1/65536)

Adjust with the **[CURSOR]** left/right buttons.

Waveform level zoom (x1-x64)

Adjust with the **[CURSOR]** up/down buttons.

* If you decide not to adjust the settings, press the **[EXIT]** button.

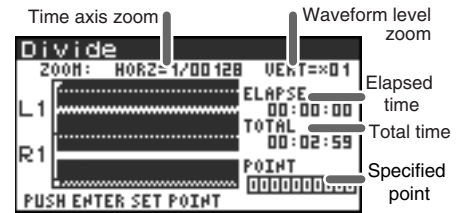

3 While playing or fast-forwarding, press the **[ENTER]** button when you reach the point at which you want to divide the project.

Alternatively, you can use the scrub dial or shuttle dial to specify the point instead of doing so during playback.

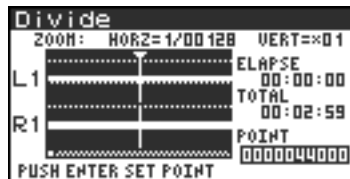

4 A screen asking you to confirm the specified point will appear.

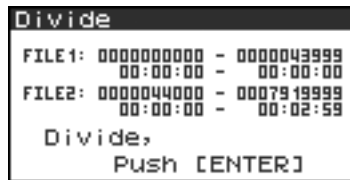

If you are satisfied with the point you specified, press the **[ENTER]** button to confirm the settings. If you decide to cancel Divide, press the **[EXIT]** button.

Even when the screen shown at the right is displayed, you can cancel the process by pressing the **[EXIT]** button.

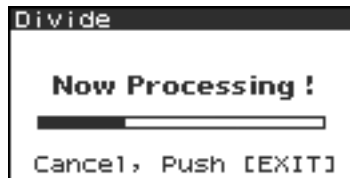

* Do not turn off the power while a project is being saved or while a process is running.

* It may take some time to save the project if it contains a large amount of data.

- 5 The divided project is saved as two new projects with the same name as the original project but with “-1” and “-2” appended to the names. The original project remains unchanged.

For example, if the original project is named **Project**, the new projects is named **Project-1** and **Project-2**.

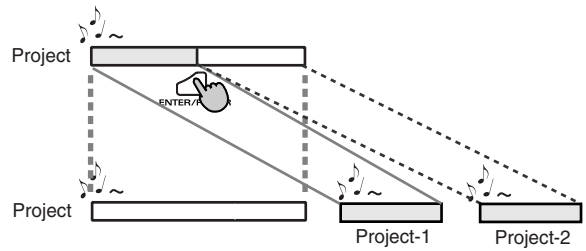

Media Full!

If the internal hard disk does not have enough space to save the project, a “**Media Full!**” message is shown.

Combine

This command appends another project (of the same format) onto the end of the currently selected project. The two files are joined to create a single new file.

You cannot perform playback, stop, or operate the scrub dial or shuttle dial while using this command.

- 1 Select the project (the “base project”) to which you want to append another project.

In the Main screen, use the **[NEXT]** button or **[PREV]** button to select the desired project. Alternatively, you can use the cursor buttons in the Finder screen.

- 2 Press the R-4 Pro **[WAVE EDIT]** button. The display shows the Wave Edit Menu screen.



- 3 Use the **[CURSOR]** buttons to select **3 Combine**, and press the **[ENTER]** button.

The display shows an editing screen like the one at right.

* If you decide to cancel the operation, press the **[EXIT]** button.

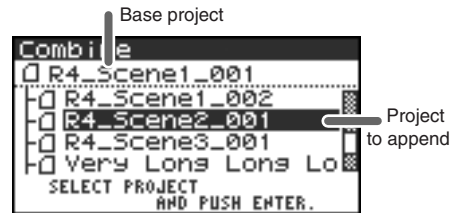

- 4 Use the **[CURSOR]** buttons to select the project that you want to append, and press the **[ENTER]** button.

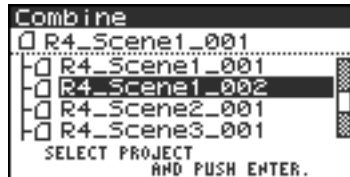

If you decide to cancel the operation, press the **[EXIT]** button. Even when the screen shown at the right is displayed, you can cancel the process by pressing the **[EXIT]** button.

* Do not turn off the power while a project is being saved or while a process is running.

* It may take some time to save the project if it contains a large amount of data.

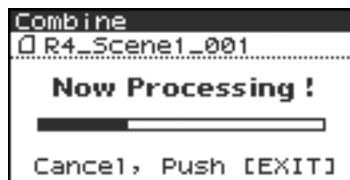

The “base project” and the “project to be appended” must have the same sampling frequency, sample size (bit depth), and number of channels.



If you select a project that cannot be appended, a “Improper Proj.” message is shown.

- 5 The combined projects are saved as a new project with the same name as the original project but with “-1” appended to it. The original project remains unchanged.

For example, if the original project is named **Project**, the new project is named **Project-1**.

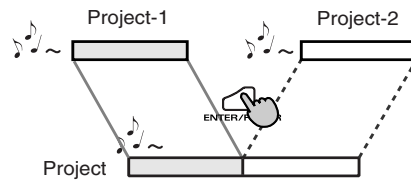

Media Full!

If the internal hard disk does not have enough space to save the project, a “**Media Full!**” message is shown.

Merge

If the currently selected project consists of multiple files (MONO x2, MONO x3, MONO x4, STEREO x2), this command merges them into a single channel.

How Rec Mode will change

Before Merge	After Merge
MONOx2	MONOx1
MONOx3	
MONOx4	
STEREOx2	STEREOx1

* Since MONO x1, STEREO x1, or 4 ch. projects cannot be merged, the Merge command does not appear in the menu when selecting these projects.

1 Press the R-4 Pro **[WAVE EDIT]** button. The Wave Edit Menu screen is shown.



2 Use the **[CURSOR]** buttons to select **4 Merge**, and press the **[ENTER]** button.

The editing screen shown at right is displayed.

If you want to adjust the level (Mix Level) of the channels in the project, you can do so. Use the **[CURSOR] up/down** buttons or the **[SCRUB] dial** to specify the value.

For example, in a stereo two-channel project (STEREO x2), you might set the Mix Level to -6.0 dB so that the level of each channel will be lowered by 6 dB when they are merged.

* If you decide to cancel the settings, press the **[EXIT]** button.

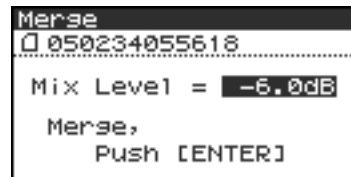

3 If you are satisfied with the settings, press the **[ENTER]** button to confirm.

If you decide not to cancel Merge, press the **[EXIT]** button. Even when the screen shown at the right is displayed, you can cancel the process by pressing the **[EXIT]** button.



* Do not turn off the power while a project is being saved or while a process is running.

* It may take some time to save the project if it contains a large amount of data.



Media Full!

If the internal hard disk does not have enough space to save the project, a **"Media Full!"** message is shown.

Edit Timecode

This command changes the timecode for the data recorded in BWF format.

* *The Edit Timecode screen does not display for non-BWF formatted data.*

- 1 Press the R-4 Pro **[WAVE EDIT]** button. The Wave Edit Menu screen is shown.



- 2 Use the **[CURSOR]** buttons to select *Edit Timecode*, and press the **[ENTER]** button.

A edit screen as shown in the figure is displayed.

- 3 Use the **[CURSOR]** button to select the input location, and then set the timecode with the **[SCRUB/VALUE]** dial.

* *H:M:S:F: indicates Hours: Minutes: Seconds: Frames, respectively. The F value differs according to the Frame Rate value in the timecode Setup.*

* *To cancel the settings, press the **[EXIT]** button.*

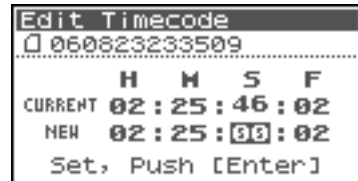
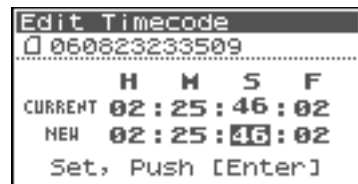

- 4 If you are satisfied with the settings, press the **[ENTER]** button to confirm.

* *Do not turn off the power while a project is being saved or while a process is running.*

* *It may take some time to save the project if it contains a large amount of data.*



Effects settings

The R-4 provides five types of effects. You can apply an effect to the incoming sound as it is being recorded, or you can apply an effect to the playback. You can also change the effect settings for each channel.

* *Effects are not available when the R-4 Pro is operating at 96 kHz.*

Effect types provided on the R-4 Pro

No.	Effect name	Effect
0	No Effect	No effects are applied. Use this setting if you want to preserve the effect on/off setting of each channel but do not want an effect to be applied.
1	3-Band EQ	This is a three-band equalizer.
2	Graphic EQ	You can adjust the gain of six fixed-frequency bands.
3	Noise Gate	This effect minimizes the noise that might be heard in silent regions as well as low-frequency noise.
4	Enhancer	By adding a phase-shifted sound to the direct sound, this effect sharpens the definition of the sound and pushes it toward the foreground.
5	Comp&DeEsser	This cuts the sibilance that can be obtrusive in a vocal, making the sound smoother. It also reduces the difference between loud and soft sounds, making the level more consistent. A compressor evens out the level differences between loud and soft sounds. A de-esser reduces the unpleasant sibilance (exaggerated “s” sound) that is sometimes present in a vocal.
6	MS-Mic	Converting sound recorded on a MS (Mid-Side type) mic to stereo.

If you apply an effect while recording, the volume and tone of the recorded sound will be different than the original sound.

Before applying an effect aggressively during recording, it is a good idea to monitor the sound through headphones in recording standby mode to make sure that the sound is not clipped or distorted. It is also a good idea to make a test recording beforehand with those settings.

For details on the procedure, refer to “**Effects settings**” (p. 59).

If the **[EFFECT]** button is pressed during recording or playback, the effect is toggled on/off. To prevent unintentionally switching an effect on or off, we recommend turning the **HOLD switch** on.

? What is an effect?

On the R-4 Pro, an “effect” is a process that digitally transforms the sound, giving it greater clarity or impact.

Effects can also make the sound more intelligible or reduce undesirable noise.

? What is clipping?

Applying an effect or boosting the level may increase the sound level (volume) beyond the maximum that a device can handle; this occurrence is called clipping. Loud sounds may be accompanied by distortion or crackly noises.

? The MS mic

The MS mic creates stereo sound by combining sound from a main mic that records central sounds (mid-signal: M) and a bi-directional mic that records lateral sounds (side signal: S).

Applying effects

You can adjust the R-4 Pro effects not only while standing-by for recording or playback, but also while you listen to the sound during actual playback or recording. This section explains how to adjust the effect settings while playing back or in recording standby mode.

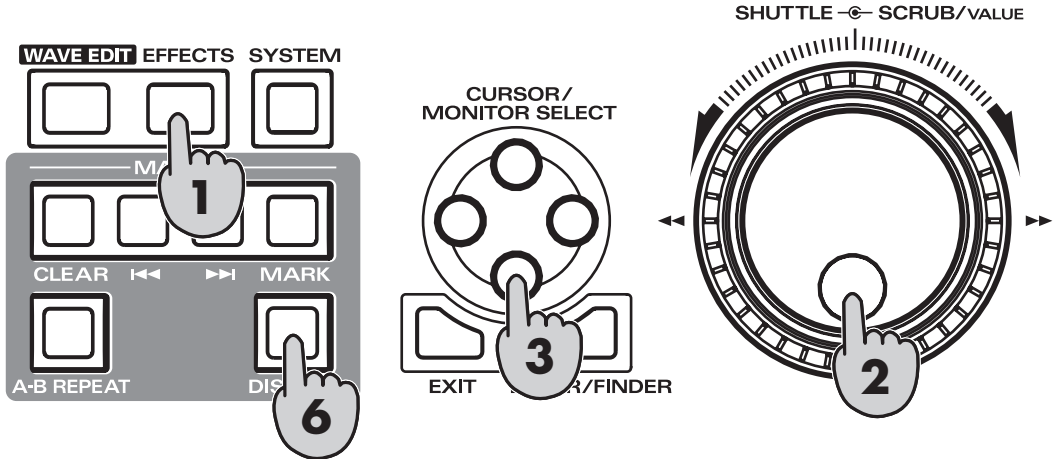

1 Press the R-4 Pro **[EFFECTS]** button.

The Effects setup screen is shown in the display.

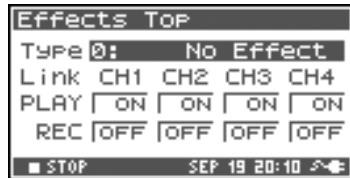

2 Use the **[SCRUB/VALUE]** dial to select the desired effect type.

For details on each effect type, see to **"Effects"** (p. 62).

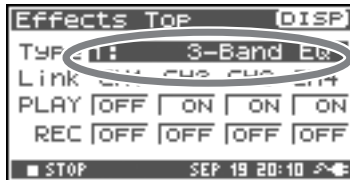

3 Press the **[CURSOR]** down button. The cursor will move to the "Link" field.

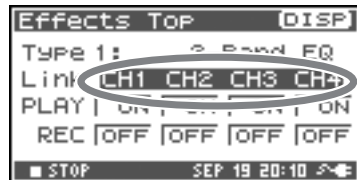

CH1 CH2 CH3 CH4	The effect on/off setting and effect parameters are set independently for each channel.
CH1+2 CH3+4	The effect on/off setting and effect parameters are linked for channels 1 and 2 and for channels 3 and 4. Choose this setting if the project uses channels 1 and 2 and channels 3 and 4 as stereo pairs.
CH1+2+3+4	The effect on/off setting and effect parameters are linked for all channels.

- 4 Use the **[SCRUB/VALUE]** dial to specify the channels to be linked.

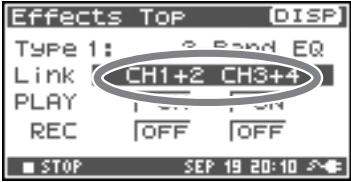

- 5 In the same way, set the "PLAY" and "REC" fields.

PLAY

OFF	The effect are not applied during playback
ON	The effect are applied during playback

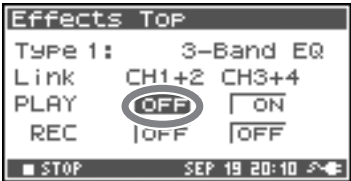

REC

OFF	The effect are not applied during recording
ON	The effect are applied during recording

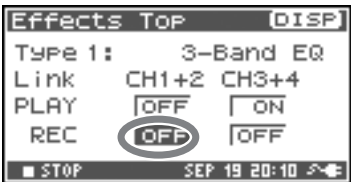

- 6 Press the **[DISPLAY]** button.

The effect parameter screen is shown on the display.
 * The effect parameter screen does not appear when 0: No Effect is selected as the type.

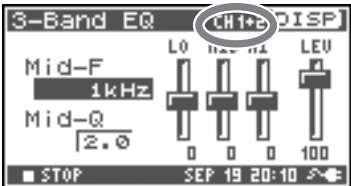

- 7 Use the **[CURSOR]** buttons and the **[SCRUB/VALUE]** dial to set each effect parameter.

- 8 If you selected "CH1 CH2 CH3 CH4" or "CH1+2 CH3+4" in the "Link" field, press the **[DISPLAY]** button.

The next channel (or pair of channels) will appear in the display.

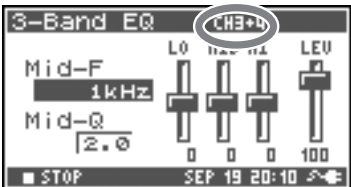

While setting effect parameters, you can return to the previous screen by pressing the **[EXIT]** button. The effect settings you make are stored until you change them. However, if you change the effect type (Type), the settings you made are reset to the default values.

- 9 When finished setting the effect parameters, press the **[EXIT]** button to return to the Main screen.

Each effect has various parameters that you can adjust to alter the character of the effect. The settings you make are stored even when the R-4 Pro power is switched off. However, if you change the effect type, these settings are reset to the default values.

Effects

1: 3-Band EQ

No.	Parameter name	Range of values	Default values	Explanation
1	MID-F	200Hz, 250Hz, 315Hz, 400Hz, 500Hz, 630Hz, 800Hz, 1kHz, 1.25Hz, 1.6kHz, 2kHz, 2.5kHz, 3.15kHz, 4kHz, 5kHz, 6.3kHz	1kHz	Specifies the center frequency of the mid-range equalizer.
2	MID-Q	0.5, 1.0, 2.0, 4.0, 8.0	2.0	Sets the range of the region centered on the Mid Freq for which the gain will change. Higher Q settings narrow the region in which the change occurs.
3	LOW	-12dB-0dB+12dB	0dB	Adjusts the gain of the low-range equalizer.
4	MID	-12dB-0dB+12dB	0dB	Adjusts the gain of the mid-range equalizer.
5	HIGH	-12dB-0dB+12dB	0dB	Adjusts the gain of the high-range equalizer.
6	LEVEL	0 - 120	100	Adjusts the overall volume.

2: Graphic EQ

No.	Parameter name	Range of values	Default values	Explanation
1	125Hz	-12dB-0dB+12dB	0dB	Adjusts the gain at 125 Hz.
2	250Hz	-12dB-0dB+12dB	0dB	Adjusts the gain at 250 Hz.
3	500Hz	-12dB-0dB+12dB	0dB	Adjusts the gain at 500 Hz.
4	1kHz	-12dB-0dB+12dB	0dB	Adjusts the gain at 1 kHz.
5	2kHz	-12dB-0dB+12dB	0dB	Adjusts the gain at 2 kHz.
6	4kHz	-12dB-0dB+12dB	0dB	Adjusts the gain at 4 kHz.
7	Level	0-120	100	Adjusts the overall volume.

3: Noise Gate

No.	Parameter name	Range of values	Default values	Explanation
1	LO-CUT	OFF, 40Hz, 55Hz, 63Hz, 80Hz, 100Hz, 125Hz, 160Hz, 200Hz, 250Hz, 315Hz, 400Hz, 500Hz, 630Hz, 800Hz, 1kHz	100Hz	Cuts unwanted low-frequency noise such as wind.
2	THRESHOLD	OFF, 1-100	20	Specifies the volume threshold below which the sound will be cut.
3	LEVEL	0-120	100	Adjusts the overall volume.

4: Enhancer

No.	Parameter name	Range of values	Default values	Explanation
1	SENSE	0–100	50	Adjusts the sensitivity of the enhancer effect.
2	MIX	0–100	50	Adjusts the amount of phase-shifted sound that is to be mixed with the input.
3	LEVEL	0–120	100	Adjusts the overall volume.

5: Comp&DeEsser

No.	Parameter name	Range of values	Default values	Explanation
1	DE-ESSER	OFF, ON	ON	Turn this ON to reduce unpleasant sibilance.
2	THRESHOLD	0–100	50	Sets the volume (threshold level) at which the compressor begins to operate. Compression is applied to the input when it exceeds this level. Lower threshold settings mean that the compressor is applied even at lower levels.
3	RATIO	1.0:1, 1.2:1, 1.5:1, 2.0:1, 2.8:1, 4.0:1, 8.0:1, 16.0:1, Inf:1	4.0:1	Adjusts the ratio at which the sound is compressed when the input exceeds the threshold level. Higher ratios mean that the sound is compressed more strongly.
4	ATTACK	0.25–100ms	10ms	Adjusts the time over which the amount of compression specified by Ratio is reached once compression is triggered when the input exceeds the threshold level. Higher Attack settings mean that compression is applied more slowly.
5	RELEASE	50–5000ms	100ms	Adjusts the time until compression is released once the input falls below the threshold level. Higher Release settings mean that the sound reverts to its uncompressed state more slowly.
6	GAIN	-6.0dB–+18.0dB (The value will change in steps of 0.5dB)	0.0dB	Adjusts the gain following compression.
7	LEVEL	0–120	100	Adjusts the overall volume.

6: MS-Mic

No.	Parameter name	Range of values	Default values	Explanation
1	Wide	0–100	80	Adjusts sound dispersion.
2	Level	0–120	100	Adjusts the overall volume.

* You can adjust the stereo dispersion during recording or playback. This case is limited to MS mics that can directly output the mid and side signals. Connect the mid-signal to CH1 (CH3) and the side signal to CH2 (CH4).

System setup

You can make settings related to the R-4 Pro system when performing initial settings for recording or playback. Press the R-4 Pro **[SYSTEM] button** to enter the system setup menu. See “**Example operations**” (p. 65) for setup procedures.

No.	Menu item	Summary	See
1	Recording Setup	Allows you to make recording settings.	p. 65
2	Player Setup	Allows you to make playback settings.	p. 65
3	Speaker	Turns the speaker on/off.	p. 65
4	LCD Setup	Allows you to make display settings.	p. 65
5	System Setup	Allows you to make settings to specify how the R-4 Pro operates.	p. 65
6	Timecode	Allows you to make settings to specify how the Timecode operates.	p. 67
7	Date & Time	Allows you to set the date and time of the R-4 Pro internal calendar. You can specify the year, month, and date (day).	p. 67
8	Project Name	The R-4 Pro automatically assigns a name to project files that are created when recording. You can set how this name will be assigned.	p. 68
9	HDD Utility	Allows you to perform utility operations on the R-4 Pro internal hard disk.	p. 69
10	USB Utility	Allows you to perform utility operations on the external memory device connected to the R-4 Pro.	p. 69
11	Factory Reset	Restores the R-4 Pro to the factory default settings.	p. 71

Example operations

Recording Setup settings

You can use the same procedure to make the settings listed below. As an example, we will show how to make **Recording Setup** settings.

Recording Setup
Player Setup
Speaker
LCD Setup
System Setup

- 1 Press the R-4 Pro **[SYSTEM]** button.

The System Menu screen is shown in the display.



- 2 Use the **[CURSOR]** buttons to choose **1 Recording Setup**, and press the **[ENTER]** button.

The Recording Setup screen is shown.



- 3 Use the **[SCRUB/VALUE]** dial to choose the **Input Select** value.

The setting is applied as soon as you select it.
 You do not need to press the **[ENTER]** button.

- 4 Use the **[CURSOR]** buttons to select **Rec Freq.**

- 5 Use the **[SCRUB/VALUE]** dial to select the **Rec Freq.** value.



- 6 In the same way, use the **[CURSOR]** buttons and the **[SCRUB/VALUE]** dial to select and set the remaining items.

- 7 When finished making settings, press the **[EXIT]** button.

You are returned to the System Menu screen.

- 8 Press the **[EXIT]** button once again to return to the Main screen.

If you want to make other system settings, use the **[CURSOR]** buttons to select the desired menu item.

Timecode settings

- 1 Press the R-4 Pro **[SYSTEM]** button.

The System Menu screen is shown in the display.



- 2 Use the **[CURSOR]** buttons to select **6 Timecode**, and press the **[ENTER]** button.

The Recording Setup screen is shown.



- 3 Use the **[CURSOR]** buttons to select **1 Setup**, and press the **[ENTER]** button.

The Recording Setup screen is shown.

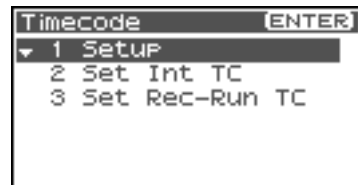

- 4 Use the **[SCRUB/VALUE]** dial to select the **Mode** value.

The setting is applied as soon as you select it.
You do not need to press the **[ENTER]** button.

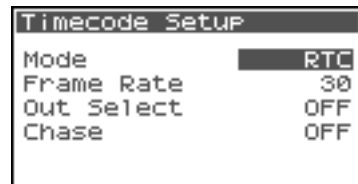

- 5 Use the **[CURSOR]** buttons to select the **Frame Rate**.

- 6 Use the **[SCRUB/VALUE]** dial to select the **Frame Rate** value.

- 7 In the same way, use the **[CURSOR]** buttons and the **[SCRUB/VALUE]** dial to choose and set the remaining items.

- 8 When finished making settings, press the **[EXIT]** button twice.

You are returned to the System Menu screen.

- 9 Press the **[EXIT]** button once again to return to the Main screen.

If you want to make other system related settings, use the **[CURSOR]** buttons to select the desired menu item.

* Please set Pre Recording to OFF when recording using timecode. If Pre Recording is set, then the timecode will not match.

* If the **[PAUSE]** button is pressed during recording, the timecode will not match during playback. Please exercise caution.

Date & Time settings

- 1 Press the R-4 Pro **[SYSTEM]** button.
The System Menu screen is shown in the display.



- 2 Use the **[CURSOR]** buttons to select **7 Date & Time**, and press the **[ENTER]** button.
The Date & Time screen is shown.

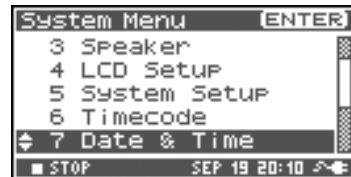

- 3 Use the **[CURSOR]** buttons and the **[SCRUB/VALUE]** dial to set the date and time.

When finished making settings, press the **[EXIT]** button.
You are returned to the System Menu screen.

* If you decide to cancel, press the **[EXIT]** button.

- 4 Press the **[EXIT]** button once again to return to the Main screen.

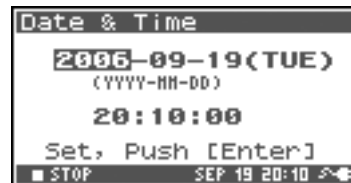

If you want to make other system related settings, use the **[CURSOR]** buttons to select the desired menu item.

Project Name settings

- 1 Press the R-4 Pro **[SYSTEM]** button.
The System Menu screen is shown in the display.



- 2 Use the **[CURSOR]** buttons to select **8 Project Name**, and press the **[ENTER]** button.
The Project Name screen is shown.

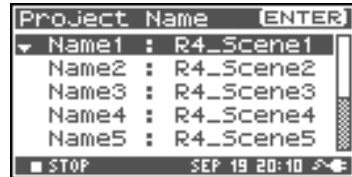

- 3 Use the **[CURSOR]** buttons to select the name you want to edit, and press the **[ENTER]** button.
A screen for editing the project name is shown.

- 4 Use the **[CURSOR]** buttons, **[SCRUB/VALUE]** dial, **[CLEAR]** button, and **[MARK]** button to edit the name.

When finished, press the **[ENTER]** button.
You are returned to the Project Name screen.

* If you decide to cancel, press the **[EXIT]** button.

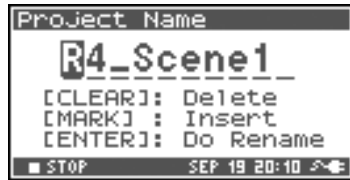

Available characters

(space) !#\$%&'()+,-.01234546789;=@

ABCDEFGHIJKLMNOPQRSTUVWXYZ[]^_`abcdefghijklmnopqrstuvwxyz{}

- 5 Press the **[EXIT]** button once again to return to the Main screen.

If you want to make other system related settings, use the **[CURSOR]** buttons to select the desired menu item.

Using the HDD Utility

- 1 Press the R-4 Pro **[SYSTEM]** button.

The System Menu screen is shown in the display.



- 2 Use the **[CURSOR]** buttons to select **9 HDD Utility**, and press the **[ENTER]** button.

The HDD Utility screen is shown.

* If you decide to cancel, press the **[EXIT]** button.

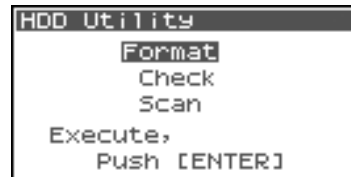

- 3 Use the **[CURSOR]** buttons to select either "Format" or "Check," and press the **[ENTER]** button.

- 4 The display displays the "Are you sure?" confirmation message. Use the **[CURSOR]** buttons to select "Yes" if you are sure you want to execute or "No" if you decide to cancel without executing.

Then press the **[ENTER]** button.

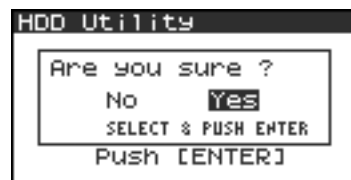

The message shown at right is shown during processing.
Do not turn off the power during processing.

When processing has completed, you will automatically return to the System Menu screen.

- 5 Press the **[EXIT]** button once again to return to the Main screen.

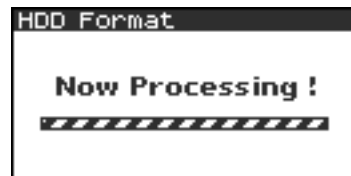

If you want to make other system related settings, use the **[CURSOR]** buttons to select the desired menu item.

Using the USB Storage Utility

- 1 Press the R-4 Pro **[SYSTEM]** button.

The System Menu screen is shown in the display.

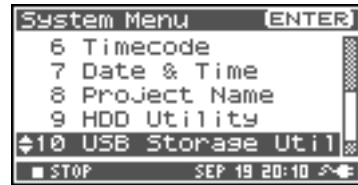

- 2 Use the **[CURSOR]** buttons to select **10 USB Storage Utility**, and press the **[ENTER]** button.

When the connection to an external memory device is not mounted, the USB Storage Utility starts as shown in the figure to the right.

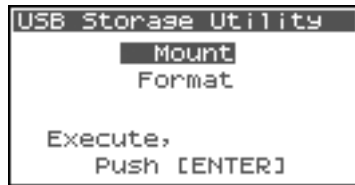

* A connected external memory device cannot not be loaded if it is not mounted.

When the connection to an external memory device is mounted, the USB Storage Utility starts as shown in the figure to the right.

* If you decide to cancel, press the **[EXIT]** button.



* If no external memory device is inserted, the message shown at right is shown.

- 3 Select one of the following with the **[CURSOR]** button and select by pressing the **[ENTER]** button.

when not mounted	Moun	Format	
when mounted	Unmount	Format	Check



- 4 The display displays the “Are you sure?” confirmation message. Use the **[CURSOR]** buttons to select “Yes” if you are sure you want to execute or “No” if you decide to cancel without executing.

Then press the **[ENTER]** button.

The message shown at right is shown during processing. Do not turn off the power during processing.



When processing has completed, you will automatically return to the System Menu screen.

- 5 Press the **[EXIT]** button once again to return to the Main screen.

If you want to make other system related settings, use the **[CURSOR]** buttons to select the desired menu item.



Executing Factory Reset (Restoring the factory default settings)

- 1 Press the R-4 Pro **[SYSTEM]** button.

The System Menu screen is shown in the display.



- 2 Use the **[CURSOR]** buttons to select **11 Factory Reset**, and press the **[ENTER]** button.

The Factory Reset screen is shown.

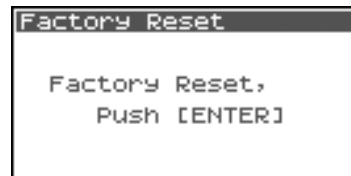

- 3 Press the **[ENTER]** button if to perform Factory Reset.

* If you decide to cancel, press the **[EXIT]** button.

- 4 The display displays the “Are you sure?” confirmation message. Use the **[CURSOR]** buttons to select “Yes” if you are sure you want to execute or “No” if you decide to cancel without executing.

Then press the **[ENTER]** button.

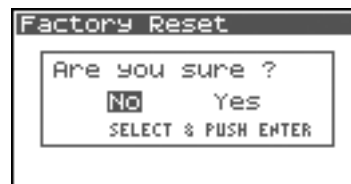

When processing has completed, you will automatically return to the System Menu screen.

- 5 Press the **[EXIT]** button once again to return to the main screen.

If you want to make other system related settings, use the **[CURSOR]** buttons to select the desired menu item.

System Menu

1 Recording Setup

The values in boldface are the default values.

* You cannot make Recording Setup settings during recording or playback.

Menu item	Value	Function
Input Select	Analog	This selects the type of input. Choose this setting if you want to record analog input. Connect your mic or analog audio device to the XLR input connectors . With this setting, any input from the internal mics or the digital input jack is ignored.
	Digital	Choose this setting if you want to record digital input. The signal from a digital device connected to the digital input connector is recorded. With this setting, any input from the internal mics or the XLR input connectors is ignored. The sampling frequency is specified by the Rec Freq. setting, and the bit depth by the Rec Bit setting.
	Dig + Ana	Choose this setting if you want to simultaneously record digital and analog input. The signal from the digital device connected to the digital input connector and the signal from the mic or analog audio device connected to the XLR input connectors are recorded simultaneously. For these settings, the digital input is on channels 1 and 2. Use channels 3 and 4 for the analog input. This cannot be selected when the Rec Freq is 192 kHz. This setting cannot be selected when the Rec Freq is set to 192 kHz.
	IntMic	Choose this setting if you want to record via the internal mics. LIMITER and sensitivity are invalid. This setting cannot be selected when the Rec Freq is set to 192 kHz.
	Int + Ana	Choose this setting if you want to simultaneously record from the internal mics and analog input. MIC-L is on channel 1, and MIC-R is on channel 2. Use channels 3 and 4 for the analog input. LIMITER and sensitivity are invalid. This setting cannot be selected when the Rec Freq is set to 192 kHz.
Rec Freq.	44.1 kHz , 448.0 kHz, 88.2kHz 96 kHz 192kHz	This sets the sampling frequency for recording. Higher sampling frequencies allow higher-quality recording but produce larger project files, meaning that there will be less available recording time on the hard disk. The 44.1 kHz setting is sufficient when recording audio that falls within the normally audible range. This frequency is also the most suitable to use if you are going to load the recorded file into your computer and create a music CD from it. You can use the higher frequency settings when recording audio that contains a significant amount of high-frequency content, from instruments such as cymbals, or when you want to capture the brightness and transparency of a natural environment.
Rec Bit	16 bit , 24 bit	This sets the sample size (bit depth) for recording. A larger sample size allows the sound to be captured in greater detail but produces a larger project file, meaning that there will be less available recording time on the hard disk. Use the 16-bit setting for normal recording. This setting allows the broadest compatibility when loading the recorded file into your computer for playback. Use the 24-bit setting if you want to capture the tonal character and ambience in greater detail, such as when recording an instrumental or vocal performance.

Menu item	Value	Function																																																	
Rec Mode	MONOx1	One-channel recording to one monaural file	<p>This selects the structure of the project file that is created during recording. A monaural WAV file will be created for each channel. Choose these settings if you are using a separate mic for the vocal and performance or each speaker in a conversation, so that a separate file is created for each channel. These settings create monaural WAV files. If Input Select is set to Analog, you can create up to four monaural files. If Input Select is set to IntMic or Digital, you can create up to two monaural files.</p> <p>* You cannot select MONO x3, MONO x4, or STEREO x2 if Input Select is set to IntMic or Digital.</p> <p>* You cannot select MONO x3 or MONO x4 if Rec Freq. is set to 88.2kHz, 96 kHz, or 192kHz.</p>																																																
	MONOx2	Two-channel recording to two monaural files																																																	
	MONOx3	Three-channel recording to three monaural files																																																	
	MONOx4	Four-channel recording to four monaural files																																																	
	STEREOx1	Two-channel recording to one stereo file	<p>Two channels are recorded as L and R to create a stereo WAV file.</p> <p>If Input Select is set to Analog, one stereo WAV file with channel 1 as L and channel 2 as R is created. The inputs to channels 3 and 4 are ignored. If Input Select is set to IntMic or Digital, one stereo WAV file is created.</p>																																																
	STEREOx2	Four-channel recording to two stereo files	<p>If Input Select is set to Analog, a stereo file with channel 1 as L and channel 2 as R is created, and another stereo file with channel 3 as L and channel 4 as R is also created.</p> <p>* When Input Select is set to either IntMic or Digital or when Rec Freq. is set to 192 kHz, STEREO x 2 cannot be selected.</p>																																																
4CHx1	Four-channel recording to one four-channel file	<p>Channels 1–4 will be recorded as a single WAV file. Be aware that not all computer software can handle four-channel WAV files.</p> <p>* When Input Select is set to either IntMic or Digital or when Rec Freq. is set to 192 kHz, 4CH x 1 cannot be selected.</p>																																																	
		<table border="1"> <thead> <tr> <th></th> <th>MONOx1</th> <th>MONOx2</th> <th>MONOx3</th> <th>MONOx4</th> <th>STEREOx1</th> <th>STEREOx2</th> <th>4CHx1</th> </tr> </thead> <tbody> <tr> <td>44.1kHz</td> <td>○</td> <td>○</td> <td>○ *</td> <td>○ *</td> <td>○</td> <td>○ *</td> <td>○ *</td> </tr> <tr> <td>48kHz</td> <td>○</td> <td>○</td> <td>○ *</td> <td>○ *</td> <td>○</td> <td>○ *</td> <td>○ *</td> </tr> <tr> <td>88.2kHz</td> <td>○</td> <td>○</td> <td>×</td> <td>×</td> <td>○</td> <td>○ *</td> <td>○ *</td> </tr> <tr> <td>96kHz</td> <td>○</td> <td>○</td> <td>×</td> <td>×</td> <td>○</td> <td>○ *</td> <td>○ *</td> </tr> <tr> <td>192kHz</td> <td>○</td> <td>○</td> <td>×</td> <td>×</td> <td>○</td> <td>×</td> <td>×</td> </tr> </tbody> </table>			MONOx1	MONOx2	MONOx3	MONOx4	STEREOx1	STEREOx2	4CHx1	44.1kHz	○	○	○ *	○ *	○	○ *	○ *	48kHz	○	○	○ *	○ *	○	○ *	○ *	88.2kHz	○	○	×	×	○	○ *	○ *	96kHz	○	○	×	×	○	○ *	○ *	192kHz	○	○	×	×	○	×	×
	MONOx1	MONOx2	MONOx3	MONOx4	STEREOx1	STEREOx2	4CHx1																																												
44.1kHz	○	○	○ *	○ *	○	○ *	○ *																																												
48kHz	○	○	○ *	○ *	○	○ *	○ *																																												
88.2kHz	○	○	×	×	○	○ *	○ *																																												
96kHz	○	○	×	×	○	○ *	○ *																																												
192kHz	○	○	×	×	○	×	×																																												
* Cannot be used if Input Select is set to IntMic or Digital.																																																			

Menu item	Value	Function																																																
Pre Recording	OFF , 1–29 sec	<p>You can specify the length of time that the sound is captured “retroactively,” starting from before the moment you pressed the [REC] (record) button. This setting specifies the number of seconds that is captured retroactively.</p> <p>* The maximum time depends on the sampling frequency, the sample size (bit depth), and the mode setting.</p> <table border="1"> <thead> <tr> <th>Rec Freq.</th> <th>Rec Bit</th> <th>Rec Mode</th> <th>Pre Recording</th> </tr> </thead> <tbody> <tr><td>44.1</td><td>16</td><td>STEREO x1</td><td>29</td></tr> <tr><td>44.1</td><td>16</td><td>STEREO x2</td><td>14</td></tr> <tr><td>48</td><td>16</td><td>STEREO x1</td><td>27</td></tr> <tr><td>48</td><td>16</td><td>STEREO x2</td><td>13</td></tr> <tr><td>48</td><td>24</td><td>STEREO x1</td><td>18</td></tr> <tr><td>48</td><td>24</td><td>STEREO x2</td><td>9</td></tr> <tr><td>88.2</td><td>24</td><td>STEREO x1</td><td>9</td></tr> <tr><td>88.2</td><td>24</td><td>STEREO x2</td><td>4</td></tr> <tr><td>96</td><td>24</td><td>STEREO x1</td><td>8</td></tr> <tr><td>96</td><td>24</td><td>STEREO x2</td><td>4</td></tr> <tr><td>192</td><td>24</td><td>STEREO x1</td><td>4</td></tr> </tbody> </table> <p>* The R-4 Pro consumes power even during pre-recording. If you are running on batteries, you should pay attention to the remaining battery charge.</p> <p>* Please set Pre Recording to OFF when recording using timecode. If Pre Recording is set, then the timecode will not match.</p>	Rec Freq.	Rec Bit	Rec Mode	Pre Recording	44.1	16	STEREO x1	29	44.1	16	STEREO x2	14	48	16	STEREO x1	27	48	16	STEREO x2	13	48	24	STEREO x1	18	48	24	STEREO x2	9	88.2	24	STEREO x1	9	88.2	24	STEREO x2	4	96	24	STEREO x1	8	96	24	STEREO x2	4	192	24	STEREO x1	4
Rec Freq.	Rec Bit	Rec Mode	Pre Recording																																															
44.1	16	STEREO x1	29																																															
44.1	16	STEREO x2	14																																															
48	16	STEREO x1	27																																															
48	16	STEREO x2	13																																															
48	24	STEREO x1	18																																															
48	24	STEREO x2	9																																															
88.2	24	STEREO x1	9																																															
88.2	24	STEREO x2	4																																															
96	24	STEREO x1	8																																															
96	24	STEREO x2	4																																															
192	24	STEREO x1	4																																															
Project Name	Date , Name1–8	<p>This specifies how names are assigned to the recorded project files. You can select to base the name on the date and time or on the Project Name that you set. If you choose Date, a project recorded at 3:45 and 12 seconds in the morning January 2, 2005, is given the name of “050102034512”.</p> <p>If you use the Date setting, the name of the project indicates the time that it was recorded; this is convenient when you have recorded a large number of projects and are looking for a specific one.</p> <p>If you choose Name, the project name is the name you set in “8 Project Name” (p. 77) plus an ascending serial number. If you specify a clearly identifiable project name, e.g., SCENE001, SCENE002, etc. the project files are grouped together.</p> <p>If you use the Name1–8 setting, the project name is the name you set in “8 Project Name” (p. 77) plus an ascending serial number. The serial number is incremented automatically, e.g., R4_Scene1_001–R4_Scene1_999, up to 999.</p> <p>The R-4 Pro uses the number of the highest serial numbered project name in the current folder as the start value for the serial number.</p>																																																
Limiter link	1/2/3/4	The limiter is applied independently to each channel.																																																
	1+2/3+4	The limiter for channels 1 and 2 is linked. In addition, the limiter for channels 3 and 4 is linked.																																																
	1+2+3+4	The limiter for all channels is coupled.																																																
	1+2/3/4	The limiter for channels 1 and 2 is linked. The limiter for channels 3 and 4 is applied independently.																																																
	1/2/3+4	The limiter for channels 3 and 4 is linked. The limiter for channels 1 and 2 is applied independently.																																																

2 Player Setup

Parameter	Value	Function
Play Mode	Single	This selects the playback mode. Only the selected project will play.
	Sequential	All projects in the folder containing the currently selected project are played sequentially.
Repeat	OFF, ON	This selects whether playback will repeat. If Play Mode is set to Single , only that project is played repeatedly. If Play Mode is set to Sequential , the projects in the folder containing the currently selected project play to the end of the list, and then the projects in that same folder play sequentially again from the beginning of the list.

3 Speaker

Parameter	Value	Function
Speaker Switch	OFF, ON	This switches the internal speakers on/off. * <i>Even if this is set to on, no sound is produced by the internal speakers during recording standby or recording if the Recording Setup parameter Input Select is set to IntMic; the speakers also remain silent while headphones are being used.</i>

4 LCD Setup

Parameter	Value	Function
Contrast	1–5–10	This adjusts the LCD contrast. Higher settings emphasize the white areas of the display.
BackLight	OFF, 1–10	This adjusts the brightness of the LCD backlight. The OFF setting turns the backlight off. Higher settings make the backlight brighter and consume more power. If you are operating the R-4 Pro on battery power, pay attention to the remaining amount of battery capacity.
BackLight Timer	OFF, 2 sec, 5 sec, 10 sec, 20 sec	Sets the amount of time until the display backlight turns off when no operations have been performed on the R-4 Pro. If you are operating the R-4 Pro on battery power, use this setting to conserve battery life.

5 System Setup

Parameter	Value	Function
Battery Time	Alkaline, Ni-MH	Sets the type of batteries you are using. Choose the Alkaline setting if you are using alkaline batteries, or Ni-MH if you are using nickel metal-hydride batteries. * <i>If you choose a setting that does not match the type of batteries that are actually installed, the remaining battery power indication will be incorrect.</i>
Ext-Power	Adapter, 9.0/9.5/ 10.0/10.5/ 11.0/11.5/ 12.0V	Sets the final voltage when using an external power source. The "Battery Low!" message is displayed when the voltage of the external power source drops below the set voltage.
Output Sel	4-indiv	Sets the sound output type. The sound from each channel from LINE OUT is output without modification.
	monitor	Sound is output according to the output assignments

6 Timecode

Menu item	Parameter	Value	Function
Setup	Mode	OFF	The timecode is not recorded.
		INT	The R-4 Pro timecode is used. The timecode operates normally.
		EXT	Uses the timecode sent from the connected device.
		REC-RUN	The R-4 Pro timecode is used. The timecode only runs during recording.
		RTC	The internal clock is used in place of the timecode.
	Frame Rate	24, 25, 29.97, 29.97D , 30, 30D	Selects the frame rate.
	Out Select	ON , OFF	Selects whether to output the timecode to the timecode connector.
	Chase	ON, OFF	Plays the project in the R-4 Pro that matches the timecode input from the timecode connector.
Set Int TC	MANUAL (H: M: S: F)	H : 00 -23 M : 00 -59 S : 00 -59 F : 00 -23/24/29 (According to the Frame Rate setting)	Sets the start time for the timecode when Mode is set to INT. * <i>CURRENT is the current timecode.</i>
	JAM EXT (H: M: S: F)	H : 00 -23 M : 00 -59 S : 00 -59 F : 00 -23/24/29 (According to the Frame Rate setting)	When Mode is set to EXT, the start time for the timecode can be set to match the external device * <i>CURRENT is the current timecode.</i>
Set Rec-Run TC	TARGET	H : 00 -23 M : 00 -59 S : 00 -59 F : 00 -23/24/29 (According to the Frame Rate setting)	When Mode is set to REC-RUN, the start time for the timecode can be set.

7 Date & Time

You can set the date and time.

If **Project Name** is set to **Date**, the time you specify here is used to set the date in the project name.
This setting is also used for the date and time shown in the Main screen.

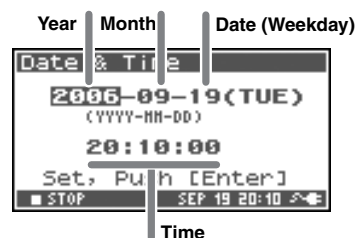

8 Project Name

You can use **Name 1–8** to specify eight different name types. The project name will consist of this name plus a consecutive number of 001, 002, 003, ... appended to it. For example, in the case of the default setting **R4_Scene1**, the project name will be **R4_Scene1_001**.

In order to use a name you have specified here, you will need to set the **Recording Setup** parameter **Project Name** to **Name 1–8**.

Available characters

(space) !#\$%&'()+,-.0123456789;=@

ABCDEFGHIJKLMNOPQRSTUVWXYZ[]^_`abcdefghijklmnopqrstuvwxyz{}

9 HDD Utility

You can use utility commands on the R-4 Pro internal hard disk. You cannot execute HDD Utility commands during recording or playback.

Command	Explanation
Format	<p>Formats the internal hard disk.</p> <p>All projects and folders in the internal hard disk are erased; afterwards, the hard disk is empty.</p> <p><i>* Be sure to back up your projects before you execute this command.</i></p>
Check	<p>Checks the internal hard disk, and after reorganization, frees up any hard disk space not used by R-4 Pro Projects.</p> <p><i>* There is no guarantee that this command will restore the internal hard disk to a normal operating state. Since this command directly manipulates the hard disk sectors, projects may be damaged. Be sure to back up your projects before executing this command.</i></p>
Scan	<p>This checks all sectors of the internal hard disk to see whether they are readable. This check takes approximately 50 minutes to perform.</p> <p>If no problems are found, you are returned to the System Menu. If a problem is found, the indication "HDD failure" is shown. Please back up your data, then contact your dealer or a Roland Service Center for service. In such situations, please be aware that we cannot make any guarantees regarding recovery of any content that may be lost from the hard disk.</p>

10 USB Storage Utility

You can perform utility commands on an external memory device connected to the R-4 Pro. You can not execute USB Storage Utility commands during recording or playback.

When not mounted

Command	Explanation
Mount	Mounts an external memory device after it is connected. <i>* The external memory device is not recognized if it is not mounted, even if it is connected.</i>
Format	Formats the external memory device. All projects and folders on the external memory device are erased; afterwards, the external memory device is empty. <i>* Be sure to back up your projects before you execute this command.</i> <i>* The external memory device is automatically mounted after formatting completes.</i>

When mounted

Command	Explanation
Unmount	Unmounts the external memory device so it can be disconnected. <i>* If you disconnect an external memory device before unmounting it, the data may be damaged. Please exercise caution.</i>
Format	Formats the external memory device. All projects and folders on the external memory device is erased; afterwards, the external memory device is empty. <i>* Be sure to back up your projects before you execute this command.</i>
Check	Checks the external memory device, and after reorganization, frees up any space on the external memory device not used by R-4 Pro Projects. <i>* There is no guarantee that this command will restore the external memory device to a normal operating state. Since this command directly manipulates the sectors on the external memory device, projects may be damaged. Be sure to back up your projects before you execute this command.</i>

11 Factory Reset

This command resets the following settings to their factory default settings. You can not execute Factory Reset during recording or playback.

Recording Setup

Player Setup

Speaker

LCD Setup

System Setup

Project Name

HDD Utility

Effects (Type, Link, Play, Rec, Parameters)

Timecode

Appendix

Handling external memory device

An external memory device can be used to move project files on the R-4 Pro hard disk to a computer or to move WAV files from a computer to the R-4 Pro hard disk. See **Finder functions** (p. 44) for details on how to handle these files.

- * A USB cable can also be used to connect directly to a computer to exchange files. For details see **Connecting to a computer** (p. 82).
- * Recordings cannot be made directly to an external memory device, and files cannot be played from an external memory device.
- * External memory devices refer to USB memory, external HDD, or memory read from a memory card reader.

Connecting an external memory device

- Non-memory devices are not recognized.
- When the memory device, such as a hard disk, is partitioned, only the first partition is recognized.
- When multiple media are inserted in a multimedia card reader, only one card is recognized. Which media is recognized depends on the card reader specifications.

Connection and removal

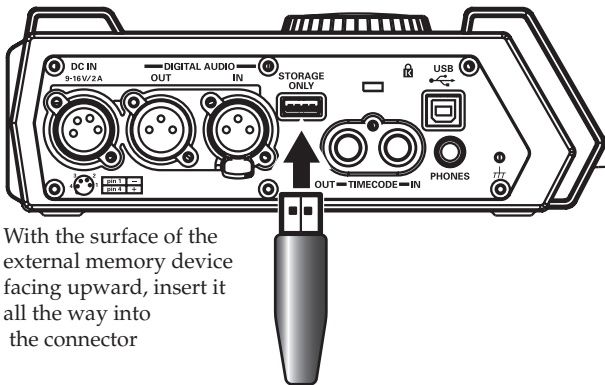

With the surface of the external memory device facing upward, insert it all the way into the connector

Connection

- 1 You can connect **External memory devices** to the **USB Storage [STORAGE ONLY]** port.

Be sure to insert the external memory device plug all the way in. If you forcibly insert the plug incorrectly, the R-4 Pro unit or external memory device may be damaged. Please exercise caution.

- 2 Mount the external memory device following the procedure below.

* When connecting an external memory device, it will not load if it is not mounted.

1. Press the **[SYSTEM]** button on the R-4 Pro. The display shows the System Menu screen.



2. Use the **[CURSOR]** button to select **10 USB Storage Utility**, and press the **[ENTER]** button.

When the connection to an external memory device is not mounted, the USB Storage Utility starts as shown in the figure to the right.

* To cancel, press the **[EXIT]** button.

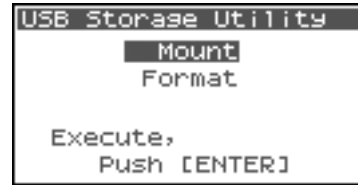

* When an external memory device is not connected, a message as shown in the figure is displayed.

3. Use the **[CURSOR]** button to select [Mount], and press the **[ENTER]** button.



4. "Are you sure?" is displayed. Use the **[CURSOR]** button to select "Yes" to execute or "No" to cancel. Once the selection is made, press the **[ENTER]** button.

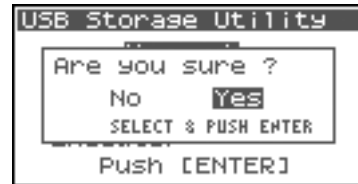

The process is displayed as shown.

Do not turn off power during execution.

When the process completes, the display automatically returns to the System Menu screen.

* Return to the main screen by pressing the **[EXIT]** button again.



Removal

- 1 Verify that the external memory device is not being written to or read from.
- 2 Unmount the external memory device following the procedure below.

* When disconnecting the external memory device, be sure to unmount it. The data in the external memory device may be damaged. Please exercise caution.

1. Press the **[SYSTEM]** button on the R-4 Pro. The display shows the system settings screen.

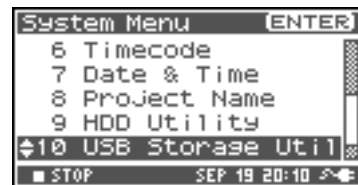

2. Use the **[CURSOR] button** to select **10 USB Storage Utility**, and press the **[ENTER] button**.
The USB Storage Utility starts as shown in the figure to the right.
* To cancel, press the **[EXIT] button**.
3. Use the **[CURSOR] button** to select **[Unmount]**, and press the **[ENTER] button**.
4. "Are you sure?" is displayed. Use the **[CURSOR] button** to select "Yes" to execute or "No" to cancel.
Once the selection is made, press the **[ENTER] button**.

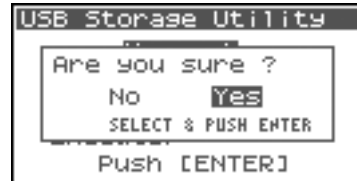
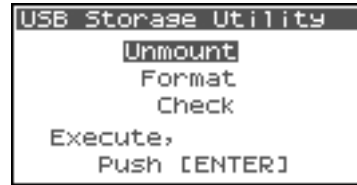

During the process, the display shows as follows.
Do not turn off power during execution.
When the process completes, the display automatically returns to the System Menu screen.

5. Return to the main screen by pressing the **[EXIT] button** again.



3. Disconnect the external memory device.

Formatting an external memory device

You must format an external memory device before using it with the R-4 Pro. For the formatting procedure, refer to page 69 of "**Using the HDD Utility**" (p. 69).
External memory devices formatted on a device other than the R-4 Pro may not work correctly on the R-4 Pro.



As an exception, you should use your Macintosh (not the R-4 Pro) to format the external memory device if you will be using it with Mac OS 9.

The external memory device must be formatted in FAT16 format.

Connecting to a computer

Connecting the R-4 Pro to your computer

You can move or copy project recorded on the R-4 Pro to your computer. Likewise, you can move or copy files from your computer to the R-4 Pro hard disk.

Using battery power will not cause a malfunction, but we recommend that you always use the AC adapter to prevent damage to the contents of the hard disk, which could occur if the batteries fail while the R-4 Pro is connected to your computer.

1 Turn on the R-4 Pro **power switch**.

2 Use a USB cable to connect the R-4 Pro to your computer.

The computer will detect the R-4 Pro, and the screen shown at right is shown.

It may take several seconds for detection to occur.

* If you see the **“Windows can perform the same action each time you insert a disk or connect a device with this kind of file.”** dialog box, click **[Cancel]**.

The computer will detect the R-4 Pro as follows.



Windows	When viewed from My Computer or Explorer, the R-4 Pro appears as R-4Pro .
Mac OS	The R-4 Pro appears as R-4Pro on the desktop.

3 You can copy WAV files from the R-4 Pro to your computer, or from your computer to the R-4 Pro.

To copy a file, drag and drop it.

Disconnecting the R-4 Pro from a computer

The following describes how to close the connection between your computer and the R-4 Pro. You must use the procedure described below to close the connection before you disconnect the USB cable.



Do not disconnect the USB cable or power down the R-4 Pro while it is connected to your computer.

Windows

- 1 Close all software and windows (such as Explorer) that are referencing the R-4 Pro's hard disk.

* *If any software or windows (such as Explorer) that are referencing the R-4 Pro's hard disk are open when you close the USB connection between your computer and the R-4 Pro, an error will occur and the connection will not be closed correctly.*

- 2 In the Windows task tray, double-click the **Safely Remove Hardware icon** ().

The **Safely Remove Hardware** dialog box will appear.

- 3 Select the item that indicates the R-4 Pro.

Item indicating the R-4 Pro

Windows XP, 2000	USB Mass Storage Device
Windows Me	USB Disk

- 4 In the dialog box, click **[Stop]**.

- 5 When the **Stop a Hardware Device** dialog box appears, select the item that indicates the R-4 Pro, and click **[OK]**.

- 6 When your computer indicates "**Safe To Remove Hardware**," you can disconnect the USB cable between the R-4 Pro and your computer.



When you disconnect the cable, the screen shown at right will appear.



* *Never switch off the R-4 Pro's power or disconnect the USB cable before you have closed the connection. Doing so may damage the internal hard disk.*

Macintosh

- 1 Cancel the connection with the R-4 Pro displayed on the desktop.

If you're using **Mac OS X**, drag the **R-4Pro** icon to the  icon on the dock. Normally, when you drag to the trash can located at the right edge of the dock, the indication changes from the trash can to  allowing you to cancel the connection.

If you're using **Mac OS 9**, drag the **R-4Pro** icon to the trash.

- 2 When the icon has disappeared from the desktop, you can disconnect the USB cable between the R-4 Pro and your computer.

Connecting to a video device with a timecode port

R-4 Pro supports synchronization with and recording of SMPTE timecode.
The R-4 Pro can be synchronized with a device supporting timecode.



SMPTE timecode

SMPTE timecode was established by the Society of Motion Picture and Television Engineers (SMPTE) and is a transmitted signal used for synchronizing multiple video and/or audio devices. The timecode indicates the position from the beginning in “Hour: Minute: Second: Frame” format.

The R-4 Pro timecode is Longitudinal Timecode (LTC) conforming to SMPTE 12M-1999.



Drop frame method

The drop frame method is one of the SMPTE timecode formats. The 30 frames per second NTSC signal method used in the US and Japan is actually 29.97 frames/second. This method corrects for the discrepancy with the actual time (clock time) by dropping intermediary Timecodes. The first two frames of each minute are dropped (starts from frame 02 rather than frame 00) except for the 10th, 20th, 30th, 40th, and 50th minutes. Broadcasters who require the timecode to match the broadcast time use this method.



Non-drop frame method

The non-drop frame method is one of the SMPTE timecode formats. Although the 30 frames per second NTSC signal method used in the US and Japan is actually 29.97 frames/second, this method emphasizes the continuity of the timecode rather than the time difference that occurs with clock time and does not drop intermediary Timecodes. This method is used in general video or music creation.

* Select the drop-frame or non-drop frame method to match the timecode of the video being synchronized.

Setting timecode

- 1 Press the **[SYSTEM]** button on the R-4 Pro.

The display shows the System Menu screen.



- 2 Use the **[CURSOR]** button to select **6 Timecode**, and press the **[ENTER]** button.

The Timecode screen is shown.

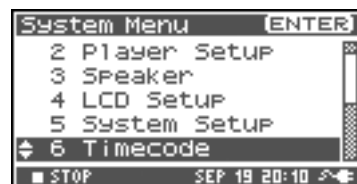

- 3 Use the **[CURSOR]** button to select **1 Setup**, and press the **[ENTER]** button.
The Timecode Setup screen is shown.

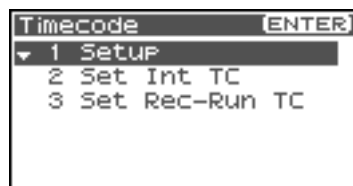

- 4 Use the **[SCRUB/VALUE]** dial to select Mode.

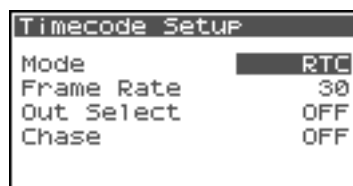

The modes are as shown below. (The values in boldface are the default values.)

OFF	The timecode is not recorded.
INT	The R-4 Pro timecode is used. The timecode operates normally.
EXT	Uses the timecode sent from the connected device.
REC-RUN	The R-4 Pro timecode is used. The timecode runs only during recording.
RTC	The internal clock is used in place of the timecode.

- 5 Use the **[CURSOR]** button to select Frame Rate.
- 6 Use the **[SCRUB/VALUE]** dial to select the Frame Rate value.
Frame Rate:
24, 25, 29.97, 29.97D, 30, 30D
D is the drop-frame method; everything else is the non-drop frame method.
- 7 After setting the value, press the **[EXIT]** button twice.
The display returns to the System Menu screen.
- 8 Return to the Main screen by pressing the **[EXIT]** button again.

- 9 When Mode is set to INT, EXT, or REC-RUN, the date and time on the Main screen changes to the timecode.

* Please set Pre Recording to OFF when recording using timecode. If Pre Recording is set, then the timecode will not match.

* If the **[PAUSE]** button is pressed during recording, the timecode will not match during playback. Please exercise caution.



Setting the start time

Setting the internal timecode start time

- 1 Press the [SYSTEM] button on the R-4 Pro.
The display shows the System Menu screen.



- 2 Use the [CURSOR] button to select 6 Timecode, and press the [ENTER] button.
The Timecode screen is shown.

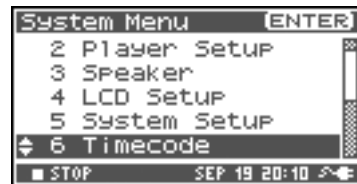

- 3 Use the [CURSOR] button to select 2 Set Int TC, and press the [ENTER] button.
The display shows the Set Int TC screen.

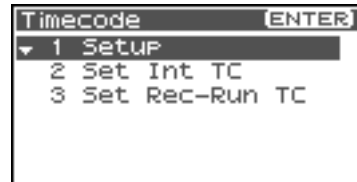

- 4 Use the [CURSOR] button to select the input location, and then set the start time with the [SCRUB/VALUE] dial.
 - * H:M:S:F: indicates Hours: Minutes: Seconds: Frames, respectively. The F value differs according to the Frame Rate value in the Timecode Setup.
 - * To cancel the settings, press the [EXIT] button.

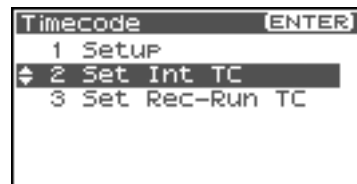

- 5 Press the [ENTER] button.
After the screen shown in the figure to the right is displayed, the set time is shown as CURRENT, and the timecode begins.

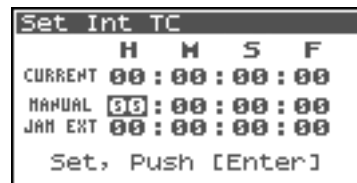

- 6 After setting the value, press the [EXIT] button.
The display returns to the Timecode screen.
- 7 Return to the Main screen by pressing the [EXIT] button again.

Synchronize to an external timecode source

* Be sure to connect the timecode In connector on the R-4 Pro to the Timecode Out port on the device used for synchronization.

- 1 Press the **[SYSTEM]** button on the R-4 Pro.

The display shows the System Menu screen.



- 2 Use the **[CURSOR]** button to select 6 Timecode, and press the **[ENTER]** button.

The Timecode screen is shown.

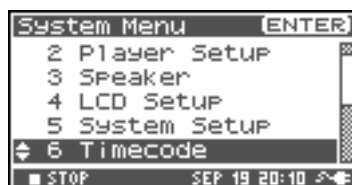

- 3 Use the **[CURSOR]** button to select 2 Set Int TC, and press the **[ENTER]** button.

The display shows the Set Int TC screen.

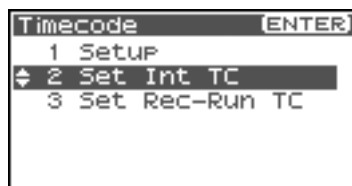

- 4 Use the **[CURSOR]** button to select JAM EXT.

* To cancel the settings, press the **[EXIT]** button.

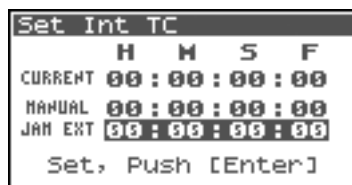

- 5 Press the **[ENTER]** button.

After the screen shown to the right is displayed, a value the same as JAM EXT is shown as CURRENT, and the timecode begins.

- 6 After setting the value, press the **[EXIT]** button.

The display returns to the Timecode screen.

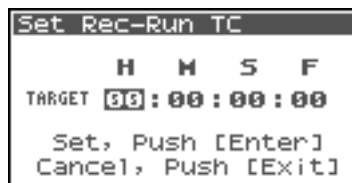

- 7 Return to the Main screen by pressing the **[EXIT]** button again.

Setting the REC-RUN timecode start time

- 1 Press the **[SYSTEM]** button on the R-4 Pro.
The display shows the System Menu screen.



- 2 Use the **[CURSOR]** button to select **6 Timecode**, and press the **[ENTER]** button.
The Timecode screen is shown.

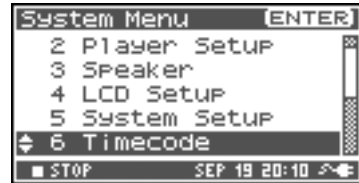

- 3 Use the **[CURSOR]** button to select **3 Set Rec-Run TC**, and press the **[ENTER]** button.
The display shows the Set Rec-Run TC screen.

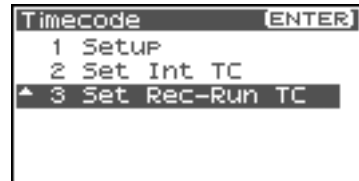

- 4 Use the **[CURSOR]** button to select the input location, and then set the start time with the **[SCRUB/VALUE]** dial.
** H:M:S:F: indicates Hours :Minutes :Seconds :Frames, respectively. The F value differs according to the Frame Rate value in the Timecode Setup.*
** To cancel the settings, press the **[EXIT]** button.*

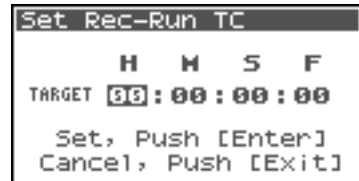

- 5 Press the **[ENTER]** button.
The set time is displayed and the timecode begins.

- 6 After setting the value, press the **[EXIT]** button.
The display returns to the Timecode screen.

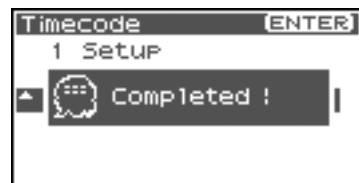

- 7 Return to the Main screen by pressing the **[EXIT]** button again.

Application guide

Before you record using the R-4 Pro, you must set up the R-4 Pro to be appropriate to your recording environment and purpose.

This section gives several actual examples of applications. For details on connections refer to **“Recording”** (p. 30). The following explains the settings that need to be made on the R-4 Pro.

Connecting an external mic for CD-quality stereo recording

This is a basic form of recording.

Panel settings

Phantom power switch	ON if using a condenser mic that requires phantom power; otherwise OFF
-----------------------------	--

Recording Setup

Input Select	Analog
Rec Freq.	44.1 kHz
Rec Bit	16 bit
Rec Mode	STEREOx1
Pre Recording	OFF
Project Name	Date

Recording birdsongs outdoors

These basic settings are used for recording birdsongs or similar outdoor sounds. Since batteries are required for outdoor use, these settings take power conservation into account.

Panel settings

Phantom power switch	ON if using a condenser mic that requires phantom power; otherwise OFF
-----------------------------	--

Recording Setup

Input Select	Analog	By lowering the sampling frequency (Rec Freq.) and limiting the number of tracks, you can minimize the size of the file to be written. These settings also reduce the number of time the hard disk is accessed, thereby conserving power.
Rec Freq.	44.1 kHz	
Rec Bit	16 bit	
Rec Mode	STEREOx1, MONOx1	Set to match the mics that are connected.
Pre Recording	4 Sec	The pre-recording setting lets you press the record button when you hear birdsong; sounds that occurred several seconds earlier is captured retroactively. When recording birdsong, four seconds is sufficient. In comparison to allowing recording to continue, this method minimizes the number of accesses to the internal hard disk. However, with any pre-recording setting other than OFF, recording always continues internally.
Project Name	Date	Using the Date setting will make it easy to tell the date and time that the recording was made.

LCD Setup

BackLight Timer	5 sec
------------------------	-------

System Setup

Battery Type	Set to the type of batteries you've installed
---------------------	---

Recording audio while filming video

These basic settings are used for using the R-4 Pro to record audio while filming video. If recording outdoors, you can use the settings for **“Recording birdsongs outdoors”** (p. 90) in this case as well, but other settings specific to video are also necessary.

Panel settings

Phantom power switch	ON if using a condenser mic that requires phantom power; otherwise OFF
-----------------------------	--

Recording Setup

Input Select	Analog	The number of mics will depend on the filming conditions. If simply recording the background sound, you can use two mics and record in stereo. If recording a play or an instrumental performance, you should set up one mic for each actor or instrument. You can record up to four mics simultaneously.
Rec Freq.	48 kHz	If you are filming with a video camera and will add the audio tracks recorded on the R-4 Pro later using a video editing system, you should record at 48 kHz.
Rec Bit	16 bit	If using audio to add to a production focussing on the video element, 16-bit recording provides sufficient quality.
Rec Mode	Set this to match the mic(s) you're using. Choose the MONO setting if each mic is assigned to a different actor or instrument. With the MONO setting, a separate WAV file will be created for each mic. In other cases you will generally use the STEREO setting.	
Pre Recording	OFF	Turn this OFF, since audio is synchronized to the video device.
Project Name	Name	It is convenient to assign a unique name to the project so that each recorded project will be easily identifiable; e.g., SCENE001, SCENE002, ... etc.

System Setup

Timecode	Set when recording the timecode. See Setting timecode (p. 84).
-----------------	--

Recording audio memos using just the R-4 Pro

You can use the internal mics to record with the R-4 Pro only. However, the recording quality will be limited compared to using good quality external mics. The sound of the R-4 Pro button operations or internal mechanism may also be recorded.

Input Select	Int-Mic
Rec Freq.	44.1 kHz
Rec Bit	16 bit
Rec Mode	STEREOx1
Pre Recording	OFF
Project Name	Date

Simultaneously recording environmental sounds (ambience)

You can take advantage of the R-4 Pro's ability to record four channels simultaneously. You can use channels 1 and 2 to record a stage performance via digital inputs, and channels 3 and 4 to record the sounds of the room or audience via mics.

Panel settings

Phantom power switch	ON if using a condenser mic that requires phantom power; otherwise OFF
-----------------------------	--

Recording Setup

Input Select	Dig + Ana	Set to Dig+Ana to use the XLR input connector and the digital input connector simultaneously.
Rec Freq.	44.1 kHz	If using a computer to edit the waveforms after recording, you may wish to use a higher sampling frequency.
Rec Bit	16 bit	
Rec Mode	STEREOx2	Set to STEREOx2 to record both the stage performance and the ambient sounds in stereo.
Pre Recording	OFF, 1–29 sec	Specify the pre-recording time as desired.
Project Name	Date, Name	Specify a name that will help you manage the projects when recording is finished. Date... Using the Date setting makes it easy to tell the date and time that the recording was made. Name... Assigning a unique project name, so that the projects have names such as SCENE001, SCENE002, and so forth, makes it easy to see which projects belong together.

Simultaneously recording at different input levels

These settings are useful when you cannot afford mistakes, such as when recording an event or other non-repeatable occasion. Even if the input levels are set appropriately, there may be cases in which an unexpectedly loud sound causes clipping to occur, or conversely, in which the sound stays at an unexpectedly low level.

For these situations, use four mics and pair two for each channel. Set each input level to a different level, and record all four channels (two stereo pairs) simultaneously. After recording, select an appropriate project.

Panel settings

Phantom power switch	ON if using a condenser mic that requires phantom power; otherwise OFF
Input level knobs	Set channels 1 and 2 to appropriate levels. Set channels 3 and 4 to slightly lower input levels; for example, about -12 dB lower than channels 1 and 2.

Recording Setup

Input Select	Analog
Rec Freq.	44.1 kHz
Rec Bit	16 bit
Rec Mode	STEREOx2
Pre Recording	OFF
Project Name	Date

Recording comments simultaneously

You can use this feature to record four channels simultaneously. You can use channels 3 and 4 to record from the connected mics and channels 1 and 2 to record comments from the internal mics.

Panel settings















Phantom power switch	ON if using a condenser mic that requires phantom power; otherwise OFF
-----------------------------	--

Recording Setup

Input Select	Int+Ana	Set to Int+Ana to use the XLR input connector and the internal mics simultaneously.
Rec Freq.	44.1 kHz	If using a computer to edit the waveforms after recording, you may wish to use a higher sampling frequency.
Rec Bit	16 bit	
Rec Mode	STEREOx2	Set to STEREOx2 to record the externally connected mics in stereo and to record the comments in stereo.
Pre Recording	OFF, 1–29 sec	Specify the pre-recording time as desired.
Project Name	Date, Name	Specify a name that will help you manage the projects when recording is finished. Date... Using the Date setting makes it easy to tell the date and time that the recording was made. Name... Assigning a unique project name, so that the projects have names such as SCENE001, SCENE002, and so forth, makes it easy to see which projects belong together.

Messages

This section explains the most important messages that may appear in the R-4 Pro's display

Message	Status
 Int-Batt Low!	Int-Batt Low! The remaining charge for the internal battery is low. The internal battery must be replaced. If the battery charge is insufficient, the internal clock will become inaccurate. Please contact one of the service locations listed on the warranty card to have the battery replaced.
 Battery Low!	Battery Low! The remaining charge for the batteries or the external power source is low. Install fresh batteries, change the external power source, or use the AC adapter.
 HDD buffering	HDD buffering The recording buffer has almost reached capacity. Move the R-4 Pro to a location where there is no vibration or sound pressure. See p. 21 for details.
 HDD Slow! PUSH ANY KEY	HDD Slow! The recording buffer has reached capacity. Recording does not stop, but some sound is not recorded. This message will not disappear until a button is pressed. Move the R-4 Pro to a location where there is no vibration or sound pressure. If this message is displayed again, it is possible that the hard disk processing capacity has decreased. Format the disk. See P. 20 for details.
 HDD unformatted	HDD Unformatted This message is displayed if the internal hard disk was formatted in a file format that the R-4 Pro cannot read. Please format the internal hard disk.
 Media Full!	Media Full! There is insufficient free space on the hard disk or external memory device. Transfer project files to your computer to free up more space.
 Over 2GB	Over 2GB The project is too large. This message is displayed if the project newly created by appending an existing project exceeds 2 GB. The R-4 Pro can handle files up to 2 GB.
 Over prj #999	Over prj #999 This message is displayed if you press the record button when a project name with a number of 999 already exists. You cannot record in this state. You need to change the project name before you can record.
 Project exists!	Project exists! An identically named project already exists. Create the project using a different name.
 File-Sys Error!	File-Sys Error! A problem has occurred with the file system.
 Name too long!	Name too long! The project name is too long. This message is displayed if the project name newly created when you use Trim or Combine, or when you copy a project is too long. You'll need to shorten the name of the source project.
 Improper Proj.	Improper Proj. The R-4 Pro cannot handle this project.
 HOLD ON	HOLD ON The HOLD switch is on. This message is displayed if you attempt to operate the R-4 Pro while the HOLD switch is on.
 Now Recording	Now Recording The R-4 Pro is recording now. This message is displayed if you attempt to operate the R-4 Pro during recording. If you need to perform an operation, you must first stop recording.
 Now Playing	Now Playing The R-4 Pro is playing now. This message is displayed if you attempt to operate the R-4 Pro during playback. If you need to perform an operation, you must first stop recording.

Troubleshooting

If you experience difficulties, read this section first. It contains tips on how to resolve various problems.

Computer-related problems

Cannot close the connection with the R-4 Pro

When using Windows and if Explorer or any other software referencing the R-4 Pro's hard disk is open when you attempt to close the USB connection between the R-4 Pro and your computer, the error message "An error occurred while removing USB mass storage device – Unable to close device 'unspecified volume.' Please execute Stop Device again later." appears, and you will be unable to disconnect the R-4 Pro. Close all software or windows that are referencing the R-4 Pro's hard disk. Then execute "Safely remove hard disk" once again.

External memory device connected in the R-4 Pro is not visible from the computer

The external memory device inserted in the R-4 Pro cannot be viewed from the computer. Consequently, you cannot manipulate projects on the external memory device.

Recording-related problems

Cannot record

You cannot record correctly if the input level specified with the input level knobs is too low. Please set the input level correctly.

Refer to: "Adjusting the input level" (p. 31)

When recording from connected mics, make sure that the mics are properly connected to the XLR input connectors.

Also check the setting of the phantom power switch.

Refer to: "Phantom power switches [PHANTOM POWER]" (p. 10)

You cannot record correctly if the Input Select system setting is wrong.

Refer to: "System setup" (p. 64)

Strange sounds are heard during the recording

If recording with the internal mics, you may hear metallic or mechanical clicks in the recording. These sounds are the operating noises of the R-4 Pro's internal hard disk. Due to how the R-4 Pro is constructed, the hard disk operating sounds may affect the recording.

You can alleviate this somewhat by using the **Graphic EQ** effect on the **REC** side to lower the 2 kHz and 4 kHz levels.

Recorded audio is distorted

The audio is distorted if the input level is too high. Refer to "Adjusting the input level" (p. 31), and use the input level knobs to adjust the level appropriately.

In some cases, the sound may be distorted because an effect has been applied while recording. You should adjust the input level with the effect applied. Adjust the effect parameters so that distortion does not appear.

Pan (stereo image) is not stored correctly

If the limiter is turned on, it will respond to the levels of each channel, meaning that when the level of a sound located toward the right (or left) side increases, the limiter for that channel will limit the volume. If you're recording in stereo, the result will be that the left and right volume difference will diminish, causing the pan (stereo image) to move toward the center.

- Panning can be correctly recorded by linking the limiters of the channels recording in stereo using the Limiter Link.

Refer to: "1 Recording Setup" (p. 72)

If using the **Comp&DeEsser** effect with channel linking (LINK) set separately for CH1, CH2, CH3, and CH4, and the compressor begins to operate on CH1 (left), this will eliminate the level difference with CH2 (right), causing the pan (stereo image) to move toward the center.

- In this case, set the LINK setting to CH1+2 or CH3+4 so that whenever compression starts being applied to CH1 (left), it will be applied to CH2 (right) at the same time.

Refer to: "Effects settings" (p. 59)

Also, the stereo image will not be recorded correctly if the input level knob settings differ significantly between L and R, so that the levels are not balanced correctly.

Even though the recording levels are set, the sound is distorted when an effect is turned on

Since some effects work by emphasizing a portion of the sound, this may increase the volume of the overall song, thereby causing clipping (distortion). You may take either of the following two actions.

- Lower the level (LEV) values for each effect parameter
The overall volume will decrease, but the character of the effect will be maintained.
Refer to: "Effects settings" (p. 59)
- Lower the input level to decrease the volume before applying the effect
This adjustment is easy to make, but may change the resulting character of the effect.

The HDD Slow! message is shown

Writing access to the hard disk has slowed down.

As you repeatedly write and delete project files, the files on the hard disk become fragmented, and this slows down the processing speed.

If making important recordings, you should consistently delete all projects together when finished with them. Repeated deletion of smaller pieces of data causes the disk to become fragmented, possibly causing recording to fail.

Playback-related problems

No sound

If the monitor level knob is turned too far down, the volume may be too low for you to hear. Gradually raise the monitor level knob.

Refer to: “**Monitor level knob [MONITOR]**” (p. 13)

If the output assignments are not set appropriately, the sounds are not output.

Reference: **Output assignments** (p. 18)

Make sure that your headphones or speakers are connected correctly.

No sound from the internal speakers

In the system settings for Speaker, make sure that Speaker Switch is ON. No sound is output from the internal speakers if this setting is OFF.

No sound is output from the internal speakers if headphones are connected.

To prevent acoustic feedback, no sound is output from the internal speakers during recording or recording standby.

The external memory device contains a file, but the R-4 Pro will not play it

The R-4 Pro cannot directly play files from the external memory device.

In order to play a file located on the external memory device, use the Finder screen to copy the file onto the R-4 Pro hard disk, and then play it.

Refer to: “**Copying a project (Copy)**” (p. 47)

A skip of several seconds occurs in the project playback

If the R-4 Pro is subjected to vibration or impact, writing to the hard disk may not occur in time, meaning that that portion of sound is not recorded. When you listen to the recorded project, the time count during playback does not skip, but there is a skip of several seconds in the sound of the project.

During recording, please be careful that the R-4 Pro is not subjected to impact.

The sound skips when you play back through the internal speakers

Vibration produced by the internal speakers may cause reading from the hard disk to fail, and this may cause skips in the sound.

Try turning the monitor level knob toward the left to lower the volume of the internal speakers.

Alternatively, you can monitor through headphones.

Skips occur in the sound

As you repeatedly write and delete project files, the files on the hard disk become fragmented, and this slows down the processing speed. If you continue recording in this state, a message of “HDD Slow!” is shown, and skips may occur in the recorded project.

If making important recordings, you should consistently delete all projects together when finished with them. Repeated deletion of smaller pieces of data causes the disk to become fragmented, possibly causing recording to fail.

Problems with the R-4 Pro operation

Power does not turn on

Make sure that the AC adapter is correctly connected.

If using batteries, make sure that each battery is securely in place and in the correct orientation. It is also possible that the batteries have run down, so you should obtain a new set of batteries.

Refer to: **"Connecting the AC adapter and turning the power on/off"** (p. 25)
"Installing batteries and turning on the power" (p. 26)

Make sure that the HOLD switch is turned off. If it is on, the panel buttons and the scrub and shuttle dials will be inoperable.

Refer to: **"Hold switch [HOLD]"** (p. 10)

Finder operation is sluggish

If a folder contains a large number of files, operation are sluggish when you open the Finder, and the screen does not scroll easily.

If there is a large number of files, operations in the Finder take more time. Try moving projects in the folder to a different folder so that the folder contains fewer projects.

Backlight turns off

The **Backlight** setting in **LCD Setup** may be set to turn off the backlight when the unit has not been operated for a while.

Refer to: **"4 LCD Setup"** (p. 75)

Settings that you made disappear

If effect settings or system settings you made have reverted to their original state, it is possible that you inadvertently reset the R-4 Pro to its factory default settings.

Refer to: **"Executing Factory Reset (Restoring the factory default settings)"** (p. 71)

Effect parameters that you set have been initialized

Effect parameter values are remembered as long as the effect type is not changed; they will return to the default values if the effect type is changed. If precise settings, you should a note of those settings to use again.

Refer to: **"Effects settings"** (p. 59)

Cannot operate the panel

Make sure that the HOLD switch is turned off.

If this is on, the panel buttons and the scrub and shuttle dials will be inoperable.

Refer to: **"Hold switch [HOLD]"** (p. 10)

Project names and folder names in the Main screen or Finder are garbled

The characters that are not "Available characters" are not displayed properly. In addition, there are cases when RENAME was not performed correctly.

Refer to: **"Available characters"** (p. 77)

Main specifications

Recorder

● Channels

4

● Signal Processing

AD/DA Conversion: 24 bits
Sampling Frequency: 44.1/48/88.2/96/192 kHz

● Data Types (both Recording and Playback)

Format: BWF, WAV
Sample Size: 16/24 bits
Sampling Frequency: 44.1/48/88.2/96/192 kHz

* The sample size and sampling frequency can be combined in any way.

● Media

Internal Hard Disk Drive (80 GB)

● Recording Time (Stereo, in hours)

	44.1 kHz	48 kHz	88.2 kHz	96 kHz	192 kHz
16 bit	116	106	58	53	26
24 bit	77	70	38	35	17

* These recording times are approximate. Your results may vary.
* If more than one recorded file is created, the total recordable time will be less than these times.

Audio Input and Output

● Analog Inputs

Channel 1-4: XLR type (accepts phantom powered)
Internal Microphones (Stereo)

● Analog Outputs

Channel 1-4: Line out (RCA phono type)
Headphones: Stereo 1/4 inch phono type

● Digital Input/Output

XLR type (AES/EBU, conforms to IEC 60958-4)

● Input Impedance

Analog Input: 4 k ohms

● Nominal Input Level

Use the sensitivity knobs to select from the following (with the input level knobs in mid-position)
-56, -50, -44, -38, -32, -26, -20, -14, -8, -2, +4 dBu
(input level knobs: negative infinity to +8 dB)

● Output Impedance

LINE Out: 950 ohms
Headphones: 10 ohms

● Output Level

LINE Out: -10 dBu (Fixed)
Headphones 40 mW + 40 mW

● Residual Noise Level

LINE Out: -90 dBu

(SENS Knob: +4 dBu, Input Level Knob: Min)

● Total Harmonic Distortion (THD+N)

0.01%
(SENS Knob: +4 dBu, Input Level Knob: Center)

● Recommended Load Impedance for Headphones

32 ohms

● Frequency Response

20 Hz-40 kHz (0 - -3 dB)

● Phantom Power

48+/-4 V / 8 mA (Available 4 Channels simultaneously)
* Should be less than 25 mA in total
* 0 dBu = 0.775 Vrms

Other Input/Output Part

● USB Interface

A Type Connector (For USB Storage device)
Supports USB 1.1 and 2.0 Mass Storage Device Class.
B Type Connector (For Computer connection)

Supports USB 1.1 and 2.0 Mass Storage Device Class.

● SMPTE Timecode connector

BNC Coaxial type (Conforms SMPTE 12M-1999)

Effect Unit Part

● Effect Type:

Select one of the types below.

- 3-BAND EQ
- 6-BAND GRAPHIC EQ
- NOISE GATE
- ENHANCER

- COMPRESSOR AND DE-ESSER
- MS MIC MIXING
- NO EFFECT

* Available when either recording or playing

* Not available for 88.2, 96, or 192 kHz sampling frequency.

Control

- Power Switch
- Hold Switch
- Input SENS Knobs x 4
- Input Level Knobs x 4
- Monitor Level knob
- Phantom Power Switches: CH1/2, CH3/4
- Limiter Switch
- Scrub (Value)/Shuttle Dial
- Transport Buttons: PREV (REW), NEXT (FWD), STOP, PLAY/PAUSE, REC
- Marker Buttons: CLEAR, PREV, NEXT, MARK
- Function Buttons: WAVE EDIT, EFFECTS, SYSTEM
- A-B Repeat Button
- Display Button

Others

● Display

128 x 64 dots Graphic LCD (backlit LCD)

● Power Supply

AC Adapter (PSB-1U)
Alkaline dry battery LR6 (AA) type x 8, or Nickel-metal hydride battery (HR15/51) x 8
External Power Supply: 4-pin XLR type (9–16 V)

● Installation Conditions

Temperature: 0 degrees Celsius to 40 degrees Celsius
(according to internal test standards)
Humidity: 80% or less (no condensation)

● Power Consumption

2.0 A

● Dimensions

240 (W) x 217.4 (D) x 77.1 (H) mm
9-1/2 (W) x 8-9/16 (D) x 3-1/16 (H) inches

* The height includes the rubber pads

● Weight (with batteries)

1.7 kg
3 lbs 12 oz

● Accessories

Owner's Manual
AC Adapter
AC Adapter 4pin XLR type connector converter cable
USB cable
Carrying Case

* In the interest of product improvement, the specifications and/or appearance of this unit are subject to change without prior notice.

Block diagram

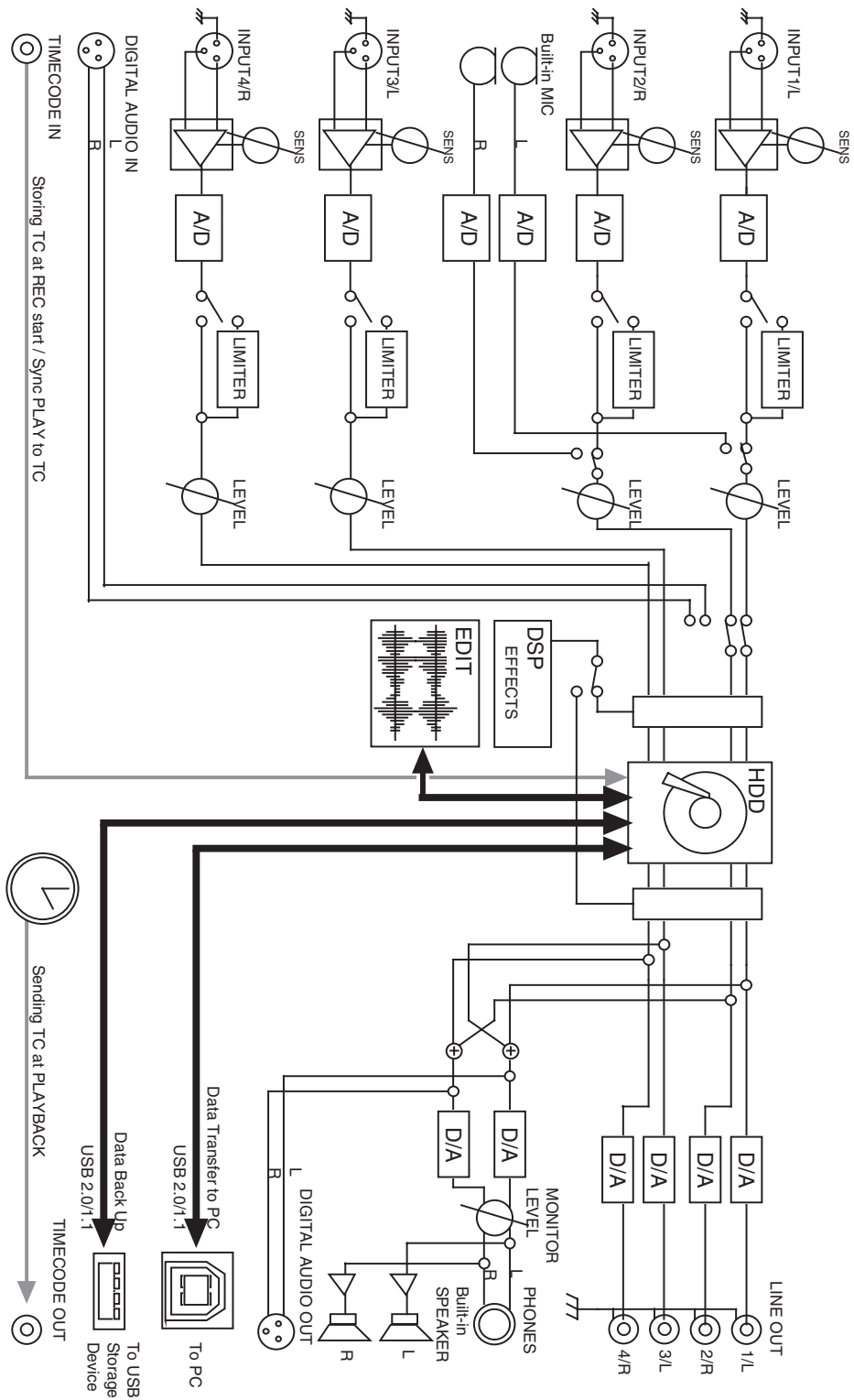

Index

Numerics

- 3-Band EQ 62
- 4CH 23
- 4-indiv 37, 75

A

- A-B REPEAT 11, 43
- A-B Repeat button 11
- ABS 18, 20
- AC adapter 25
- AC adaptor 8, 25
- Adjusting the input level 31, 33
- Alkaline 26, 75
- amplified speakers 37
- Analog 72
- analog device 37

B

- BackLight 75
- BackLight Timer 75
- batteries 26
- Battery compartment 17
- Battery life 28
- Battery Low 94
- Battery Time 75
- Block diagram 101
- Bottom panel 17
- BWF 23

C

- Carrying case 8
- Channel level meters 18
- Channel level sliders 19
- Channel names 18
- Chase 76
- Check 77–78
- CLEAR 11
- Clear button 11
- Clip level indicators 18–19
- Combine 55
- Combo input jacks 16
- Comp&DeEsser 63
- computer 82
- Contrast 75
- Copy 47
- CURSOR/MONITOR SELECT 12
- Cursor/Monitor Select buttons 12

D

- Date 74
- Date & Time 67, 76
- DC IN 14
- Delete 45
- Dig + Ana 72
- Digital 72
- digital connection 38
- digital device 34
- DIGITAL IN 14
- Digital input connector 14
- DIGITAL OUT 14
- Digital output connector 14
- Display 11, 13, 18
- Display button 11
- Divide 53
- Drop frame method 84

E

- Edit Timecode 58
- Effect button 11
- EFFECTS 11
- effects 59–60
- Enhancer 63
- ENTER/FINDER 12
- Enter/Finder button 12
- EXIT 12
- Exit button 12
- external memory device 70
- external power sources 29
- external timecode 87
- Ext-Power 75

F

- Factory Reset 71, 78
- file size 23
- File-Sys Error 94
- Format 69–70, 77–78, 81
- Four-channel projects 23
- Frame Rate 76
- Front panel 13

G

- Graphic EQ 62
- Grounding terminal 15

H

- HDD Slow 94, 96

- HDD Unformatted 94
HDD Utility 69, 77
Headphone jack 15
headphones 37
HOLD 10
HOLD ON 94
Hold switch 10
- I**
- Improper Proj. 55, 94
INPUT GAIN 13
Input level knobs 13, 33, 35–36
Input level select switch 35–36
Input Select 72, 89
Int + Ana 72
Int-Batt Low 94
Internal mics 9
Internal speakers 9
internal timecode 86
Int-Mic 72
- J**
- JAN EXT 76
- L**
- LCD Setup 75
LEN 18
Level 18
Level scale 18
LIMITER 10
Limiter 30, 35
Limiter link 74
Limiter switch 10
LINE OUT 16
Line output jacks 16
LTC 18, 20
- M**
- Macintosh 83
main screen 18, 20
Make Folder 49
MANUAL 76
MARK 11, 42
Mark button 11
MARKER 11
Marker 11
Marker indicators 19
Media Full 52, 54, 56–57, 94
Merge 57
MIC-L 9
MIC-R 9
- mixer screen 19
Mode 76
Monaural projects 22
MONITOR 13
monitor 37, 75
Monitor level knob 13
MONOx1 22
MONOx2 22
MONOx3 22
MONOx4 22
Mount 78
Move 48
MS-Mic 63
- N**
- Name 74, 94
Name too long 94
NEXT 13
NEXT button 13
nickel metal-hydride 26
Ni-MH 75
Noise Gate 62
Non-drop frame method 84
Now Playing 94
Now Recording 94
- O**
- Out Select 76
Output assignments 18
Output level meters 19
Output Sel 75
Over 2GB 94
Over prj #999 94
- P**
- PAUSE 13
Pause button 13
PHANTOM POWER 10
Phantom power switch 10, 30, 33, 89
PHONES 15
pjt 23
PLAY 13
Play button 13
Play Mode 39, 75
Player Setup 39, 75
POWER 9, 25
Power connector 14
Power Conversion Cable 8
Power source 19
Power switch 9
Pre Recording 74, 89

PREV	13
PREV button	13
Progress bar	18
project	22
Project exists	94
Project Name	18, 68, 74, 77, 89

R

REC	13
Rec Bit	72, 89
Rec Freq.	72, 89
Rec Mode	73, 89
Record button	13, 32–36
Recordable time	20
Recording Setup	65
Recording-standby	32
REC-RUN	85, 88
REM	19
Remaining hard disk capacity	20
Remaining time	19
Rename	46
Repeat	39, 75
RTC	85

S

Sample size	18
Sampling frequency	18
Scan	77
Scrub dial	12
SCRUB/VALUE	12
Security Slot	14
Select	44
SENS	13
Sequential	39, 75
Set Int TC	76
Set Rec-Run TC	76
SHUTTLE	12
Shuttle dial	12
Side panel	14, 16
Single	39, 75
SMPTE timecode	84
Speaker	40, 75
Speaker Switch	40, 75
start time	86
Stereo	23
Stereo projects	23
STOP	13
Stop button	13
STORAGE ONLY	14
SYSTEM	11
System button	11

System settings	30, 33–36, 64
System Setup	75–76

T

TARGET	76
Time counter	18, 20
TIMECODE	14
Timecode	66
Timecode Connector	14
Top panel	9
Total recording time	20
Total time	18
Trim	51

U

Unmount	78
USB	14
USB cable	8
USB connector	14
USB Storage	79
USB Storage connector	14
USB Storage Utility	70, 78

W

wav	23
WAVE EDIT	11
Wave edit button	11
Windows	83

X

XLR input connectors	16
----------------------------	----

MEMO

MEMO

IMPORTANT: THE WIRES IN THIS MAINS LEAD ARE COLOURED IN ACCORDANCE WITH THE FOLLOWING CODE.

BLUE: NEUTRAL
BROWN: LIVE

As the colours of the wires in the mains lead of this apparatus may not correspond with the coloured markings identifying the terminals in your plug, proceed as follows:

The wire which is coloured BLUE must be connected to the terminal which is marked with the letter N or coloured BLACK.

The wire which is coloured BROWN must be connected to the terminal which is marked with the letter L or coloured RED.

Under no circumstances must either of the above wires be connected to the earth terminal of a three pin plug.

DECLARATION OF CONFORMITY Compliance Information Statement

Model Name : R-4 Pro
Type of Equipment : 4-CHANNEL PORTABLE RECORDER and WAVE EDITOR
Responsible Party : Roland Systems Group U.S.
Address : 425 Sequoia Drive Suite 114, Bellingham, Washington, 98226 USA
Telephone : 360-594-4282

- * Microsoft and Windows are registered trademarks of Microsoft Corporation.
- * Windows[®] is known officially as: "Microsoft[®] Windows[®] operating system."
- * Apple and Macintosh are registered trademarks of Apple Computer, Inc.
- * Mac OS is a trademark of Apple Computer, Inc.
- * All product names mentioned in this document are trademarks or registered trademarks of their respective owners.
- * Fugue © 2006 Kyoto Software Research, Inc. All rights reserved.



Information

When you need repair service, call your nearest EDIROL/Roland Service Center or authorized EDIROL/Roland distributor in your country as shown below.

ASIA

CHINA

Roland Shanghai Electronics Co.,Ltd.
5F, No.1500 Pingliang Road
Shanghai 200090, CHINA
TEL: (021) 5580-0800

Roland Shanghai Electronics Co.,Ltd.
(BEIJING OFFICE)
10F, No.18 3 Section Anhuaxili
Chaoyang District Beijing
100011 CHINA
TEL: (010) 6426-5050

KOREA

KOREA AVICS CO., LTD.
463-3 Sunghwa bldg. 3rd F.,
Seokyo-Dong, Mapo-ku,
Seoul, KOREA
Tel: 02-322-3264

TAIWAN

ROLAND TAIWAN
ENTERPRISE CO., LTD.
Room 5, 9fl. No. 112 Chung Shan
N.Road Sec.2, Taipei, TAIWAN,
R.O.C.
TEL: (02) 2561 3339

SINGAPORE/ MALAYSIA

Roland Asia Pacific Sdn. Bhd.
45-1, Block C2, Jalan PJU 1/39,
Dataran Prima, 47301 Petaling
Jaya, Selangor, MALAYSIA
TEL: 3-7805-3263

CENTRAL/LATIN AMERICA

Roland Systems Group U.S.
425 Sequoia Drive Suite 114,
Bellingham, Washington,
98226 USA
TEL: 360-594-4282

EUROPE

AUSTRIA/GERMANY/
ITALY/IRELAND/
UNITED KINGDOM
EDIROL (Europe) Ltd.
Studio 3.4 114 Power Road
London W4 5PY
U. K.
TEL: (0)20 8747 5949

BELGIUM/FRANCE/
LUXEMBOURG/
SWITZERLAND/
HOLLAND/SPAIN/
PORTUGAL

Roland Iberia, S.L.
Paseo García Faria, 33-35
08005 Barcelona SPAIN
TEL: 93 493 91 00

CROATIA

ART-CENTAR
Degenova 3.
HR - 10000 Zagreb
TEL: (1) 466 8493

CZECH REP.

CZECH REPUBLIC
DISTRIBUTOR s.r.o
Vocáárova 247/16
CZ - 180 00 PRAHA 8,
CZECH REP.
TEL: (2) 830 20270

DENMARK

Roland Scandinavia A/S
Nordhavnsvej 7, Postbox 880,
DK-2100 Copenhagen
DENMARK
TEL: 3916 6200

FINLAND

Roland Scandinavia As,
Filial Finland
Elannontie 5
FIN-01510 Vantaa, FINLAND
TEL: (0)9 68 24 020

NORWAY

Roland Scandinavia Avd.
Kontor Norge
Lilleakerveien 2 Postboks 95
Lilleaker N-0216 Oslo
NORWAY
TEL: 2273 0074

SWEDEN

Roland Scandinavia A/S
SWEDISH SALES OFFICE
Danvik Center 28, 2 tr.
S-131 30 Nacka SWEDEN
TEL: (0)8 702 00 20

HUNGARY

Roland East Europe Ltd.
Warehouse Area 'DEPO' Pf.83
H-2046 Torokbalint, HUNGARY
TEL: (23) 511011

POLAND

ROLAND POLSKA SP. Z O.O.
UL. Gibraltarska 4.
PL-03 664 Warszawa
POLAND
TEL: (022) 679 4419

ROMANIA

FBS LINES
Piata Libertatii 1,
535500 Gheorgheni, ROMANIA
TEL: (266) 364 609

RUSSIA

MuTek
Dorozhnaya ul.3.korp.6
117 545 Moscow, RUSSIA
TEL: (095) 981-4967

SLOVAKIA

DAN Acoustic s.r.o.
Povazská 18.
SK - 940 01 Nové Zámky
TEL: (035) 6424 330

UKRAINE

EURHYTHMICS Ltd.
P.O.Box: 37-a.
Nedecey Str. 30
UA - 89600 Mukachevo,
UKRAINE
TEL: (03131) 414-40

OCEANIA

Roland Corporation
Australia Pty., Ltd.
38 Campbell Avenue
Dee Why West, NSW 2099
AUSTRALIA

For Australia
Tel: (02) 9982 8266
For New Zealand
Tel: (09) 3098 715

NORTH AMERICA

CANADA

Roland Canada Ltd.
(Head Office)
5480 Parkwood Way, Richmond
B. C., V6V 2M4 CANADA
TEL: (604) 270 6626

Roland Canada Ltd.
(Toronto Office)
170 Admiral Boulevard
Mississauga ON L5T 2N6
CANADA
TEL: (905) 362 9707

U. S. A.

Roland Systems Group U.S.
425 Sequoia Drive Suite 114,
Bellingham, Washington,
98226 USA
TEL: 360-594-4282

As of November 1, 2006 (EDIROL-2)



This product must be disposed of separately
at your local waste recycling centre.
Do not dispose of in household waste bin.



Free Manuals Download Website

<http://myh66.com>

<http://usermanuals.us>

<http://www.somanuals.com>

<http://www.4manuals.cc>

<http://www.manual-lib.com>

<http://www.404manual.com>

<http://www.luxmanual.com>

<http://aubethermostatmanual.com>

Golf course search by state

<http://golfingnear.com>

Email search by domain

<http://emailbydomain.com>

Auto manuals search

<http://auto.somanuals.com>

TV manuals search

<http://tv.somanuals.com>