

# USB Audio Capture UA-1000



## Owner's Manual

Before using this unit, carefully read the sections entitled: "IMPORTANT SAFETY INSTRUCTIONS" (p. 2), "USING THE UNIT SAFELY" (pp. 3-4), and "IMPORTANT NOTES" (pp. 5-6). These sections provide important information concerning the proper operation of the unit. Additionally, in order to feel assured that you have gained a good grasp of every feature provided by your new unit, Owner's Manual should be read in its entirety. The manual should be saved and kept on hand as a convenient reference.



Copyright © 2003 ROLAND CORPORATION

All rights reserved. No part of this publication may be reproduced in any form without the written permission of ROLAND CORPORATION.

|   |   |   |
|---|---|---|
|    | <b>CAUTION</b><br>RISK OF ELECTRIC SHOCK<br>DO NOT OPEN |  |
| <b>ATTENTION:</b> RISQUE DE CHOC ELECTRIQUE NE PAS OUVRIR   |   |   |
| <b>CAUTION:</b> TO REDUCE THE RISK OF ELECTRIC SHOCK,<br>DO NOT REMOVE COVER (OR BACK).<br>NO USER-SERVICEABLE PARTS INSIDE.<br>REFER SERVICING TO QUALIFIED SERVICE PERSONNEL. |   |   |



The lightning flash with arrowhead symbol, within an equilateral triangle, is intended to alert the user to the presence of uninsulated "dangerous voltage" within the product's enclosure that may be of sufficient magnitude to constitute a risk of electric shock to persons.



The exclamation point within an equilateral triangle is intended to alert the user to the presence of important operating and maintenance (servicing) instructions in the literature accompanying the product.

INSTRUCTIONS PERTAINING TO A RISK OF FIRE, ELECTRIC SHOCK, OR INJURY TO PERSONS.

## IMPORTANT SAFETY INSTRUCTIONS SAVE THESE INSTRUCTIONS

**WARNING** - When using electric products, basic precautions should always be followed, including the following:

1. Read these instructions.
2. Keep these instructions.
3. Heed all warnings.
4. Follow all instructions.
5. Do not use this apparatus near water.
6. Clean only with a dry cloth.
7. Do not block any of the ventilation openings. Install in accordance with the manufacturers instructions.
8. Do not install near any heat sources such as radiators, heat registers, stoves, or other apparatus (including amplifiers) that produce heat.
9. Do not defeat the safety purpose of the polarized or grounding-type plug. A polarized plug has two blades with one wider than the other. A grounding type plug has two blades and a third grounding prong. The wide blade or the third prong are provided for your safety. When the provided plug does not fit into your outlet, consult an electrician for replacement of the obsolete outlet.
10. Protect the power cord from being walked on or pinched particularly at plugs, convenience receptacles, and the point where they exit from the apparatus.
11. Only use attachments/accessories specified by the manufacturer.
12. Never use with a cart, stand, tripod, bracket, or table except as specified by the manufacturer, or sold with the apparatus. When a cart is used, use caution when moving the cart/apparatus combination to avoid injury from tip-over.
13. Unplug this apparatus during lightning storms or when unused for long periods of time.
14. Refer all servicing to qualified service personnel. Servicing is required when the apparatus has been damaged in any way, such as power-supply cord or plug is damaged, liquid has been spilled or objects have fallen into the apparatus, the apparatus has been exposed to rain or moisture, does not operate normally, or has been dropped.



**For the U.K.**

**WARNING:** THIS APPARATUS MUST BE EARTHED

**IMPORTANT:** THE WIRES IN THIS MAINS LEAD ARE COLOURED IN ACCORDANCE WITH THE FOLLOWING CODE.  
GREEN-AND-YELLOW: EARTH, BLUE: NEUTRAL, BROWN: LIVE

As the colours of the wires in the mains lead of this apparatus may not correspond with the coloured markings identifying the terminals in your plug, proceed as follows:

The wire which is coloured GREEN-AND-YELLOW must be connected to the terminal in the plug which is marked by the letter E or by the safety earth symbol  or coloured GREEN or GREEN-AND-YELLOW.

The wire which is coloured BLUE must be connected to the terminal which is marked with the letter N or coloured BLACK.

The wire which is coloured BROWN must be connected to the terminal which is marked with the letter L or coloured RED.

# USING THE UNIT SAFELY

## INSTRUCTIONS FOR THE PREVENTION OF FIRE, ELECTRIC SHOCK, OR INJURY TO PERSONS

### About ⚠ WARNING and ⚠ CAUTION Notices

|                  |  |
|------------------|--|
| <b>⚠ WARNING</b> | Used for instructions intended to alert the user to the risk of death or severe injury should the unit be used improperly.   |
| <b>⚠ CAUTION</b> | Used for instructions intended to alert the user to the risk of injury or material damage should the unit be used improperly.<br>* Material damage refers to damage or other adverse effects caused with respect to the home and all its furnishings, as well to domestic animals or pets. |

### About the Symbols

|  |  |
|--|--|
|  | The ⚠ symbol alerts the user to important instructions or warnings. The specific meaning of the symbol is determined by the design contained within the triangle. In the case of the symbol at left, it is used for general cautions, warnings, or alerts to danger.         |
|  | The ⓧ symbol alerts the user to items that must never be carried out (are forbidden). The specific thing that must not be done is indicated by the design contained within the circle. In the case of the symbol at left, it means that the unit must never be disassembled. |
|  | The ⚡ symbol alerts the user to things that must be carried out. The specific thing that must be done is indicated by the design contained within the circle. In the case of the symbol at left, it means that the power-cord plug must be unplugged from the outlet.        |

### ALWAYS OBSERVE THE FOLLOWING

#### ⚠ WARNING

- Before using this unit, make sure to read the instructions below, and the Owner's Manual.

---

- Do not open or perform any internal modifications on the unit.

---

- Do not attempt to repair the unit, or replace parts within it (except when this manual provides specific instructions directing you to do so). Refer all servicing to your retailer, the nearest Roland Service Center, or an authorized Roland distributor, as listed on the "Information" page.

---

- Never use or store the unit in places that are:
  - Subject to temperature extremes (e.g., direct sunlight in an enclosed vehicle, near a heating duct, on top of heat-generating equipment); or are
  - Damp (e.g., baths, washrooms, on wet floors); or are
  - Humid; or are
  - Exposed to rain; or are
  - Dusty; or are
  - Subject to high levels of vibration.

---

- This unit should be used only with a rack or stand that is recommended by Roland.

---

- When using the unit with a rack or stand recommended by Roland, the rack or stand must be carefully placed so it is level and sure to remain stable. If not using a rack or stand, you still need to make sure that any location you choose for placing the unit provides a level surface that will properly support the unit, and keep it from wobbling.

#### ⚠ WARNING

- The unit should be connected to a power supply only of the type described in the operating instructions, or as marked on the side of unit.

---

- Use only the attached power-supply cord.

---

- Do not excessively twist or bend the power cord, nor place heavy objects on it. Doing so can damage the cord, producing severed elements and short circuits. Damaged cords are fire and shock hazards!

---

- This unit, either alone or in combination with an amplifier and headphones or speakers, may be capable of producing sound levels that could cause permanent hearing loss. Do not operate for a long period of time at a high volume level, or at a level that is uncomfortable. If you experience any hearing loss or ringing in the ears, you should immediately stop using the unit, and consult an audiologist.

---

- Do not allow any objects (e.g., flammable material, coins, pins); or liquids of any kind (water, soft drinks, etc.) to penetrate the unit.

**⚠ WARNING**

- Immediately turn the power off, remove the power cord from the outlet, and request servicing by your retailer, the nearest Roland Service Center, or an authorized Roland distributor, as listed on the "Information" page when:
  - The power-supply cord, or the plug has been damaged; or
  - If smoke or unusual odor occurs
  - Objects have fallen into, or liquid has been spilled onto the unit; or
  - The unit has been exposed to rain (or otherwise has become wet); or
  - The unit does not appear to operate normally or exhibits a marked change in performance.
- In households with small children, an adult should provide supervision until the child is capable of following all the rules essential for the safe operation of the unit.
- Protect the unit from strong impact. (Do not drop it!)
- Do not force the unit's power-supply cord to share an outlet with an unreasonable number of other devices. Be especially careful when using extension cords—the total power used by all devices you have connected to the extension cord's outlet must never exceed the power rating (watts/amperes) for the extension cord. Excessive loads can cause the insulation on the cord to heat up and eventually melt through.
- Before using the unit in a foreign country, consult with your retailer, the nearest EDIROL/Roland Service Center, or an authorized EDIROL/Roland distributor, as listed on the "Information" page.
- DO NOT play a CD-ROM disc on a conventional audio CD player. The resulting sound may be of a level that could cause permanent hearing loss. Damage to speakers or other system components may result.
- Do not put anything that contains water (e.g., flower vases) on this unit. Also, avoid the use of insecticides, perfumes, alcohol, nail polish, spray cans, etc., near the unit. Swiftly wipe away any liquid that spills on the unit using a dry, soft cloth.

**⚠ CAUTION**

- The unit should be located so that its location or position does not interfere with its proper ventilation.
- Always grasp only the plug on the power-supply cord when plugging into, or unplugging from, an outlet or this unit.
- At regular intervals, you should unplug the power plug and clean it by using a dry cloth to wipe all dust and other accumulations away from its prongs. Also, disconnect the power plug from the power outlet whenever the unit is to remain unused for an extended period of time. Any accumulation of dust between the power plug and the power outlet can result in poor insulation and lead to fire.
- Try to prevent cords and cables from becoming entangled. Also, all cords and cables should be placed so they are out of the reach of children.
- Never climb on top of, nor place heavy objects on the unit.
- Never handle the power cord or its plugs with wet hands when plugging into, or unplugging from, an outlet or this unit.
- Before moving the unit, disconnect the power plug from the outlet, and pull out all cords from external devices.
- Before cleaning the unit, turn off the power and unplug the power cord from the outlet (p. \*\*).
- Whenever you suspect the possibility of lightning in your area, pull the plug on the power cord out of the outlet.
- Whenever you've removed any screws—whether it be when installing a rackmount adaptor—be sure to place the screws out of reach of small children, so they won't be swallowed accidentally.
- Always turn the phantom power off when connecting any device other than condenser microphones that require phantom power. You risk causing damage if you mistakenly supply phantom power to dynamic microphones, audio playback devices, or other devices that don't require such power. Be sure to check the specifications of any microphone you intend to use by referring to the manual that came with it.

(This instrument's phantom power: 48 V DC, 10 mA Max x 2 systems)

# IMPORTANT NOTES

In addition to the items listed under “IMPORTANT SAFETY INSTRUCTIONS” and “USING THE UNIT SAFELY” on pages 2 and 4, please read and observe the following:

## Power Supply

- Do not use this unit on the same power circuit with any device that will generate line noise (such as an electric motor or variable lighting system).
- Before connecting this unit to other devices, turn off the power to all units. This will help prevent malfunctions and/or damage to speakers or other devices.
- Although the LCD and LEDs are switched off when the POWER switch is switched off, this does not mean that the unit has been completely disconnected from the source of power. If you need to turn off the power completely, first turn off the POWER switch, then unplug the power cord from the power outlet. For this reason, the outlet into which you choose to connect the power cord’s plug should be one that is within easy reach.

## Placement

- Using the unit near power amplifiers (or other equipment containing large power transformers) may induce hum. To alleviate the problem, change the orientation of this unit; or move it farther away from the source of interference.
- This device may interfere with radio and television reception. Do not use this device in the vicinity of such receivers.
- Noise may be produced if wireless communications devices, such as cell phones, are operated in the vicinity of this unit. Such noise could occur when receiving or initiating a call, or while conversing. Should you experience such problems, you should relocate such wireless devices so they are at a greater distance from this unit, or switch them off.
- When moved from one location to another where the temperature and/or humidity is very different, water droplets (condensation) may form inside the unit. Damage or malfunction may result if you attempt to use the unit in this condition. Therefore, before using the unit, you must allow it to stand for several hours, until the condensation has completely evaporated.

## Maintenance

- For everyday cleaning wipe the unit with a soft, dry cloth or one that has been slightly dampened with water. To remove stubborn dirt, use a cloth impregnated with a mild, non-abrasive detergent. Afterwards, be sure to wipe the unit thoroughly with a soft, dry cloth.
- Never use benzine, thinners, alcohol or solvents of any kind, to avoid the possibility of discoloration and/or deformation.

## Repairs and Data

- Please be aware that all data contained in the unit’s memory may be lost when the unit is sent for repairs. Important data should always be written down on paper. During repairs, due care is taken to avoid the loss of data. However, in certain cases (such as when circuitry related to memory itself is out of order), we regret that it may not be possible to restore the data, and Roland assumes no liability concerning such loss of data.

## Additional Precautions

- Please be aware that the contents of memory can be irretrievably lost as a result of a malfunction, or the improper operation of the unit. To protect yourself against the risk of losing important data, we recommend that you periodically write down important data you have stored in the unit’s memory on paper.
- Unfortunately, it may be impossible to restore the contents of data that was stored in the unit’s memory once it has been lost. Roland Corporation assumes no liability concerning such loss of data.
- Use a reasonable amount of care when using the unit’s buttons, sliders, or other controls; and when using its jacks and connectors. Rough handling can lead to malfunctions.
- When connecting / disconnecting all cables, grasp the connector itself—never pull on the cable. This way you will avoid causing shorts, or damage to the cable’s internal elements.
- A small amount of heat will radiate from the unit during normal operation.
- To avoid disturbing your neighbors, try to keep the unit’s volume at reasonable levels. You may prefer to use headphones, so you do not need to be concerned about those around you (especially when it is late at night).
- When you need to transport the unit, package it in the box (including padding) that it came in, if possible. Otherwise, you will need to use equivalent packaging materials.
- Use a cable from Roland to make the connection. If using some other make of connection cable, please note the following precautions.
  - Some connection cables contain resistors. Do not use cables that incorporate resistors for connecting to this unit. The use of such cables can cause the sound level to be extremely low, or impossible to hear. For information on cable specifications, contact the manufacturer of the cable.

## Handling CD-ROMs

- Avoid touching or scratching the shiny underside (encoded surface) of the disc. Damaged or dirty CD-ROM discs may not be read properly. Keep your discs clean using a commercially available CD cleaner.

## Copyright

- Unauthorized recording, distribution, sale, lending, public performance, broadcasting, or the like, in whole or in part, of a work (musical composition, video, broadcast, public performance, or the like) whose copyright is held by a third party is prohibited by law.
- When exchanging audio signals through a digital connection with an external instrument, this unit can perform recording without being subject to the restrictions of the Serial Copy Management System (SCMS). This is because the unit is intended solely for musical production, and is designed not to be subject to restrictions as long as it is used to record works (such as your own compositions) that do not infringe on the copyrights of others. (SCMS is a feature that prohibits second-generation and later copying through a digital connection. It is built into MD recorders and other consumer digital-audio equipment as a copyright-protection feature.)
- Do not use this unit for purposes that could infringe on a copyright held by a third party. We assume no responsibility whatsoever with regard to any infringements of third-party copyrights arising through your use of this unit.

\* Microsoft and Windows are registered trademarks of Microsoft Corporation.

\* The screen shots in this document are used in compliance with the guidelines of the Microsoft Corporation.

\* Windows® is known officially as: "Microsoft® Windows® operating system."

\* All product names mentioned in this document are trademarks or registered trademarks of their respective owners.

# Contents

|   |           |
|---|-----------|
| <b>USING THE UNIT SAFELY .....</b>                        | <b>3</b>  |
| <b>IMPORTANT NOTES .....</b>                              | <b>5</b>  |
| <b>Main features .....</b>                                | <b>8</b>  |
| <b>Contents of the package .....</b>                      | <b>9</b>  |
| <b>Panel Descriptions.....</b>                            | <b>11</b> |
| Front panel.....  | 11        |
| Rear panel.....   | 15        |
| <b>Preparations for using the UA-1000.....</b>            | <b>18</b> |
| Installing the driver.....                                | 18        |
| Giving priority to background services .....              | 22        |
| Driver settings.....                                      | 23        |
| <b>Basic connections and settings .....</b>               | <b>26</b> |
| Basic connections.....                                    | 26        |
| Recording a mic or guitar.....                            | 27        |
| Recording onto an external ADAT device.....               | 29        |
| Capturing sound from an external ADAT device .....        | 30        |
| Monitoring 5.1 channel sound.....                         | 31        |
| Inserting an external effects processor .....             | 32        |
| Recording a digital input signal.....                     | 33        |
| Synchronizing to the word clock input.....                | 34        |
| <b>Various settings .....</b>                             | <b>36</b> |
| Internal blocks of the UA-1000 .....                      | 36        |
| UA-1000 Control Panel.....                                | 36        |
| Adjusting the audio latency .....                         | 40        |
| Using ASIO Direct Monitor .....                           | 40        |
| <b>Synchronization settings .....</b>                     | <b>41</b> |
| About the ADAT mode switch and external clock switch..... | 41        |
| <b>System settings .....</b>                              | <b>44</b> |
| Restoring the factory settings (Factory Reset).....       | 44        |
| <b>Troubleshooting.....</b>                               | <b>45</b> |
| Problems related to the USB driver .....                  | 45        |
| Deleting the driver .....                                 | 45        |
| Problems related to the UA-1000 .....                     | 46        |
| <b>Main specifications .....</b>                          | <b>50</b> |
| <b>Block diagram .....</b>                                | <b>51</b> |
| <b>INDEX.....</b>   | <b>53</b> |

# Main features

## 480 Mbps transfer speed with hi-speed USB (USB 2.0), supporting 10 IN/10 OUT at superb 24-bit/96 kHz audio quality

Ten independent channels of simultaneous recording and playback are supported with superb 24-bit/96 kHz audio quality.

If your computer has a USB 2.0 connector, you can implement a cutting-edge recording environment by connecting a single USB cable.

## Four channels of high-performance mic preamp

High-performance mic preamp equivalent to those used on the Roland VS-2480 deliver transparent sound.

The UA-1000 uses the same carefully selected analog parts as on the Roland VS-2480, giving you great audio quality and plenty of recording headroom.

## A rich array of inputs and outputs in a single rack space

Four TRS/XLR combo jacks with phantom power, a high-impedance (Hi-Z) jack for direct connection of a guitar or bass, and optical/coaxial digital input/output connectors are provided.

The optical jacks can also be used as an eight-channel ADAT interface (\*).

In addition, the UA-1000 provides four input/output jacks for effect insertion, MIDI input/output, and word clock input/output jacks for precise recording synchronization with external digital devices.

\* *When the UA-1000 is not connected to a computer, it can function as a multi-channel analog <-> digital converter or an ADAT <-> analog converter.*

\* *The UA-1000's analog inputs cannot be used while in ADAT recording mode.*

## Built-in digital mixer

The internal digital mixer can be controlled directly from the UA-1000 Control Panel on your computer.

The Direct Monitor function allows realtime monitoring of the ten channels of input without passing them through your computer software.

## WDM and ASIO 2.0 compatible

WDM and ASIO 2.0 compatible low-latency driver is provided.

The driver delivers superb performance with any DAW application, such as SONAR and Cubase.

## MIDI interface with FPT ensures high speed and low jitter

FPT (Fast Processing Technology of MIDI Transmission) ensures stable, high-speed transmission and reception with consistent latency and minimal jitter, regardless of the density of MIDI data.



# Contents of the package

## ■ UA-1000



## ■ Power cord

This is the only power cord you should use with the UA-1000. Do not use any power cord other than the supplied one, since doing so may cause malfunction.

## ■ USB cable

Use this to connect the USB connector of your computer with the USB connector of the UA-1000.

- \* Please use only the included USB cable. If you require a replacement due to loss or damage, please contact a "EDIROL/Roland Service Center" listed in the "Information" section at the end of this manual.

## ■ Owner's Manual

This is the manual you are reading. Please keep it on hand for reference.

## ■ CD-ROM

This contains the driver required in order to use the UA-1000.

- \* You must read the license agreement before opening the CD-ROM. Opening the CD-ROM case will be considered acceptance of the license agreement.
- \* Do not touch the recorded (unprinted) surface of the disc or allow it to be scratched. Doing so may render the disc unreadable. If the disc gets dirty, use a commercially available CD cleaner to clean it.

Do not play back the CD-ROM in a conventional audio CD player. Doing so may produce high-volume sound that can damage your hearing and/or speakers.

## Contents of the package

### ■ Rackmount adaptors (two pcs.)

Use this when you want to install the UA-1000 in an audio rack. Two rack ears are included.

#### Attaching the rackmount adaptors

If you want to install the UA-1000 in a rack, attach the rackmount adaptors as shown in the diagram.

1. Remove three screws (on each side) from the right and left panels of the UA-1000.
2. Using the screws you removed in step 1, attach the rackmount brackets to the UA-1000.

\* You must use the screws that you removed. Do not use any other screws.

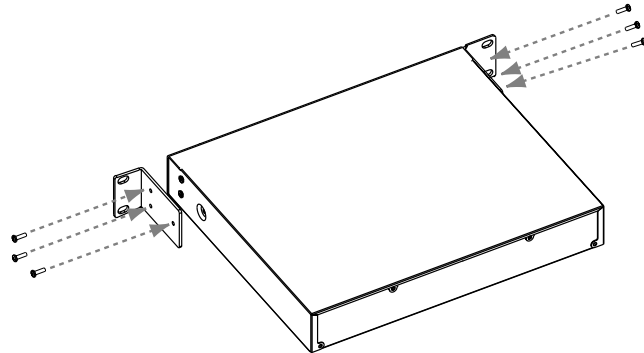

### ■ Ferrite Core (for 230V and 240V)

The ferrite core should be attached to the cord of your headphones.

#### Attaching the Ferrite Core

Before using headphones, make sure to attach the ferrite core.

If you will be using headphones, please follow the instructions below to clamp the supplied ferrite core over the cord. Afterwards, make sure to leave it on the cord, since it serves in blocking electromagnetic noise.

1. Open the ferrite core and position it over the cord.

\* Make sure to position it so it's close to the plug.

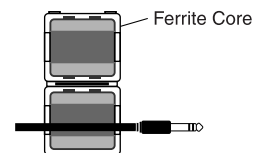

2. Wrap the cord around the ferrite core; one turn is enough.

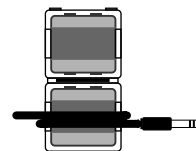

3. Close it firmly; you should hear a distinct sound as it clicks shut.

\* Take care not to get your fingers pinched when attaching the ferrite core.

\* Make sure you don't apply undue force and damage the cord when clamping on the ferrite core.

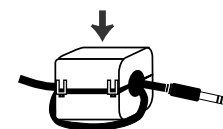

# Panel Descriptions

## Front panel



### 1. Combo input jacks 1–4

These are analog audio input jacks with high-quality preamps. Either XLR type or phone type jacks can be connected here, as appropriate for the equipment you are using. Balanced or unbalanced connections are supported. The XLR type jacks provide 48 V phantom power, allowing you to connect phantom-powered condenser mics. In this case, turn on the phantom power switch.

\* This instrument is equipped with balanced (XLR/TRS) type input jacks. Wiring diagrams for these jacks are shown on the right. Make connections after first checking the wiring diagrams of other equipment you intend to connect.

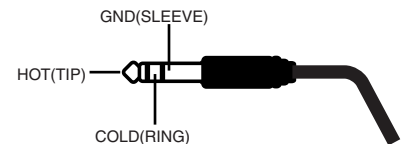
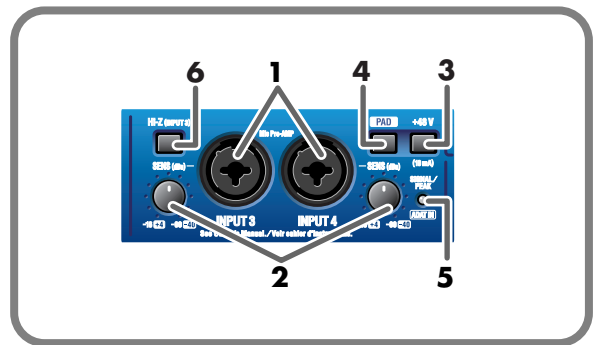

### 2. Input sensitivity knobs

These adjust the input level of the signals that are input to front panel **combo input jacks 1–4** and rear panel **input jacks 5–8**.

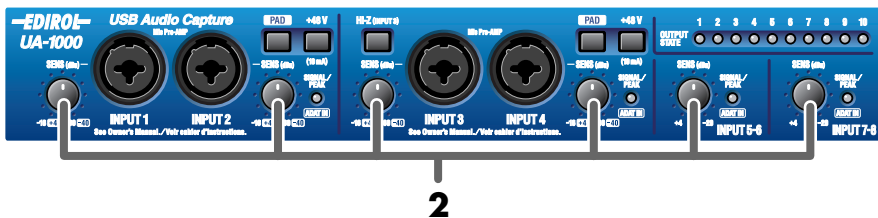

### 3. Phantom power switches 1, 2 (PHANTOM 48 V)

These are on/off switches for the phantom power that is supplied to the XLR type connectors of **combo input jacks 1–2** and **3–4**. Phantom power is on when the switch is pressed inward (☑), and off when the switch is in the outward position (☐).

\* You must turn phantom power off (button in the ☐ outward position) unless a condenser microphone requiring a phantom power supply is connected to the XLR type jacks. Malfunctions will occur if you supply phantom power to a dynamic microphone or to an audio playback device. For details on the specifications of your microphone, refer to the owner's manual for your microphone.

(The UA-1000 supplies phantom power at DC 48 V, maximum 10 mA x 2 systems)

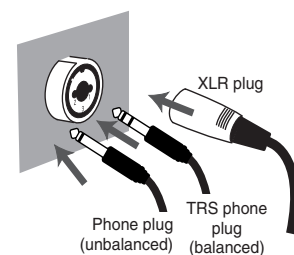



### 4. Gain select switches (PAD)

These switch the input level. Turn these on (button in the ☑ inward position) if you connect devices that have a high output gain.

### 5. Input peak indicators

These indicate whether distortion is occurring in the sound being input to each input jack. The peak indicators will light red at a level before the sound begins to distort (-6 dB). Adjust the corresponding **input sensitivity knob** or the output level of your equipment so that the peak indicators do not light red.

### 6. Input impedance select switch

For the phone jack input of **combo input jack 3**, you can select either high impedance (Hi-Z (button in the  inward position)) or low impedance (Lo-Z (button in the  outward position)), as appropriate for the device that is connected. Select high impedance (Hi-Z) if you have connected a guitar or bass.

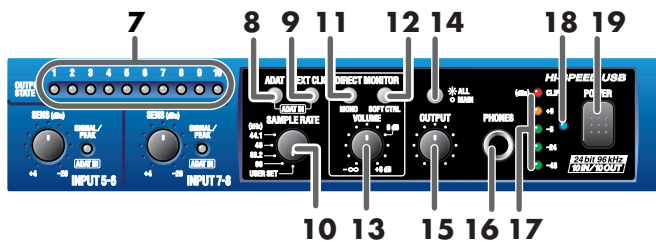

### 7. Output indicators

If audio data is being output from the UA-1000, the output indicator for the jack from which audio data is being output will light. For example, if audio data is being output from output jack 1, output indicator “1” will light green. Indicators “9” and “10” will light to indicate output from the digital output connector.

This provides a convenient way to check the settings of the UA-1000’s internal patch bay. For details, refer to **“Internal blocks of the UA-1000”** (p. 36).

### 8. ADAT mode switch

When you press the ADAT mode switch, the ADAT mode switch will light and the UA-1000 will be in ADAT Output mode; ADAT format signals will be output from the optical digital output jack.

If you simultaneously press the ADAT mode switch and the external clock switch, the PEAK/SIG/ADAT IN indicators will all light orange, and the UA-1000 will be in ADAT Input/Output mode; ADAT format signals will be input from the optical input jack.

*\* If you are using ADAT mode, you must set the UA-1000 to 44.1 kHz or 48 kHz. If a setting other than 44.1 kHz or 48 kHz is selected, ADAT mode will not be available; pressing the ADAT mode switch will not cause the ADAT mode switch to light.*



Turning off the power of the UA-1000 will not change the setting of this switch.



For more about the ADAT mode switch, refer to **“About the ADAT mode switch and external clock switch”** (p. 41).

### 9. External clock switch

Turn this on if you want the UA-1000 to synchronize to a word clock signal from an external device or to a digital signal from the digital input jack. If synchronization is occurring normally, the external clock switch will light, and the UA-1000 will be in external clock mode. If the external clock switch is blinking, synchronization has not been achieved.

You must be sure to input a signal which has the frequency that matches the setting of the sampling frequency select switch.

*\* If both the word clock input connector and the digital input connector are connected simultaneously, the word clock input connector will take priority.*

*\* If you are recording a digital signal, the external clock switch must be turned on.*



Turning off the power of the UA-1000 will not change the setting of this switch.



For more about the external clock switch, refer to **“About the ADAT mode switch and external clock switch”** (p. 41).

## 10. Sampling frequency select switch

This selects the sampling frequency at which audio data will be recorded and played back.

In order for this setting to take effect, you must exit all applications and turn the power of the UA-1000 off, then on again.

The sampling frequency select switch must be set to match the sampling frequency of the application you are using. If you are using external clock mode, this must also match the sampling frequency of your external device.

\* If you are using the UA-1000 in ADAT mode, set this to 44.1 kHz or 48 kHz. If this is set to anything other than 44.1 kHz or 48 kHz, ADAT mode will not be available; pressing the ADAT mode switch will not cause the ADAT mode switch to light.

### USER SET

UA-1000 Control Panel (p. 36) lets you store the following settings in the UA-1000's internal memory.

- ADAT mode switch
- External clock switch
- Sampling frequency select switch
- STEREO/MONO select switch
- Direct monitor soft control switch
- Output volume select switch
- Monitor mixer and patch bay settings

To call up the settings stored in USER SET, set the **sampling frequency select switch** to **USER SET**, then cycle the power to the unit.



For more about the internal monitor mixer and patch bay, refer to “**Various settings**” (p. 36).

## 11. STEREO/MONO select switch (Direct monitor section)

This selects whether the input signal will be monitored in stereo or in monaural.

Even if **MONO** is selected, the audio signal sent via USB to your computer is stereo.



Turning off the power of the UA-1000 will not change the setting of this switch.



If you have connected a mic or guitar to only one of the **combo input jacks**, it is convenient to use the **MONO** setting.

## 12. Direct monitor soft control switch (Direct monitor section)

This selects whether the INPUT MONITOR will be controlled by your software. When lit, the monitor volume, pan, and on/off settings of each input jack can be controlled from your software. When unlit, signals will be output without being affected by any settings of the INPUT MONITOR.

This lets you temporarily disable the settings of your software in order to check the state of connections.

For details on controlling the UA-1000 from your computer, refer to “**UA-1000 Control Panel**” (p. 36).



Turning off the power of the UA-1000 will not change the setting of this switch.



For details, refer to “**UA-1000 Control Panel**” (p. 36).

## 13. Direct monitor volume (Direct monitor section)

This adjusts the volume at which the input signal is sent to the INPUT MONITOR. If you set the knob to the **0 dB** position, the volume will be the same as the signal that is being recorded.

\* For details on the INPUT MONITOR, refer to “**UA-1000 Control Panel**” (p. 36).

If this knob is turned all the way to the left, the signal level sent to the INPUT MONITOR will be **zero**.

If you are “thru-ing” the audio data within your computer, or have connected a mixer and are outputting the input signal directly from the mixer for monitoring, leave this knob turned all the way to the left.



You can adjust the **direct monitor volume** even when the **direct monitor soft control switch** is turned off.

### 14. Output volume select switch

This switches the jacks that will be controlled by the output volume knob. Hold this down for two seconds or longer. If you set this to **MAIN**, the knob adjusts the volume of the main output signal (i.e., all input signals plus the playback signals from the computer mixed).

If you set this to **ALL**, the knob adjusts the volume of all output jacks together.

For details, refer to “**Block diagram**” (p. 51).



Turning off the power of the UA-1000 will not change the setting of this switch.



**Lower the volume of the connected equipment before you change the setting of the output volume select switch.**

### 15. Output volume knob

This adjusts the final volume that is output from the UA-1000.

If the **output volume knob select switch** is set to **MAIN**, this knob adjusts the volume of the main output signal (i.e., all input signals plus the playback signals from the computer mixed). If you set this to **ALL**, the knob adjust the volume of all output jacks together.



For details, refer to “**Block diagram**” (p. 51).

### 16. Headphone jack

A set of headphones can be connected here. The headphone jack will output the main output signal (i.e., all input signals plus the playback signals from the computer mixed by the monitor mixer).

Sound will still be output from the master output jacks even if headphones are connected.



For details, refer to “**Internal blocks of the UA-1000**” (p. 36).

### 17. Output level indicators

These LEDs will light to indicate the output level adjusted by the output volume knob. Adjust the input sensitivity knob of each input jack so that the red LED (CLIP) does not light.

### 18. Power indicator

This indicator will light when the power switch is on.

### 19. Power switch

Press this switch to turn the power on/off.

The power is on when the switch is in the inward position, and off when the switch is in the outward position.

\* *Do not turn off the power switch while your audio application is recording or playing. Doing so may cause your application to freeze.*

Power is on  
when switch is in

Power is off  
when switch is out

## Rear panel

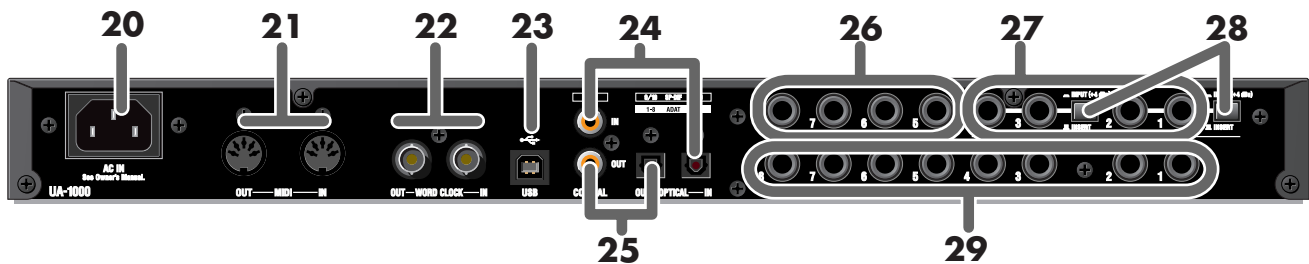

### 20. AC inlet

Connect the included AC cable here. Plug in the cable firmly so that it does not fall out. For details on current consumption, refer to “Main specifications” (p. 50).

### 21. MIDI IN/OUT connectors

Connect these to the MIDI connectors of your MIDI device to receive or transmit MIDI messages.

### 22. WORD CLOCK IN/OUT jacks

Use these jacks to synchronize the UA-1000 with a digital recorder.

If you want to synchronize to WORD CLOCK, you must turn on the external clock switch.

### 23. USB connector

Use a USB cable to connect the UA-1000 to your computer.

*\* Do not plug in or unplug the USB cable while your audio application is recording or playing. Doing so may cause the application to freeze.*

### 24. Coaxial digital input jack / optical digital input jack

Use these jacks to input digital audio from a CD/MD/DAT, etc. If a digital device is connected to the optical digital input jack, the optical digital input jack will be given priority; the signal from the coaxial digital input jack will not be input. Digital signals applied to the digital input connectors are handled as INPUT 9 and 10.

In order to record a digital signal, the external clock switch must be turned on.

If you want to use the optical digital input jack to input ADAT signals, simultaneously press the **ADAT mode switch** and the **external clock switch** to select ADAT Input/Output mode. This allows ADAT format signals to be input from the optical input jack.

### 25. Coaxial digital output jack / optical digital output jack

Use these jacks to send digital audio to a digital audio device such as an MD or DAT. Digital signals output from the digital output connectors are handled as OUTPUT 9 and 10.

If you want to use the optical digital output jack to output ADAT signals, press the **ADAT mode switch** to select ADAT Output mode, or simultaneously press the **ADAT mode switch** and the **external clock switch** to select ADAT Input/Output mode. This allows ADAT format signals to be output from the optical input jack.

### 26. Input jacks 5–8

Connect to these jacks when you want to input audio signals from audio devices or MIDI sound modules.

### 27. Insertion / Input jacks 1–4

These can be used either as insertion jacks or as input jacks.

Turn the Insertion/Input Select switches on/off to select whether these jacks will function as insertion jacks or as input jacks.



For details, refer to “**Inserting an external effects processor**” (p. 32).

### 28. Insertion / Input jack select switches

Turn the Insertion/Input Select switches on/off to select whether insertion / input jacks 1–4 will function as insertion jacks or as input jacks.

For details on use, refer to “**Inserting an external effects processor**” (p. 32).

#### Insertion jack mode:

Set the switch to INSERT (▣ button outward). Insertion/Input jacks 1–4 will function as insertion jacks.

This setting lets you insert external effects processors into the inputs of combo input jacks 1–4 (TRS phone type).

#### Input jack mode:

Set the switch to INPUT (▣ button inward). Insertion/Input jacks 1–4 will function as input jacks.

This setting lets you input audio signals from audio devices or MIDI sound modules (+4 dBu fixed, phone type, unbalanced).



If you use these as input jacks, the input from combo input jacks 1–4 will be turned off.

See also “**Inserting an external effects processor**” (p. 32).

### 29. Output jacks 1–8 (phone)

These are output jacks for analog audio signals.



## Application of AC230 V Power Cord

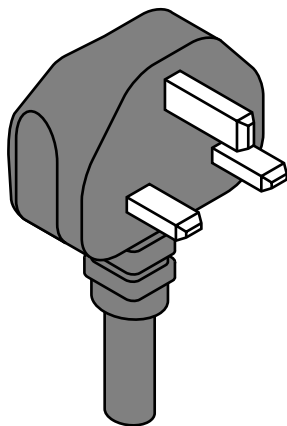

for UK

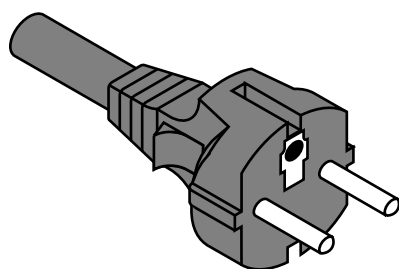

except for UK

# Preparations for using the UA-1000

## Installing the driver

### What is a driver?

A “**driver**” is software that transfers data between the UA-1000 and application software running on your computer, when your computer and the UA-1000 are connected by a USB cable. The driver sends data from your application to the UA-1000, and from the UA-1000 to your application.

1

With the UA-1000 disconnected, start up Windows.

Disconnect all USB cables except for a USB keyboard and USB mouse (if used).  
If you are using virus checking or similar software, be sure to exit it as well.

2

Open the **System Properties** dialog box.

1. Click the Windows **start** menu, and from the menu, select **Control Panel**.
2. In “**Pick a category,**” click “**Performance and Maintenance.**”
3. In “**or pick a Control Panel icon,**” click the **System** icon.

3

Click the **Hardware** tab, and then click [**Driver Signing**].

The **Driver Signing Options** dialog box will appear.

4

Make sure that “**What action do you want Windows to take?**” is set to “**Ignore.**”

If it is set to “**Ignore,**” simply click [**OK**].

If it is not set to “**Ignore,**” make a note of the current setting (“**Warn**” or “**Block**”). Then change the setting to “**Ignore**” and click [**OK**].



5

Click [**OK**] to close the **System Properties** dialog box.

6

Exit all currently running software (applications).

Also close any open windows. If you are using virus checking or similar software, be sure to exit it as well.

### NOTE

You must log on using a user name with an administrative account type (e.g., Administrator). For details on user accounts, please consult the system administrator of your computer.

### MEMO

Depending on how your system is set up, the **System** icon may be displayed directly in the **Control Panel** (the Classic view). In this case, double-click the **System** icon.

### MEMO

If you changed “**What action do you want Windows to take?**,” you must restore the previous setting after you have installed the driver.

**7**

Prepare the CD-ROM.  
Insert the CD-ROM into the CD-ROM drive of your computer.

**8**

Click the Windows **start** button. From the menu that appears, select “**Run...**”

The “**Run...**” dialog box will appear.

**9**

In the dialog box that appears, input the following into the “**Open**” field, and click [**OK**].

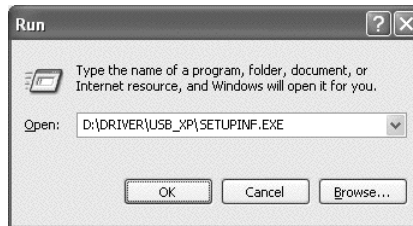

(drive name) :**D**:Driver\USB\_XP\SETUPINF.EXE

\* In the explanatory example shown here, the drive name is given as “**D:**”. The drive name “**D:**” may be different for your system. Specify the drive name of your CD-ROM drive.

**10**

The SetupInf dialog box will appear.  
You are now ready to install the driver.

**11**

Use the USB cable to connect the UA-1000 to your computer.

- 1.** With the **power switch** turned **OFF**, connect the **power cord** to the **UA-1000**.
- 2.** Connect the **power cord** to an electrical outlet.
- 3.** Use the **USB cable** to connect the **UA-1000** to your **computer**.

**12**

Set the UA-1000’s **power switch** to the **ON** position.

Near the task bar, your computer will indicate “**Found New Hardware.**” Please wait.

**13**

The **Found New Hardware Wizard** will appear.

Select “**Install from a list or specific location (Advanced),**” and click [**Next**].

### MEMO

If the screen indicates “**Windows can perform the same action each time you insert a disk or connect a device with this kind of file,**” click [**Cancel**].

### MEMO

**To check the drive name**  
Click the **start** button, and choose **My Computer** from the menu that appears. In the window that appears, check the drive name of the CD-ROM drive into which you inserted the CD-ROM in step 7. The drive name is the (D:) or (E:) displayed by the CD-ROM drive.

### NOTE

Once the connections have been completed, turn on power to your various devices in the order specified. By turning on devices in the wrong order, you risk causing malfunction and/or damage to speakers and other devices.

### MEMO

This unit is equipped with a protection circuit. A brief interval (a few seconds) after power up is required before the unit will operate normally.

## Preparations for using the UA-1000

14

The screen will indicate **“Please choose your search and installation options.”**

Select **“Don’t search. I will choose the driver to install,”** and click **[Next]**.

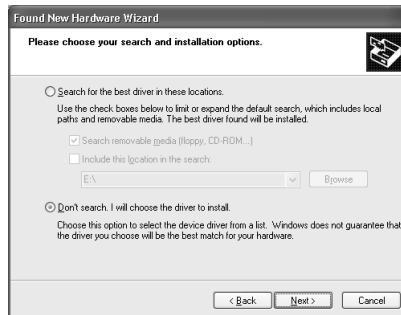

15

Make sure that the **“Model”** field indicates **“EDIROL UA-1000,”** and click **[Next]**. Driver installation will begin.

If the **“What action do you want Windows to take?”** setting was not set to **“Ignore,”** a **“Hardware Installation”** dialog box will appear.

**If “What action do you want Windows to take?” is set to “Warn”**

A dialog box with a **“!**” symbol will appear.

1. Click **[Continue Anyway]**.
2. Continue the installation.

**If “What action do you want Windows to take?” is set to “Block”**

A dialog box with a **“x”** symbol will appear.

1. Click **[OK]**.
2. When the **“Found New Hardware Wizard”** appears, click **[Finish]**.
3. Return to **step 1** (p. 18) and re-install the driver from the beginning of the procedure.

16

The **Insert Disk** dialog box may appear.

Click **[OK]**.

17

The **Files Needed** dialog box will appear.

Input the following into the **“Copy files from”** field, and click **[OK]**.

**D:\DRIVER\USB\_XP**

\* The drive name **“D:”** may be different for your system. Specify the drive name of your CD-ROM drive.



The **Insert Disk** dialog may not appear. In that case, proceed to the next step.

If the **“What action do you want Windows to take?”** setting was not set to **“Ignore,”** a **“Hardware Installation”** dialog box will appear.

A dialog box with a **“!**” symbol will appear.

1. Click **[Continue Anyway]**.
2. Continue the installation.

**18**

The screen will indicate “**Completing the Found New Hardware Wizard.**”

Click [**Finish**].

Wait until “**Found New Hardware**” appears near the taskbar.

**19**

When driver installation has been completed, the **System Settings Change** dialog box will appear.

Click [**Yes**]. Windows will restart automatically.

If you changed the “**What action do you want Windows to take?**” setting, restore the original setting after Windows restarts.

1. Log on to Windows using the user name of an administrative account (e.g., Administrator).
2. Click the Windows **start** button, and from the menu that appears, select **Control Panel**.
3. In “**Pick a category,**” click “**Performance and Maintenance.**”
4. In “**or pick a Control Panel icon,**” click the **System** icon. The **System Properties** dialog box will appear.  
*\* Depending on how your **system** is set up, the **System** icon may be displayed directly in the **Control Panel** (classic view). In this case, double-click the **System** icon.*
5. Click the **Hardware** tab, and then click [**Driver Signing**]. The **Driver Signing Options** dialog box will appear.
6. Return the **What action do you want Windows to take?** setting to the original setting (either “Warn” or “Block”), and click [**OK**].
7. Click [**OK**]. The System properties dialog box will close.

This completes installation of the driver.

Next, make settings so that Windows will give priority to background services, to ensure that audio and MIDI data are processed smoothly.

(-> “**Giving priority to background services**” (p. 22))

# Giving priority to background services

If you fail to make this setting, you may experience interruptions in the sound. To ensure that audio MIDI and processing occurs smoothly, use the following procedure to make settings.

1

Open the **System Properties** dialog box.

1. Click the Windows **start** menu, and from the menu, select **Control Panel**.
2. In “Pick a category,” click “**Performance and Maintenance**.”
3. In “or pick a Control Panel icon,” click the **System** icon.

2

Click the **Advanced** tab.

3

At the right of the **Performance** field, click [**Settings**].

The **Performance Options** dialog box will appear.

4

Click the **Advanced** tab.

5

In the **Processor Scheduling** field, select “**Background services**,” and click [**OK**].

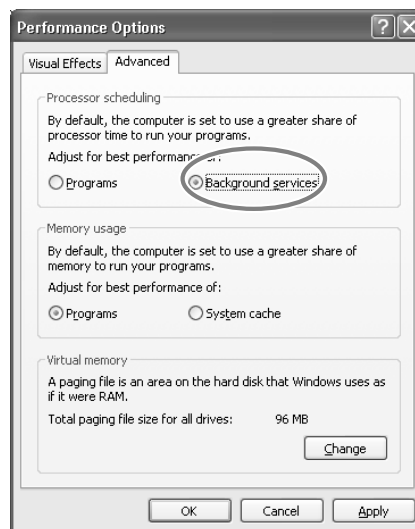

6

In the **System Properties** dialog box, click [**OK**].

The **System Properties** dialog box will close.

Next, make audio device and MIDI device settings.

(->“**Driver settings**” (p. 23))

# Driver settings

---

## About the input/output devices

In order to obtain the best performance from the software you are using, you must specify the correct audio and MIDI input/output destinations.

The audio driver supports WDM/ASIO2.0/MME.

### Audio device

|                     |                             |      |
|---------------------|-----------------------------|------|
| Audio output device | EDIROL UA-1000              | WDM  |
|                     | MME EDIROL UA-1000 1-2 Out  | MME  |
|                     | MME EDIROL UA-1000 9-10 Out |      |
| Audio input device  | EDIROL UA-1000              | WDM  |
|                     | MME EDIROL UA-1000 1-2 In   | MME  |
|                     | MME EDIROL UA-1000 9-10 In  |      |
|                     | MME EDIROL UA-1000 Mon      |      |
| ASIO audio device   | EDIROL UA-1000              | ASIO |

### MIDI device

|                 |   |
|-----------------|---|
| MIDI OUT device | EDIROL UA-1000  |
|                 | If you specify UA-1000 MIDI OUT as the output port for your sequencer software, messages will be transmitted from the MIDI OUT connector of the UA-1000 itself. |
| MIDI IN device  | EDIROL UA-1000  |
|                 | If you specify UA-1000 MIDI IN as the input port for your sequencer software, messages will be input from the UA-1000's MIDI IN connector.                      |

*If you are unable to select the UA-1000 device in the device settings of your software, it is possible that the UA-1000 driver was not installed correctly. Please reinstall the driver.*

### WDM

Use this for the following applications or purposes.

- Conventional applications such as Media Player  
(For details on settings, refer to "Settings when using the Windows Media Player").
- WDM driver mode compatible applications such as SONAR
- DirectSound compatible applications
- Playing back WMA Professional format 5.1 channel files in Media Player  
(In "Control Panel" -> "Sounds and Audio Devices" -> "Audio" tab -> "Advanced" button in "Sound playback" -> "Speaker setup," select "5.1 surround sound speakers")

\* Stereo audio signals will be input and output from WAVE OUT 1-2 and WAVE IN 1-2. In other cases, use "MME."

### ASIO

Use this when using the UA-1000 with an ASIO-compatible application such as Cubase.

In the ASIO settings of your application, select "EDIROL UA-1000." You will be able to use 12 inputs and 10 outputs.

- \* To prevent audio loops or double monitoring, turn off monitoring in your application or select "Use ASIO Direct Monitor."
- \* When using the UA-1000 with ASIO, we recommend that you set your application so that it does not use the Microsoft GS Wavetable SW Synth. (In order to decrease the load, and for convenience when changing the driver buffer size)

### MME

Normally you should use WDM or ASIO.

Use this in the following cases when using an application that does not support WDM driver mode or ASIO (e.g., Cool Edit).

- Recording or playing 24-bit data
- Using something other than the UA-1000's WAVE OUT 1-2 and WAVE IN 1-2

### Input/output device settings

If you are using the UA-1000 with the Media Player included with Windows, use the following procedure to make input/output device settings.

The method for making device settings will depend on the software you are using. For details, refer to the owner's manual for your software.

1

Open the **Sounds and Multimedia Properties** dialog box.

1. Click the Windows **start** menu, and from the menu, select **Control Panel**.
2. In "Pick a category," click "Sound, Speech, and Audio Devices."
3. In "or pick a Control Panel icon," click the **Sounds and Audio Devices** icon.

2

Click the **Audio** tab.

3

In Sounds and Audio Devices Properties, click each Default device field and choose the following device from the list that appears.

|                            |                |
|----------------------------|----------------|
| <b>Sound playback</b>      | EDIROL UA-1000 |
| <b>Sound recording</b>     | EDIROL UA-1000 |
| <b>MIDI music playback</b> | EDIROL UA-1000 |

4

Click **[OK]** to close the **Sounds and Multimedia Properties** dialog box.

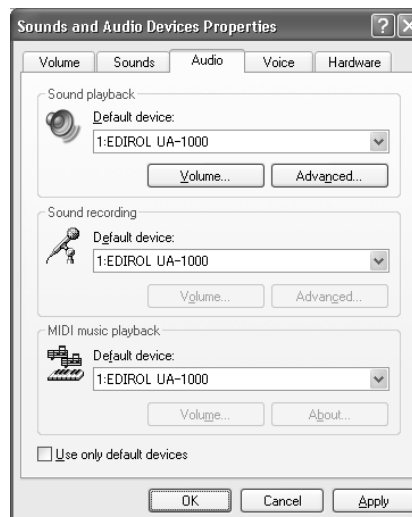

The completes the driver settings.

#### MEMO

Depending on how your system is set up, the **sounds and Audio Devices** icon may be displayed directly in the **Control Panel** (the Classic view). In this case, double-click the **Sounds and Audio Devices** icon.

#### MEMO

If you are using sequencer software, you will need to make audio and MIDI device settings in your software. For details, refer to the owner's manual for your software.



## Check whether there is sound

Now we will play back the sample data to check whether connections and settings are correct.

Here we will use standard Windows functionality to play back the sample data. The sample data is found on the CD-ROM.



Use of the song data supplied with this product for any purpose other than private, personal enjoyment without the permission of the copyright holder is prohibited by law. Additionally, this data must not be copied, nor used in a secondary copyrighted work without the permission of the copyright holder.

1

Insert the CD-ROM into the CD-ROM drive of your computer.

2

From the **SampleSong** folder of the CD-ROM, drag **TTears(.mp3)** to your desktop, copying it.

3

Right-click the copied file **TTears(.mp3)**, and select **Play**.

Play back the sample data.

Click the Preview tab, and then click the button.

### MEMO

What you actually see on your computer screen may be different depending on your computing environment and the operating system you are using.

### MEMO

If it did not play back correctly, refer to “**Troubleshooting**” (p. 45) to determine the reason.

If it was played back correctly, this means that the computer and the UA-1000 are connected correctly and that the drivers have been installed correctly.

## About the demo songs

When playing the demo songs (other than the MP3 songs) in the SampleSong folder of the CD-ROM, please note the following points to ensure that the songs play correctly.

Copy the demo songs to the hard disk of your computer, and then load them into your sequencer for playback.

- The demo songs were produced at 48 kHz. Set the UA-1000's sampling frequency to 48 kHz. If you change the sampling frequency, you need to switch off the UA-1000, then turn it back on again.
- If you use the Cubase SX demo version to play back the Cubase demo songs, the playback will not be correct, since some functions, such as effects, will not be available.

# Basic connections and settings

This chapter explains basic connections for the UA-1000 and describes the data flow.

\* To prevent malfunction and/or damage to speakers or other devices, always turn down the volume, and turn off the power on all devices before making any connections.

## Basic connections

Use a USB cable to connect the UA-1000 to your computer.

Connecting the USB cable allows both MIDI data and audio data to be transferred.

As shown in the diagram, you can connect headphones and/or monitor speakers to monitor the playback of your software or the sound of the instruments or audio devices connected to the UA-1000.

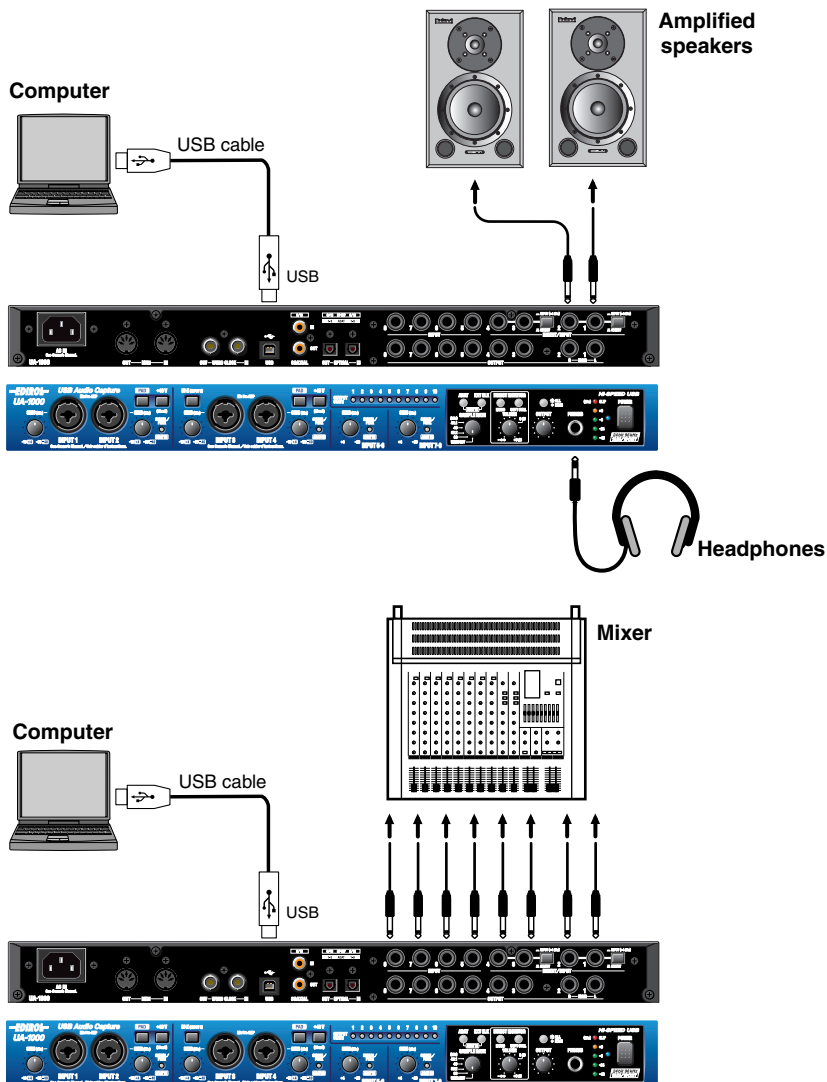

In the **OUTPUT PATCH BAY** section of UA-1000 Control Panel, set **OUTPUT 1-2** to **“MONITOR OUT.”**

(->“Various settings” (p. 36))

When using a mixer

In the **OUTPUT PATCH BAY** section of UA-1000 Control Panel, set **OUTPUT 1-2** to **WAVE OUT 1-2**, **OUTPUT 3-4** to **WAVE 3-4** ... **OUTPUT 7-8** to **WAVE 7-8**.

### About the sampling frequency select switch

- You must set the UA-1000’s **sampling frequency select switch** to the sampling frequency used by your software.
- After you change the setting of the sampling frequency select switch, you must switch off the UA-1000, then turn it on again.

## Recording a mic or guitar

With the setup shown below, you can listen to the audio data played back by your computer while you perform on the guitar (or mic), and record only the guitar (or vocal) performance on your computer.

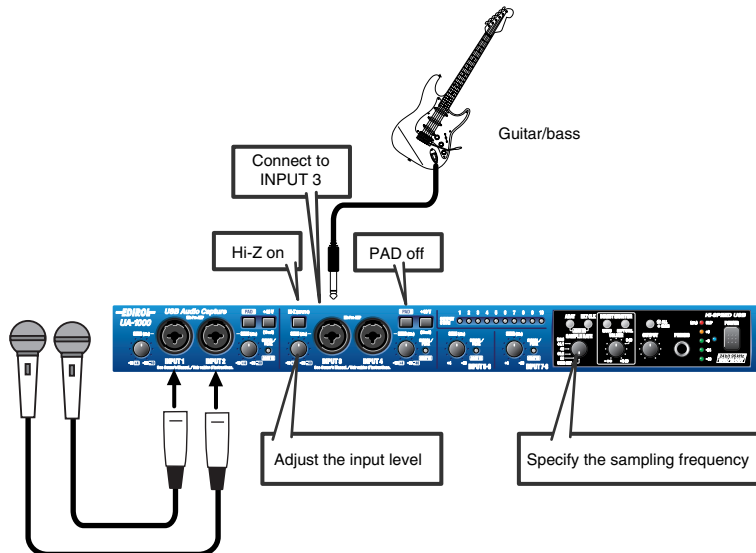

- **Connections**

The sound of the device connected to INPUT 1 will be recorded on the left (L) channel of your computer. If you connect to INPUT 2, the sound will be recorded on the right (R) channel. Connect your guitar to INPUT 3.

- **Sampling frequency select switch**

Set this to the sampling frequency that is selected in your recording software.

- **Input impedance select switch**

**If using a mic**

select Lo-Z.

**If using a guitar**

select Hi-Z.

- **STEREO/MONO select switch (Direct monitor section)**

Set this to specify whether you will monitor the input signal in stereo or in monaural.

- **Direct monitor soft control switch**

Turn this on if you want to control the INPUT MONITOR from your software.

For details, refer to “UA-1000 Control Panel” (p. 36).

- **Direct monitor volume**

Adjust the monitor volume appropriately.

- **Phantom power switch**

If you are using a condenser mic, turn the phantom power switch on.

\* If you have connected a device that does not require phantom power, you must turn off the phantom power switch; failing to do so will damage your equipment.

## Basic connections and settings

### ● Input sensitivity knob

Use the input sensitivity knob to adjust the input level. To obtain the best audio quality, adjust **the input sensitivity knob** until the level is as high as you can get it without causing the input peak indicator to light.

### ● Output volume select switch

Select either MAIN or ALL.

If you select **MAIN**, you will be able to adjust the volume of the main output signal (all input signals and the playback signals from the computer mixed).

If you select **ALL**, you will be able to adjust the volume of all output jacks together.



Lower the volume of your connected equipment before you change the setting of the output volume select switch.

### ● Other cautions

Do not connect anything to input jacks you are not using.

Howling could be produced depending on the location of microphones relative to speakers. This can be remedied by:

1. Changing the orientation of the microphone(s).
2. Relocating microphone(s) at a greater distance from speakers.
3. Lowering volume levels.

## Recording onto an external ADAT device

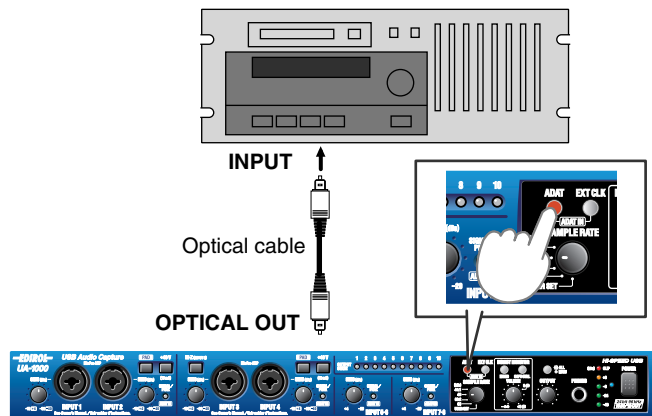

- **Connections**

Connect an optical cable from the OPTICAL OUT jack.

- **Sampling frequency select switch**

Select either 44.1 kHz or 48 kHz.

- **ADAT mode switch**

Press the **ADAT mode switch** to turn it on.

\* By pressing the **external clock mode switch** in ADAT mode, you can use ADAT Output mode to synchronize the word clock or digital input to an external device.

If you turn on the external synchronization mode switch when using ADAT output mode, the output to the ADAT will be synchronized to the word clock from the external device or to the clock of the digital input.

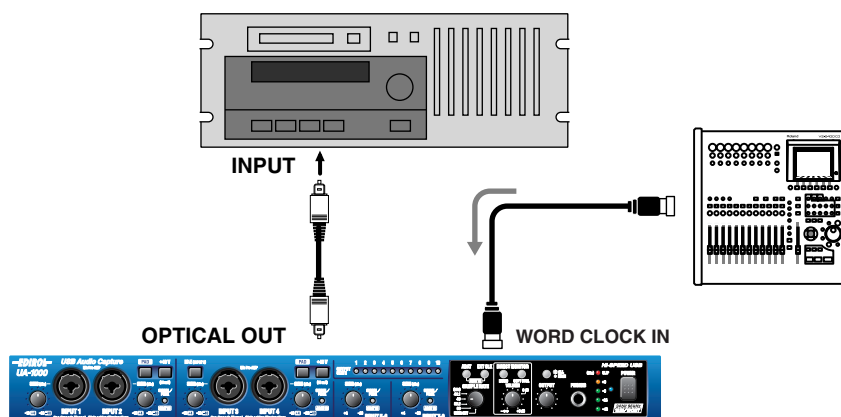

\* If the **word clock input connector** and the **digital input connector** are both connected, the **word clock input connector** will take priority for synchronization.

## Capturing sound from an external ADAT device

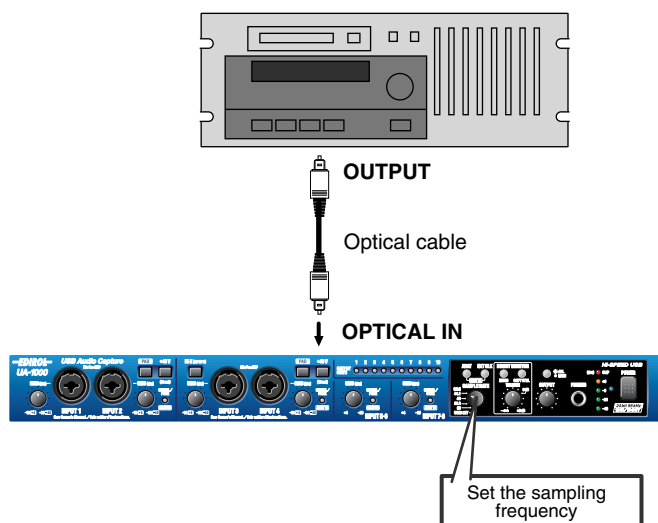

- **Connections**

Connect an optical cable to the OPTICAL IN jack.

- **Sampling frequency select switch**

Select either 44.1 kHz or 48 kHz.

Set this to the same sampling frequency as specified for your ADAT or recording software.

- **ADAT mode switch and external clock switch**

Simultaneously press the **ADAT mode switch** and **external clock switch**.

The PEAK/SIG/ADAT IN indicators will light orange simultaneously.

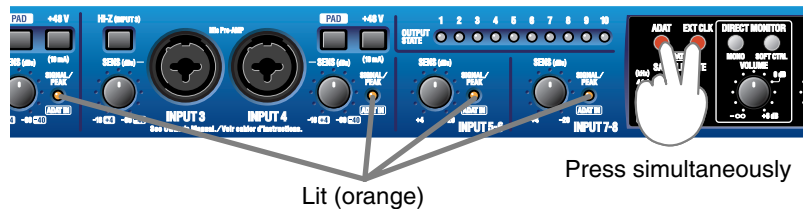

When audio signals are input from the ADAT to the UA-1000, the PEAK/SIG/ADAT IN indicators will light green.

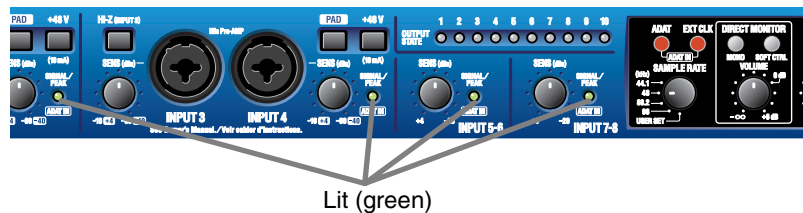

\* If the word clock input connector is connected, the word clock input connector will take priority for synchronization. In this case, the ADAT connected to the digital input connector must also be synchronized to the word clock.

## Monitoring 5.1 channel sound

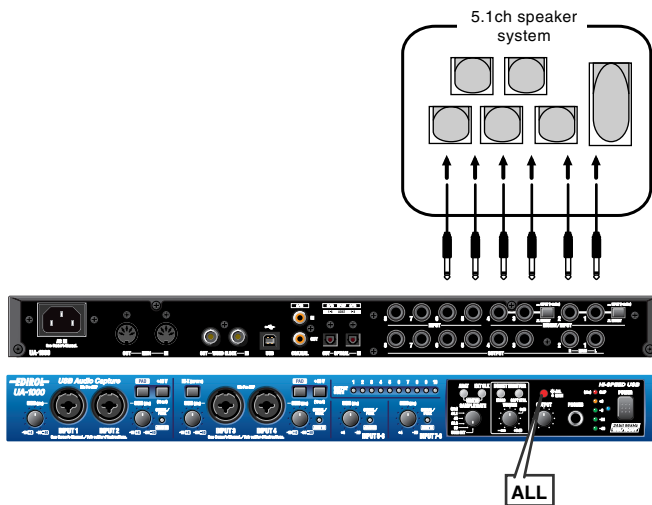

- **Connections**

Connect phone jack audio cables to the output jacks.

- **Output volume select switch**

Press the **output volume select switch** to select ALL (lit).

- **Output volume knob**

Use the knob to adjust the volume level of signal that is output from the output jacks.

- **UA-1000 internal patching**

Set patch bay as follows in UA-1000 Control Panel.

\* For details on UA-1000 Control Panel, refer to “**Various settings**” (p. 36).

In the **PATCH BAY** area of UA-1000 Control Panel set **OUTPUT 1-2** to **WAVE OUT 1-2**, **OUTPUT 3-4** to **WAVE OUT 3-4**, **OUTPUT 5-6** to **WAVE OUT 5-6**.

### Settings in Windows

1. From the Windows **Control Panel**, open **Sound and Audio Devices Properties**.  
(-> “**Input/output device settings**” (p. 24))
2. Click the **Audio** tab.  
In **Sound Playback**, click the **Default Device** field, and choose **EDIROL UA-1000** from the list that appears.
3. In **Sound Playback**, click [**Advanced**].
4. Click the **Speakers** tab.  
Select **5.1 surround sound speakers** as **Speaker setup**.
5. Click [**OK**] to close the **Advanced Audio Properties** dialog box.
6. Click [**OK**] to close the **Sounds and Audio Devices Properties** dialog box.

\* In your software, select 6-speaker mode, 5.1 ch surround sound mode, etc.

# Inserting an external effects processor

If you want to use an external effects processor to process the sound of a mic or guitar being input from each inputs, you can use the rear panel **insertion/input jacks 1–4** as insertion jacks.

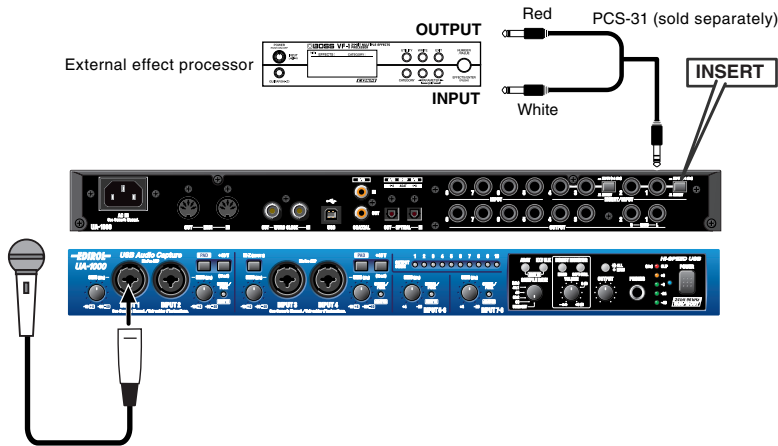

### ● Connections

Connect insertion cables to the rear panel **insertion/input jacks 1–4**, and connect the other end of the cable to your external effects processor.

You will need to use special insertion cables. (Sold separately: Roland PCS-31)

### ● Insertion/Input jack select switch

Since you will be using insertion/input jacks 1–4 as insertion jacks, select **INSERT** ( (  button outward).

### Signal flow

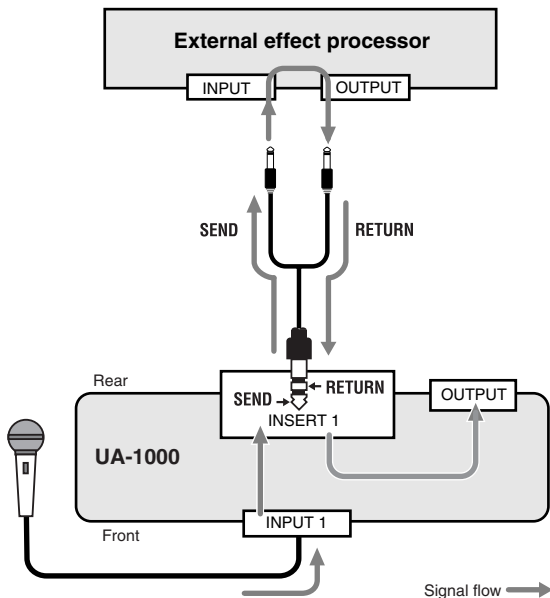



## Recording a digital input signal

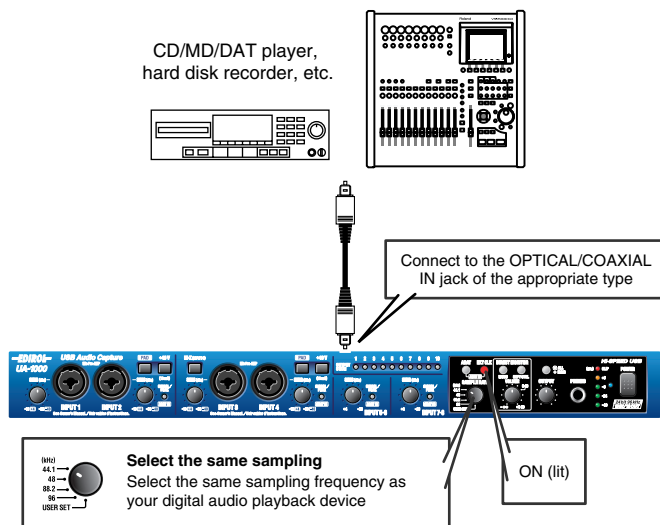

### ● Connections

Connect your digital audio device to either the coaxial digital input jack or the optical digital input jack, as appropriate for your device.

### ● Sampling frequency select switch

Set this to the same frequency as selected on your digital playback device and your recording software.

### ● External clock switch

So that the UA-1000 will synchronize to the digital signal being input to the digital input jack, turn this on (lit).

### ● Direct monitor soft control switch

Turn this on if you want to control the INPUT MONITOR from your software.

For details, refer to “UA-1000 Control Panel” (p. 36)

### ● Direct monitor volume

Adjust the volume appropriately.

# Synchronizing to the word clock input

### Word clock and sampling frequency

An analog audio signal is converted into a digital audio signal by sampling the level of the analog signal at extremely small increments of time, and converting this level into digital data. The sampling frequency is the number of times this AD (analog to digital) conversion is performed each second. Higher sampling frequencies allow better audio quality, but will also increase the amount of data.

In order for two or more devices to accurately process a digital audio signal, all of the devices must be operating at the identical sampling frequency. This can be ensured by sending a word clock signal to the devices. In order for two or more devices to be synchronized, they must be in the appropriate Word Clock Master and Word Clock Slave relationship.

## Using the UA-1000 as the master

In the setup shown here, the UA-1000 is the master, and the external device (e.g., hard disk recorder) is the slave.

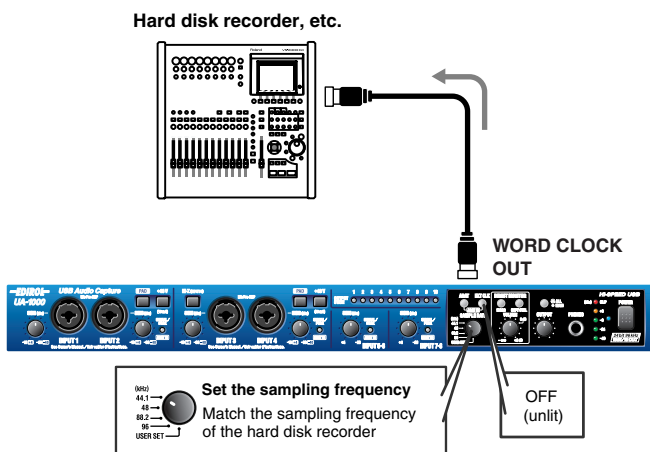

- **Connections**

Connect the WORD CLOCK OUT jack to your hard disk recorder.

- **Sampling frequency select switch**

Set this to the same sampling frequency as selected on your hard disk recorder and recording software.

- **External clock switch**

Turn this off (unlit) so that the external device will synchronize to the digital signal output from the UA-1000 (i.e., the UA-1000 will be the master).

## Using an external device as the master

In the setup shown here, the hard disk recorder or other external device is the master, and the UA-1000 is the slave.

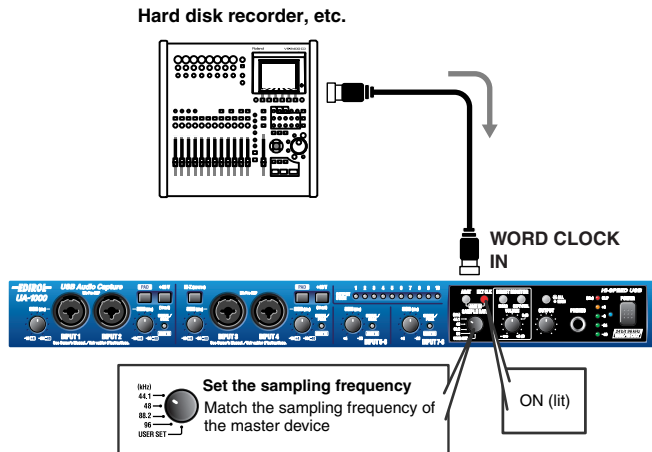

- **Connections**

Connect your external device (e.g., hard disk recorder) to the WORD CLOCK IN jack.

- **Sampling frequency select switch**

Set this to the same sampling frequency as selected for the master device.

- **External clock switch**

Turn this on (lit) so that the UA-1000 will synchronize to the digital signal input to the WORD CLOCK IN connector (i.e., the UA-1000 will be the slave).

# Various settings

You can make various settings for the UA-1000 from your computer.

Use UA-1000 Control Panel to make settings. This lets you control the UA-1000's monitor mixer on/off, volume, on/off, and pan settings. You can also specify the patching.

In addition, you can make the settings described in “Adjusting the audio latency” (p. 40) and “Using ASIO Direct Monitor” (p. 40).

## Internal blocks of the UA-1000

The UA-1000 contains two types of mixer and two patch bays.

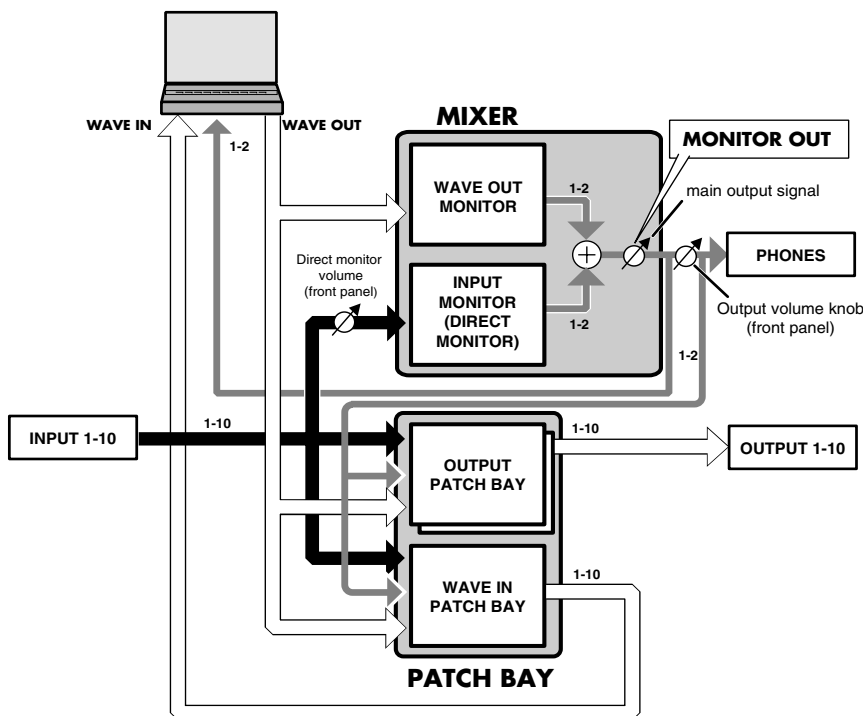

For details, refer to “Block diagram” (p. 51).

## UA-1000 Control Panel

UA-1000 Control Panel is installed together with the driver when you install the UA-1000 Driver.

Here we will provide only an overview. For details, refer to the README\_E.HTM file the Driver -> USB\_XP folder of the CD-ROM.

### Starting up

1. From the Windows **start menu**, choose **Control Panel**.
2. Click “**Switch to Classic View**” to select the Classic view. Depending on your system, Classic view may already be selected. If so, proceed to the next step.
3. In the **Control Panel**, double-click the **EDIROL UA-1000** icon.  
The UA-1000 Control Panel will appear.



## Screen items and what they do

### Main window

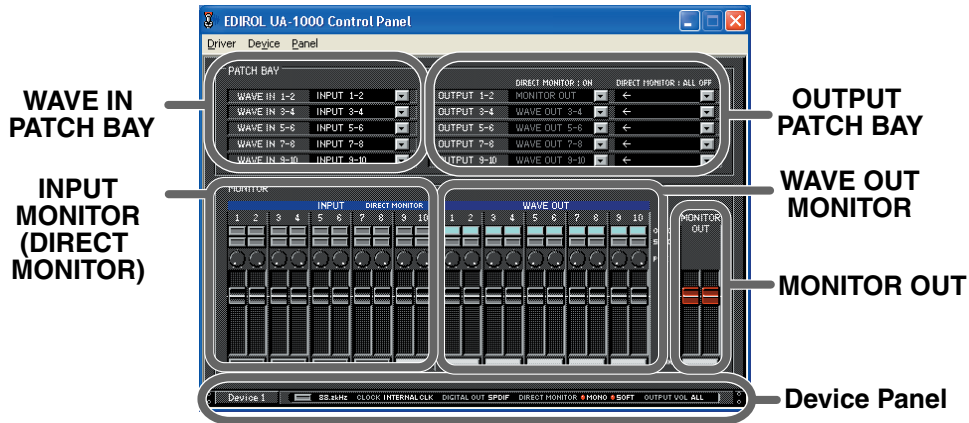

You can use UA-1000 Control Panel to control each block of the UA-1000.

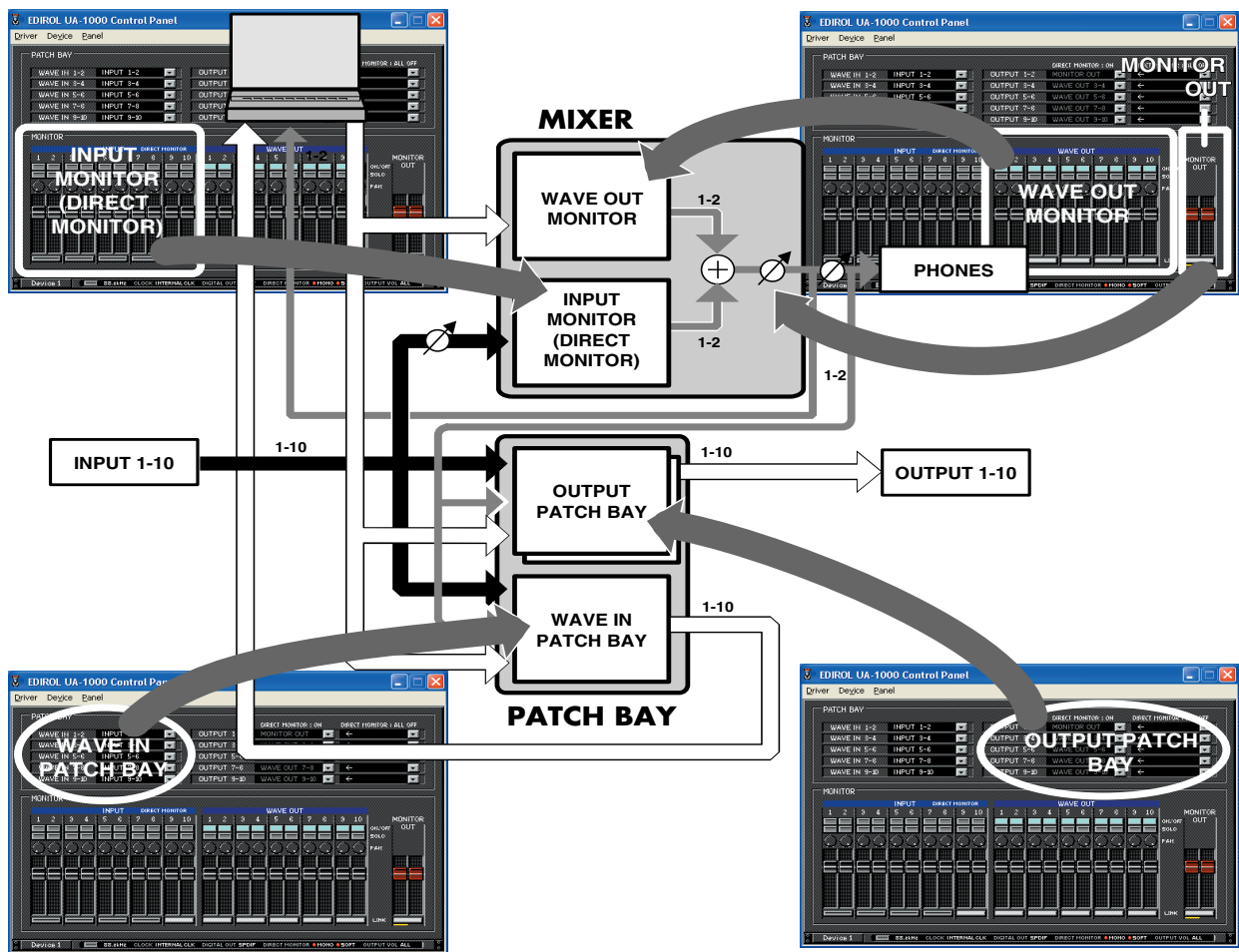

### WAVE IN PATCH BAY

Here you can select the input source audio signals that will be sent to the computer. Choose from the five stereo channels of audio data sent from the computer, the audio data input from the UA-1000's input jacks 1–10, and MONITOR OUT to specify the channels that will be sent to the computer.

### OUTPUT PATCH BAY

Here you can select the signals that will be sent to each output jack of the UA-1000. For each output jack, you can choose from the five stereo channels of audio data sent from the computer, the audio data from the UA-1000's input jacks 1–10, and MONITOR OUT.

### INPUT MONITOR (DIRECT MONITOR)

Here you can control the monitor level and balance of the audio data that is input from the UA-1000's input jacks 1–10.

These settings will be ignored if the front panel Direct Monitor Soft Control switch is off.



### WAVE OUT MONITOR

This controls the balance of the five stereo channels of audio data sent from the computer, and sends the resulting signal to the monitor section (e.g., headphones).

### Device Panel

This area shows the state of the various panel switches of the device.

When you click a setting button, the panel switch setting window will appear.

## Writing to USER SET

From UA-1000 Control Panel you can write the following settings into the UA-1000's internal memory (USER SET), and recall them when desired.

- ADAT mode switch
- External Clock switch
- Sampling frequency selection
- STEREO/MONO select switch
- Direct Monitor Soft Control switch
- Output volume select switch
- Monitor mixer and patch bay settings

1. Start up UA-1000 Control Panel.  
(->“Starting up” (p. 36))
2. From the **Device** menu, choose **Store USER SET of Device**.  
Make the appropriate settings in the dialog box that appears.
3. Click [OK] to write the settings to the **USER SET**.
4. The **USER SET** settings will be loaded when you power-on the UA-1000 with its **sampling frequency select switch** to USER SET.

The UA-1000 supports 192 kHz playback.

#### STEPS

1. If the UA-1000's USER SET has already been modified, restore it to the factory settings (p. 44).
2. Set the UA-1000's sampling frequency select switch to USER SET, and power-on the UA-1000.

\* 192 kHz recording is not supported.

\* You will be able to output only to output jacks 1/2 and the headphone jack.

## Reading and writing memories

Five sets of UA-1000 settings can be stored within the UA-1000 itself. These stored memories can be read and written from UA-1000 Control Panel.

For the procedure, refer to README\_E.HTM on the included CD-ROM.

## Convenient ways to use the OUTPUT PATCH BAY

You can store two different settings for the OUTPUT PATCH BAY, and switch between these two settings.

### DIRECT MONITOR: ON

If even one **INPUT MONITOR (DIRECT MONITOR)** switch is **ON**, the **DIRECT MONITOR: ON** settings of the **OUTPUT PATCH BAY** will be used.

\* These settings will always be used if the **Direct Monitor Soft Control switch** of the UA-1000's front panel is **turned off**.

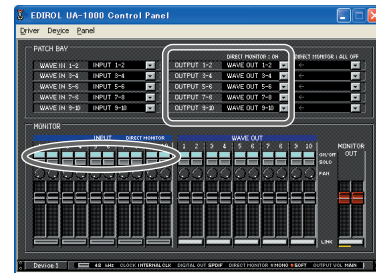

### DIRECT MONITOR: OFF

If all of the **INPUT MONITOR (DIRECT MONITOR)** switches are **OFF**, the **DIRECT MONITOR: OFF** settings of the **OUTPUT PATCH BAY** will be used.

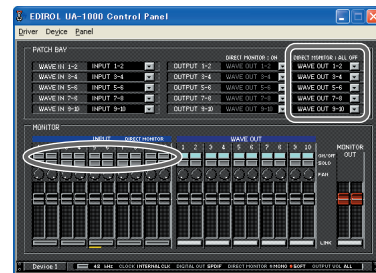

## Examples of use

Simply by switching **INPUT MONITOR (DIRECT MONITOR)** on/off, you can switch between settings for monitoring and settings for mastering.

### Settings for monitoring

These settings are appropriate when you want to hear the sounds being input to the UA-1000 from the input jacks.

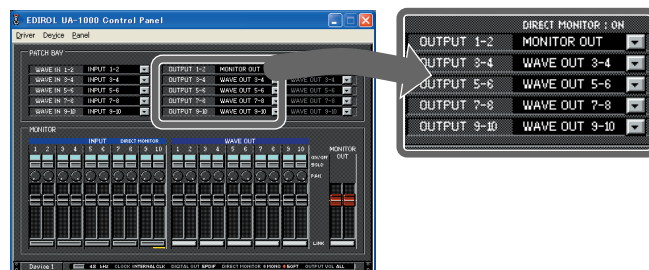

### Settings for mastering

These settings are appropriate when you have finished acquiring audio from the input jacks, and are mastering the data on your computer.

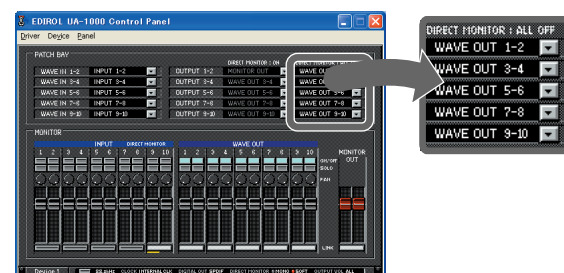

# Adjusting the audio latency

You can change the driver settings to adjust the latency of the audio. To adjust the latency, change the Buffer Size in the driver settings dialog box. Latency is the time delay from when an application plays back audio data until the sound is actually heard from an audio device such as the UA-1000.

1. In UA-1000 control panel, click the **Driver** menu, select **Driver settings**.

Open the “**Driver Settings**” dialog box.

Adjust the driver buffer size.

2. Set “**Audio Buffer Size**” to the far left (Min).

Click **[OK]** to close the **driver settings** dialog box.

3. Restart the application that is using the UA-1000.

If you are using an application that has a function for testing audio devices, get it to perform its tests.

4. Play back audio data on your application.

If interruptions occur in the sound, repeat this procedure, and gradually increase the buffer size specified in step 2 until interruptions no longer occur.

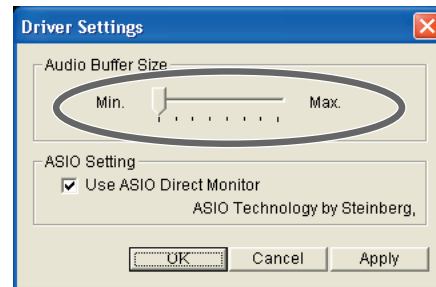

\* Depending on the application you are using, there may be a buffer size or latency adjustment function among the audio settings of the application as well. For details, refer to the operation manual for your application.

# Using ASIO Direct Monitor

If you are using the UA-1000 in Advanced mode from an ASIO 2.0 compatible application, the UA-1000's Input Monitor select switch can be controlled from your ASIO 2.0 compatible application.

1. In UA-1000 control panel, click the **Driver** menu, select **Driver settings**.

Open the “**Driver Settings**” dialog box.

2. Check the “**Use ASIO Direct Monitor**” check box.

3. Click **[OK]** to close the driver settings dialog box.

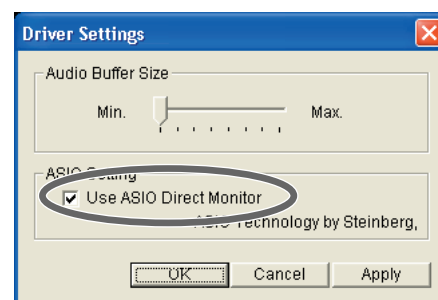

\* Depending on your application, there may also be an ASIO Direct Monitor setting among the audio settings of your application. For details, refer to the operation manual for your application.

\* When using ASIO Direct Monitor, monitoring may switch on/off at unexpected times, depending on the application settings and on the recording procedure. If this occurs, uncheck the check box in step 2 to disable ASIO Direct Monitor.



# Synchronization settings

## About the ADAT mode switch and external clock switch

### ■ ADAT mode switch

#### ADAT Output mode

When you press the ADAT mode switch, the ADAT mode switch will light, and the UA-1000 will be in ADAT Output mode.

The signals being output to jacks 1–8 will be converted to ADAT format and sent from the optical digital output jack. The signals will simultaneously be sent from output jacks 1–8 as well.

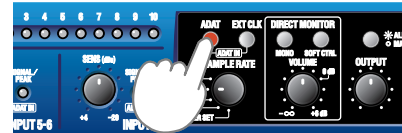

- \* You can use the digital input jack (coaxial, optical) and analog input jacks as usual.
- \* The coaxial digital output jack will not be available.
- \* Set the **sampling frequency select switch** and the sampling frequency setting of your application to 44.1 kHz or 48 kHz. If a setting other than 44.1 kHz or 48 kHz is selected, ADAT mode will not be available; pressing the **ADAT mode switch** will not place the unit in ADAT mode, nor will the ADAT mode switch light.

While in ADAT mode, you can press the **external clock switch** to synchronize the word clock or digital input to an external device in ADAT mode.



#### Internal blocks in ADAT output mode

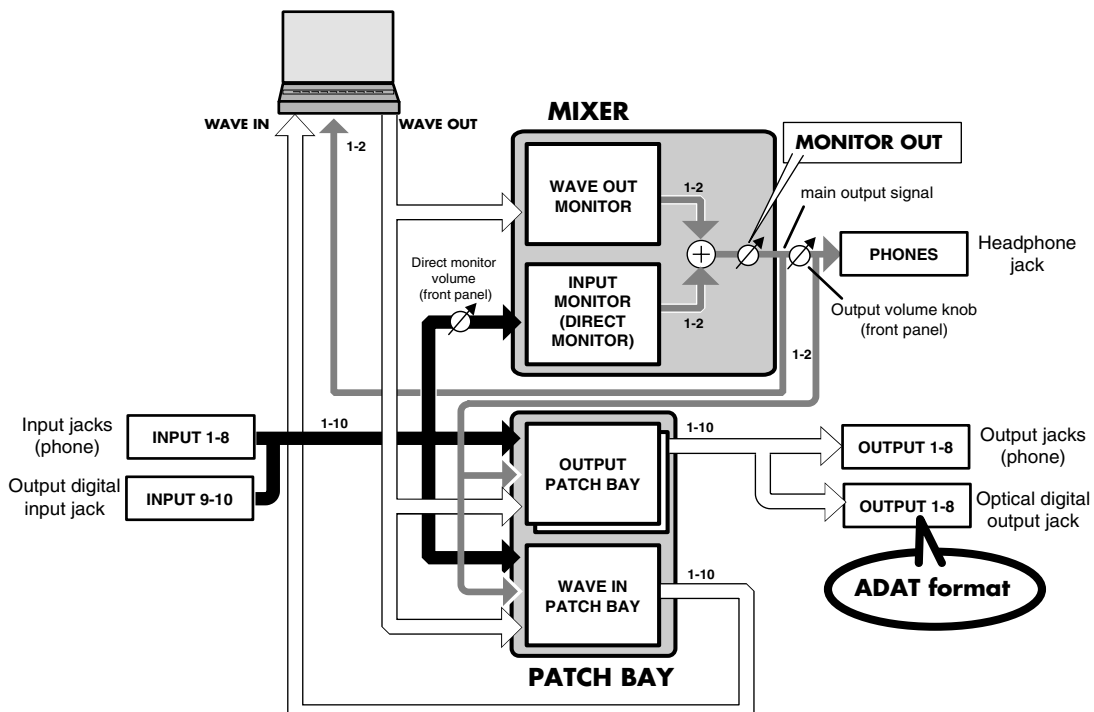

## Synchronization settings

### ADAT Input mode

Simultaneously press the ADAT mode switch and the External Clock mode switch. The peak indicator will light in orange, and the UA-1000 will be in ADAT Input mode. The outputs will operate in the same way as in ADAT Output mode.

- \* If the word clock input connector is connected, the word clock input connector will take priority for synchronization. If the UA-1000 is operating in synchronization to the word clock, the ADAT compatible device connected to digital input must be synchronized to the word clock.
- \* Set the sampling frequency select switch and the sampling frequency setting of your software to 44.1 kHz or 48 kHz. If a setting other than 44.1 kHz or 48 kHz is selected, ADAT mode will not be available; pressing the ADAT mode switch will not cause the ADAT mode switch to light.
- \* If the external clock switch is blinking, synchronization has not been achieved. The UA-1000 will not be able to record or play back correctly. Please check the settings of the connected equipment.

#### Possible reasons for problems

- The digital signal from the connected ADAT compatible device is not being received correctly.
  - If a word clock is being input to the word clock input connector in ADAT mode, the word clock signal is not being received correctly, or the sampling frequency of the word clock is not 44.1 kHz or 48 kHz.
- \* Turning off the power of the UA-1000 will not change the setting of this switch.
- \* The coaxial digital and analog input jacks will not be available.

While in ADAT Input mode, pressing the ADAT switch will exit ADAT mode and enter External Clock mode.

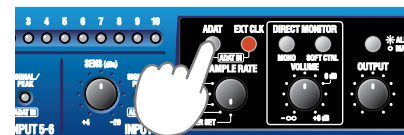

While in ADAT Input mode, pressing the External Clock mode switch will exit ADAT Input mode and enter ADAT Output mode.



## Internal blocks in ADAT input mode

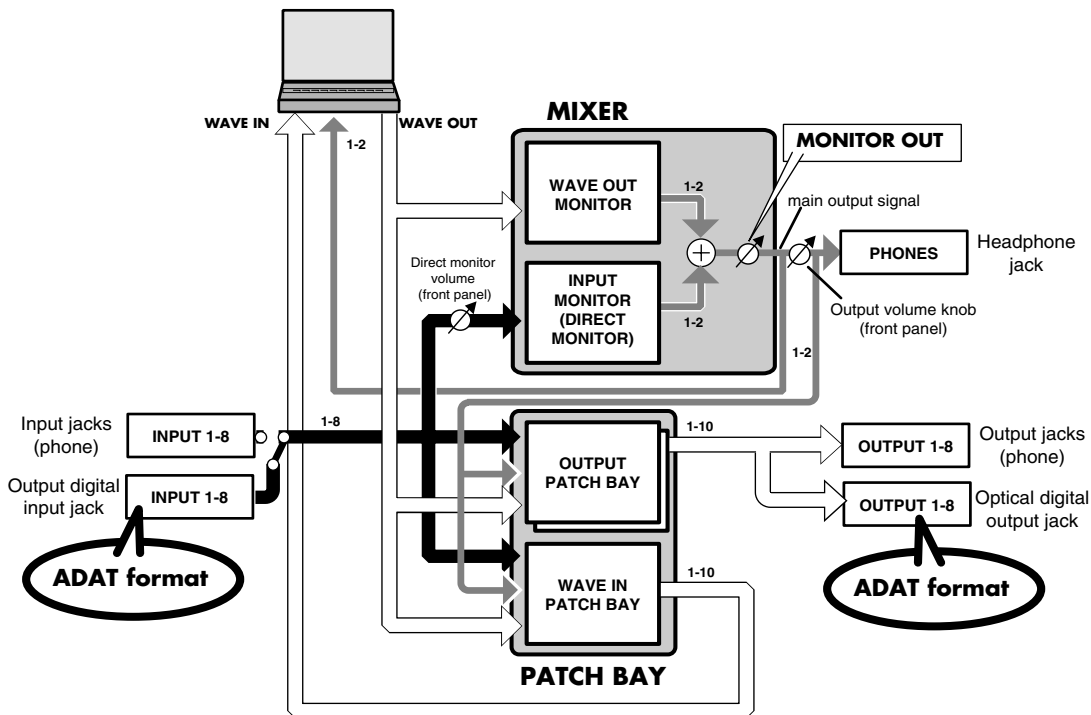

## External clock switch

Turn this switch on if you want the UA-1000 to synchronize to the word clock from an external digital device or to the digital signal being input from the digital input jack. If synchronization is occurring correctly, the external clock switch will light, and the UA-1000 will be in external clock mode.

If you are synchronizing to the digital signal or recording it, you must turn on the external clock switch.

If the external clock switch is blinking, synchronization has not been achieved. The UA-1000 will not be able to record or play back correctly. Please check the settings of the connected equipment.

### Possible reasons for problems

- The word clock from the connected digital device or the digital signal from the digital input jack is not being received correctly
- The sampling frequency does not match the setting of the sampling frequency select switch.

If the word clock input connector and the digital input connector are both connected, the word clock input connector will take priority.

If the UA-1000 is synchronized to the word clock, the digital device connected to the digital input jack must also be synchronized to the word clock.



If the digital device connected to the digital input is not synchronized to the word clock, the digital input and digital output will not operate correctly.

\* Turning off the power of the UA-1000 will not change the setting of this switch.

# System settings

## Restoring the factory settings (Factory Reset)

1. While simultaneously holding down the **output volume select switch** and the **STEREO/MONO select switch**, turn on the power.  
The **output volume select switch** and the **STEREO/MONO select switch** will blink.

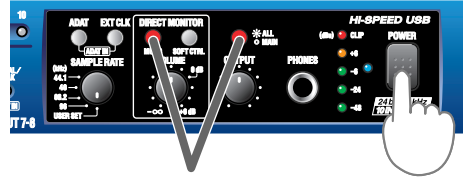

Hold down simultaneously and turn on the power

2. Press the **STEREO/MONO select switch** once again.  
The output volume select switch and the **STEREO/MONO select switch** will blink faster, and then the **direct monitor soft control switch (SOFT CTRL)** will light.  
(The operation will be cancelled if you press any LED switch other than the **STEREO/MONO select switch**.)

Once the **direct monitor soft control switch (SOFT CTRL)** has lighted, the output volume select switch and the **STEREO/MONO select switch** will go out.

The factory settings have now been restored.

### Factory settings

| Function                           | State  |
|------------------------------------|--------|
| STEREO/MONO select switch          | STEREO |
| Direct monitor soft control switch | On     |
| ADAT                               | Off    |
| EXT CLOCK                          | Off    |
| Output volume mode                 | MAIN   |

\* For details of the UA-1000's internal block structure when it is shipped from the factory, refer to "**Block diagram**" (p. 51).

# Troubleshooting

If an unexpected problem occurs while using the UA-1000, read this chapter first. It contains numerous tips for resolving problems.

If you are using Windows for the first time, and as a result find it difficult to follow the procedural explanations, please refer to the manuals that came with your computer or operating system.

Be sure to read the README\_E.HTM file in the Driver -> USB\_XP folder of the CD-ROM. The file contains any additional information that was not included in this manual.

## Problems related to the USB driver

---

### An “Unknown driver found” dialog box appears, and you are unable to install the driver

#### “Find new hardware wizard” ends before the process is completed

- It may take about 15 seconds (or more) after the USB cable is connected for the UA-1000 to be detected.
- **Is the USB cable connected correctly?**  
Make sure that the UA-1000 and your computer are correctly connected via a USB cable.
- **Is USB enabled on your computer?**  
Refer to the operation manual for your computer, and make sure that USB is enabled.
- **Does your computer meet the USB specifications?**  
If you are using a computer that does not fulfill the electrical requirements of the USB specifications, operation may be unstable. In this case, you may be able to solve the problem by connecting a USB hub.

#### Cannot install the driver correctly

Using the procedure for “**Deleting the driver**” (p. 45), delete the USB audio device driver installed in your computer, and then re-install the UA-1000 driver as described in “**Installing the driver**” (p. 18).

#### Can't install/delete/use the driver

- **Did you log on to Windows as a user with administrative privileges?**  
In order to install/delete/re-install the driver in Windows XP, you must be logged into Windows as a user with administrative privileges, such as Administrator. For details, please contact the system administrator for your computer system.
- **Did you make “Driver Signing Options?”**  
In order to install/re-install the driver, you must make “**Driver Signing Options**” (p. 18).

#### Windows XP displays a “Hardware Installation” dialog box

- **Did you make “Driver Signing Options?”**  
In order to install/re-install the driver, you must make “**Driver Signing Options**” (p. 18).

## Deleting the driver

---

If you were unable to install the driver according to the procedure given, the UA-1000 may not be recognized correctly by the computer. In this case, use the following procedure to delete the driver, and then follow the procedure in “**Installing the driver**” (p. 18) to install the driver once again.

1. With the UA-1000 disconnected, start up Windows.  
Disconnect all USB cables except for a USB keyboard and USB mouse (if used).
2. Insert the CD-ROM into the CD-ROM drive of your computer.
3. Click the Windows **start** button. From the menu that appears, select “**Run...**”  
In the “**Run...**” dialog box, input the following into the “**Open**” field, and click [OK].  
**D:\DRIVER\USB\_XP\Uninstal.EXE**  
\* The drive name “D:” may be different for your system. Specify the drive name of your CD-ROM drive.
4. Perform the installation as directed by the dialog boxes that appear.

# Problems related to the UA-1000

---

## Can't output/input sound

- **Is the UA-1000's external clock switch set correctly?**

If the UA-1000's external clock switch is blinking, the UA-1000 is not synchronized with the word clock from the external device or with the clock of the digital signal being input to the optical digital input connector.

For details, refer to “**External clock switch**” (p. 43).

- **In UA-1000 Control Panel, could MONITOR be turned OFF?**

If MONITOR is turned OFF in the control panel, the audio output will be muted. Turn MONITOR ON in the UA-1000 Control Panel.

For details on Control Panel, refer to “**UA-1000 Control Panel**” (p. 36).

- **Are the input/output settings of your software correct?**

Check the audio input/output settings of the software you are using.

(-> “**Driver settings**” (p. 23))

## Can't hear sound from the computer

- **Is it possible that the UA-1000's Master volume has been placed at 0 (turned fully counterclockwise)?**

- **Have you specified the audio and MIDI data output destination for your operating system?**

You must specify the UA-1000 as the audio data output destination for your computer. For details on how to make this setting, refer to Settings and checking.

(-> “**Driver settings**” (p. 23))

- **Are you running multiple applications?**

If multiple applications are running simultaneously, an error message may appear. If this occurs, click **[OK]** and exit the other applications.

Even if an application window is closed, it is still running if it appears in the taskbar. Be sure to exit unneeded applications displayed.

- **Was the driver installed correctly?**

In order for you to play back audio data via the UA-1000, the driver must be installed. For installation and settings, refer to “**Installing the driver**” (p. 18).

- **Is your computer in Suspend or Sleep mode?**

If so, get your computer to resume normal operation, then exit all applications that are using the UA-1000. Next, turn the UA-1000's power off, then switch it on again.

- **Did you plug-in or unplug the USB cable or turn the power of the UA-1000 off/on while an application was running?**

Exit all applications that are using the UA-1000, and exit all applications that are using the UA-1000, and re-connect the UA-1000.

- **Are the faders of the Windows volume control raised?**

Make settings so that Windows will give priority to background services, to ensure that audio and MIDI data are processed smoothly. Adjust the volume of the faders in the Windows volume control. Also make sure that the relevant fader is not muted.

To open the volume control, click the Windows **start** button and choose **All Programs -> Accessories -> Entertainment -> Volume Control**.

## Sound from devices connected to the input jack is not heard in the headphones

- **Is the headphone volume set appropriately?**  
Turn the knob clockwise to adjust the volume.
- **Is the rear panel insertion/input jack select switch set appropriately?**  
Refer to “Insertion / Input jack select switches” (p. 16), and set the switch appropriately.
- **If you are using digital input, turn the External clock switch on.**

## Volume from a device connected to the input jacks is too low

- **Are you using a cable that has a built-in resistor?**  
Use a cable without a built-in resistor (e.g., Roland PCS series).
- **Is the Input volume raised appropriately?**  
Turn the knob clockwise to adjust the volume.

## The sound of a device connected to the input jack is distorted

If you are inputting sound through the input jacks, use the Input sensitivity knobs of the UA-1000 to lower the input level.

## Noise is heard during audio playback

- **Is a mic or guitar still connected?**  
If a mic or guitar is connected to the UA-1000, disconnect the mic or guitar, and turn the input sensitivity knob all the way to the left. Disconnect any audio devices you are not using.
- **Noise is sometimes heard in the line input or mic input.**  
If a USB-compatible MIDI sound module and the UA-1000 are connected via USB to the same computer, and the outputs of the MIDI sound module are connected to the line input jacks of the UA-1000, noise from your computer may be heard via the MIDI sound module from the UA-1000, depending on the computer you are using. If this occurs, you can either connect the MIDI sound module and the UA-1000 in parallel using a self-powered hub, or connect the MIDI sound module via its serial or MIDI interface.
- **Are two or more audio devices such as the UA-1000 or a mixer connected to your computer?**  
Try connecting only a single UA-1000 unit, and check whether the noise disappears. If numerous audio devices are connected to a computer, noise may occur depending on your system. In such cases, connect only the UA-1000 to your computer.
- **In some cases, you may also be able to solve this problem by grounding the chassis of your computer, or the grounding connector of the AC power supply plug of your computer. In addition, you can check whether any devices that produce a strong magnetic field are located nearby, such as a television or microwave oven.**
- **Also check the troubleshooting item Sound is interrupted during audio playback (p. 48).**

### Sound is interrupted during audio playback

- If Cubase SX displays a message of “Sample could not be set,” open “Project Setup” and click the [OK] button in order to solve the problem.

- The sound may be interrupted if a LAN is operating.

Try disabling the LAN in the Device Manager. If this solved the problem of sound being interrupted, you may be able to solve the problem of interrupted sound by updating the driver or BIOS.

- Are many applications running on your computer?

If you use many applications or start up other applications during playback, playback may be interrupted, depending on your computer system. Please exit unneeded applications, and try again. If this does not resolve the problem, try restarting your computer.

- Try installing more memory.

Installing more memory will increase the performance of your computer. For details on how to install more memory, refer to the operation manual for your computer.

- Does your computer satisfy the requirements of the USB2.0 standard?

If you are using a computer (such as a computer that you yourself assembled) that does not satisfy the electrical requirements of the USB2.0 specifications, you may experience interruptions in the audio. If this occurs, you may be able to solve the problem by connecting a USB hub that contains its own power supply.

- Giving priority to background services

To ensure that audio MIDI and processing occurs smoothly, use the following procedure to make settings. (-> “Giving priority to background services” (p. 22))

- You can solve this problem in the “Driver Settings” dialog box.

For details, refer to the section “Part of the playback is wrong: e.g., notes are broken off prematurely, or some notes are lost” within the README\_E.HTM file located in the folder in which you installed the CD-ROM.

### Digitally recorded sound is distorted, is at the wrong pitch, or contains noise

If you are using a long optical digital cable, noise may be produced when the cable is connected, or the sound may be distorted. We recommend that you use optical digital cables that are no longer than one meter in length.

- Does the sampling frequency setting of your application match the setting of the UA-1000’s sampling frequency switch?

Set this to the sampling frequency that is selected in your recording software.

### Playback or recording halts midway through, and then becomes impossible

- Was a heavy processing load experienced while using the UA-1000, such as accessing the CD-ROM drive or a network?

If an operation involving a heavy processing load is performed while the UA-1000 is in use, it may not operate correctly. If this occurs, stop playback/recording, and then try resuming playback/recording. If you are still unable to play back/record, exit all applications that use the UA-1000, switch off the UA-1000, then turn it on again.

### Recording produces a silent (blank) file

- Have you correctly specified the audio data that is to be input in the operating system?

Make the correct settings as described in “Driver settings” (p. 23).

- On your recording software, is the audio data input destination set correctly?

Make the correct settings as described in “Driver settings” (p. 23).

### Noise is present in the sound

- If you are using word clock, noise may be caused by jitter occurring in the master device.

If you are using word clock with another digital device as the master and the UA-1000 as the slave, jitter occurring in the master device may cause noise.



## Can't record/play MIDI

- **Is the MIDI device you are using set correctly?**

In order to record/play MIDI tracks via the UA-1000, the UA-1000 driver must be installed correctly. (-> "Installing the driver" (p. 18))

- **Are the track outputs set correctly?**

You cannot hear MIDI tracks that are not assigned to a MIDI playback device. If you want to play back a MIDI track, make sure that the MIDI device you are using is shown as the MIDI output port in your software. For details, refer to the owner's manual of the software you are using.

- **Notes are interrupted or lag during MIDI playback**

Make settings so that Windows gives priority to background services.

Make settings as described in "Giving priority to background services" (p. 22).

## Can't specify the audio input/output destination in Cubase

- **By performing the following procedure, you will be able to use five streams of audio in Cubase.**

1. From the **Panels** menu, choose **VST Inputs**.
  2. Click the buttons marked In 1/2–In 9/10 and Mon L/R so they are lit.
  3. Close the VST Inputs window.
  4. From the **Panels** menu, choose **VST Master Mixer**.
  5. Drag the bottom right of the window toward the right to make the window wider.
  6. Click the **[Active]** buttons so they are all lit.
  7. Click the buttons located below the sliders to successively select Out 3–Out 9.
  8. Close the **VST Master Mixer** window.
  9. In the Arrangements window, click the Out field and select either Master, BUS 2, BUS 3, BUS 4, or BUS 5.
- \* If you want to use stereo output, select a track and then click the **[Stereo]** button located in Track Info.

## Cubase SX

1. From the **Device** menu, choose **VST Inputs**.
2. Click the Active buttons for In 1/2–In 9/10 and Mon L/R so they are all lit.
3. Close the VST Inputs window.
4. From the **Device** menu, choose **VST Outputs**.
5. Drag the bottom right of the window toward the right to make the window wider.
6. Click the **[Active]** buttons so they are all lit.
7. Click the buttons located below the sliders to successively select Out 3–Out 9.
8. Close the **VST Options** window.
9. In the Arrangements window, click the Out field and select either BUS 1, BUS 2, BUS 3, BUS 4, or BUS 5.

# Main specifications

## UA-1000: USB 2.0 Audio Capture

### Number of Audio Record/Playback Channels

Record: 10 channels  
Playback: 10 channels  
Full duplex

### Signal Processing

PC interface: 24 bits  
AD/DA Conversion: 24 bits  
Internal Processing: 40 bits

### Sampling Frequency

Digital output: 44.1/48/88.2/96 kHz  
Digital input: 44.1/48/88.2/96 kHz  
AD/DA Conversion: 44.1/48/88.2/96 kHz

### Frequency Response

96.0 kHz: 20 Hz to 40 kHz (+0 dB/-2 dB)  
88.2 kHz: 20 Hz to 40 kHz (+0 dB/-2 dB)  
48.0 kHz: 20 Hz to 22 kHz (+0 dB/-2 dB)  
44.1 kHz: 20 Hz to 20 kHz (+0 dB/-2 dB)

### Nominal Input Level (variable)

**Input Jack 1–4 (Front)**  
-60 to -16 dBu (PAD OFF)  
-40 to +4 dBu (PAD ON)  
**Insert/Input Jack 1–4 (Rear)**  
+4 dBu  
**Input Jack 5–8 (Rear)**  
-20 to +4 dBu

### Nominal Output Level

**Output Jack 1–8**  
+4 dBu (balanced)

### Residual Noise Level

(input terminated with 1 k ohms,  
MAIN VOLUME: 0 dB, INPUT SENS: +4 dBu,  
DIRECT MONITOR VOLUME: 0 dB, IHF-A typ.)

**Output Jack 1-2**  
-89 dBu

### Interface

**USB 2.0**  
**Digital input/output** (conforms to IEC60958)  
Coaxial type  
Optical type  
conforms to IEC60958 and ADAT  
ADAT capability:  
48 kHz: 50.8 kHz - 40.4 kHz  
44.1 kHz: 49.5 kHz - 40.4 kHz  
**MIDI IN/OUT**

### Connectors

#### <Front Panel>

**Input Jack 1–4 (XLR type / 1/4 inch TRS phone type)**  
XLR type (balanced / phantom power)  
1/4 inch TRS phone type (balanced)  
\* Input Jack 3 supports Guitar Hi-Z.

**Headphones Jack (Stereo 1/4 inch phone type)**

#### <Rear Panel>

**Insert/Input Jack 1–4**  
(1/4 inch phone type, Insert: TRS, Input: unbalanced)  
**Input Jack 5–8** (1/4 inch TRS phone type (balanced))  
**Output Jack 1–8** (1/4 inch TRS phone type (balanced))  
**Digital In Connectors** (Coaxial type, Optical type)  
**Digital Out Connectors** (Coaxial type, Optical type)  
**MIDI Connectors** (In, Out)  
**Word Clock Connectors** (In, Out) (BNC type)  
**USB Connector**

### Power Supply

AC 117 V, AC 230 V, AC 240 V: 50/60Hz  
AC 220 V: 60Hz

### Power Consumption

25 W

### Dimensions

431 (W) x 244 (D) x 44 (H) mm  
17 (W) x 9-5/8 (D) x 1-3/4 (H) inches

### Weight

2.8 kg / 6 lbs 3 oz

### Accessories

Owner's Manual  
CD-ROM  
Power cord  
USB cable  
Rackmount adaptor  
Ferrite core (for 230V and 240V)

(0 dBu = 0.775 V rms)

*\*In the interest of product improvement, the specifications and/or appearance of this unit are subject to change without prior notice.*

# Block diagram

## ■ Factory settings

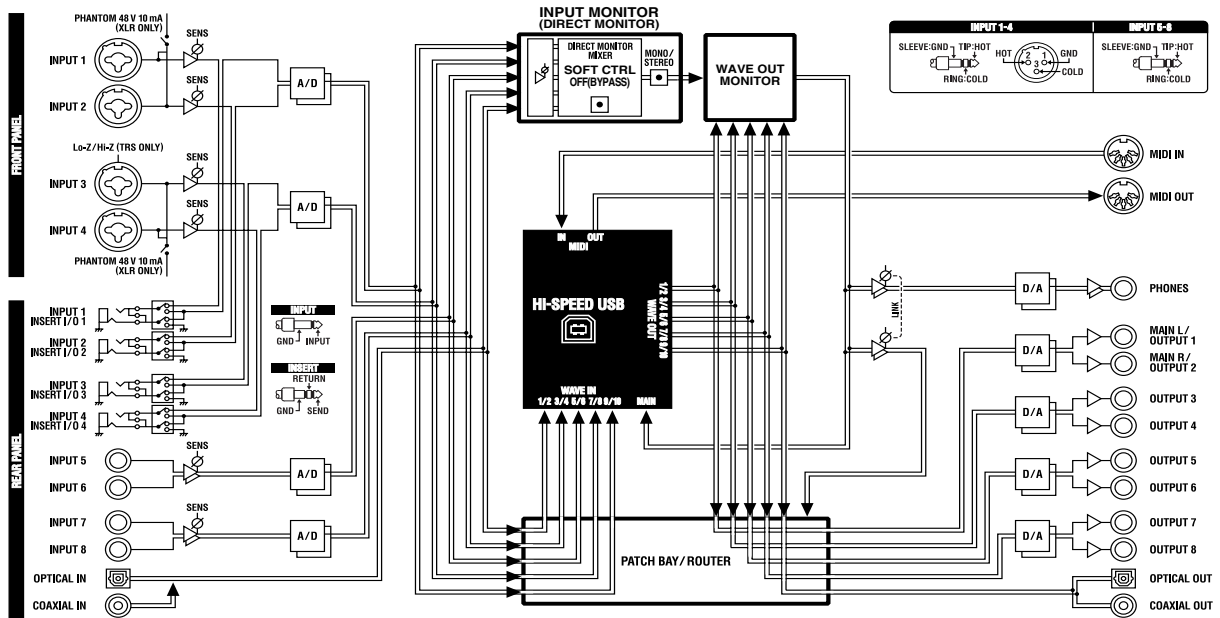

# Block diagram

## Output volume select switch: MAIN

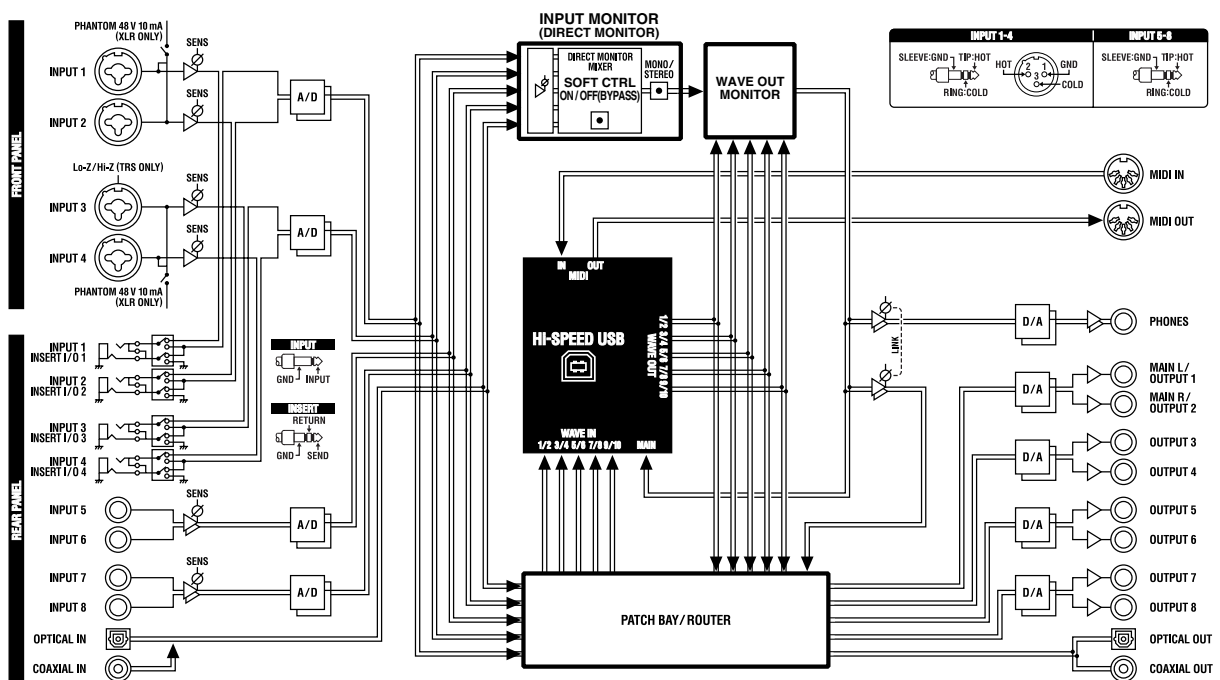

## Output volume select switch: ALL

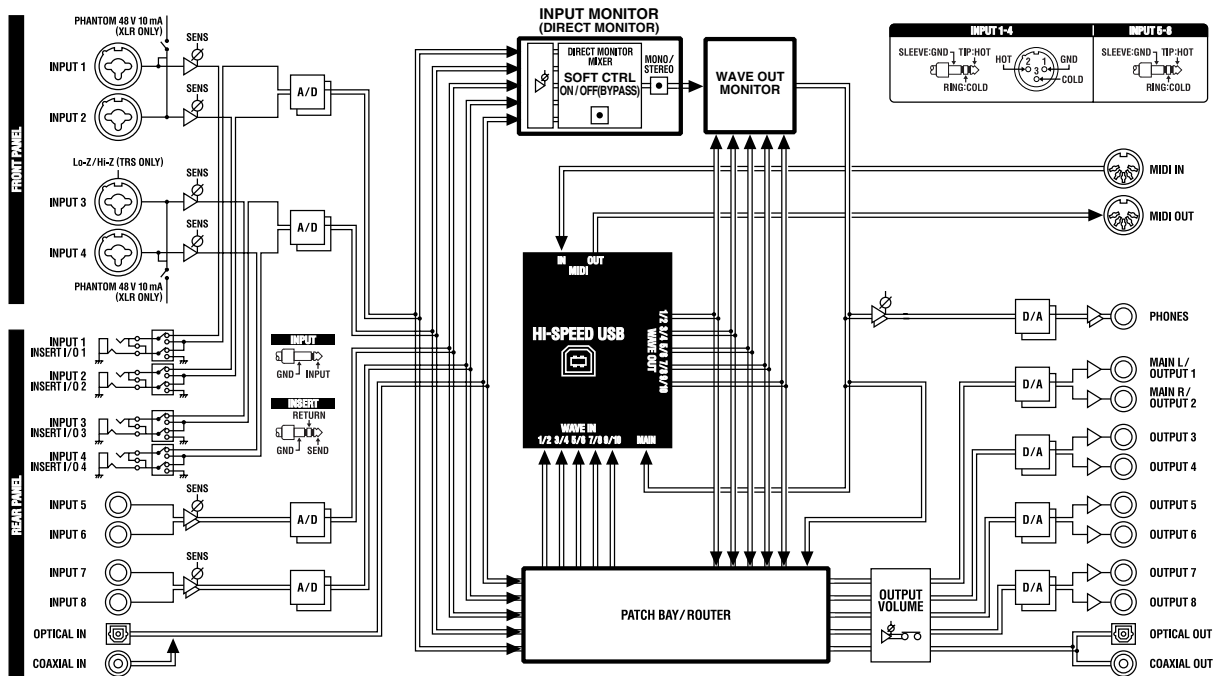

# INDEX

## Numerics

- 192 kHz ..... 38
- 5.1 channel ..... 31

## A

- AC inlet ..... 15
- ADAT ..... 29–30
- ADAT mode switch ..... 12, 29
- ADAT mode switch and external clock switch ..... 30
- ASIO ..... 23
- ASIO audio device ..... 23
- ASIO Direct Monitor ..... 40
- Audio device ..... 23
- Audio input device ..... 23
- Audio output device ..... 23

## B

- background service ..... 22

## C

- Coaxial digital input jack ..... 15
- Coaxial digital output jack ..... 15
- Combo input jacks ..... 11

## D

- Device Panel ..... 38
- DIRECT MONITOR ..... 39
- Direct monitor section ..... 13
- Direct monitor soft control switch ..... 13, 27, 33
- Direct monitor volume ..... 13, 27, 33
- driver ..... 18
- Driver Signing ..... 18

## E

- EDIROL UA-1000 ..... 23
- effects ..... 32
- External clock switch ..... 12, 33–34

## F

- Ferrite Core ..... 10
- Front panel ..... 11

## G

- Gain select switches ..... 11
- guitar ..... 27

## H

- Headphone jack ..... 14

## I

- Input impedance select switch ..... 12, 27
- Input jack mode ..... 16
- Input jacks ..... 15
- INPUT MONITOR ..... 38–39
- Input peak indicators ..... 12
- Input sensitivity knob ..... 28
- Input sensitivity knobs ..... 11
- Insertion / Input jack select switches ..... 16
- Insertion / Input jacks ..... 16
- Insertion jack mode ..... 16
- Insertion/Input jack select switch ..... 32
- Internal blocks ..... 36

## L

- latency ..... 40

## M

- memories ..... 39
- mic ..... 27
- MIDI device ..... 23
- MIDI IN device ..... 23
- MIDI IN/OUT connectors ..... 15
- MIDI OUT device ..... 23
- MME ..... 23
- MME EDIROL UA-1000 ..... 23
- MONITOR OUT ..... 26

## O

- optical digital input jack ..... 15
- optical digital output jack ..... 15
- Output indicators ..... 12
- Output jacks ..... 16
- Output level indicators ..... 14
- OUTPUT PATCH BAY ..... 26, 38–39
- Output volume knob ..... 14, 31
- Output volume select switch ..... 14, 28, 31

## P

- PAD ..... 11
- PATCH BAY ..... 31
- Phantom power switch ..... 27
- Phantom power switches ..... 11
- Power cord ..... 9
- Power indicator ..... 14
- Power switch ..... 14

## INDEX

### R

- Rackmount adaptors ..... 10
- Rear panel ..... 15

### S

- Sampling frequency select switch . 13, 27, 29–30, 33–34
- STEREO/MONO select switch ..... 13, 27
- System ..... 18

### U

- UA-1000 Control Panel ..... 36
- UA-1000 internal patching ..... 31
- USB cable ..... 9
- USB connector ..... 15
- USER SET ..... 13, 38

### W

- WAVE IN PATCH BAY ..... 38
- WAVE OUT MONITOR ..... 38
- WDM ..... 23
- WORD CLOCK IN/OUT jacks ..... 15



For EU Countries

This product complies with the requirements of European Directives EMC 89/336/EEC and LVD 73/23/EEC.

For the USA

## FEDERAL COMMUNICATIONS COMMISSION RADIO FREQUENCY INTERFERENCE STATEMENT

This equipment has been tested and found to comply with the limits for a Class B digital device, pursuant to Part 15 of the FCC Rules. These limits are designed to provide reasonable protection against harmful interference in a residential installation. This equipment generates, uses, and can radiate radio frequency energy and, if not installed and used in accordance with the instructions, may cause harmful interference to radio communications. However, there is no guarantee that interference will not occur in a particular installation. If this equipment does cause harmful interference to radio or television reception, which can be determined by turning the equipment off and on, the user is encouraged to try to correct the interference by one or more of the following measures:

- Reorient or relocate the receiving antenna.
- Increase the separation between the equipment and receiver.
- Connect the equipment into an outlet on a circuit different from that to which the receiver is connected.
- Consult the dealer or an experienced radio/TV technician for help.

This device complies with Part 15 of the FCC Rules. Operation is subject to the following two conditions:

- (1) This device may not cause harmful interference, and
- (2) This device must accept any interference received, including interference that may cause undesired operation.

Tested To Comply With FCC Standards

FOR HOME OR OFFICE USE

Unauthorized changes or modification to this system can void the users authority to operate this equipment.  
This equipment requires shielded interface cables in order to meet FCC class B Limit.

For Canada

### NOTICE

This Class B digital apparatus meets all requirements of the Canadian Interference-Causing Equipment Regulations.

### AVIS

Cet appareil numérique de la classe B respecte toutes les exigences du Règlement sur le matériel brouilleur du Canada.

For the USA

## DECLARATION OF CONFORMITY Compliance Information Statement

Model Name : UA-1000  
Type of Equipment : USB2.0 Audio Interface  
Responsible Party : Ediol Corporation North America  
Address : 425 Sequoia Drive, Suite 114, Bellingham, WA 98226  
Telephone : (360) 594-4276

# Information

When you need repair service, call your nearest EDIROL/Roland Service Center or authorized EDIROL/Roland distributor in your country as shown below.

## EDIROL

### EUROPE

**EDIROL (Europe) Ltd.**  
Studio 3.4 114 Power Road  
London W4 5PY  
U. K.  
TEL: +44 (0)20 8747 5949  
FAX:+44 (0)20 8747 5948  
http://www.edirol.com/europe

**Deutschland**  
TEL: 0700 33 47 65 20  
**France**  
TEL: 0810 000 371  
**Italia**  
TEL: 02 93778329

## Roland

### NORTH AMERICA

#### CANADA

**Roland Canada Music Ltd.**  
(Head Office)  
5480 Parkwood Way Richmond  
B. C., V6V 2M4 CANADA  
TEL: (604) 270 6626

**Roland Canada Music Ltd.**  
(Toronto Office)  
170 Admiral Boulevard  
Mississauga On L5T 2N6  
CANADA  
TEL: (905) 362 9707

#### U. S. A.

**Roland Corporation U.S.**  
5100 S. Eastern Avenue  
Los Angeles, CA 90040-2938,  
U. S. A.  
TEL: (323) 890 3700

### AFRICA

#### EGYPT

**Al Fanny Trading Office**  
9, EBN Hagar Al Askalany  
Street,  
ARD El Golf, Heliopolis,  
Cairo 11341, EGYPT  
TEL: 20-2-417-1828

#### REUNION

**Maison FO - YAM Marcel**  
25 Rue Jules Hermann,  
Chaudron - BP79 97 491  
Ste Clotilde Cedex,  
REUNION ISLAND  
TEL: (0262) 218-429

#### SOUTH AFRICA

**Paul Bothner(PTY)Ltd.**  
Royal Cape Park, Unit 24  
Londonderry Road, Ottery 7800  
Cape Town, SOUTH AFRICA  
TEL: (021) 799 4900

### ASIA

#### CHINA

**Roland Shanghai Electronics  
Co.,Ltd.**  
5F, No.1500 Pingliang Road  
Shanghai 200090, CHINA  
TEL: (021) 5580-0800

**Roland Shanghai Electronics  
Co.,Ltd.**

(BEIJING OFFICE)  
10F, No.18 3 Section Anhuaxili  
Chaoyang District Beijing  
100011 CHINA  
TEL: (010) 6426-5050

**Roland Shanghai Electronics  
Co.,Ltd.**

(GUANGZHOU OFFICE)  
2/F., No.30 Si You Nan Er Jie  
Yi Xiang, Wu Yang Xin Cheng,  
Guangzhou 510600, CHINA  
TEL: (020) 8736-0428

#### HONG KONG

**Parsons Music Ltd.**  
8th Floor, Railway Plaza, 39  
Chatham Road South, T.S.T,  
Kowloon, HONG KONG  
TEL: 2333 1863

#### INDIA

**Rivera Digitec (India) Pvt. Ltd.**  
409, Nirmam Kendra  
Mahalaxmi Flats Compound  
Off. Dr. Edwin Moses Road,  
Mumbai-400011, INDIA  
TEL: (022) 2493 9051

#### INDONESIA

**PT Citra IntiRama**  
Jl. Cideng Timur No. 15J-150  
Jakarta Pusat  
INDONESIA  
TEL: (021) 6324170

#### KOREA

**Cosmos Corporation**  
1461-9, Seocho-Dong,  
Seocho Ku, Seoul, KOREA  
TEL: (02) 3486-8855

#### MALAYSIA/ SINGAPORE

**Roland Asia Pacific Sdn. Bhd.**  
45-1, Block C2, Jalan PJU 1/39,  
Dataran Prima, 47301 Petaling  
Jaya, Selangor, MALAYSIA  
TEL: (03) 7805-3263

#### PHILIPPINES

**G.A. Yupangco & Co. Inc.**  
339 Gil J. Puyat Avenue  
Makati, Metro Manila 1200,  
PHILIPPINES  
TEL: (02) 899 9801

#### TAIWAN

**ROLAND TAIWAN  
ENTERPRISE CO., LTD.**  
Room 5, 9fl. No. 112 Chung  
Shan N.Road Sec.2, Taipei,  
TAIWAN, R.O.C.  
TEL: (02) 2561 3339

#### THAILAND

**Theera Music Co., Ltd.**  
330 Soi Verng NakornKasem,  
New Road, Sumpantawongse,  
Bangkok 10100, THAILAND  
TEL: (02) 224-8821

#### VIETNAM

**SAIGON MUSIC  
DISTRIBUTOR  
(TAN DINH MUSIC)**  
138 Tran Quang Khai Street  
Dist. 1, Ho Chi Minh City  
VIETNAM  
TEL: (08) 848-4068

### AUSTRALIA/ NEW ZEALAND

#### AUSTRALIA/ NEW ZEALAND

**Roland Corporation  
Australia Pty.,Ltd.**  
38 Campbell Avenue  
Dee Why West. NSW 2099  
AUSTRALIA

For Australia  
Tel: (02) 9982 8266  
For New Zealand  
Tel: (09) 3098 715

### CENTRAL/LATIN AMERICA

#### ARGENTINA

**Instrumentos Musicales S.A.**  
Av.Santa Fe 2055  
(1123) Buenos Aires  
ARGENTINA  
TEL: (011) 4508-2700

#### BARBADOS

**A&B Music Supplies LTD**  
12 Webster Industrial Park  
Wildley, St.Michael, Barbados  
TEL: (246)430-1100

#### BRAZIL

**Roland Brasil Ltda.**  
Rua San Jose, 780 Sala B  
Parque Industrial San Jose  
Cotia - Sao Paulo - SP, BRAZIL  
TEL: (011) 4615 5666

#### CHILE

**Comercial Fancy II S.A.**  
Rut.: 96.919.420-1  
Nataaniel Cox #739, 4th Floor  
Santiago - Centro, CHILE  
TEL: (02) 688-9540

#### COLOMBIA

**Centro Musical Ltda.**  
Cra 43 B No 25 A 41 Bodeoga 9  
Medellin, Colombia  
TEL: (574)3812529

#### CURACAO

**Zeelandia Music Center Inc.**  
Orionweg 30  
Curacao, Netherland Antilles  
TEL:(305)5926866

#### DOMINICAN REPUBLIC

**Instrumentos Fernando Giraldez**  
Calle Proyecto Central No.3  
Ens.La Esperilla  
Santo Domingo,  
Dominican Republic  
TEL:(809) 683 0305

#### ECUADOR

**Mas Musica**  
Rumichaca 822 y Zaruma  
Guayaquil - Ecuador  
TEL:(593-4)2302364

#### GUATEMALA

**Casa Instrumental**  
Calzada Roosevelt 34-01,zona 11  
Ciudad de Guatemala  
Guatemala  
TEL:(502) 599-2888

#### HONDURAS

**Almacen Pajaro Azul S.A. de C.V.**  
BO.Paz Barahona  
3 Ave.11 Calle S.O  
San Pedro Sula, Honduras  
TEL: (504) 553-2029

#### MARTINIQUE

**Musique & Son**  
Z.I.Les Mangle  
97232 Le Lamantin  
Martinique F.W.I.  
TEL: 596 596 426860

**Gigamusik SARI**  
10 Rte De La Folie  
97200 Fort De France  
Martinique F.W.I.  
TEL: 596 596 715222

#### MEXICO

**Casa Veerkamp, s.a. de c.v.**  
Av. Toluca No. 323, Col. Olivar  
de los Padres 01780 Mexico  
D.F. MEXICO  
TEL: (55) 5668-6699

#### NICARAGUA

**Bansbach Instrumentos  
Musicales Nicaragua**  
Altamira D'Este Calle Principal  
de la Farmacia 5ta.Avenida  
1 Cuadra al Lago.#503  
Managua, Nicaragua  
TEL: (505)277-2557

#### PERU

**Audionet**  
Distribuciones Musicales SAC  
Juan Fanning 530  
Miraflores  
Lima - Peru  
TEL: (511) 4461388

#### TRINIDAD

**AMR Ltd**  
Ground Floor  
Maritime Plaza  
Barataria Trinidad W.I.  
TEL: (868)638 6385

#### URUGUAY

**Todo Musica S.A.**  
Francisco Acuna de Figueroa 1771  
C.P.: 11.800  
Montevideo, URUGUAY  
TEL: (02) 924-2335

#### VENEZUELA

**Instrumentos Musicales  
Allegro,C.A.**  
Av.las industrias edf.Guitar  
import  
#7 zona Industrial de Turumo  
Caracas, Venezuela  
TEL: (212) 244-1122

### EUROPE

#### AUSTRIA

**Roland Elektronische  
Musikinstrumente HmbH.  
Austrian Office**  
Eduard-Bodem-Gasse 8,  
A-6020 Innsbruck, AUSTRIA  
TEL: (0512) 26 44 260

#### BELGIUM/FRANCE/ HOLLAND/ LUXEMBOURG

**Roland Central Europe N.V.**  
Houtstraat 3, B-2260, Oevel  
(Westerlo) BELGIUM  
TEL: (014) 575811

#### CZECH REP.

**K-AUDIO**  
Kardasovska 626.  
CZ-198 00 Praha 9,  
CZECH REP.  
TEL: (2) 666 10529

#### DENMARK

**Roland Scandinavia A/S**  
Nordhavnsvej 7, Postbox 880,  
DK-2100 Copenhagen  
DENMARK  
TEL: 3916 2000

#### FINLAND

**Roland Scandinavia As, Filial  
Finland**  
Elannontie 5  
FIN-01510 Vantaa, FINLAND  
TEL: (09) 68 24 020

#### GERMANY

**Roland Elektronische  
Musikinstrumente HmbH.**  
Oststrasse 96, 22844  
Norderstedt, GERMANY  
TEL: (040) 52 60090

#### GREECE

**STOLLAS S.A.**  
Music Sound Light  
155, New National Road  
Patras 26442, GREECE  
TEL: 2610 435400

#### HUNGARY

**Roland East Europe Ltd.**  
Warehouse Area 'DEPO' Pf.83  
H-2046 Torokbalint,  
HUNGARY  
TEL: (23) 511011

#### IRELAND

**Roland Ireland**  
G2 Calmount Park, Calmount  
Avenue, Dublin 12  
Republic of IRELAND  
TEL: (01) 4294444

#### ITALY

**Roland Italy S. p. A.**  
Viale delle Industrie 8,  
20020 Arese, Milano, ITALY  
TEL: (02) 937-78300

#### NORWAY

**Roland Scandinavia Avd.  
Kontor Norge**  
Lilleakerveien 2 Postboks 95  
Lilleaker N-0216 Oslo  
NORWAY  
TEL: 2273 0074

#### POLAND

**MX MUSIC SP.Z.O.O.**  
UL. Gibraltarska 4.  
PL-03664 Warszawa POLAND  
TEL: (022) 697 44 19

#### PORTUGAL

**Roland Iberia, S.L.**  
Portugal Office  
Cais das Pedras, 8/9-1 Dto  
4050-465, Porto, PORTUGAL  
TEL: 22 608 00 60

#### ROMANIA

**FBS LINES**  
Piata Libertatii 1,  
535500 Gheorgheni,  
ROMANIA  
TEL: (266) 364 609

#### RUSSIA

**MuTek**  
Dorozhnaya ul.3,korp.6  
117 545 Moscow, RUSSIA  
TEL: (095) 981-4967

#### SPAIN

**Roland Iberia, S.L.**  
Paseo Garcia Faria, 33-35  
08005 Barcelona SPAIN  
TEL: 93 493 91 00

#### SWEDEN

**Roland Scandinavia A/S**  
SWEDISH SALES OFFICE  
Danvik Center 28, 2 tr.  
S-131 30 Nacka SWEDEN  
TEL: (08) 702 00 20

#### SWITZERLAND

**Roland (Switzerland) AG**  
Landstrasse 5, Postfach,  
CH-4452 Itingen,  
SWITZERLAND  
TEL: (061) 927-8383

#### UKRAINE

**TIC-TAC**  
Mira Str. 19/108  
P.O. Box 180  
295400 Munkachevo,  
UKRAINE  
TEL: (03131) 414-40

#### UNITED KINGDOM

**Roland (U.K.) Ltd.**  
Atlantic Close, Swansea  
Enterprise Park, SWANSEA  
SA7 9FJ,  
UNITED KINGDOM  
TEL: (01792) 702701

### MIDDLE EAST

#### BAHRAIN

**Moon Stores**  
No.16, Bab Al Bahrain Avenue,  
P.O.Box 247, Manama 304,  
State of BAHRAIN  
TEL: 17 211 005

#### CYPRUS

**Radex Sound Equipment Ltd.**  
17, Diagorou Street, Nicosia,  
CYPRUS  
TEL: (022) 66-9426

#### IRAN

**MOCO INC.**  
No.41 Nike St., Dr.Shariyati Ave.,  
Roboeroy Cerah Mirdamad  
Teheran, IRAN  
TEL: (021) 285-4169

#### ISRAEL

**Halilit P. Greenspoon & Sons  
Ltd.**  
8 Retzif Ha'aliya Hashnya St.  
Tel-Aviv-Yafo ISRAEL  
TEL: (03) 6823666

#### JORDAN

**MUSIC HOUSE CO. LTD.  
FREDDY FOR MUSIC**  
P. O. Box 922846  
Amman 11192 JORDAN  
TEL: (06) 5692696

#### KUWAIT

**EASA HUSAIN AL-YOUSIFI  
& SONS CO.**  
Abdullah Salem Street,  
Safat, KUWAIT  
TEL: 243-6399

#### LEBANON

**Chahine S.A.L.**  
Gerge Zeidan St., Chahine  
Bldg., Achrafieh, P.O.Box: 16-  
5857  
Beirut, LEBANON  
TEL: (01) 20-1441

#### OMAN

**TALENTZ CENTRE L.L.C.**  
Malatan House No.1  
Al Noor Street, Ruwi  
SULTANATE OF OMAN  
TEL: 2478 3443

#### QATAR

**Badie Studio & Stores**  
P.O. Box 62,  
Doha, QATAR  
TEL: 423554

#### SAUDI ARABIA

**aDawlah Universal  
Electronics APL**  
Corniche Road, Aldossary  
Bldg., 1st Floor, Alkhorbar,  
SAUDI ARABIA

**P.O.Box 2154, Alkhorbar 31952  
SAUDI ARABIA  
TEL: (03) 898 2081**

#### SYRIA

**Technical Light & Sound  
Center**  
Rawda, Abdul Qader Jazairi St.  
Bldg. No. 21, P.O.BOX 13520,  
Damascus, SYRIA  
TEL: (011) 223-5384

#### TURKEY

**ZUHAL DIS TICARET A.S.**  
Galip Dede Cad. No.37  
Beyoglu - Istanbul / TURKEY  
TEL: (0212) 249 85 10

#### U.A.E.

**Zak Electronics & Musical  
Instruments Co. L.L.C.**  
Zabeel Road, Al Sherooq Bldg.,  
No. 14, Grand Floor, Dubai,  
U.A.E.  
TEL: (04) 3360715



## Free Manuals Download Website

<http://myh66.com>

<http://usermanuals.us>

<http://www.somanuals.com>

<http://www.4manuals.cc>

<http://www.manual-lib.com>

<http://www.404manual.com>

<http://www.luxmanual.com>

<http://aubethermostatmanual.com>

Golf course search by state

<http://golfingnear.com>

Email search by domain

<http://emailbydomain.com>

Auto manuals search

<http://auto.somanuals.com>

TV manuals search

<http://tv.somanuals.com>