

***DIVA LAN ISDN Modem
User's Guide***

DIVA LAN ISDN Modem is a trademark of Eicon Technology Corporation.

All other brand and product names are trademarks or registered trademarks of their respective owners.

Changes are periodically made to the information herein; these changes will be incorporated into new editions of the publication. Eicon Technology may make improvements and/or changes in the products and/or programs described in this publication at any time.

If you have comments on this manual or the products it describes, address them to: Eicon Technology Corporation,

Attention: Corporate Publications,
9800 Cavendish Blvd.,
Montreal, Quebec, Canada,
H4M 2V9

Telephone: (514) 745-5500

Fax: (514) 745-5588

Eicon Technology may use or distribute whatever information you supply in any way it believes appropriate without incurring any obligations to you.

Copyright © 1998-1999 Eicon Technology Corporation. All rights reserved, including those to reproduce this publication or parts thereof in any form without permission in writing from Eicon Technology Corporation

Table of Contents

Chapter One:

Introduction	9
Introducing the DIVA LAN ISDN Modem	10
Creating your own LAN for resource sharing	10
Connecting to the Internet	10
Connecting to a corporate network	11
Creating a VPN	11
Attaching telephones and fax machines	11
Connecting more computers	12
Total network security	12
Compression for faster throughput	12
Bandwidth on-demand	13
Advanced ISDN tariff management	13
Advanced diagnostics	13
Unsupported configurations	13
Summary of features	14
Contacting customer services	15
World wide web	15

Chapter Two:

Getting Started	16
1. Installation overview	17
2. Prepare for installation	18
Verify your package contents	18
Verify the configuration of your computers	18
To use the advanced configuration options	19
3. Choose a connection protocol	20
Important ISDN concepts	20
ISDN channel usage	20
Choosing a connection protocol	21
Summary	22
4. Order an ISDN Line	23
5. Gather Internet account information	24
Gather X.25 information	24
Gather V.120 information	24
6. Install the DIVA LAN ISDN Modem	26
7. Install Modem Monitor (Windows 95/98/NT4)	28
8. Connecting a non-Windows computer to the DIVA LAN ISDN Modem ..	31
9. Configuring the Internet connection	33
To configure the Internet connection	33
10. Using your DIVA LAN ISDN Modem	38
How long will the line stay connected?	38
Registering your DIVA LAN ISDN Modem	38
What's next?	38

Chapter Three:

Using Modem Monitor	39
Starting Modem Monitor	40
Start menu program group	40
Properties dialog box	42
Utilities dialog box	43
Options dialog box	44
Status Viewer	45

Chapter Four:

The Web-based Configuration Interface	46
Starting the web-based configuration interface	47
To start the web-based configuration interface	47
Saving configuration settings	48
Getting help	48
General settings and connection profiles	49
General settings	49
Connection profile settings	49
Editing the ISP profile	50
Editing LAN settings	52
Saving and restoring configuration files	53
To save/restore configuration settings	53
Viewing status information	54
System status	54
Front panel display	54
Obtaining statistics	55
Upgrading the DIVA LAN ISDN Modem firmware	56
Resetting to factory defaults	57

Chapter Five:

Minimizing ISDN Charges	58
The Cost Control page	59
Idle timer	59
Data call thresholds	60
ISDN billing intervals	60
Configuring BACP	61
Configuring AO/DI	63
X.25 on the D-channel	65
Setting ISDN active intervals	67
Spoofing NetBIOS services	68
Data compression	69
Manual dialing	70
Restricting analog calls	71
Data over voice	72
Traffic filtering	73

Chapter Six:

Security 74

Security features 75

System password 76

Automatic log out 77

Network address translation 78

 Security benefits 78

 NAT static mappings 78

Remote management 81

Incoming data calls 83

Call screening 86

Call authentication 87

 To set up call authentication 87

Callback 88

 Callback modes 88

 Callback options 88

 Delay before host calls back 89

 Timeout waiting for callback 89

 To set up callback 89

Manual dialing 90

Custom security features 91

Chapter Seven:

Setting up the Phone Ports 92

Setting phone numbers manually 93

Connecting modems and fax machines 94

Connecting multiple analog devices 94

Call bumping 95

 How it works 95

 Requirements 95

 To enable call bumping 95

Restricting analog calls 96

Supplementary services 97

 Call Forwarding 97

 Call Waiting 98

 VoiceMail 98

 Caller ID 98

 Three-way Conference Calling 98

 Call Transfer 99

 Feature Key values 99

Chapter Eight:

Connecting to a Corporate Network 100

Overview 101

1. Gather information 102

 Gather X.25 information 102

2. Configure the Corporate profile 103

Using the corporate connection 107

- How long will the line stay connected? 107
- Support for Microsoft Network Neighborhood 107
- NetBIOS name resolution 107
- Timeouts 107
- Dynamic IP addressing 107

What's next? 108

Chapter Nine:

Advanced Installations 109

Connection retries 110

Installing on an existing LAN 112

- Using Modem Monitor 112
- Manual installation 112
- Adjusting configuration settings on the LAN 114

Connecting more than four computers 115

Creating a virtual private network 116

- To create a VPN 116
- Connecting to the VPN 117

Concurrent Internet and Intranet connections 119

- Selecting a connections protocol 119
- Defining routes 119
- Installation and configuration procedure 119

IP routes 120

- About IP addresses 120
- Why routes are needed 123
- The Routing Information Protocol (RIP) 126
- Defining routes for the DIVA LAN ISDN Modem 126

IP filters 128

- How filtering works 128
- Default filters 129
- To define a filter 129
- IP filtering examples 132

Making a V.120 connection 136

SecurID support 138

Chapter Ten:

Other Configuration Tools 140

Configuration options 141

Web interface 142

TFTP interface 143

- Enabling TFTP server support 143
- Uploading/downloading configuration files 144
- Loading new firmware via TFTP 144

DTMF interface 145

- How it works 145
- Commands 145

Command line interface (CLI)	146
Establishing a Telnet connection via IP	146
Establishing a serial connection	146
Using the command line interface	147
About configuration context	148
Connection profiles	148
Default profiles	148
Command line reference	148
Loading firmware with the CLI	148
<hr/>	
Appendix A:	
TCP/IP Configuration	150
Installing and configuring TCP/IP for Windows 95/98	151
Installing TCP/IP	151
Configuring TCP/IP	151
Installing TCP/IP for Windows NT	154
Configuring TCP/IP on an iMac	155
<hr/>	
Appendix B:	
Technical Information	156
DIVA LAN ISDN Modem indicator lights	157
DIVA LAN ISDN Modem connectors	159
Resetting the DIVA LAN ISDN Modem	160
Resetting operational settings	160
Resetting to factory defaults	160
Termination	161
Determining termination requirements	161
Installing the resistor	161
<hr/>	
Appendix C:	
Command Line Reference	162
Notational Conventions	163
Commands	164
AO/DI	165
Callback	166
Call screening	167
Call thresholds	168
DHCP	169
DNS	172
Ethernet	173
General	174
IP filters	177
IP NAT	180
IP routing	181
IP various	182

ISDN	184
ISDN Access Time	187
LAPD	188
Logging and Mail Trace	189
MLPPP	190
Phone	191
PPP	194
Profiles	197
Q.931	198
RIP	199
SNMP	201
TCP	202
TFTP	203
Time Protocol	204
UDP	205
V.120	206
V.120 Scripting	208
X.25	209

Appendix D:	
Regulatory Information	211

Chapter One

Introduction

Eicon Technology's DIVA LAN ISDN Modem provides affordable workgroup computing for branch offices, small businesses, and home offices.

This chapter summarizes the features of the DIVA LAN ISDN Modem and shows how it can be used in a variety of applications.

Introducing the DIVA LAN ISDN Modem

The DIVA LAN ISDN Modem is a powerful networking solution for SOHO (small office/home office) and branch office users. It creates a complete networking, phone, fax, and data communications system in one box. The DIVA LAN ISDN Modem is easy to install, use, and maintain, without the need for technical support from the remote, corporate office.

The DIVA LAN ISDN Modem can be used in a variety of applications. This section presents a brief overview of some of the more common applications, and their features.

Creating your own LAN for resource sharing

The DIVA LAN ISDN Modem has a built-in 10 Mbps Ethernet hub with four ports. By connecting computers (or other devices, such as printers) to these ports, they become part of a LAN (local area network), and can share data and resources with each other.

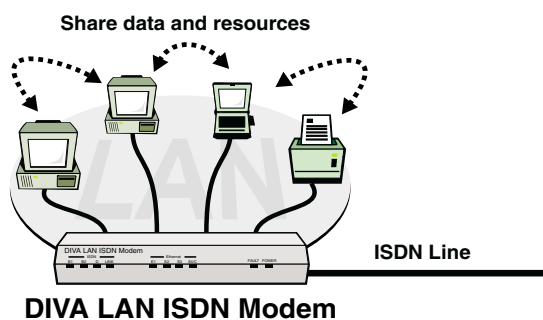

Connecting three computers and a network printer to the DIVA LAN ISDN Modem.

Connecting to the Internet

In this application, the DIVA LAN ISDN Modem enables you to connect one or more computers to the Internet for e-mail, web surfing, and file transfers.

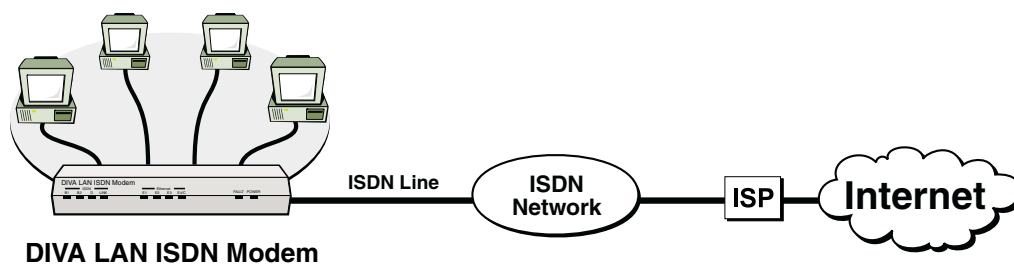

How it works: You connect the DIVA LAN ISDN Modem to an ISDN line (which is part of the telephone network). You also set up an account with an ISP (Internet Service Provider), obtaining the necessary phone numbers, user name, and password. Once the DIVA LAN ISDN Modem is configured with this information, it automatically calls the ISP and uses its services to send and receive data on the Internet.

Connecting to a corporate network

This option enables you to connect one or more computers to your corporate LAN for file sharing, e-mail, data transfer. Generally, this type of connection takes place via a direct, dial-up link with the corporate LAN.

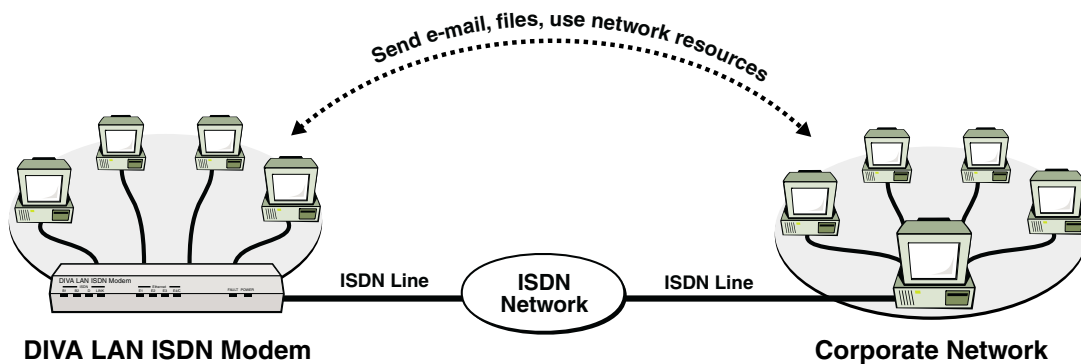

How it works: You connect the DIVA LAN ISDN Modem to an ISDN line (which is part of the telephone network). You also contact the corporate network and obtain its ISDN phone number and associated user names and passwords. Once the DIVA LAN ISDN Modem is configured with this information, it automatically calls the remote site to send data to it, for example, when a local users sends e-mail, or shares folders with Windows Network Neighborhood.

Note You cannot connect to a corporate network if it is also using a DIVA LAN ISDN Modem.

Creating a VPN

Connect branch offices and telecommuters into an enterprise-wide Virtual Private Network (VPN) over the Internet. This eliminates the long-distance charges, network management problems, and security responsibilities associated with traditional WANs.

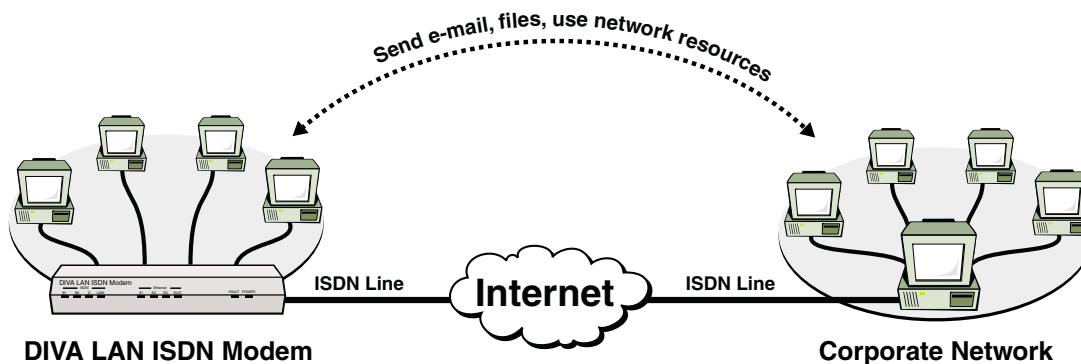

Note You cannot connect to a corporate network if it is also using a DIVA LAN ISDN Modem.

Attaching telephones and fax machines

The DIVA LAN ISDN Modem is available in a version that features two analog ports for the connection of telephones, fax machines, and analog modems. The DIVA LAN ISDN Modem takes advantage of the flexibility of ISDN to enable you to make or receive phone calls or faxes, while at the same time connecting to the Internet or a corporate network with your computers. This can eliminate the need to install additional analog phone lines.

The DIVA LAN ISDN Modem supports caller ID, call transfer, call waiting, call holding, call forwarding, and 3-way conference call features.

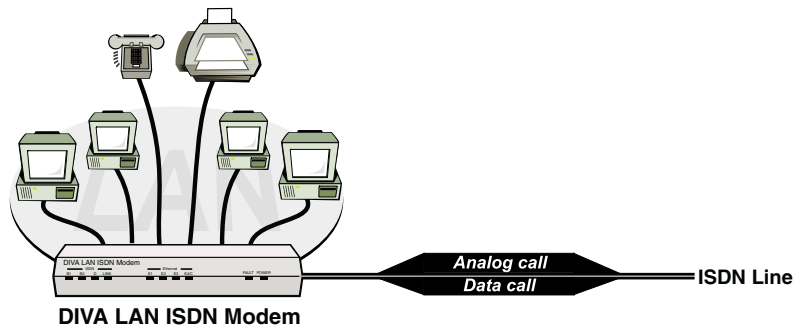

Connecting more computers

By attaching a DIVA LAN ISDN Modem to an Ethernet hub from other manufacturers, you can interconnect more than four computers (or other devices), enabling them to share the ISDN connection provided by the DIVA LAN ISDN Modem.

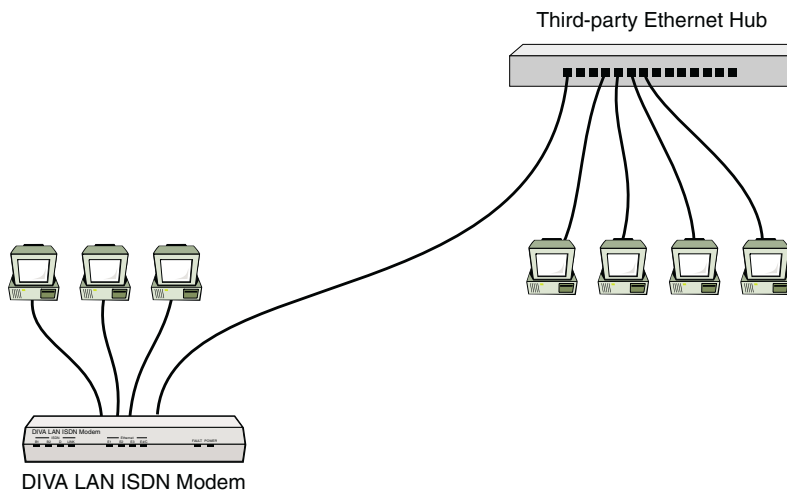

Connecting the DIVA LAN ISDN Modem to a third-party Ethernet hub.

In this example, all computers can share the ISDN link to exchange data, send e-mail, or surf the Web. There is no need for multiple modems, phone lines, or ISP accounts.

Note *Two DIVA LAN ISDN Modems cannot be connected in this manner.*

Total network security

The Network Address Translation (NAT) feature keeps local IP addresses hidden so that your computers are invisible to the outside world.

Password security, filtering, and the ability to disable support for incoming calls prevents intruders from breaking into the DIVA LAN ISDN Modem itself.

Compression for faster throughput

The DIVA LAN ISDN Modem provides data compression to achieve throughput rates of up to 512 kbps. That's four times the ISDN remote access speed of 128 kbps.

Bandwidth on-demand

The DIVA LAN ISDN Modem's bandwidth-on-demand feature automatically monitors data traffic and engages the second B-channel only when needed, reducing ISDN costs.

Advanced ISDN tariff management

The DIVA LAN ISDN Modem can be configured to:

- Disable ISDN access during peak tariff rates or limit the total line usage in minutes for a given time period.
- Set a maximum number of connections for a given period.
- Filter out specific IP protocols which consume a lot of bandwidth.
- Control broadcast traffic such as NetBEUI and TCP from reconnecting the ISDN line.

Advanced diagnostics

- On-screen display of B-channel status.
- Significant events are recorded in the Event Viewer.
- Events trigger visual or audible alarms.
- Common errors are described in non-technical language inside the Event Viewer, so that users don't need to analyze PPP or ISDN traces.
- Detailed ISDN information for the last two calls is retained.
- Reports list ISDN diagnostics in plain language along with help information. This is particularly useful for solving ISDN line provisioning problems.
- Detailed traces (including ISDN (Q.931), PPP, X.25, LAPD) are available enabling technical personnel to isolate complex communications problems.

Unsupported configurations

The DIVA LAN ISDN Modem cannot be used in the following configurations:

- Two DIVA LAN ISDN Modems cannot be interconnected (daisy-chained) via their Ethernet ports.
- The DIVA LAN ISDN Modem cannot be used on both sides when connecting to a corporate network. The corporate network must have its own gateway.

Summary of features

Note *The DIVA LAN ISDN Modem is available with or without analog phone ports. Phone related features are only available on models with analog phone ports.*

Key features of the DIVA LAN ISDN Modem include:

Physical characteristics

- Ethernet hub with four ports
- Two analog ports
- Console port (serial)
- Status LEDs (four ISDN, four Ethernet, power, fault)

ISDN support

- Available with U or S/T interface
- Support for international switches
- Always On/Dynamic ISDN (AO/DI)

Voice call handling

- Call bumping (Dynamic Bandwidth Allocation) on incoming and outgoing calls
- Advanced calling features, including call forwarding, three-way calling, etc.
- Delivers CallerID digits to the analog ports
- PHONE ports have a REN of 3

PPP features

- PPP, Multilink PPP, BACP, BOD, AO/DI, V.120
- Compression: Ascend, MPPP, MS-STAC, STAC1, and STAC3
- Authentication: PAP/CHAP, MS-CHAP

Installation

- Quick install via wizards
- Auto detection of common problems, including line presence, incorrect configuration, etc.

Usage/tariff management

- Connectivity timers to restrict usage to particular days and times
- Usage limits can be set based on number of calls or time connected
- Call filtering

LAN protocol

- Supports static and dynamic IP routing
- Supports IP PAT and NAT
- Performs IP spoofing and packet filtering
- Can act as a DHCP server
- TFTP server support

Administration

- Web-based, TELNET, and command line management interfaces
- Configure using IP via the Ethernet or ISDN ports, or by using a direct serial link via the console port
- DTMF interface permits configuration with a touch tone telephone
- Statistics with real-time updates
- Ability to save and restore configuration locally or remotely
- SNMP MIB II support

Contacting customer services

To obtain technical support for Eicon products, contact your Eicon Technology supplier.

World wide web

Information about Eicon Technology products and services—including documentation and software updates—is available from our web site at **www.eicon.com/support**

Chapter Two

Getting Started

This chapter explains how to install and configure the DIVA LAN ISDN Modem to provide Internet access for up to four computers.

If this type of installation does not meet your needs, instructions for creating other types of installations are found in Chapter Eight and Chapter Nine.

1. Installation overview

The steps in this chapter explain how to install and configure DIVA LAN ISDN Modem to provide Internet access for up to four computers.

The following diagram illustrates the key components that are part of this installation.

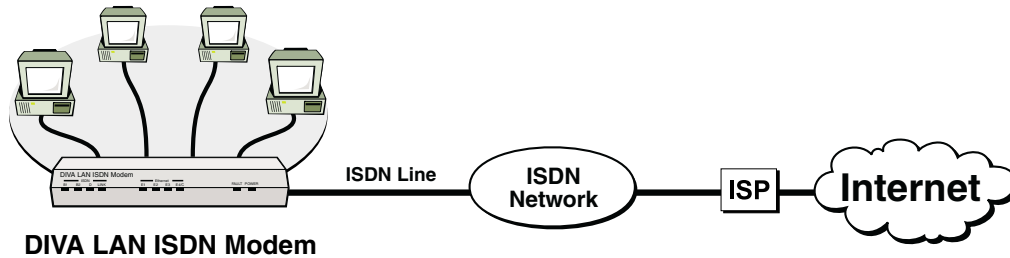

The installation process is composed of the following steps:

- Step 1. Installation overview
- Step 2. Prepare for installation
- Step 3. Choose a connection protocol
- Step 4. Order an ISDN Line
- Step 5. Gather Internet account information
- Step 6. Install the DIVA LAN ISDN Modem
- Step 7. Install Modem Monitor (Windows 95/98/NT4)
- Step 8. Connecting a non-Windows computer to the DIVA LAN ISDN Modem
- Step 9. Configuring the Internet connection
- Step 10. Using your DIVA LAN ISDN Modem

2. Prepare for installation

To ensure that the installation of your DIVA LAN ISDN Modem is quick and trouble free, take a few moments to prepare for installation.

Verify your package contents

Your package should contain the following:

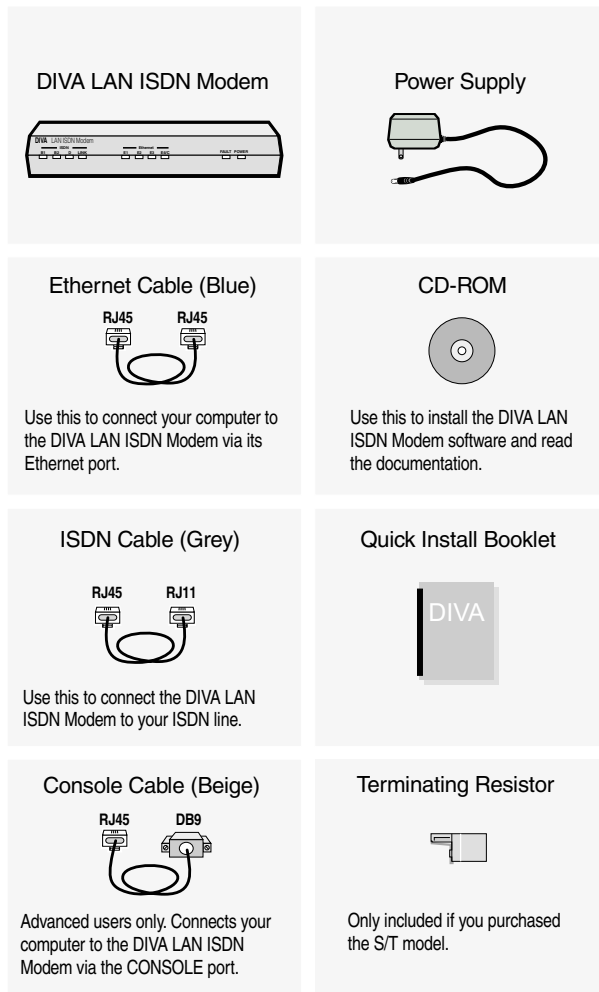

Verify the configuration of your computers

To connect to the DIVA LAN ISDN Modem

Each computer that will be connected to the DIVA LAN ISDN Modem must have:

- A 10BASE-T Ethernet network interface card, properly installed and configured to use the TCP/IP protocol. Consult the documentation that came with your card for instructions on how to do this. 100 Mbps Ethernet cards can only be connected to the DIVA LAN ISDN Modem if they support auto-sensing.
- the TCP/IP communications protocol configured as follows:
 - it must be set to obtain its IP address automatically (DHCP client)
 - it must not be configured to use a DNS server

See Appendix A for information on configuring TCP/IP.

To configure the DIVA LAN ISDN Modem

The computer you are going to use to configure the DIVA LAN ISDN Modem must have:

- Web browser software (Netscape 3.01 or later, or Internet Explorer 4 or later).
Internet Explorer 4 is included on the DIVA LAN ISDN Modem CD for computers running Windows 95, Windows 98, or NT 4.0 or later. NT 4.0 requires SP3 or SP4 available on the DIVA LAN ISDN Modem CD.
- The Web browser must be configured as follows:
 - Connect to the Internet via a local area network (LAN).
 - Do not connect through a proxy server.

To run the Modem Monitor software

The Modem Monitor software provides an easy way to manage the DIVA LAN ISDN Modem. To install and run this software you need:

- IBM-compatible 486, or Pentium-based computer running Microsoft Windows 95/98/NT4.0 or later
- CD-ROM drive

To use the advanced configuration options

For the advanced user, the DIVA LAN ISDN Modem offers additional configuration options. These options and their requirements are as follows:

- The *command line interface* (CLI) gives you complete access to all the DIVA LAN ISDN Modem configuration parameters. To access this interface you require Telnet software or a terminal emulation program.
- *TFTP* (trivial file transfer protocol) gives you access to all configuration files on the DIVA LAN ISDN Modem. You need TFTP client software to use this option. A TFTP program is included on the DIVA LAN ISDN Modem CD.
- The *DTMF interface* enables you to define certain DIVA LAN ISDN Modem configuration settings using a ordinary touch tone phone.

See Chapter Ten for more information on these configuration options.

3. Choose a connection protocol

The usage of the ISDN link is governed by the type of connection protocol you choose. The connection protocol defines the rules by which ISDN channels are enabled and disabled. The type of protocol you choose to use depends on the type of connections you plan to make.

Important ISDN concepts

Before you can decide on a connection protocol, you must become familiar with the following ISDN concepts.

ISDN channels

ISDN lines are defined in terms of *channels*, with each channel supporting a specific type of communication. The DIVA LAN ISDN Modem supports two ISDN channel types:

- **D-channel:** The Device channel is used to control the setup of ISDN connections on the other channels. They can also be used to transmit packet data traffic. The D-channel has a transmission speed of 16 kbps.
- **B-channel:** Bearer channels are used to carry data or voice traffic. They have a transmission speed of 56 or 64 kbps.

ISDN access interfaces

An access interface is the physical connection between you and an ISDN network. It defines the number of D- and B-channels that are available to you and the total transmission speed of the connection. The DIVA LAN ISDN Modem supports a single Basic Rate Interface (BRI), which is comprised of one D-channel (16 kbps) and two B-channels (64 kbps) for a total user bit rate of 144 kbps.

Each ISDN B-channel can have its own telephone number. Although in some cases you will only get one number for both channels unless you order supplementary services.

ISDN channel usage

The following diagram shows all the potential connections a DIVA LAN ISDN Modem could make, if it was configured to support an Internet connection, a corporate network connection, incoming data calls, and analog calls on both PHONE ports.

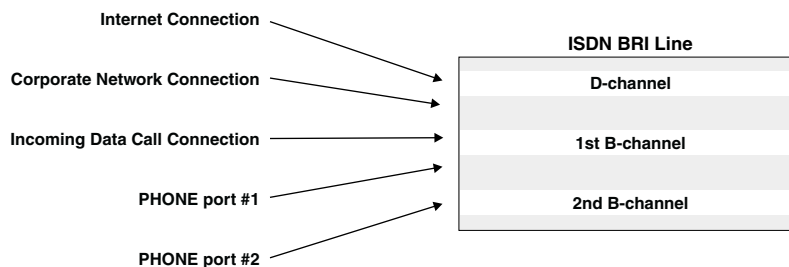

All connections, both data and voice, are carried on the B-channels. (AO/DI enables you to also use the D-channel for data connections, but this exception will be discussed later.) The DIVA LAN ISDN Modem dynamically assigns B-channels on-demand. Therefore, there is no guarantee which B-channel a specific connection will receive. The same is true for your ISDN phone numbers and your SPIDs. Your first phone number does not necessarily map to ISDN channel B1.

Connections are mapped as follows:

- PHONE port 1 always uses the first ISDN phone number (and SPID).
- PHONE port 2 always uses the second ISDN phone number (and SPID).
- To help avoid conflicts, the DIVA LAN ISDN Modem always tries to establish data connections using phone number 2 first, in an attempt to leave PHONE port 1 free. Of course, if phone number 2 is in use, the data connection is established using phone number 1.
- When an analog or data connection is established, the first available ISDN B-channel is assigned to it.

Choosing a connection protocol

Since the DIVA LAN ISDN Modem supports so many potential connections, a set of rules is needed to control how the two ISDN B-channels are shared between connections. These rules are based on the type of *connection protocol* you decide to use for your data traffic. The DIVA LAN ISDN Modem supports the two protocols: PPP and V.120.

- PPP is a widely-used standard for transferring data on point-to-point links. The DIVA LAN ISDN Modem supports four variations of the PPP protocol: PPP, Multilink PPP, Multilink PPP+BACP, and Multilink PPP+AO/DI. Each version has its own specific features as detailed later in this section.
- V.120 was designed to allow non-ISDN devices to communicate with the ISDN network. The DIVA LAN ISDN Modem provides support for V.120, so you can connect with such legacy systems. For example, in many countries around the world, CompuServe offers access to their network over ISDN, using the V.120 protocol.

By choosing the correct protocol variation for your connection, you control how the ISDN channels are assigned and how the DIVA LAN ISDN Modem provides support for analog calls.

PPP

PPP operates on a single ISDN B-channel. Since two B-channels are available, the DIVA LAN ISDN Modem can support two PPP connections at the same time. This is useful if you need to have two connections that need to be established at the same time. For example, to maintain a connection to the Internet and to a remote corporate network, or if you intend to support incoming data calls.

By default, the DIVA LAN ISDN Modem is configured to support call bumping. However, a PPP connection will never be disconnected to allow an incoming or outgoing analog call to connect. If two PPP connections are active, no analog calls can be made or received.

Multilink PPP

When you activate multilink PPP (MLPPP), the DIVA LAN ISDN Modem combines both your B-channels into a single 128 kbps communications link. Both B-channels remain in use as long as the connection is active, which may result in excessive ISDN connection charges if the link is frequently idle.

MLPPP reserves both B-channels for its exclusive use. This means that if your Internet connection uses MLPPP, you will not be able to make or receive other data calls.

Analog calls, however, are governed by a different set of rules. By default, the DIVA LAN ISDN Modem is configured to support call bumping. Call bumping causes MLPPP to drop one B-channel when you make or receive an analog call. This reduces the throughput of the data call to 64 kbps. When the analog call is done, MLPPP re-establishes the second B-channel, returning the data connection to 128 kbps.

Only one PHONE port can be used when an MLPPP connection is active. This can be either PHONE 1 or PHONE 2.

Multilink PPP + BACP

To save on communications charges, you can use BACP in combination with MLPPP. The DIVA LAN ISDN Modem uses BACP to monitor incoming and outgoing traffic, and to open or close the second B-channel as the traffic volume warrants. This reduces your communications charges by ensuring that two ISDN channels are never active when one is sufficient. For information on how to configure BACP, see “Configuring BACP” on page 61.

As with MLPPP, MLPPP + BACP reserves both B-channels for its exclusive use. This means that if your Internet connection uses MLPPP + BACP, you will not be able to make or receive other data calls.

As with MLPPP, call bumping causes MLPPP + BACP to drop one B-channel (if both are active), when you make or receive an analog call.

Only one PHONE port can be used when an MLPPP + BACP connection is active. However, since MLPPP + BACP may only be using one B-channel, either PHONE 1 or PHONE 2 may not be available. For example, if PHONE 2 was in use when the data connection was established, the data connection uses telephone number 1. Even though telephone number 2 becomes available when PHONE 2 hangs up, the data connection does not switch over. If you try to use PHONE 1, you will get a busy signal.

Multilink PPP + AO/DI

Always On/Dynamic ISDN uses the ISDN D-channel to maintain a permanent connection to your ISP or corporate network. This connection operates at 9.6 kbps using the X.25 protocol. It can be used to send and receive low-bandwidth data, such as e-mail or web-based push content.

AO/DI incorporates BACP, and uses it to monitor incoming and outgoing traffic. When traffic volume warrants, it enables one or two B-channels to meet the demand. For information on AO/DI, see “Configuring AO/DI” on page 63.

As with MLPPP, MLPPP + AO/DI reserves both B-channels for its exclusive use. This means that if your Internet connection uses MLPPP + AO/DI, you will not be able to make or receive other data calls.

MLPPP + AO/DI can drop both B-channels, allowing you to make or receive two analog calls. Since the data connection is still active on the D-channel, you can use both phone ports at any time. Note, however, that the speed of the D-channel (9.6 kbps) is much slower than a B-channel (64 kbps).

V.120

V.120 was designed to allow non-ISDN devices to communicate with the ISDN network. The DIVA LAN ISDN Modem provides support for V.120, so you can connect with such legacy systems. For example, in many countries around the world, CompuServe offers access to their network over ISDN, using the V.120 protocol.

V.120 operates on a single ISDN B-channel. Since two B-channels are available, the DIVA LAN ISDN Modem can support two V.120 connections at the same time. In general, you should use V.120 only when the site you are connecting to requires it. Once the V.120 connection is active, the DIVA LAN ISDN Modem automatically establishes a PPP connection on top of it. This is why you will see this option listed as *PPP over V.120* on the configuration screens.

A V.120 connection will never be disconnected to allow an incoming or outgoing analog call. If two V.120 connections are active, no analog calls can be made.

Summary

The following summary will help you determine how ISDN channels are assigned by the various connection protocols. This summary assumes that call bumping is enabled.

- If a data connection using any MLPPP-related protocol is connected, it reserves both ISDN B-channels. This means that no other data call can be established.
- If a data connection using MLPPP is connected, only one PHONE port can be used at a time.
- If a data connection using MLPPP-BACP is connected, one PHONE port (in most cases PHONE 2), will not be available.
- If a data connection using MLPPP-AO/DI is connected on one or both ISDN B-channels, one or both B-channels will be dropped to allow an incoming or outgoing analog call to connect.
- Data connections using PPP or V.120 are established first on telephone number 1, then on telephone number 2. If two PPP or V.120 data connections are active, no PHONE ports are available.
- If both PHONE ports are in use, no data calls can be established. Unless you are using AO/DI, which can make use of the D-channel.

4. Order an ISDN Line

Call your local phone company and order an **ISDN Basic Rate line**.

To make ordering an ISDN line easier, Bellcore, in conjunction with the North American ISDN User's Forum (NIUF) and Local Exchange Carriers (LEC), have created several pre-defined ISDN packages which you can order by simply specifying an ISDN ordering code (IOC).

Ordering Code	Features
EZ-ISDN 1 or IOC: "U"	Offers voice and data on both ISDN channels and supports advanced calling features such as call conference, call transfer, and caller ID on the first ISDN number. You may have to request these features individually, and there may be an additional charge for each one.
EZ-ISDN 1A or IOC: "V"	Same as EZ-ISDN 1, but adds Voice Mail support.
IOC: "S"	Offers voice and data on both B-channels, but without any advanced calling features. If you select this package, be sure to get Additional Call Offering (ACO). ACO is required for call bumping (also known as dynamic bandwidth allocation) and call waiting to work correctly. IOC "S1" includes ACO, however it is not supported everywhere.
EZ-ISDN 3 or 3A	If you want to use Always On/Dynamic ISDN (AO/DI).
Capability Package AB	Same as IOC U, but with advanced calling support on both channels and support for AO/DI.
Capability Package AC	Same as IOC V, but with advanced calling support on both channels and support for AO/DI.

Information to record when ordering your line

Item	Description
ISDN phone number(s)	The phone number assigned to your ISDN line. Some providers will give you two phone numbers—one for each ISDN channel.
SPID(s)	<p>SPIDs (service profile IDs) identify the set of features and services provided by the ISDN switch to which the ISDN device is connected.</p> <p>When you subscribe to an ISDN line your provider allocates a SPID in the same way they allocate an ISDN phone number. In some cases, the SPID is the same as the phone number, in other cases it is the phone number with other digits added to it. It depends on your provider.</p> <p>Find out if your ISDN line supports AutoSPID. AutoSPID is a new National ISDN protocol feature that enables the DIVA LAN ISDN Modem to automatically configure all parameters for your ISDN line.</p> <p>However, even if your ISDN line supports AutoSPID, it is a good idea to write down your SPIDs.</p>
Switch type	The type of ISDN switch used by your provider. During configuration, the DIVA LAN ISDN Modem automatically tries to detect the switch type your line is connected to. However, if auto-detection fails, you need to manually specify the switch type. Three types are supported: National ISDN-1, AT&T 5ESS, or AT&T 5ESSPP (5ESS Point-to-Point).
Billing intervals	Find out how your provider bills for ISDN usage. With this information on hand you can configure the DIVA LAN ISDN Modem to minimize your connection costs. See "Multilink PPP + BACP" on page 21.

5. Gather Internet account information

Obtain an account with an ISP (Internet Service Provider) and record the following:

Item	Description
ISP's ISDN phone number(s)	This is the phone number the DIVA LAN ISDN Modem dials to access the ISP. Some ISPs will give you two phone numbers—one for each ISDN channel. Your ISP may also have a backup number for each channel in case the primary number is busy or unavailable.
User name	Name the DIVA LAN ISDN Modem will use to access the ISP.
Password	Password the DIVA LAN ISDN Modem will use to access the ISP.
Primary DNS server address Secondary DNS server address	To reach other sites on the Internet you need to use your ISP's DNS server. In most cases, the DIVA LAN ISDN Modem will automatically discover the addresses of these servers. However, if it is unable to do so, you will have to enter them manually. Addresses are written as four numbers separated by periods. Each number can range from 0 to 255. For example: 123.123.123.123 or 192.168.1.1
X.25 information	If you intend to use AO/DI, collect the information on page 24 as well.

Gather X.25 information

If you intend to use AO/DI, you will require the following information:

Item	Description
Remote X.25 address	The X.25 address of your ISP or the corporate network you want to connect to.
Local X.25 address	The X.25 DTE address assigned to the DIVA LAN ISDN Modem. This may not be required on some X.25 switches.
Default window size Maximum window size	The DIVA LAN ISDN Modem supports windows sizes from 1 to 7.
Default packet size Maximum packet size	The DIVA LAN ISDN Modem supports packet sizes from 64 to 1024 bytes.
Number of VCs	Number of virtual circuits. The DIVA LAN ISDN Modem supports up to 4 two-way virtual circuits.
ISDN TEI type	Determine if TEI assignment is static, dynamic, or shared. If static, get the number assigned to the D-channel.

Gather V.120 information

If you intend to use V.120, you will require the following information:

Item	Description
Mode	Two modes are supported: Unacknowledged or Multiframe.
Maximum transmit frame size Maximum receive frame size	This is the maximum size of a V.120 information field that can be transmitted or received. The DIVA LAN ISDN Modem supports frame sizes from 16 to 260 bytes.

Item	Description
Window size	Applies to Multiframe mode only. The DIVA LAN ISDN Modem supports windows sizes from 1 to 7.
Maximum retry count	Applies to Multiframe mode only. Defines the maximum number of retransmissions of an unacknowledged frame.
Retransmission timer (T200)	Applies to Multiframe mode only. Defines how long to wait before retransmitting an unacknowledged frame.
Link Integrity timer (T203)	Applies to Multiframe mode only. Defines the maximum time the connection can remain idle without data or control frames being exchanged.
Idle timer	Defines the maximum time the connection can remain idle without data frames being exchanged.

V.120 scripting

To successfully log on to your ISP, you will need to define a script to automatically execute the log on process for you. The DIVA LAN ISDN Modem contains a pre-defined script that should work in the majority of cases. However, you may need to modify this script for your installation.

To modify this script, you need to determine the sequence of events that occur when logging on to your ISP, and the input that must be sent. For example:

- Step 1: *Your ISP issues the prompt "Login:" and expects you to send your user name, then press Enter.*
- Step 2: *Your ISP issues the prompt "password:" and expects you to send your password, then press Enter.*

For more information on scripting see "Making a V.120 connection" on page 136.

6. Install the DIVA LAN ISDN Modem

Installing the DIVA LAN ISDN Modem is as simple as plugging it in and connecting a few cables. Before you begin make sure that each computer has the required prerequisites as explained in the section “Verify the configuration of your computers” on page 18.

Note *The DIVA LAN ISDN Modem is available with or without analog phone ports. Phone related features are only available on models with analog phone ports.*

Consult the following diagram as you perform the installation.

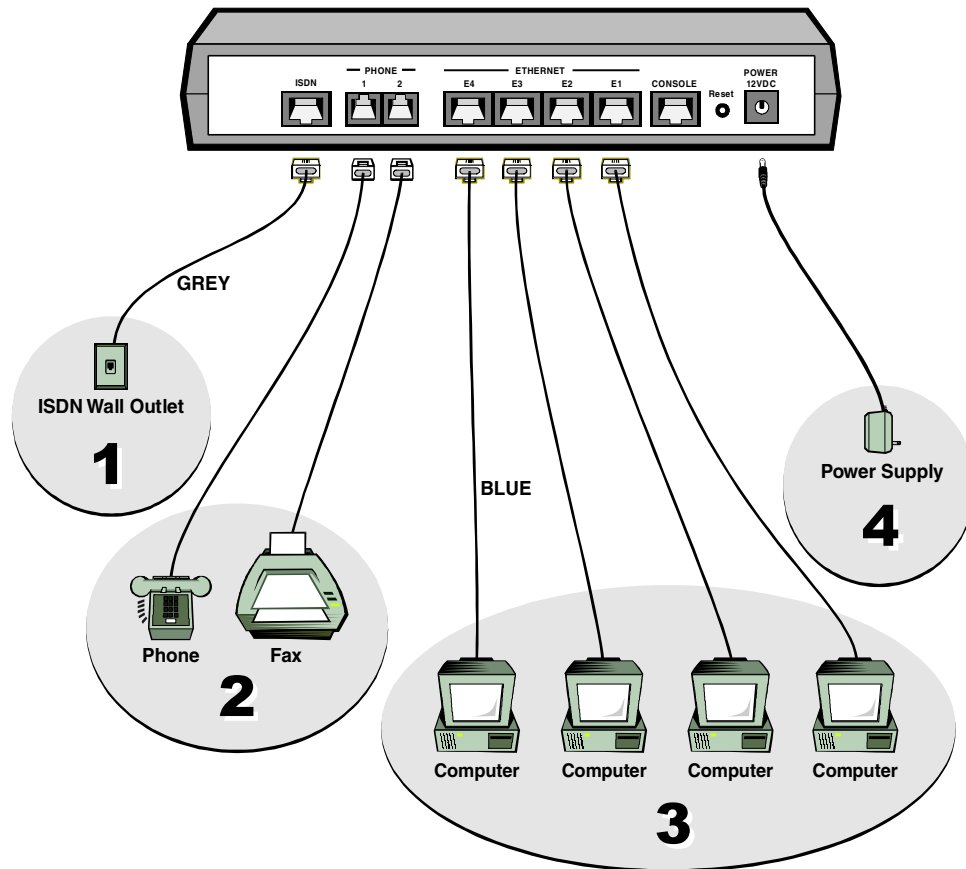

To install the DIVA LAN ISDN Modem

1. Connect the DIVA LAN ISDN Modem to your ISDN line using the supplied grey ISDN cable. Plug the RJ45 connector (big end) into the DIVA LAN ISDN Modem and plug the RJ11 connector (small end) into your ISDN wall outlet.
 - If you are installing a DIVA LAN ISDN Modem with a U interface, make sure that it is the only device connected to your ISDN line.
 - If you are installing a DIVA LAN ISDN Modem with an S/T interface, you may need to connect the terminating resistor. See “Termination” on page 161 for more information.
2. You can connect analog devices, such as telephones or fax machines, to the PHONE ports. It is recommended that you use PHONE 1 for voice and PHONE 2 for data (modem or fax).
3. Turn off your computers and then connect them to the Ethernet ports on the DIVA LAN ISDN Modem. It does not matter which Ethernet port you plug your computers into. All Ethernet ports are the same. One Ethernet cable (blue) is supplied as part of the DIVA LAN ISDN Modem package. If you are connecting more than one computer, printer, or other network resource, you will require additional Ethernet cables.

4. Connect the power supply to the POWER jack on the DIVA LAN ISDN Modem, and plug it into a power outlet.
5. Wait at least 10 seconds for the DIVA LAN ISDN Modem to initialize.
6. Turn on your computers.
7. You are now ready to install the Modem Monitor software and configure the DIVA LAN ISDN Modem.

Note *Do not connect the beige cable. It is for advanced configuration options only. See Chapter Eight.*

7. Install Modem Monitor (Windows 95/98/NT4)

Note If you are using an operating system other than Windows 95/98/NT4, turn to page 31.

Modem Monitor provides quick access to the DIVA LAN ISDN Modem Web-based configuration interface, as well as online help, and utilities.

Modem Monitor runs under Windows 95/98/NT4. It should be installed only on the computer you are going to use to configure the DIVA LAN ISDN Modem. Other computers that are connected to the DIVA LAN ISDN Modem must be configured as explained in the section “Verify the configuration of your computers” on page 18. Other than this, they require no additional software to be installed.

To install Modem Monitor

1. Insert the DIVA LAN ISDN Modem CD into the CD-ROM drive on your computer. The setup program will automatically start. If it does not, click “CDSETUP.EXE” in the root folder of the CD.
2. On the Welcome screen, click *Install Software/View Documentation*.

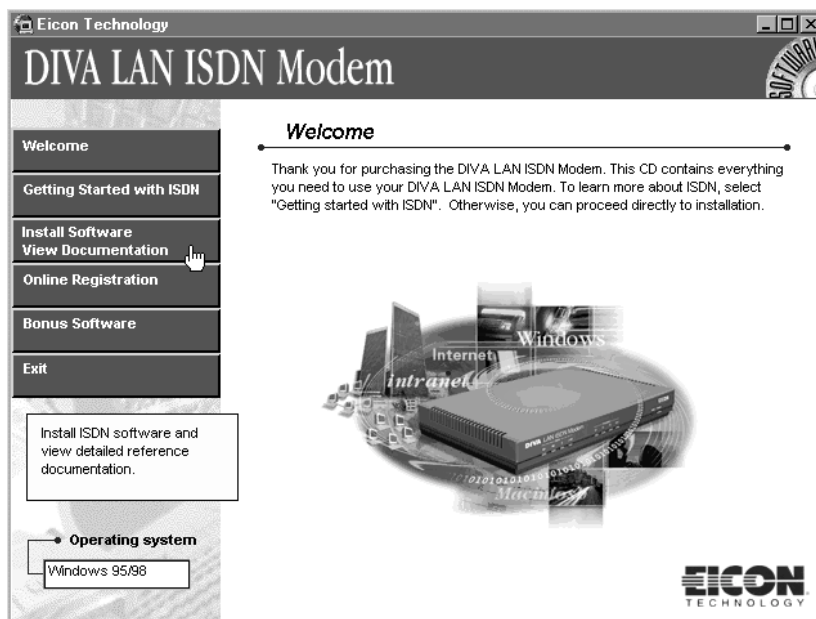

3. On the Install Software screen, click *Install DIVA LAN ISDN Modem Software*.

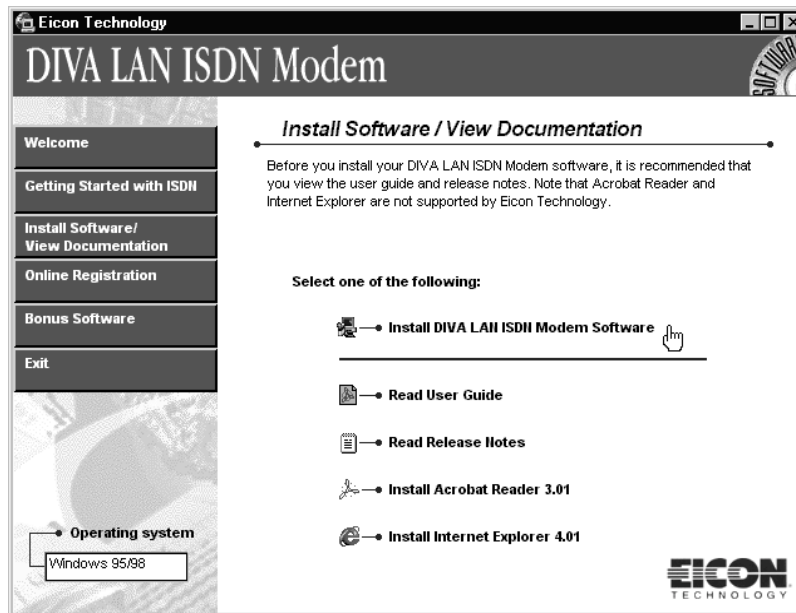

4. The DIVA LAN ISDN Modem Setup Wizard starts. Follow the directions on your screen to install the software.

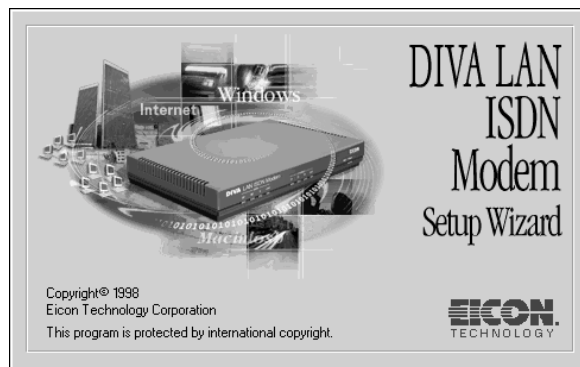

5. Once installation is complete, the Setup Wizard then attempts to contact the DIVA LAN ISDN Modem.

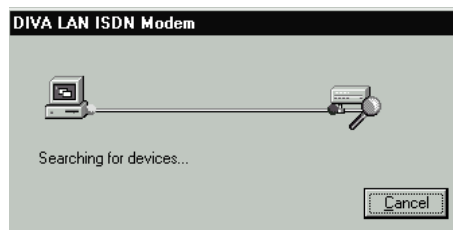

6. Once detected, the Setup Wizard starts the Network Wizard. The Network Wizard will verify that you can communicate with the DIVA LAN ISDN Modem. If a problem is found, the Network Wizard will help you correct it.

If at any point you are prompted to upgrade the firmware on your DIVA LAN ISDN Modem, do so. The procedure is automatic. In certain cases, the firmware on the CD-ROM may be more recent than that installed in the DIVA LAN ISDN Modem. For more information on firmware upgrades see “Upgrading the DIVA LAN ISDN Modem firmware” on page 56.

7. When the Network Wizard is done, you will see the following dialog box.



8. Click *Configure*. The DIVA LAN ISDN Modem launches your default Web browser and displays the first page of the Internet wizard.

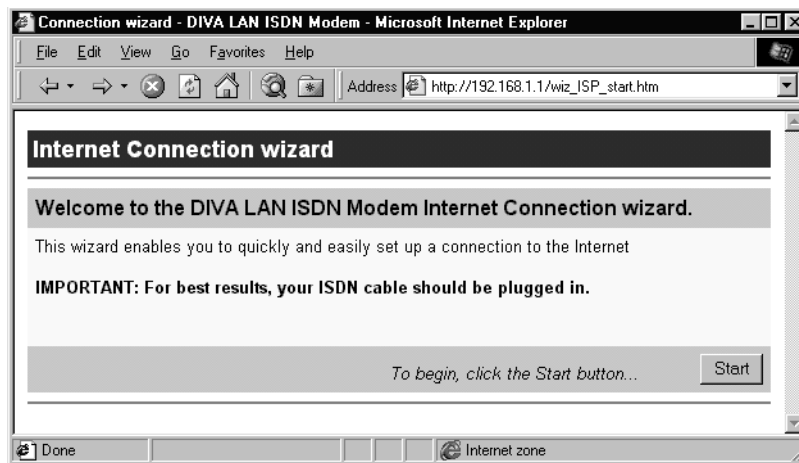

If your Web browser is unable to load this page, make sure that:

- it is configured to use the LAN, and *not* a dial-up connection
 - it is *not* set to use a proxy server
9. Turn to the section "Configuring the Internet connection" on page 33 for a complete walkthrough of the wizard.

8. Connecting a non-Windows computer to the DIVA LAN ISDN Modem

Note *If you are using an operating system other than Windows 95/98/NT4, follow the steps in this section to configure your system so that it can communicate with the DIVA LAN ISDN Modem.*

To connect to the DIVA LAN ISDN Modem

1. Make sure that your computer has TCP/IP installed, configured, and bound to its Ethernet card.
2. Enable DHCP client support. This allows your computer to automatically obtain its IP address from the DIVA LAN ISDN Modem (which acts as a DHCP server). If you do not want to use the DIVA LAN ISDN Modem as your DHCP server, make sure that the IP address assigned to your computer is on the same IP network as the DIVA LAN ISDN Modem (192.168.1.0), and that its subnet mask is 255.255.255.0. A simple solution is to use the address 192.168.1.2 for your computer. You must also ensure that the DIVA LAN ISDN Modem is added to your list of gateways and DNS servers.
3. Determine if your computer can communicate with the DIVA LAN ISDN Modem. Start your web browser (Netscape 3.01 or later, or Internet Explorer 4.x).
4. Specify the address 192.168.1.1 and press Enter. (If you changed the address of the DIVA LAN ISDN Modem, enter the new address instead.)
5. Your web browser will load the Log In page.



If you cannot load the log in page, try to PING the DIVA LAN ISDN Modem with the command: PING 192.168.1.1.

If you receive a reply, your Web browser may not be configured properly. Make sure that:

- it is configured to use the LAN, and **not** a dial-up connection
- it is **not** set to use a proxy server

If you do not receive a reply, it is likely that your TCP/IP settings are incorrect, verify the settings you made in step 1 and 2.

6. Click *Log In*. (Until you set a password, none is required to log in.)

7. The DIVA LAN ISDN Modem displays the Configuration main menu.

DIVA LAN ISDN Modem
Configuration main menu



Quick start

Internet wizard - Quickly create a connection to the Internet.

Administration These options are only fully enable once you complete the Internet wizard

Connection profiles

Configure your connection profile settings.

Manual configuration

Manual access to all configuration settings.

Statistics

See current statistics for all protocols.

View system status and log

Information on the status, past and present, of your device.

Maintenance

Update and backup your configuration or firmware.

Information

Contact us, technical support, etc...



Reset

Log out



8. The Configuration main menu gives you access to all configuration options. However, the first time you start the web configuration program, most of the options in the Administration section are disabled. These options only become available once you have configured the DIVA LAN ISDN Modem with the Internet wizard.
9. Click *Internet wizard*. The DIVA LAN ISDN Modem displays the first page of the Internet wizard. Turn to the section “Configuring the Internet connection” on page 33 for a complete walkthrough of the wizard.

9. Configuring the Internet connection

This section explains how to use the Internet wizard to set up an Internet connection.

Configuration occurs via a series of web pages that reside on the DIVA LAN ISDN Modem. You use your web browser to access these pages and change configuration settings.

To configure the Internet connection

1. Regardless of the type of operating system you are using, you should see the following web page in your browser. If you do not see this page, return to the section you came from and retry the instructions.

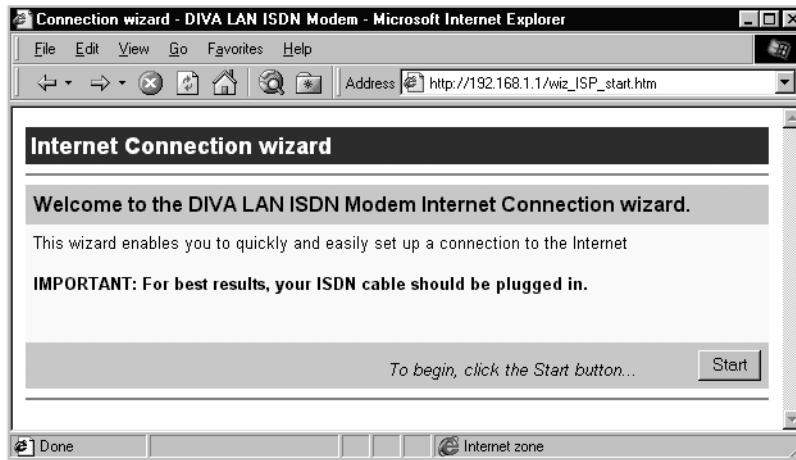

2. Click *Start*.
3. Depending on how SPIDs are configured on your ISDN line, you will see one of the following three pages:
 - If your line supports AutoSPID, the DIVA LAN ISDN Modem will discover your SPIDs and directory numbers and present them to you. Simple click Next to continue. For example, this screen shows the results of AutoSPID:

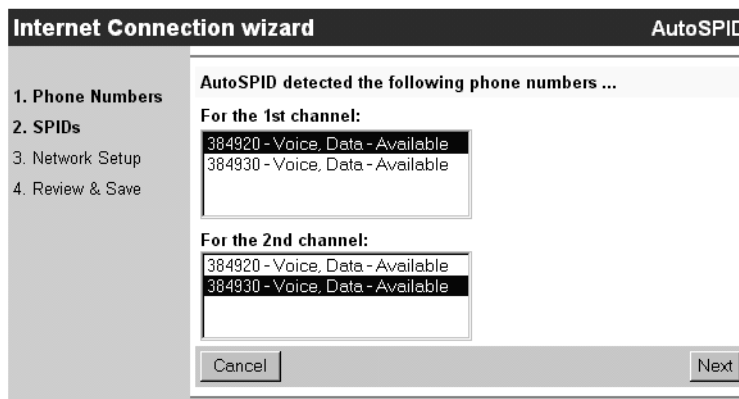

- If your line does not support AutoSPID, you will see the following page:

Enter your area code and your ISDN numbers and click *Next*. The DIVA LAN ISDN Modem will use this information to attempt to guess your SPIDs. If SPID guessing is successful, go to step 4. If not, see the next bullet below.

- If SPID guessing fails or your ISDN line is not plugged in, you will see the following page:

Specify your switch type, your ISDN numbers, and your SPIDs. Click *Next* to continue.

4. The Internet Network Setup page is where you define the characteristics of your connection.

5. Fill in the fields as indicated below.

- A** This is the name assigned to your Internet connection profile. It is recommended that you do not change it.
- B** Specify your ISP's ISDN phone numbers. If your ISP uses two numbers (one for each B-channel), enter the second one after the first. Separate the two with an ampersand (&), a tilde (~), or a forward slash (/). For example: 7451111/7451113
- C** Set a communications protocol for this connection. If you are unsure about which protocol to use, leave the default setting (MLPPP). It has been chosen to work with the majority of switches.
See "Choose a connection protocol" on page 20 for more information.
- D** If you are using AO/DI, enter the X.25 address of your ISP. The wizard will set default values for other X.25-related parameters, which should work for the majority of connections. If your AO/DI connection does not work with these default settings, you will have to configure these parameters manually. See "Configuring AO/DI" on page 63 for instructions on how to do this.
- E** Specify the user name and password given to you by your ISP.
- F** If your ISP supplied you with the addresses of its DNS servers, enter them. If not, leave these addresses as 0.0.0.0. When the DIVA LAN ISDN Modem connects with your ISP, it will automatically discover these addresses (if supported by your ISP).

6. Click *Next*. The DIVA LAN ISDN Modem displays a summary of your settings and asks you to verify them. For example, this screen shows the configuration settings for a connection with no backup telephone number, and no DNS server addresses.

Internet Connection wizard	Review & Save
1. Phone Numbers 2. SPIDs 3. Network Setup 4. Review & Save 5. Test & Connect	<p>Setup is ready to create a connection with the following characteristics.</p> <hr/> <p>ISDN switch type: National ISDN (NI-1) ISDN number for B1: 5147456408 SPID 1: 514745640800 ISDN number for B2: 5147457223 SPID 2: 514745722300</p> <hr/> <p>Primary telephone number: 98761183 Backup telephone number:</p> <hr/> <p>PPP settings: Multilink PPP</p> <hr/> <p>Username: Edwin Password: *****</p> <hr/> <p>Primary DNS address: 0.0.0.0 Secondary DNS address: 0.0.0.0</p> <hr/> <ul style="list-style-type: none"> • Now is a good time to test your configuration by connecting. Click on "Save + Test" to connect. • If you do not want to test at this point and your configuration is good, click "Save" • Otherwise, click "Back" and correct those that are in error.
	<input type="button" value="Back"/> <input type="button" value="Save"/> <input type="button" value="Save + Test"/>

7. Click Save + Test. This will validate your configuration and point out any errors.

Note *If your ISDN line is not connected, the Save + Test option is not available.*

8. First, your configuration is saved to the DIVA LAN ISDN Modem.

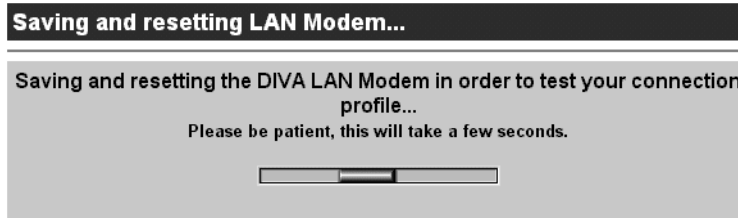

9. Next, the test is executed. For example, this page shows the results of a successful test:

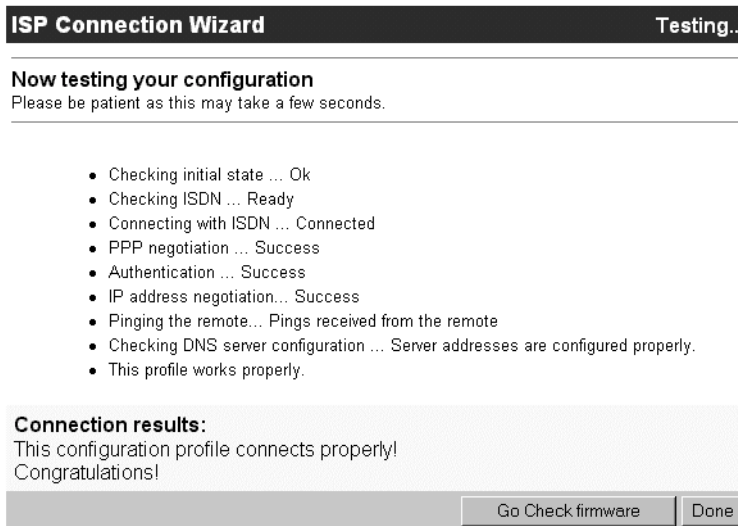

This page shows the results of a test that failed due to an invalid username or password. Fix the settings that are in error and try the test again.

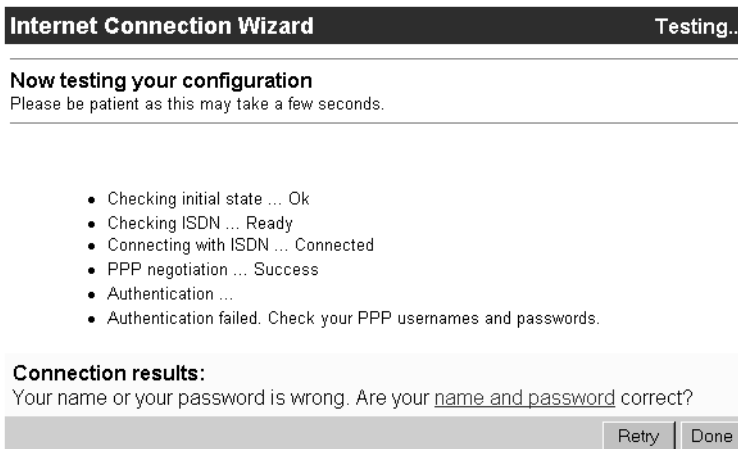

10. If your test was successful, you are now connected to the Internet.
 - Click the *Go Check Firmware* button to visit the Eicon Technology web site. There you will find the latest firmware for your DIVA LAN ISDN Modem and other news and information as it becomes available.
 - To visit any other web site, simply enter the URL in your browser and press Enter. You may want to visit **www.isdnzone.com**. This site was created by Eicon Technology and is devoted to all things ISDN.
11. See “Using your DIVA LAN ISDN Modem” on page 38 for information on how the DIVA LAN ISDN Modem operates.

10. Using your DIVA LAN ISDN Modem

The DIVA LAN ISDN Modem automatically dials out and establishes the ISDN link to the Internet as required. You simply launch the applications you use to do your work, such as a web browser or e-mail program, and you are automatically connected.

You can also establish your connections manually, dialing and hanging up as you see fit. See the Dial and Hangup buttons on page 45 for details.

How long will the line stay connected?

By default, the DIVA LAN ISDN Modem stays connected until the line has been idle for two minutes. To adjust this setting, see “Idle timer” on page 59.

Registering your DIVA LAN ISDN Modem

Once your setup is running you should visit the Eicon web site and register your DIVA LAN ISDN Modem. This ensures that you will always be kept up-to-date of new features and firmware releases. Point your web browser to:

www.eicon.com/divalan/downld.htm

or follow the firmware upgrade procedure in the section “Upgrading the DIVA LAN ISDN Modem firmware” on page 56. Registration is part of the upgrade process.

What’s next?

The rest of this manual provides in depth information and instruction on a variety of topics relating to operating and configuring the DIVA LAN ISDN Modem.

Some of the topics that you may want to consult are:

Minimizing your ISDN charges

The DIVA LAN ISDN Modem has several pre-defined settings to help reduce your ISDN charges. To adjust these settings for your installation, see Chapter Five.

Using telephones, fax machines, and modems

If your DIVA LAN ISDN Modem has PHONE ports, you can share the ISDN line with your analog devices. Consult Chapter Seven for complete details on setting up your analog devices.

Configuring security features

The DIVA LAN ISDN Modem provides a wide range of security features. Some of the features you may want to configure include:

- *System password:* A system password is also available to restrict access to the configuration interface.
- *Support for remote management:* By default, remote access to the configuration is disabled.
- *Support for incoming data calls:* By default, support for incoming data calls is disabled.
- *Call screening:* Lets you accept incoming data calls only from specific numbers.
- *Call authentication:* Lets you verify incoming callers by username and password.

Consult Chapter Six for complete details.

Using Modem Monitor

The Modem Monitor program provides an effective way to manage your DIVA LAN ISDN Modem. This section provides an overview of some of Modem Monitor's main functions. For more information, consult the Modem Monitor online help.

Note *Modem Monitor is available for Windows 95/98/NT4 systems only and should be installed on only one computer connected to the DIVA LAN ISDN Modem.*

Starting Modem Monitor

By default, Modem Monitor is automatically loaded each time you start Windows. An icon appears in your system tray to indicate it is running. The icon will change its appearance depending on the state of your DIVA LAN ISDN Modem. If you place your cursor on the Modem Monitor icon, it will display a tooltip describing the current state.

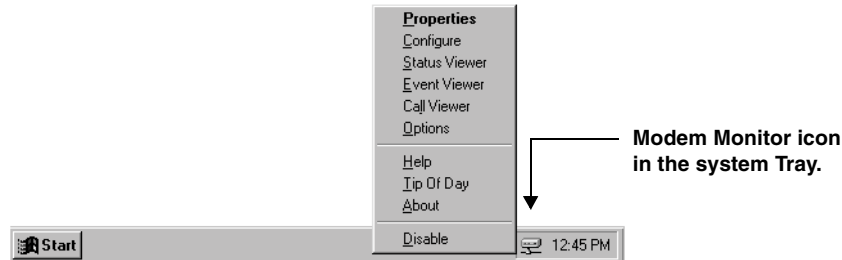

Right-click the Modem Monitor icon to display the menu. The following options are available:

- **Properties:** Displays the Properties dialog box which gives you quick access to your DIVA LAN ISDN Modem. See “Properties dialog box” on page 42. Double-clicking the Modem Monitor icon also opens the Properties dialog box.
- **Configure:** Opens the DIVA LAN ISDN Modem Web-based configuration interface in your default web browser. See Chapter Four for more information.
- **Status Viewer:** Starts the Status Viewer, which lets you view the status of your DIVA LAN ISDN Modem and manually dial or disconnect your connections.
- **Event Viewer:** Starts the Event Viewer, which lets you view the list of messages recorded in the log file.
- **Call Viewer:** Starts the Call Viewer, which lets you view information for all incoming and outgoing calls.
- **Options:** Lets you set Modem Monitor configuration options. To keep Modem Monitor from running each time you start Windows, disable the “Run DIVA LAN ISDN Modem Monitor at startup” option.
- **Help:** Starts the online help.
- **Tip Of Day:** Displays a helpful tip on using Modem Monitor.
- **About:** Displays the Modem Monitor version number.
- **Disable:** Closes Modem Monitor.

Start menu program group

Another way to load Modem Monitor is to use the Start menu.

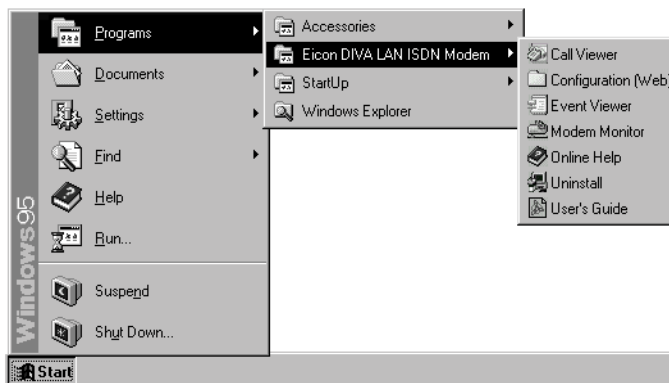

Start menu options

- **Call Viewer:** Starts the Call Viewer, which lets you view information for all incoming and outgoing calls.
- **Configuration (Web):** Opens a folder from which you can start the web-based configuration program.
- **Event Viewer:** Starts the Event Viewer, which lets you view the list of messages recorded in the log file.
- **Modem Monitor:** Opens the Modem Monitor properties dialog box.
- **Online Help:** Starts the Modem Monitor online help.
- **Uninstall:** Removes the Modem Monitor software from your computer.
- **User's Guide:** Opens the DIVA LAN ISDN Modem User's Guide using Adobe Acrobat Reader.

Properties dialog box

The Modem Monitor Properties dialog box gives you quick access to your DIVA LAN ISDN Modem. To access it, double-click the Modem Monitor icon in your system tray.

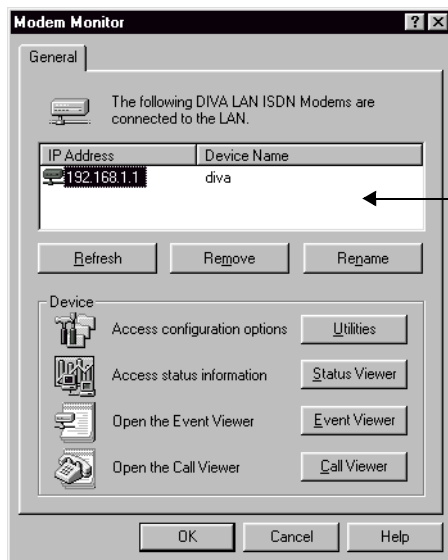

Displays the list of active DIVA LAN ISDN Modems that are reachable from your computer.

Buttons

- **Utilities:** Let's you perform configuration tasks.
- **Status Viewer:** Starts the Status Viewer, which lets you view the status of your DIVA LAN ISDN Modem and manually dial or disconnect your connections.
- **Event Viewer:** Starts the Event Viewer, which lets you view the list of messages recorded in the log file.
- **Call Viewer:** Starts the Call Viewer, which lets you view information for all incoming and outgoing calls.

Utilities dialog box

Display the Utilities dialog box by clicking the Utilities button in the Properties dialog box.

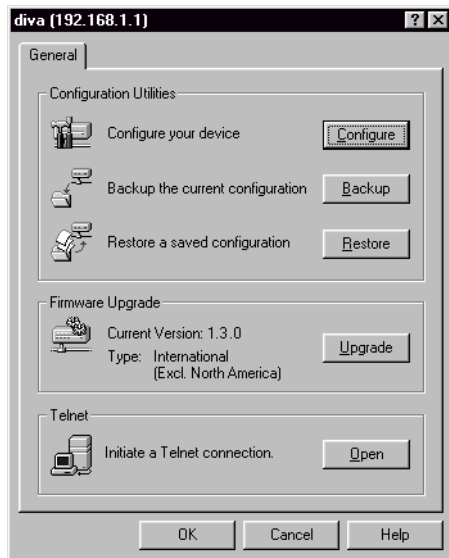

Buttons

- **Configure:** Starts the web-based configuration interface using your default web browser.
- **Backup:** Backs up the current configuration settings to a file on your computer.
- **Restore:** Restores a saved configuration from a file on your computer.
- **Upgrade:** Upgrades the DIVA LAN ISDN Modem with new firmware you have downloaded to your computer. Use the Maintenance option in the web-based configuration interface to download the new firmware. See “Upgrading the DIVA LAN ISDN Modem firmware” on page 56.
- **Open:** Starts a Telnet connection with the DIVA LAN ISDN Modem. This provides you with access to the CLI configuration interface for advanced configuration and troubleshooting. See “Command line interface (CLI)” on page 146.

Options dialog box

Lets you define the operational characteristics of the Modem Monitor software.

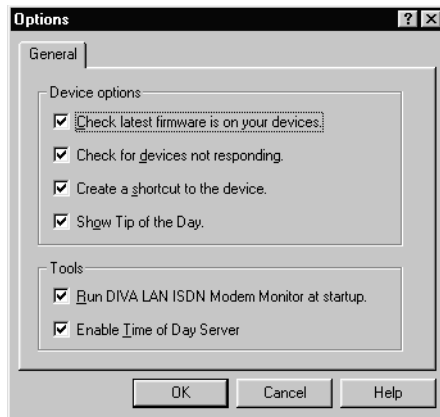

Check latest firmware is on your device

When enabled, Modem Monitor automatically checks if the firmware on your DIVA LAN ISDN Modem is the latest firmware version available on your computer.

Check for devices not responding

When enabled, Modem Monitor checks if any DIVA LAN ISDN Modem's on your LAN are not responding. A DIVA LAN ISDN Modem may not be responding for two reasons:

- It is not powered up or connected correctly.
- It has been removed from the LAN.

Create a shortcut to the device

When enabled, Modem Monitor automatically creates a shortcut on the desktop to the Web-based configuration interface.

Show Tip of the Day

When enabled displays the Tip of the Day.

Run DIVA LAN ISDN Modem Monitor at startup

When enabled, Modem Monitor automatically loads when you start your computer.

Enable Time of Day Server

Enables Modem Monitor to function as a Time of Day Server using the time and date set on your computer. The DIVA LAN ISDN Modem will update its internal clock by periodically contacting Modem Monitor.

Status Viewer

Lets you view the operational status of the DIVA LAN ISDN Modem and manually manage your connections.

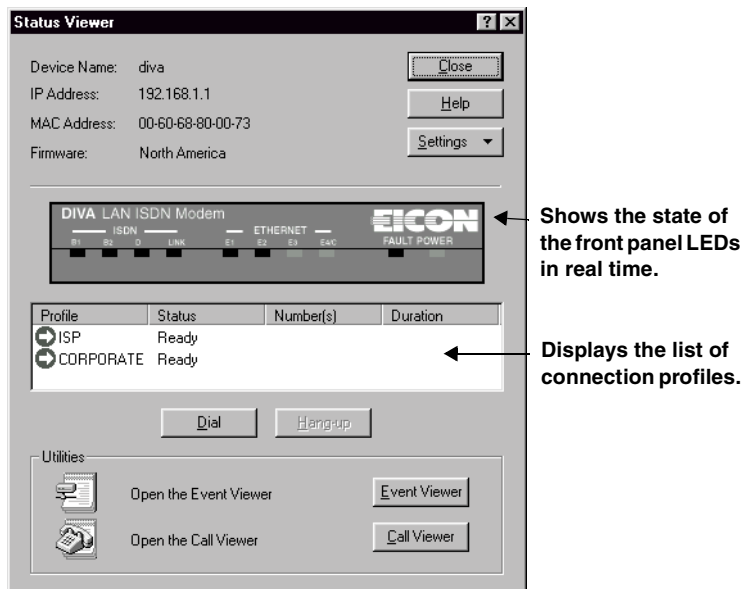

- **Device name:** Name assigned to the DIVA LAN ISDN Modem.
- **IP address:** IP address assigned to the DIVA LAN ISDN Modem.
- **MAC address:** Ethernet address assigned to the DIVA LAN ISDN Modem.
- **Firmware:** Displays the version of the current firmware loaded on the DIVA LAN ISDN Modem.

Profile table

- **Profile:** Name of the profile.
- **Status:** Status of the profile.
- **Number(s):** If a profile is active, this is the number that was dialed.
- **Duration:** Length of time the profile has been connected.

- **Dial:** Use this button to manually connect a profile.
- **Hangup:** Use this button to manually disconnect a profile.

Utilities

- **Event Viewer:** Starts the Event Viewer, which lets you view the list of messages recorded in the log file.
- **Call Viewer:** Starts the Call Viewer, which lets you view information for all incoming and outgoing calls.

The Web-based Configuration Interface

The DIVA LAN ISDN Modem uses a single ISDN link to provide communications services for all your connected devices. It manages incoming and outgoing data calls from your computers, as well as incoming and outgoing analog calls from connected telephones and/or fax machines.

To accomplish all this, the DIVA LAN ISDN Modem implements a number of important ISDN features that enable complex communications requirements to be supported on a single link. When you define your setup with the Internet wizard, a number of parameters are set to default values that give good results for most cases. However, due to the number of options that are available, the Internet wizard cannot fine tune all settings for your particular installation. For optimal performance, or to define a custom setup, you must manually adjust the configuration of the DIVA LAN ISDN Modem.

The web-based configuration interface provides you with an easy way to manage the configuration of the DIVA LAN ISDN Modem, and perform other tasks like viewing status and statistics on your connections, and updating your system firmware.

This chapter explains how to access the web-based configuration interface, and gives step-by-step instructions for some common tasks.

Starting the web-based configuration interface

The web-based interface enables you to manage the configuration and operation of the DIVA LAN ISDN Modem. It also lets you view status information and perform maintenance tasks like updating the firmware.

Note Only one user can access the web-based configuration interface at a time.

To start the web-based configuration interface

1. If you installed the Modem Monitor software
 - Right-click the DIVA LAN ISDN Modem icon in your system tray, and click Configure on the menu. Your default web browser will start.

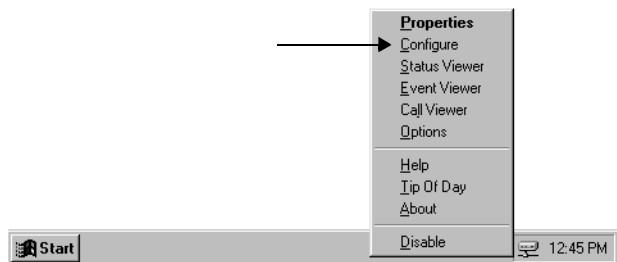

If you did not install the Modem Monitor software

- Start your web browser software, specify the URL “diva.lanmodem” or the default IP address of the DIVA LAN ISDN Modem (192.168.1.1), and press Enter. (If you changed the address or name of the DIVA LAN ISDN Modem, enter the new name or address instead.)
2. Your web browser will load the Log In page.

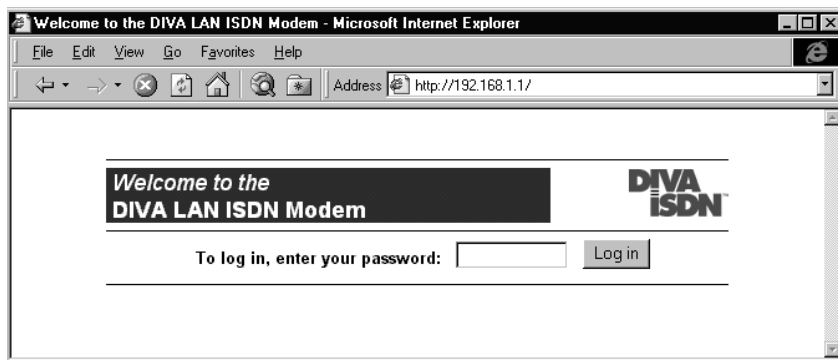

3. Enter the *system password*, if required, and click Log In.

4. The DIVA LAN ISDN Modem displays the Main configuration menu.

DIVA LAN ISDN Modem
Configuration main menu



Quick start

[Internet wizard](#) - Quickly create a connection to the Internet.

Administration These options are only fully enable once you complete the Internet wizard

Connection profiles

Configure your connection profile settings.

Manual configuration

Manual access to all configuration settings.

Statistics

See current statistics for all protocols.

View system [status](#) and [log](#)

Information on the status, past and present, of your device.

Maintenance

Update and backup your configuration or firmware.

Information

Contact us, technical support, etc...



Reset Log out



Note The first time you access the web-based configuration interface, most of the options in the Administration section are not available. They are only activated once you have defined your configuration settings using the Internet wizard.

Saving configuration settings

Most pages in the configuration interface have a Save button. When you click this button, your changes are sent to the DIVA LAN ISDN Modem. However, for the changes to take effect, you must reset the DIVA LAN ISDN Modem. Do this by clicking the Reset button on the Manual Configuration menu.

Getting help

Context-sensitive help is available for each parameter. Simply click the parameter name to display its description.

On some pages, you can get general information about the page by clicking the question mark that appears on the title bar.

General settings and connection profiles

Before you begin customizing your configuration, you should familiarize yourself with how the DIVA LAN ISDN Modem organizes its configuration settings.

Configuration settings are split into two groups: general settings and connection profile settings.

General settings

General settings apply to the DIVA LAN ISDN Modem as a whole, and cover global settings like system time, password, ISDN phone numbers, phone lines, etc.

Connection profile settings

A connection profile is a group of configuration settings that define the characteristics of an incoming or outgoing connection. Each profile has a number of settings that you can customize.

Connection profile types

The DIVA LAN ISDN Modem supports two profiles: ISP and Corporate. Both can be active at the same time, allowing you to handle different types of connections.

ISP profile

This profile is created by the Internet wizard. It defines the settings for a connection to the Internet. You can use the Manual Configuration option to customize the settings of this profile.

Corporate profile

This profile is provided so you can define the settings for a connection to a remote corporate network. See Chapter Eight, “Connecting to a Corporate Network” for more information.

Editing the ISP profile

After you have defined your connections with the Internet wizard, it may be necessary to fine tune certain parameters manually. To do this, you need to edit the ISP profile settings. Although it is possible to change the names of this profile, it is not recommended.

To edit the ISP profile

1. Start the web-based configuration interface and log in. The DIVA LAN ISDN Modem displays the Main configuration menu.

DIVA LAN ISDN Modem
Configuration main menu

Quick start

[Internet wizard](#) - Quickly create a connection to the Internet.

Administration *These options are only fully enable once you complete the Internet wizard*

<p>Connection profiles <i>Configure your connection profile settings.</i></p> <p>Statistics <i>See current statistics for all protocols.</i></p> <p>Maintenance <i>Update and backup your configuration or firmware.</i></p>	<p>Manual configuration <i>Manual access to all configuration settings.</i></p> <p>View system status and log <i>Information on the status, past and present, of your device.</i></p> <p>Information <i>Contact us, technical support, etc...</i></p>
---	--





Reset Log out



2. Click *Connection profiles*. The DIVA LAN ISDN Modem displays the Connection Profiles list page.

Connection profiles

Select a connection profile to edit.

	Profile	State		
1	ISP	Enabled	Edit	Dial
2	CORPORATE	Enabled	Edit	Dial

Configuration changes you Save when editing a profile are only activated after you click Reset.

Reset

3. Click *Edit* for the ISP profile. The DIVA LAN ISDN Modem displays the Profile page.

Connection profiles ?

Profile

[Profile](#) | [Connection](#) | [IP](#) | [RIP](#) | [Authentication](#) | [Callback](#) | [FINISH](#)

Profile name:

Enable profile?

Protocol: More...

Backup profile:

Profile restore delay: seconds

[Profile](#) | [Connection](#) | [IP](#) | [RIP](#) | [Authentication](#) | [Callback](#) | [FINISH](#)

4. Use the menu bar to navigate between the six configuration pages: Profile, Connection, IP, RIP, Authentication, and Callback. For a description of each parameter, just click the parameter name. The DIVA LAN ISDN Modem will display a help window.
5. When you are done with your settings, click *Finish*, then click *Save*.
6. To activate the settings you must reset the DIVA LAN ISDN Modem. Click the *Reset* button on the Connection Profiles list page.

Editing LAN settings

The LAN parameters page defines the settings for the LAN created by the Ethernet hub built into the DIVA LAN ISDN Modem. You need to modify these settings if:

- you need to assign a specific (static) IP address to it. This is usually the case when installing on an existing LAN. See page 112 for more information.
- you want to alter the routing information protocol (RIP) settings the DIVA LAN ISDN Modem uses on the LAN. For more information see “The Routing Information Protocol (RIP)” on page 126.

To edit the LAN profile

1. On the Manual Configuration menu, click *LAN*. The DIVA LAN ISDN Modem displays the LAN Parameters page.

LAN parameters
Edit LAN parameters

IP address:

Subnet mask:

RIP parameters

RIP version:

Route merging?

RIP policy:

2. Make your configuration changes. For a description of each parameter, just click the parameter name. The DIVA LAN ISDN Modem will display a help window.
3. Click *Save*.
4. Click *Reset*.

Saving and restoring configuration files

The web-based configuration interface makes it easy to save and restore configuration settings on the DIVA LAN ISDN Modem. This is useful for backup purposes, or if you intend to maintain several different configurations.

When you save the configuration settings, they are stored in a file on your computer.

To save/restore configuration settings

1. On the Main Configuration menu, click *Maintenance*. The DIVA LAN ISDN Modem displays the Maintenance page.



2. Click *Configuration*. The DIVA LAN ISDN Modem displays the Configuration maintenance page.

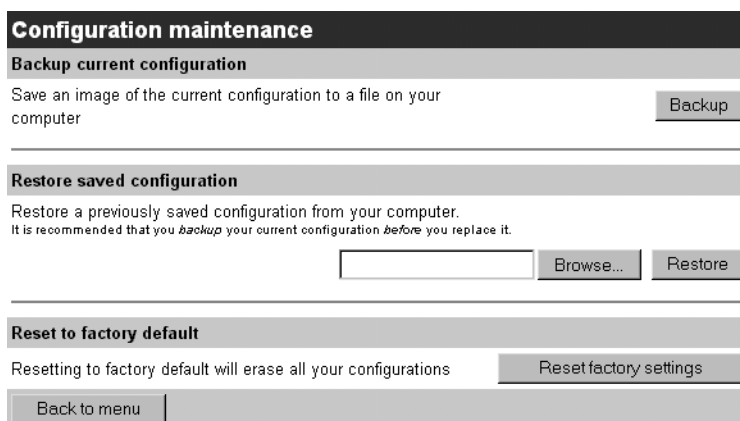

3. Click *Backup* to save your configuration settings to a file on your computer.

Viewing status information

Click Status on the Main configuration menu to view real-time status information. The DIVA LAN ISDN Modem will open a new browser window containing the System status page.

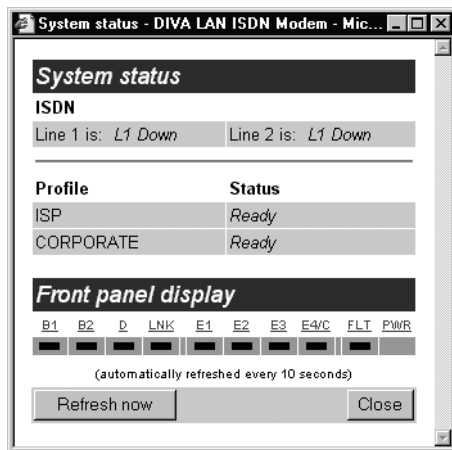

System status

Indicates the status of each of your ISDN channels (via front panel lights).

The status of each profile is also shown. It can be one of the following:

- *Connected*: The profile is in use for a data connection.
- *Ready*: The profile is ready to make a connection.
- *Pause before dialing*: Profile is about to dial out.
- *Failed*: The profile was disabled automatically because:
 - The profile failed to connect and exceeded the retry limit. See "Connection retries" on page 110.
 - The profile exceeded the defined call thresholds. See "Data call thresholds" on page 60
- *Disabled*: The profile was disabled manually.

Front panel display

Shows the status of the front panel LEDs. See "DIVA LAN ISDN Modem indicator lights" on page 157 for more information.

Obtaining statistics

The DIVA LAN ISDN Modem records a view variety of statistics, which you can use for information and troubleshooting purposes.

Click *Statistics* on the Main configuration menu, then choose the type of statistics you want to view from the menu bar. For example, the following screen shows ISDN statistics.

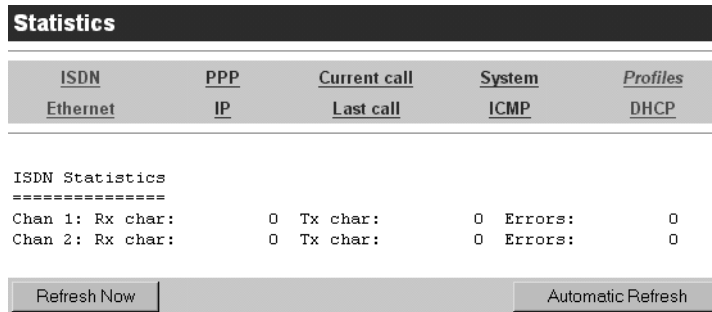

The screenshot shows a web interface for statistics. At the top is a dark header with the word "Statistics" in white. Below this is a navigation menu with five items: "ISDN", "PPP", "Current call", "System", and "Profiles". Under "ISDN", there is a sub-menu with "Ethernet", "IP", "Last call", "ICMP", and "DHCP". The main content area displays "ISDN Statistics" followed by a separator line. Below this, there are two lines of statistics: "Chan 1: Rx char: 0 Tx char: 0 Errors: 0" and "Chan 2: Rx char: 0 Tx char: 0 Errors: 0". At the bottom of the content area, there are two buttons: "Refresh Now" and "Automatic Refresh".

ISDN	PPP	Current call	System	Profiles
Ethernet	IP	Last call	ICMP	DHCP

ISDN Statistics

Chan 1: Rx char: 0 Tx char: 0 Errors: 0
Chan 2: Rx char: 0 Tx char: 0 Errors: 0

Refresh Now Automatic Refresh

Click the *Automatic Refresh* button to have the page updated every 4 seconds. Otherwise, click the *Refresh Now* button to update the statistics when you require them.

Upgrading the DIVA LAN ISDN Modem firmware

Eicon Technology posts the latest DIVA LAN ISDN Modem firmware on its web site. You can automatically update your DIVA LAN ISDN Modem to this version by using the web configuration program.

To upgrade the firmware

1. On the Main configuration menu, click *Maintenance*.
2. Click *Firmware*. The DIVA LAN ISDN Modem displays the Firmware Maintenance page.

Firmware maintenance

Download firmware

Visit the Eicon Technology web site to get the latest available firmware.
Requires an Internet connection

Backup firmware

Save an image of the currently installed firmware to a file on your computer

Upgrade firmware

Load a new firmware image onto the DIVA LAN ISDN Modem from your computer.
(All configuration settings are preserved.)
It is recommended that you *backup* your currently installed firmware *before* you upgrade it.

Be patient! After you click the Upgrade button, there will be a delay while the file is being transferred.

3. Click the *Backup* button. This retrieves a copy of the current firmware that is loaded on the DIVA LAN ISDN Modem. Save it to disk, just in case you encounter problems installing or using the new firmware.
4. To retrieve new firmware from the Eicon web site, click the *Visit* button. This points your web browser to the DIVA LAN ISDN Modem firmware upgrade page on the Eicon Technology web site.
5. Select the latest firmware release on this site and download it. Save it in the following folder on your computer:

```
Eicon\DIVA LAN ISDN Modem\ELM
```

 By default this folder is located in:

```
c:\Program Files\
```

 However, it may be located elsewhere, depending on where you installed your DIVA LAN ISDN Modem software.
6. When the download is done, return to the Firmware Maintenance page.
7. Click the *Browse* button.
8. Select the new firmware file you downloaded, or if you want to upgrade from the CD, open the following folder on the CD: `\Firmware` and select the file: **rtrna.elm**
9. Click the *Upgrade* button to upload the firmware to the DIVA LAN ISDN Modem. When done, the DIVA LAN ISDN Modem is automatically reset to activate the new firmware.

Resetting to factory defaults

Resetting the DIVA LAN ISDN Modem to factory defaults will erase all your configuration settings, including the system password. You may want to consider backing up your current configuration, as explained on page 53, before you reset to factory defaults.

To reset the DIVA LAN ISDN Modem to factory defaults

1. On the Main Configuration menu, click *Maintenance*. The DIVA LAN ISDN Modem displays the Maintenance page.



The screenshot shows a dark header bar with the word "Menu" in white. Below the header, there are two columns of text. The left column has the heading "Firmware" and the text "Backup and/or upgrade firmware". The right column has the heading "Configuration" and the text "Backup and/or restore config file".

2. Click *Configuration*. The DIVA LAN ISDN Modem displays the Configuration maintenance page.

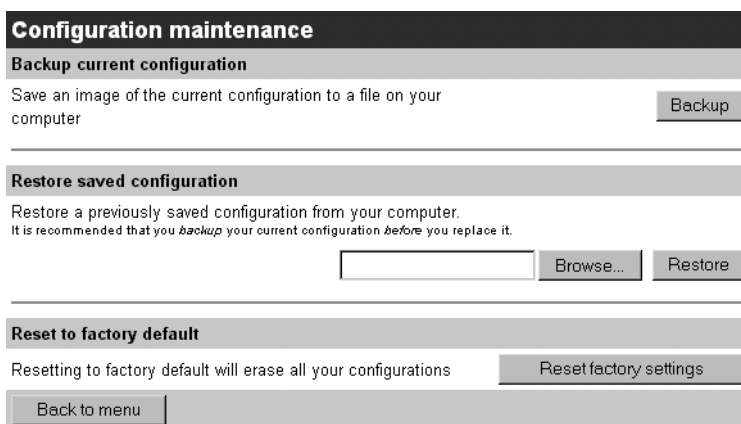

The screenshot shows a dark header bar with the text "Configuration maintenance". Below the header, there are three sections. The first section is titled "Backup current configuration" and contains the text "Save an image of the current configuration to a file on your computer" and a "Backup" button. The second section is titled "Restore saved configuration" and contains the text "Restore a previously saved configuration from your computer. It is recommended that you backup your current configuration before you replace it." and a "Browse..." button next to an empty text input field, and a "Restore" button. The third section is titled "Reset to factory default" and contains the text "Resetting to factory default will erase all your configurations" and a "Reset factory settings" button. At the bottom of the page, there is a "Back to menu" button.

3. Click *Reset factory settings*.

Note If you changed the LAN IP address of the DIVA LAN ISDN Modem from its default setting of 192.168.1.1, then you will lose contact with the web configuration interface after the reset is completed. The reset will return the DIVA LAN ISDN Modem to its default of 192.168.1.1.

Minimizing ISDN Charges

ISDN billing practices vary from flat-rate monthly services to per-call billing to per-minute usage fees. To help you reduce your ISDN charges, the DIVA LAN ISDN Modem provides you with several cost-cutting configuration options. Use this chapter to find the best options for use on your ISDN line.

The Cost Control page

For your convenience, the DIVA LAN ISDN Modem groups the most commonly used options for reducing your ISDN charges on the Cost Control page.

To define Cost Control settings

Click *Cost Control* on the Manual configuration menu. The DIVA LAN ISDN Modem displays the following page:

Idle timer

Each profile has its own idle timer. The idle timer controls how long a data call stays connected when no traffic is being sent or received. When the idle timer expires, the DIVA LAN ISDN Modem disconnects the call at the end of the next billing interval.

If you set the idle timer to 0, the call will never be disconnected due to an absence of traffic, and you will have to disconnect the call manually. This can be useful for AO/DI connections.

To set the idle timer

1. On the Cost Control page, click the name of the profile you want to adjust the idle timer for. The DIVA LAN ISDN Modem displays the Connection profile parameters page.

2. Set the *Idle timer*.
3. Click *Finish*.
4. Click *Save*.
5. Click *Reset*.

Data call thresholds

By defining data call thresholds, you are able to limit the total number of calls or total length of calls made by any one profile during a set period of time. This is especially useful as a safety measure if you have devices that may inadvertently generate a large number of calls or may stay connected indefinitely.

The threshold monitoring interval is set in days. During this interval, the DIVA LAN ISDN Modem tracks the duration and number of calls each profile makes. You can set two different limits to watch for:

- *Maximum duration of calls*: Sets the maximum number of hours a profile can be connected during the threshold monitoring interval. Range: 0 (disabled), 1 to (24 * number of days in the interval).
- *Maximum number of calls*: Set the maximum number of calls a profile can make during the threshold monitoring interval. Range: 0 (disabled) to 1000

If a profile exceeds either limit, all profiles are disabled. You must reset the DIVA LAN ISDN Modem to re-activate the profiles (or dial them manually to connect). Doing either also resets the threshold interval. (To determine if a profile has been disabled, click Connection Profiles on the Configuration main menu.)

ISDN billing intervals

A billing interval is the minimum amount of connection time your ISDN provider recognizes. For example, many ISDN providers use a one minute interval, which means you pay the same amount whether you are connected for ten seconds, or sixty seconds. Sometimes, two intervals are used, one for the first minute, and one for each subsequent minute.

It is to your advantage to stay connected for the entire length of your billing interval. This helps avoid situations where a connection is established to transmit or receive a small amount of data, taken down, then immediately brought up again moments later.

The DIVA LAN ISDN Modem has two timers that let you manage your billing intervals.

- **Initial Billing Interval**: Sets the minimum amount of time that an ISDN B-channel will be enabled.
- **Recurring Billing Interval**: Sets the minimum amount of time that an ISDN B-channel remains enabled after the Initial Billing Interval expires.

These timers should be set to match the billing intervals used by your ISDN provider. For example, if your ISDN provider charges a flat fee for the first minute, and then bills every 40 seconds thereafter, you would set the intervals as follows.

- Initial Billing Interval = 60 seconds
- Recurring Billing Interval = 40 seconds

This ensures that each time an ISDN B-channel is enabled, it stays active for at least 60 seconds. This avoids a situation where a B-channel is enabled only for 30 seconds, dropped, then enabled again a few seconds later. If a B-channel is up for more than 60 seconds, then the interval is reduced to 40 seconds.

The billing interval timers work in conjunction with the idle timer. When the idle timer expires, the B-channel is dropped at the end of the next billing interval.

Configuring BACP

The bandwidth allocation protocol (BACP) works in conjunction with the MLPPP connection protocol to regulate usage of your ISDN line. The DIVA LAN ISDN Modem uses BACP to monitor incoming and outgoing traffic, and to open or close the second ISDN B-channel as the traffic volume warrants. This reduces your communications charges by ensuring that two ISDN channels are never active when one is sufficient.

You customize how BACP opens and closes B-channels by setting the following parameters.

- **Delay for opening the 2nd B-channel:** Sets the amount of time data traffic on the first ISDN B-channel must exceed the specified Threshold value, for BACP to bring up the second B-channel.
- **Threshold for opening the 2nd B-channel:** Sets the percentage of total bandwidth on the first B-channel that must be exceeded.
- **Delay for closing the 2nd B-channel:** Sets the amount of time data traffic on the first ISDN B-channel must be below the specified Threshold value, for BACP to drop the second B-channel.
- **Threshold for closing the 2nd B-channel:** Sets the percentage of total bandwidth on the first B-channel that traffic must be below, for BACP to drop the second B-channel.

The relationship between these parameters is best illustrated with an example. Assume the parameters are set as follows:

- Delay for opening the 2nd B-channel: 5
- Threshold for opening the 2nd B-channel: 50
- Delay for closing the 2nd B-channel: 5
- Threshold for closing the 2nd B-channel: 40

When traffic on the first B-channel exceeds 32 kbps (50% of 64 kbps) for five seconds, BACP enables the second B-channel. The second B-channel remains active until traffic on the first B-channel falls below 25.6 kbps (40% of 64 kbps).

To configure BACP

Each profile that uses BACP will have its own BACP settings. To configure BACP for a profile, do the following:

1. On the Configuration main menu, click *Connection Profiles*.
2. Click *Edit* for the profile you want to configure BACP for. You will see the following page.

The screenshot shows the 'Connection profiles' configuration window. The 'Profile' tab is selected, and the profile name is 'ISP'. The 'Enable profile?' checkbox is checked. The 'Protocol' dropdown is set to 'MLPPP + BACP (2nd channel as needed)'. The 'Backup profile' dropdown is set to 'None'. The 'Profile restore delay' is set to '0' seconds. The navigation bar at the top includes 'Profile | Connection | IP | RIP | Authentication | Callback | FINISH'.

3. If you have not selected *MLPPP + BACP* as the *Protocol*, do so now.

4. Click the *More* button next to the Protocol field. You will see the following page.

Connection profiles : BACP parameters

Delay for opening the 2nd B-channel: seconds

Threshold for opening the 2nd B-channel: %

Delay for closing the 2nd B-channel: seconds

Threshold for closing the 2nd B-channel: %

5. Set the BACP parameters as required.
6. Click *Save*.
7. Click *Finish*.
8. Click *Save*.
9. Click *Reset*.

Configuring AO/DI

AO/DI lets you maintain a permanent connection to the Internet or a corporate network, without tying up an expensive ISDN B-channel. AO/DI accomplishes this by using the ISDN D-channel to establish a low-bandwidth (9.6 kbps) connection with your ISP or corporate network. When incoming or outgoing traffic exceeds the capabilities of the D-channel, AO/DI automatically invokes one or more B-channels to handle the increased traffic.

Some advantages of AO/DI include:

- Makes maintaining a permanent connection to the Internet more cost effective. With such a connection, remote users can connect with the DIVA LAN ISDN Modem from any remote location that has Internet access. This eliminates the need to dial in via ISDN. (To make the connection permanent you must set the idle timer to 0. See page 59.)
- Ideal solution for connecting to a remote corporate network, because low-bandwidth keep alive traffic can use the D-channel, instead of constantly bringing up a B-channel.

You customize how AO/DI opens and closes B-channels by setting the following parameters.

- **Delay for opening the 1st B-channel:** Sets the amount of time data traffic on the ISDN D-channel must exceed the specified Threshold value, for AO/DI to bring up the first B-channel.
- **Threshold for opening the 1st B-channel:** Sets the percentage of total bandwidth on the D-channel that must be exceeded, for AO/DI to bring up the first B-channel.
- **Delay for closing the 1st B-channel:** Sets the amount of time data traffic on the ISDN D-channel must be below the specified Threshold value, for AO/DI to drop the first B-channel.
- **Threshold for closing the 1st B-channel:** Sets the percentage of total bandwidth on the D-channel that traffic must be below, for AO/DI to drop the first B-channel.
- **Delay for opening the 2nd B-channel:** The amount of time data traffic on the first B-channel must exceed the specified Threshold value, for AO/DI to bring up the second B-channel.
- **Threshold for opening the 2nd B-channel:** Sets the percentage of total bandwidth on the first B-channel that must be exceeded, for AO/DI to bring up the second B-channel.
- **Delay for closing the 2nd B-channel:** Sets the amount of time data traffic on the first B-channel must be below the specified Threshold value, for AO/DI to drop the second B-channel.
- **Threshold for closing the 2nd B-channel:** Sets the percentage of total bandwidth on the first B-channel that traffic must be below, for AO/DI to drop the second B-channel.
- **Mode:** Determines ISDN line usage when AO/DI is enabled.
 - *D-Channel Only:* Data is only transferred on the D-channel.
 - *Normal:* Data is transferred on the D-channel, plus both B-channels if required.
- **Dial prefix:** Specifies the prefix to dial when making a call. For example, 1 to call long distance, or 9 to obtain an external line
- **X.25 transmit queue threshold:** Specifies the transmit queue threshold, in bytes, for X.25 on the D-channel. When queued data exceeds this limit, for the period of time specified for the parameter *Delay for opening the 1st B-channel*, the first B-channel is brought up. This parameter performs a similar function to *Threshold for opening the 1st B-channel*, and can be used concurrently with that parameter.

To configure AO/DI

1. On the Configuration main menu, click *Connection Profiles*.
2. Click *Edit* for the profile you want to configure AO/DI for. You will see the following page.

3. If you have not selected *MLPPP + AO/DI* as the *Protocol*, do so now.
4. Click the *More* button next to the Protocol field. You will see the following page.

5. Set the AO/DI parameters as required.
6. Click *Save*.
7. You are now ready to configure the X.25 parameters. See the next section in this chapter.

X.25 on the D-channel

During normal ISDN operation, the D-channel is used for signalling traffic purposes (call setup, call take down, caller ID, etc.) However, the full bandwidth of the D-channel is not needed for this. AO/DI takes advantage of the extra 9.6 kbps that is available to establish an X.25 packet-switched connection to a remote site.

Therefore, to take advantage of AO/DI, the remote site must support X.25 and you must properly configure the following X.25 settings on the DIVA LAN ISDN Modem.

The following parameters should be set based on the values supplied by your ISP or remote corporate network.

- **Local DTE address:** Sets the X.25 DTE address assigned to the DIVA LAN ISDN Modem. Specify up to 15 digits.
- **Maximum window size:** Defines the maximum number of X.25 packets that can be outstanding (not acknowledged by the remote). When this number is reached, transmission is paused. Maximum window size can never be exceeded. If a larger window size is requested when the call is established, it is negotiated downward so that the Maximum window size is respected.
- **Default window size:** The window size used when a X.25 call is made. This value cannot be larger than the value of *Maximum window size*.
- **Maximum packet size:** The maximum size of an X.25 packet. Maximum packet size can never be exceeded. If a larger packet size is requested when the call is established, it will be negotiated downward so that the Maximum packet size is respected.
- **Default packet size:** The packet size used when a X.25 call is made. This value cannot be larger than the value of *Maximum packet size*.
- **Number of VCs:** Specify the number of two-way virtual circuits supported on your D-channel. The DIVA LAN ISDN Modem supports up to four VCs.
- **ISDN TEI type:** Determines how TEI assignment takes place.
 - Dynamic: TEIs are dynamically assigned by the switch.
 - Shared: Enables TEI sharing. Some switches only make two TEIs available for an ISDN line. Therefore, enable this option if you need three dynamically assigned TEIs (two B and one D). This shares the TEI between channels B1 and D. Requires AO/DI.
 - Static: Lets you manually specify the TEI assignment for the D-channel.
- **Static TEI number:** If static was selected for ISDN TEI type, enter the TEI number you want to assign to the D-channel.

To configure X.25 settings

1. Click *Connection* on the menu bar. You will see the following page:

The screenshot shows the 'Connection profiles' window with the 'Connection parameters' tab selected. The configuration options are as follows:

- Telephone number 1: [Empty text box]
- Telephone number 2: [Empty text box]
- Backup telephone number 1: [Empty text box]
- Backup telephone number 2: [Empty text box]
- ISDN call type: Normal (dropdown menu)
- Remote X.25 address: [Empty text box]
- Compression?:
- Manual dialing only?:
- Idle timer: 120 seconds
- Max retries: 25
- Retry delay: 30 seconds

At the bottom of the window, there is a navigation bar with the following tabs: Profile | Connection | IP | RIP | Authentication | Callback | FINISH.

2. Set the *Remote X.25 address* parameter to the address of the remote site you want to communicate with.

3. Click *Finish*.
4. Click *Save*.
5. On the Manual configuration menu, click X.25. The DIVA LAN ISDN Modem displays this page:

X.25 parameters
Edit X.25 parameters

Local X.25 address:

Maximum window size:

Default window size:

Maximum packet size:

Default packet size:

Number of VCs:

ISDN TEI type:

Static TEI number:

6. Set the X.25 parameters as required.
7. Click *Save*.
8. Click *Reset*.

Setting ISDN active intervals

By defining ISDN active intervals, you are able to place restrictions on when data calls can be made or received.

To set ISDN active intervals

1. On the Manual configuration menu, click *ISDN active intervals*.

ISDN active intervals ?

ISDN active intervals status

Enable ISDN active intervals?

Edit ISDN active intervals - specify when calls will be allowed

Rule	Day	Time (starting & ending)
1	[- Not Used -]	00:00 - 00:00
2	[- Not Used -]	00:00 - 00:00
3	[- Not Used -]	00:00 - 00:00
4	[- Not Used -]	00:00 - 00:00
5	[- Not Used -]	00:00 - 00:00
6	[- Not Used -]	00:00 - 00:00
7	[- Not Used -]	00:00 - 00:00
8	[- Not Used -]	00:00 - 00:00
9	[- Not Used -]	00:00 - 00:00
10	[- Not Used -]	00:00 - 00:00

Cancel
Reset Form
Save

2. For each interval specify the day of the week it applies to, and the starting and ending times. Make sure you set the system clock, so the time and date on the DIVA LAN ISDN Modem are accurate. You may also want to enable the time client option for automatic updating of the system clock.
3. Click *Save*.
4. Click *Reset*.

Spoofing NetBIOS services

The NetBIOS protocol is used by Windows 95/98/NT to support Microsoft Windows Network Neighborhood, the MAP NETWORK option in Windows Explorer, and various DOS-based networking commands (such as net use, net view, and net logon). To maintain these services, NetBIOS regularly exchanges bookkeeping messages between connected systems. This can cause increased ISDN charges as the line is brought up just to transfer these messages.

The DIVA LAN ISDN Modem provides several options that let you choose the level of NetBIOS support you want to maintain.

- **All:** The DIVA LAN ISDN Modem forwards all NetBIOS traffic to the remote site. No cost savings is achieved.
- **Intelligent:** The DIVA LAN ISDN Modem spoofs (replies to without forwarding) all unnecessary traffic NetBIOS messages to reduce usage of the ISDN line. This option provides full support for all Network Neighborhood functions.
- **Minimal:** The DIVA LAN ISDN Modem reduces NetBIOS traffic to a minimum. This options does not support Network Neighborhood functions. However, it does provide support for the MAP NETWORK option in Windows Explorer and DOS-based networking commands such as net use, net view, and net logon.
- **None:** The DIVA LAN ISDN Modem discards all NetBIOS traffic. NetBIOS services are not supported across the ISDN link.

To enable spoofing of NetBIOS services

1. On the Manual configuration menu, click *IP*.
2. Click General.

IP parameters : General ?

Edit IP general parameters

DNS relay:

TFTP server:

NetBIOS IP services: None

Cancel Reset form Save

3. Select the *NetBIOS IP services* option you require.
4. Click *Save*.
5. Click *Reset*.

Data compression

Data compression increases the effective throughput of a B-channel by encoding data so that fewer bits are required to represent it. Popular compression algorithms typically reduce the size of the data by 50 percent, effectively doubling the rate at which it is transmitted.

However, not all types of data lend themselves to such high compression ratios. If you are transmitting ZIP files, JPG or GIF images, MPEG files, or other data that has already been storage-optimized, activating compression can have very little effect on throughput. This occurs because the compression algorithm can only achieve a small reduction in file size, which is offset by the processing overhead required for the sender to compress the file and the receiver to uncompress it. Therefore, you should determine if the traffic on your link is suitable for compression before you enable it.

The compression algorithm used is automatically negotiated by the DIVA LAN ISDN Modem and the remote site when the connection is established. The DIVA LAN ISDN Modem supports most popular compression standards, including: Ascend, MPPP, MS-STAC, STAC1, and STAC3.

You can enable/disable compression for each connection profile individually.

1. On the Configuration main menu, click *Connection Profiles*.
2. Click Edit for the profile you want to configure compression for.
3. Click *Connection* on the menu bar. You will see the following page.

Connection profiles [?]

Connection parameters

[Profile](#) | [Connection](#) | [IP](#) | [RIP](#) | [Authentication](#) | [Callback](#) | [FINISH](#)

Telephone number 1:

Telephone number 2:

Backup telephone number 1:

Backup telephone number 2:

ISDN call type: Normal ▾

Remote X.25 address:

Compression?

Manual dialing only?

Idle timer: seconds

Max retries:

Retry delay: seconds

[Profile](#) | [Connection](#) | [IP](#) | [RIP](#) | [Authentication](#) | [Callback](#) | [FINISH](#)

4. Check the *Compression* box.
5. Click *Finish*.
6. Click *Save*.
7. Click *Reset*.

Manual dialing

ISDN active intervals lets you control costs by specifying time ranges when the ISDN link can be used. However, there may be certain situations where direct control of the ISDN link is desirable. The manual dialing option gives you this control.

Each profile can be configured to use manual dialing only. If you enable this option and password protect the DIVA LAN ISDN Modem, you effectively put ISDN access under direct manual control of authorized users.

To enable manual dialing

1. Click *Connection Profiles* on the Configuration main menu.
2. Click *Edit* for the profile you want to configure.
3. Click *Connection* on the menu bar. You will see the following page:

The screenshot shows a web-based configuration interface for 'Connection profiles'. The main title is 'Connection profiles' with a help icon. Below it is a navigation bar with 'Connection parameters' selected. The interface contains several input fields and checkboxes:

- Telephone number 1: [text input]
- Telephone number 2: [text input]
- Backup telephone number 1: [text input]
- Backup telephone number 2: [text input]
- ISDN call type: [Normal] (dropdown menu)
- Remote X.25 address: [text input]
- Compression?:
- Manual dialing only?:
- Idle timer: [120] seconds
- Max retries: [25]
- Retry delay: [30] seconds

At the bottom, there is another navigation bar with 'Profile | Connection | IP | RIP | Authentication | Callback | FINISH'.

4. Check the *Manual dialing only* box.
5. Click *Finish*.
6. Click *Save*.
7. Click *Reset*.

Restricting analog calls

Generally, most of the activity on the ISDN line will be created by data traffic. That is why the most of the settings in this section are targeted at data calls. However, in some cases, you may want to place some restrictions on analog use of the ISDN line.

Each phone port has a *type of calls* setting which you can use for cost control purposes. It allows you to restrict traffic as follows:

- allow incoming calls only
- allow outgoing calls only
- allow all calls
- do not allow any calls

To restrict analog calls

1. On the Manual Configuration menu, click *ISDN and phone ports*. The DIVA LAN ISDN Modem displays the ISDN parameters page.
2. Select the phone port you want to restrict calls on. The DIVA LAN ISDN Modem displays the ISDN phone line parameters page. For example:

The screenshot shows a web interface titled "ISDN phone line parameters". At the top, there is a dropdown menu labeled "Define settings for:" with "Phone port 1" selected. Below this, there are several settings:

- "Type of calls supported:" with a dropdown menu set to "All".
- "Support modem/fax only?" with an unchecked checkbox.
- "Enable distinctive ring?" with an unchecked checkbox.
- "Enable call waiting?" with a checked checkbox.
- "Enable voice mail?" with an unchecked checkbox.

At the bottom of the form, there are two buttons: "Reset form" on the left and "Save" on the right.

3. Set the *Type of calls supported* parameter.
4. Click *Save*.
5. Click *Reset*.

Data over voice

In some regions, ISDN voice calls cost less than ISDN data calls. You can configure the DIVA LAN ISDN Modem to take advantage of this discrepancy to reduce your ISDN charges. When you enable data over voice support, the DIVA LAN ISDN Modem establishes all data calls as voice calls. This does not affect the throughput of your call, the only change is in how the call is billed.

Note *To use data over voice, the remote site you are calling must also support this feature.*

To enable data over voice

Data over voice can be enabled separately for each profile.

1. Click *Connection Profiles* on the Configuration main menu.
2. Click *Edit* for the profile you want to configure.
3. Click *Connection* on the menu bar. You will see the following page:

The screenshot shows a web-based configuration interface for 'Connection profiles'. The 'Connection parameters' tab is active. The interface includes the following elements:

- Navigation:** Profile | **Connection** | IP | RIP | Authentication | Callback | FINISH
- Telephone number 1:** [Text input field]
- Telephone number 2:** [Text input field]
- Backup telephone number 1:** [Text input field]
- Backup telephone number 2:** [Text input field]
- ISDN call type:** Normal (dropdown menu)
- Remote X.25 address:** [Text input field]
- Compression?:**
- Manual dialing only?:**
- Idle timer:** 120 seconds
- Max retries:** 25
- Retry delay:** 30 seconds

At the bottom of the configuration area, the navigation bar is repeated: Profile | Connection | IP | RIP | Authentication | Callback | FINISH.

4. Set *ISDN call type* to *Data over voice*.
5. Click *Finish*.
6. Click *Save*.
7. Click *Reset*.

Traffic filtering

By using the DIVA LAN ISDN Modem's IP filters, you can selectively drop outgoing traffic to reduce your communications charges. This can be useful if you have applications on your LAN that regularly send non-critical traffic across the ISDN link.

For more information on filters, see "IP filters" on page 128.

Chapter Six

Security

Connecting your computers to the internet or a remote corporate LAN creates a wide range of benefits, but also exposes your computers to certain risks. To safeguard your data and systems, the DIVA LAN ISDN Modem provides a comprehensive range of security features. This chapter explains how to use and configure each feature for optimal protection of your systems.

Security features

The following table lists all security features offered by the DIVA LAN ISDN Modem, and their default settings.

Feature	Default	Description
System password	None	Restricts access to the DIVA LAN ISDN Modem configuration interfaces.
Automatic log out	Active	Automatically terminates idle configuration sessions.
Network address translation (NAT)	Active	NAT hides the addresses of the computers on the internal Ethernet LAN from the external network.
Remote management	Disabled	Permits remote systems to log on to the DIVA LAN ISDN Modem configuration interfaces (Web or CLI).
Incoming data calls	Disabled	Permits the DIVA LAN ISDN Modem to answer incoming data calls.
Call screening	Disabled	Allows you to accept incoming data calls from specific phone numbers only.
Call authentication	Always authenticate	Lets you validate incoming data calls, or respond to authentication requests when making outgoing data calls.
Callback	Disabled	Forces the remote site to call back to establish the connection.
Manual dialing	Disabled	Enables you to manually control when the ISDN link is established.
Custom security using IP filters	None	Enables you to filter specific IP datagrams for security reasons.

The following table lists the security features that can be applied to restrict access to the DIVA LAN ISDN Modem configuration interfaces.

Source system	Connected via	Security features that apply
Remote computer	ISDN	<ul style="list-style-type: none"> • System password • Automatic log out • Remote Management • Answer incoming data calls • Call screening • Call authentication • Custom security using IP filters
Local computer	Ethernet	<ul style="list-style-type: none"> • System password • Automatic log out • Custom security using IP filter
Local computer	Serial	<ul style="list-style-type: none"> • System password
Telephone	Phone port	<ul style="list-style-type: none"> • (Only available when the ISDN is not connected.)

System password

The DIVA LAN ISDN Modem provides a system password that restricts access to the Web-based configuration interface and the CLI. This ensures that configuration changes can only be made by authorized personnel.

By default, no password is defined.

To set the system password

1. On the Manual Configuration menu, click *System*.
2. Enter the system password in the *Login Password* and *Repeat Login Password* fields.

The screenshot shows a web-based configuration interface for system parameters. At the top, there is a header 'System parameters' and a sub-header 'Edit system parameters'. Below this, there is a section for 'Current firmware revision:'. The main configuration area includes several fields: 'System name' (set to 'diva'), 'Login password' (empty), 'Repeat login password' (empty), 'Enable remote management' (checkbox), 'Set time' (set to 5:44:45), 'Set date' (set to 1999-7-9), and a 'Get time and date' button. Below these fields, there is a 'Log output' dropdown menu (set to 'Send to remote') and a 'Remote IP address' field (set to '255.255.255.255'). At the bottom, there are three buttons: 'Cancel', 'Reset form', and 'Save'.

3. Click *Save*.
4. Click *Reset*.

To erase the system password

It can happen that you might forget your system password. The only way to erase the system password is to reset the DIVA LAN ISDN Modem to its factory defaults. This also returns all configuration settings to their default values.

See “Resetting the DIVA LAN ISDN Modem” on page 160 for instructions.

Automatic log out

The DIVA LAN ISDN Modem applies an automatic time out to configuration sessions. When a configuration session is idle for more than the time out value, the DIVA LAN ISDN Modem automatically logs the user out. This reduces the risk of unauthorized persons taking advantage of a logged-in computer that has been left unattended.

Time outs are not configurable and are set as follows:

- If you are using the web interface, the time out is 30 minutes.
- If you are using Telnet, the time out is 5 minutes.
- If you are using a direct serial connection, there is no time out.

Note *Changes that have not been saved are lost when the configuration session is terminated.*

Network address translation

The DIVA LAN ISDN Modem uses network address translation (NAT) to “hide” the local LAN it creates from all external resources. The benefits of this are the ability for all connected computers to access the Internet using one Internet address and ISP account. For example, when communicating with the Internet, these four computers share the dynamically assigned address 222.182.22.39.

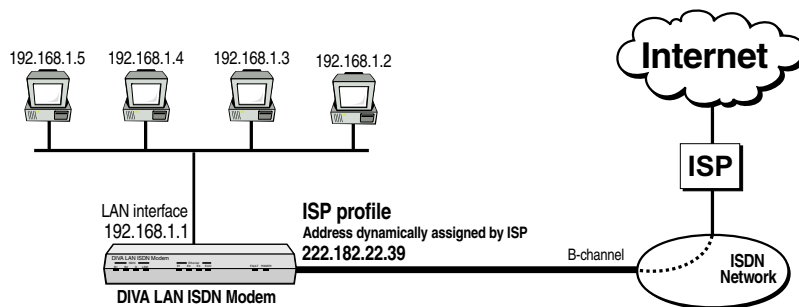

NAT operates transparently, translating internal addresses to a single external one for all data traffic. There is no effect on throughput.

Most applications will work with NAT. For a list of applications that have been tested by Eicon Technology, see the release notes on the DIVA LAN ISDN Modem CD.

NAT is enabled by default, and it is recommended that you do not turn it off unless you have a specific requirement to do so.

(For more information on IP addressing see “About IP addresses” on page 120.)

Security benefits

An additional benefit of NAT is increased network security. Like a firewall, NAT restricts access to the computers that reside on the local LAN. By default, no computer on the internal LAN is visible to the external network the DIVA LAN ISDN Modem is connected to. This applies to the Internet, as well as a corporate network. Computers on the internal network cannot act as FTP or web servers, nor can they share their drives using Windows Network Neighborhood. These security features can be weakened if you use NAT static mappings.

NAT static mappings

For those cases where you want to create an FTP or web server, or need a computer on the internal LAN to be *visible* to the external network, the DIVA LAN ISDN Modem provides a solution. You can define NAT static mappings.

How it works

NAT static mappings allow you to designate specific computers on the internal LAN to receive certain incoming network traffic. For example, you could designate a computer to receive all incoming HTTP traffic, essentially allowing it to function as a web server. However, the actual IP address of this computer is still hidden by NAT. Therefore, remote users must specify the address of the DIVA LAN ISDN Modem to gain access to the web server.

When you create a NAT static mapping, the DIVA LAN ISDN Modem routes *all* traffic for the protocol you specify to the designated computer. This includes traffic normally handled by the DIVA LAN ISDN Modem itself. This leads to the following restrictions:

- Remote access to the configuration interfaces on the DIVA LAN ISDN Modem via the ISDN link can be disrupted. For example, if you designate a computer to receive HTTP traffic, remote access to the web configuration interface will be disrupted. Local access via Ethernet will still be possible however.
- Only *one* computer on the internal LAN can be designated to receive the traffic for a *specific* protocol. This means, for example, you cannot create multiple web servers or FTP servers.

Default NAT server

When the DIVA LAN ISDN Modem receives incoming datagrams containing protocols it does not handle, it discards them. For example, if an incoming datagram contains an FTP request and no FTP server has been defined using a static mapping, the data is discarded.

In some cases, you may want to forward these datagrams to a specific computer. The DIVA LAN ISDN Modem calls this computer, the *default NAT server*.

To define a default NAT server, enter the IP address of the device that should receive these datagrams into the *Default NAT server* parameter on the IP Parameters panel (see page 80).

Note *The DIVA LAN ISDN Modem handles traffic with the following protocols: HTTP, Telnet, TFTP, ECHO (UDP port 7), and SNMP. Only traffic that does not contain these protocols will be forwarded to the default NAT server. To forward these protocols you must define a NAT static mapping for each one.*

Running a web or FTP server

Two of the most common reasons to use NAT static mappings are to run a web server or FTP server on a computer connected to the DIVA LAN ISDN Modem.

Use the following diagram as a reference as you examine the NAT mapping examples that follow:

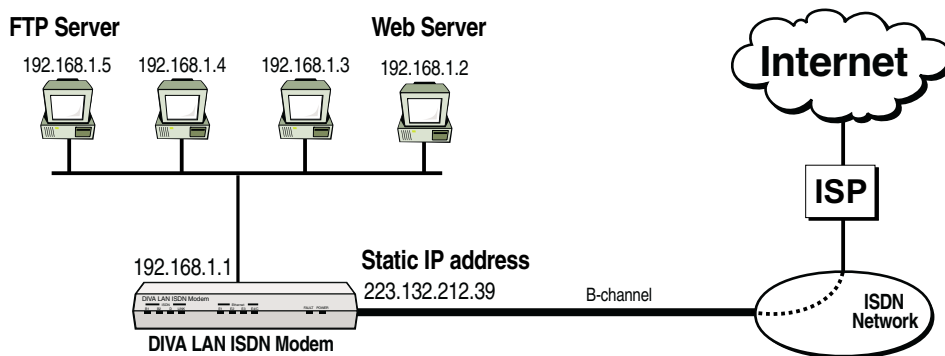

Configuring a NAT static mapping for a web server

Web traffic is carried on TCP port 80. Therefore, the following NAT mapping is required:

Map	Protocol	Server port	Server IP address
1	TCP	80	192.168.1.2

To access the web server, a remote computer uses the URL: HTTP://223.132.212.39/

The DIVA LAN ISDN Modem forwards all web traffic to the appropriate computer on the internal LAN.

Note *Setting up a web server disables remote access (via the ISDN line) to the DIVA LAN ISDN Modem web interface. Local computers can still log in.*

Configuring a NAT mapping for an FTP server

FTP traffic is carried on TCP ports 20 and 21. Therefore, the following two NAT mappings are required:

Map	Protocol	Server port	Server IP address
1	TCP	20	192.168.1.5
2	TCP	21	192.168.1.5

To create a static NAT mapping

1. On the Manual Configuration menu, click *IP*.
2. On the IP menu, click *NAT Static Mappings*.

IP parameters : NAT static mappings ?

Default NAT server

Default NAT server:

Edit NAT static mappings

Map	Protocol	Server port	Server IP address
1	None ▾	<input style="width: 20px;" type="text" value="0"/>	<input style="width: 100px;" type="text" value="0.0.0.0"/>
2	None ▾	<input style="width: 20px;" type="text" value="0"/>	<input style="width: 100px;" type="text" value="0.0.0.0"/>
3	None ▾	<input style="width: 20px;" type="text" value="0"/>	<input style="width: 100px;" type="text" value="0.0.0.0"/>
4	None ▾	<input style="width: 20px;" type="text" value="0"/>	<input style="width: 100px;" type="text" value="0.0.0.0"/>
5	None ▾	<input style="width: 20px;" type="text" value="0"/>	<input style="width: 100px;" type="text" value="0.0.0.0"/>
6	None ▾	<input style="width: 20px;" type="text" value="0"/>	<input style="width: 100px;" type="text" value="0.0.0.0"/>
7	None ▾	<input style="width: 20px;" type="text" value="0"/>	<input style="width: 100px;" type="text" value="0.0.0.0"/>
8	None ▾	<input style="width: 20px;" type="text" value="0"/>	<input style="width: 100px;" type="text" value="0.0.0.0"/>
9	None ▾	<input style="width: 20px;" type="text" value="0"/>	<input style="width: 100px;" type="text" value="0.0.0.0"/>
10	None ▾	<input style="width: 20px;" type="text" value="0"/>	<input style="width: 100px;" type="text" value="0.0.0.0"/>
11	None ▾	<input style="width: 20px;" type="text" value="0"/>	<input style="width: 100px;" type="text" value="0.0.0.0"/>
12	None ▾	<input style="width: 20px;" type="text" value="0"/>	<input style="width: 100px;" type="text" value="0.0.0.0"/>
13	None ▾	<input style="width: 20px;" type="text" value="0"/>	<input style="width: 100px;" type="text" value="0.0.0.0"/>
14	None ▾	<input style="width: 20px;" type="text" value="0"/>	<input style="width: 100px;" type="text" value="0.0.0.0"/>
15	None ▾	<input style="width: 20px;" type="text" value="0"/>	<input style="width: 100px;" type="text" value="0.0.0.0"/>
16	None ▾	<input style="width: 20px;" type="text" value="0"/>	<input style="width: 100px;" type="text" value="0.0.0.0"/>
17	None ▾	<input style="width: 20px;" type="text" value="0"/>	<input style="width: 100px;" type="text" value="0.0.0.0"/>
18	None ▾	<input style="width: 20px;" type="text" value="0"/>	<input style="width: 100px;" type="text" value="0.0.0.0"/>
19	None ▾	<input style="width: 20px;" type="text" value="0"/>	<input style="width: 100px;" type="text" value="0.0.0.0"/>
20	None ▾	<input style="width: 20px;" type="text" value="0"/>	<input style="width: 100px;" type="text" value="0.0.0.0"/>

You may enter a maximum of 20 NAT static mappings.

Cancel
Reset Form
Save

3. For each server that you want to define, specify the following parameters:
 - **Protocol:** Select the protocol that remote computers will use to access the server.
 - **Server port:** Enter the port number that the protocol will use on the server.
 - **Server address:** Enter the IP address of the computer that will act as the server. The server address must be on the same LAN as the DIVA LAN ISDN Modem (or must be reachable via the LAN).
4. Click *Save*.
5. Click *Reset*.

Remote management

By default, the DIVA LAN ISDN Modem does not allow remote devices to access its configuration interfaces via the ISDN link. This prevents unauthorized tampering when the DIVA LAN ISDN Modem has dialed out and is connected to the Internet or a remote corporate network.

To accomplish this security, all incoming HTTP and Telnet traffic on the ISDN line is automatically dropped. This effectively blocks remote computers from using the web-based interface, as well as the CLI (via Telnet).

This does not affect traffic on the local LAN created by the DIVA LAN ISDN Modem. Therefore, if the local LAN is connected to other networks, these computers will have access to the DIVA LAN ISDN Modem.

Consider the following topology:

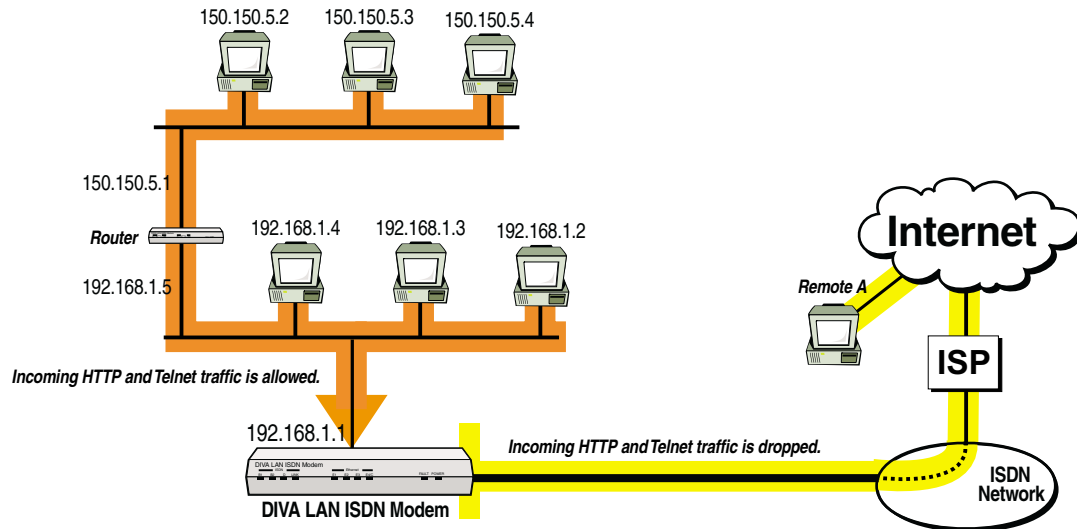

- In this example, all computers on the two LANs have access to the DIVA LAN ISDN Modem configuration interfaces.
- Remote computer A, however, is blocked.

Note Remote security is implemented using IP filtering (see page 128). Removing these filters will affect remote security.

To enable remote management

If you want to support remote configuration, you must enable the remote management option. This option can only be set with the web-based configuration interface.

1. On the Manual Configuration menu, click *System*.
2. Check the *Enable remote management* check box.

The screenshot shows a web-based configuration interface for system parameters. At the top, there is a dark header with the text "System parameters" and a sub-header "Edit system parameters". To the right of the sub-header, it says "Current firmware revision:". Below this, there are several input fields and a checkbox. The "System name" field contains "diva" and ".lanmodem". The "Login password" and "Repeat login password" fields are empty. The "Enable remote management" checkbox is unchecked. The "Set time" field shows "5 : 44 : 45 (HH:MM:SS)" and the "Set date" field shows "1999 - 7 - 9 (YYYY-MM-DD)". There is a "Get time and date" button below these fields. At the bottom, there is a "Log output" dropdown menu set to "Send to remote" and a "Remote IP address" field containing "255.255.255.255" with the note "(if log sent to remote)". At the very bottom, there are three buttons: "Cancel", "Reset form", and "Save".

3. Click *Save*.
4. Click *Reset*.

Note *It is strongly suggested that you define a log in password if you enable remote management.*

Incoming data calls

By default, the DIVA LAN ISDN Modem refuses all incoming ISDN data calls. This effectively shuts the door on unauthorized systems dialing-in. (Voice calls are not blocked by this setting.)

When support for incoming data calls is activated and an incoming call is received, the DIVA LAN ISDN Modem compares the user name and password supplied by the remote site against the remote user name and remote password configured for each connection profile. If a match is found, the call is accepted. Otherwise, the call is rejected. Therefore, to accept incoming data calls you must define call authentication settings for the appropriate profile (as explained in the steps below).

Note *Since the DIVA LAN ISDN Modem checks the ISP profile first, if both profiles have the same remote user name, the incoming call will always connect with the ISP profile.*

Incoming data calls can only be received if there is an available B-channel. To keep a free channel, you must use PPP (or V.120) for your existing connection. If you are using MLPPP, you will only be able to receive incoming voice calls if no data call is active. See “Choose a connection protocol” on page 20 for more information.

Note *When you enable callback support (page 88) using the web configuration interface, the DIVA LAN ISDN Modem automatically enables support for incoming data calls.*

Incoming calls and IP addressing

For an incoming call to successfully connect, you must define a proper IP addressing scheme for the profile that will handle the connection. This means setting the following three parameters: *IP address*, *Subnet mask*, and *Remote IP address*.

Generally, when you configure the DIVA LAN ISDN Modem to connect to the Internet, you set the *IP address* parameter to 0.0.0.0, which means that the address will be dynamically assigned by the ISP when the profile connects. When you receive an incoming call however, it may be the responsibility of the DIVA LAN ISDN Modem to assign an IP address to the caller. In this case, the static address you set for *Remote IP address* would be adopted by the caller.

The following diagram illustrates the effects of potential addressing schemes. (The subnet mask is omitted from this discussion, but should be set to match the IP address. See “About IP addresses” on page 120 for more information on masks.)

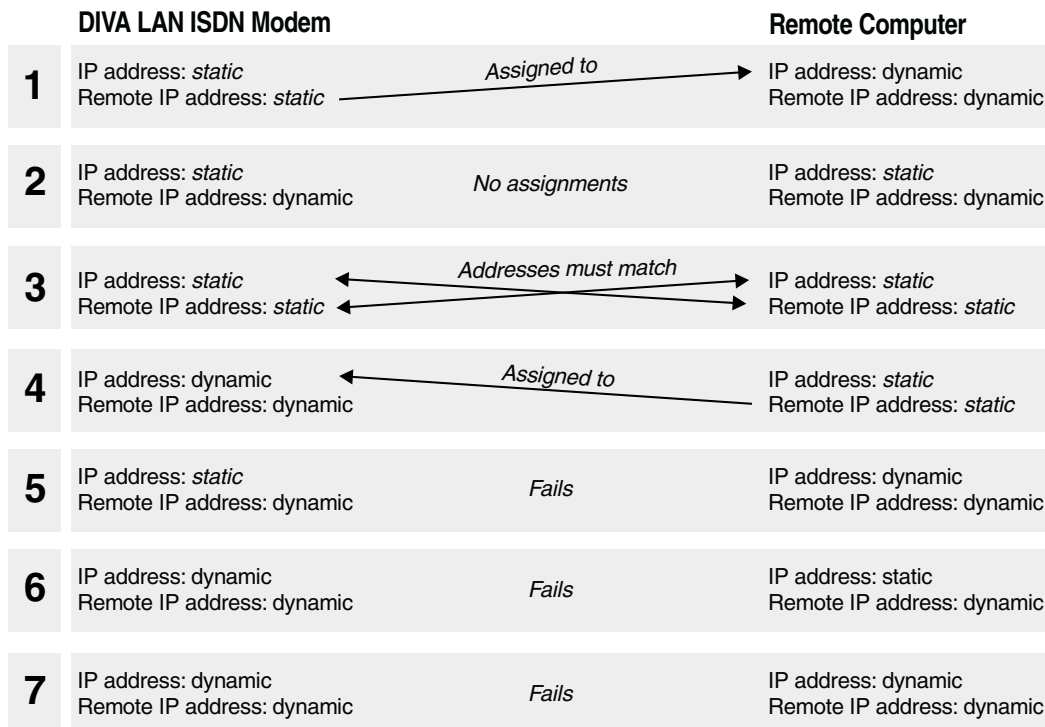

Notes on the diagram

1. The DIVA LAN ISDN Modem provides an IP address to the remote computer.
2. Both the DIVA LAN ISDN Modem and the remote computer have their own fixed IP addresses so no assignments are made.
3. Both the DIVA LAN ISDN Modem and the remote computer have their own fixed IP addresses AND have specified remote addresses. This means they will only be able to connect if the remote addresses match the IP addresses of the other device.
4. The remote computer provides an IP address to the DIVA LAN ISDN Modem.
5. The remote computer has no IP address and the DIVA LAN ISDN Modem is not configured to supply one.
6. The DIVA LAN ISDN Modem has no IP address and the remote computer is not configured to supply one.
7. Neither device has an IP address and neither is configured to supply one.

To enable support for incoming data calls

To turn on and configure support for incoming calls, do the following:

1. On the Manual Configuration menu, click *Incoming data calls*. This displays the Incoming calls parameters page.

Incoming calls parameters

Select section to edit: General settings

[Answer incoming data calls?](#)

[Always use encrypted authentication for incoming calls?](#)

Protocol: PPP (only 1 channel)

Cancel
Reset form
Save

Note: To receive incoming calls, you need to configure the remote username and password of the [connection profile](#) that will answer the call.

2. Enable *Answer incoming data calls*.
3. Specify the type of password the DIVA LAN ISDN Modem expects the remote to send: encrypted or any (unchecked). If the supplied password is not in the proper format the call is rejected.
4. Choose the type of connection protocol to use for the call. The setting you make here takes precedence over the setting for the profile that will answer the call.
5. Click *connection profile* in the Note at the bottom of the page. The DIVA LAN ISDN Modem displays the Connection profiles list page.

Connection profiles

Select a connection profile to edit.

	Profile	State		
1	ISP	Enabled	Edit	Dial
2	CORPORATE	Enabled	Edit	Dial

Configuration changes you Save when editing a profile are only activated after you click Reset.

Reset

6. Click *Edit* for the profile that will answer the call.
7. Click *Authentication*.
8. Define the *Remote username* and *Remote password* the DIVA LAN ISDN Modem expects the remote to send. See “Call authentication” on page 87 for more information.
9. Click *IP*.
10. Set *IP address*, *Subnet mask*, and *Remote IP address* as required.
11. Click *Finish*.
12. Click *Save*.
13. Click *Reset*.

Call screening

Call screening enables you to accept or reject incoming data calls based on their phone number. This is an effective way to limit dial-in access to the DIVA LAN ISDN Modem to a small group of remote sites.

To set up call screening

1. On the Manual Configuration menu, click *Incoming data calls*.
2. In the *Define settings for* box choose *Call screening*. You will see the following page.

First ISDN number	Second ISDN number
<input type="text"/>	<input type="text"/>
<input type="text"/>	<input type="text"/>
<input type="text"/>	<input type="text"/>
<input type="text"/>	<input type="text"/>
<input type="text"/>	<input type="text"/>
<input type="text"/>	<input type="text"/>
<input type="text"/>	<input type="text"/>
<input type="text"/>	<input type="text"/>
<input type="text"/>	<input type="text"/>
<input type="text"/>	<input type="text"/>

3. Check the *Enable call screening* box.
4. Enter the phone numbers of the remote sites you want to receive calls from. If you have two ISDN numbers assigned to your line, you can screen calls on each one.
5. Click *Save*.
6. Click *Reset*.

Call authentication

Call authentication enables ISDN devices, like the DIVA LAN ISDN Modem, to validate the identity of the device at the other end of the line. Authentication works through the exchange of usernames and passwords. It can be one-way (either the caller gets validated or the callee gets validated) or two-way (both sides validate each other).

Generally, authentication is one-way, with the caller getting validated. For example:

- When the DIVA LAN ISDN Modem calls an ISP or a corporate network, it will be authenticated (i.e., it must supply a username and password to log on).
- When a remote computer calls the DIVA LAN ISDN Modem, it will be authenticated (i.e., it must supply a username and password for the call to be accepted).

To successfully use call authentication it is important that both devices are configured to support the same authentication options.

To set up call authentication

1. On the Configuration main menu, click *Connection Profiles*.
2. Click *Edit* for the profile you want to configure.
3. Click *Authentication* on the menu bar. You will see the following page:

The screenshot shows a web interface for configuring connection profiles. The title is 'Connection profiles' with a help icon. Below it is a tabbed interface with 'Authentication parameters' selected. The tabs are: Profile, Connection, IP, RIP, Authentication, Callback, and FINISH. The 'Authentication parameters' section contains the following fields and options:

- Local username:
- Local password:
- Always use encrypted password?:
- Always authenticate remote?:
- Remote username:
- Remote password:
- Use SecurID?:

4. Specify the *Local username* and *Local password* this profile will send to the remote site during the authentication process. For example, the ISP profile uses these values to log on to your ISP account.

Note *Local username and Local password are case-sensitive.*

5. Specify the type of password the DIVA LAN ISDN Modem will send to the remote: encrypted or any (unchecked). If the remote is not using the same type of encryption, the call will be rejected.

Note *This setting applies to outgoing calls only.*

6. Enable *Always authenticate the remote* if you want the DIVA LAN ISDN Modem to ask the remote to identify itself with a username and password. The DIVA LAN ISDN Modem will compare the values the remote sends against the settings you make for *Remote username* and *Remote password*. Remote username and Remote password are case-sensitive.

Note *This setting applies to outgoing calls only. The DIVA LAN ISDN Modem always authenticates the remote when receiving an incoming call.*

Note

7. Click *Finish*.
8. Click *Save*.
9. Click *Reset*.

Callback

Callback is another effective method to control access to the DIVA LAN ISDN Modem. When callback is enabled, the DIVA LAN ISDN Modem functions as a callback client, and the remote site being called functions as a callback server.

The client calls the server, the connection is dropped or disconnected, then waits for the server to call back to re-establish the connection. While waiting for the server to call back, the DIVA LAN ISDN Modem may accept incoming calls that are not from the server. To ensure that only calls from the server are accepted you can use call authentication (set the *always authenticate remote* option as shown on page 87) to validate the incoming call.

The DIVA LAN ISDN Modem can only function as a callback client.

Note *When you enable callback using the web configuration interface, the DIVA LAN ISDN Modem automatically enables support for incoming data calls (page 83).*

Callback modes

Two callback modes are available. Each provides different features. For callback to work, both client and server must use the same mode.

Callback control protocol

This is a Microsoft-developed solution. It is used by NT4, and devices from Cisco, Ascend, and other vendors.

NCP enables you to specify a time delay before the server calls back, and supports both the user specified and administrator specified options.

ISDN callback

Unlike the callback control protocol, the server does not answer the initial call from the DIVA LAN ISDN Modem when using ISDN callback mode. Therefore, there is no charge for the call. This can be advantageous if you are making a lot of calls without a flat-rate package, or are making long distance calls.

ISDN modem only works with Cisco IOS. It uses caller ID information to return the call. Therefore, caller ID must be enable on your line to use this mode.

Callback options

Two callback options are available: user specified and administrator specified.

User specified

This option requires that the DIVA LAN ISDN Modem supply the server with the callback number to use. If the server is on a PBX, or must dial long distance, you may need to include appropriate dialing prefixes. Contact the system administrator of the server to determine the exact requirements.

The main advantage of this option is that if you change the DIVA LAN ISDN Modem's ISDN phone numbers, you do not have to inform the server, since you supply the phone number with each call.

Administrator specified

With this option, the DIVA LAN ISDN Modem does not supply the server with a number to dial. Instead, the remote identifies the DIVA LAN ISDN Modem by its caller ID or information supplied during call authentication. The server then consults a pre-configured table to determine the number to dial.

The main advantage of this option is centralized security. The server maintains a list of all valid clients, with their physical phone numbers and security information.

Note *It may not always be possible to support an MLPPP connection with the administrator specified option. The reason for this is that the server will only have one number configured for callback. When it tries to establish the second channel, it gets a busy signal. The solution is to use user specified, and send the server the two numbers that are required.*

Delay before host calls back

This option is only supported by the callback control protocol. It allows you to specify the amount of time the server waits before calling back. The DIVA LAN ISDN Modem proposes the delay during callback negotiation. The server can either accept or reject it.

Timeout waiting for callback

Sets the amount of time the DIVA LAN ISDN Modem waits for the server to call back. During this time, the DIVA LAN ISDN Modem may accept calls that are not from the callback server unless you use call authentication (set the *always authenticate remote* option as shown on page 87) to validate the incoming call.

To set up callback

Note When you enable callback using the web configuration interface, the DIVA LAN ISDN Modem automatically enables support for incoming data calls (page 83).

1. On the Configuration main menu, click *Connection Profiles*.
2. Click Edit for the profile you want to configure callback for.
3. Click *Callback* on the menu bar. You will see the following page.

Connection Profiles [?]

Callback parameters

Profile | Connection | IP | RIP | Authentication | Callback | FINISH

Callback type: None

Callback option: No callback

Callback numbers: Not required Not required

Delay before host calls back: 5 seconds

Timeout waiting for callback: 30 seconds

Profile | Connection | IP | RIP | Authentication | Callback | FINISH

4. Configure the callback parameters as required by your setup.
5. Click *Finish*.
6. Click *Save*.
7. Click *Reset*.

Manual dialing

The DIVA LAN ISDN Modem automatically establishes the ISDN link whenever there is outgoing data traffic. There may be certain situations where this is not desirable and you will want to have manual control of ISDN usage. The manual dialing option gives you this control.

Each profile can be configured to use manual dialing only. If you enable this option and password protect the DIVA LAN ISDN Modem, you effectively put ISDN access under direct manual control of authorized users.

To enable manual dialing

1. On the Configuration main menu, click *Connection Profiles*.
2. Click *Edit* for the profile you want to configure.
3. Click *Connection* on the menu bar. You will see the following page:

Connection profiles [?]

Connection parameters

Profile | **Connection** | IP | RIP | Authentication | Callback | FINISH

Telephone number 1:

Telephone number 2:

Backup telephone number 1:

Backup telephone number 2:

ISDN call type: Normal ▾

Remote X.25 address:

Compression?

Manual dialing only?

Idle timer: seconds

Max retries:

Retry delay: seconds

Profile | **Connection** | IP | RIP | Authentication | Callback | FINISH

4. Enable *Manual dialing only*.
5. Click *Finish*.
6. Click *Save*.
7. Click *Reset*.

Custom security features

By using IP filters you can create your own custom security solutions. For example:

- limiting local access to the DIVA LAN ISDN Modem for certain computers
- accepting incoming traffic only from certain remote users or networks
- dropping incoming or outgoing nuisance traffic

For more information see “IP filters” on page 128.

Setting up the Phone Ports

If you purchased a DIVA LAN ISDN Modem with analog ports, you are able to use ordinary telephones, answering machines, fax machines, and modems over your ISDN line. This chapter explains how to configure the DIVA LAN ISDN Modem to support these analog devices.

Also in this chapter are instructions for configuring supplementary calling services.

Setting phone numbers manually

The ISP wizard makes it easy for you to define your phone numbers and SPIDs. However, you can edit them manually using this method.

1. On the Manual Configuration menu, click *ISDN and phone ports*. The DIVA LAN ISDN Modem displays the ISDN line parameters page.

The screenshot shows the 'ISDN line parameters' configuration page. At the top, there is a header 'ISDN line parameters' and a dropdown menu 'Define settings for:' set to 'Data port'. Below this is a 'Switch type:' dropdown menu set to 'Auto-Detect'. The page is divided into sections for 'FIRST NUMBER' and 'SECOND NUMBER'. Each section has input fields for 'First ISDN number:' and 'Service profile identifier (SPID):'. Below the 'SECOND NUMBER' section is a 'Call Bumping' section with an 'Enable Call Bumping:' checkbox. At the bottom of the page are 'Reset form' and 'Save' buttons. On the left side, there is a box with the text 'Click here to have DIVA LAN ISDN Modem guess your SPIDs:' and a 'SPID guess' button.

2. Set your 1st ISDN phone number and your 2nd ISDN phone number (if you have one).
3. Set your SPIDs or click the SPID guess button to have the DIVA LAN ISDN Modem attempts to determine your SPIDs for you.
4. Click *Save*.
5. Click *Reset*.

Connecting modems and fax machines

If you are using a PHONE port to connect an analog modem or fax machine, the DIVA LAN ISDN Modem lets you configure the port for better throughput. Note that although you will still be able to make voice calls on the port, some ISDN phones may not work in this mode and supplementary services (Call Hold, Call Waiting, etc.) is disabled.

To enable support for fax/modem

1. On the Manual Configuration menu, click *ISDN and phone ports*. The DIVA LAN ISDN Modem displays the ISDN line parameters page.
2. In the *Define settings for* box, select the phone port you want to enable phone/fax support on. The DIVA LAN ISDN Modem displays the ISDN phone lines parameters page.

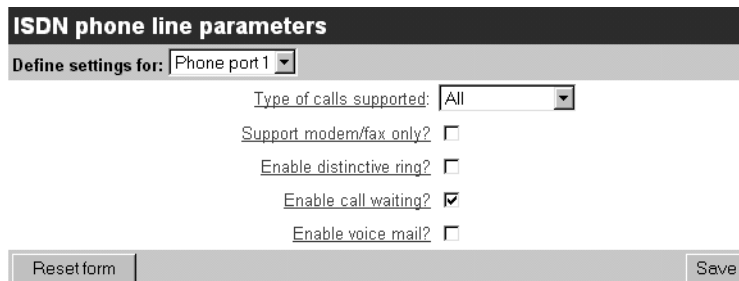

The screenshot shows a web form titled "ISDN phone line parameters". At the top, there is a dropdown menu labeled "Define settings for:" with "Phone port 1" selected. Below this, there are several settings:

- "Type of calls supported:" with a dropdown menu set to "All".
- "Support modem/fax only?" with an unchecked checkbox.
- "Enable distinctive ring?" with an unchecked checkbox.
- "Enable call waiting?" with a checked checkbox.
- "Enable voice mail?" with an unchecked checkbox.

At the bottom of the form, there are two buttons: "Reset form" on the left and "Save" on the right.

3. Enable the *Support modem/fax only* parameter. This sets the bearer capability of the outgoing call to 3.1 KHz audio, which provides better throughput when using faxes and modems. Support for supplementary services is disabled.
4. Click *Save*.
5. Click *Reset*.

Connecting multiple analog devices

You can connect more than one phone (or analog device) to each of the PHONE ports. One way to do this is to plug your existing telephone extension wiring (which has several telephone sockets chained together) into one of the DIVA LAN ISDN Modem PHONE ports.

Call bumping

Call bumping, more formally known as dynamic bandwidth allocation (DBA), allows you to share the ISDN line between data and analog calls. This enables you to send and receive faxes, or make phone calls, while at the same time downloading data from the Internet with your computers.

How it works

When you enable call bumping, incoming or outgoing analog calls can *bump* one B-channel of an active data connection to gain access to the ISDN line. This ensures that a line is almost always available for your voice or fax calls.

A sample call bumping scenario

- A data connection using MLPPP is in progress. It is currently using both ISDN channels to transfer a large database (both B-channel LEDs are green).
- Suddenly, that important phone call you were expecting arrives. As soon as the phone rings, the data connection automatically drops one of the ISDN B-channels, reducing throughput from 128 kbps to 64 kbps, and the voice call is connected. One of the B-channel LEDs will change from green to orange, indicating a voice call is active.
- When the call is done you hang up the phone. Automatically, the data connection re-establishes the second B-channel and brings throughput back up to 128 kbps.

Call bumping works in the same manner if you pick up the phone and place an outgoing call.

Requirements

To support call bumping:

- you must be using Multilink PPP (MLPPP), as your connection protocol. See the section “Choose a connection protocol” on page 20 for more information on MLPPP.
- your ISDN line must support the Call Waiting supplementary service.

To enable call bumping

1. On the Manual Configuration menu, click *ISDN and phone ports*. The DIVA LAN ISDN Modem displays the ISDN line parameters page.

2. Click the *Enable Call Bumping* check box.
3. Click *Save*.
4. Click *Reset*.

Restricting analog calls

Generally, most of the activity on the ISDN line will be created by data traffic. That is why the most of the settings in this section are targeted at data calls. However, in some cases, you may want to place some restrictions on analog use of the ISDN line.

Each phone port has a *type of calls* setting which you can use for cost control purposes. It allows you to restrict traffic as follows:

- allow incoming calls only
- allow outgoing calls only
- allow all calls
- do not allow any calls

To restrict analog calls

1. On the Manual Configuration menu, click *ISDN and phone ports*. The DIVA LAN ISDN Modem displays the ISDN line parameters page.
2. In the *Define settings for* box, choose the phone port you want to restrict calls on. The DIVA LAN ISDN Modem displays the following page.

The screenshot shows a web interface titled "ISDN phone line parameters". At the top, there is a header bar with the title. Below the header, there is a dropdown menu labeled "Define settings for:" with "Phone port 1" selected. Underneath, there are several configuration options:

- "Type of calls supported:" with a dropdown menu set to "All".
- "Support modem/fax only?" with an unchecked checkbox.
- "Enable distinctive ring?" with an unchecked checkbox.
- "Enable call waiting?" with a checked checkbox.
- "Enable voice mail?" with an unchecked checkbox.

At the bottom of the form, there are two buttons: "Reset form" on the left and "Save" on the right.

3. Set the *Type of calls supported* parameter.
4. Adjust the configuration settings. Use the following information as a guide:
5. Click *Save*.
6. Click *Reset*.

Supplementary services

The supplementary services described in this section only work if they are supported by your ISDN service provider and if they are enabled on your ISDN line. Contact your ISDN service provider for more information on the calling features that are available in your area and the provisioning of your ISDN connection.

If you attempt to use a calling feature that is not available to you, you will hear four beeps (called the service failure tone) through your telephone handset.

- Call Forwarding
- Call Waiting
- VoiceMail
- Caller ID
- Three-way Conference Calling
- Call Transfer

Note If you did not use EZ-ISDN or IOC to order your line, verify that the DIVA LAN ISDN Modem's default settings are compatible with those of your ISDN provider before using this feature. See "Feature Key values" on page 99 for more information.

Note To use Calling Features, your ISDN line must support the following: Additional Call Offering (ACO) and Flexible Calling (FC). If you ordered your ISDN line using the proper EZ-ISDN code, you should have access to these features.

Note Calling Features are accessed via codes (for example, *72). The codes you use will differ depending on your ISDN Service Provider. Contact your ISDN Service Provider for more information.

To enable supplementary services

1. On the Manual Configuration menu, click *ISDN and phone ports*. The DIVA LAN ISDN Modem displays the ISDN phone line parameters page.
2. In the *Define settings for* box, choose the phone port you want to enable calling features for. DIVA LAN ISDN Modem displays the following page:

ISDN phone line parameters

Define settings for: Phone port 1

Type of calls supported: All

Support modem/fax only?

Enable distinctive ring?

Enable call waiting?

Enable voice mail?

Reset form Save

3. Enable *distinctive ring*, *Enable call waiting*, or *Enable voice mail* as required.
4. Click *Save*.
5. Click *Reset*.

Call Forwarding

Call Forwarding automatically transfers incoming calls to wherever you are so you never miss a customer call even when you're away from your home office. Call Forwarding is accessed by dialing a simple code (e.g., 72#<forward number>). Not all ISDN Service Providers use the same dial codes. Ask your ISDN Service Provider for the codes you should use.

Note Some ISDN Service Providers use *70 to activate Call Forwarding. If you press *70, but call forwarding does not get activated, try using **70. Contact your ISDN Service Provider if problems persist.

If your ISDN service conforms to EZ-ISDN 1A or EZ-ISDN 3A, you will also have VoiceMail. If the number to which you have forwarded your calls is busy or does not answer, the call will automatically be forwarded to your VoiceMail. With VoiceMail, the DIVA LAN ISDN Modem also supports Visual Message Waiting Indicator.

Call Forwarding supports Reminder Ring. Reminder Ring causes your telephone to ring once (for about ½ a second) whenever it forwards a call. If your phone has Caller ID (see “Caller ID” on page 98), it will display details of the forwarded call.

Call Waiting

Call Waiting alerts you to an incoming call when you're already on the phone. You can put one call on hold while you accept another, so you'll never miss a customer call. It works as follows:

If you receive a second call while on a call, a beep sounds. To answer the second call, press the Flash/Link button. The first call is then put on hold and the second call is answered. You can press the Flash/Link button to toggle between the two calls.

The call waiting beep is repeated 10 seconds later if the second incoming call is not answered.

Call Waiting can be disabled by using a code before dialing a number (e.g., *70). Not all ISDN Service Providers use the same dial codes. Ask your ISDN Service Provider for the codes you should use.

If your phone is a Type II phone with Caller ID, the phone will display the number of the second incoming call (the call waiting).

If you hang up while a call is on hold, the phone will ring for 30 seconds before disconnecting the call. It is limited to 30 seconds as charges may apply for the call on hold.

VoiceMail

VoiceMail allows you to receive voice messages when you cannot answer a call (for example you are away from your desk, or if your line is busy with a voice or data call). All unanswered callers will be forwarded to your VoiceMail box, where they can leave a voice message.

VoiceMail supports Visual Message Waiting. With Visual Message Waiting, a flashing light on the phone set indicates that there is a new message in your voice mail box. This feature requires a “Class R” phone with a Message Light.

Caller ID

Caller ID lets you know who's calling before you answer, so you can decide how to handle the call.

Caller ID also works with Call Waiting, by displaying the number of the second incoming call (a Type II Caller ID phone is required), and with Call Forwarding by displaying the details of the forwarded call.

Three-way Conference Calling

Three-way Conference Calling lets you speak with up to two people at the same time so you can accomplish more with fewer phone calls. It works as follows:

While connected to the first person, press the Flash/Link button (this places the first party on hold). Dial the second person's number. After the second person answers, press the Flash/Link button. You and the two other people will all be connected. If you want to drop the last party added to the call, press the Flash/Link button.

Service Failure Tone

If get a service failure tone every time you start a conference call, and you did not use EZ-ISDN or ISDN codes when ordering your line, check the assignment of the Three-way Conference feature key (See “Feature Key values” on page 99).

Call Transfer

Call Transfer allows you to disconnect from a Three-Way Conference call and leave the other two people connected. It works as follows: Establish a Three-Way call as described in the section above. Hang up. The other two people remain connected.

Feature Key values

To access calling features, the DIVA LAN ISDN Modem supplies the ISDN switch with certain codes called Feature Keys. Not all ISDN providers use the same Feature Keys (unless you are using an EZ-ISDN or IOC line). Ask your ISDN service provider for a list of Feature Key values that your DIVA LAN ISDN Modem should use.

Note *Some ISDN providers allow you to specify which Feature Key values you want to use. If this is the case, you can supply the DIVA LAN ISDN Modem default values, and no further configuration is necessary. If your ISDN provider supports user supplied Feature Key values, supply them with the values in the following table.*

The default values for the DIVA LAN ISDN Modem are as follows:

Feature Key	Value
3-Way Conference	60
Call Drop	62
Message Waiting Indicator	63

If the Feature Key values supplied by your ISDN provider do not match, you must configure your DIVA LAN ISDN Modem to use the proper values. The Feature Key values can only be changed via the CLI. See Chapter Ten for details on how to use the CLI.

Connecting to a Corporate Network

Intranets are an effective way for organizations to share data and resources. The DIVA LAN ISDN Modem makes it easy for branch offices and telecommuters to connect to a corporate Intranet.

This chapter explains how to configure the DIVA LAN ISDN Modem to connect with a remote network only. If you need to connect to the Internet and a remote network at the same time, see “Concurrent Internet and Intranet connections” on page 119.

Overview

This option enables you to connect one or more computers to your corporate LAN for intranet web browsing, e-mail, and file transfer. Generally, this type of connection takes place via a direct, dial-up ISDN link with the corporate LAN. For example:

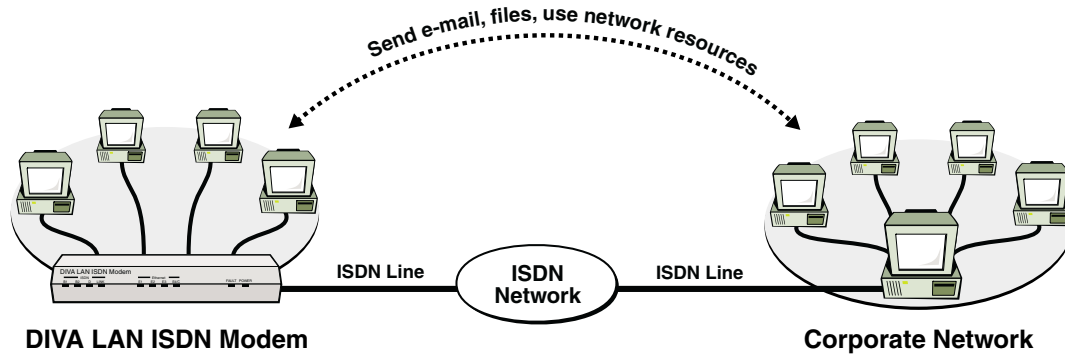

Note *The DIVA LAN ISDN Modem cannot be used on both sides when connecting to a corporate network. The corporate network must have its own gateway.*

To set up a connection to your corporate network you need to perform the following steps as detailed in this chapter:

- Step 1. Gather information
- Step 2. Configure the Corporate profile

1. Gather information

Contact your corporate network administrator and record the following information:

Item	Description
ISDN number(s) of corporate network	This is the phone number the DIVA LAN ISDN Modem will dial to access the corporate network. A backup number may also exist in case the primary number is busy or unavailable.
User name	Name the DIVA LAN ISDN Modem will use to log on to the corporate network. If your corporate network is an NT network, you may need to specify a domain name and user name pair. For example: HEADOFFICE\bob.
Password	Password the DIVA LAN ISDN Modem will use to log on to the corporate network.
Domain name of the corporate network	This is the domain name that identifies the network. For example: eicon.com
Primary DNS server address * Secondary DNS server address *	To reach other computers on the corporate network you need to use the network's DNS servers.
IP address of corporate network * Subnet mask of corporate network	This is only required if you intend to connect to the Internet at the same time as your corporate network.
Static IP address * Subnet mask	On some corporate networks, the network administrator will assign a static IP address and subnet mask to the DIVA LAN ISDN Modem. If not, the DIVA LAN ISDN Modem will negotiate its own address and subnet mask when it connects to the network.

*Addresses are written as four numbers separated by periods. Each number can range from 0 to 255. For example: 213.132.21.1

Gather X.25 information

If you intend to use AO/DI, you will require the following information:

Item	Description
Remote X.25 address	The X.25 address of the corporate network you want to connect to.
Local X.25 address	The X.25 DTE address assigned to the DIVA LAN ISDN Modem. This may not be required on certain switches.
Default window size Maximum window size	The DIVA LAN ISDN Modem supports window sizes from 1 to 7.
Default packet size Maximum packet size	The DIVA LAN ISDN Modem supports packet sizes from 64 to 1024 bytes.
Number of VCs	Number of virtual circuits. The DIVA LAN ISDN Modem supports up to 4 two-way virtual circuits.
ISDN TEI type	Determine if TEI assignment is static, dynamic, or shared. If static, get the number assigned to the D-channel.

2. Configure the Corporate profile

Use the Corporate profile to define the configurations settings for the connection to your corporate network.

To configure the Corporate profile

1. Start the Web-based configuration interface and log in as explained in Chapter Four.
2. Click *Connection profiles*. The DIVA LAN ISDN Modem displays the Connection Profiles list page.

Connection profiles				
Select a connection profile to edit.				
	Profile	State		
1	ISP	Enabled	Edit	Dial
2	CORPORATE	Enabled	Edit	Dial

Configuration changes you Save when editing a profile are only activated after you click Reset.

Reset

Note If this is the first time you are using the web-based configuration interface, the *Connection profiles* option will not be available. It is only activated once you have used the *Internet wizard*. At this point, you should run the *Internet wizard* as described in the section “Configuring the Internet connection” on page 33. Enter dummy values in all fields (the number 1 is a good choice), and save the results. Once the DIVA LAN ISDN Modem resets you will be able to access the *Connection profiles* option.

3. Click *Edit* for the CORPORATE profile. The DIVA LAN ISDN Modem displays the Profile page.

Connection profiles	
Profile	
Profile Connection IP RIP Authentication Callback FINISH	
Profile name:	CORPORATE
Enable profile?	<input checked="" type="checkbox"/>
Protocol:	PPP (only 1 channel) More...
Backup profile:	None
Profile restore delay:	0 seconds
Profile Connection IP RIP Authentication Callback FINISH	

4. Select a *Protocol* for the connection to the corporate network. See “Choose a connection protocol” on page 20 for information on how to choose a connection protocol.

5. Click *Connection* on the menu bar. The DIVA LAN ISDN Modem displays the Connection parameters page.

The screenshot shows the 'Connection profiles' window with the 'Connection parameters' tab selected. The interface includes a navigation bar with 'Profile', 'Connection', 'IP', 'RIP', 'Authentication', 'Callback', and 'FINISH'. The main area contains several input fields and checkboxes:

- Telephone number 1: []
- Telephone number 2: []
- Backup telephone number 1: []
- Backup telephone number 2: []
- ISDN call type: Normal (dropdown)
- Remote X.25 address: []
- Compression?:
- Manual dialing only?:
- Idle timer: 120 seconds
- Max retries: 25
- Retry delay: 30 seconds

The bottom navigation bar is identical to the top one.

6. Set the following parameters:

- **Telephone number 1:** Specify the ISDN phone number of the corporate network.
- **Backup telephone number 1:** Specify the backup number to dial when *Telephone number 1* is busy or not available. If the corporate network does not have a backup number, leave this field blank.
- **Remote X.25 address:** If you are using AO/DI, specify the X.25 address of the corporate network. You will also need to configure X.25 settings as described in the section “Configuring AO/DI” on page 63.

7. Click *IP* on the menu bar. The DIVA LAN ISDN Modem displays the IP options page.

The screenshot shows the 'Connection Profiles' window with the 'IP options' tab selected. The interface includes a navigation bar with 'Profile', 'Connection', 'IP', 'RIP', 'Authentication', 'Callback', and 'FINISH'. The main area contains several input fields and a dropdown menu:

- Select profile mode: NAT (Network Address Translation) (dropdown)
- Primary DNS address: 0.0.0.0
- Secondary DNS address: 0.0.0.0
- Domain name: []
- IP address: 0.0.0.0
- Subnet mask: 0.0.0.0
- Remote IP address: 0.0.0.0

The bottom navigation bar is identical to the top one.

8. Set the following parameters:

- **Select profile mode:** Leave this set to NAT unless you have a specific requirement not too. For more information on NAT, see “Network address translation” on page 78.
- **Primary/Secondary DNS address:** Specify the addresses of the primary/secondary DNS servers on the corporate network. If you leave these addresses set to 0.0.0.0, the DIVA LAN ISDN Modem will attempt to retrieve the DNS addresses for you when it connects to the corporate LAN (if supported by the corporate LAN).
- **Domain name:** Specify the DNS name of the corporate network. For example: eicon.com.
- **IP address:** On some corporate networks, the network administrator will assign a static IP address to the DIVA LAN ISDN Modem. If this is your case, enter the static IP address here. Leave this set to 0.0.0.0 if you want the DIVA LAN ISDN Modem to negotiate its own address when it connects to the network.
- **Subnet mask:** Specify the subnet mask associated with the *IP address*.
- **Remote IP address:** In some instances, you need to specify the IP address of the corporate network.

9. Click *Authentication* on the menu bar. The DIVA LAN ISDN Modem displays the Authentication parameters page.

Connection profiles ?

Authentication parameters

Profile | Connection | IP | RIP | **Authentication** | Callback | FINISH

Local username: 123

Local password: bob

Always use encrypted password?

Always authenticate remote?

Remote username:

Remote password:

Use SecurID?

Profile | Connection | IP | RIP | **Authentication** | Callback | FINISH

10. Set the following parameters:

- **Local username:** Specify the name the DIVA LAN ISDN Modem will use to log on to the corporate network. If your corporate network is an NT network, you may need to specify a domain name and user name pair. For example: HEADOFFICE\bob.
- **Local password:** Specify the password the DIVA LAN ISDN Modem will use to log on to the corporate network.
- **Always use encrypted password:** If your corporate network requires encrypted passwords (CHAP or MS-CHAP), enable this option.

11. Click *Finish*.

12. Click *Save*.

13. Click *Manual Config* on the menu bar.

14. Click *IP*.

15. Click *Routes*. The DIVA LAN ISDN Modem displays the Routes page. Edit the fields (if required) so that they are set as follows:

IP parameters : Routes ?

Edit IP routing parameters

Rte	Network address	Mask length	Gateway address	Interface	Metric
1	0.0.0.0	0 bits	0.0.0.0	CORPORATE	1
2		bits		None	
3		bits		None	
4		bits		None	
5		bits		None	
6		bits		None	
7		bits		None	
8		bits		None	
9		bits		None	
10		bits		None	

You may enter a maximum of 50 routes.
If all the above entries are full, click Save and more entries will appear.

16. Click *Save*.

17. Click *Reset*.

Your corporate connection is now ready to use. You should be able to send and receive e-mail, share files, or browse any intranet web pages.

Using the corporate connection

The DIVA LAN ISDN Modem automatically dials out and establishes the ISDN link to your corporate network as required. You simply launch the applications you use to do your work, such as a web browser or e-mail program, and you are automatically connected.

You can also establish your connections manually, dialing and hanging up connections as you see fit. See page 45 for details.

How long will the line stay connected?

By default, the DIVA LAN ISDN Modem will stay connected until the line has been idle for two minutes. To adjust this setting, see “The Cost Control page” on page 59.

Support for Microsoft Network Neighborhood

If you are connecting to an Microsoft NT network, see “Spoofing NetBIOS services” on page 68 for information on supporting Network Neighborhood functions.

NetBIOS name resolution

If you use Microsoft networking, then you will need to be able to resolve NetBIOS names to IP addresses. If you allow the Microsoft WINS client to use DNS as a method of resolving names (Windows NT), then it could result in persistent ISDN calls being generated. In general, it is recommended that you make entries in the LMHOSTS file of each computer connected to the DIVA LAN ISDN Modem to resolve NetBIOS names. Consult the Microsoft documentation for your operating system for more information on how to do this.

Timeouts

To save communications charges, the DIVA LAN ISDN Modem will drop the ISDN line when it is idle. Although this may not cause problems for most applications, it can cause difficulties for the corporate server you are connected to. If the server implements TCP *keep alives*, then the server will hang up your TCP/IP session if the ISDN line is down when the *keep alives* are sent. Thus, when the DIVA LAN ISDN Modem reconnects (i.e., the client sends more data), the session will have been aborted.

Dynamic IP addressing

If the corporate network uses dynamic IP address assignment, it is possible that each time the DIVA LAN ISDN Modem connects it will be given a different IP address. This can cause problems for some session-based applications when the DIVA LAN ISDN Modem drops the ISDN link due to inactivity. When the link is re-established, the server has given the DIVA LAN ISDN Modem a new IP address. When the application attempts to continue using the previous session, it is refused because of the address change.

Although applications may not themselves timeout when the DIVA LAN ISDN Modem drops the line due to inactivity, the IP stack on the corporate server you are connected to may.

What's next?

Other chapters in this manual provide in depth information and instruction on a variety of topics relating to operating and configuring the DIVA LAN ISDN Modem.

Some of the topics that you may want to consult are:

Minimizing your ISDN charges

The DIVA LAN ISDN Modem has several pre-defined settings to help reduce your ISDN charges. To adjust these settings for your installation, see Chapter Five.

Using telephones, fax machines, and modems

If your DIVA LAN ISDN Modem has PHONE ports, you can share the ISDN line with your analog devices. Consult Chapter Seven for complete details on setting up your analog devices.

Configuring security features

The DIVA LAN ISDN Modem provides a wide range of security features. Some of the features you may want to configure include:

- *System password:* A system password is also available to restrict access to the configuration interface.
- *Support for remote management:* By default, remote access to the configuration is disabled.
- *Support for incoming data calls:* By default, support for incoming data calls is disabled.
- *Call screening:* Lets you accept incoming data calls only from specific numbers.
- *Call authentication:* Lets you verify incoming callers by username and password.

Consult Chapter Six for complete details.

Advanced Installations

This chapter describes advanced installation scenarios and provides background information on advanced configuration issues like IP filtering and IP routing.

Connection retries

The connection retry parameter controls how many times the DIVA LAN ISDN Modem attempts to establish a connection using a specific profile. If the profile cannot be connected using either its primary telephone number or backup telephone number, it is disabled, and the DIVA LAN ISDN Modem attempts to connect using a backup profile instead.

Once a profile has been disabled, it must be re-enabled before it can be used again. There are three ways to re-enable a profile"

- manually dial it
- reset the DIVA LAN ISDN Modem
- set the profile to be re-enabled automatically by defining a value for the *Profile restore delay* parameter

To define retry settings

1. On the Configuration main menu, click *Connection Profiles*.
2. Click *Edit* for the profile you want to adjust the retry settings for.
3. Click *Connection* on the menu bar. You will see the following page.

Connection profiles [?]

Connection parameters

[Profile](#) | [Connection](#) | [IP](#) | [RIP](#) | [Authentication](#) | [Callback](#) | [FINISH](#)

Telephone number 1:

Telephone number 2:

Backup telephone number 1:

Backup telephone number 2:

ISDN call type:

Remote X.25 address:

Compression?

Manual dialing only?

Idle timer: seconds

Max retries:

Retry delay: seconds

[Profile](#) | [Connection](#) | [IP](#) | [RIP](#) | [Authentication](#) | [Callback](#) | [FINISH](#)

4. Set *Max retries* to the number of times you want to dial when trying to connect. Dialing attempts alternate between Telephone number 1/2 and Backup Telephone number 1/2.
5. Set *Retry delay* to the number of seconds the DIVA LAN ISDN Modem should pause between dialing attempts.
6. Click *Finish*.
7. Click *Save*.
8. Click *Reset*.

To define a backup profile and set the profile restore delay

1. On the Configuration main menu, click *Connection Profiles*.
2. Click *Edit* for the profile you want to define a backup profile for. You will see the following page.

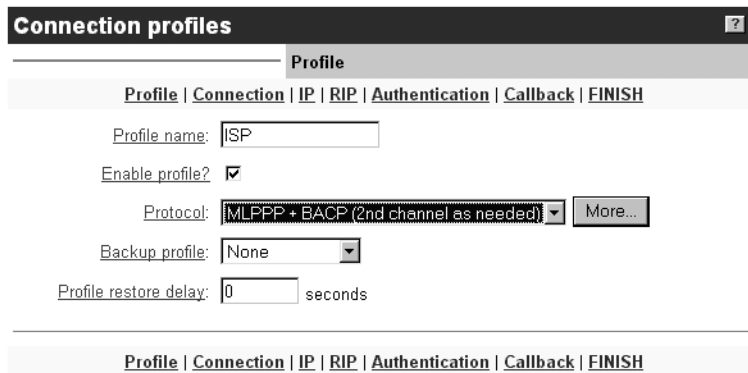

The screenshot shows the 'Connection profiles' configuration interface. At the top, there is a dark header with the title 'Connection profiles' and a help icon. Below the header is a breadcrumb trail: 'Profile | Connection | IP | RIP | Authentication | Callback | FINISH'. The main configuration area includes the following fields and controls:

- Profile name:** A text input field containing 'ISP'.
- Enable profile?:** A checkbox that is checked.
- Protocol:** A dropdown menu showing 'MLPPP + BACP (2nd channel as needed)' and a 'More...' button.
- Backup profile:** A dropdown menu showing 'None'.
- Profile restore delay:** A text input field containing '0' followed by the unit 'seconds'.

At the bottom of the configuration area, there is another breadcrumb trail: 'Profile | Connection | IP | RIP | Authentication | Callback | FINISH'.

3. Choose a *Backup profile* from the list.
4. Set a value for *Profile restore delay*. (This value must be greater than 0, if you want to use a backup profile.)
5. Click *Finish*.
6. Click *Save*.
7. Click *Reset*.

Installing on an existing LAN

Installing the DIVA LAN ISDN Modem on an existing LAN can be extremely simple, or quite challenging, depending on the complexity of your existing LAN setup. To help you successfully integrate the DIVA LAN ISDN Modem into your setup, this section presents an installation strategy that should work in the majority of cases. However, due to the wide range of networking equipment and topologies that are in use worldwide, your configuration needs may fall outside the strategy presented here. In this case, you should contact your network administrator, or other support person to help you with your installation.

Using Modem Monitor

Modem Monitor greatly simplifies the task of installing the DIVA LAN ISDN Modem on a LAN. If at least one of the computers on your LAN is running Windows 95/98/NT, follow the instructions in Chapter Two to install and configure the DIVA LAN ISDN Modem. However, make the following exceptions:

- Instead of connecting the DIVA LAN ISDN Modem directly to your computers, connect it to the LAN. Do this by connecting any one of the DIVA LAN ISDN Modem's ETHERNET ports to a port on your LAN hub.
If your hub has a cross-over switch or cascade port, you can use the supplied blue Ethernet cable to make this connection. If not, you will need a special cross-over Ethernet cable to make this connection.
Try connecting the supplied blue cable to the hub, if the green Ethernet light on the DIVA LAN ISDN Modem does not light up, you need a special cross-over cable.
- Install the Modem Monitor software on a Windows 95/98/NT computer that is connected to the LAN. Modem Monitor will automatically detect the DIVA LAN ISDN Modem and let you adjust its IP settings for proper operation on the LAN.

Once installation is complete, you may need to adjust the configuration settings of the computers on your LAN. See "Adjusting configuration settings on the LAN" on page 114 for complete details.

Manual installation

Follow these steps to install the DIVA LAN ISDN Modem on a LAN if you are unable to run Modem Monitor on a computer on your network.

1. Determine how IP addresses are assigned on the LAN.
 - **Static:** Each computer on your LAN has a fixed address. If this is the case, then determine the IP address and subnet mask that will be assigned to the DIVA LAN ISDN Modem.
 - **Dynamic:** Addresses are assigned by a DHCP server (such as a Windows NT server).

It is recommended that before you install the DIVA LAN ISDN Modem on your LAN, you should install and configure it for use with a single non-networked computer. This lets you verify that your ISDN line is functioning and that you are able to successfully communicate with the DIVA LAN ISDN Modem.

2. Disconnect a computer from your LAN.
3. Follow the instructions in Chapter Two to install and configure the DIVA LAN ISDN Modem. Pay particular attention to section "Verify the configuration of your computers" on page 18. If you need to change the settings of your computer, make sure you record the existing settings before you change them.
4. Once installation and configuration are complete, confirm that your ISDN line works and that you have access to the Internet.
5. Start the Web-based configuration interface.

- Click *LAN* on the Manual Configuration menu. The DIVA LAN ISDN Modem displays the LAN parameters page.

- Set the *IP address* to a free address on your LAN. If your LAN uses dynamic addressing (DHCP server) make sure that the address you choose is outside the range of dynamically assigned ones, or that you reserve the address. For background information on IP addresses, see “About IP addresses” on page 120.
- Set the *Subnet mask* according to the requirements of your LAN.
- Click *Save*. **Do not** reset the DIVA LAN ISDN Modem.

By default, the DIVA LAN ISDN Modem is configured to act as a DHCP server. If a computer on the LAN is already providing this function (such as a Windows NT server), you need to disable this feature on the DIVA LAN ISDN Modem.

- Click *IP* on the Manual Configuration menu.
- Click *DHCP*. The DIVA LAN ISDN Modem displays the LAN Parameters page.

- Uncheck the *DHCP server enabled* option.
- Click *Save*.
- Click *Reset*.
- Disconnect your computer from the DIVA LAN ISDN Modem.

16. Connect the DIVA LAN ISDN Modem to the LAN. Do this by connecting any one of the DIVA LAN ISDN Modem's ETHERNET ports to a port on your LAN hub.

If your hub has a cross-over switch or *cascade* port, you can use the supplied blue Ethernet cable to make this connection. If not, you will need a special cross-over Ethernet cable to make this connection.

Try connecting the supplied blue cable to the hub, if the green Ethernet light on the DIVA LAN ISDN Modem does not light up, you need a special cross-over cable.
17. Press the Reset button on the back of the DIVA LAN ISDN Modem.
18. Restore your computer's network configuration settings and reconnect it to the LAN.
19. Start your Web browser and enter the new IP address you assigned to the DIVA LAN ISDN Modem. Your browser should display the Log In page.
20. You may need to adjust the configuration settings of the computers on your LAN. See "Adjusting configuration settings on the LAN" on page 114 for complete details.

Adjusting configuration settings on the LAN

Depending on your setup, you may have to adjust configuration settings on your computers in order to communicate with the DIVA LAN ISDN Modem. Due to the diversity of networking equipment and topologies, this section can only cover several of the most common setups. If your setup is more complex, contact your network administrator, or other support person to help you with your installation.

If your LAN uses static addressing

Configure TCP/IP on each computer that will communicate with the DIVA LAN ISDN Modem as follows:

- Set *Default Gateway* to the address of the DIVA LAN ISDN Modem.
- Set *DNS Server* to the address of the DIVA LAN ISDN Modem.

If your LAN has a DHCP server

Configure your DHCP server to return the address of the DIVA LAN ISDN Modem as the *Default Gateway* and *DNS Server* to all clients.

If your LAN has a router

If you have a router on your LAN, it is likely configured as the default gateway for your computers. In this case, you will need to configure the routing table on your router to re-direct the appropriate traffic to the DIVA LAN ISDN Modem. And add a route on the DIVA LAN ISDN Modem to direct appropriate traffic to the router.

Consider the following example:

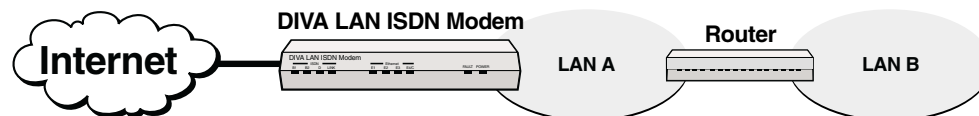

- Traffic from LAN A addressed to LAN B is forwarded by the router to LAN B.
- Traffic from LAN A addressed to the Internet needs to be forwarded by the router to the DIVA LAN ISDN Modem. This requires you to configure a route on the router.
- Traffic from the Internet to LAN B needs to be forwarded to the router. This requires you to configure a route on the DIVA LAN ISDN Modem. No route is needed for traffic to LAN A.

Connecting more than four computers

In certain cases, you may want to share the DIVA LAN ISDN Modem with more than four computers. To do this, you can connect the DIVA LAN ISDN Modem to an Ethernet hub. This connection requires either a special Ethernet cable, called a cross-over, or you can use the supplied blue cable if the hub has a cross-over switch. Try connecting the supplied blue cable to the hub, if the green Ethernet light on the DIVA LAN ISDN Modem does not light up, you need a special cross-over cable.

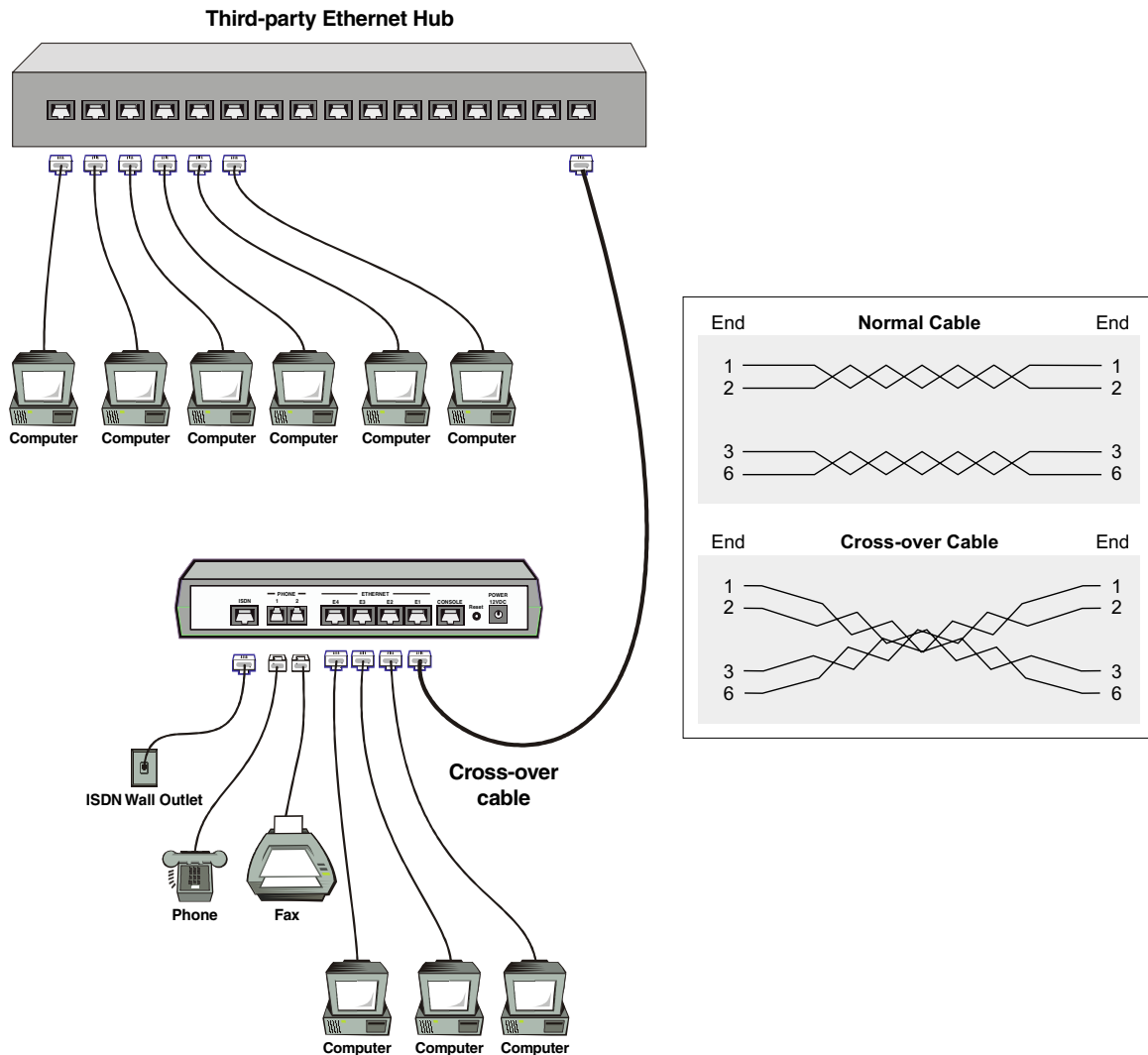

Note If the hub is part of a local area network, you will need to adjust configuration settings on the DIVA LAN ISDN Modem. See "Installing on an existing LAN" on page 112 for details.

Creating a virtual private network

A virtual private network (VPN) is an interconnection between two networks that uses the PPTP (point-to-point tunneling protocol). By using the Internet to transport data, a VPN can eliminate long distance charges associated with traditional dial-up solutions. And, since PPTP provides a secure connection, network security is not compromised.

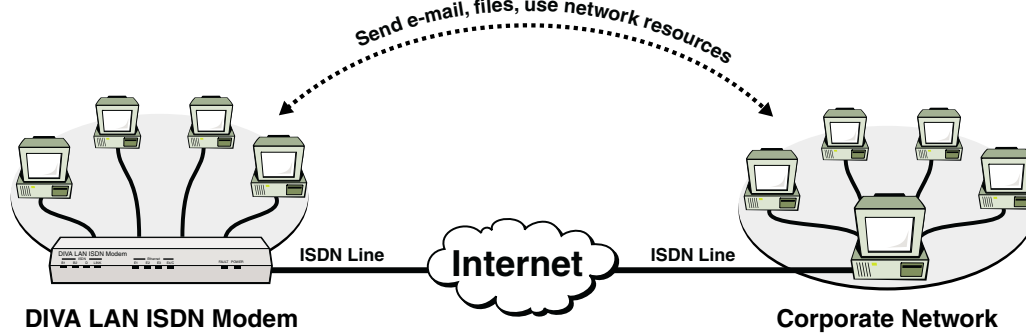

To create a VPN

1. Create a connection to the Internet as described in Chapter Two.
2. Contact the administrator of the network you want to attach to and obtain the following:
 - the IP address or host name of the VPN server
 - For each user that will be connected to the VPN:
 - user name
 - password
3. Go to the Microsoft web site and download Dial-Up Networking 1.3.
4. Install Dial-Up Networking 1.3 on each computer that will be connected to the VPN.
5. When Dial Up Networking is installed, create a new connection. Double-click *My Computer*, and then double-click *Dial-Up Networking*. You will see the following dialog box.



6. Enter a name for your connection.
7. Select *Microsoft VPN Adapter* as the device.

8. Click *Next*. You will see the following dialog box.



9. Enter the IP address or host name of the VPN server.
10. Click *Next*. You will see the following dialog box.

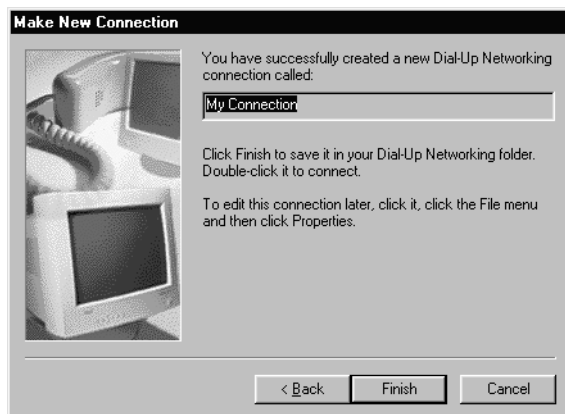

11. Click *Finish* to create the new connection.

Connecting to the VPN

1. To connect to the VPN, you simply launch the connection you just created with Dial-Up Networking. You will see the following dialog box.

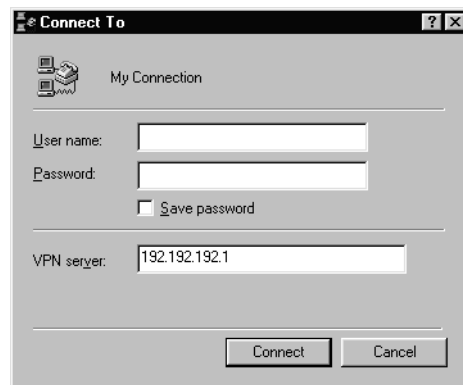

2. Enter your *user name* and *password* and click *Connect*.

3. The DIVA LAN ISDN Modem will automatically establish the link to the Internet and you will see the following Dial-Up Networking dialog box, showing the details of your connection.

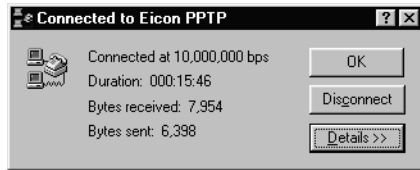

Note *The bps value reported by this dialog box is your LAN Ethernet speed. Your actual connection speed will be either 64 bps or 128 kbps depending on how many B-channels you are using.*

Note *The idle timer on the DIVA LAN ISDN Modem cannot be used to manage VPN connections. Therefore, if your VPN connection remains idle for long periods of time, the link will not be disconnected unless you manually disconnect.*

Concurrent Internet and Intranet connections

The DIVA LAN ISDN Modem can support both an Internet connection and an intranet connection to your corporate network. This section explains how to install and configure such a setup.

Selecting a connections protocol

One of the primary considerations is choice of connection protocol. If you want to have both connections active at the same time, you must assign PPP to each connection. The reason for this is that any MLPPP-related protocol reserves both ISDN channels for its exclusive use, even if they are not active. Therefore, the only way to share the two ISDN channels between two data connections is to use PPP for each.

Defining routes

If you have two active connections, it is important to define routes so that the DIVA LAN ISDN Modem can send data to the proper connection. In most cases, you will want to send certain specific traffic to your corporate network, and route all other traffic to the Internet.

For a complete discussion of routing issues, see “IP routes” on page 120.

Installation and configuration procedure

1. Use the Internet wizard, as described in Chapter 2, to define your Internet connection.
2. The Internet wizard will automatically add a default route to the routing table. The default route is defined as 0.0.0.0 with a mask of 0. This is a catch-all route. Any traffic which does not match any other route, will match the default route, and thus be sent to the Internet.
3. Next, create a connection to your corporate network as described in Chapter Eight.
 - Choose PPP as the connection protocol.
 - When you reach the routing table, you should configure it as outlined in the section “Multiple connections” on page 124.
4. You should now be able to use both connections.

IP routes

This section provides background information on why IP routes are needed and explains how to define them. However, before you can understand routing, you must be familiar with IP addressing and how the DIVA LAN ISDN Modem assigns them.

About IP addresses

IP addresses identify the computers (and other devices) on an IP network. Each address is composed of 32 bits. To make things easier to understand, addresses are written out as four decimal numbers separated by dots. The numbers can range in value from 0 to 255. For example: 192.168.1.1 or 222.182.22.39

Using masks

IP addresses are composed of two parts: the network address and the host address. A host is any computer (or other device) on a network that is capable of transmitting or receiving data. To determine which portion of the address identifies the network and which portion identifies a host, a mask is used.

Masks are specified in bits. A logical bitwise AND operation is performed between the address and the mask to extract the network address. To simplify, consider that each of the four decimal numbers that make up an address is represented by 8 bits. This leads to the following network addresses and their corresponding masks:

Mask (# of bits)	Mask (in decimal)	Source IP address	Extracted network address
8	255.0.0.0	222.182.22.39	222.0.0.0
16	255.255.0.0	222.182.22.39	222.182.0.0
24	255.255.255.0	222.182.22.39	222.182.22.0
32	255.255.255.255	222.182.22.39	222.182.22.39

This table also illustrates how the mask is used to extract the network address for a given source address. Note that when the mask is 32 bits, the extracted address is identical to the source address, and refers to a single host computer rather than a network.

Static vs. dynamic addresses

IP addresses can be either dynamic or static. Static addresses are fixed, and must be changed manually. They are used by computers that are permanently connected to the Internet (a web server, for example), and sometimes by computers on a LAN.

Dynamic addresses can change. They are assigned using a special protocol such as DHCP or PPP (IPCP). For example, when connecting to the Internet, the IP address assigned to the DIVA LAN ISDN Modem by your ISP is usually dynamic, assigned by PPP (IPCP). It changes each time the DIVA LAN ISDN Modem connects.

The DIVA LAN ISDN Modem and IP addresses

The DIVA LAN ISDN Modem can have up to three IP addresses assigned to it. One address is used on the internal LAN it creates. The other two are used to communicate externally with remote sites.

Internal LAN addresses

By default, the DIVA LAN ISDN Modem is configured to act as a DHCP server. This means it is responsible for assigning IP addresses to each computer connected to it. To receive an address, each computer must be configured to obtain their IP addresses automatically from a DHCP server (see Chapter Nine).

The following diagram shows four computers with addresses assigned by the DIVA LAN ISDN Modem.

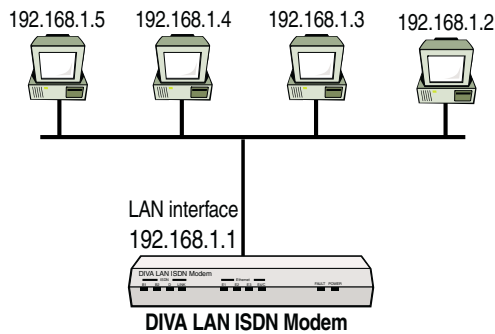

By default, the DIVA LAN ISDN Modem uses the mask 255.255.255.0 when assigning addresses. This means that the network portion of the address is: 192.168.1.0

Note that the DIVA LAN ISDN Modem has its own address on the LAN: 192.168.1.1

External addresses

When the DIVA LAN ISDN Modem establishes a connection to a remote site, it needs to be identified with an IP address. This address is associated with the profile making the connection. Since, two profiles are supported, two IP addresses are required.

Generally, these external addresses are dynamic, and are automatically negotiated when the DIVA LAN ISDN Modem connects with the remote site. For example, when establishing a link with an ISP, the ISP will generally assign an IP address to the DIVA LAN ISDN Modem. This address will change each time the DIVA LAN ISDN Modem reconnects.

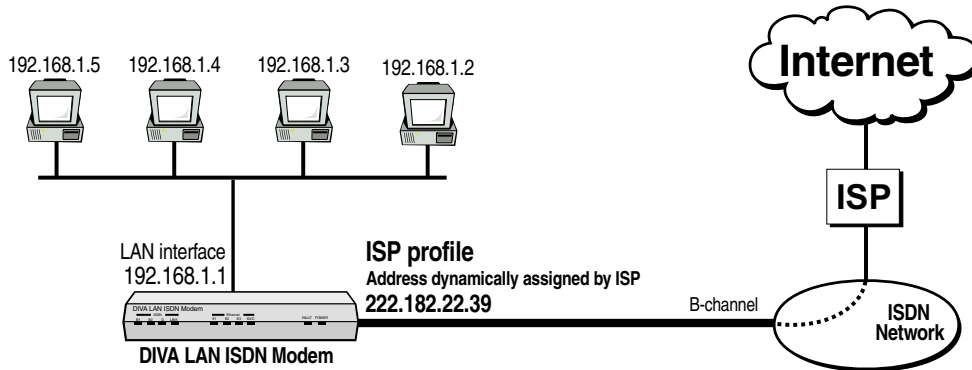

In this example, the address 222.182.22.39 is assigned to the DIVA LAN ISDN Modem. The address is associated with the ISP profile, since this is the profile that was used to establish the connection.

In some cases, you may be required to assign a static IP address to a profile. This may occur when connecting to a corporate network. For example:

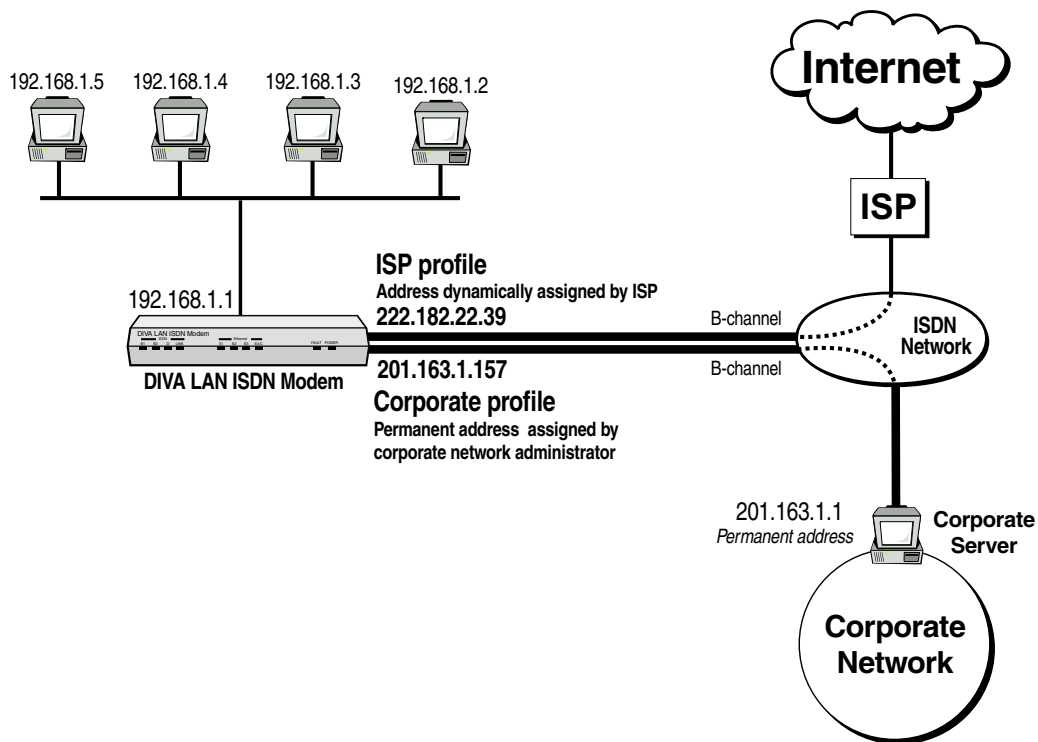

This example shows three addresses assigned to the DIVA LAN ISDN Modem: one on the LAN, one for an Internet connection, and one for a connection to a corporate network.

Why routes are needed

Data on an IP network is carried in small packages called datagrams. Each datagram contains the IP address of its source and destination. In order to send datagrams to their proper destination, the DIVA LAN ISDN Modem requires a list of destinations and the addresses that are associated with it. This information is stored in a route. Since more than one route is generally required, they are grouped together in a routing table. Each time the DIVA LAN ISDN Modem sends or received a datagram, it consults the routing table to determine the target destination for the datagram.

Single connection

Consider the following scenario:

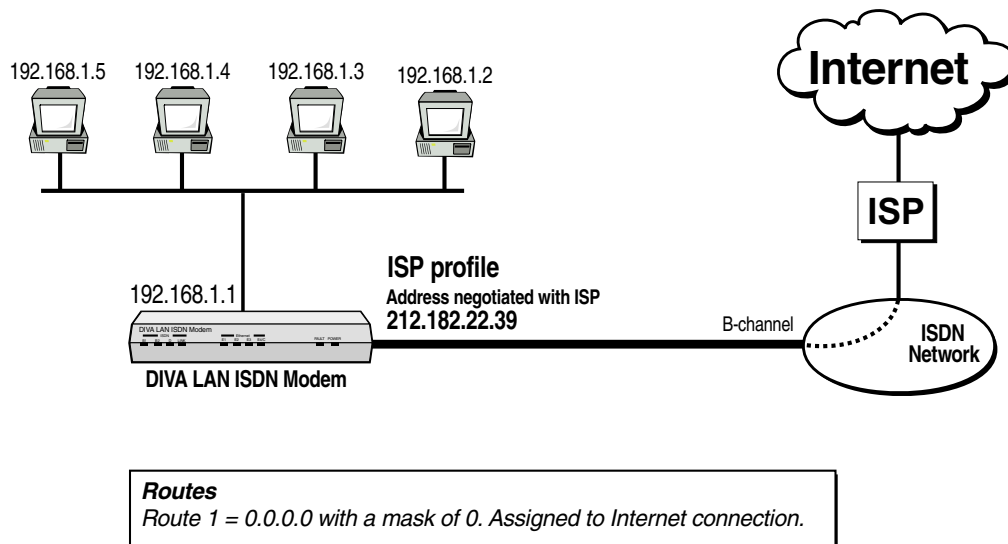

Since there is only one destination for outgoing data (the Internet), only one route is required. This route needs to match all addresses. The special address 0.0.0.0 does this. The same would be true for a Corporate connection. If you want to route all data to the corporate network, specify a single route using the special address 0.0.0.0.

There can be only one default route on the DIVA LAN ISDN Modem. The default route always uses the special address 0.0.0.0.

Multiple connections

Consider the following scenario, which features an Internet and Corporate connection, each using one B-channel (PPP):

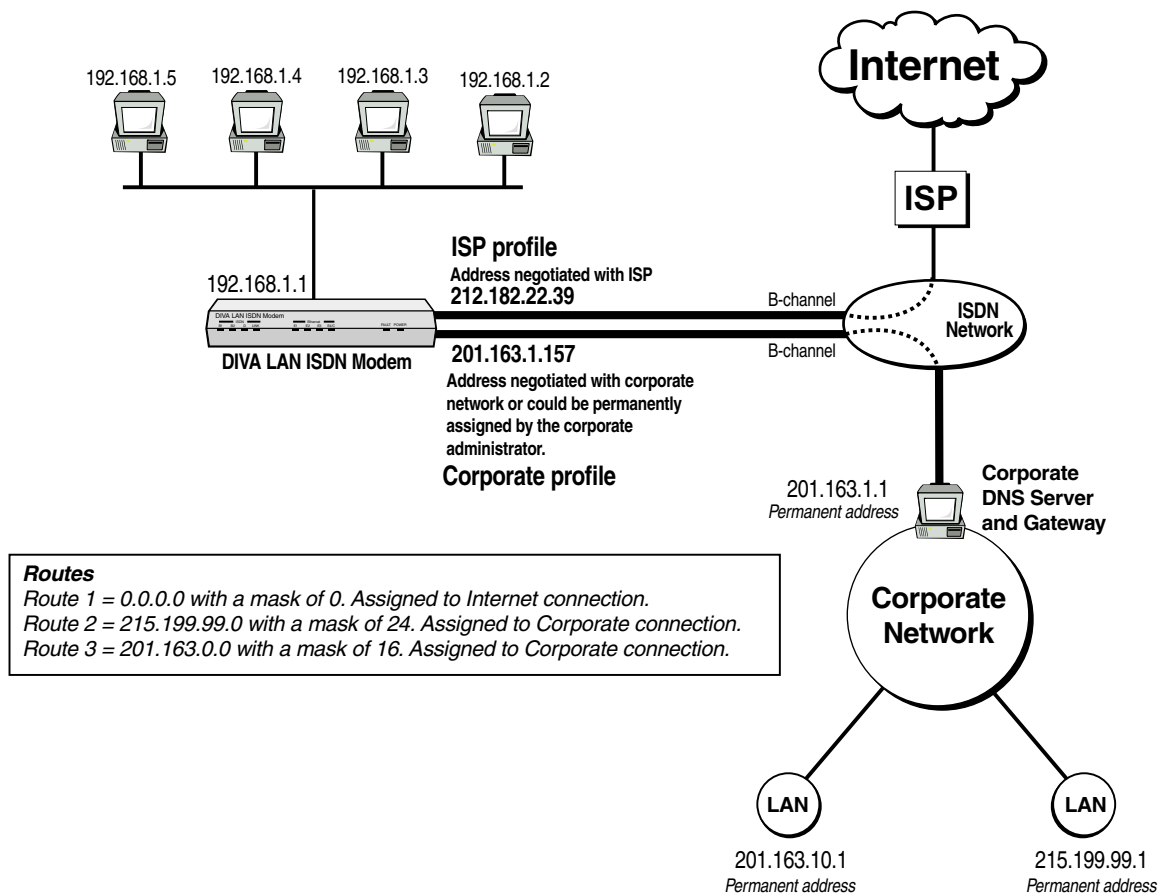

This scenario requires three routes:

Route 3 is used to route traffic to the Corporate network (201.163.0.0). It is assigned to the Corporate connection.

Notice that two subnetworks are directly connected to the Corporate network. Since one of these subnetworks has the same network address (201.163), traffic addressed to users on this subnet will be properly routed.

Route 2 is required to send traffic to the second subnet (215.199.99.1). It is assigned to the Corporate connection.

Route 1 is the default route. It is assigned to the Internet connection. It matches any address. Therefore, any traffic that is not routed by Route 2 or 3 is routed by Route 1 to the Internet.

Routing on the local LAN

The DIVA LAN ISDN Modem lets you create your own local area network. In some instances, this network, or the DIVA LAN ISDN Modem itself, will be connected to another network via a bridge or router. Consider this scenario, which adds another LAN to the previously discussed example:

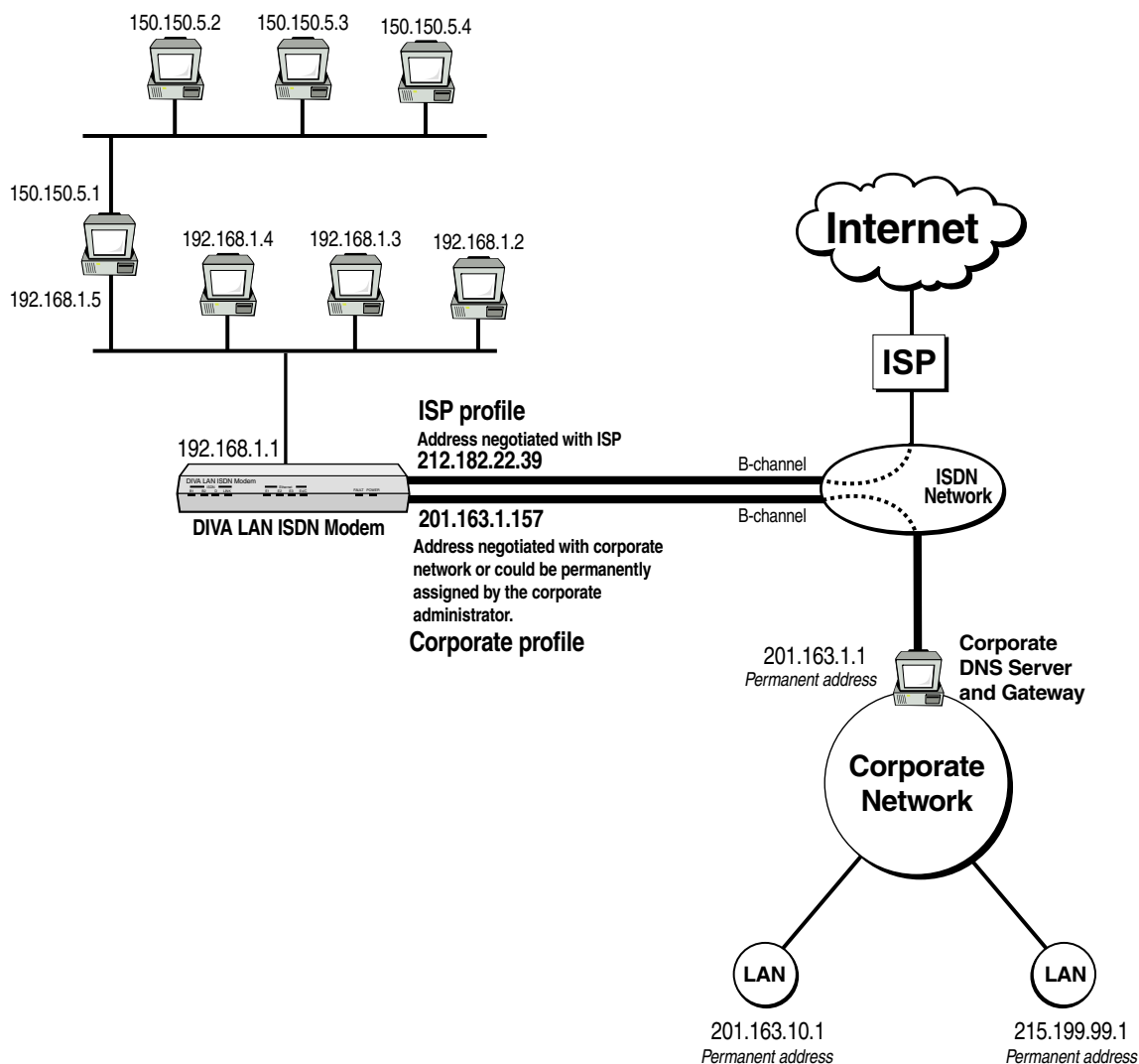

Routes

Route 1 = 0.0.0.0 with a mask of 0. Assigned to Internet connection.
 Route 2 = 215.199.99.0 with a mask of 24. Assigned to Corporate connection.
 Route 3 = 201.163.0.0 with a mask of 16. Assigned to Corporate connection.
 Route 4 = 150.150.0.0 with a mask of 16. Assigned to the LAN interface. Gateway address is 192.168.1.5

Assuming that RIP (discussed in the next section), is not being used on the LAN, this scenario requires an additional route.

Route 4 is used to route traffic to the new LAN connected to the computer with address 192.168.1.5 This route is assigned to the LAN interface, which means that instead of traffic being sent onto the ISDN link, it is forwarded onto the LAN. The LAN address of the destination is required, because unlike the ISDN link, where only one device exists at the other end of the connection, more than one device is connected to the LAN. So, the gateway address for this route is 192.168.1.5, which is the computer that provides access to the destination LAN. Of course, this computer must be properly configured to forward the datagrams it receives onto the other LAN.

The Routing Information Protocol (RIP)

RIP permits the DIVA LAN ISDN Modem to automatically discover routes for itself, by listening to routing broadcasts from other networks. If your corporate LAN broadcasts RIP updates, the DIVA LAN ISDN Modem will be able to discover routes to all subnets connected to it. For example, if a subnet does not have the same network address as your corporate network (as above), you need to create a specific route to support it. However, since RIP is enabled by default, all you need to do is specify a single route to the corporate network. The DIVA LAN ISDN Modem will listen for RIP broadcasts and define the needed routes.

RIP also works on the local LAN created by the DIVA LAN ISDN Modem. If this LAN is connected to other LANs, RIP will discover the routes to these LANs (if they are configured to broadcast RIP routing information).

Defining routes for the DIVA LAN ISDN Modem

You always need to have at least one route. When you use the Internet wizard, the default route (0.0.0.0) is automatically created for you.

In some cases, it may be necessary to manually add a route, even though RIP is enabled. To edit the routing table, do the following:

1. Start the Web configuration interface and log in.
2. Click *Manual Configuration*.
3. Click *IP*.
4. Click *Routes* to display the following page. If you previously ran the Internet wizard, the routing table should have at least one entry in it, the default route 0.0.0.0.

Note Only one default route can be defined for the DIVA LAN ISDN Modem, and its network address is always 0.0.0.0. Since the Internet wizard automatically creates a default route for the ISP profile, you must delete this route if you want to use a default route with the Corporate profile.

Use the explanations below to guide you in defining more routes.

IP parameters : Routes ?

Edit IP routing parameters

Rte	Network address	Mask length	Gateway address	Interface	Metric
1	<input type="text" value="0.0.0.0"/>	<input type="text" value="0"/> bits	<input type="text" value="0.0.0.0"/>	ISP	1
2	<input type="text"/>	<input type="text"/> bits	<input type="text"/>	None	<input type="text"/>
3	<input type="text"/>	<input type="text"/> bits	<input type="text"/>	None	<input type="text"/>
4	<input type="text"/>	<input type="text"/> bits	<input type="text"/>	None	<input type="text"/>
5	<input type="text"/>	<input type="text"/> bits	<input type="text"/>	None	<input type="text"/>
6	<input type="text"/>	<input type="text"/> bits	<input type="text"/>	None	<input type="text"/>
7	<input type="text"/>	<input type="text"/> bits	<input type="text"/>	None	<input type="text"/>
8	<input type="text"/>	<input type="text"/> bits	<input type="text"/>	None	<input type="text"/>
9	<input type="text"/>	<input type="text"/> bits	<input type="text"/>	None	<input type="text"/>
10	<input type="text"/>	<input type="text"/> bits	<input type="text"/>	None	<input type="text"/>

You may enter a maximum of 50 routes.
If all the above entries are full, click Save and more entries will appear.

Cancel
Reset Form
Back
Next
Save

- **Network address:** Specifies the IP address of datagrams that should be routed. The address you set here is compared against the destination address in all datagrams that pass through the DIVA LAN ISDN Modem. If a match is found, the datagram is routed to the profile specified under Interface.
- **Mask:** Lets you specify the number of bits that are checked when the DIVA LAN ISDN Modem compares the address of a datagram to that specified by the Network Address parameter. See "About IP addresses" on page 120 for more information.

- **Gateway address:** Only used if the Interface is set to LAN. This is the address of the device you want to send the routed traffic to. This will usually be the address of a bridge or router.
- **Interface:** Choose the name of the profile you want to send the routed data to. The profile you choose should establish a connection to the proper destination so that routing is successful. If you select LAN, data is routed onto the local Ethernet LAN created by the DIVA LAN ISDN Modem.
- **Metric:** Metric determines the weight of a route. If two identical routes exist, then the DIVA LAN ISDN Modem uses the route with the lower metric.

IP filters

IP filtering provides you with the means to implement customized security, usage, and cost control measures.

How filtering works

Filters are defined in a stack. Up to 8 filters can be combined together to obtain sophisticated results. Data cascades through the filter stack as follows:

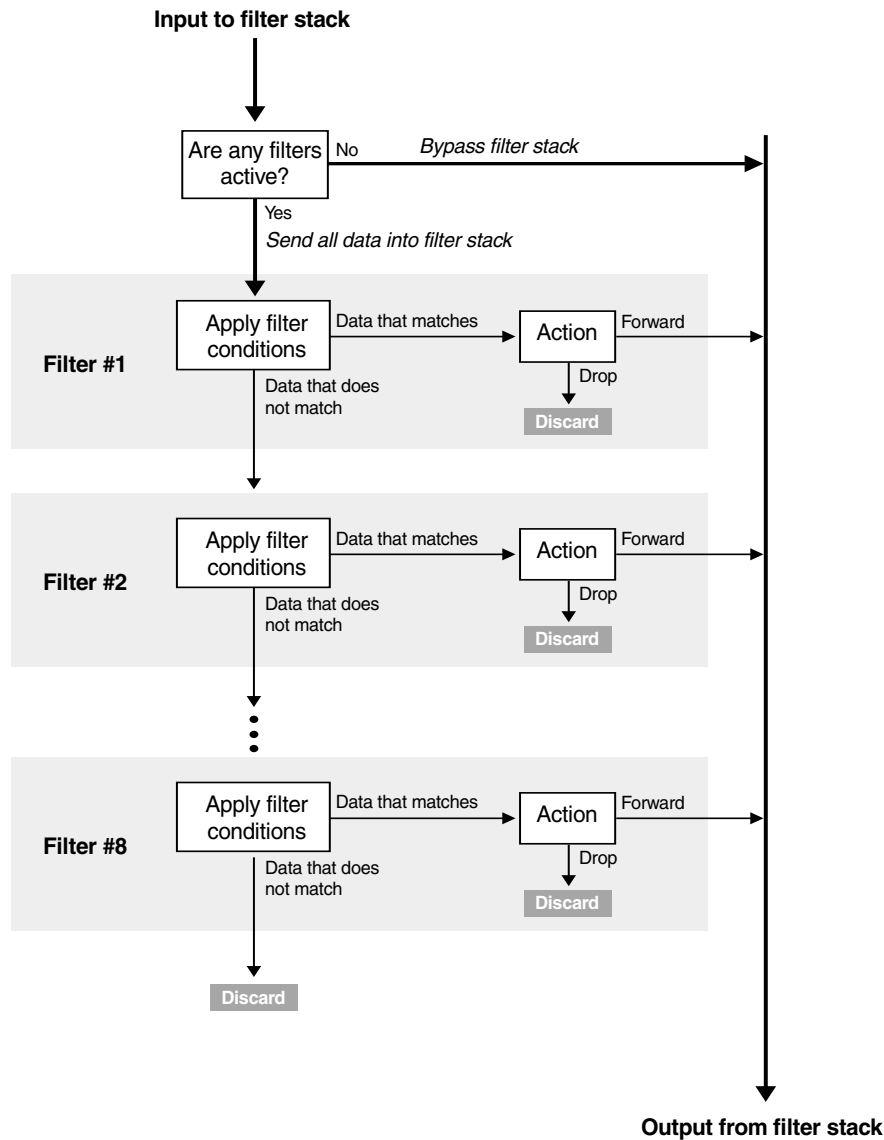

Each profile has its own filter stack. **However, note that once any filter is activated, all incoming and outgoing data passes through the filter stack.** By default, the DIVA LAN ISDN Modem defines three filters. This means, unless you turn these filters off, all incoming and outgoing data passes through the filter stack.

Note More sophisticated filters can be defined using the command line interface. See Chapter Ten for more information.

Default filters

By default, the DIVA LAN ISDN Modem defines the following three filters for the ISP profile:

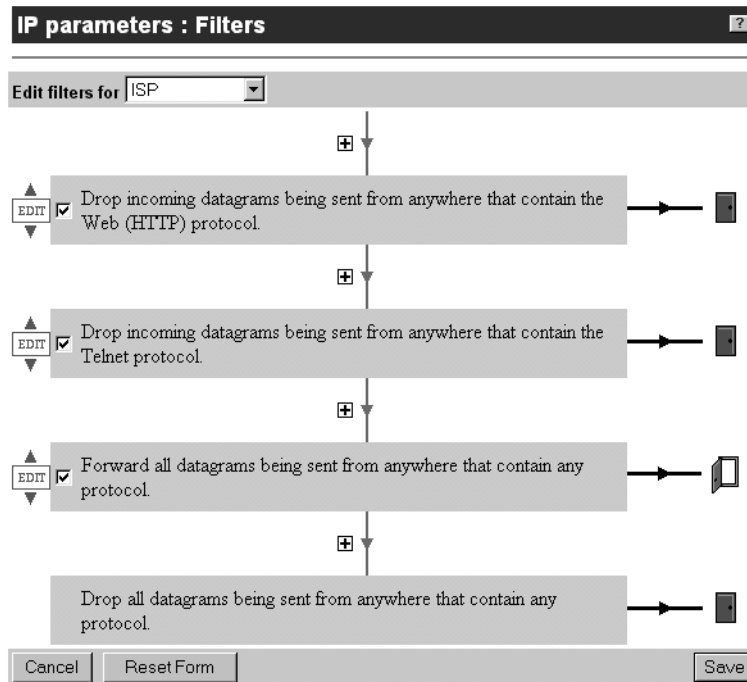

The first two filters prevent outside access to the web-based configuration interface and the CLI by discarding incoming HTTP and Telnet traffic. When you enable remote management, these filters are deleted.

The last filter is required because, by default, any traffic that is not forwarded is discarded when it reaches the bottom of the stack. This filter must be set to operate on all traffic (incoming and outgoing) because, once a filter is activated, all traffic passes through the filter stack.

What is a datagram?

Data on an IP network is carried in small packages called datagrams. Along with the data it is carrying, each datagram contains the IP address of its source and destination.

To define a filter

Filters become active immediately after they are defined. You do not have to reset the DIVA LAN ISDN Modem to activate them. If you are defining a filter that affects your connection to the DIVA LAN ISDN Modem, you will lose contact immediately after saving.

1. Start the web configuration interface and log in.
2. Click *Manual Configuration*.
3. Click *IP*.

4. Click *Filters* to display the following page. (If you enabled remote management you will not see the first two filters.)

IP parameters : Filters

Edit filters for **ISP**

+ ↓

EDIT Drop incoming datagrams being sent from anywhere that contain the Web (HTTP) protocol. →

+ ↓

EDIT Drop incoming datagrams being sent from anywhere that contain the Telnet protocol. →

+ ↓

EDIT Forward all datagrams being sent from anywhere that contain any protocol. →

+ ↓

Drop all datagrams being sent from anywhere that contain any protocol. →

5. Select the profile you want to define filters for.
6. Click a “+” symbol to insert a new filter. The DIVA LAN ISDN Modem displays the Edit Filters page.

IP parameters : Edit Filters

Edit IP filters for profile **ISP**

Drop all datagrams being sent from anywhere

that contain protocol.

Operation on this filter

Select the operation to perform on this filter and click Do it!

No operation

7. Define the settings for the filter and click *Done*. The following descriptions explain the options that are available.

The screenshot shows a configuration window titled "Edit IP filters for profile ISP". It has a header bar with the title. Below the header, there are several fields and buttons. The fields are: "Action" (a dropdown menu set to "Drop"), "Direction" (a dropdown menu set to "incoming"), "Source / Destination" (a dropdown menu set to "datagrams being sent"), "Location" (a dropdown menu set to "from the network:"), "Address" (a text box containing "192.168.1.0"), and "Protocol" (a dropdown menu set to "any"). At the bottom of the window, there are two buttons: "Reset Form" on the left and "Done" on the right. Dotted lines connect labels above and below the window to the corresponding fields.

Action

- **Drop:** Discard data that matches the filter definition.
- **Forward:** Send data that matches the filter definition to the filter output.

Direction

- **incoming:** Data being received by the DIVA LAN ISDN Modem on the ISDN link.
- **outgoing:** Data being sent by the DIVA LAN ISDN Modem on the ISDN link.
- **all:** Both incoming and outgoing.

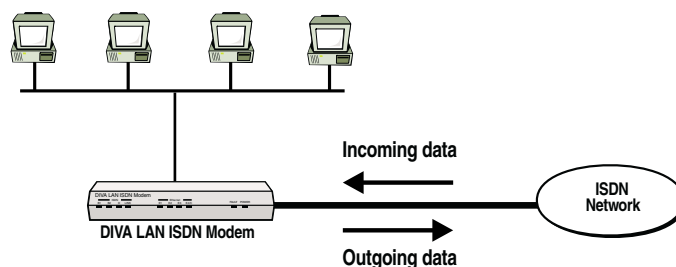

Source/Destination

- **from:** Examine the source IP address of the datagram.
- **to:** Examine the destination IP address of the datagram.

Location

- **the Ethernet LAN:** Sets the filter to match datagrams with network addresses that are the same as that of the DIVA LAN ISDN Modem. By default, this is 192.168.1.0. A mask of 255.255.255.0 is used to extract the network address.
- **the network:** Sets the filter to match datagrams with network addresses that are the same as that the one you specify. Choosing this option requires that you supply the IP address of a class C network in the next box. The filter uses a mask of 255.255.255.0 to extract the network address (class C network mask).
- **host:** Sets the filter to match datagrams with IP addresses that are the same as the one you specify. Choosing this option requires that you supply the IP address of the host computer in the next box. The filter uses a mask of 255.255.255.255.
- **anywhere:** Sets the filter to ignore the source and destination address in the datagram.

Address

Only applies if you select *the network* or *the host* for location.

Protocol

IP datagrams can carry a wide variety of protocol traffic. The DIVA LAN ISDN Modem lets you filter the many of the most popular protocols. The following descriptions explain some of the options that are available.

- **any:** Applies the filter to any datagram.

- **any well known:** Applies the filter to any protocol using TCP or UDP ports in the range 0 to 1023. See RFC 1700 for the complete list of protocols.
- **UNIX:** Applies the filter to any protocol using TCP or UDP ports in the range 512 to 1023. See RFC 1700 for the complete list of protocols.
- **TCP:** Many protocols (such as HTTP, FTP, Telnet, News) make use of TCP. If you filter all TCP traffic you will prevent the use of these protocols. Note that access to the web configuration interface occurs via HTTP and access to the command line interface (CLI) occurs via Telnet.
- **UDP:** Many protocols (such as SNMP, Time, TFTP, BOOTP) make use of UDP. If you filter all UDP traffic, you will prevent the use of these protocols.
- **FTP:** Applies the filter to all datagrams containing the file transfer protocol.
- **Web (HTTP):** If you filter all HTTP traffic, you may not be able to reach the web configuration interface. Filtering outgoing HTTP traffic can be used to prevent users from browsing on the Internet.
- **Mail (SMTP):** Applies the filter to all datagrams containing the mail (SMTP) protocol.
- **Mail (POP3):** Applies the filter to all datagrams containing the mail (POP3) protocol.
- **Telnet:** If you filter all Telnet traffic, you will not be able to reach the command line interface (CLI).
- **TFTP:** The DIVA LAN ISDN Modem can function as a TFTP server to support uploading and downloading of configuration files. If you filter TFTP traffic, you will not be able to use this feature.
- **DNS:** Domain name system. Filtering DNS datagrams can cause disruptions in the ability to access remote sites.

The following options are also available: NFS/RPC, News, Time (NTP), BOOTP, SNMP, ICMP, Ping (ICMP), Ping Reply, ICMP Redir. For a description of these protocols, consult the appropriate RFC at the site www.faqs.org.

8. Activate the filter by clicking the box that appears to the right of the EDIT button.
9. Click *Save*. This makes the filter operational.

Note *Unlike other configurations settings, you do not have to reset the DIVA LAN ISDN Modem to make filters operational.*

IP filtering examples

The examples in this section illustrate how to use filters to:

- Dropping incoming traffic from a specific network
- Allowing incoming traffic only from a specific network
- Blocking web surfing

Note *These examples assume that you have not enabled remote management. If enabled, the default filter stack you see will only contain the single filter: "Forward all datagrams being sent from anywhere that contain any protocol." If no filters are present, the only visible filter will be "Drop All". The "Forward all" filter is active but invisible.*

Dropping incoming traffic from a specific network

This example defines a filter to make sure that no traffic is accepted from a specific network. Assume the network has the IP address 213.112.12.0.

Since the filter is applied against data from the Internet, it is defined for the ISP profile. Place this filter in the third position in the stack.

Edit IP filters for profile ISP

Drop	incoming	datagrams being sent	from	the network:
213.112.12.0	that contain	any	protocol.	

When done, the filter stack should look like this:

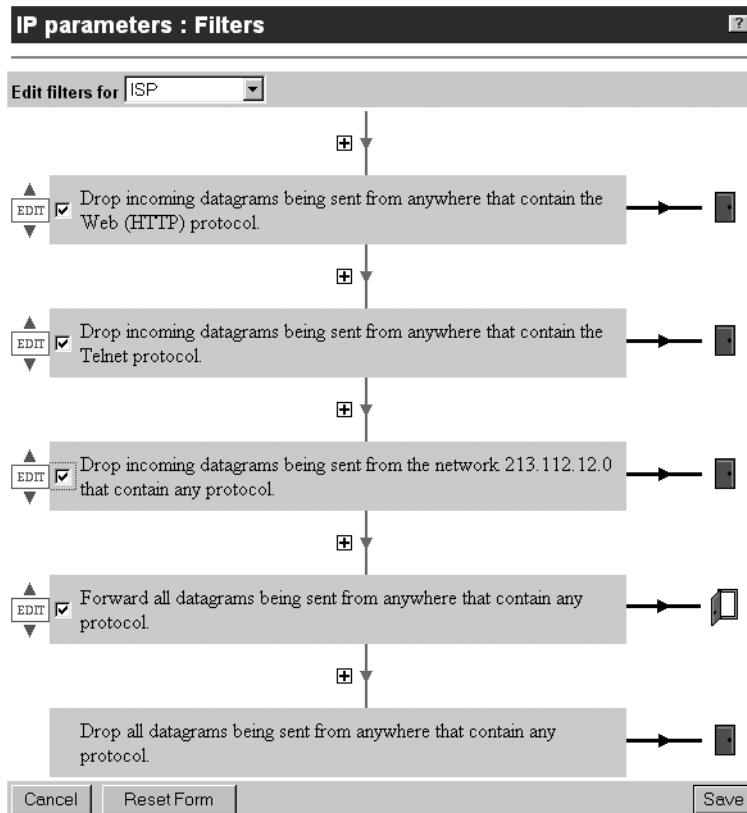

Allowing incoming traffic only from a specific network

This example shows how to allow the DIVA LAN ISDN Modem to only receive incoming data from a specific network (112.111.212.0) on the Internet. Data from all other networks is dropped. However, outgoing traffic is not affected.

This requires defining two filters. Since these filters are applied against data from the Internet, they are defined for the ISP profile.

1st filter

Define the 1st filter to forward only incoming traffic from 112.111.212.0. Place this filter in the third position in the stack.



2nd filter

Define the 2nd filter to forward all outgoing traffic. The easiest way to do this is to edit the existing filter that is set to “Forward all datagrams being sent from anywhere that contain any protocol.” Change it to “Forward outgoing datagrams being sent from anywhere that contain any protocol.”

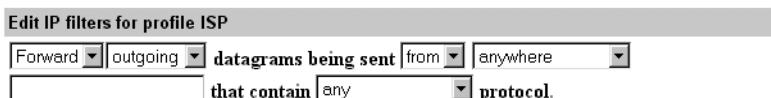

When done, the filter stack should look like this:

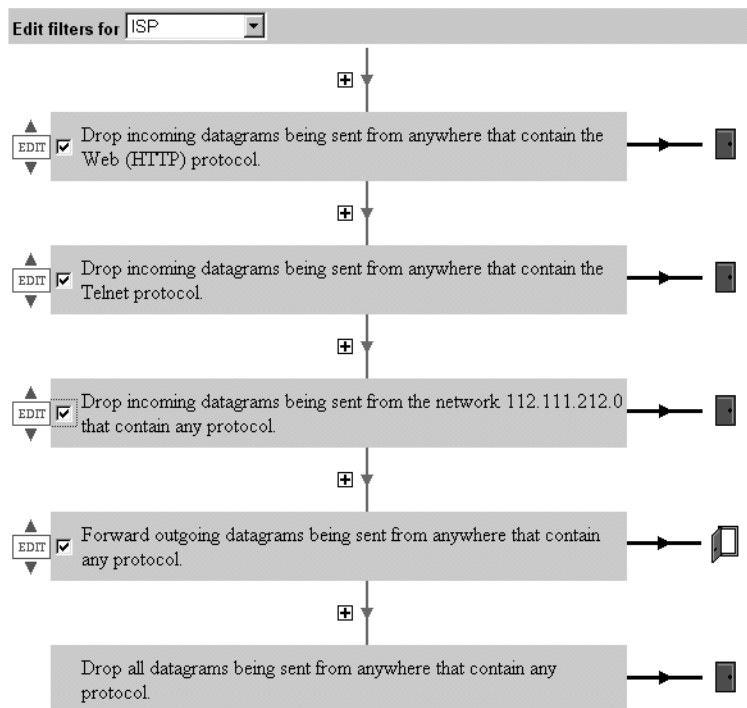

Blocking web surfing

This example shows how to block computers on the local LAN created by the DIVA LAN ISDN Modem from surfing the web.

Web traffic is carried by the HTTP protocol. Therefore, to stop web access, this protocol needs to be dropped for all outgoing traffic.

A single filter needs to be defined. Place this filter in the third position in the stack.

Edit IP filters for profile ISP

Drop outgoing datagrams being sent from the Ethernet LAN that contain the Web (HTTP) protocol.

When done, the filter stack should look like this:

The screenshot shows a configuration window titled "IP parameters : Filters" with a help icon. Below the title bar, there is a dropdown menu labeled "Edit filters for" with "ISP" selected. A vertical line with a downward arrow and a plus sign icon indicates the filter stack. The stack consists of five filter rules, each with an "EDIT" button, a checkbox, and a description:

- 1. Drop incoming datagrams being sent from anywhere that contain the Web (HTTP) protocol. (Action: Drop)
- 2. Drop incoming datagrams being sent from anywhere that contain the Telnet protocol. (Action: Drop)
- 3. Drop outgoing datagrams being sent from the LAN network that contain the Web (HTTP) protocol. (Action: Drop)
- 4. Forward all datagrams being sent from anywhere that contain any protocol. (Action: Forward)
- 5. Drop all datagrams being sent from anywhere that contain any protocol. (Action: Drop)

At the bottom of the window are three buttons: "Cancel", "Reset Form", and "Save".

Making a V.120 connection

V.120 was designed to allow non-ISDN devices to communicate with the ISDN network. The DIVA LAN ISDN Modem provides support for V.120, so you can connect with such legacy systems. For example, in many countries around the world, Compuserve offers access to their network over ISDN, using the V.120 protocol.

In general, you should use V.120 only when the site you are connecting to requires it. Once the V.120 connection is active, the DIVA LAN ISDN Modem automatically establishes a PPP connection on top of it. This is why you will see this option listed as *PPP over V.120* on the configuration screens.

To make a V.120 connection you must do two things:

- Configure the V.120 protocol for the profile that will make the connection.
- Define a V.120 script to automatically log on to your ISP. The DIVA LAN ISDN Modem contains a pre-defined script that should work in the majority of cases. However, you may need to modify this script for your installation.

To configure the V.120 protocol

1. On the Configuration main menu, click *V.120*. You will see the following page:

V.120 parameters
Edit V.120 parameters

Mode: Multiframe

Maximum transmit frame size: 256

Maximum receive frame size: 260

Window size (K): 7

Maximum Retry count: 3

Retransmission timer (T200): 15

Link Integrity timer (T203): 30

Idle timer: 1440

Cancel Reset form Save

2. Define the V.120 parameters to match the settings of the remote site you are going to connect to. For information on each parameter consult the online help by clicking the parameter name.
3. Click *Save*.
4. On the Configuration main menu, click *Connection Profiles*.
5. Click *Edit* for the profile that will make the V.120 connection.
6. Click *Connection* on the menu bar.
7. Select *PPP over V.120* as the *Protocol*.

Connection profiles ?

Profile

Profile | Connection | IP | RIP | Authentication | Callback | FINISH

Profile name: ISP

Enable profile?

Protocol: PPP over V.120 More...

Backup profile: None

Profile restore delay: 0 seconds

Profile | Connection | IP | RIP | Authentication | Callback | FINISH

8. Click *More*. You will see the V.120 Dialing Script page:

9. This page contains a pre-defined script that you can modify for your installation. When the V.120 connection is established, this script is automatically run to complete the log in process. Consult your ISP to determine the sequence of events that occur during the log in process. Then modify this script accordingly. The following commands are available:

- **Send:** Sends the specified text to the remote. Enter up to 33 alphanumeric characters.
- **Send username:** Sends the Local username (set on the Authentication page) to the remote.
- **Send password:** Sends the Local password (set on the Authentication page) to the remote.
- **Wait for:** Pause script execution until the specified text is sent by the remote system. Enter up to 33 alphanumeric characters.
- **Delay:** Pauses script execution for the specified number of seconds. Range: 1 to 255 seconds.
- **Timeout:** If the next script event does not complete within the time specified, the script is aborted. Range: 1 to 255 seconds.
- **Abort:** End the script.

10. Click *Save*.
11. Click *Finish*.
12. Click *Reset*.

SecurID support

When establishing a connection to a SecurID server, a special username and password must be supplied to log on. The server will request this information during authentication. In order to reply to the request, the DIVA LAN ISDN Modem must obtain the log on information from the user that initiated the connection. To support the dynamic collection of username and password, the Eicon SecurID Client application must be installed on the user's computer.

For example:

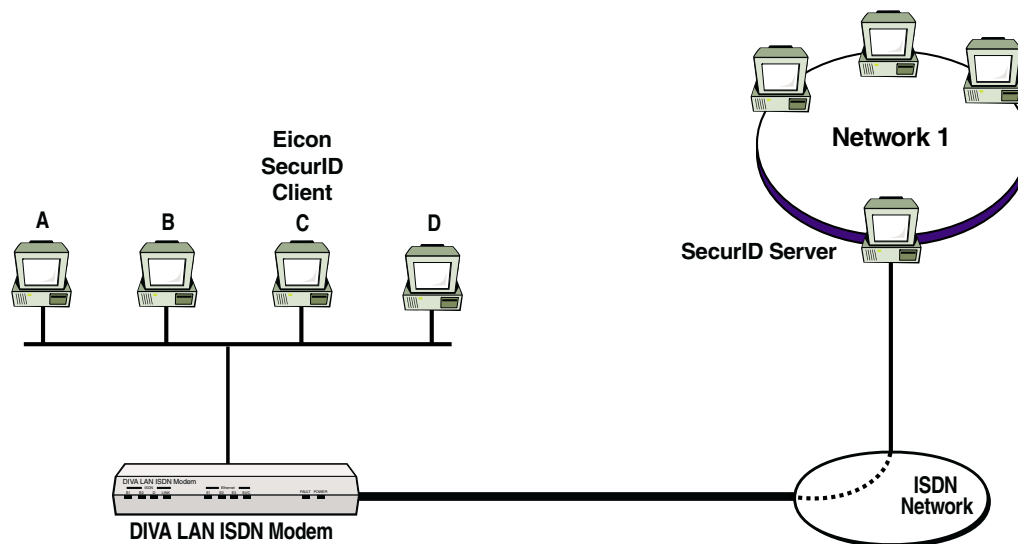

The user on computer C attempts to access a resource on Network 1. Before the DIVA LAN ISDN Modem places the call, it requests a SecurID username and password from the Eicon SecurID Client on computer C, which causes the Eicon SecurID Client to display a dialog box to the user. The user fills in the appropriate information and clicks OK. The Eicon SecurID Client forwards the information to the DIVA LAN ISDN Modem, which then places the call. When the SecurID server asks for authentication, the DIVA LAN ISDN Modem sends the SecurID username and password. If correct, the connection is established.

Note Once the connection to the SecurID protected server is established, all users on the internal LAN have access to the server. In the example above, once C logs in, computers A, B, and D also gain access to the server.

To install the Eicon SecurID Client software

1. Open the folder \SecurID on the DIVA LAN ISDN Modem CD ROM.
2. Copy all the files in this folder to a new folder on your computer.
3. Go to the MS DOS prompt.
4. Change directories to the new folder.
5. Execute the command: `secid.exe -i`
This installs the Eicon SecurID client and start it. Each time you restart Windows, the Eicon SecurID client will automatically load.

To uninstall the Eicon SecurID Client software

6. Go to the MS DOS prompt.
7. Change directories to the folder where you copied the SecurID files.
8. Execute the command: `secid.exe -u`
This uninstalls the Eicon SecurID client.
9. Delete the folder.

To enable SecurID support

1. On the Configuration main menu, click *Connection Profiles*.
2. Click *Edit* for the profile you want to enable SecurID support for.
3. Click *Authentication* on the menu bar. You will see the following page.

The screenshot shows a web interface for configuring connection profiles. At the top, there is a dark header with the text 'Connection profiles' and a help icon. Below this is a sub-header 'Authentication parameters'. A breadcrumb trail reads 'Profile | Connection | IP | RIP | Authentication | Callback | FINISH'. The main content area contains several form fields and checkboxes: 'Local username:' with the value '123', 'Local password:' with a masked value '*****', 'Always use encrypted password?' with an unchecked checkbox, 'Always authenticate remote?' with an unchecked checkbox, 'Remote username:' with an empty field, 'Remote password:' with an empty field, and 'Use SecurID?' with an unchecked checkbox. At the bottom, another breadcrumb trail reads 'Profile | Connection | IP | RIP | Authentication | Callback | FINISH'.

4. Check the *Use SecurID* box.
5. Click *Finish*.
6. Click *Save*.
7. Click *Reset*.

Other Configuration Tools

The DIVA LAN ISDN Modem has four configuration interfaces: Web, CLI, DTMF, and TFTP. For most configuration tasks you should use the Web interface, since it is the easiest and fastest way to change configuration settings. However, in some cases, you may want to take advantage of the other tools described in this chapter.

Configuration options

Local configuration

The following diagram illustrates the configuration interfaces that are accessible locally.

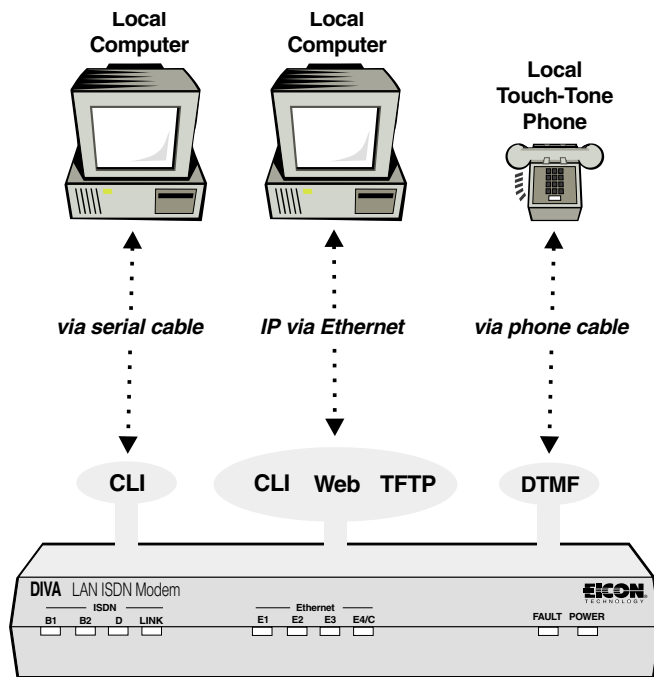

Remote configuration

The following diagram illustrates the configuration interfaces that are accessible remotely, using the ISDN line to call in.

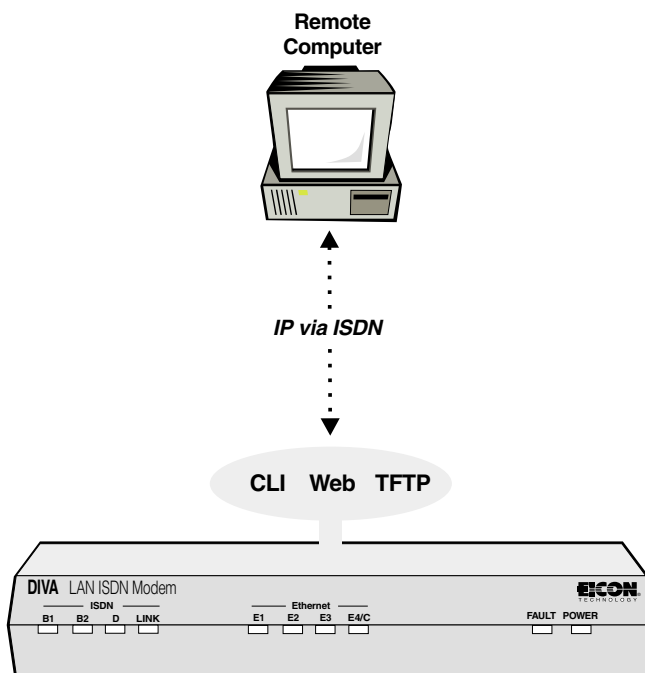

Note *Telnet software is required to access the CLI interface.*

Web interface

An easy to use interface that provides access to configuration wizards, advanced configuration parameters, and status information. The web interface is discussed in detail in Chapter Four.

Prerequisites

- Requires Web browser software.
 - Netscape 3.01 or later
 - Internet Explorer 4 or later

Internet Explorer 4 is included on the DIVA LAN ISDN Modem CD for computers running Windows 95, Windows 98, or NT 4.0 or later. NT 4.0 requires SP3 or SP4 available on the DIVA LAN ISDN Modem CD.

Local access

- IP connection via an Ethernet port.
- User must supply system password to log on (page 76).

Remote access

- IP connection via ISDN.
- Remote management must be enabled (page 81).
- Support for incoming data calls must be enabled (page 83).
- User must supply system password to log on (page 76).

TFTP interface

The TFTP interface lets you upload and download configuration files and firmware.

Prerequisites

- Requires TFTP client software. A shareware client is included on the DIVA LAN ISDN Modem CD.

Local access

- IP connection via an Ethernet port.
- Support for TFTP server must be enabled.

Remote access

- IP connection via ISDN.
- Remote management must be enabled (page 81).
- Support for incoming data calls must be enabled (page 83).
- Support for TFTP server must be enabled.

Enabling TFTP server support

Using Web interface

1. Click *IP* on the Manual Configuration menu.
2. Click *General*.
3. Check the *TFTP server* check box.

IP parameters : General

Edit IP general parameters

DNS relay:

TFTP server:

NetBIOS IP services: None

Cancel Reset form Save

4. Click *Save*.
5. Click *Reset*.

Using the command line interface (CLI)

For instructions on using the CLI see page 146. Once you have logged into the CLI, enter the following commands to enable TFTP server support:

```
enable tftp server
save
```

Uploading/downloading configuration files

All configuration settings on the DIVA LAN ISDN Modem are stored in configuration files. Using TFTP, you can access these files to retrieve and set configuration values.

File Name	Access	Description
config.bat	Write-only	A file containing CLI commands. The commands in this file are automatically executed after being uploaded with TFTP. Trace commands are not supported by this file. Use trace.bat instead.
trace.bat	Write-only	Same as config.bat except that it supports trace commands.
results.txt	Read-only	Contains the results of the last .bat file that was executed.
config.all	Read-only	Contains the list of commands that define the current active configuration. Retrieve this file to view the entire configuration of the DIVA LAN ISDN Modem.
config.bin	Read/write	Contains a binary image of the current active configuration. You can download this file to backup the current configuration. (Download as a binary file.)
image.elm	Read/write	Contains the DIVA LAN ISDN Modem firmware. Write to this file to update the firmware. After writing is complete, a reset is automatically performed. Download this file to back up the firmware. (Download as a binary file.)
system.log	Read-only	The system log contains a record of a variety of events (trace data, connected/disconnected messages, security-related messages, warning and errors messages) that have occurred on the DIVA LAN ISDN Modem. The log can contain over 15000 entries before it wraps around.

Loading new firmware via TFTP

To upload new firmware to the DIVA LAN ISDN Modem, use your TFTP client software to transfer the firmware file. For example, under NT, you would issue the following command:

```
tftp -i 192.168.1.1 put NewImageFile image.elm
```

Where:

- 192.168.1.1 is the IP address of the DIVA LAN ISDN Modem.
- NewImageFile is the name of the most recent DIVA LAN ISDN Modem image file.
- image.elm is the target file name on the DIVA LAN ISDN Modem.

DTMF interface

The DIVA LAN ISDN Modem enables you to set certain parameters using a standard touch-tone telephone.

Prerequisites

- touch-tone analog phone

Local access

- Phone must be plugged into PHONE port 2.
- ISDN line must not be connected.

Remote access

- Not available.

How it works

Plug an analog phone into PHONE port 2.

- Each command starts and ends with a #.
- A short beep indicates that the command you entered was accepted.
- Continuous beeping indicates that the command you entered was rejected. Enter # to start a new command and end the beeping.

Commands

The following commands are available.

Set primary ISDN telephone number

#TN1 *ISDN number* # (#861*ISDN number* #)

Example: #8614078#

Set second ISDN telephone number

#TN2 *ISDN number* # (#862 *ISDN number* #)

Example: #8624079#

Set ISDN switch type

- #STA# (#782#) AT&T 5ESS
- #STP# (#787#) AT&T 5ESS Point-to-Point
- #STN# (#786#) NI-1
- #STD# (#783#) Detect Switch Type Automatically

Save configuration and reset

#SA# (#72#)

Reset to factory defaults

#RF# (#73#)

Set LAN IP address

#IPxxx*xxx*xxx*xxx# (#47xxx*xxx*xxx*xxx#)

Example: #47192*168*4*1#.

Set LAN IP subnet mask

#SMxxx*xxx*xxx*xxx# (#76xxx*xxx*xxx*xxx#)

Example: #76255*255*255*0#.

Command line interface (CLI)

The command line interface provides you with access to all DIVA LAN ISDN Modem parameters. Some advanced parameters are only accessible via this interface.

Prerequisites

- Requires Telnet software for an IP connection.
- Requires terminal emulation software for a direct serial connection.
- Requires special serial cable (included) for a direct serial connection.

Local access

Telnet

- IP connection via an Ethernet port.
- User must supply system password to log on (page 76).

Direct serial

- Direct connection between PC's serial port and serial port on the DIVA LAN ISDN Modem using the included beige serial cable.
- User must supply system password to log on (page 76).

Remote access

- IP connection via ISDN.
- Remote management must be enabled (page 81).
- Support for incoming data calls must be enabled (page 83).
- User must supply system password to log on (page 76).

Establishing a Telnet connection via IP

To establish a Telnet connection you require the following:

- an Ethernet card installed in your computer
- TCP/IP installed and configured on your computer
- Telnet software (provided with Windows 95/98/NT)

To establish a Telnet connection

1. Start your Telnet software. If you are running Windows 95/98/NT, select the Run command on the Start menu, type TELNET, and press enter.
2. Connect to the address 192.168.1.1. This is the default address assigned to the DIVA LAN ISDN Modem. If it has been changed, use the new address. If you are connecting remotely, via ISDN, use the "external" IP address assigned to the DIVA LAN ISDN Modem.
3. A welcome message appears on your screen. It will include a request to enter a password.
4. Type the appropriate password and press enter. The DIVA LAN ISDN Modem displays the command line prompt '>'. See "Using the command line interface" on page 147 for more information.

Establishing a serial connection

To establish a serial connection you require the following:

- a free serial port on your computer
- Asynchronous communications software (use HyperTerminal provided with Windows 95/98/NT)
- your computer must be connected to the DIVA LAN ISDN Modem via the supplied serial cable (beige).

To establish a serial connection

Establish a serial connection as follows:

1. Connect the DB9 connector on the beige serial cable to the serial port on your computer, and plug the RJ45 connector into the CONSOLE port on the back of the DIVA LAN ISDN Modem.
2. Start your communications software. (If you are running Windows 95/98/NT, use HyperTerminal which is available in the Accessories folder.)
3. Set your software to match the following configuration:

Parameter	Setting
Terminal emulation type	VT100 or VT102
Bits per second (bps)	115200 (recommended), 57600, 19200, 9600
Local echo	off
CR translation	CR
LF after CR	off
Data bits	8
Stop bits	1
Parity	none
Flow control	hardware

4. Initiate the connection with your software.
5. Press the Enter key on your keyboard several times until a welcome message appears on your screen. It will include a request to enter a password.
6. Type the appropriate password (if any) and press enter. The DIVA LAN ISDN Modem displays the command line prompt '>'. See "Using the command line interface" on page 147 for more information.

Using the command line interface

The command line interface provides direct access to almost all of the DIVA LAN ISDN Modem's configuration parameters.

When you connect to the DIVA LAN ISDN Modem via a serial connection or Telnet connection, you are greeted with the command line interface welcome message and a request for a password. Once you enter the correct password, you will see the command line prompt '>'.

Make sure that you are using VT100 terminal emulation, otherwise the command line interface may not display properly on your screen and certain keys will not function correctly.

The DIVA LAN ISDN Modem is now ready to accept your commands. The following keys are available for use:

- up/down arrows: Moves back and forth through previously issued commands.
- F1: Provides help tailored to the current command you are entering. For example, if you are part way through typing a command, it will show you the valid syntax to complete it.
- Tab: To speed up entry of commands, you need only enter enough of the command so that the CLI can uniquely recognize it, or press TAB and the CLI will automatically complete the current keyword for you. For example: The PROFILE command can be shortened to PROF. Pressing TAB expands it to PROFILE.

When a command calls for a string of alphanumeric characters, you can use "" to enter an empty string.

About configuration context

The command line interface identifies the configuration context you are in by changing the prompt. When you first activate the CLI interface you are in the General configuration context, which is identified by a plain prompt (>). All other contexts are identified by a label added to the prompt.

About profiles

To make the configuration of the DIVA LAN ISDN Modem easier, the parameters that control its operation have been combined into groups according to function. These groups are called profiles. When you want to customize the operation of the DIVA LAN ISDN Modem, you use a CLI command to change the setting of a parameter in one of its profiles. To do this, you must set the focus (also called the configuration context) of the command line interface to be on the profile.

Connection profiles

Certain profiles define the characteristics of a connection, instead of just operational settings for the DIVA LAN ISDN Modem. For example, the ISP profile defines a connection that enables the DIVA LAN ISDN Modem to be connected to an Internet service provider. When the profile is active, the features and functions defined by the profile are active. In the case of the ISP profile, it means the DIVA LAN ISDN Modem will dial and connect to the ISP whenever a computer attempts to browse the Internet.

Default profiles

The DIVA LAN ISDN Modem has following default profiles:

- **ISP:** This profile is created by the Internet Wizard. It defines the settings for a connection to the Internet.
- **Corporate:** This profile can be used to define the settings for the connection to a remote corporate site.
- **LAN:** This is an internal profile that is part of the default configuration of the DIVA LAN ISDN Modem. It defines the settings for the LAN created by the Ethernet hub built into the DIVA LAN ISDN Modem. You can change the settings of this profile, but you cannot deactivate it.
- **Incoming:** This is an internal profile that is part of the default configuration of the DIVA LAN ISDN Modem. It defines how the DIVA LAN ISDN Modem handles incoming data calls. You can change the settings of this profile. By default, support for incoming calls is disabled.

Command line reference

See Appendix C for a complete list of all CLI commands and their descriptions.

Loading firmware with the CLI

The DIVA LAN ISDN Modem firmware is the program that resides on the modem and controls all its functions. Periodically, Eicon Technology may make new versions of the firmware available that improve the performance of the modem or add additional features. To take advantage of these updates you must retrieve the appropriate firmware module and load it on the DIVA LAN ISDN Modem.

Note *This section describes how to update the firmware using the CLI interface. The firmware can also be easily upgraded using the web-based configuration interface and your web browser. See “Upgrading the DIVA LAN ISDN Modem firmware” on page 56 for complete instructions.*

Retrieving new firmware

Retrieve the new firmware from www.eicon.com/divalan/downld.htm.

To load the new firmware

1. Log in to the CLI.
2. Type the following command and press Enter.

```
> monitor
```
3. Type the following command and press Enter.

```
> at@load
```
4. The DIVA LAN ISDN Modem warns you that your firmware is about to be erased. Note that all configuration settings are retained, including passwords. Type 'Y'.

```
This will erase your FLASH memory, do you wish to proceed (y/n)? y
```
5. When you see the following message, the DIVA LAN ISDN Modem is ready to receive the firmware update.

```
Please start XMODEM transmission of file to be loaded
```
6. Start your file transfer using 1K XMODEM (or XMODEM). The terminal program displays a dialog box showing the progress of the transfer.
7. When the transfer is done, the DIVA LAN ISDN Modem automatically resets itself to invoke the new software.

Appendix A

TCP/IP Configuration

This appendix provides instructions on how to install and configure TCP/IP for use with the DIVA LAN ISDN Modem.

Installing and configuring TCP/IP for Windows 95/98

Installing TCP/IP

If TCP/IP is not installed on your computer, install it as follows:

1. On the Start menu, choose *Settings*, then choose *Control Panel*.
2. Double-click the *Network* icon. The Network dialog box appears.
3. Click *Add*. The Select Network Component Type dialog box appears.

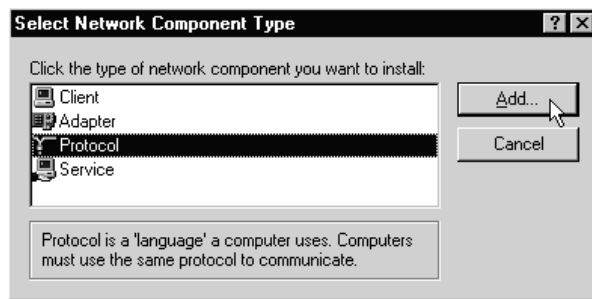

4. Select *Protocol* and click *Add*. The Select Network Protocol dialog box appears.

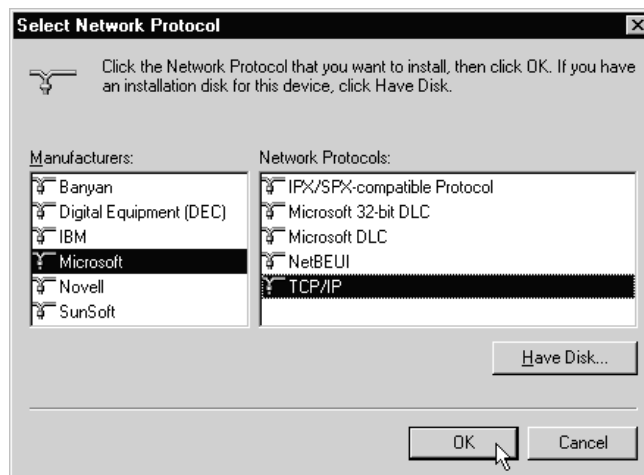

5. In the Manufacturer box, choose *Microsoft*.
6. In the Network Protocols box, choose *TCP/IP*.
7. Click *OK*.
8. Go to the next section to configure TCP/IP.

Configuring TCP/IP

If TCP/IP is installed on your computer, do the following to configure it for use with the DIVA LAN ISDN Modem.

1. On the Start menu, choose *Settings*, then choose *Control Panel*.
2. Double-click the *Network* icon. The Network dialog box appears.
3. On the Configuration tab, select *TCP/IP* for the network card that is installed in your system.
4. Click *Properties*. The TCP/IP Properties dialog box appears.

5. Click the *IP Address* tab.

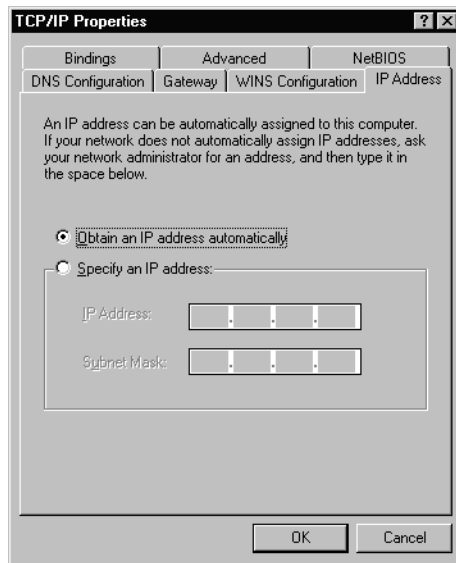

6. Select *Obtain an IP address automatically*. This defines your machine as a DHCP client.

7. Click the *WINS Configuration* tab.

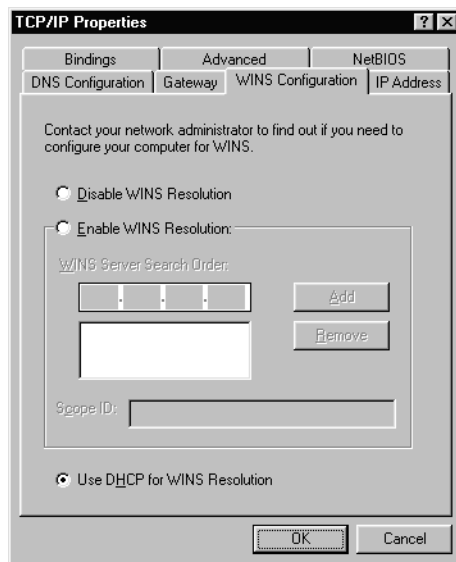

8. Select *Use DHCP for WINS Resolution*.

- Click the Gateway tab.

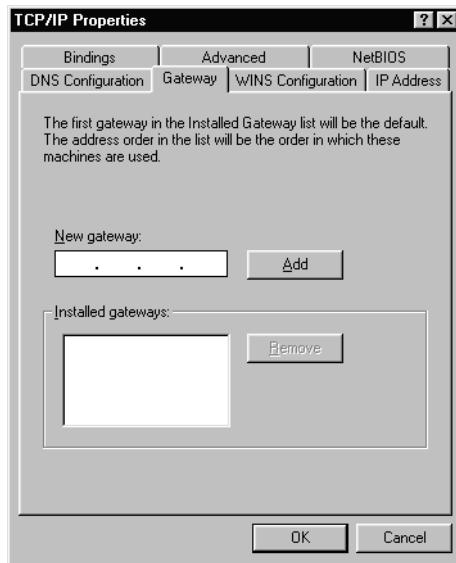

- Make sure no gateways are defined.

- Click the DNS Configuration tab.

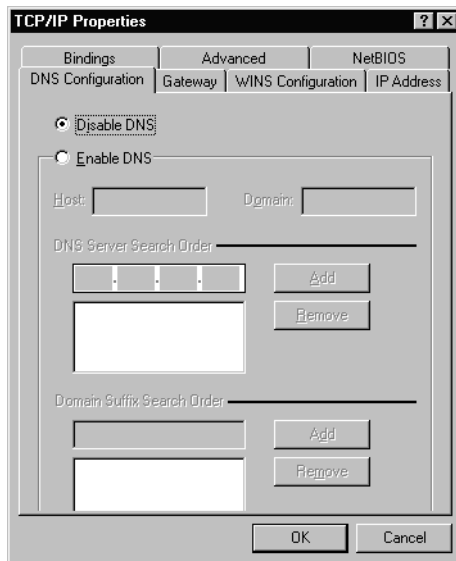

- Select *Disable DNS*. This sets your computer to use the DIVA LAN ISDN Modem as its DNS server.

- Click *OK*.

- Click *OK*.

- When prompted, insert the original Windows 95/98 installation CD and enter the drive letter of your CD drive (or use the Browse button to locate your CD drive), then click *OK*.

- Click *Yes* when prompted to restart your system.

Installing TCP/IP for Windows NT

Installing TCP/IP

1. On the Start menu, choose *Settings*, then choose *Control Panel*.
2. Double-click the *Network* icon. The Network dialog box appears.
3. Click the *Protocols* tab.
4. Click *Add*.
5. Select *TCP/IP protocol* as your network protocol.
6. Click *OK*.
7. Click *Yes* to use DHCP.
8. When prompted, insert the original Windows NT installation CD and enter d:\i386 (where d: is the drive letter of your CD drive), and click *Continue*.
9. Click *Close*.
10. Click *Yes* when prompted to restart your system.

Configuring TCP/IP

1. On the Start menu, choose *Settings*, then choose *Control Panel*.
2. Double-click the *Network* icon. The Network dialog box appears.
3. Click the *Protocols* tab.
4. Select *TCP/IP protocol*.
5. Click *Properties*.
6. Select *Obtain an IP address from a DHCP server*.
7. Click the *DNS* tab.
8. Check if any DNS addresses are configured. If so, delete them.
9. Click *OK*.

Configuring TCP/IP on an iMac

Set up TCP/IP on an iMac as follows:

1. On the Apple menu, select *Control Panels*.
2. Select *TCP/IP*.
3. Set *Connect via* to *Ethernet*.
4. Set *Configure* to *Using DHCP Server*.

Appendix B

Technical Information

This appendix provides detailed technical information on the DIVA LAN ISDN Modem.

DIVA LAN ISDN Modem indicator lights

The front panel lights show you the status of the DIVA LAN ISDN Modem.

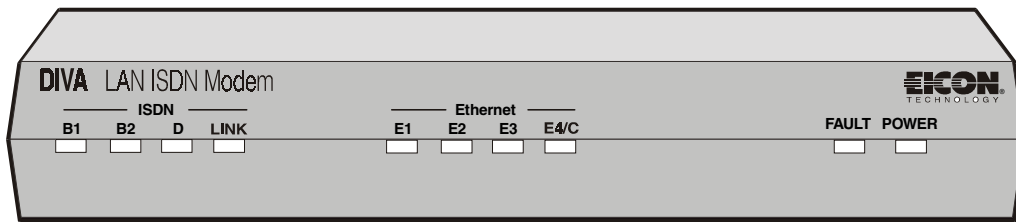

B1, B2

Indicates the status of the B-channels.

State	Description
Green	Indicates a data call.
Orange	Indicates a phone call.
Off	No call activity on the specified B-channel.
Flashing	An incoming or outgoing call is being established on the B-channel.
Steady	A call is connected and the channel is in use.

D

Indicates the status of the ISDN D-channel.

State	Description
Off	The ISDN physical interface is not active. The LINK light may provide additional information.
Flashing	Indicates that the ISDN physical interface is initializing. Flashing stops when initialization is complete. Continuous flashing indicates an error in the initialization process (usually due to incorrectly entered SPIDs). Data transmission may not be possible on the D- or B-channels until the problem is resolved. The console port can be used to further diagnose the problem. If you are using AO/DI, continuous flashing indicates that the DIVA LAN ISDN Modem cannot establish the X.25 data link layer on the D-channel.
Steady	The ISDN physical interface has been initialized and is ready to place or receive calls on the D- and B-channels.

LINK

Indicates the status of the ISDN physical interface.

State	Description
Off	The ISDN physical interface is not synchronized, or is improperly connected. Check your ISDN cable.
Flashing	The ISDN physical interface is synchronizing. Continuous flashing indicates a problem with the ISDN line: <ul style="list-style-type: none"> • Make sure that the line is plugged in and that you are using the correct interface (S/T or U). • Check your termination requirements. See “Termination” on page 161.
Steady	The ISDN physical interface is active. Lights D, B1, and B2 may provide additional status information.

E1, E2, E3, E4

Indicates the status of the four ETHERNET ports.

State	Description
Off	There is no device connected to the specified ETHERNET port, or the connected device is not powered on.
Flashing	Data is being received on the specified ETHERNET port.
Steady	There is a device connected to the specified ETHERNET port and the link is up.

/C

Indicates the status of Ethernet collisions in red.

State	Description
Off	No collisions
Flashing	Indicates that an Ethernet collision has occurred because two Ethernet devices connected to the DIVA LAN ISDN Modem are trying to transmit at the same time. This is a normal occurrence and will automatically resolve itself.
Steady	Indicates that one of the Ethernet ports has encountered too many physical layer errors to continue normal operation. The device connected to this port will not be able to send or receive data. Reset the port by temporarily unplugging the cable connected to it.

FAULT

State	Description
Off	The modem is operating normally.
Flashing	A hardware fault has occurred. Contact your Eicon Technology representative.
Steady	A software fault has occurred. Contact your Eicon Technology representative.

POWER

State	Description
Off	The unit is off.
Steady	The unit is on.

DIVA LAN ISDN Modem connectors

The back panel is where you connect your equipment to the DIVA LAN ISDN Modem.

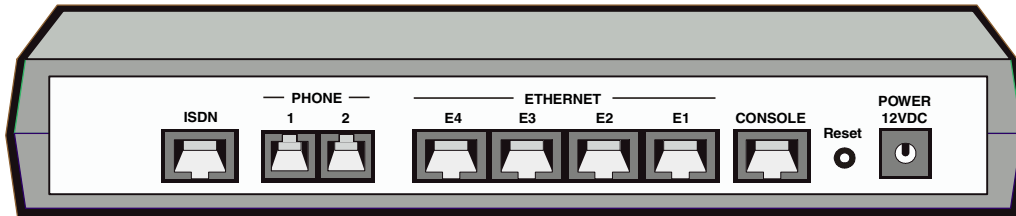

Port	Description
ISDN	Use this RJ-45 port to connect the DIVA LAN ISDN Modem to the ISDN line jack. An RJ-45 to RJ-11 cable is included for this purpose.
Phone 1, 2	Use these RJ-11 ports to connect analog devices such as telephones or fax machines.
Ethernet E1, E2, E3, E4	Use these RJ-45 ports to connect the Ethernet cables for up to four computers. An RJ-45 to RJ-45 cable is supplied so you can connect one computer to configure the DIVA LAN ISDN Modem.
CONSOLE	If you do not have an Ethernet card, you can use this port to configure the DIVA LAN ISDN Modem. A special cable is included that lets you connect this RJ-45 port to a DB-9 serial port on a computer.
RESET	Press this button to re-initialize the DIVA LAN ISDN Modem.
POWER 12VDC	Use this jack to connect the supplied AC adapter.

Resetting the DIVA LAN ISDN Modem

The Reset button is located on the back of the DIVA LAN ISDN Modem.

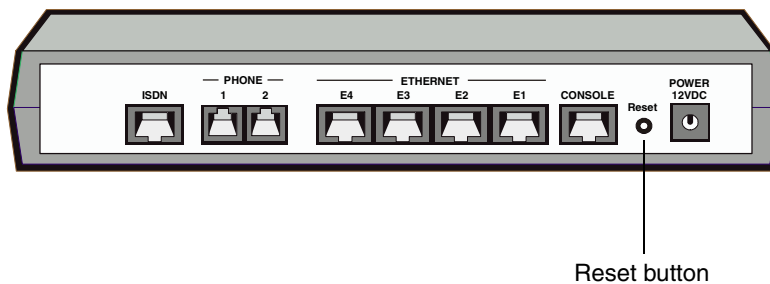

Two reset options are available:

Resetting operational settings

Use this to activate configuration settings you have made.

To reset

- Press and release the Reset button quickly. All the ISDN lights and the Fault light will flash, followed by all the ETHERNET lights. The lights then return to normal operation.

Using this option is equivalent to clicking the Reset button on the Configuration main menu in the Web-based configuration interface (page 48).

Resetting to factory defaults

Use this option to reset the DIVA LAN ISDN Modem to its factory default settings. Resetting to factory defaults erases the system password and returns all parameter setting to their defaults. You can use the web-based configuration interface to back up your configuration settings before you reset.

To reset

- Press and hold the reset button for 15 seconds.
- All lights (except POWER) will go out.
- After five seconds, the B1 and B2 indicator lights will turn red.
- Continue to hold the reset button until these lights go off. If you let go before the lights go off, you may not completely reset the DIVA LAN ISDN Modem and you may not be able to communicate with it.

You can also reset to factory defaults using:

- the Web-based configuration interface (page 160)
- the command line interface (page 146)
- a touch tone phone (page 145)

Termination

If you are in North America or Australia and you are installing a DIVA LAN ISDN Modem with an S/T interface, you must connect the terminating resistor to ensure the proper operation of your equipment.

Determining termination requirements

Termination requirements vary depending on the number of devices connected to an external NT1 and the distance between these devices and the NT1.

Single ISDN device

If the DIVA LAN ISDN Modem is the only device connected to the external NT1, then determine the length of the cable linking the two devices.

If the cable is longer than 75 meters (250 feet):

- Connect the included terminating resistor.
- Set the NT1 to provide 100 ohms of resistance. Consult the manual provided with the NT1 for more detailed instructions.

Note *Some NT1s do not support connections over 75 meters (250 feet). Check your user documentation to determine the distance supported.*

If the cable is shorter than 75 meters (250 feet):

- Do not connect the included terminating resistor.
- Set the NT1 to provide 50 ohms of resistance. Consult the manual provided with the NT1 for more detailed instructions.

Multiple ISDN devices

If the NT1 is connected to more than one ISDN device, determine the length of cable connecting the DIVA LAN ISDN Modem to the NT1.

If the cable is longer than 75 meters (250 feet):

- Connect the included terminating resistor.
- Set the other ISDN devices to 100 ohms of resistance. Consult the manuals provided with these devices for more detailed instructions.
- Set the NT1 to no termination. Consult the manual provided with the NT1 for more detailed instructions.

Note *Some NT1s do not support connections over 75 meters (250 feet). Check your user documentation to determine the distance supported.*

If the cable is shorter than 75 meters (250 feet):

- Do not connect the included terminating resistor.
- Set the other ISDN devices to no termination. Consult the manuals provided with these devices for more detailed instructions.
- Set the NT1 to provide 50 ohms of resistance. Consult the manual provided with the NT1 for more detailed instructions.

Installing the resistor

If termination is required, install the 100 ohm terminating resistor that is included in your package as follows:

1. Insert the RJ-45 end of the ISDN cable into the resistor

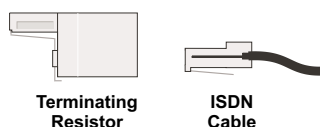

2. Insert the resistor into the ISDN wall outlet.

Command Line Reference

This appendix provides a description for each CLI command. The commands are grouped according to functionality.

Notational Conventions

The section uses the following conventions:

Syntax Example	Description
Cancel	Boldface type indicates the name of an item (a parameter name, command button, menu option, etc.) you need to select or perform an action on.
RESET	UPPERCASE TYPE indicates keywords. The actual words can be entered in either uppercase or lowercase.
[/C n]	Items enclosed in square brackets are optional. You can either include them or not. Do not enter the brackets. If the items are separated by vertical bars, you must choose one of the items. Enter only one item. Do not enter the vertical bar.
<i>numHops</i>	Items in lowercase italic type are user-supplied input. Replace these items with values appropriate to your system.
{ THIS THAT }	Two or more items enclosed in braces and separated by a vertical bars means you must choose one item. Enter only one item. Do not enter the vertical bar.

For example, if a command is presented as:

```
SET DHCP LEASEDURATION duration { MINS | HOURS | DAYS }
```

the following can be concluded:

SET DHCP LEASEDURATION	Enter as shown.
<i>duration</i>	Replace <i>duration</i> with a value you supply.
{ MINS HOURS DAYS }	Use one of these three choices.

For example: SET DHCP LEASEDURATION 10 HOURS

Commands

For information on:	See page:
AO/DI	165
Callback	166
Call screening	167
Call thresholds	168
DHCP	169
DNS	172
Ethernet	173
General	174
IP filters	177
IP NAT	180
IP routing	181
IP various	182
ISDN	184
ISDN Access Time	187
LAPD	188
Logging and Mail Trace	189
MLPPP	190
Phone	191
PPP	194
Profiles	197
Q.931	198
RIP	199
SNMP	201
TCP	202
TFTP	203
Time Protocol	204
UDP	205
V.120	206
V.120 Scripting	208
X.25	209

AO/DI

ENABLE AODI AREACODE

Valid context: *Profile/PPP*

Enables or disables use of the area code when making an AO/DI call. When enabled, the DIVA LAN ISDN Modem uses the area code when dialing a remote site. When disabled, it does not.

DISABLE AODI AREACODE

Valid context: *Profile/PPP*

SET AODI DIALPREFIX dialstr

Valid context: *Profile/PPP*

Specifies the prefix to dial when making an AO/DI call. For example, 1 to call long distance, or 9 to obtain an external line.

SET AODI TXBUFFER bytes

Valid context: *Profile/PPP*

Specifies the transmit queue threshold for X.25 on the D-channel when using AO/DI.

When queued data exceeds this limit, for the period of time specified with `"SET MLPPP LINKUP delay\"`, the 1st B-channel is added to the AO/DI connection. Range = 100 to 10000

Callback

SET CALLBACK MODE type option [number1 number2]

Valid context: *Profile/PPP*

Several callback modes are available. Each provides different features. For callback to work, both client and server must use the same mode. The DIVA LAN ISDN Modem can only function as a callback client.

type: NONE, NCP, ISDN

NONE: No callback.

NCP: Supports both the USERSPEC and ADMIN SPEC options. This is a Microsoft-developed solution. It is used by NT4, and devices from Cisco, Ascend, and other vendors. NCP enables you to specify a time delay before the server calls back.

ISDN: The server does not answer the initial call from the DIVA LAN ISDN Modem (thus there is no charge for the call). The remote uses caller ID information to return the call. Only works with Cisco IOS.

option: USERSPEC, ADMIN SPEC

USERSPEC: (user specified) The DIVA LAN ISDN Modem must supply the server with the callback number to use. The number must include the appropriate dialing prefixes.

ADMIN SPEC: (administer specified) The DIVA LAN ISDN Modem does not supply the server with a number to dial, instead the server maintains its own table of numbers. The server identifies the DIVA LAN ISDN Modem by its caller ID or user ID (supplied during call authentication). The server then uses this information to determine which number to dial for callback.

number1: USERSPEC only. This is the first number that the server dials when calling back. It should be the first ISDN number assigned to the DIVA LAN ISDN Modem, and include all required dialing pre-fixes.

number2: USERSPEC only. This is the second number that the server dials when calling back. For example, if you have two ISDN numbers, and you want to establish an MLPPP connection, the server must call in twice, once to establish each channel.

SET CALLBACK TIMEOUT seconds

Valid context: *Profile/PPP*

Sets the amount of time the DIVA LAN ISDN Modem waits for the server to call back. During this time, the DIVA LAN ISDN Modem will refuse incoming calls that are not from the callback server on the phone number that was configured for callback.

seconds: Length of delay in seconds. Range: 20 to 240. Default: 30.

SET CALLBACK DELAY seconds

Valid context: *Profile/PPP*

Callback control protocol only. Sets the amount of time the server waits before calling back. The DIVA LAN ISDN Modem proposes the delay during callback negotiation. The server can either accept or reject it.

seconds: Length of delay in seconds. Range: 1 to 30. Default: 5.

SHOW CALLBACK CONFIGURATION

Valid context: *Profile/PPP*

Displays the current setting of all callback parameters for the current profile.

Call screening

ADD ISDN SCREENING channel number

Valid context: *General*

Adds a number to the call screening table. When call screening is enabled, an incoming data call is only accepted if its number appears in the call screening table.

Use this command to add a number to the call screening table.

channel: ISDN number to screen calls on. Range 1 to 2.

number: ISDN telephone number to screen for. Enter up to 20 digits. Call screening does not support subaddresses.

DELETE ISDN SCREENING channel index

Valid context: *General*

Removes an ISDN number from the call screening table.

channel: ISDN channel to screen the number on. Range 1 to 2.

index: Index number of the table entry to delete. Range: 1 to 10.

ENABLE ISDN SCREENING

Valid context: *General*

Enables or disables ISDN call screening. When enabled, an incoming data call is only accepted if its number appears in the call screening table.

DISABLE ISDN SCREENING

Valid context: *General*

SHOW ISDN SCREENING

Valid context: *General*

Displays the ISDN call screening table. When call screening is enabled, an incoming data call is only accepted if its number appears in the call screening table.

Call thresholds

SET ISDN THRESHOLD intervalDays maxHours maxCalls

Valid context: *General*

Limits usage of the ISDN line based on number of calls or time connected during a specified interval.

intervalDays: Number of days in the interval. Range: 1 to 31 days.

maxHours: Maximum number of hours a profile can be connected during the interval. Range: 0 (disabled), 1 hour to (24 * intervalDays) hours.

maxCalls: Maximum number of calls a profile can make during the interval. Range: 0 (disabled), 1 to 1000.

ENABLE ISDN THRESHOLD DISABLE ISDN THRESHOLD

Valid context: *General*

Enables or disables ISDN threshold monitoring. When enabled, the DIVA LAN ISDN Modem limits usage of the ISDN line for each profile during the specified threshold monitoring interval. This lets you limit your ISDN usage charges.

When a profile exceeds a threshold limit, all profiles are disabled. You must reset the DIVA LAN ISDN Modem to re-activate the profiles. This also resets the threshold interval.

DHCP

SET DHCP TYPE { SERVER | NONE}

Valid context: *General*

Sets the type of DHCP services the DIVA LAN ISDN Modem will supply. DHCP server is active by default.

SERVER: As a DHCP server, the DIVA LAN ISDN Modem is responsible for assigning IP addresses when it receives a DHCP request from a network device.

NONE: No DHCP services are supplied.

SHOW DHCP STATUS

Valid context: *General*

Displays DHCP status and the list of IP addresses that are currently defined.

SET DHCP IPRANGE startIpaddress range

Valid context: *General*

Defines the pool of addresses the DIVA LAN ISDN Modem uses to assign dynamic addresses from when it is operating as a DHCP server.

startIpaddress: Starting address for the pool. This address must be on the same network as the LAN IP address. Default: 192.168.1.1.
range: Number of addresses in the pool. Range: 1 to 50. Default: 50.

Defines the maximum number of addresses in the dynamic DHCP address pool. Range: 1 to 50. Default: 50.

SET DHCP LEASEDURATION duration MINS | HOURS | DAYS

Valid context: *General*

Defines the length of time a client address assigned by the DIVA LAN ISDN Modem is valid. Range: 30 minutes to 30 days.

SET DHCP DNS {PRIMARY | SECONDARY} DNSaddr

Valid context: *General*

Defines the IP address of the primary and secondary DNS servers that DIVA LAN ISDN Modem returns to DHCP clients when it is acting as a DHCP server. This is the server the clients will use as their DNS server. By default, the Primary DNS is set to 192.168.1.1, which is the address of the DIVA LAN ISDN Modem.

PRIMARY: Primary DNS server.

SECONDARY: Secondary DNS server.

DNSaddr: IP address of the DNS server. Default: 192.168.1.1 (the DIVA LAN ISDN Modem)

SET DHCP WINS {PRIMARY | SECONDARY} WINaddr

Valid context: *General*

Defines the IP address of the primary and secondary WINS servers that the DIVA LAN ISDN Modem returns to DHCP clients when it is acting as a DHCP server. This is the server the clients will use as their WINS server.

PRIMARY: Primary WINS server.

SECONDARY: Secondary WINS server.

WINSaddr: IP address of the WINS server.

SET DHCP DOMAIN domain

Valid context: *General*

Specifies the domain name returned by the DIVA LAN ISDN Modem when acting as a DHCP server in response to a DHCP request.

domain: Domain name as a string of up to 31 characters.

SHOW DHCP CONFIGURATION

Valid context: *General*

Displays the setting of all DHCP related parameters.

SET DHCP SERVERADDR {PRIMARY | SECONDARY} DHCPAddr

Valid context: *General*

Defines the address of the DHCP servers the DIVA LAN ISDN Modem forwards DHCP requests to when acting as a DHCP relay agent.

Primary: Primary DHCP server.

Secondary: Secondary DHCP server.

DHCPAddr: IP address of the DHCP server.

SHOW DHCP TRACE [memsize [framesize]]

Valid context: *General*

Starts or displays an already started DHCP trace for an ISDN channel.

memsize: The amount of RAM reserved to store the trace on the DIVA LAN ISDN Modem. Range: 1 to 63 KB . Default: 16 KB

framesize: The number of characters to display in each frame.

STOP DHCP TRACE

Valid context: *General*

Stops an active DHCP trace.

ADD DHCP STATICMAP ipAddress MACAddr

Valid context: *General*

Adds a new entry to the STATICMAP table. This table contains the list of static IP address assignments used by the DIVA LAN ISDN Modem when it is acting as a DHCP server. Each entry defines an IP address and IP mask for a specific MAC address.

ipAddress: IP address in dotted-decimal notation.

MACAddr: MAC (Ethernet) address of the target device. This address must be 12 hexadecimal digits separated by colons, commas, or hyphens. For example: 11:22:33:44:55:66

SET DHCP STATICMAP ip macaddr

Valid context: *General*

Modifies the definition of an existing entry in the STATICMAP table. See ADD DHCP STATICMAP for complete details.

ipAddress: IP address of the entry to modify.

MACAddr: New value for the Mac (Ethernet) address of the target device. MAC address must be 12 hexadecimal digits separated by colons as follows:

11:22:33:44:55:66

DELETE DHCP STATICMAP ip

Valid context: *General*

Deletes an entry from the STATICMAP table. See ADD DHCP STATICMAP for complete details.

ipAddress: IP address of the entry to delete.

SHOW DHCP STATICMAP

Valid context: *General*

Displays the list of defined static DHCP addresses. See ADD DHCP STATICMAP for complete details.

**ENABLE DHCP STATICMAP ip
DISABLE DHCP STATICMAP ip**

Valid context: *General*

Enables or disables support for static address assignment when the DIVA LAN ISDN Modem is acting as a DHCP server. See ADD DHCP STATICMAP for complete details.

DNS

SET DNS DOMAIN domain

Valid context: *Profile*

When DNS relay is enabled, the DIVA LAN ISDN Modem checks each DNS request to see if it matches this name. If so, the DIVA LAN ISDN Modem establishes the connection defined by this profile, and forwards the request.

domain: Domain name or * to match any name.

Range: Up to 32 characters.

SET DNS ADDRESS {PRIMARY | SECONDARY} dnsaddr

Valid context: *Profile*

Specifies the address of the DNS server the DIVA LAN ISDN Modem routes DNS requests to when DNS Relay is enabled.

PRIMARY: First DNS server to route requests to.

SECONDARY: Second DNS server. Only used when the PRIMARY does not reply.

dnsIpaddr: IP address of the server.

ENABLE DNS RELAY DISABLE DNS RELAY

Valid context: *General*

When enabled, the DIVA LAN ISDN Modem forwards all DNS requests to a remote DNS server. It does this by matching the requested domain against the domain name assigned to each profile. If a match is found, the profile is connected and the DNS request is forwarded. DNS relay is enabled by default.

SHOW DNS CONFIGURATION

Valid context: *General*

Displays all DNS configuration settings.

Ethernet

SHOW ETHERNET STATISTICS

Valid context: *General*

Displays Ethernet statistics.

SHOW ETHERNET ADDRESS

Valid context: *Profile*

Displays the Ethernet address of the DIVA LAN ISDN Modem. You must be in the LAN profile to issue this command.

SHOW ETHERNET TRACE [memsize [framesize]]

Valid context: *General*

Starts or displays an Ethernet trace.

memsize: The amount of RAM reserved to store the trace on the DIVA LAN ISDN Modem. Range: 1 to 63 KB . Default: 16 KB

framesize: Number of characters to show for each frame.

STOP ETHERNET TRACE

Valid context: *General*

Stops an active Ethernet trace.

General

MONITOR

Valid context: *General*

Invokes monitor mode. Use monitor mode to upload new firmware or to dump system memory for debugging purposes. You can set the DIVA LAN ISDN Modem to automatically invoke monitor mode when a fatal error occurs by issuing the SET ONERROR command.

NEXT

Valid context: *Filter*

Makes the next IP filter the current context so you can edit it.

PREVIOUS

Valid context: *Filter*

Makes the previous IP filter the current context so you can edit it.

PING Ipaddr [number] [size]

Valid context: *General*

Lets you determine if an IP address is reachable.

Ipaddr: IP address of device to PING.

number: Number of messages to send. Range: 1 to no limit. Default: 4

size: size of the message in bytes. Range: 1 to 1472. Default: 64

RESET [FACTORY | HUB]

Valid context: *General*

Resets the DIVA LAN ISDN Modem.

FACTORY: Resets the DIVA LAN ISDN Modem and returns all parameters to their factory default settings. Deletes all user-defined profiles and the password.

HUB: Resets only the Ethernet ports.

LOGOUT

Valid context: *General*

Closes the current configuration session.

SET ONERROR {HALT | RESET}

Valid context: *General*

Defines how the DIVA LAN ISDN Modem reacts when it encounters a fatal error and cannot continue to operate normally.

HALT: Activate monitor mode when a fatal error is encountered. The fault LED will be lit.

RESET: Reset the system when fatal error is encountered.

SAVE [profileName]

Valid context: *General*

Saves the current configuration settings to non-volatile memory on the DIVA LAN ISDN Modem. If you do not save your changes, they will be lost when you power-off or reset the DIVA LAN ISDN Modem.

VALIDATE

Valid context: *General*

Validates the current configuration by running a series of tests. Validate helps you determine if the DIVA LAN ISDN Modem is properly configured.

SET TIME hh:mm[:ss]

Valid context: *General*

Sets the internal system clock.

hh: Hours. Range: 0 to 24.

mm: Minutes. Range 00 to 59.

ss: Seconds. Range 00 to 59.

SET DATE yy[yy]-mm-dd

Valid context: *General*

Sets the internal system date. For example: yyyy-mm-dd

mm: Month. Range: 1 to 12.

dd: Day. Range: 1 to 31.

yy[yy]: Year can be entered as either two or four digits. A two-digit year less than 80 is assumed to be after the year 2000.

SHOW DATE

Valid context: *General*

Displays the current system date and time.

**ENABLE DISPLAY
DISABLE DISPLAY**

Valid context: *General*

Enables or disables display of the status bar. The status bar is only available if your terminal supports VT100 emulation. By default, it is disabled.

Valid context: *General*

SET PASSWORD password

Valid context: *General*

Sets the password that users need to specify when logging on to a DIVALAN ISDN Modem configuration interface. Specify up to 11 alphanumeric characters. Spaces are not allowed. The password is case-sensitive, which means \"PASS\" and \"pass\" are not the same.

SHOW TIME

Valid context: *General*

Displays the system date and time.

SHOW STATUS

Valid context: *General*

Displays general information about the DIVA LAN ISDN Modem.

SHOW LED STATUS

Valid context: *General*

Displays the current status of the DIVA LAN ISDN Modem LEDs. For example:

LED Status

B1	B2	D	LINK	E1	E2	E3	E4/C	FAULT	POWER
On	Off	On	On	Flash	Flash	Off	*Flash	Off	On

A * next to an On indicates that the LED color is NOT green. It could be orange or red.

SET SYSTEM NAME name

Valid context: *General*

Defines the SNMP name of the DIVA LAN ISDN Modem. Enter up to 29 alphanumeric characters.

SHOW SYSTEM STATUS

Valid context: *General*

Displays system information: memory, firmware version, etc.

SHOW VERSION

Valid context: *General*

Displays system information: memory, firmware version, etc.

SET HOSTNAME name

Sets the domain name of the DIVA LAN ISDN Modem. This is also the address of the home page of the Web-based configuration interface. The text `\.lanmodem\` is appended to whatever name you enter. Default: `diva` (i.e., `diva.lanmodem`). Range: Up to 32 characters.

SHOW CALLS STATUS [ACTIVE | LAST]

Valid context: *General*

Shows status information for an ISDN call.

ACTIVE: The active call.

LAST: The last call.

SHOW CALLS STATISTICS

Valid context: *Profile/PPP*

Show statistics information for the active call or the last call.

IP filters

ADD IP FILTER filterNum

Valid context: *Profile*

Adds a new IP filter to the list at the specified position. This enables you to insert a filter at any point in the list.

filternum: Position to add the new filter.

DELETE IP FILTER filterNum

Valid context: *Profile*

Delete an IP filter.

filterNum: Number of the IP filter to delete.

ENABLE FILTER DISABLE FILTER

Valid context: *Filter/Profile*

Enables or disables IP filters. In Profile context, this applies to all filters defined for the profile. In Filter context, this applies only to filters defined for the current filter.

COPY FILTER filterNumber

Valid context: *Filter/Profile*

Copies an existing filter to the current filter. Only available in the filter context.

filterNumber: Number of the IP filter to copy.

SET ACTION {DROP | FORWARD}

Valid context: *Filter*

Sets the action this filter takes when it encounters data that matches the filter setting.

DROP: Discard the data.

FORWARD: Forward the data to the next filter.

SET DIRECTION {IN | OUT | ANY}

Valid context: *Filter*

Sets whether the filter applies to incoming or outgoing data.

IN: Filter applies to incoming data only.

OUT: Filter applies to outgoing data only.

ANY: Filter applies to all data. Default setting.

SET IP SOURCE Ipaddr netMask

Valid context: *Filter/Profile*

Sets the source address and network mask for the filter. Only data which originates from the specified address and network is processed by this filter.

Ipaddr: Source IP address of data to filter.

netMask: Source network mask of data to filter.

SET IP DESTINATION Ipaddr netMask

Valid context: *Filter/Profile*

Sets the destination address and network mask for the filter. Only data which is destined for the specified address and network is processed by this filter.

Ipaddr: Destination IP address of data to filter.

netMask: Destination network mask for data to filter.

SET UDP SOURCE lowPort highPort

Valid context: *Filter*

Sets the minimum and maximum source UDP ports for which this filter will process data.

lowPort: Minimum UDP port number of data to filter. Range: 0 to highPort. Default 0.

highPort: Maximum UDP port number of data to filter. Range lowPort to 65535. Default 65535.

SET UDP DESTINATION lowPort highPort

Valid context: *Filter*

Sets the minimum and maximum destination UDP ports for which this filter will process data.

lowPort: Minimum UDP port number of data to filter. Range: 0 to highPort. Default 0.

highPort: Maximum UDP port number of data to filter. Range lowPort to 65535. Default 65535.

SET TCP SOURCE lowPort highPort

Valid context: *Filter*

Sets the minimum and maximum source TCP ports for which this filter will process data.

lowPort: Minimum TCP port number of data to filter. Range: 0 to highPort. Default 0.

highPort: Maximum TCP port number of data to filter. Range lowPort to 65535. Default 65535.

SET TCP DESTINATION lowPort highPort

Valid context: *Filter*

Sets the minimum and maximum destination TCP ports for which this filter will process data.

lowPort: Minimum TCP port number of data to filter. Range: 0 to highPort. Default 0.

highPort: Maximum TCP port number of data to filter. Range lowPort to 65535. Default 65535.

SET IP FILTER filterNum

Valid context: *Profile*

Makes the specified filter the active context so you can edit it.

filterNum: Number of the IP filter to edit.

SHOW IP FILTER

Valid context: *Filter/Profile*

Display all IP filters for the current profile. Or if in a Filter, only those filters that are defined for the current filter.

SET TYPE {ALL | UDP | TCP | SYN | ANYICMP}

Valid context: *Filter*

Sets the type of data this filter applies to.

ALL: This filter applies to all data.

UDP: This filter applies to UDP data.

TCP: This filter applies to TCP data. Default setting.

SYN: This filter applies to TCP connection (SYN) data.

ANYICMP: This filter applies to all ICMP data.

ICMP: This filter applies to specific ICMP data only (as set by type)

type: ICMP type to filter.

IP NAT

ENABLE IP NAT DISABLE IP NAT

Valid context: *Profile*

Enables or disables NAT (network address translation) for this profile. NAT allows the DIVA LAN ISDN Modem to use only one IP address when communicating with remote sites via the ISDN port. NAT is enabled by default.

SHOW IP NAT

Valid context: *General*

Displays the IP NAT table, which contains the settings for all computers on the internal LAN that are visible to the external network.

ADD IP NAT {UDP | TCP} port ipaddress

Valid context: *General*

Allows a computer on the internal LAN to be visible to the external network

for a particular protocol. For example, if you want an internal computer to function as a SMTP (E-mail) server, set TCP to port 25 and enter the IP address of the computer.

UDP: Use the UDP protocol.

TCP: Use the TCP protocol.

port: Port to use.

ipaddress: IP address of the computer on the internal LAN.

DELETE IP NAT {UDP | TCP} port

Valid context: *General*

Deletes the specified entry in the IP NAT table.

UDP: UDP protocol.

TCP: TCP protocol.

port: Port being used.

DEFAULT: The IP address that the DIVA LAN ISDN Modem forwards unresolved incoming datagrams to.

ipaddress: IP address of the computer on the internal LAN.

SET IP NAT {UDP | TCP | DEFAULT} port address

Valid context: *General*

Allows a computer on the internal LAN to be visible to the external network

for a particular protocol. For example, if you want an internal computer to function as a SMTP server set TCP to port 25 and enter the IP address of the computer.

UDP: Use the UDP protocol.

TCP: Use the TCP protocol.

DEFAULT: The IP address that the DIVA LAN ISDN Modem forwards unresolved incoming datagrams to.

port: Port to use.

address: IP address of the computer on the internal LAN.

IP routing

ADD IP ROUTE Ipaddr maskLen[:metric] [gwAddr]

Valid context: *Profile*

Adds a static IP route.

Ipaddr: Specifies the IP address of datagrams that should be routed.

maskLen: Lets you specify the number of bits that are checked when comparing the address of a datagram to that specified by the Ipaddr parameter. Range: 0 to 32.

metric: Metric determines the weight of a route. If two identical routes exist, then the DIVA LAN ISDN Modem uses the route with the lower metric. Default value: 1 Range: 1 - 15, 16 (never use this route).

gwAddr: Specifies the IP address of the device to forward datagrams to if a match is found.

DELETE IP ROUTE Ipaddr

Valid context: *General*

Deletes an IP route.

Ipaddr: Address of the IP route to delete.

SET IP ROUTE Ipaddr maskLen [gwAddr]

Valid context: *General*

Modifies the mask and gateway address for an existing IP route. See ADD IP ROUTE for more information.

Ipaddr: The IP address of the existing route to change.

maskLen: New setting for mask length. Range: 0 to 32

gwAddr: New setting for gateway address.

SHOW IP ROUTE

Valid context: *General*

Displays all defined static and dynamic IP routes.

IP various

SHOW ICMP STATISTICS

Valid context: *General*

Displays ICMP statistics.

SET IP REMOTE Ipaddr

Valid context: *Profile*

Sets the IP address of the remote device this profile connects to. Use this only in cases when a static IP address is assigned to the remote site. In most cases, specify 0.0.0.0 to allow dynamic negotiation of the address when the connection is established.

Dynamic negotiation is not supported by the LAN profile.

SET IP ADDRESS Ipaddr

Valid context: *Profile*

Sets the IP address this profile should use in cases when a static address is assigned to the DIVA LAN ISDN Modem by your ISP or network administrator. In most cases, specify 0.0.0.0 to allow dynamic negotiation when the connection is established.

Dynamic negotiation is not supported by the LAN profile.

SHOW IP ADDRESS

Valid context: *General*

Displays the current IP addresses for the DIVA LAN ISDN Modem. The addresses

you see might not be those that are defined, but rather those as negotiated by IP. For example, if an IP address is set to 0, it is negotiated to a new value when the device connects. This command only displays the addresses that apply to the current profile, or all addresses if executed from the general context.

SET IP BACKUP profilename

Valid context: *Profile*

Specifies the backup profile to use when this profile cannot connect. The backup profile is invoked when the maximum number of connection retries has been exceeded.

SET IP DESCRIPTION description

Valid context: *Profile*

Sets the description for this IP interface.

description: 39 alphanumeric characters.

SET IP MASK Ipaddr

Valid context: *Profile*

Sets the subnet mask for this profile.

SHOW IP STATISTICS

Valid context: *General*

Displays statistics for the IP protocol.

SHOW IP STATUS

Valid context: *General*

Displays IP status information and all configured IP addresses.

SHOW IP CONFIGURATION

Valid context: *General*

Displays IP configuration settings.

SET IP SERVICES {ALL | INTELLIGENT | MINIMAL | NONE}

Valid context: *General*

Defines the level of support the DIVA LAN ISDN Modem provides for Microsoft NetBIOS services (which are integrated into Microsoft TCP/IP). NetBIOS is required to support Microsoft Windows Network Neighborhood, the MAP NETWORK option in Windows Explorer, and various DOS-based networking commands (such as net use, net view, and net logon).

ALL: The DIVA LAN ISDN Modem forwards all NetBIOS traffic to the remote site. May result in substantial ISDN charges unless you have a flat rate connection.

INTELLIGENT: Provides full support for all Network Neighborhood functions, but spoofs unnecessary traffic to reduce usage of the ISDN line.

MINIMAL: Reduces NetBIOS traffic to a minimum. Does not support Network Neighborhood functions. However, does support the MAP NETWORK option in Windows Explorer and DOS-based networking commands such as net use, net view, and net logon. Most economical solution.

NONE: The DIVA LAN ISDN Modem discards all NetBIOS traffic. NetBIOS services are not supported across the ISDN link.

ENABLE IP SPOOFING DISABLE IP SPOOFING

Valid context: *General*

Enables or disables spoofing. When enabled, the DIVA LAN ISDN Modem does the following:

- spoofs all TCP keep alive datagrams
- spoofs all Microsoft Server Message Block datagrams
- drops all NetBIOS over IP name service traffic

ENABLE IP MULTICAST DISABLE IP MULTICAST

Valid context: *Profile*

Enables or disables support for IP multicasting. When disabled (default settings), the DIVA LAN ISDN Modem does not forward IP multicast datagrams from the WAN onto the LAN. To allow computers on the Ethernet LAN to subscribe to services that use IP multicasting as a delivery mechanism, you must enable this option.

ENABLE IP MANUALDIAL DISABLE IP MANUALDIAL

Valid context: *Profile*

Enables or disables manual dialing of this profile. When enabled, the DIVA LAN ISDN Modem will not automatically connect the profile when data needs to be sent. Instead, you must manually connect the profile.

Use the Dial command to do this.

ENABLE IP UNNUMBERED DISABLE IP UNNUMBERED

Valid context: *Profile*

Enables or disables IP unnumbered mode for this profile. Permits you to save an IP address by using the same IP address for the DIVA LAN ISDN Modem on both the Internet and internal LAN. Only valid if NAT is not enabled.

ISDN

ENABLE ISDN TEISHARING DISABLE ISDN TEISHARING

Valid context: *General*

Enables or disables the sharing of TEI assignments. Some switches only make two TEIs available for an ISDN line. Therefore, if you are using AO/DI, enable this option. This shares the TEI between channels B1 and D.

TEISHARING is disabled by default and is only available if TEI assignment is dynamic (SET ISDN TEI DYNAMIC).

ENABLE ISDN ANSWER DISABLE ISDN ANSWER

Valid context: *General*

Specifies if the DIVA LAN ISDN Modem will answer incoming ISDN data calls. If disabled, incoming data calls are ignored. This parameter is disabled by default.

SET ISDN BILLINTERVAL initialTime recurringTime

Valid context: *General*

Allows you to minimize your ISDN charges by controlling the frequency with which the DIVA LAN ISDN Modem will enable and disable an ISDN channel.

initialTime: The minimum amount of time that an ISDN channel will be enabled for. Range: 0 to 1800 seconds. Default: 60 seconds.

recurringTime: The minimum amount of time that an ISDN channel remains enabled after initialTime is surpassed. Range: 10 to 1800 seconds. Default: 60 seconds.

SET ISDN DN channel isdnNumber [DATA]

Valid context: *General*

Sets your ISDN telephone number. ISDN telephone numbers are defined by your ISDN provider to identify your ISDN equipment. Enter 20 digits followed by a dot followed by a 20 digit subaddress (optional). Note that the following three characters will be removed after the number is entered: hyphen, space, parenthesis.

channel: First or second ISDN number. Range: 1 to 2.

isdnNumber: ISDN phone number.

DATA: International version only. Enables enhanced support for data traffic on the selected port. Throughput is increased, but supplementary calling services are not supported.

SET ISDN TELEPHONE channel isdnNumber

Valid context: *General*

This command is an alias for SET ISDN DN.

SET ISDN TELEPHONE channel isdnNumber [DATA]

Valid context: *General*

This command is an alias for SET ISDN DN.

SET ISDN REMOTE channel isdnNumber

Valid context: *Profile/PPP*

Sets the remote ISDN numbers the DIVA LAN ISDN Modem should dial when making calls for this profile.

channel: ISDN channel. Range: 1 to 2.

isdnNumber: ISDN number.

SET ISDN BACKUP channel isdnNumber

Valid context: *Profile/PPP*

Sets the remote backup ISDN numbers the DIVA LAN ISDN Modem should dial when the remote numbers failed to connect.

channel: ISDN channel. Range: 1 to 2.

isdnNumber: ISDN number.

DETECT ISDN SPID

Valid context: *General*

Before you use this command you must define the telephone number for each ISDN channel. The DIVA LAN ISDN Modem uses these telephone numbers to determine the SPID assigned to each channel.

SET ISDN SPID channel spid

Valid context: *General*

Service Profile Identifiers are defined by your ISDN provider to identify your ISDN equipment to the ISDN switch. If your line supports AutoSPID, the DIVA LAN ISDN Modem automatically detects your SPIDs.

channel: First or second SPID. Range: 1 to 2.

spid: SPID number to assign. Range: 1 to 32 digits.

SET ISDN SWITCH {NI1 | 5ESS | AUTO | 5ESSPP}

Valid context: *General*

Specifies the type of ISDN switch used by your ISDN service provider.

NI1: National ISDN-1 switch.

5ESS: AT&T 5ESS switch.

5ESSPP: AT&T 5ESS switch/Point to Point. This setting does not require SPIDs.

AUTO: The DIVA LAN ISDN Modem automatically detects the switch type in use.

SET ISDN SWITCH {JATE | EURO | BT | TPH | CHINA | SINGAPORE}

Valid context: *General*

Specifies the type of ISDN switch used by your ISDN service provider.

EURO: Euro-ISDN

TPH: Microlink (TPH1962/TS013)

JATE: INS-Net64 (Japan)

BT: British Telecom

SET ISDN TEI {isdnTEI | DYNAMIC}

Valid context: *General*

Defines the TEI used by ISDN to support X.25 communications over the D-channel. This setting takes precedence over TEI sharing (dynamic allocation).

isdnTEI: TEI number to assign to the D-channel for X.25. Your service provider will provide this value. Range: 1 to 127.

DYNAMIC: TEI number is negotiated with the ISDN switch and also allows TEIs to be shared (ENABLE ISDN TEISHARING).

SET ISDN CALLTYPE {AUTO | 56K | DOV}

Valid context: *Profile/PPP*

Defines the ISDN call type for this profile.

56K: Transmit and receive at 56 kbps.

DOV: Establish all data calls as voice calls. Useful in areas where voice calls cost less than data calls. Throughput is not affected.

AUTO: Transmit and receive at 64 kbps or 56 kbps.

ENABLE ISDN DELAY56K {DEFAULT | VALUE delay}

Valid context: *General*

An attempt is made to automatically re-establish a data call at 56 kbps if a data call attempt failed at 64 kbps due to network congestion, or if a service or option was not available or not configured.

DEFAULT: Immediately try to connect at 56 kbps if a call fails at 64 kbps. In Australia and Japan, do not retry.

VALUE delay: Specifies how long to wait before retrying. Range 0 to 10 seconds., 254 (use pre-configured values depending on region), 255 (no retry).

DISABLE ISDN DELAY56K

Valid context: *General*

SHOW ISDN STATISTICS

Valid context: *General*

Displays statistics for the two ISDN channels.

SHOW ISDN STATUS

Valid context: *General*

Displays ISDN status information.

SHOW ISDN CONFIGURATION

Valid context: *General*

Displays ISDN configuration information.

ISDN Access Time

ADD ISDN ACESSTIME days time {IN | OUT | ANY| BLOCKED}

Valid context: *General*

Defines the times during which ISDN data calls can be made or received.

For example, the command `"add isdn accesstime mon-fri 9:00-17:00 IN"` enables incoming calls Monday to Friday, from 9AM to 5PM.

days: Starting and ending days, separated by a hyphen. Range: mon, tues, wed, thur, fri, sat, sun. Range must be within the same week (sun-sat). You can specify only one day as well.

time: Starting and ending time in hours and minutes, separated by a hyphen.

Time must be within the same day (0:00 - 24:00).

IN: Allow incoming calls only.

OUT: Allow outgoing calls only.

ANY: Allow both incoming and outgoing calls.

BLOCKED: Prohibits both incoming and outgoing calls.

SET ISDN ACESSTIME index {DAYS | TIME | DIRECTION} item

Valid context: *General*

Changes the settings for an entry in the ISDN ACESSTIME table. These entries define the times during which ISDN calls can be made or received.

index: Entry number in the table.

DAYS: Change the setting for starting and ending days. Separate days by a hyphen. Range: mon, tues, wed, thur, fri, sat, sun. Range must be within the same week (sun-sat). You can specify only one day as well.

TIME: Change the setting for starting and ending time. Specify time in hours and minutes, separated by a hyphen. Time must be within the same day 0:00 - 24:00.

DIRECTION: Change the setting for direction: Specify IN, OUT, ANY or BLOCK.

DELETE ISDN ACESSTIME index

Valid context: *General*

Deletes the settings for an entry in the ISDN ACESSTIME table. These entries define the times during which ISDN data calls can be made or received.

index: Entry number in the table.

SHOW ISDN ACESSTIME

Valid context: *General*

Displays the ISDN ACESSTIME table. These entries define the times during which ISDN data calls can be made or received.

ENABLE ISDN ACESSTIME DISABLE ISDN ACESSTIME

Valid context: *General*

Enable or disable support for ISDN access time. When enabled, the DIVA LAN ISDN Modem restricts incoming and outgoing data calls based on the settings in the ISDN ACESSTIME table.

LAPD

SHOW LAPD TRACE [memsize [framesize]]

Valid context: *General*

This command will start a LAPD trace or display information for a LAPD trace that is already active.

memsize: The amount of RAM reserved to store the trace on the DIVA LAN ISDN Modem. Range: 1 to 63 KB. Default: 16 KB

framesize: The number of characters to display in each frame.

STOP LAPD TRACE

Valid context: *General*

Stops and resets a LAPD trace.

Logging and Mail Trace

SET LOG FILTER {TRACE | DEBUG | INFO | SECURITY | WARNING}

Valid context: *General*

Specifies the type of information that will be written to the DIVA LAN ISDN Modem event log. See SHOW LOG for a description of the information written to the log by each setting.

ENABLE LOG MODULE taskName | ALL DISABLE LOG MODULE taskName | ALL

Valid context: *General*

Enables or disables the inclusion of firmware module messages in the log file. Each firmware module issues status messages during the course of its operations. Use this command to set which messages are displayed from the log when you issue the SHOW LOG command.

taskName: Use module names as shown in SHOW LOG. For example: DHCP, DNS, PPP, IP, IPPP.

ALL: Affects all module messages.

ENABLE LOG OUTPUT SCREEN | REMOTE hostAddr DISABLE LOG OUTPUT SCREEN | REMOTE

Valid context: *General*

Sends event log information to the specified device.

SCREEN: Every time an event is added to the log it is also displayed on the local screen.

REMOTE: Every time an event occurs, a message is sent to the remote device.

hostAddr: IP address of the remote device.

SHOW MAIL TRACE [control]

Valid context: *General*

Displays a mail trace.

control: [buf_size[,entry_size[,filter]]] -p -s -r

buf_size: Size of trace buffer in bytes. (hexadecimal)

entry_size: Maximum size of each element to include.

filter: Type of filter.

- p: Stop/pause trace.

- s: Restart trace from paused state.

- r: Reset (clear) trace buffer.

nothing: auto-pause the mail trace and read current contents

STOP MAIL TRACE

Valid context: *General*

Stops an active mail trace.

SHOW LOG [STATUS]

Valid context: *General*

Displays the event log. If STATUS is specified, this command only displays status information.

MLPPP

SET MLPPP LINKUP threshold delay [channel]

Valid context: *Profile/PPP*

Sets the conditions that define when the DIVA LAN ISDN Modem brings up an ISDN B-channel.

threshold: Percent usage of the current channel. Range: 50 to 100%. Default: 70%.

delay: How long usage must stay at threshold before the B-channel is brought up. Range: 1 to 120 sec. Default: 5 sec.

channel: ISDN B-channel to bring up. Range: 1 to 2. Default: assign to both B-channels.

SET MLPPP LINKDOWN threshold delay [channel]

Valid context: *Profile/PPP*

Sets the conditions that define when the DIVA LAN ISDN Modem brings down an ISDN B-channel. This can never result in the termination of a connection. If only one channel is in use, no action is taken.

threshold: Percent usage of the previous last channel. Range: 0 to 50%. Default: 40%.

delay: How long usage must stay at threshold before channel is brought down. Range: 1 to 120 sec. Default: 5 sec.

channel: ISDN channel to bring down. Range: 1 to 2. Default: assign to both channels.

SET MLPPP POLICY {AUTO | DONLY}

Valid context: *Profile/PPP*

Determines ISDN line usage when AO/DI is enabled.

AUTO: Data is transferred on the D-channel, plus both B-channels if required.

DONLY: Data is only transferred on the D-channel.

SET MLPPP MODE {DISABLE | NORMAL | BACP | AODI}

Valid context: *Profile/PPP*

The DIVA LAN ISDN Modem uses multilink PPP to combine both ISDN B-channels into a single 128 kbps communications link.

DISABLE: Disable MLPPP support.

NORMAL: Enable MLPPP support.

BACP: The DIVA LAN ISDN Modem uses BACP to monitor incoming and outgoing traffic, and to open or close your second ISDN channel as the traffic volume warrants. This reduces your communications charges by ensuring that two ISDN channels are never active when one is sufficient.

AODI: Always On/Dynamic ISDN lets you maintain a permanent D-channel connection for low-bandwidth applications. AODI incorporates BACP, ensuring that ISDN channels are automatically activated/deactivated in response to data traffic.

SHOW MLPPP CONFIGURATION

Valid context: *Profile/PPP*

Displays MLPPP configuration settings, including BACP and AO/DI.

Phone

ENABLE PHONE ALTRING channel **DISABLE PHONE ALTRING channel**

Valid context: *General*

If you have two phone numbers assigned to phone port, the DIVA LAN ISDN Modem assigns a distinctive ring to each number.

If you ENABLE PHONE ALTRING for a port, the assigned rings are swapped.

channel: PHONE port number. Range: 1 to 2.

ENABLE PHONE CALLBUMPING **DISABLE PHONE CALLBUMPING**

Valid context: *General*

Enables or disables call bumping. Call bumping is only effective if you are using MLPPP, MLPPP+BACP, or MLPPP+AO/DI. When enabled, an incoming or outgoing voice call will temporarily disconnect one channel of an active data call. If PPP is in use on both B-channels, then call bumping does not work (incoming and outgoing calls will receive a busy signal).

ENABLE PHONE CALLWAITING [port] **DISABLE PHONE CALLWAITING [port]**

Valid context: *General*

Enables or disables call waiting for analog phones (POTS).

port: Phone port number. Range: 1 to 2. Default: applies to both ports.

ENABLE PHONE CALLS channel [IN | OUT] **DISABLE PHONE CALLS channel [IN | OUT]**

Valid context: *General*

Enables or disables incoming and/or outgoing POTS phone calls on a specific ISDN channel.

channel: ISDN channel. Range: 1 to 2.

IN: Enable/Disable incoming calls.

OUT: Enable/Disable outgoing calls.

SET PHONE RING FREQUENCY {0 | 20 | 25 | 40 | 50}

Valid context: *General*

Specifies the ringer frequency for phones connected to the PHONE ports.

0: The ring frequency is determined by the country setting (SET PHONE COUNTRY).

20, 25, 40, 50: Ringer frequency in hertz.

ENABLE PHONE CALLERID **DISABLE PHONE CALLERID**

Valid context: *General*

Enables or disables caller ID for connected phones (POTS). When enabled, telephones with Call Display will display incoming call information.

SET PHONE FEATUREKEY {CONFERENCE | TRANSFER | DROP | MSGINDICATOR} value

Valid context: *General*

Specifies the feature key for analog device calling features.

CONFERENCE: Conference call.

TRANSFER: Call transfer.

DROP: Call drop.

MSGINDICATOR: Message waiting indicator.

value: 1 to 16383. Defaults are: Conference Call = 60, Call Transfer = 61, Call Drop = 62, Message Waiting Indicator = 63.

SET PHONE MSGINDICATOR refresh

Valid context: *General*

Specifies how frequently the DIVA LAN ISDN Modem should refresh the Visual Message Indicator.

refresh: Refresh time in minutes. Range: 0 (disabled), 1 to 60. Default: 30. It is recommended that refresh not be set to below 30 minutes.

SET PHONE CAPABILITY channel {SPEECH | DATA}

Valid context: *General*

Specifies the type of traffic a PHONE is optimized to support.

channel: Phone port. Range: 1 to 2.

SPEECH: Port can carry voice and data traffic.

DATA: Sets the bearer capability of the port to 3.1 KHz audio, which provides better throughput when using faxes and modems. Support for supplementary services (Call Waiting, etc.) is disabled.

SET PHONE ENCODINGLAW {AUTO | ULAW | ALAW}

Valid context: *General*

Specifies the type of encoding law for ISDN voice calls.

AUTO: Automatically detect the correct encoding to use.

ULAW: Use when connected to an INS-Net64, NI-1 or AT&T 5ESS switch.

ALAW: Use when connected to a EuroISDN or TPH switch.

ENABLE PHONE VOICEMAIL channel [SILENT]

Valid context: *General*

Enables voice mail support.

channel: PHONE port number. Range: 1 to 2.

SILENT: Mutes periodic ring warning you of waiting messages.

DISABLE PHONE VOICEMAIL channel

Valid context: *General*

Disables voice mail support.

channel: PHONE port number. Range: 1 to 2.

ENABLE PHONE SERVICES channel
DISABLE PHONE SERVICES channel

Valid context: *General*

Enables or disables support for all supplementary phone services.

channel: Channel number. Range: 1 to 2.

SET PHONE COUNTRY country

Valid context: *General*

Specifies the country in which this phone is being used. Sets the phone to behave as expected in the selected country.

country: Code identifying the country in which the phone is being used. Use the command SHOW PHONE COUNTRY to see the list of supported countries and their codes.

SHOW PHONE COUNTRY

Valid context: *General*

Displays a list of countries and their associated codes.

SHOW PHONE CONFIGURATION

Valid context: *General*

Displays the current settings of all phone parameters.

PPP

SET PPP AUTHENT {ENCRYPTED | ANY}

Valid context: *Profile/PPP*

Specifies how authentication is handled for a call. If the remote is not using the same type of password (encrypted/unencrypted), then the call is rejected.

ENCRYPTED: Accepts only calls using encrypted passwords for authentication.

ANY: Accepts calls using either encrypted or unencrypted passwords. Default setting.

ENABLE PPP AUTHENT DISABLE PPP AUTHENT

Valid context: *Profile/PPP*

Enables or disables authentication when dialing out. If enabled, the DIVA LAN ISDN Modem attempts to authenticate the remote with whatever authentication method is defined. This option is disabled by default.

SET PPP LPASSWORD localPassword

Valid context: *Profile/PPP*

Sets the password that the DIVA LAN ISDN Modem will use when replying to valid authentication requests. For example, when connecting to your ISP, this is the password that is used to log on. Specify 0 to 31 alphanumeric characters (no spaces).

SET PPP LNAME localName

Valid context: *Profile/PPP*

Sets the name that the DIVA LAN ISDN Modem will use when replying to valid authentication requests. For example, when connecting to your ISP, this is the name that is used to log on. Specify 0 to 31 alphanumeric characters (no spaces).

SET PPP RNAME remoteName

Valid context: *Profile/PPP*

Sets the name the remote user or device must supply when authentication is requested by the DIVA LAN ISDN Modem. Specify 1 to 31 alphanumeric characters (no spaces).

SET PPP RPASSWORD remotePassword

Valid context: *Profile/PPP*

Sets the password the remote device must supply when authentication is requested by the DIVA LAN ISDN Modem. Specify 1 to 31 alphanumeric characters (no spaces).

ENABLE PPP COMPRESSION DISABLE PPP COMPRESSION

Valid context: *Profile/PPP*

Enables or disables PPP compression. When enabled, the DIVA LAN ISDN Modem automatically negotiates one of the following standards: Ascend, MPPC, MS-STAC, STAC 1, and STAC 3. Compression is disabled by default.

ENABLE PPP SECUREID DISABLE PPP SECUREID

Valid context: *Profile/PPP*

Enables or disables support for SecureID client applications.

When enabled, the DIVA LAN ISDN Modem uses the SecureID name and password instead of the username (SET PPP LNAME) and password (SET PPP LPASSWORD) configured on the DIVA LAN ISDN Modem for the active profile. The DIVA LAN ISDN Modem dynamically obtains the SecureID name and password from the SecureID client application as required.

SET PPP BACKUP profilename

Valid context: *Profile/PPP*

Specifies the alternate profile to use when a connection attempt with this profile fails.

profilename: Name of the alternate profile.

ENABLE PPP ECHOREQUEST DISABLE PPP ECHOREQUEST

Valid context: *Profile/PPP*

Enables or disables the use of PPP echo requests. Some systems do not properly respond to PPP echo requests. To connect to these systems you will have to disable the sending of PPP echo requests.

SET PPP IDLETIME interval

Valid context: *Profile/PPP*

Each profile has its own idle timer. The idle timer controls how long a data call stays connected when no traffic is being sent or received. When the idle timer expires, the DIVA LAN ISDN Modem disconnects the call at the end of the next billing interval. Range 0 (never disconnect), 15 to 900 seconds. Default: 120 seconds.

SET PPP MAXRETRY number [2ndchannel]

Valid context: *Profile/PPP*

Sets the maximum number of attempts this profile makes to establish a connection with this profile. When this limit is reached, the DIVA LAN ISDN Modem places the profile in the "failed" state and a backup profile, if defined, is dialed.

To automatically reset the profile, use the command SET PPP RESTOREDELAY. To reset the profile manually, dial it or reset the DIVA LAN ISDN Modem.

number: Number of times the DIVA LAN ISDN Modem will attempt to activate the ISDN link. Range: 0 to 250. Default: 25.

2ndchannel: If this profile supports, BACP, this parameter sets the number of times BACP will attempt to activate the second B-channel.

SET PPP RESTOREDELAY interval

Valid context: *Profile/PPP*

Automatically restores a profile from "failed" state to "ready" state after the specified number of seconds.

interval: Time to wait before restoring the profile to ready state. Range: 0 (do not restore), 300 - 65535 seconds.

SET PPP RETRYDELAY interval

Valid context: *Profile/PPP*

Sets the amount of time the DIVA LAN ISDN Modem waits after a failed connection attempt, before retrying.

SHOW PPP CONFIGURATION

Valid context: *Profile/PPP*

Displays the current PPP configuration settings.

SHOW PPP STATISTICS

Valid context: *General*

Displays PPP statistics.

SHOW PPP STATUS

Valid context: *Profile/PPP*

Displays PPP status.

SHOW PPP TRACE [port[mask] [memsize [framesize]]]

Valid context: *Profile/PPP*

Starts or displays an already started PPP trace for an ISDN channel.

memsize: The amount of RAM reserved to store the trace on the DIVA LAN ISDN

Modem. Range: 1 to 63 KB . Default: 16 KB

framesize: The number of characters to display in each frame.

STOP PPP TRACE [port]

Valid context: *Profile/PPP*

Stops a PPP trace for an ISDN channel.

Profiles

SET PROFILE NAME name

Valid context: *Profile*

Changes the name of the current profile.

name: New name for the profile. The name must not contain spaces.

ENABLE PROFILE DISABLE PROFILE

Valid context: *Profile*

Enables or disables the current profile.

SHOW PROFILE [profileName]

Valid context: *General*

Displays the configuration settings for all profiles.

TEST PROFILE

Valid context: *Profile/PPP*

Tests the profile. Each step in the test is displayed on the with its results.

PROFILE [profileName]

Valid context: *General*

Changes the active context to the specified profile. If no name is specified, you are placed in the General context. The exception to this is if you are in the Filter context, then you are returned to the profile you came from.

profileName: Name of an existing profile.

LAN

Valid context: *General*

Changes the current context to the predefined LAN profile.

INCOMING

Valid context: *General*

Changes the current context to the Incoming context. Use the Incoming context to define how the DIVA LAN ISDN Modem handles incoming data calls.

DIAL

Valid context: *Profile/PPP*

Dials out using the phone numbers in the current profile.

HANGUP

Valid context: *Profile/PPP*

Hangs up the connection established by the current profile.

Q.931

SHOW Q931 TRACE [memsize [framesize]]

Valid context: *General*

Start a Q931 trace, or display one that is already running.

memsize: The amount of RAM reserved to store the trace on the DIVA LAN ISDN

Modem. Range: 1 to 63 KB . Default: 4 KB

framesize: The number of characters to display in each frame.

STOP Q931 TRACE

Valid context: *General*

Stops a running Q931 trace.

RIP

ENABLE RIP [V1 | V2 | V2COMPATIBLE | MERGE]

Valid context: *Profile*

Enables or disables support for RIP (routing information protocol). When enabled, the DIVA LAN ISDN Modem will exchange routing information with other devices.

V1: Supports RIP version 1.

V2: Supports RIP version 2.

V2COMPATIBLE: Supports RIP version 2 that is version 1 compatible (implies broadcasting RIP-2).

MERGE: Merge equivalent routes.

DISABLE RIP [MERGE]

Valid context: *Profile*

Disables all RIP services.

MERGE: RIP will not merge similar routes.

SHOW RIP CONFIGURATION

Valid context: *Profile*

Display RIP configuration settings.

SHOW RIP STATISTICS

Valid context: *General*

Displays RIP statistics.

SET RIP UPDATE period

Valid context: *General*

Specifies the amount of time RIP waits between sending updates to its peers.

period: Time in seconds between updates. Default 30 sec.

SET RIP POLICY {SILENT | PERIODIC}

Valid context: *Profile*

Specifies how RIP manages route updates, requests, and responses.

SILENT: RIP accepts updates from other systems, but will not respond to requests or send updates.

PERIODIC: RIP operates normally: A complete update is sent to all neighbors and all incoming requests are responded to. (LAN only)

ADD RIP REJECT ipaddr

Valid context: *General*

Adds or deletes an IP address. RIP ignores all routing information received from peers with IP address that appears in the RIP Reject table.

ipaddr: IP address of peer to ignore.

DELETE RIP REJECT ipaddr

Valid context: *General*

SHOW RIP REJECT

Valid context: *General*

Displays the RIP reject table. RIP ignores all routing information received from peers with IP address that appears in this table.

SNMP

SET SNMP NAME name

Valid context: *General*

Lets you assign a name to the DIVA LAN ISDN Modem. This information can be retrieved by SNMP agents. Range: 1 to 39 alphanumeric characters.

SET SNMP DESCRIPTION name

Valid context: *General*

Lets you associate a description with the DIVA LAN ISDN Modem. This information can be retrieved by SNMP agents.

SET SNMP CONTACT name

Valid context: *General*

Lets you store the email address of the person responsible for the DIVA LAN ISDN Modem. This information can be retrieved by SNMP agents. Range: 1 to 29 alphanumeric characters.

SET SNMP LOCATION name

Valid context: *General*

Lets you store a description describing the physical location of the DIVA LAN ISDN Modem. This information can be retrieved by SNMP agents. Range: 1 to 29 alphanumeric characters.

SET SNMP COMMUNITY name

Valid context: *General*

Sets the SNMP community name for the DIVA LAN ISDN Modem. The community name acts as a password controlling SNMP read and write access to all DIVA LAN ISDN Modem configuration settings. Range: 1 to 29 alphanumeric characters.

SET SNMP TRAPADDR ipaddr

Valid context: *General*

Sets the IP address of the remote station where LAN Manager will send SNMP traps. The DIVA LAN ISDN Modem supports all standard MIB II traps.

trapaddr: IP address of remote station in dotted-decimal format.

TCP

SHOW TCP STATISTICS

Valid context: *General*

Displays TCP statistics.

SHOW TCP TRACE [memsize [framesize]]

Valid context: *General*

Starts or displays a TCP trace.

memsize: The amount of RAM reserved to store the trace on the DIVA LAN ISDN

Modem. Range: 1 to 63 KB . Default: 16 KB

framesize: Number of characters to show for each frame.

STOP TCP TRACE

Valid context: *General*

Stops an active TCP trace.

TFTP

ENABLE TFTP SERVER **DISABLE TFTP SERVER**

Valid context: *General*

Enables or disables the TFTP (Trivial File Transfer Protocol). When enabled the DIVA LAN ISDN Modem acts as a TFTP server, and can respond to upload or download requests from TFTP clients. TFTP server is disabled by default.

GET TFTP FILE ipaddress localfn remotefn **PUT TFTP FILE ipaddress localfn remotefn**

Valid context: *General*

Download or upload a file using TFTP (trivial file transfer program).

ipaddress: IP address of the remote system.

localfn: Name of the file on the local system.

remotefn: Name of the file on the remote system.

Time Protocol

SET TIMEPROTOCOL SERVER timeServer

Valid context: *General*

Use this command to automatically update the DIVA LAN ISDN Modem internal clock using a time server.

timeServer: IP address of the time server.

SET TIMEPROTOCOL ZONE timeZoneDiff

Valid context: *General*

Specifies the difference between your time zone and Greenwich mean time (GMT) in hours. Range: -12 to 12.

ENABLE TIMEPROTOCOL DISABLE TIMEPROTOCOL

Valid context: *General*

Enables or disables the use of the time protocol. When enabled, the DIVA LAN ISDN Modem will periodically contact a time server to retrieve the correct time and set its internal clock to match.

SHOW TIMEPROTOCOL CONFIGURATION

Valid context: *General*

Display time protocol settings.

UDP

SHOW UDP STATISTICS

Valid context: *General*

Displays UDP statistics.

SHOW UDP TRACE [memsize [framesize]]

Valid context: *General*

Starts or displays an UDP trace.

memsize: The amount of RAM reserved to store the trace on the DIVA LAN ISDN Modem. Range: 1 to 63 KB. Default: 16 KB

framesize: Number of characters to show for each frame.

STOP UDP TRACE

Valid context: *General*

Stops an active UDP trace.

V.120

ENABLE V120 **DISABLE V120**

Valid context: *Profile/PPP*

Enables or disables the V.120 protocol for the current profile.

SET V120 MODE {MULTIFRAME | UNACKNOWLEDGED}

Valid context: *General*

V.120 was designed to allow non-ISDN devices to communicate with the ISDN network. The DIVA LAN ISDN Modem provides support for V.120, so you can connect with such legacy systems. For example, in many countries around the world, CompuServe offers access to their network over ISDN, using the V.120 protocol.

SET V120 MAXFRAMESIZE MaxFrameSizeTx MaxFrameSizeRx

Valid context: *General*

Defines the maximum size of a V.120 information field that the DIVA LAN ISDN will transmit or receive. Range: 16 to 260 bytes. Default: 260.

Note: If a larger frame needs to be transmitted, the DIVA LAN ISDN segments it into V.120 fragments and expects the remote device to perform re-assembly.

SET V120 WINDOWSIZE Number

Valid context: *General*

Applies to Multiframe mode only. Defines the maximum number of sequential data frames that can be outstanding (not acknowledged) at any given time. Range is 1 to 127. Default: 7

SET V120 MAXRETRY Count

Valid context: *General*

Applies to Multiframe mode only. Defines the maximum number of retransmissions of an unacknowledged frame. A frame is considered to be unacknowledged if the remote site does not send an acknowledgement before the retransmission timer (T200) expires. When the maximum number of retransmissions has been attempted, a recovery process is started which may cause the connection to be terminated.

Count: Number of retransmissions. Range 1 to 10. Default: 3.

SET V120 T200 RetransmissionDelay

Valid context: *General*

Applies to Multiframe mode only. Defines the maximum time a frame can be outstanding without an acknowledgement from the remote. When this timer expires, the frame is considered to be lost and retransmission is attempted. Range 1 to 255 in tenths of a second. Default: 15 (1.5 seconds).

The value specified for this timer must be less than the value specified for the Link Integrity Timer (T203). Otherwise, default values are used for both.

SET V120 T203 LinkIntegrityDelay

Valid context: *General*

Applies to Multiframe mode only. Defines the maximum time the connection can remain idle without data or control frames being exchanged. This enables you to verify that the remote device is still online and operational, so you do not maintain the link for no reason. When this timer expires, a recovery process is started which may cause the connection to be terminated. Range: 1 to 255 seconds. Default: 30.

The value specified for this timer must be less than the value specified for the Idle Timer. Otherwise, default values are used for both.

SET V120 IDLETIME IdleDelay

Valid context: *General*

Defines the maximum amount of time the line can remain idle without the exchange of data, before the DIVA LAN ISDN Modem disconnects the link. This enables you to reduce your communications charges by dropping the link when no data is being transferred. Range: 0 (never disconnect, 1 to 10000 minutes. Default: 1440 minutes (24 hours).

SHOW V120 CONFIGURATION

Valid context: *General*

Displays V.120 configuration settings for the current profile.

SHOW V120 TRACE [memsize [framesize]]

Valid context: *Profile/PPP*

Starts or displays an V120 trace.

memsize: The amount of RAM reserved to store the trace on the DIVA LAN ISDN Modem. Range: 1 to 63 KB. Default: 16 KB

framesize: Number of characters to show for each frame.

STOP V120 TRACE

Valid context: *Profile/PPP*

Stops an active V120 trace.

V.120 Scripting

ADD SCRIPT LINE index command [argument]

Valid context: *Profile/PPP*

Adds a line to the V.120 script for the current profile. The script is executed when the DIVA LAN ISDN Modem establishes a V.120 connection.

\ "command\" are:

ABORT: End the script.

SEND text: Send the specified text to the remote. Enter up to 33 alphanumeric characters.

WAITFOR text: Pause script execution until the specified text is sent by the remote system. Enter up to 33 alphanumeric characters.

DELAY num: Pauses script execution for the specified number of seconds. Range: 1 to 255 seconds.

TIMEOUT num: If the next script event does not complete within the time specified, the script is aborted. Range: 1 to 255 seconds.

USERNAME: Sends the username configured with SET PPP LNAME to the remote.

PASSWORD: Sends the password configured with SET PPP LPASSWORD to the remote.

DELETE SCRIPT LINE index

Valid context: *Profile/PPP*

Deletes a line from the script for the current profile.

index: Number of the line to delete. Range: 1 to 17.

SHOW SCRIPT [index]

Valid context: *Profile/PPP*

Displays any defined script lines for the current profile.

X.25

SET X25 ADDRESS localX25addr

Valid context: *Profile*

Sets the X.25 DTE address assigned to the DIVA LAN ISDN Modem. Specify up to 15 digits.

localX25addr: DTE address of the device.

SET X25 CUD callUserData

Valid context: *Profile*

Specifies the call user data the device will include when establishing an X.25 call.

callUserData: Call user data as hexadecimal digits separated by commas, colons, or hyphens. Maximum length is 16 bytes. For example: 42,07,07

SET X25 FACILITIES hexstring

Valid context: *Profile*

Sets the X.25 facilities used to establish an X.25 call with this profile.

hexstring: Encode facilities as a hexadecimal string of characters separated by commas, colons, or hyphens. Maximum length is 14 bytes. For example: 42,07,07

SET X25 LCN lcnNumber

Valid context:

Sets the lowest X.25 logical channel number (LCN) available.

LCNnumber: Logical channel number.

SET X25 MAXIDLETIME seconds

Valid context: *Profile*

Sets the maximum amount of time an X.25 connection can be idle before the DIVA LAN ISDN Modem drops the connection.

maxIdleTime: Maximum time a connection can be idle. Range: 0 (never disconnect), 1 to 600 seconds. Default: 20 seconds.

SET X25 MINCONTIME seconds

Valid context: *Profile*

Sets the minimum amount of time an X.25 connection must stay connected.

minConnectionTime: Minimum time an X.25 connection must stay connected. Range: 0 to 1800 seconds. Default: 30 seconds.

SET X25 NUMSVC svc

Valid context: *General*

Sets the number of X.25 SVCs (switched virtual circuits) supported for X.25 communications over the D-channel.

SET X25 PACKETSIZE default maximum

Valid context: *General*

Sets the default and maximum X.25 packet sizes supported for X.25 communications over the D-channel.

default: Default packet size. Range: 64 to 1024 bytes. Default: 128 bytes.

maximum: Maximum packet size. Range: Default packet size - 1024 bytes.

Default: 256 bytes.

SET X25 REMOTE x25addr

Valid context: *Profile*

Only required if this profile uses AO/DI. Specifies the remote X.25 address the DIVA LAN ISDN Modem calls to establish a connection on the D-channel. Enter up to 15 digits for the address.

SET X25 VERSION {1984 | 1988}

Valid context: *General*

Sets the version of the X.25 protocol to use.

1984: ITU recommendation 1984.

1988: ITU recommendation 1988.

SET X25 WINDOWSIZE default maximum

Valid context: *General*

Sets the default and maximum X.25 window sizes supported for X.25 communications over the D-channel.

default: Default window size. Range: 1 to 7. Default: 2.

maximum: Maximum window size. Range: Default window size - 7. Default: 7.

SHOW X25 STATUS

Valid context: *Profile*

Display X.25 status.

SHOW X25 TRACE [memsize [framesize]]

Valid context: *Profile*

Starts or displays an X.25 trace.

memsize: The amount of RAM reserved to store the trace on the DIVA LAN ISDN Modem.

Range: 1 to 63 KB . Default: 16 KB

framesize: Number of characters to show for each frame.

STOP X25 TRACE

Valid context: *Profile*

Stops an active X.25 trace.

SHOW X25 CONFIGURATION

Valid context: *Profile*

Display X.25 configuration settings.

Regulatory Information

This appendix provides regulatory information.

Regulatory Information for the U.S.A

WARNING. Changes or modifications to this unit not expressly approved by Eicon Technology Corporation could void the user's authority to operate the equipment.

FCC Declaration of Conformity

We:

Eicon Technology Inc.
2155 Chenault Drive
Suite 503
Carrollton, Texas
USA 75006
1-800-80-EICON
(972) 417-5500
Fax: (972) 417-5610

Declare under our sole legal responsibility that the products listed below to which this declaration relates, are in conformity with Part 15 of the FCC Rules. Operation is subject to the following two conditions:

- (1) This device may not cause harmful interference, and
- (2) this device must accept any interference received, including interference that may cause undesired operation.

NOTE. This equipment has been tested and found to comply with the limits for a Class B digital device, pursuant to Part 15 of the FCC Rules. These limits are designed to provide reasonable protection against harmful interference in a residential installation. This equipment generates, uses and can radiate radio frequency energy and, if not installed and used in accordance with the instructions, may cause harmful interference to radio communications.

However, there is no guarantee that interference will not occur in a particular installation. If this equipment does cause harmful interference to radio or television reception, which can be determined by turning the equipment off and on, the user is encouraged to try to correct the interference by one or more of the following measures:

- Reorient or relocate the receiving antenna.
- Increase the separation between the equipment and receiver.
- Connect the equipment into an outlet on a circuit different from that to which the receiver is connected.
- Consult the dealer or an experienced radio/TV technician for help.

FCC Part 68 Notice

This unit complies with Part 68 of the FCC rules. On the bottom of this equipment is a label that contains, among other information, the FCC registration number. If requested, this information must be provided to the telephone company.

An FCC compliant telephone cord and modular plug is provided with this equipment, designed to be connected to the telephone network or premises wiring using a compatible modular jack which is Part 68 compliant.

This equipment cannot be used on telephone company-provided coin service. Connection to party line service is subject to state tariffs.

If this equipment causes harm to the telephone network, the telephone company will notify you in advance that temporary discontinuance of service may be required. If advance notice isn't practical, the telephone company will notify the customer as soon as possible. Also, you will be advised of your right to file a complaint with the FCC if you believe it is necessary.

The telephone company may make changes in its facilities, equipment, operations, or procedures that could affect the operation of the equipment. If this happens, the telephone company will provide advance notice in order for you to make the necessary modifications in order to maintain uninterrupted service.

If trouble is experienced with this equipment, please contact us for repair and warranty information. If the trouble is causing harm to the telephone network, the telephone company may request you to remove the equipment from the network until the problem is resolved.

Regulatory Information for Canada

NOTICE: The Industry Canada label identifies certified equipment. This certification means that the equipment meets certain telecommunications network protective, operational and safety requirements. Industry Canada does not guarantee the equipment will operate to the user's satisfaction.

Before installing this equipment, users should ensure that it is permissible to be connected to the facilities of the local telecommunications company. The equipment must also be installed using an acceptable method of connection. In some cases, the company's inside wiring associated with a single line individual service may be extended by means of certified connector assembly (telephone extension cord). The customer should be aware that compliance with the above conditions may not prevent degradation of service in some situations.

Repairs to certified equipment should be made by an authorized Canadian maintenance facility designated by the supplier. Any repairs or alterations made by the user to this equipment, or equipment malfunctions, may give the telecommunications company cause to request the user to disconnect the equipment.

For their own protection, users should ensure that any electrical ground connections of the power utility, telephone lines and internal metallic water pipe system are connected together. This precaution is particularly important in rural areas.



Users should not attempt to make such connections themselves, but should contact the appropriate electric inspection authority, or electrician, as appropriate.

This Class B digital apparatus complies with Canadian ICES-003.

Cet appareil numérique de la classe B est conforme à la norme NMB-003 du Canada.

Free Manuals Download Website

<http://myh66.com>

<http://usermanuals.us>

<http://www.somanuals.com>

<http://www.4manuals.cc>

<http://www.manual-lib.com>

<http://www.404manual.com>

<http://www.luxmanual.com>

<http://aubethermostatmanual.com>

Golf course search by state

<http://golfingnear.com>

Email search by domain

<http://emailbydomain.com>

Auto manuals search

<http://auto.somanuals.com>

TV manuals search

<http://tv.somanuals.com>