

EIKI

MULTIMEDIA PROJECTOR

MODEL LC-SD15

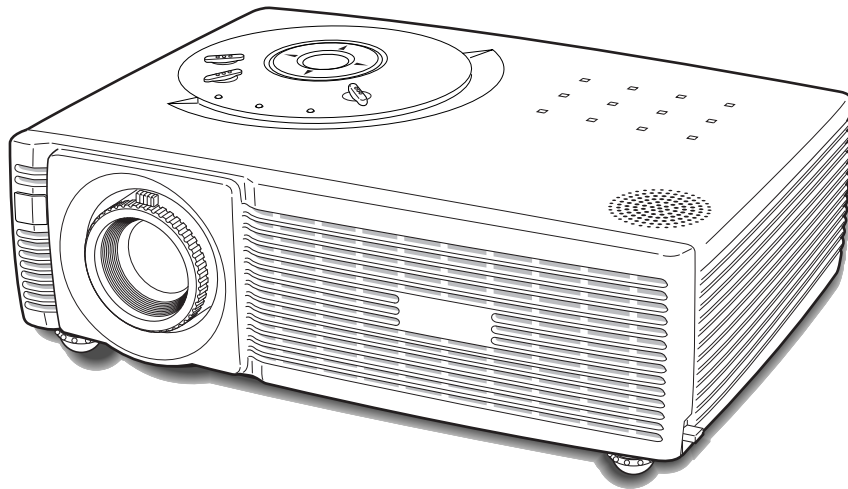

OWNER'S MANUAL

Features and Design

This Multimedia Projector is designed with the most advanced technology for portability, durability, and ease of use. This projector utilizes built-in multimedia features, a palette of 16.77 million colors, and matrix liquid crystal display (LCD) technology.

◆ **Compact Design**

This projector is designed compact in size and weight. It is easy to carry and work anywhere you wish to use.

◆ **Compatibility**

The projector widely accepts various video and computer input signals including; Computers, 6 Color systems (PAL, SECAM, NTSC, NTSC4.43, PAL-M, PAL-N), Component video, S-video and RGB scart.

◆ **Simple Computer System Setting**

The projector has the Multi-scan system to conform to almost all computer output signals quickly. (See page 25.)

◆ **Auto PC Adjustment**

Incoming computer signals are recognized and optimum settings are made automatically by Auto PC Adjustment. No complicated setup is necessary and projection is always precise. (See page 26.)

◆ **Blackboard Function**

Blackboard* can be used as a projection screen.
*The board color is limited to green.
(See pages 29 and 34.)

◆ **Digital zoom (for Computer)**

The digital zoom function expands (to approx. 16 times of screen size) or compresses the image size, allowing you to focus on crucial information during presentations. (See page 31.)

◆ **Film Function**

The Film function reproduces pictures faithful to the original film quality from 3-2 pull-down video contents. (See page 36.)

◆ **Multi-language Menu Display**

Operation menu is available in 12 languages; English, German, French, Italian, Spanish, Portuguese, Dutch, Swedish, Russian, Chinese, Korean, or Japanese. (See page 38.)

◆ **Keystone Correction**

The keystone correction function is provided to correct distortion of the projected image allowing you to use the projector without locational constraints. (See pages 22 and 38.)

◆ **Power management**

The Power management function reduces power consumption and maintains the lamp life. (See page 41.)

◆ **User's Logo**

A projected image can be captured and used for the starting display of the projector with the Capture function. You can also display the captured image instead of the black-out image during the intervals between your presentation with the No show function. (See pages 22 and 40.)

◆ **Selectable Lamp Mode**

The brightness of the projection lamp can be selected in the Setting Menu. (See page 41.)

◆ **Key Lock Function**

The Key Lock function is provided to lock the operation of the projector. This function protects the projector from being tampered with by third persons. (See page 42.)

◆ **PIN Code Lock Function**

The PIN code lock function prevents others except authorized users from using the projector. (See pages 17 and 43.)

◆ **Dim Mode**

With the Dim mode function, the brightness of the projected image can be easily selected to suit presenters' and guests' preferences. (See pages 22 and 41.)

Table of Contents

Features and Design	2	Computer Input	24
Table of Contents	3	Input Source Selection	24
To the Owner	4	Computer System Selection	25
Safety Instructions	5	Auto PC Adjustment	26
Air Circulation	6	Manual PC Adjustment	27
Installing the Projector in Proper Position	6	Image Level Selection	29
Moving the Projector	6	Image Level Adjustment	30
Compliance	7	Screen Size Adjustment	31
Part Names and Functions	8	Video Input	32
Front	8	Input Source Selection	32
Back	8	Video System Selection	33
Bottom	8	Image Level Selection	34
Rear Terminal	9	Image Level Adjustment	35
Top Control	10	Screen Size Adjustment	37
Remote Control	11	Setting	38
Operating Range	11	Setting	38
Remote Control Battery Installation	12	Maintenance and Cleaning	45
Installation	13	Warning Indicator	45
Positioning the Projector	13	Cleaning the Air Filters	46
Adjustable Feet	13	Cleaning the Projection Lens	47
Connecting the AC Power Cord	14	Cleaning the Projector Cabinet	47
Connecting to a Computer	15	Attaching the Lens Cover	47
Connecting to Video Equipment	16	Lamp Replacement	48
Basic Operation	17	Lamp Replacement Counter	49
Turning On the Projector	17	Appendix	50
Turning Off the Projector	18	Troubleshooting	50
Zoom and Focus Adjustment	19	Menu Tree	52
How to Operate the On-Screen Menu	20	Indicators and Projector Condition	54
Menu Bar	21	Compatible Computer Specifications	55
Keystone Correction	22	Technical Specifications	56
Picture Freeze Function	22	Optional Parts	57
Dim Mode	22	Configurations of Terminals	58
No Show Function	22	PIN Code Number Memo	59
P-Timer Function	23		
Sound Adjustment	23		

Trademarks

Each name of corporations or products in this book is either a registered trademark or a trademark of its respective corporation.





To the Owner

Before operating this projector, read this manual thoroughly and operate the projector properly.



This projector provides many convenient features and functions. Operating the projector properly enables you to manage those features and maintain it in better condition for a considerable time.

Improper operation may result in not only shortening the product life, but also malfunctions, fire hazard, or other accidents.

If your projector seems to operate improperly, read this manual again, check operations and cable connections and try the solutions in the "Troubleshooting" section in the end of this booklet. If the problem still persists, contact the dealer where you purchased the projector or the service center.

 CAUTION RISK OF ELECTRIC SHOCK DO NOT OPEN 
CAUTION : TO REDUCE THE RISK OF ELECTRIC SHOCK, DO NOT REMOVE COVER (OR BACK). NO USER-SERVICEABLE PARTS INSIDE EXCEPT LAMP REPLACEMENT. REFER SERVICING TO QUALIFIED SERVICE PERSONNEL.
 THIS SYMBOL INDICATES THAT DANGEROUS VOLTAGE CONSTITUTING A RISK OF ELECTRIC SHOCK IS PRESENT WITHIN THIS UNIT.
 THIS SYMBOL INDICATES THAT THERE ARE IMPORTANT OPERATING AND MAINTENANCE INSTRUCTIONS IN THE OWNER'S MANUAL WITH THIS UNIT.

NOTE: This symbol mark and recycle system are applied only to EU countries and not applied to the countries in the other area of the world.

	Your EIKI product is designed and manufactured with high quality materials and components which can be recycled and reused.
	This symbol means that electrical and electronic equipment, at their end-of-life, should be disposed of separately from your household waste.

Please dispose of this equipment at your local community waste collection/recycling centre.
In the European Union there are separate collection systems for used electrical and electronic products.
Please help us to conserve the environment we live in!



Safety Precaution

WARNING : TO REDUCE THE RISK OF FIRE OR ELECTRIC SHOCK, DO NOT EXPOSE THIS APPLIANCE TO RAIN OR MOISTURE.

- This projector produces intense light from the projection lens. Do not stare directly into the lens as much as possible. Eye damage could result. Be especially careful that children do not stare directly into the beam.
- Install the projector in a proper position. If not, it may result in a fire hazard.
- Provide appropriate space on the top, sides and rear of the projector cabinet for allowing air circulation and cooling the projector. Minimum clearance must be maintained. If the projector is to be built into a compartment or similarly enclosed, the minimum distances must be maintained. Do not cover the ventilation slots on the projector. Heat build-up can reduce the service life of your projector, and can also be dangerous.

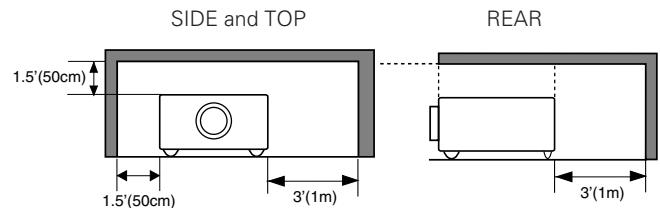

- Do not put any flammable object or spray can near the projector, hot air is exhausted from the ventilation holes.
- If the projector is not to be used for an extended time, unplug the projector from the power outlet.

READ AND KEEP THIS OWNER'S MANUAL FOR LATER USE.

CAUTION

Not for use in a computer room as defined in the Standard for the Protection of Electronic Computer/Data Processing Equipment, ANSI/NFPA 75.

Ne peut être utilisé dans une salle d'ordinateurs telle que définie dans la norme ANSI/NFPA 75 Standard for Protection of Electronic Computer/Data Processing Equipment.

Safety Instructions

All the safety and operating instructions should be read before the product is operated.

Read all of the instructions given here and retain them for later use. Unplug this projector from AC power supply before cleaning. Do not use liquid or aerosol cleaners. Use a damp cloth for cleaning.

Follow all warnings and instructions marked on the projector.

For added protection to the projector during a lightning storm, or when it is left unattended and unused for long periods of time, unplug it from the wall outlet. This will prevent damage due to lightning and power line surges.

Do not expose this unit to rain or use near water... for example, in a wet basement, near a swimming pool, etc...

Do not use attachments not recommended by the manufacturer as they may cause hazards.

Do not place this projector on an unstable cart, stand, or table. The projector may fall, causing serious injury to a child or adult, and serious damage to the projector. Use only with a cart or stand recommended by the manufacturer, or sold with the projector. Wall or shelf mounting should follow the manufacturer's instructions, and should use a mounting kit approved by the manufacturers.

An appliance and cart combination should be moved with care. Quick stops, excessive force, and uneven surfaces may cause the appliance and cart combination to overturn.



Slots and openings in the back and bottom of the cabinet are provided for ventilation, to ensure reliable operation of the equipment and to protect it from overheating.

The openings should never be covered with cloth or other materials, and the bottom opening should not be blocked by placing the projector on a bed, sofa, rug, or other similar surface. This projector should never be placed near or over a radiator or heat register.

This projector should not be placed in a built-in installation such as a book case unless proper ventilation is provided.

Never push objects of any kind into this projector through cabinet slots as they may touch dangerous voltage points or short out parts that could result in a fire or electric shock. Never spill liquid of any kind on the projector.

Do not install the projector near the ventilation duct of air-conditioning equipment.

This projector should be operated only from the type of power source indicated on the marking label. If you are not sure of the type of power supplied, consult your authorized dealer or local power company.

Do not overload wall outlets and extension cords as this can result in fire or electric shock. Do not allow anything to rest on the power cord. Do not locate this projector where the cord may be damaged by persons walking on it.

Do not attempt to service this projector yourself as opening or removing covers may expose you to dangerous voltage or other hazards. Refer all servicing to qualified service personnel.

Unplug this projector from wall outlet and refer servicing to qualified service personnel under the following conditions:

- a. When the power cord or plug is damaged or frayed.
- b. If liquid has been spilled into the projector.
- c. If the projector has been exposed to rain or water.
- d. If the projector does not operate normally by following the operating instructions. Adjust only those controls that are covered by the operating instructions as improper adjustment of other controls may result in damage and will often require extensive work by a qualified technician to restore the projector to normal operation.
- e. If the projector has been dropped or the cabinet has been damaged.
- f. When the projector exhibits a distinct change in performance-this indicates a need for service.

When replacement parts are required, be sure the service technician has used replacement parts specified by the manufacturer that have the same characteristics as the original part. Unauthorized substitutions may result in fire, electric shock, or injury to persons.

Upon completion of any service or repairs to this projector, ask the service technician to perform routine safety checks to determine that the projector is in safe operating condition.



Voor de klanten in Nederland

Bij dit produkt zijn batterijen geleverd. Wanneer deze leeg zijn, moet u ze niet weggoien maar inleveren als KCA.

Air Circulation

Openings in the cabinet are provided for ventilation and to ensure reliable operation of the product and to protect it from overheating, and these openings must not be blocked or covered.



CAUTION

Hot air is exhausted from the exhaust vent. When using or installing the projector, the following precautions should be taken.

- Do not put any flammable objects near the vent.
- Keep the exhaust vent at least 3'(1m) away from any objects.
- Do not touch a peripheral part of the exhaust vent, especially screws and metallic part. This area will become hot while the projector is being used.
- Do not put anything on the projector. Objects put on the cabinet will not only get damaged but also cause fire hazard by heat.

Cooling fans are provided to cool down the projector. The fans' running speed is changed according to the temperature inside the projector.

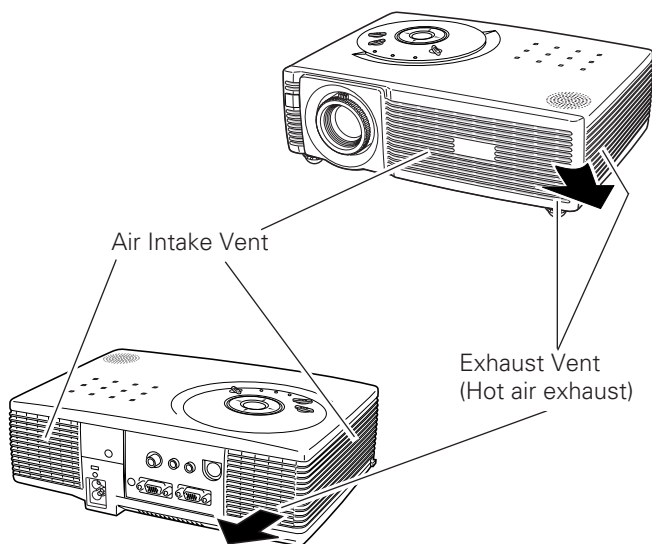

Installing the Projector in Proper Position

Install the projector properly. Improper Installation may reduce the lamp life and cause a fire hazard.

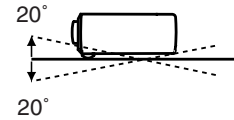

Do not tilt the projector more than 20 degrees above and below.



Do not point the projector up to project an image.



Do not point the projector down to project an image.



Do not put the projector on either side to project an image.

Moving the Projector

When moving the projector, replace the Lens Cover and retract Adjustable Feet to prevent damage to the lens and cabinet.

When the projector is not in use for an extended period, put it into a case.



USE CAUTION IN CARRYING OR TRANSPORTING THE PROJECTOR

- Do not drop or bump the projector, otherwise damages or malfunctions may result.
- When carrying a projector, use a suitable carrying case.
- Do not transport the projector by using a courier or transport service in an unsuitable transport case. This may cause damage to the projector. To transport the projector through a courier or transport service, consult your dealer for more information.

Federal Communication Commission Notice

Note : This equipment has been tested and found to comply with the limits for a Class B digital device, pursuant to part 15 of the FCC Rules. These limits are designed to provide reasonable protection against harmful interference in a residential installation. This equipment generates, uses and can radiate radio frequency energy and, if not installed and used in accordance with the instructions, may cause harmful interference to radio communications. However, there is no guarantee that interference will not occur in a particular installation. If this equipment does cause harmful interference to radio or television reception, which can be determined by turning the equipment off and on, the user is encouraged to try to correct the interference by one or more of the following measures :

- Reorient or relocate the receiving antenna.
- Increase the separation between the equipment and receiver.
- Connect the equipment into an outlet on a circuit different from that to which the receiver is connected.
- Consult the dealer or an experienced radio/TV technician for help.

Use of shielded cable is required to comply with class B limits in Subpart B of Part 15 of FCC Rules.

Do not make any changes or modifications to the equipment unless otherwise specified in the instructions. If such changes or modifications should be made, you could be required to stop operation of the equipment.

Model Number : LC-SD15
Trade Name : EIKI
Responsible party : EIKI International, Inc.
Address : 30251 Esperanza, Rancho Santa Margarita,
CA 92688-2132 U.S.A.
Telephone No. : 800-242-3454 (949-457-0200)

AC Power Cord Requirement

The AC Power Cord supplied with this projector meets the requirement for use in the country you purchased it.

AC Power Cord for the United States and Canada :

AC Power Cord used in the United States and Canada is listed by the Underwriters Laboratories (UL) and certified by the Canadian Standard Association (CSA).

AC Power Cord has a grounding-type AC line plug. This is a safety feature to be sure that the plug will fit into the power outlet. Do not try to defeat this safety feature. Should you be unable to insert the plug into the outlet, contact your electrician.

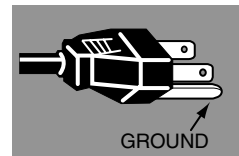

THE SOCKET-OUTLET SHOULD BE INSTALLED NEAR THE EQUIPMENT AND EASILY ACCESSIBLE.

Part Names and Functions

Front

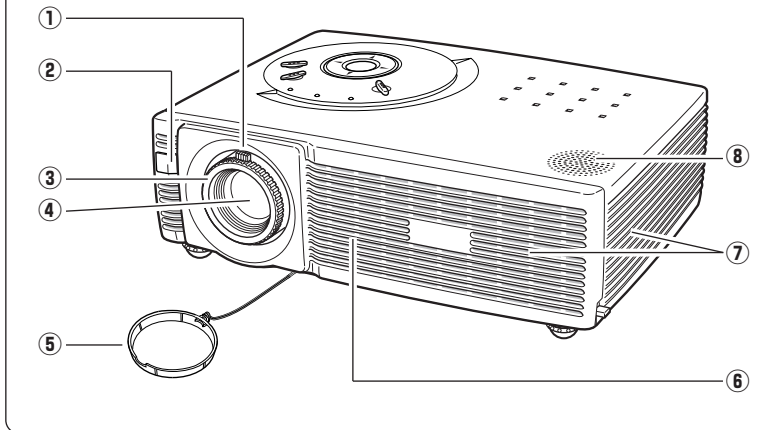

- ① Zoom Lever
- ② Infrared Remote Receiver
- ③ Focus Ring
- ④ Projection Lens
- ⑤ Lens Cover
- ⑥ Air Intake Vent
- ⑦ Exhaust Vent



Hot air is exhausted from the exhaust vent. Do not put heat-sensitive objects near this side.

- ⑧ Speaker

Back

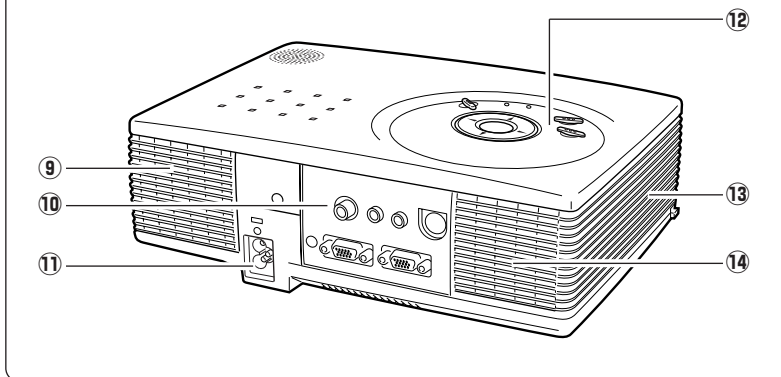

- ⑨ Air Intake Vent
- ⑩ Terminals and Connectors
- ⑪ Power Cord Connector
- ⑫ Top Control and Indicators
- ⑬ Air Intake Vent
- ⑭ Exhaust Vent



Hot air is exhausted from the exhaust vent. Do not put heat-sensitive objects near this side.

Bottom

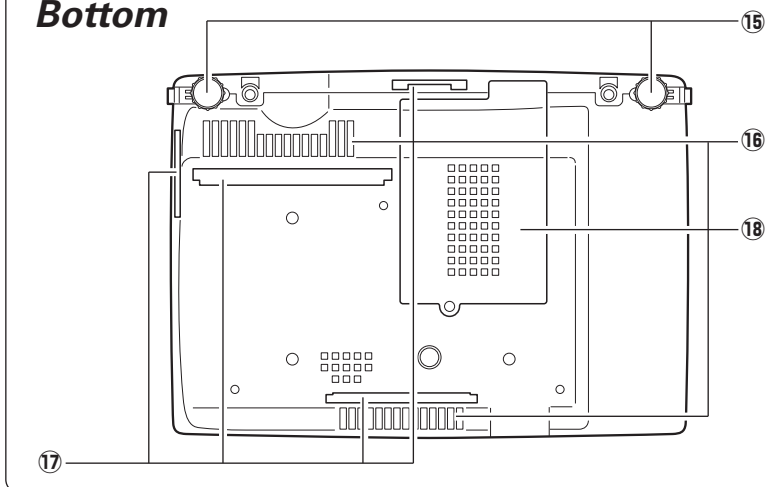

- ⑮ Adjustable Feet
- ⑯ Air Intake Vents
- ⑰ Air Filters
- ⑱ Lamp Cover

Rear Terminal

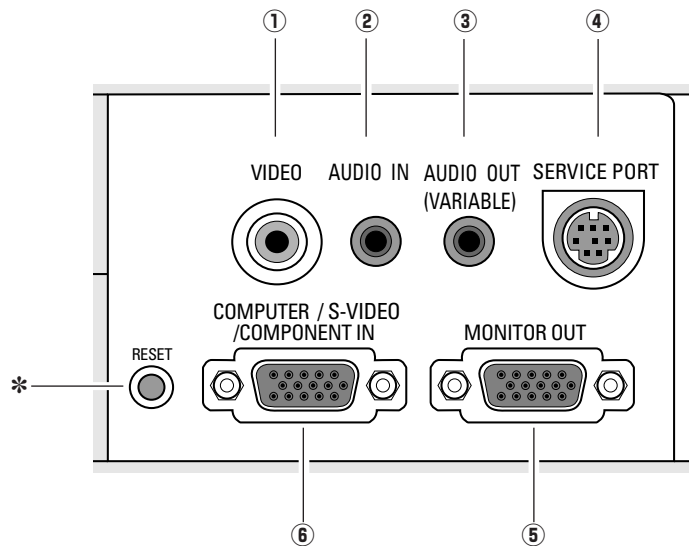

① VIDEO

Connect composite video output from video equipment to VIDEO jack. (p16)

② AUDIO IN (Stereo)

Connect audio output from computer or video equipment connected to ① or ⑥ to this jack. (p15, 16)

③ AUDIO OUT(VARIABLE)

Connect external audio amplifier to this jack. (p15, 16)
This terminal outputs the sound coming from AUDIO IN terminal.

④ SERVICE PORT

This jack is used to service the projector.

⑤ MONITOR OUT

This terminal outputs the signal coming from COMPUTER / S-VIDEO / COMPONENT IN terminals. (This terminal cannot output RGB(Scart) signal from COMPUTER / S-VIDEO / COMPONENT IN terminals.) (p15)

⑥ COMPUTER / S-VIDEO / COMPONENT IN

Connect S-video output, RGB Scart 21-pin video output, component video output or computer output to this connector. (p15, 16)

* RESET button

A built-in micro processor that controls this unit may occasionally malfunction and needs to be reset. This can be done by pressing the RESET button with a pen, which will shut down and restart the unit. Do not use the RESET function excessively.

✓ Note:

- AUDIO OUT and MONITOR OUT terminals work only when the projector is under operation and do not work when the projector is in stand-by state or Power management mode (p41).

Top Control

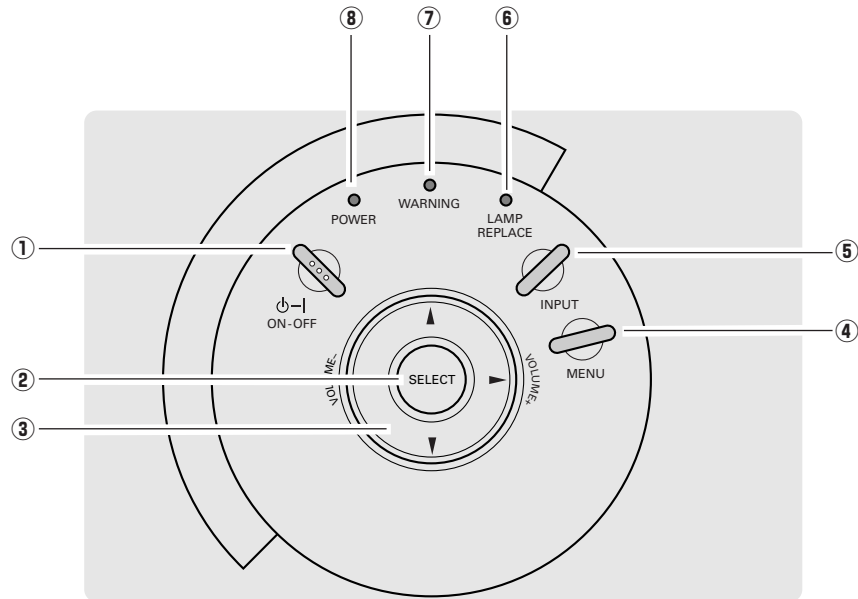

- ① **POWER ON-OFF button**
Turn the projector on or off. (p17,18)
- ② **SELECT button**
Execute the item selected. It is also used to expand/compress the image in Digital zoom +/- mode. (p31)
- ③ **POINT (▲▼◀▶) buttons**
Select an item or adjust the setting value in the On-Screen Menu. They are also used to pan the image in Digital zoom + mode. (p31)
The Point ◀▶ buttons are used as the VOLUME +/- buttons. (p23)
- ④ **MENU button**
Open or close the On-Screen Menu. (p20)
- ⑤ **INPUT button**
Select an input source. (p24, 32)
- ⑥ **LAMP REPLACE indicator**
Emits yellow light when the life of the projection lamp draws to an end. (p48, 54)
- ⑦ **WARNING indicator**
Emits red light when the projector detects an abnormal condition. This also blinks red when the internal temperature of the projector exceeds the operating range. (p45, 54)
- ⑧ **POWER indicator**
Blinks red until the projector gets ready to be turned on. It turns red when the projector is in stand-by mode. It remains green while the projector is under operation. (p54)

Remote Control

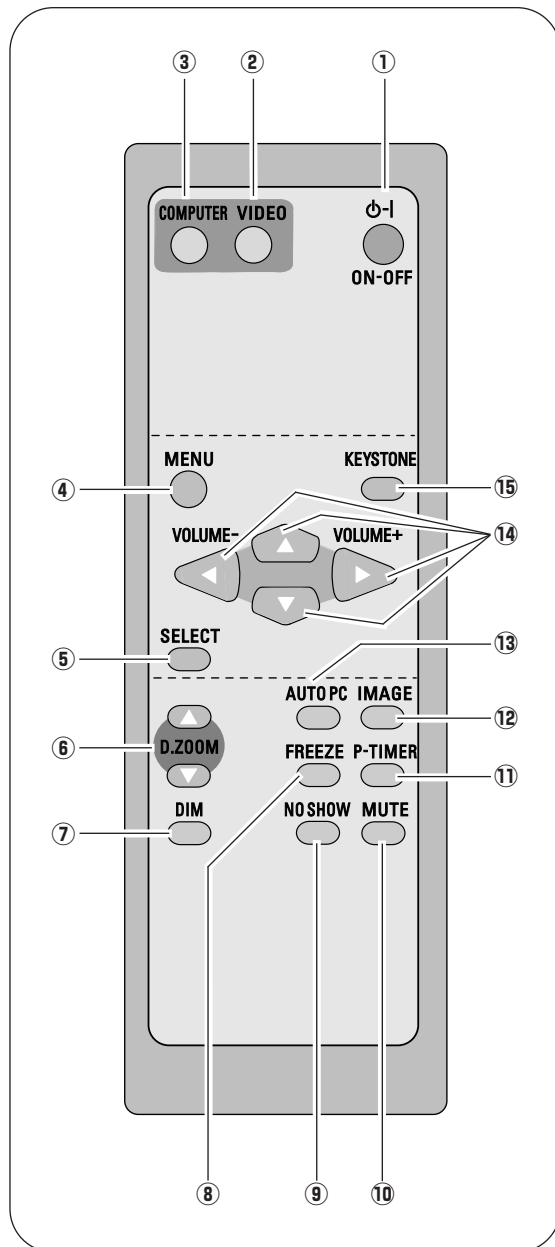

- ① **POWER ON-OFF button**
Turn the projector on or off. (p17, 18)
- ② **VIDEO button**
Select VIDEO input. (p32)
- ③ **COMPUTER button**
Select COMPUTER input source. (p24, 32)
- ④ **MENU button**
Open or close the On-Screen Menu. (p20)
- ⑤ **SELECT button**
Execute the selected item, or expand/compress the image in Digital zoom +/- mode. (p31)
- ⑥ **D.ZOOM ▲▼ buttons**
Select the Digital zoom +/- mode and resize the image. (p31)
- ⑦ **DIM button**
Dim the projection screen. (p22, 41)
- ⑧ **FREEZE button**
Freeze the picture. (p22)
- ⑨ **NO SHOW button**
Temporarily turn off the image on the screen. (p22)
- ⑩ **MUTE button**
Mute the sound. (p23)
- ⑪ **P-TIMER button**
Operate the P-timer function. (p23)
- ⑫ **IMAGE button**
Select an image level. (p29, 34)
- ⑬ **AUTO PC button**
Automatically adjust a computer image to its optimum setting. (p26)
- ⑭ **POINT ▲▼◀▶ (VOLUME +/-) buttons**
Select an item or adjust the setting value in the On-Screen Menu. They are also used to pan the image in Digital zoom + mode. (p31)
The Point ◀▶ buttons are also used as the VOLUME +/- buttons. (p23)
- ⑮ **KEYSTONE button**
Correct keystone distortion. (p22, 38)

Operating Range

Point the remote control toward the projector (Infrared Remote Receiver) when pressing any buttons. The maximum operating range for the remote control is about 16.4' (5m) and 60° in front of the projector.

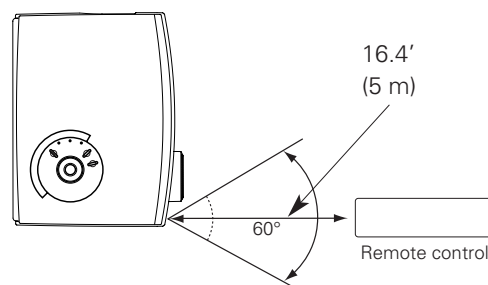

Remote Control Battery Installation

- 1** Open the battery compartment lid.

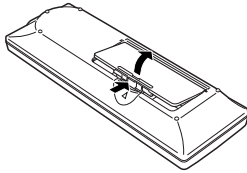

- 2** Install new batteries into the compartment.

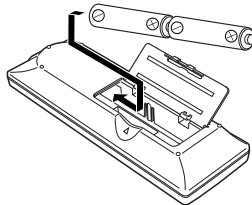

Two AA size batteries
For correct polarity (+ and -), be sure battery terminals are in contact with pins in the compartment.

- 3** Replace the compartment lid.

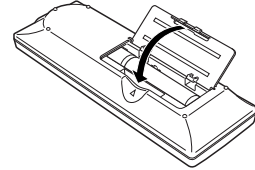

To insure safe operation, please observe the following precautions:

- Use (2) AA or LR6 type alkaline batteries.
- Always replace batteries in sets.
- Do not use a new battery with a used battery.
- Avoid contact with water or liquid.
- Do not expose the remote control to moisture or heat.
- Do not drop the remote control.
- If the battery has leaked on the remote control, carefully wipe the case clean and install new batteries.
- Risk of explosion if battery is replaced by an incorrect type.
- Dispose of used batteries according to the instructions.

Positioning the Projector

This projector is designed to project on a flat projection surface and can focus from 4.3'(1.3m) - 21.3'(6.5m). Refer to the figure and table below for the screen size and distance between the projector and the screen.

A : B = 9 : 1

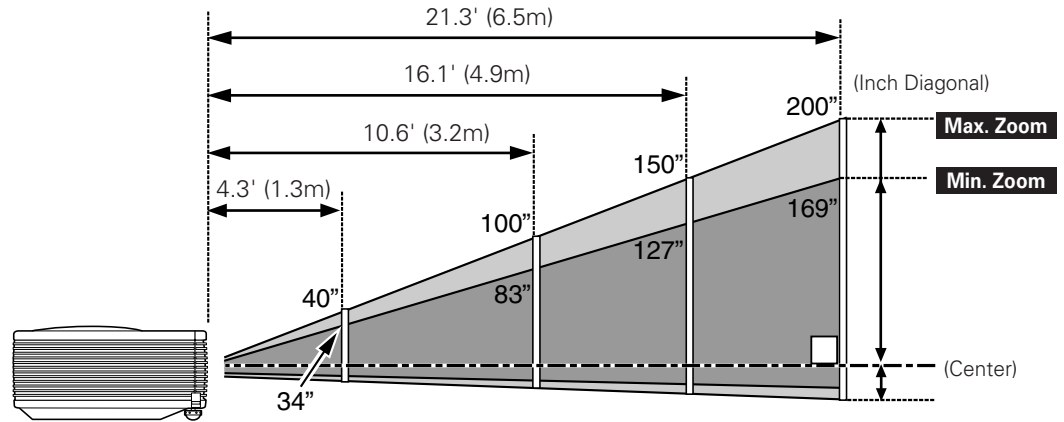

Screen Size (W x H) mm	34"	40"	100"	150"	200"
4 : 3 aspect ratio	691 x 518	813 x 610	2032 x 1524	3048 x 2286	4064 x 3048
Zoom (min)	4.3' (1.3m)	4.9' (1.5m)	12.5' (3.8m)	19.0' (5.8m)	—
Zoom (max)	—	4.3' (1.3m)	10.6' (3.2m)	16.1' (4.9m)	21.3' (6.5m)

✓ Note:

- The brightness in the room has a great influence on picture quality. It is recommended to limit ambient lighting in order to obtain the best image.
- The values shown above are approximate and may vary from the actual sizes.

Adjustable Feet

Projection angle can be adjusted up to 7.0 degrees with the adjustable feet.

- 1 Lift the front of the projector and pull the feet lock latches in each side of the projector upward.
- 2 Release the feet lock latches to lock the adjustable feet and rotate the adjustable feet to a proper height, and tilt.
- 3 To retract the adjustable feet, lift the front of the projector and undo the feet lock latches.
Keystone distortion of the projected image can be corrected by Menu Operation. (p22, 38)

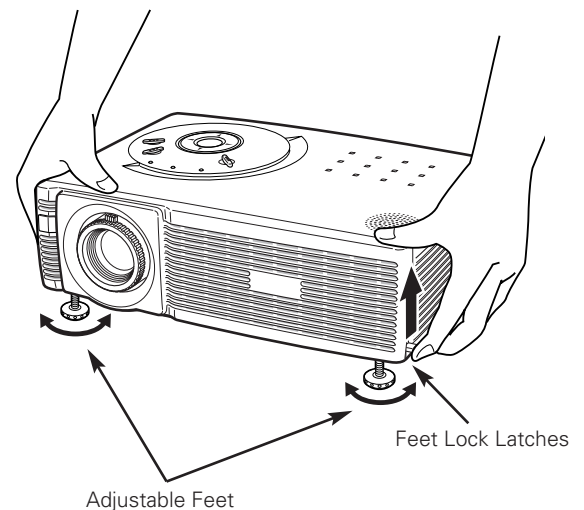

Connecting the AC Power Cord

This projector uses nominal input voltages of 100-120 V or 200-240 V AC and it automatically selects a correct input voltage. It is designed to work with the single-phase power systems having a grounded neutral conductor. To reduce the risk of electrical shock, do not plug into any other type of power system.

If you are not sure of the type of power being supplied, consult your authorized dealer or service station. Connect the projector with all peripheral equipment before turning on the projector. (See pages 15 and 16 for connection.)



CAUTION

For safety, unplug the AC power cord when the projector is not in use. When the projector is connected to an outlet with the AC power cord, it is in stand-by mode and consumes a little electric power.

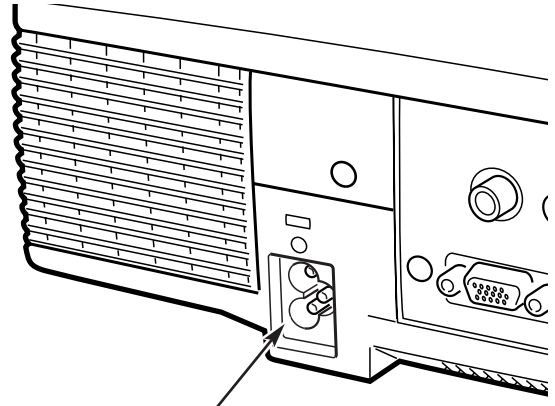

Connect the AC power cord (supplied) to the projector.

The AC outlet must be near this equipment and must be easily accessible.

NOTE ON THE POWER CORD

AC power cord must meet the requirements of the country where you use the projector. Confirm the AC plug type with the chart below and a proper AC power cord must be used.

If the supplied AC power cord does not match your AC outlet, contact your sales dealer.

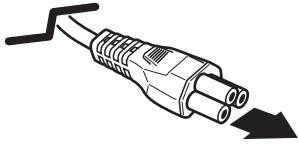
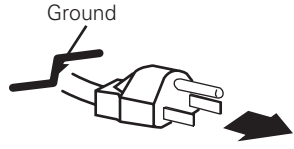
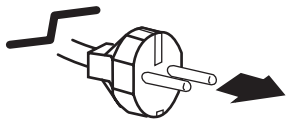
Projector side	AC outlet side	
 <p data-bbox="381 1339 560 1417">To power cord connector on your projector.</p>	<p data-bbox="657 1134 933 1165">For the U.S.A. and Canada</p>  <p data-bbox="682 1186 755 1207">Ground</p> <p data-bbox="763 1354 933 1407">To the AC outlet. (120 V AC)</p>	<p data-bbox="990 1134 1266 1165">For Continental Europe</p>  <p data-bbox="1096 1354 1282 1407">To the AC outlet. (200 - 240 V AC)</p>

Connecting to a Computer

Cables used for connection

- VGA Cable (Mini D-sub 15 pin)
 - Audio Cables (Mini Plug: stereo) *
- (* = Not supplied with this projector.)

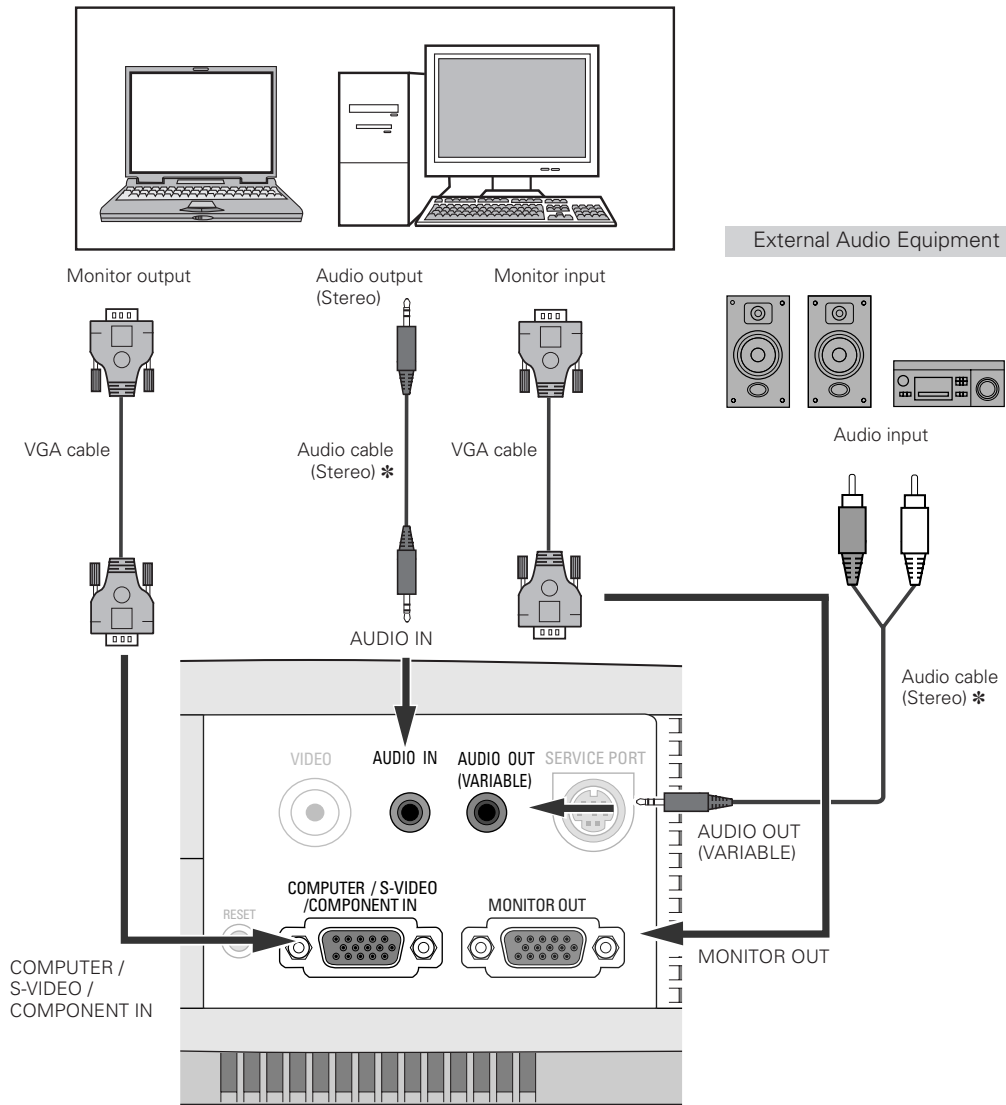

✓ **Note:**

- When connecting AUDIO OUT to external audio equipment, the projector's built-in speaker is disconnected.
- AUDIO OUT and MONITOR OUT terminals work only when the projector is under operation and do not work when the projector is in stand-by state or Power management mode (p41).
- See page 57 for ordering optional parts.



Note:

When connecting the cables, the power cords of both the projector and the external equipment should be disconnected from the AC outlet.

Connecting to Video Equipment

Cables used for connection

- Scart-VGA Cable *
 - S-VIDEO-VGA Cable *
 - S-VIDEO Cable *
 - Component-VGA Cable *
 - Component Cable *
 - Video Cable *
 - Audio Cables (Mini Plug: stereo) *
- (* = Not supplied with this projector.)

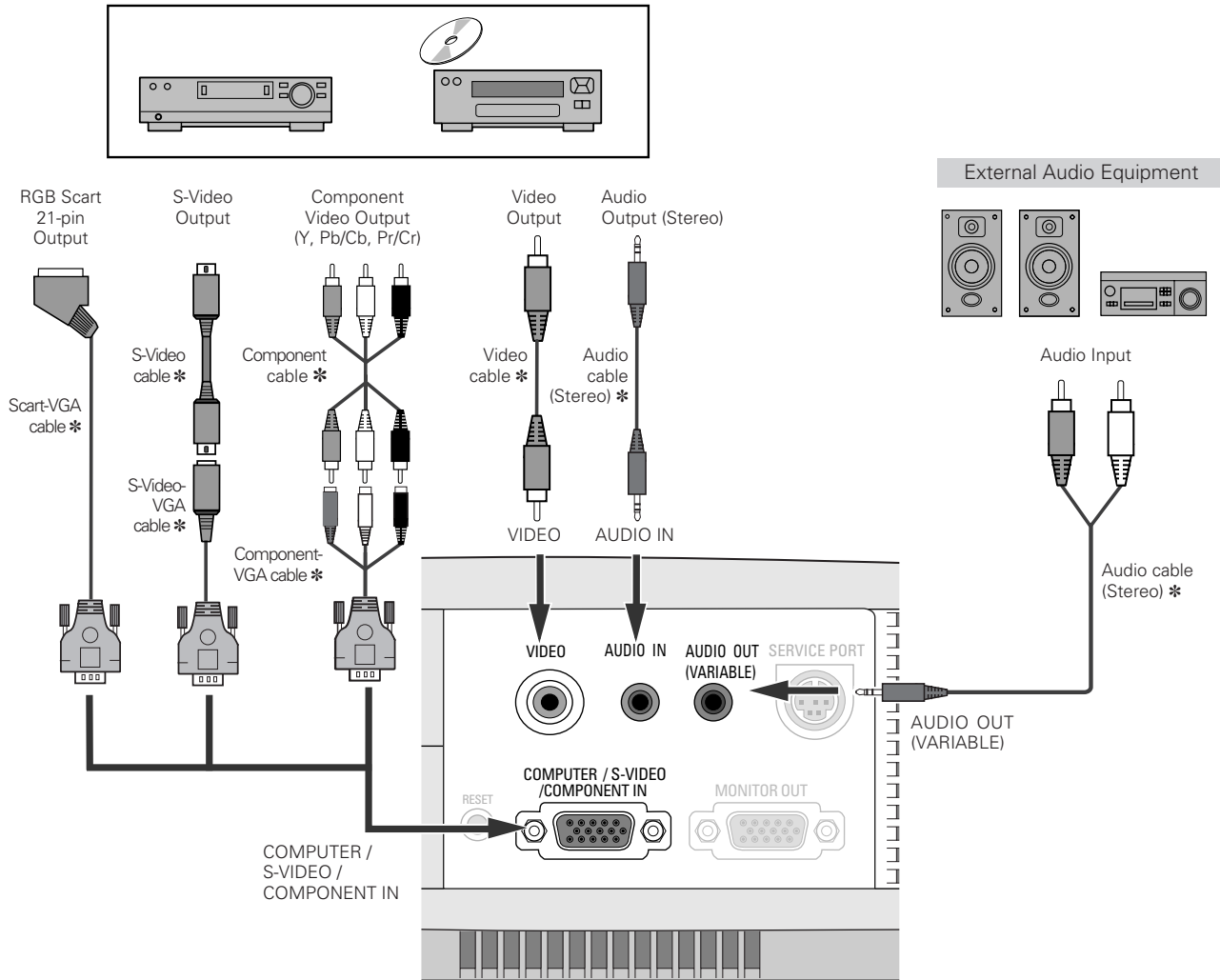

✓ **Note:**

- When connecting AUDIO OUT to external audio equipment, the projector's built-in speaker is disconnected.
- AUDIO OUT and MONITOR OUT terminals work only when the projector is under operation and do not work when the projector is in stand-by state or Power management mode (p41).
- See page 57 for ordering optional parts.



Note:

When connecting the cables, the power cords of both the projector and the external equipment should be disconnected from the AC outlet.

Turning On the Projector

- 1 Complete peripheral connections (with a computer, VCR, etc.) before turning on the projector.
- 2 Connect the projector's AC power cord into an AC outlet. The POWER indicator blinks red for a moment and then turns to steady red.
- 3 Press the POWER ON-OFF button on the top control or on the remote control. The POWER indicator turns green lighting and the cooling fans start to operate. The preparation display appears on the screen and the countdown starts.
- 4 After the countdown, the input source that was last selected and the Lamp mode status icon (see page 41) will appear on the screen.

If the projector is locked with a PIN code, PIN code Input Dialog Box appears. Enter the PIN code as instructed below.

Enter a PIN code

Select a number by pressing the Point ◀▶ buttons and fix the number with the SELECT button. The number will change to "*". If you fixed a wrong number, move the pointer to "Set" or "Clear" once by pressing the Point ▼ button, then return to "PIN code". Enter the correct number. Repeat this step to complete entering a four-digit number.

When the four-digit number is fixed, the pointer will automatically move to "Set". Press the SELECT button so that you can start to operate the projector.

If you enter a wrong PIN code, "PIN code" and the number (****) will turn red and disappear. Enter a PIN code all over again.

What is PIN code?

PIN (Personal Identification Number) code is a security code that allows the person who knows it to operate the projector. Setting a PIN code prevents unauthorized use of the projector.

A PIN code consists of a four-digit number. Refer to PIN code lock function in Setting on page 43 for locking the operation of the projector with your PIN code.



CAUTION ON HANDLING PIN CODE

If you forget your PIN code, the projector can no longer be started. Take special care in setting a new PIN code; write down the number in column on page 59 of this manual and keep it at hand. Should the PIN code be missing or forgotten, consult your dealer or service center.



The preparation display disappears after 20 seconds.

Selected Input Source and Lamp Mode



(See page 41 for Lamp mode.)

PIN code Input Dialog Box



OK

After the OK icon disappears, you can operate the projector.

Turning Off the Projector

- 1** Press the POWER ON-OFF button on the top control or on the remote control, and the message "Power off?" appears on the screen.
- 2** Press the POWER ON-OFF button again to turn off the projector. The POWER indicator starts to blink red and it continues blinking while the cooling fans are operating for about 90 seconds. (About 120 seconds when the fan mode is L2. See page 44.)
- 3** When the projector has cooled down enough to be turned on again, the POWER indicator stops blinking and turns to steady red. Then you can unplug the AC power cord.

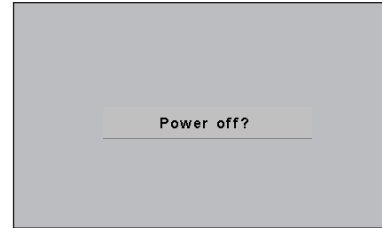

The message disappears after 4 seconds.



TO MAINTAIN THE LIFE OF LAMP, ONCE YOU TURN THE PROJECTOR ON, WAIT AT LEAST 5 MINUTES BEFORE TURNING IT OFF. DO NOT UNPLUG THE AC POWER CORD WHILE THE COOLING FANS ARE RUNNING OR BEFORE THE POWER INDICATOR STOPS BLINKING. OTHERWISE IT WILL RESULT IN SHORTENING THE LAMP LIFE.

✓ **Note:**

- You cannot turn on the projector during the cooling period with the POWER indicator blinking red. Turn it on after the POWER indicator stops blinking and turns to steady red.
- When the On start function is on, the projector is turned on automatically by connecting the AC power cord to an AC outlet. (See page 41 for the On start function.)
- Do not operate the projector continuously without rest. Continuous use may result in shortening the lamp life. Turn off the projector and rest it for about an hour in every 24 hours.
- The running speed of cooling fans is changed according to the temperature inside the projector.
- If the WARNING indicator blinks or turns red, see "Warning Indicator" on page 45.

Zoom and Focus Adjustment

Rotate the Zoom Lever to zoom in and out.
Rotate the Focus Ring to bring the image into focus.

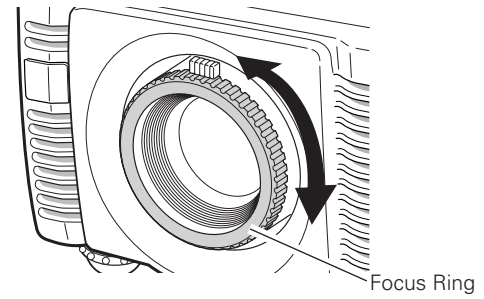
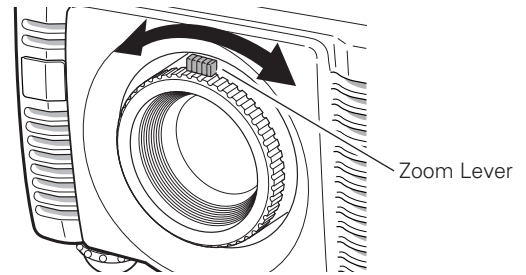

How to Operate the On-Screen Menu

The projector can be adjusted or set via the On-Screen Menu. Refer to the following pages regarding each adjustment and setting procedure.

- 1 Press the MENU button to display the On-Screen Menu.
- 2 Press the Point ◀▶ buttons to select a Menu icon to adjust. Press the Point ▲▼ buttons to select an item to adjust.
- 3 Press the SELECT button to show the item data. Press the Point ◀▶ buttons to adjust the data. Refer to the following pages for each adjustment.

✓ Note:

- The selected item is not active until the SELECT button is pressed.

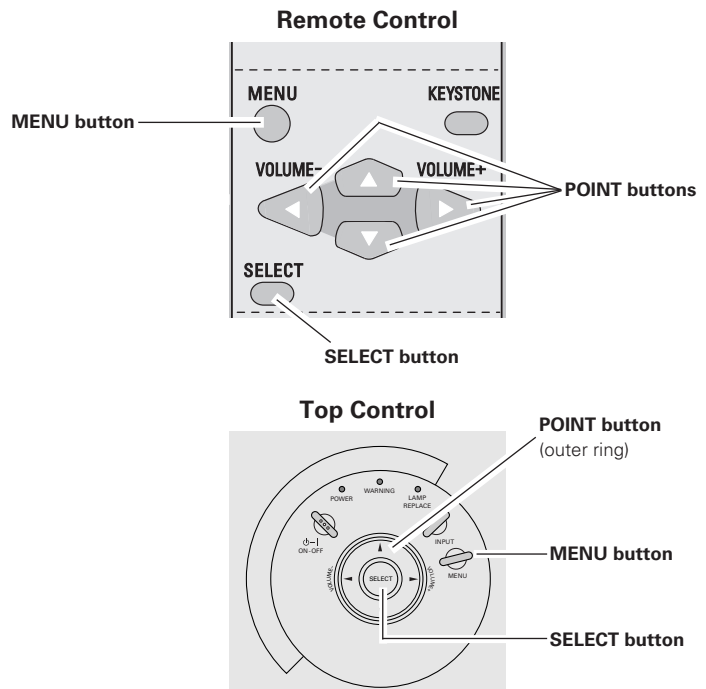
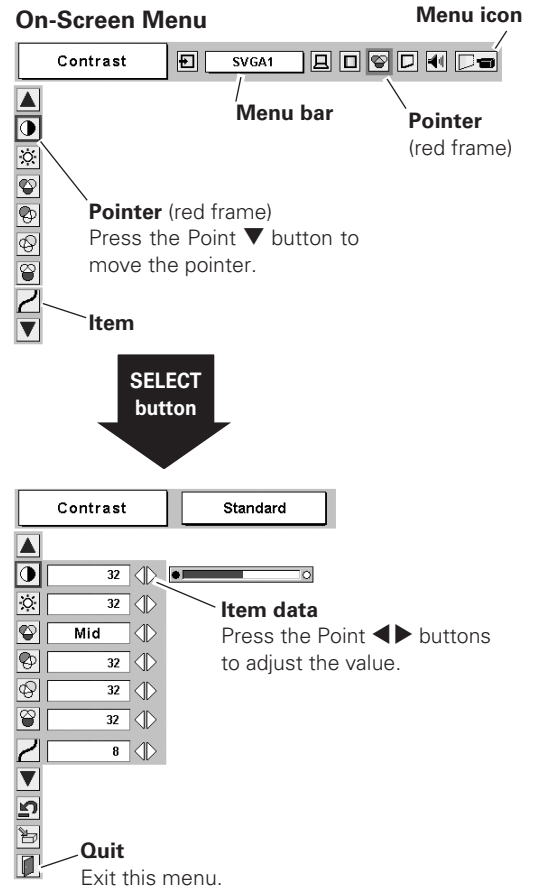

Menu Bar

For computer source

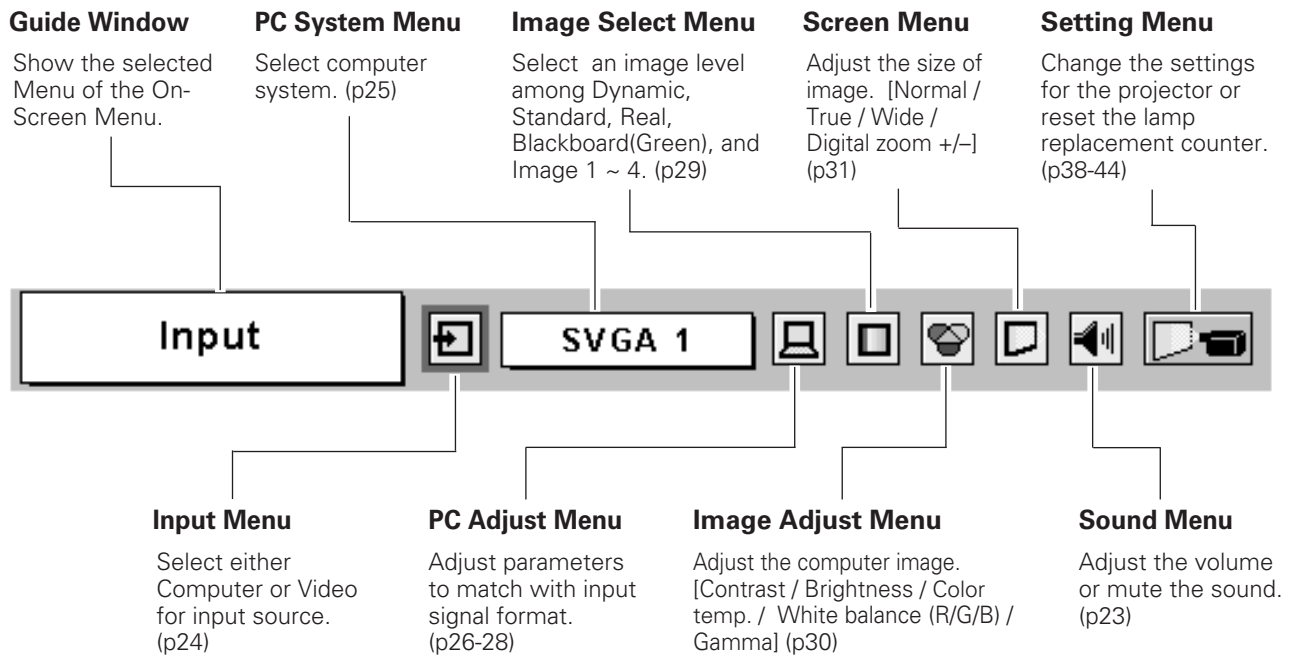

For video source

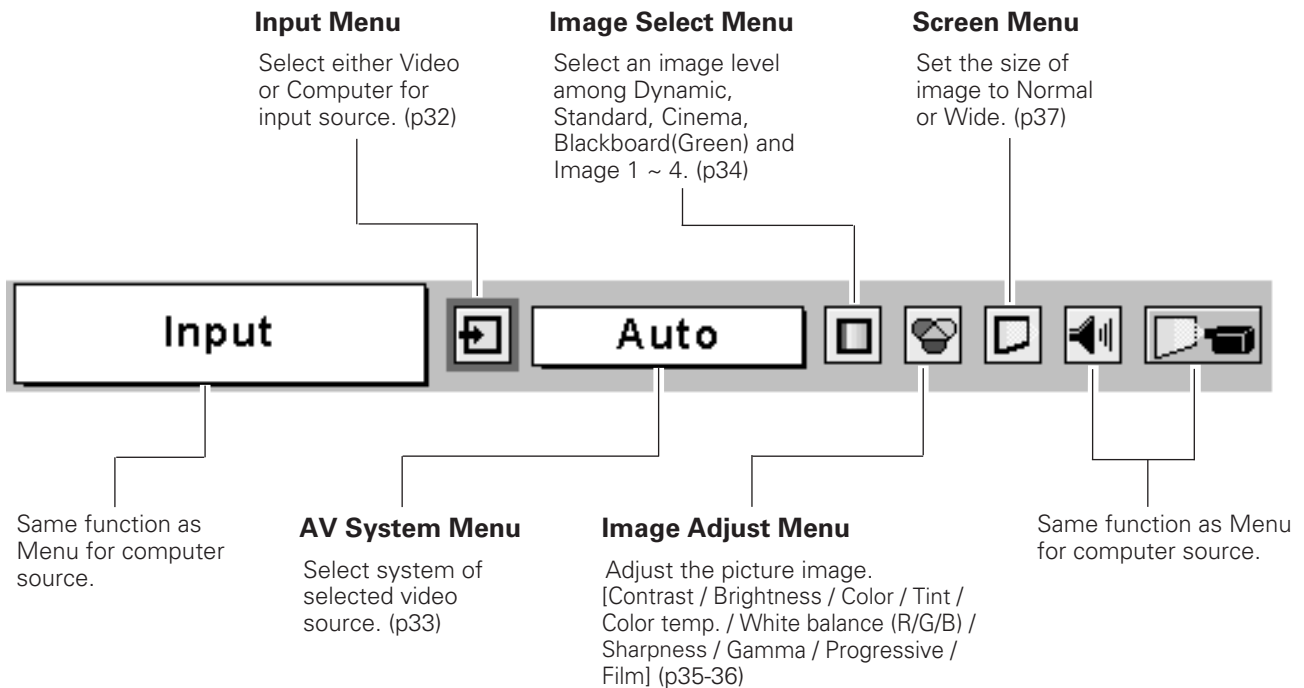

Keystone Correction

If a projected picture has keystone distortion, correct the image with the keystone correction function.

- 1 Press the KEYSTONE button on the remote control or select Keystone on the Setting Menu (p38) to display the Keystone dialog box.
- 2 Correct keystone distortion by pressing the Point ▲▼ buttons. Press the Point ▲ button to reduce the upper part of image, and press the Point ▼ button to reduce the lower part.



- The arrows are white when no correction.
- The arrows in the corrected direction will turn red.
- The arrows disappear at the maximum correction.
- If you press the KEYSTONE button on the remote control once more while the keystone dialog box is being displayed, the correction will be canceled.

Reduce the upper width with the Point ▲ button.

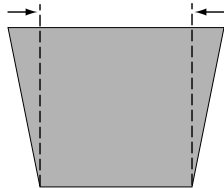

Reduce the lower width with the Point ▼ button.

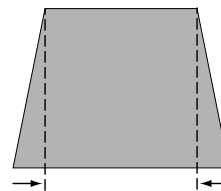

Picture Freeze Function

Press the FREEZE button on the remote control to freeze the picture on the screen. To cancel the Freeze function, press the FREEZE button again or press any other button.

Dim Mode

The Dim mode function is provided to dim the contrast and brightness of the projection screen. Press the DIM button on the remote control to dim the screen. Press the DIM button again to return to the previous screen. Contrast level of the Dim mode screen can be adjusted in the Setting Menu. (p41)

Remote Control

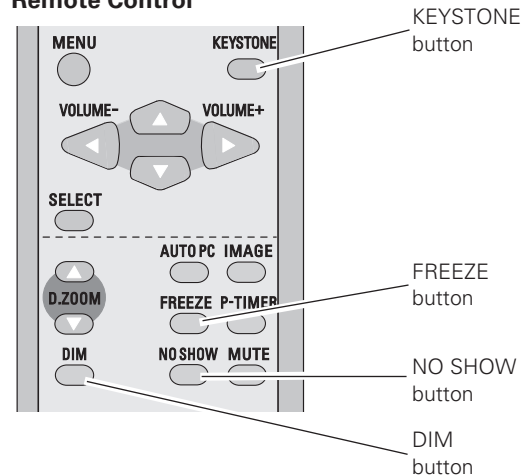

No Show Function

Press the NO SHOW button on the remote control to black out the image. To restore to normal, press the NO SHOW button again or press any other button. When a projected image is captured and set as "User" in the Logo item in the Setting Menu (p40), the screen changes each time you press the NO SHOW button as follows.

black-out → the captured image → normal →

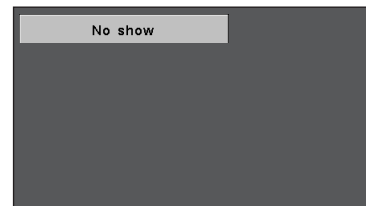

The message disappears after 4 seconds.

P-Timer Function

Press the P-TIMER button on the remote control. The timer display "00 : 00" appears on the screen and starts to count time (00 : 00 ~ 59 : 59).

To stop the P-Timer, press the P-TIMER button. Press the P-TIMER button again to cancel the P-Timer function.



Sound Adjustment

Direct Operation

Volume

Press the VOLUME +/- buttons on the top control or on the remote control to adjust the volume. The volume dialog box appears on the screen for a few seconds.

Press the + button to turn up the volume and the - button to turn down the volume.

Mute

Press the MUTE button on the remote control to turn off the sound. To restore the sound to its previous level, press the MUTE button again or press the VOLUME +/- buttons.

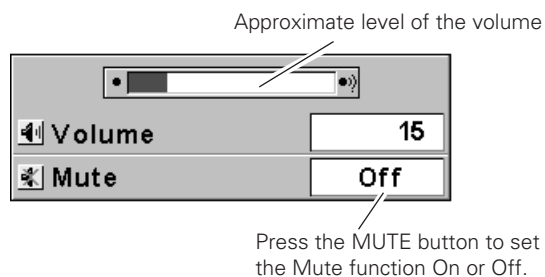

The display disappears after 4 seconds.

Menu Operation

- 1 Press the MENU button to display the On-Screen Menu. Press the Point ◀▶ buttons to move the red frame pointer to the Sound Menu icon.
- 2 Press the Point ▼ button to move the red frame pointer to the desired item and then press the SELECT button.

Volume

Press the Point ▶ button to turn up the volume, and press the Point ◀ button to turn down the volume.

Mute

Press the Point ◀▶ buttons to turn off the sound. The mute dialog box display is changed to "On" and the sound is turned off. To restore the sound to its previous level, press the Point ◀▶ buttons again.

Remote Control

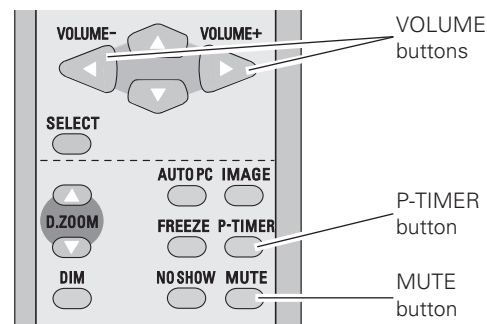

Sound Menu

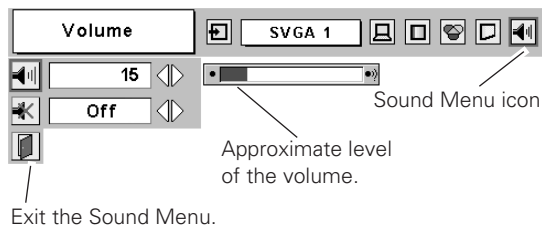

Computer Input

Input Source Selection

Direct Operation

Choose Computer by pressing the INPUT button on the top control or press the COMPUTER button on the remote control. Before using these buttons, a correct input source should be selected through Menu Operation as described below.

Top Control

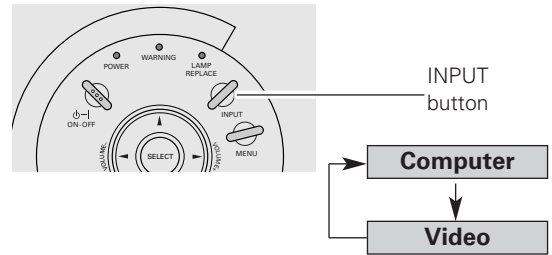

Remote Control

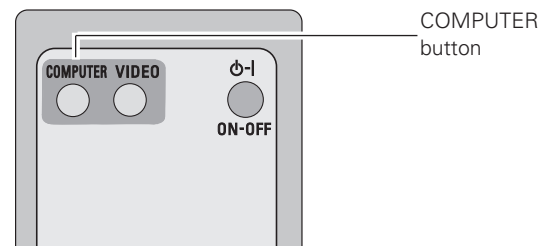

Menu Operation

- 1 Press the MENU button to display the On-Screen Menu. Press the Point ◀▶ buttons to move the red frame pointer to the Input Menu icon.
- 2 Press the Point ▼ button to move the red arrow pointer to Computer and then press the SELECT button.
- 3 After the Source Select Menu appears for Computer, move the pointer to RGB and then press the SELECT button.

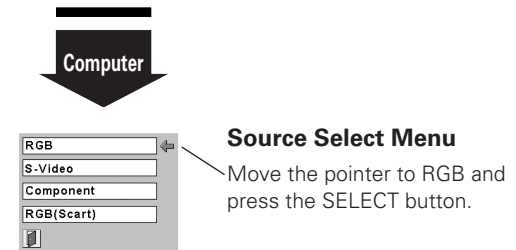
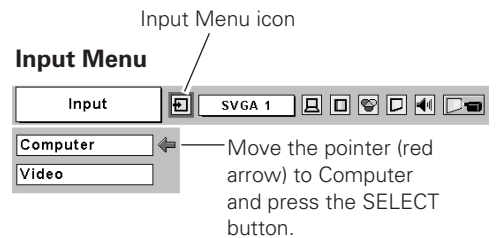

Computer System Selection

This projector automatically tunes to various types of computers based on VGA, SVGA, XGA or SXGA with its Multi-scan system and Auto PC Adjustment. If Computer is selected as a signal source, this projector automatically detects the signal format and tunes to project a proper image without any additional settings. (The signal formats provided in this projector is shown on page 55.)

One of the following messages may appear when:

- Auto** The projector cannot recognize the connected signal conforming to the provided PC Systems. The message "Auto" is displayed on the PC System Menu icon and the Auto PC Adjustment function works to display proper images. If the image is not projected properly, a manual adjustment is required. (p27, 28)
- There is no signal input from computer. Check the connection between your computer and the projector. (See " Troubleshooting" on page 50.)
- Mode 1** The preset system is manually adjusted in the PC Adjust Menu. The adjusted data can be stored in Mode 1~5. (p27, 28)
- SVGA 1** PC Systems provided in this projector is chosen. The projector chooses a proper system provided in the projector and displays it.

*Mode 1 and SVGA 1 are examples.

PC System Menu

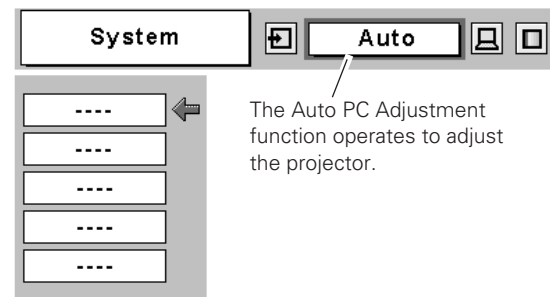

Selecting Computer System Manually

PC system can also be selected manually.

- 1** Press the MENU button to display the On-Screen Menu. Press the Point ◀▶ buttons to move the red frame pointer to the PC System Menu icon.
- 2** Press the Point ▼ button to move the red arrow pointer to the desired system and then press the SELECT button.

PC System Menu

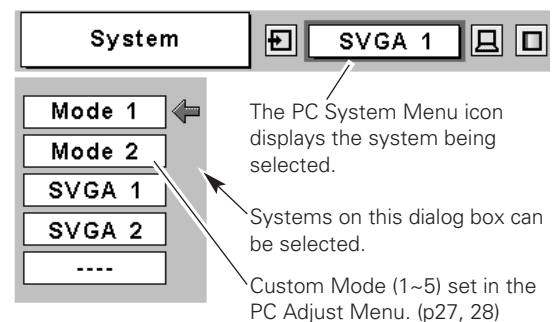

Auto PC Adjustment

The Auto PC Adjustment function is provided to automatically adjust Fine sync, Total dots, Horizontal and Vertical positions to conform to your computer. Auto PC Adjustment function can be operated as follows.

Direct Operation

The Auto PC Adjustment function can be operated directly by pressing the AUTO PC button on the remote control.

Remote Control

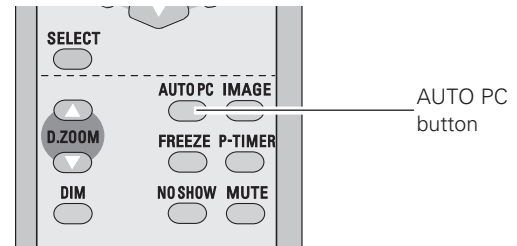

Menu Operation

Auto PC adj.

- 1 Press the MENU button to display the On-Screen Menu. Press the Point ◀▶ buttons to move the red frame pointer to PC Adjust Menu icon.
- 2 Press the Point ▼ button to move the red frame pointer to Auto PC adj. icon and then press the SELECT button twice.

To store the adjusted parameters

The system parameters adjusted in the Auto PC Adjustment can be stored in the projector. Once the parameters are stored, the setting can be done just by selecting Mode in the PC System Menu (p25). See "Store" on page 28.

✓ Note:

- Fine sync, Total dots and Picture Position of some computers can not be fully adjusted with the Auto PC Adjustment function. When the image is not provided properly, manual adjustments are required (p27, 28).
- The Auto PC Adjustment cannot be operated when 480i, 575i, 480p, 575p, 720p, 1035i, or 1080i is selected in the PC System Menu (p25).

PC Adjust Menu

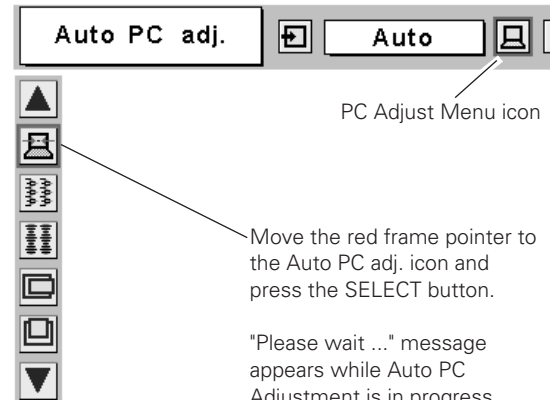

Manual PC Adjustment

Some computers employ special signal formats which may not be tuned by Multi-scan system of this projector. Manual PC Adjustment enables you to precisely adjust several parameters to match those signal formats. The projector has 5 independent memory areas to store those parameters manually adjusted, which allows you to recall the setting for a specific computer.

- 1 Press the MENU button to display the On-Screen Menu. Press the Point ◀▶ buttons to move the red frame pointer to the PC Adjust Menu icon.
- 2 Press the Point ▼ button to move the red frame pointer to the desired item and then press the SELECT button. The adjustment dialog box will appear. Press the Point ◀▶ buttons to adjust the value.

Fine sync

Eliminate a flicker from the image displayed. Press the Point ◀▶ buttons to adjust the value. (From 0 to 31.)

Total dots

Adjust the number of total dots in one horizontal period. Press the Point ◀▶ buttons to adjust the number to match your PC image.

Horizontal

Press the Point ◀▶ buttons to adjust the horizontal picture position.

Vertical

Press the Point ◀▶ buttons to adjust the vertical picture position.

Current mode

Press the SELECT button to show H-sync freq. and V-sync freq. of the connected computer.

Clamp

Adjust the clamp level. When the image has dark bars, try this adjustment.

PC Adjust Menu

PC Adjust Menu icon

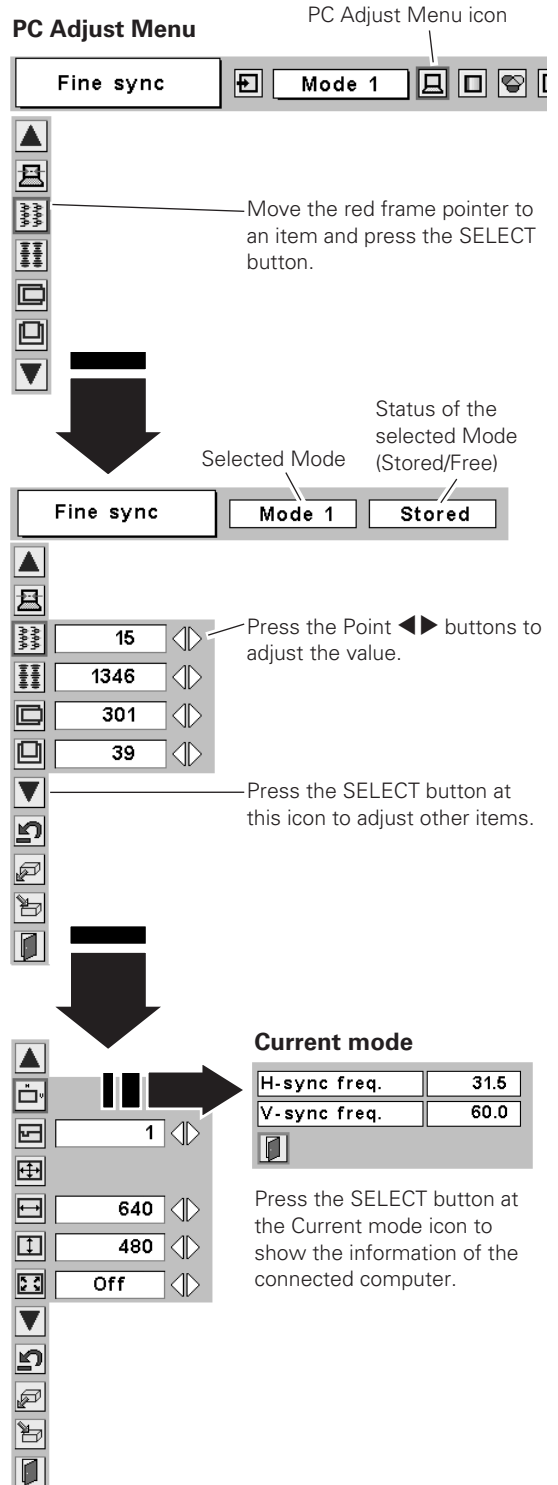

Fine sync Mode 1

Move the red frame pointer to an item and press the SELECT button.

Selected Mode Status of the selected Mode (Stored/Free)

Fine sync Mode 1 Stored

Press the Point ◀▶ buttons to adjust the value.

15 1346 301 39

Press the SELECT button at this icon to adjust other items.

Current mode

H-sync freq.	31.5
V-sync freq.	60.0

Press the SELECT button at the Current mode icon to show the information of the connected computer.

 **Display area**

Press the SELECT button to display the Display area dialog box and select the resolution.

 **Display area H**

Adjust the horizontal area displayed by the projector. Press the Point ◀▶ buttons to decrease/increase the value and then press the SELECT button.

 **Display area V**

Adjust the vertical area displayed by the projector. Press the Point ◀▶ buttons to decrease/increase the value and then press the SELECT button.

 **Full screen**

With this function on, SXGA image is fully displayed at 4 : 3 aspect ratio. It is displayed at 5 : 4 aspect ratio with this function off.

 **Reset**

To reset the adjusted data, select Reset and press the SELECT button. The confirmation box will appear and then select [Yes]. All adjustments return to their previous figures.

 **Mode free**

To clear the adjusted data previously set, move the red frame pointer to the Mode free icon and then press the SELECT button. Move the red arrow pointer to the Mode that you want to clear and then press the SELECT button.

 **Store**

To store adjusted data, move the red frame pointer to the Store icon and then press the SELECT button. Move the red arrow pointer to any of Mode 1 to 5 in which you want to store and then press the SELECT button.

 **Quit**

Exit the PC Adjust Menu.

✓ **Note:**

- Auto PC Adjustment, Display area, Display area (H/V), and Full screen cannot be selected when 480i, 575i, 480p, 575p, 720p, 1035i, or 1080i is selected in the PC System Menu (p25).

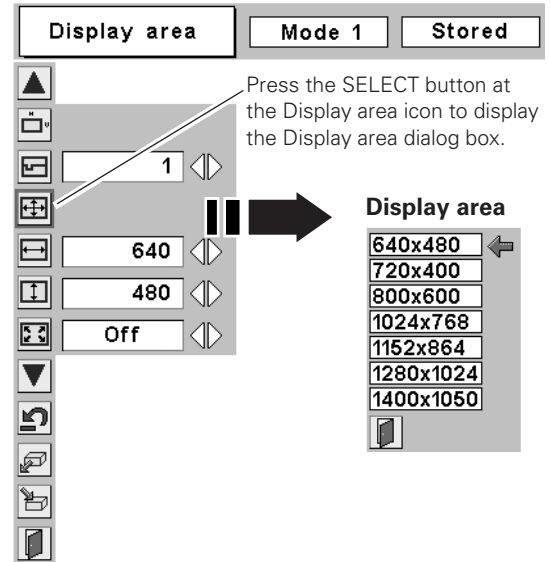

Press the SELECT button at the Display area icon to display the Display area dialog box.

To clear adjusted data

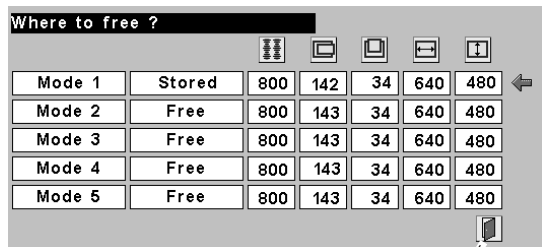

Close this dialog box.

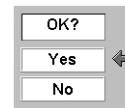

The confirmation box will appear and then select [Yes].

To store adjusted data

This Mode has the parameters being stored.

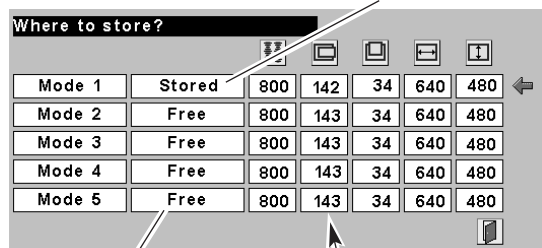

Vacant

Values of "Total dots", "Horizontal", "Vertical", "Display area H", and "Display area V".

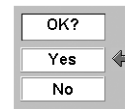

The confirmation box will appear and then select [Yes].

Image Level Selection

Direct Operation

Select an image level among Dynamic, Standard, Real, Blackboard(Green), Image 1, Image 2, Image 3, and Image 4 by pressing the IMAGE button on the remote control.

Dynamic

Picture level suitable for viewing a picture in a bright room.

Standard

Normal picture level preset on this projector.

Real

Picture level with improved halftone for graphics.

Blackboard(Green)

Picture level suitable for the image projected on a blackboard. This mode helps to enhance the image contrast projected on the blackboard. This is mainly effective on a green colored board, not truly effective on a black colored board.

Image 1~4

User preset image in the Image Adjust Menu (p30).

Menu Operation

- 1 Press the MENU button to display the On-Screen Menu. Press the Point ◀▶ buttons to move the red frame pointer to the Image Select Menu icon.
- 2 Press the Point ▼ button to move the red frame pointer to the desired level and then press the SELECT button.

Dynamic

Picture level suitable for viewing a picture in a bright room.

Standard

Normal picture level preset on this projector.

Real

Picture level with improved halftone for graphics.

Blackboard(Green)

Picture level suitable for the image projected on a blackboard. See above for further details.

Image 1~4

User preset image in the Image Adjust Menu (p30).

Remote Control

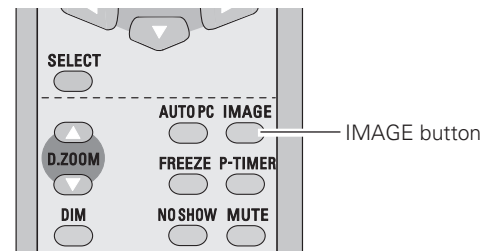

IMAGE button

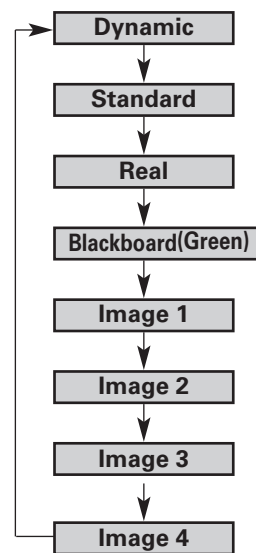
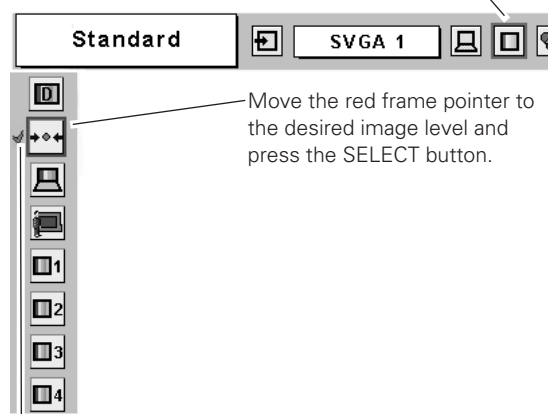

Image Select Menu



The image level being selected.

Image Level Adjustment

- 1 Press the MENU button to display the On-Screen Menu. Press the Point ◀▶ buttons to move the red frame pointer to the Image Adjust Menu icon.
- 2 Press the Point ▼ button to move the red frame pointer to the desired item and then press the SELECT button. The level of each item is displayed. Adjust each level by pressing the Point ◀▶ buttons.

Contrast

Press the Point ◀ button to decrease the contrast and the Point ▶ button to increase the contrast. (From 0 to 63.)

Brightness

Press the Point ◀ button to adjust the image darker and the Point ▶ button to adjust the image brighter. (From 0 to 63.)

Color temp.

Press the Point ◀▶ buttons to select the desired Color temp. level. (XLow, Low, Mid, or High)

White balance (Red)

Press the Point ◀ button to lighten red tone and the Point ▶ button to deepen red tone. (From 0 to 63.)

White balance (Green)

Press the Point ◀ button to lighten green tone and the Point ▶ button to deepen green tone. (From 0 to 63.)

White balance (Blue)

Press the Point ◀ button to lighten blue tone and the Point ▶ button to deepen blue tone. (From 0 to 63.)

Gamma

Press the Point ◀▶ buttons to obtain a better balance of contrast. (From 0 to 15.)

Reset

To reset the adjusted data, select Reset and press the SELECT button. The confirmation box will appear and then select [Yes]. All adjustments return to their previous figures.

Store

To store the adjusted data, select Store and press the SELECT button. The confirmation box will appear and then select [Yes]. Stored data can be called up by selecting "Image" in the Image Level Selection on page 29. If you change the Image level (p29) without storing the adjusted data, the figures will go back to the factory default settings.

Quit

Exit the Image Adjust Menu.

✓ Note:

- After adjusting the White balance of Red, Green or Blue, the Color temp. level will change to "Adj".

Image Adjust Menu

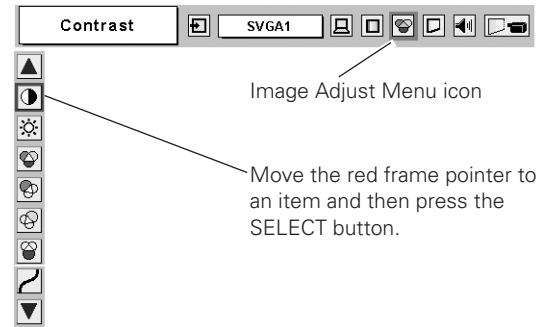
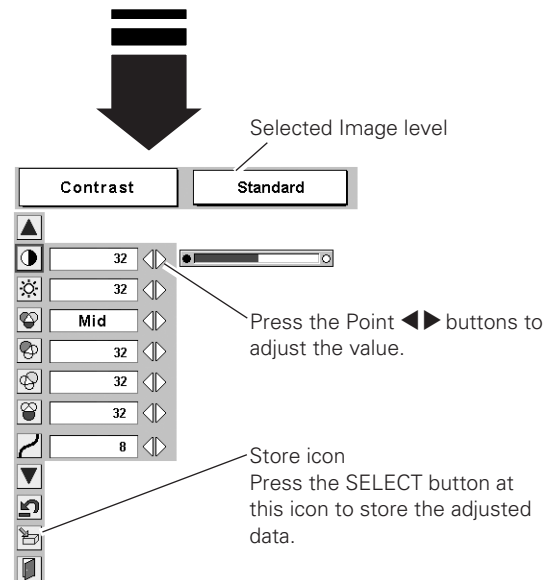

Image Adjust Menu icon

Move the red frame pointer to an item and then press the SELECT button.



Selected Image level

Press the Point ◀▶ buttons to adjust the value.

Store icon
Press the SELECT button at this icon to store the adjusted data.

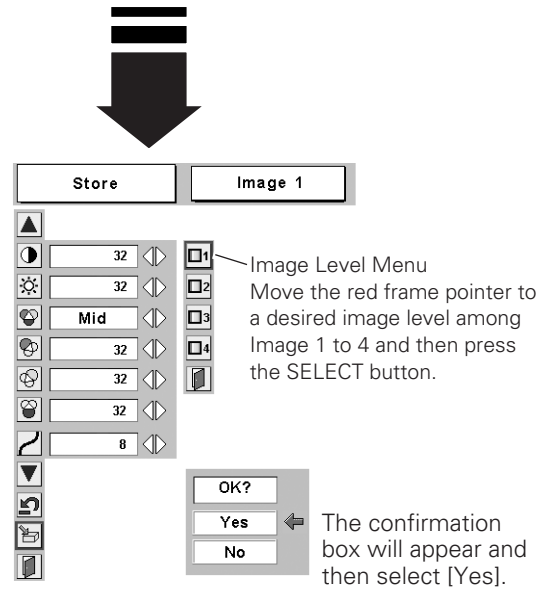

Image Level Menu
Move the red frame pointer to a desired image level among Image 1 to 4 and then press the SELECT button.

OK?
Yes
No
The confirmation box will appear and then select [Yes].

Screen Size Adjustment

This projector has the picture screen resize function which enables you to customize the image size.

- 1 Press the MENU button to display the On-Screen Menu. Press the Point ◀▶ buttons to move the red frame pointer to the Screen Menu icon.
- 2 Press the Point ▼ button and move the red frame pointer to the desired function and then press the SELECT button.

Normal

Provides the image to fit the screen size.

True

Provides the image in its original size. When the original image size is larger than the screen size (800 x 600), the projector automatically switches to "Digital zoom +" mode.

Wide

Provides the image to fit the wide video aspect ratio (16 : 9) by expanding the image width uniformly. This function can be used to provide the squeezed video signal at 16 : 9.

Digital zoom +

When the Digital zoom + is selected, the On-Screen Menu disappears and the message "D. zoom +" appears. Press the SELECT button to expand the image size. Press the Point ▲▼◀▶ buttons to pan the image. The Panning function can work only when the image is larger than the screen size.

The projected image can also be expanded by pressing the D.ZOOM ▲ button on the remote control.

Digital zoom -

When the Digital zoom - is selected, the On-Screen Menu disappears and the message "D. zoom -" appears. Press the SELECT button to compress the image size.

The projected image can also be compressed by pressing the D.ZOOM ▼ button on the remote control.

To exit the Digital zoom +/- mode, press any button except the D.ZOOM ▲▼, SELECT, and Point buttons.

To return to the previous screen size, select a screen size from the Screen Size Adjustment or select an input source from the Input Source Selection (p24) again, or adjust the screen size with the D.ZOOM buttons.

✓ Note:

- The Screen Menu cannot be operated when "720p(HDTV)", "1035i (HDTV)", or "1080i (HDTV)" is selected in the PC System Menu (p25).
- The True and Digital Zoom +/- cannot be selected when "480i", "575i", "480p", or "575p" is selected in the PC System Menu (p25).
- This projector cannot display any resolution higher than 1280 x 1024. If your computer's screen resolution is higher than 1280 X 1024, lower the resolution before connecting to the projector.
- The image data other than SVGA (800 x 600) is modified to fit the screen size in initial mode.
- The panning function may not operate properly if the computer system prepared in the PC Adjust Menu is used.

Screen Menu

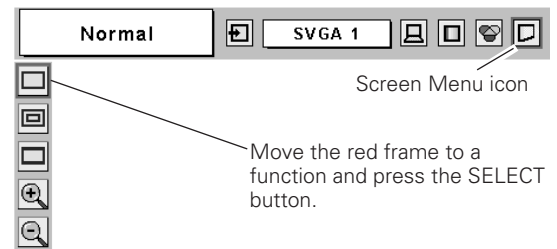

Remote Control

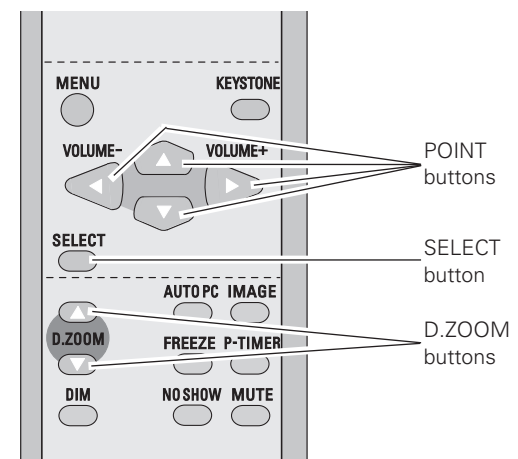

Video Input

Input Source Selection

Direct Operation

Choose either Video or Computer by pressing the INPUT button on the top control or VIDEO or COMPUTER button on the remote control.

Before using these buttons, a correct input source should be selected through Menu Operation as described below.

Top Control

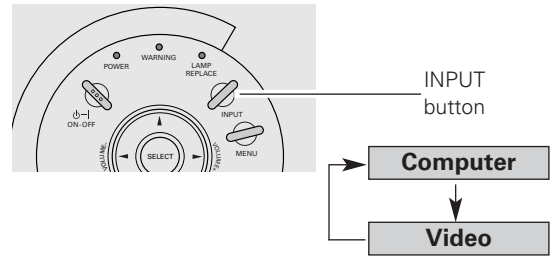

Remote Control

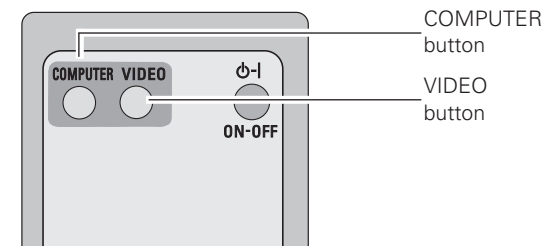

Menu Operation

- 1 Press the MENU button to display the On-Screen Menu. Press the Point ◀▶ buttons to move the red frame pointer to the Input Menu icon.
- 2 Press the Point ▼ button to move the red arrow pointer to Video or Computer and then press the SELECT button. The Source Select Menu will appear. When selecting VIDEO, video input is selected. When selecting COMPUTER, go to Step 3 to select an input source.
- 3 Move the pointer to a correct input source and then press the SELECT button.

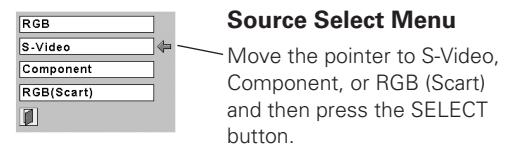
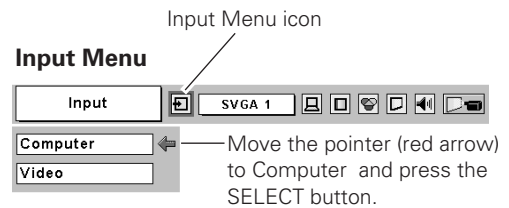

S-Video When the input source is connected to the COMPUTER / S-VIDEO / COMPONENT IN with a S-Video-VGA Cable, select S-Video.

Component When the input source is coming from video equipment connected to the COMPUTER / S-VIDEO / COMPONENT IN with a Component-VGA Cable, select Component.

RGB (Scart) When the input source is coming from video equipment connected to the COMPUTER / S-VIDEO / COMPONENT IN with a Scart-VGA Cable, select RGB (Scart).

✓ Note:

- S-Video-VGA Cable, Component-VGA Cable and Scart-VGA Cable are optionally supplied. See page 57 for order.

Image Level Selection

Direct Operation

Select a desired image level among Dynamic, Standard, Cinema, Blackboard (Green), Image 1, Image 2, Image 3, and Image 4 by pressing the IMAGE button on the remote control.

Dynamic

Picture level suitable for viewing a picture in a bright room.

Standard

Normal picture level preset on this projector.

Cinema

Picture level adjusted for the fine tone picture.

Blackboard(Green)

Picture level suitable for the image projected on a blackboard. This mode helps to enhance the image contrast projected on the blackboard. This is mainly effective on a green colored board, not truly effective on a black colored board.

Image 1~4

User preset image in the Image Adjust Menu (p35, 36).

Menu Operation

- 1 Press the MENU button to display the On-Screen Menu. Press the Point ◀▶ buttons to move the red frame pointer to the Image Select Menu icon.
- 2 Press the Point ▼ button to move the red frame pointer to the desired level and then press the SELECT button.

Dynamic

Picture level suitable for viewing a picture in a bright room.

Standard

Normal picture level preset on this projector.

Cinema

Picture level adjusted for the picture with fine tone.

Blackboard(Green)

Picture level suitable for the image projected on a blackboard. See above for further details.

Image 1~4

User preset image in the Image Adjust Menu (p35, 36).

Remote Control

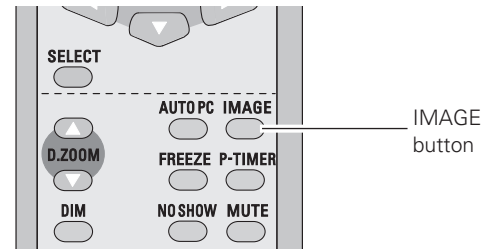

IMAGE button

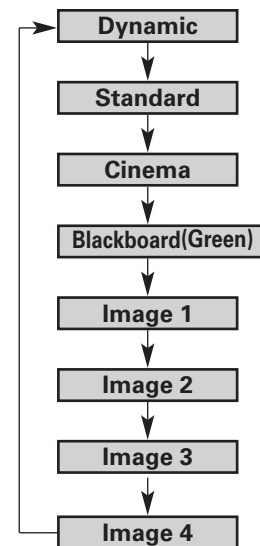
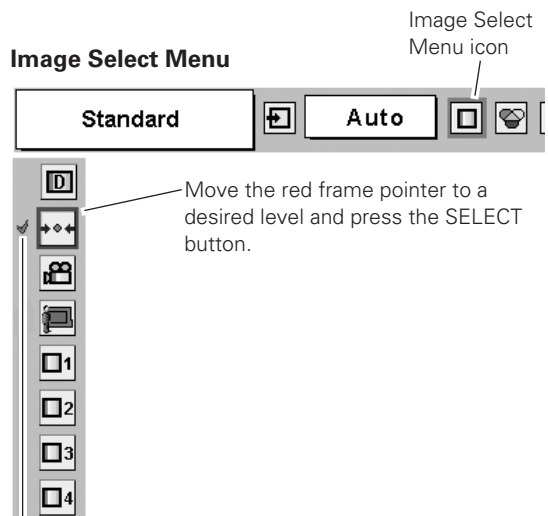

Image Select Menu



The image level being selected.

Image Level Adjustment

- 1 Press the MENU button to display the On-Screen Menu. Press the Point ◀▶ buttons to move the red frame pointer to the Image Adjust Menu icon.
- 2 Press the Point ▼ button to move the red frame pointer to the desired item and then press the SELECT button. The level of each item is displayed. Adjust each level by pressing the Point ◀▶ buttons.

Contrast

Press the Point ◀ button to decrease the contrast and the Point ▶ button to increase the contrast. (From 0 to 63.)

Brightness

Press the Point ◀ button to adjust the image darker and the Point ▶ button to adjust the image brighter. (From 0 to 63.)

Color

Press the Point ◀ button to lighten the color and the Point ▶ button to deepen the color. (From 0 to 63.)

Tint

Press the Point ◀▶ buttons to obtain a proper color. (From 0 to 63.)

Color temp.

Press the Point ◀▶ buttons to select the desired Color temp. level. (XLow, Low, Mid, or High)

White balance (Red)

Press the Point ◀ button to lighten red tone and the Point ▶ button to deepen red tone. (From 0 to 63.)

White balance (Green)

Press the Point ◀ button to lighten green tone and the Point ▶ button to deepen green tone. (From 0 to 63.)

White balance (Blue)

Press the Point ◀ button to lighten blue tone and the Point ▶ button to deepen blue tone. (From 0 to 63.)

Sharpness

Press the Point ◀ button to soften the image and the Point ▶ button to sharpen the image. (From 0 to 15.)

Gamma

Press the Point ◀▶ buttons to obtain better balance of contrast. (From 0 to 15.)

✓ Note:

- The Tint cannot be adjusted when the video system is PAL, SECAM, PAL-M, or PAL-N.
- After adjusting the White balance of Red, Green or Blue, the Color temp. level will change to "Adj."

Image Adjust Menu



Image Adjust Menu icon

Move the red frame pointer to an item and then press the SELECT button.

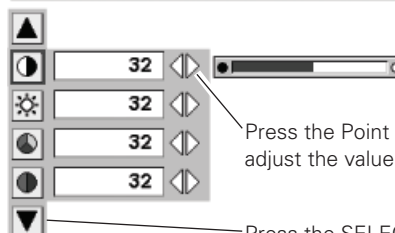
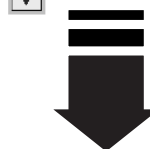

Press the Point ◀▶ buttons to adjust the value.

Press the SELECT button at this icon to display other items.

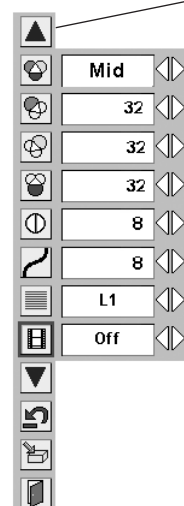

Press the SELECT button at this icon to display previous items.

Progressive

Interlaced video signal can be displayed in a progressive picture.

- Off Not activated.
- L1 Select "L1" for a moving picture.
- L2 Select "L2" for a still picture.

Film

This function operates on 3-2 pulldown video sources. When this function is "On", the projector reproduces pictures faithful to the original film quality.

Reset

To reset the adjusted data, select Reset and press the SELECT button. The confirmation box will appear and then select [Yes]. All adjustments return to their previous figures.

Store

To store the adjusted data, select Store and press the SELECT button. The confirmation box will appear and then select [Yes]. Stored data can be called up by selecting "Image" in the Image Level Selection on page 34. If you change the Image level (p34) without storing the adjusted data, the figures will go back to the factory default settings.

Quit

Exit the Image Adjust Menu.

✓ Note:

- Progressive cannot be selected when 480p, 575p, 720p, 1035i, or 1080i is selected in the AV System Menu (p33).
- Film can only be activated when selecting NTSC and 480i for Video System and L1/ L2 for Progressive.
- 3-2 Pulldown or Telecine transfer is the process of changing images from film mode to video mode. Film runs at 24 frames per second (fps), while NTSC television signals (or video) have a run rate of 30fps, therefore the 24 fps film needs to be speeded up to 30fps and transferred to get the best film-like images using a proper field pattern.

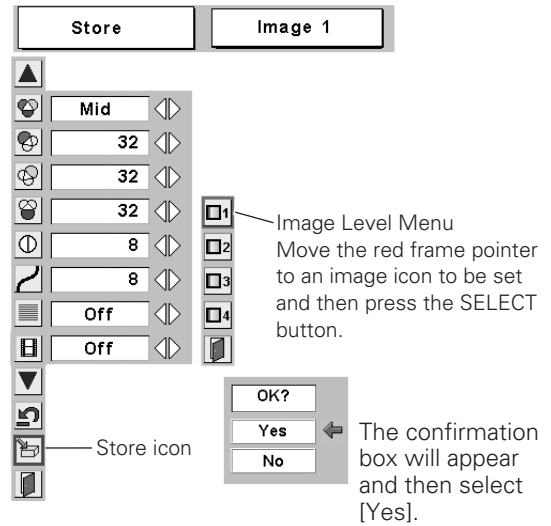

Screen Size Adjustment

This projector has the picture screen resize function, which enables you to customize the image size.

- 1 Press the MENU button to display the On-Screen Menu. Press the Point ◀▶ buttons to move the red frame pointer to the Screen Menu icon.
- 2 Press the Point ▼ button and move the red frame pointer to the desired function and then press the SELECT button.

Normal

Provides image at the normal video aspect ratio of 4 : 3.

Wide

Provides image at the wide screen ratio of 16 : 9.

✓ Note:

- Screen Menu cannot be operated when 720p, 1035i, or 1080i is selected in the AV System Menu (p33).

Screen Menu

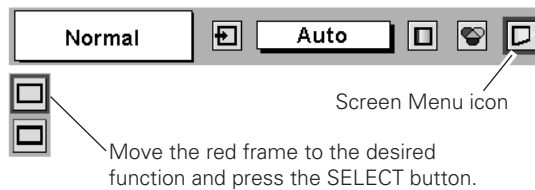

Setting

This projector has Setting Menu that allows you to set up other various functions described below.

- 1 Press the MENU button to display the On-Screen Menu. Press the Point ◀▶ buttons to move the red frame pointer to the Setting Menu icon.
- 2 Press the Point ▼ button to move the red frame pointer to the desired item and then press the SELECT button. The Setting dialog box appears.

Language

The language used in the On-Screen Menu is available in English, German, French, Italian, Spanish, Portuguese, Dutch, Swedish, Russian, Chinese, Korean, or Japanese.

Keystone

This function corrects distortion of a projected image. Select either Store or Reset with the Point ◀▶ buttons, and then press the SELECT button. The keystone dialog box appears. Correct keystone distortion with the Point ▲▼ buttons. (p22)

Store store the keystone correction even after the AC power cord is unplugged.

Reset reset the keystone correction when the AC power cord is unplugged.

Blue back

When this function is "On," the projector produces a blue image while input signal is not detected. Press the Point ◀▶ buttons to switch On/Off.

Display

This function allows you to decide whether to display the On-Screen Displays. Press the Point ◀▶ buttons to switch On/Off.

On show all the On-Screen Displays.

Off hide the On-Screen Displays except;

- On-Screen Menu
- "Power off?" message
- P-Timer
- "No signal" message
- "Please wait ..." message

Setting Menu (Language)

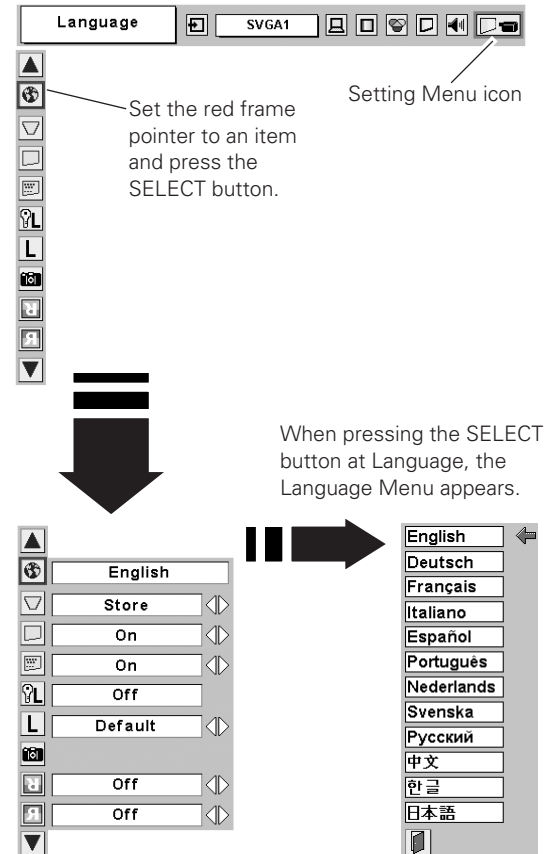

 **Logo PIN code lock**

This function prevents an unauthorized person from changing the Logo setting.

- Off the Logo setting can be changed freely with the Logo function. (p40)
- On the Logo setting cannot be changed without the Logo PIN code.

If you want to change the Logo PIN code lock setting, enter a Logo PIN code along the following steps. The initial Logo PIN code is set "4321" at the factory.

Enter a Logo PIN code

Select a number by pressing the Point ◀▶ buttons and fix the number with the SELECT button. The number will change to "*". If you fixed a wrong number, move the pointer to "Set" or "Clear" once by pressing the Point ▼ button, and then return to "Logo PIN code". Enter the correct number.

Repeat this step to complete entering a four-digit number.

When the four-digit number is fixed, the pointer will automatically move to "Set". Press the SELECT button so that you can change the Logo PIN code lock setting.

If you enter a wrong Logo PIN code, "Logo PIN code" and the number (****) will turn red and disappear. Enter a Logo PIN code all over again.

To Change the Logo PIN code

Logo PIN code can be changed to your desired four-digit number. Select "Logo PIN code change" with the Point ▼ button and press the SELECT button. Set a new Logo PIN code.

Be sure to note the new Logo PIN code and keep it at hand. If you lost the number, you could no longer change the Logo PIN code setting. For details on PIN code setting, refer to the relevant instructions of the PIN code lock function on page 43.

Logo PIN code lock

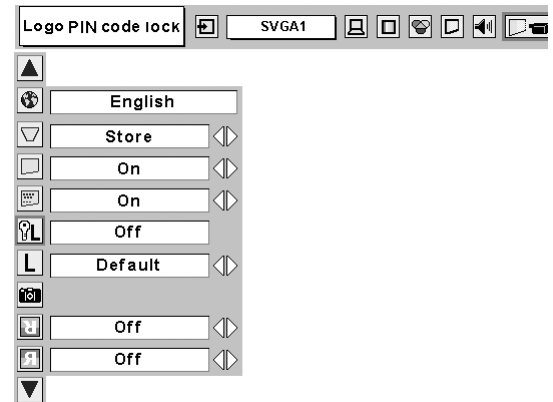

Logo PIN code lock Dialog Box



After a correct Logo PIN code is entered, the following dialog box will appear.

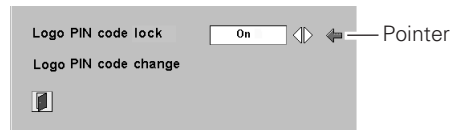

Select On/Off by pressing the Point ◀▶ buttons or change the Logo PIN code.

L Logo

This function allows you to decide on the starting-up display from among the following options.

- User the image you captured
- Default the factory-set logo
- Off countdown only

Capture

This function enables you to capture an image being projected to use it for the starting-up display or interval of presentations.

After capturing the projected image, go to the Logo function and set it to "User". Then the captured image can be displayed the next time projector is turned on or when the NO SHOW button is pressed. (p22)

To capture the image, select [Yes]. To cancel the Capture function, select [No].

Note:

- Before capturing an image, select Standard in the Image Select Menu to capture a proper image (p29, 34).
- A signal from a computer can be captured up to XGA(1024 x 768). A signal from video equipment can be captured except for 720p, 1035i, and 1080i.
- When capturing the image that has been adjusted by the Keystone function, the adjusted data is automatically reset and the projector captures an image without keystone correction.
- When the Logo PIN code lock function is "On", the Logo and Capture menu cannot be selected.
- When starting to capture a new image, the previously stored image is cleared even if you cancel the capturing.

Ceiling

When this function is "On," the picture is top/bottom and left/right reversed. This function is used to project an image from the ceiling-mounted projector.

Rear

When this function is "On," the picture is left/right reversed. This function is used to project an image to a rear projection screen.

Capture

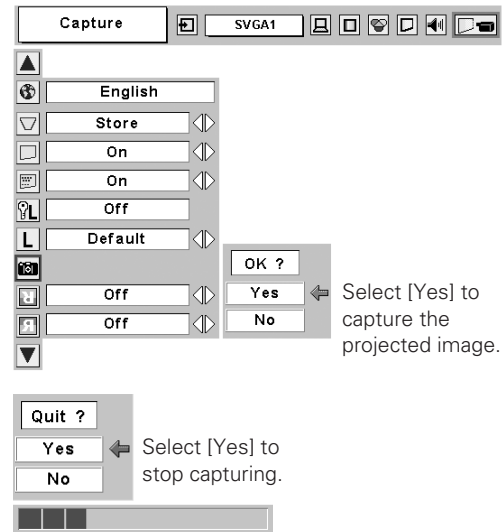

Ceiling

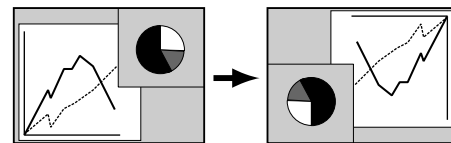

Rear

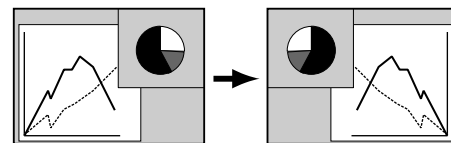

 **Power management**

For reducing power consumption as well as maintaining the lamp life, the Power management function turns off the projection lamp when the projector is not used for a certain period.

If the input signal is interrupted and no button is pressed for more than 30 seconds, the timer display with the "No signal" message appears on the screen to start the countdown. The countdown time can be set between 1 and 30 minutes with the Point ◀▶ buttons.

When the countdown time has been elapsed, the lamp will be turned off to cool itself down. The POWER indicator is blinking red during the cooling-off period. When the lamp has been fully cooled down, the projector operates according to the selected mode.

Ready The POWER indicator changes to green blinking. In this condition, the projection lamp can be turned on when the input signal is reconnected or any button on the top control or remote control is pressed.

Shutdown The power will be turned off.

Off The Power management function is off.

 **On start**



When this function is "On," the projector is automatically turned on just by connecting the AC power cord to an AC outlet.

✓ **Note:**

- Be sure to turn off the projector properly. (See "Turning Off the Projector" on page 18). If the projector is turned off in an incorrect sequence, such as disconnecting the AC power cord before completing the cool-down etc., the On start function does not operate properly.

 **Lamp mode**

This function allows you to change brightness of the screen.

-  Normal normal brightness.
-  Auto brightness according to the input signal.
-  Eco lower brightness that reduces the lamp power consumption and extends the lamp life.

 **Dim mode**

This function allows you to dim the projection screen contrast and brightness. Adjust the contrast level of the Dim mode screen with the Point ◀▶ buttons to your desired brightness. (From 0 to 15.) (p22)

Power management



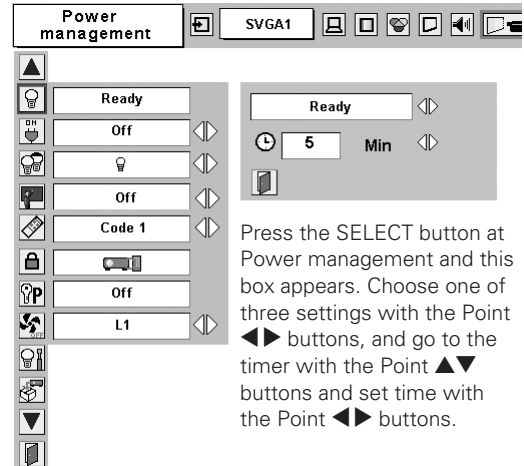

Time left until Lamp off



Press the SELECT button at Power management and this box appears. Choose one of three settings with the Point ◀▶ buttons, and go to the timer with the Point ▲▼ buttons and set time with the Point ◀▶ buttons.

 **Lamp mode**

This function allows you to change brightness of the screen.

-  Normal normal brightness.
-  Auto brightness according to the input signal.
-  Eco lower brightness that reduces the lamp power consumption and extends the lamp life.

 **Dim mode**

This function allows you to dim the projection screen contrast and brightness. Adjust the contrast level of the Dim mode screen with the Point ◀▶ buttons to your desired brightness. (From 0 to 15.) (p22)

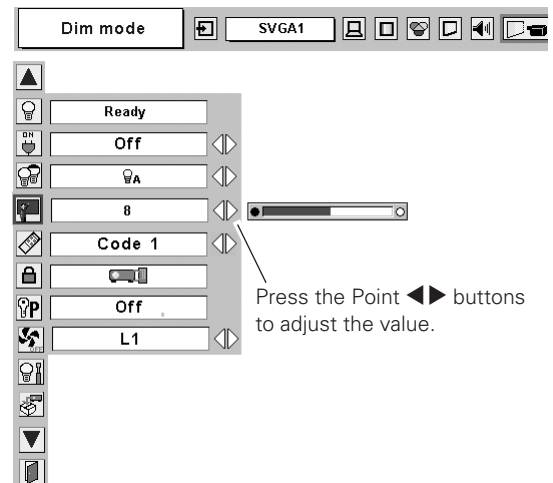

Press the Point ◀▶ buttons to adjust the value.

 **Remote control**

Two different remote control codes are assigned to this projector; the factory-set normal code (Code 1) and the secondary code (Code 2). This switching function prevents interference with different remote controls when several projectors or video equipment nearby are used at one time.

When operating the projector in "Code 2", the code for both the projector and remote control must be switched to "Code 2".

To change the code of the projector :

Set the remote control in the Setting Menu to "Code 2."

To change the code of the remote control :

Press and hold both MENU and IMAGE buttons on the remote control for more than 10 seconds. After changing the code, make sure the remote control operates properly.

To return to the normal code (Code 1), follow the above steps to operate both the projector and remote control.

Remote control

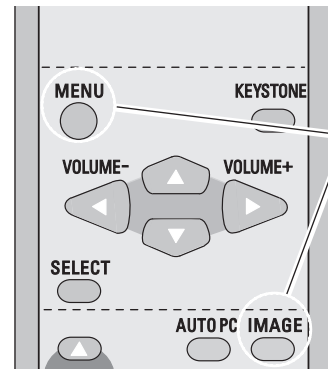

Press and hold the MENU and IMAGE buttons for more than 10 seconds.

✓ Note:

- When the batteries of the remote control are replaced, the remote control code automatically returns to the normal code (Code 1).

 **Key lock**

This function locks operation of the top control and the remote control. It helps to prevent operation by an unauthorized person.

 . . . not locked.

 . . . lock operation of the top control. To unlock, use the remote control.

 . . . lock operation of the remote control. To unlock, use the top control.

If the top control accidentally becomes locked and you do not have the remote control nearby, unplug the AC power cord from an AC outlet. While pressing the SELECT button, reinsert the AC power cord. This will cancel the top control lock.

Key lock

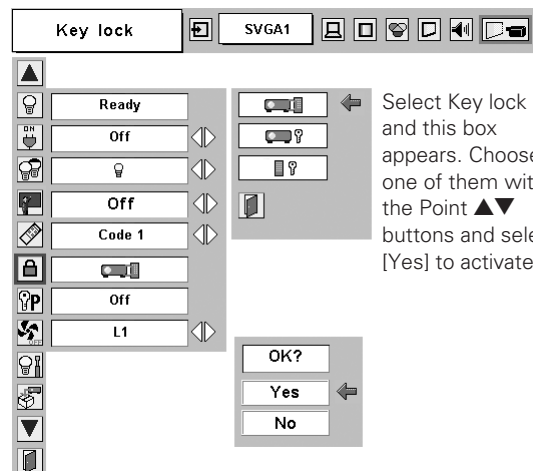

Select Key lock and this box appears. Choose one of them with the Point ▲▼ buttons and select [Yes] to activate it.

🔑 PIN code lock

This function prevents the projector from being operated by an unauthorized person and provides the following settings for security options.

- Of the projector is not locked with the PIN code.
- On1 requires to enter the PIN code every time turning on the projector.
- On2 requires to enter the PIN code to operate the projector once the power cord is disconnected; as long as the AC power cord is connected, the projector can be operated without the PIN code.

Whenever you change the PIN code lock setting or the PIN code (the four-digit number), entering the PIN code is required. The factory default PIN code is "1234".

Enter a PIN code

Select a number by pressing the Point ◀▶ buttons and fix the number with the SELECT button. The number will change to "*". If you fixed a wrong number, move the pointer to "Set" or "Clear" once by pressing the Point ▼ button, and then return to "PIN code". Enter the correct number.

Repeat this step to complete entering a four-digit number.

When the four-digit number is fixed, the pointer will automatically move to "Set". Press the SELECT button so that you can change the following PIN code lock settings.

If you enter a wrong PIN code, "PIN code" and the number (****) will turn red and disappear. Enter a PIN code all over again.

To Change the PIN code lock setting

Select Off, On1, or On2 with the Point ◀▶ buttons and then "Quit" with the Point ▼ button. Press the SELECT button to close the dialog box.

To Change the PIN code

The PIN code can be changed to your desired four-digit number. Select "PIN code change" with the Point ▼ button, and press the SELECT button. The New PIN code input dialog box will appear.

Select a number with the Point ◀▶ buttons and fix the number with the SELECT button. Repeat it to complete entering a four-digit number. When the four-digit number is fixed, the pointer automatically moves to "Set". Then press the SELECT button.

CAUTION:
WHEN YOU HAVE CHANGED THE PIN CODE, WRITE DOWN A NEW PIN CODE IN COLUMN OF THE PIN CODE NO. MEMO ON PAGE 59, AND KEEP IT SECURELY. SHOULD THE PIN CODE BE LOST OR FORGOTTEN, THE PROJECTOR CAN NO LONGER BE OPERATED.

PIN code lock

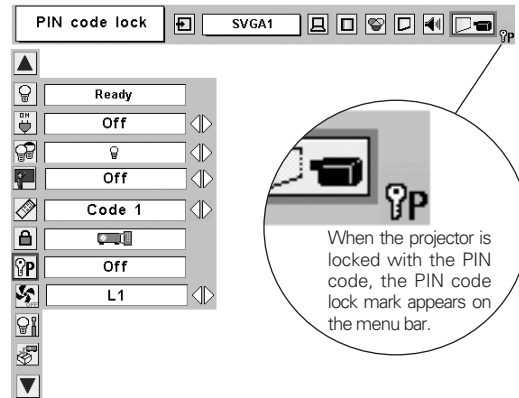

Enter a PIN code

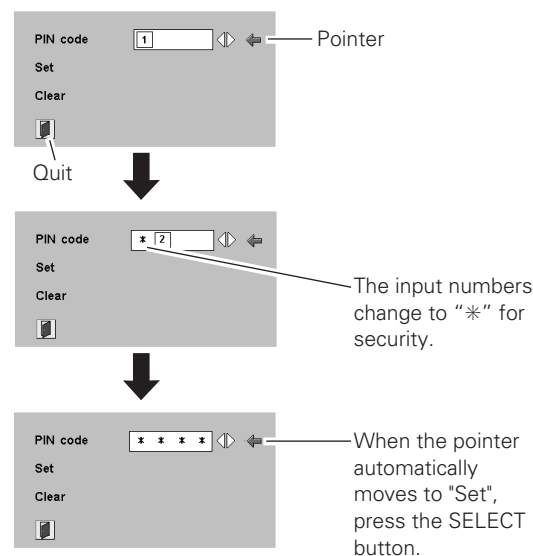

Change the PIN code lock setting



Change the PIN code

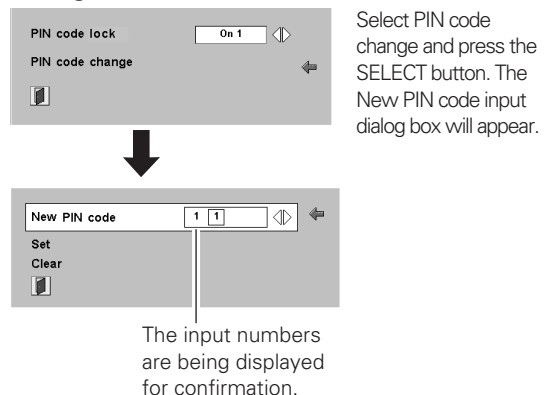

 **Fan**

This function provides the following alternatives in the cooling fans' operation after turning off the projector. (p18)

- L1 normal operation
- L2 slower and lower-sound than the normal operation (L1), but it takes longer to cool the projector down.

 **Lamp counter reset**

This function resets the lamp replacement counter. When replacing the projection lamp, reset the lamp replacement counter with this function. See page 49 for operation.

 **Factory default**

This function restores all setting values except for the user logo, PIN code lock, Logo PIN code lock and the lamp counter to the factory default settings.

Fan

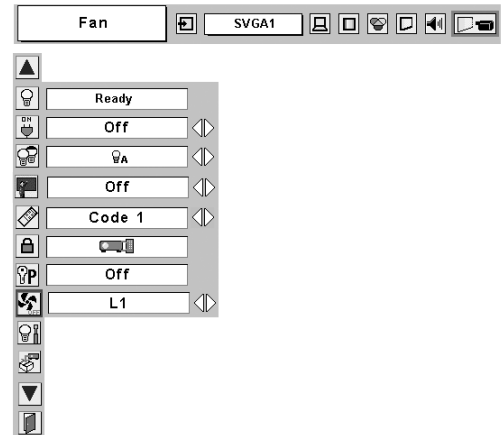

Factory default

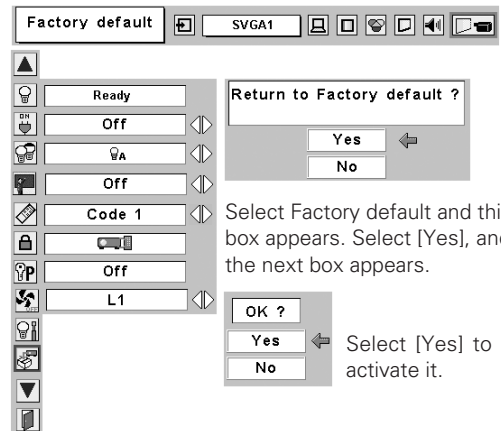

Select Factory default and this box appears. Select [Yes], and the next box appears.

Select [Yes] to activate it.

Warning Indicator

The WARNING indicator shows the state of the function that protects the projector. Check the state of the WARNING indicator and the POWER indicator to take proper maintenance.

The projector is shut down and the WARNING indicator is blinking red.

When the temperature inside the projector reaches a certain level, the projector will be automatically shut down to protect the inside of the projector. The POWER indicator is blinking while the projector is being cooled down. When the projector has cooled down sufficiently (to its normal operating temperature), it can be turned on again by pressing the POWER ON-OFF button.

✓ **Note:**

- The WARNING indicator continues to blink after the temperature inside the projector returns to normal. When the projector is turned on again, the WARNING indicator stops blinking.

TOP CONTROL

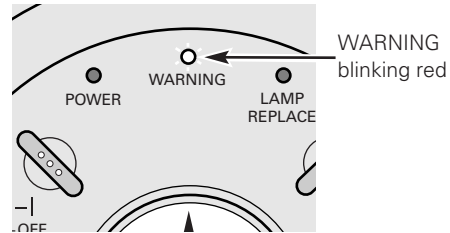

Then check the matters below:

- Did you provide appropriate space for the projector to be ventilated? Check the installing condition to see if the ventilation slots are not blocked.
- Is the projector not installed near the ventilation duct of air-conditioning equipment that may be hot? Install the projector away from the ventilation duct of air-conditioning equipment.
- Are the air filters clean? Clean the air filters periodically. (p46)

The projector is shut down and the WARNING indicator lights red.

When the projector detects an abnormal condition, it will be automatically shut down to protect the inside and the WARNING indicator emits red light. In this case, unplug the AC power cord and reconnect it, and then turn on the projector once again for check. If the projector cannot be turned on and the WARNING indicator emits red light, unplug the AC power cord and contact the service station for checkup and repair.

TOP CONTROL

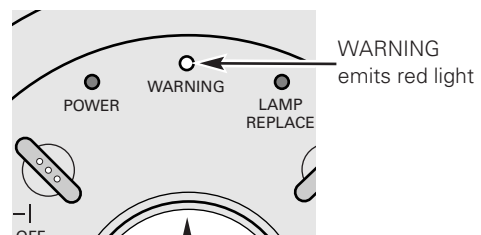

CAUTION

DO NOT LEAVE THE PROJECTOR WITH THE AC POWER CORD CONNECTED UNDER AN ABNORMAL CONDITION. IT MAY RESULT IN FIRE OR ELECTRIC SHOCK.

Cleaning the Air Filters

Air filters prevent dust from accumulating on the surface of the optical elements inside the projector. Should the air filters become clogged with dust particles, it reduces the effectiveness of cooling fans and may result in a buildup of internal heat and adversely affect the life of the projector. Clean the air filters by following the steps below.

- 1** Turn off the projector, and unplug the AC power cord from an AC outlet.
- 2** Turn the projector upside down and remove the air filters by pulling the latches upward.
- 3** Clean the air filters with a brush or rinse them softly.
- 4** When rinsing the air filters, dry them well. Replace the air filters properly. Make sure that the air filters are fully inserted to the projector.



CAUTION

Do not operate the projector with the air filters removed. Dust may accumulate on the LCD panel degrading the picture quality of the projection mirror. Do not put anything into the air intake vents. It may result in malfunction of the projector.

RECOMMENDATION

We recommend avoiding dusty/smoky environments when operating the projector. Usage in these environments may cause a poor image quality.

When using the projector under dusty or smoky conditions, dust may accumulate on a lens, LCD panels, or optical elements inside the projector. Such conditions may degrade the quality of a projected image.

When the symptoms above are noticed, contact your authorized dealer or service station for proper cleaning.

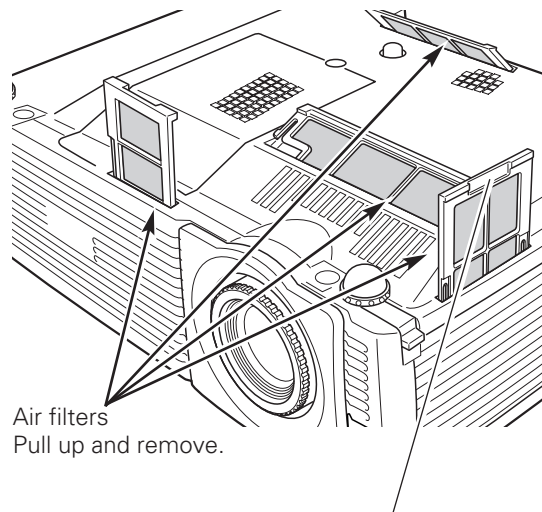

✓ Note:

- When reinserting this air filter, be sure that the slit part is facing the outer side.

Cleaning the Projection Lens

Unplug the AC power cord before cleaning.

Gently wipe the projection lens with a cleaning cloth that contains a small amount of non-abrasive cleaner for camera lens, or use lens cleaning paper or a commercially available air blower to clean the lens. Avoid using an excessive amount of cleaner. Abrasive cleaners, solvents, or other harsh chemicals might scratch the surface of the lens.

When the projector is not in use, replace the lens cover.

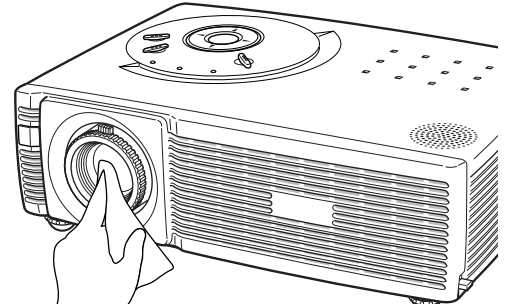

Cleaning the Projector Cabinet

Unplug the AC power cord before cleaning.

Gently wipe the projector body with a dry soft cloth. When the cabinet is heavily soiled, apply a small amount of mild detergent and finish with a dry soft cloth. Avoid using an excessive amount of cleaner. Abrasive cleaners, solvents, or other harsh chemicals might scratch the surface of the cabinet.

When the projector is not in use, put it in an appropriate carrying case to protect it from dust and scratches.

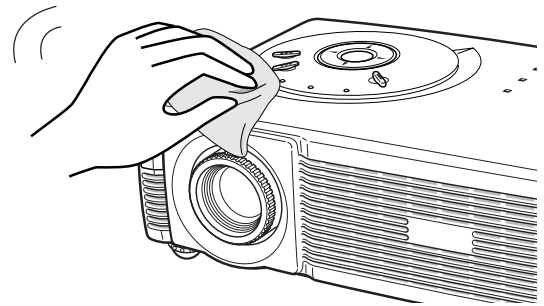

Attaching the Lens Cover

When moving the projector or while it is not in use over an extended period of time, replace the lens cover.

- 1** Thread the string through the hole on the lens cover and then tie a knot in the string to secure it in place.
- 2** Thread the other end of the string through the hole at the bottom of the projector. Then pass the lens cover through the resulting loop of the string. Tie a knot in the string to secure it in place.

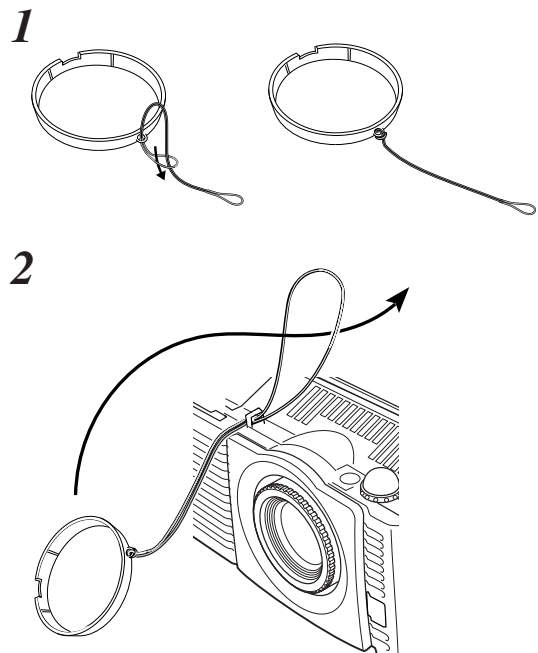

Lamp Replacement

When the life of the projection lamp draws to an end, the LAMP REPLACE indicator emits yellow light. If this indicator emits yellow light, replace the lamp with a new one promptly.

This indicator emits yellow light when the life of the projection lamp draws to an end.

Top Control

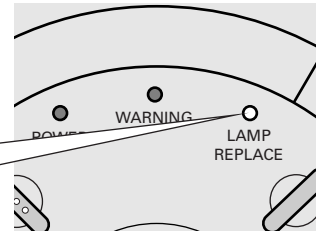

CAUTION

Allow the projector to cool for at least 45 minutes before you open the lamp cover. The inside of the projector can become very hot.



CAUTION

For continued safety, replace with a lamp of the same type. Do not drop the lamp or touch the glass bulb! The glass can shatter and may cause injury.

Follow these steps to replace the lamp.

- 1** Turn off the projector and unplug the AC power cord. Allow the projector to cool for at least 45 minutes.
- 2** Remove the screw with a screwdriver, and remove the lamp cover.
- 3** Loosen 2 screws of the lamp with a screwdriver and pull the handle out to remove the lamp.
- 4** Replace the lamp with a new one and tighten the 2 screws back into position. Make sure that the lamp is set properly. Replace the lamp cover and tighten the screw.
- 5** Connect the AC power cord to the projector and turn on the projector.
- 6** Reset the Lamp replacement counter. See "Lamp Replacement Counter" on the next page.

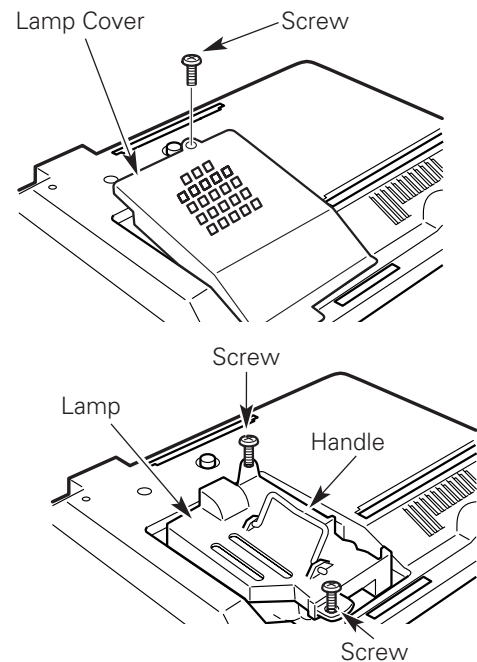

ORDER REPLACEMENT LAMP

Replacement lamp can be ordered through your dealer. When ordering a projection lamp, give the following information to the dealer.

- **Model No. of your projector** : **LC-SD15**
- **Replacement Lamp Type No.** : **POA-LMP78**
(Service Parts No. 610 317 7038)

Lamp Replacement Counter

Be sure to reset the lamp replacement counter after the lamp is replaced. When the lamp replacement counter is reset, the LAMP REPLACE indicator stops lighting.

- 1 Turn on the projector and press the MENU button to display the On-Screen Menu. Press the Point ◀▶ buttons to move the red frame pointer to the Setting Menu icon.
- 2 Press the Point ▼ button to move the red frame pointer to the Lamp counter reset item and then press the SELECT button. The message "Lamp replacement counter reset?" appears. Move the pointer to [Yes] and then press the SELECT button.
- 3 Another confirmation dialog box appears and select [Yes] to reset the Lamp replacement counter.

✓ **Note:**

- Do not reset the Lamp replacement counter without implementing lamp replacement. Be sure to reset the Lamp replacement counter only after replacing the lamp.

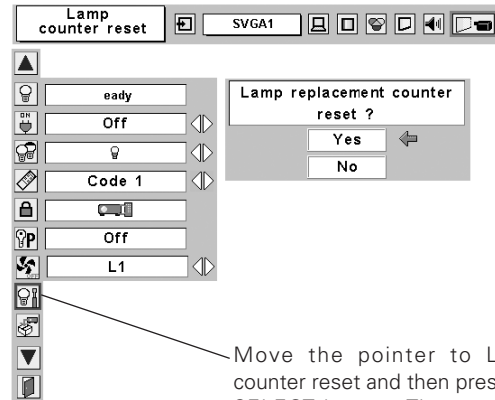

Move the pointer to Lamp counter reset and then press the SELECT button. The message "Lamp replacement counter reset?" appears.



LAMP HANDLING PRECAUTIONS

This projector uses a high-pressure lamp which must be handled carefully and properly. Improper handling may result in accidents, injury, or create a fire hazard.

- Lamp life may differ from lamp to lamp and according to the environment of use. There is no guarantee of the same life for each lamp. Some lamps may fail or terminate their life in a shorter period of time than other similar lamps.
- If the projector indicates that the lamp should be replaced, i.e., if the LAMP REPLACE indicator lights up, replace the lamp with a new one IMMEDIATELY after the projector has cooled down. (Follow carefully the instructions in the Lamp Replacement section of this manual.) Continuous use of the lamp with the LAMP REPLACE indicator lighted may increase the risk of lamp explosion.
- A Lamp may explode as a result of vibration, shock or degradation as a result of hours of use as its lifetime draws to an end. Risk of explosion may differ according to the environment or conditions in which the projector and lamp are being used.

IF A LAMP EXPLODES, THE FOLLOWING SAFETY PRECAUTIONS SHOULD BE TAKEN.

If a lamp explodes, disconnect the projector's AC plug from the AC outlet immediately. Contact an authorized service station for a checkup of the unit and replacement of the lamp. Additionally, check carefully to ensure that there are no broken shards or pieces of glass around the projector or coming out from the cooling air circulation holes. Any broken shards found should be cleaned up carefully. No one should check the inside of the projector except those who are authorized trained technicians and who are familiar with projector service. Inappropriate attempts to service the unit by anyone, especially those who are not appropriately trained to do so, may result in an accident or injury caused by pieces of broken glass.

Troubleshooting

Before calling your dealer or service center for assistance, check the items below once again.

- Make sure you have properly connected the projector to peripheral equipment as described in "Connecting to a Computer" and "Connecting to Video Equipment" on pages 15 and 16.
- Make sure all equipment is connected to an AC outlet and the power is turned on.
- When you operate the projector with a computer and it does not project an image, restart the computer.

Problem:

– Solutions

No power

- Plug the power cord of the projector into the AC outlet.
 - See if the POWER indicator lights red.
 - Wait 90-120 seconds after the projector is turned off to restart the projector. The projector can be turned on after the POWER indicator turns red. (See "Turning Off the Projector" on page 18.)
 - Check the WARNING indicator. If the WARNING indicator emits red light, the projector cannot be turned on. (See "Warning Indicator" on page 45.)
 - Check the projection lamp. (See page 48.)
 - Unlock the Key lock for the projector in the Setting Menu. (See page 42.)
-

Image is out of focus.

- Adjust the focus of the projector. (See page 19.)
 - Provide proper distance between the projector and the projection screen. (See page 13.)
 - Check the projection lens to see if it needs to be cleaned. (See page 47.)
 - Moving the projector from a cool to warm place may result in moisture condensation on the projection lens. In such cases, leave the projector off and wait until condensation evaporates.
-

No image

- Check the connection between your computer or video equipment and the projector. (See page 15, 16)
 - See if the input signal is correctly output from your computer. For some laptop computers, the setting for the monitor output needs to be changed when connecting to a projector. See your computer's instruction manual for the setting.
 - It takes about 20 seconds to display an image after turning on the projector.
 - See if the selected system is corresponding to your computer or video equipment. (See page 25 and 33)
 - Select a correct input source once again through Menu Operation. (See page 24, 32)
 - Make sure the temperature is not out of the specified Operating Temperature (41°F ~ 95°F (5°C ~ 35°C)).
-

**Image is Left/Right reversed.
Image is Top/Bottom reversed.**

- Check the Ceiling/Rear item. (See page 40.)
 - Check the Ceiling item. (See page 40.)
-

No sound

- Check audio cable connections from an audio input source.
 - Adjust the audio source.
 - Press the Volume + button. (See page 23.)
 - Press the Mute button. (See page 23.)
-

Some displays are not seen during the operation.

- Check the Display item. (See page 38.)

PIN code dialog box appears at start-up.

- PIN code lock is being set. Input a PIN code (1234 or numbers you have set). (See pages 17 and 43.)

The Remote Control does not work.

- Check the batteries.
- Make sure there is no obstruction between the projector and remote control.
- Make sure you are not too far from the projector when using the remote control. The maximum operating range is 16.4' (5m).
- Make sure the code of the remote control is conformed to that of the projector. (See page 42.)
- Unlock the Key lock for the remote control in the Setting Menu. (See page 42.)

WARNING :

High voltages are used to operate this projector. Do not attempt to open the cabinet.

If problems still persist after following all operating instructions, contact the dealer where you purchased the projector or the service center. Give the model number and explain about the problem. We will advise you how to obtain service.



The CE Mark is a Directive conformity mark of the European Community (EC).



This symbol on the nameplate means the product is Listed by Underwriters Laboratories Inc. It is designed and manufactured to meet rigid U.L. safety standards against risk of fire, casualty and electrical hazards.

Menu Tree

Computer Input / Video Input

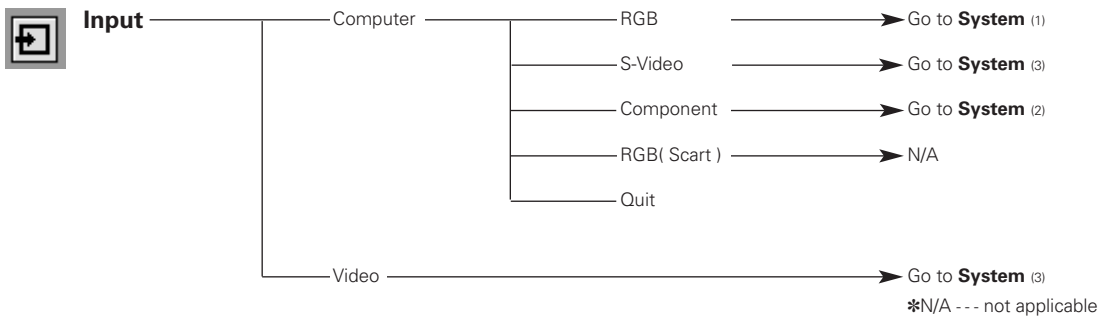

Sound

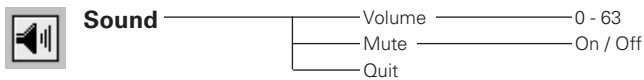

Computer Input

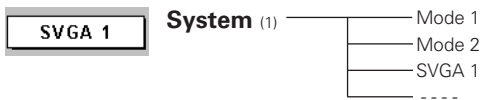

*Systems displayed in the System Menu vary depending the input signal.

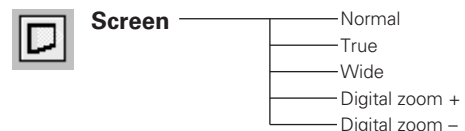
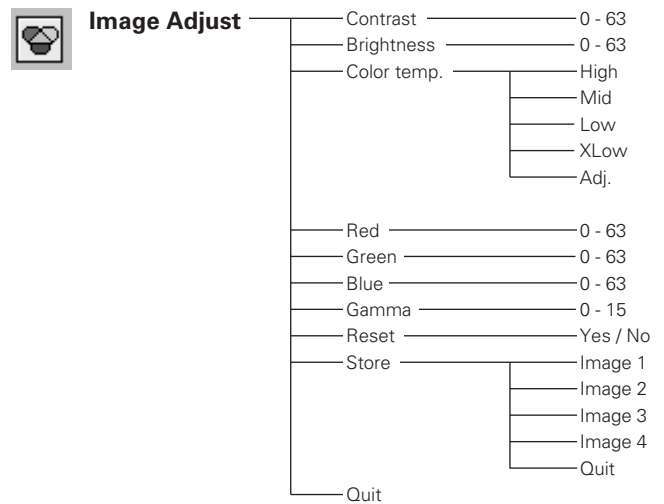
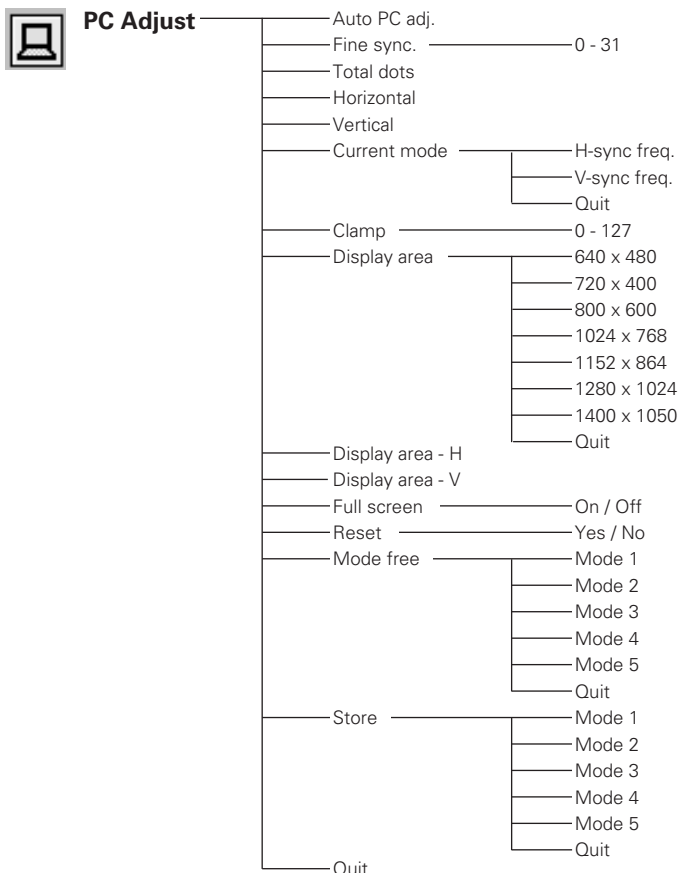
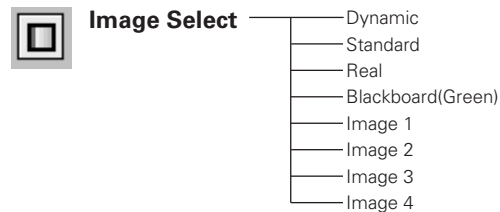

Video Input

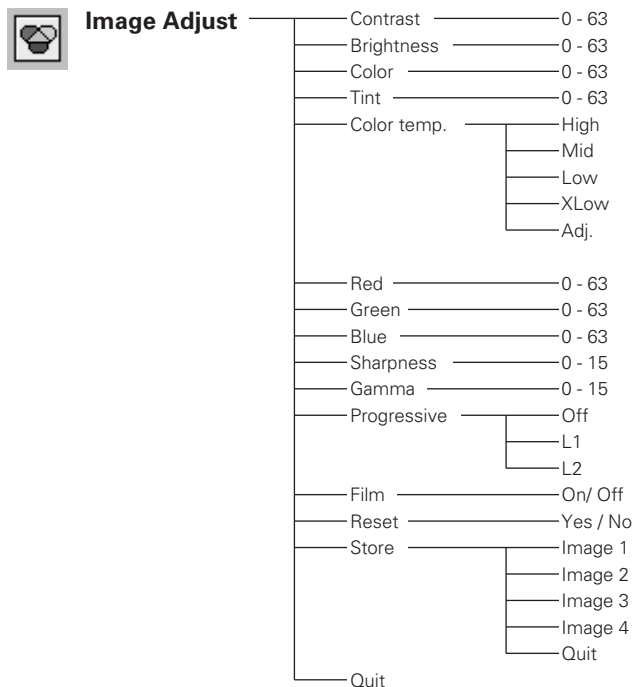
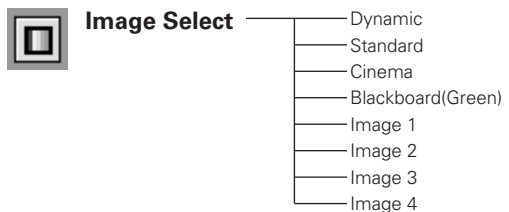
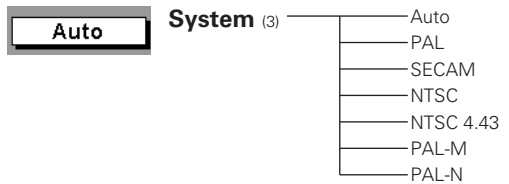
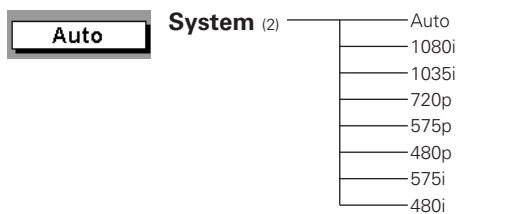

Setting

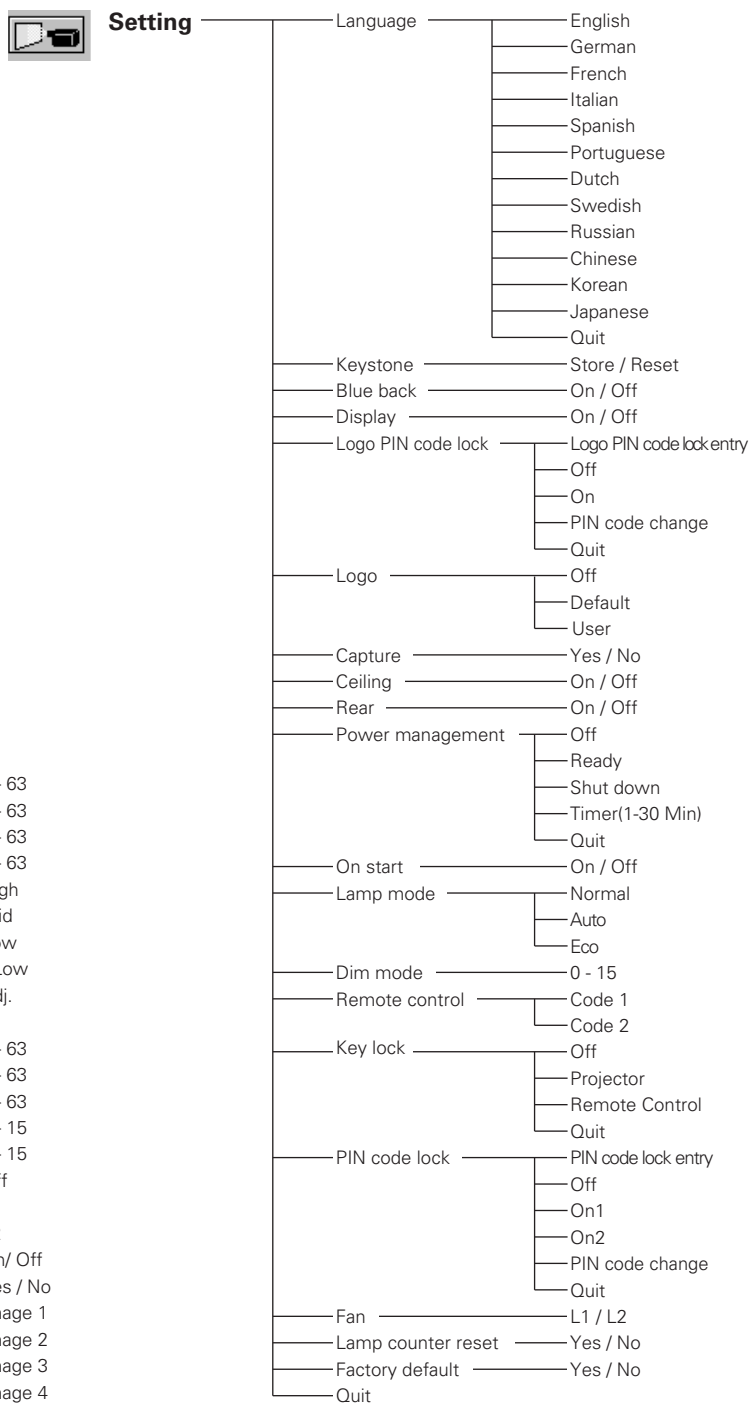

Indicators and Projector Condition

Check the indicators for projector condition.

Indicators			Projector Condition
POWER red/green	WARNING red	LAMP REPLACE yellow	
●	●	●	The projector is off. (The AC power cord is unplugged.)
⦿	●	*	The projector is preparing for stand-by or the projection lamp is being cooled down. The projector cannot be turned on until cooling is completed.
⦿	●	*	The projector is ready to be turned on with the POWER ON-OFF button.
○	●	*	The projector is operating normally.
⦿	●	*	The projector is in Power management mode.
⦿	⦿	*	The temperature inside the projector is abnormally high. The projector cannot be turned on. When the projector is cooled down enough and the temperature returns to normal, the POWER indicator turns to steady red and the projector can be turned on. (The WARNING indicator keeps blinking.) Check and clean the air filters.
⦿	⦿	*	The projector has been cooled down enough and the inside temperature returns to normal. When turning on the projector, the WARNING indicator stops blinking. Check and clean the air filters.
●	⦿	*	The projector detects an abnormal condition and cannot be turned on. Unplug the AC power cord and plug it again to turn on the projector. If the projector is turned off again, unplug the AC power cord and contact the dealer or the service center for service and checkup. Do not leave the projector on. It may cause an electric shock or a fire hazard.

○ ●●● emits green light ⦿ ●●● blinks green ⦿ ●●● emits red light ⦿ ●●● blinks red ● ●●● off

* When the life of the projection lamp draws to an end, the LAMP REPLACE indicator emits yellow light. In this case, replace the projection lamp with a new one promptly. Reset the Lamp replacement counter after replacing the lamp. See pages 48 and 49.

Compatible Computer Specifications

Basically this projector can accept the signal from all computers with the below mentioned V, H-Frequency and less than 100 MHz of Dot Clock.

ON-SCREEN DISPLAY	RESOLUTION	H-Freq. (kHz)	V-Freq. (Hz)	ON-SCREEN DISPLAY	RESOLUTION	H-Freq. (kHz)	V-Freq. (Hz)
VGA 1	640 x 480	31.47	59.88	XGA 2	1024 x 768	68.677	84.997
VGA 2	720 x 400	31.47	70.09	XGA 3	1024 x 768	60.023	75.03
VGA 3	640 x 400	31.47	70.09	XGA 4	1024 x 768	56.476	70.07
VGA 4	640 x 480	37.86	74.38	XGA 5	1024 x 768	60.31	74.92
VGA 5	640 x 480	37.86	72.81	XGA 6	1024 x 768	48.50	60.02
VGA 6	640 x 480	37.50	75.00	XGA 7	1024 x 768	44.00	54.58
VGA 7	640 x 480	43.269	85.00	XGA 8	1024 x 768	63.48	79.35
MAC LC13	640 x 480	34.97	66.60	XGA 9	1024 x 768	36.00	^{87.17} (Interlace)
MAC 13	640 x 480	35.00	66.67	XGA 10	1024 x 768	62.04	77.07
480p	————	31.47	59.88	XGA 11	1024 x 768	61.00	75.70
575p	————	31.25	50.00	XGA 12	1024 x 768	35.522	^{86.96} (Interlace)
480i	————	15.734	⁶⁰ (Interlace)	XGA 13	1024 x 768	46.90	58.20
575i	————	15.625	⁵⁰ (Interlace)	XGA 14	1024 x 768	47.00	58.30
SVGA 1	800 x 600	35.156	56.25	XGA 15	1024 x 768	58.03	72.00
SVGA 2	800 x 600	37.88	60.32	MAC 19	1024 x 768	60.24	75.08
SVGA 3	800 x 600	46.875	75.00	MAC 21	1152 x 870	68.68	75.06
SVGA 4	800 x 600	53.674	85.06	SXGA 1	1152 x 864	64.20	70.40
SVGA 5	800 x 600	48.08	72.19	SXGA 11	1152 x 900	61.20	65.20
SVGA 6	800 x 600	37.90	61.03	SXGA 13	1280 x 1024	50.00	^{86.00} (Interlace)
SVGA 7	800 x 600	34.50	55.38	SXGA 14	1280 x 1024	50.00	^{94.00} (Interlace)
SVGA 8	800 x 600	38.00	60.51	SXGA 17	1152 x 900	61.85	66.00
SVGA 9	800 x 600	38.60	60.31	SXGA 18	1280 x 1024	46.43	^{86.70} (Interlace)
SVGA 10	800 x 600	32.70	51.09	720p (HDTV)	————	45.00	60.00
SVGA 11	800 x 600	38.00	60.51	1035i (HDTV)	————	33.75	^{60.00} (Interlace)
MAC 16	832 x 624	49.72	74.55	1080i (HDTV)	————	33.75	^{60.00} (Interlace)
XGA 1	1024 x 768	48.36	60.00	1080i (HDTV)	————	28.125	^{50.00} (Interlace)

Technical Specifications

Mechanical Information

Projector Type	Multi-media Projector
Dimensions (W x H x D)	10.63" x 3.07" x 7.48" (270mm x 78mm x 190mm) (not including Adjustable Feet)
Net Weight	4.8lbs (2.2 kg)
Feet Adjustment	0° to 7.0°

Panel Resolution

LCD Panel System	0.5" TFT Active Matrix type, 3 panels
Panel Resolution	800 x 600 dots
Number of Pixels	1,440,000 (800 x 600 x 3 panels)

Signal Compatibility

Color System	PAL, SECAM, NTSC, NTSC4.43, PAL-M, PAL-N
High Definition TV Signal	480i, 480p, 575i, 575p, 720p, 1035i, and 1080i
Scanning Frequency	H-sync. 15 ~ 80 KHz, V-sync. 50 ~ 100 Hz

Optical Information

Projection Image Size (Diagonal)	Adjustable from 34" to 200"
Projection Lens	F 1.6 ~ 1.8 lens with f 18.3 mm ~ 21.9 mm with manual zoom and focus
Throw Distance	4.3' ~ 21.2' (1.3m ~ 6.5m)
Projection Lamp	160W

Interface

Video Input Jack	RCA Type x 1
Audio Input Jack	Mini Jack (Stereo) x 1
Monitor Out Terminal	Analog RGB (Mini D-sub 15 pin) x 1
Computer/S-Video/Component Input Terminal	Analog RGB (Mini D-sub 15 pin) x 1
Service Port Connector	Mini DIN 8 pin x 1
Audio Output Jack	Mini Jack (stereo) x 1 (Variable)

Audio

Internal Audio Amp	0.8 W RMS
Built-in Speaker	1 speaker, ø1.3" (32mm)

Power

Voltage and Power Consumption	AC 100 ~ 120 V (3.6 A Max. Ampere), 50/60 Hz (The U.S.A and Canada) AC 200 ~ 240 V (1.8 A Max. Ampere), 50/60 Hz (Continental Europe)
-------------------------------	--

Operating Environment

Operating Temperature	41 °F ~ 95 °F (5 °C ~ 35 °C)
Storage Temperature	14 °F ~ 140 °F (-10°C ~ 60 °C)

Remote Control

Battery	AA or LR6 1.5V ALKALINE TYPE x 2
Operating Range	16.4' (5m) / ±30°
Dimensions	1.9" (W) x 0.87" (H) x 5.7" (D) (49mm x 22mm x 145.3mm)
Net Weight	3.53 oz (100 g) (including batteries)

Accessories

Owner's Manual
AC Power Cord
Remote Control and Batteries
VGA Cable
Lens Cover with String
PIN Code Label

- The specifications are subject to change without notice.
- LCD panels are manufactured to the highest possible standards. Even though 99.99% of the pixels are effective, a tiny fraction of the pixels (0.01% or less) may be ineffective by the characteristics of the LCD panels.
- The On-Screen Menu and figures in this manual may differ slightly from the product.

Optional Parts

The parts listed below are optionally available. When ordering those parts, give the item name and Model No. to the sales dealer.

	<i>Model No.</i>
COMPONENT-VGA Cable	: AH-98771 (POA-CA-COMPVGA)
SCART-VGA Cable	: AH-98881 (POA-CA-SCART)
S-Video-VGA Cable	: AH-98661 (POA-CA-VGAS)

Configurations of Terminals

COMPUTER INPUT/S-VIDEO INPUT/COMPONENT INPUT/MONITOR OUTPUT TERMINAL (ANALOG)

Terminal : Mini D-sub 15 pin

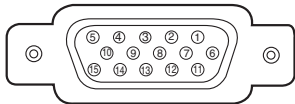

1	Red (R/Cr) Input/Output	9	---
2	Green (G/Y) Input/Output	10	Ground (Vert.sync.)
3	Blue (B/Cb) Input/Output	11	Ground / ---
4	---	12	---
5	Ground (Horiz.sync.)	13	Horiz. sync. Input/Output (Composite H/V sync.)
6	Ground (Red)	14	Vert. sync.
7	Ground (Green)	15	---
8	Ground (Blue)		

SERVICE PORT CONNECTOR

Terminal : Mini DIN 8-PIN

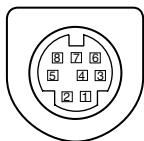

	Serial
1	R X D
2	---
3	---
4	GND
5	RTS/CTS
6	T X D
7	GND
8	GND

PIN Code Number Memo

Write down the PIN code number in the column below and keep it with this manual securely. If you forgot or lost the numbers and unable to operate the projector, contact the service station.

PIN Code Lock No.

--	--	--	--

Factory default set No: 1 2 3 4*

Logo PIN Code Lock No.

--	--	--	--

Factory default set No: 4 3 2 1*

*Should the four-digit number be changed, the factory set number will be invalid.

While the projector is locked with the PIN code ...

Put on the label below (supplied) in a prominent place of the projector's body while it is locked with a PIN code.

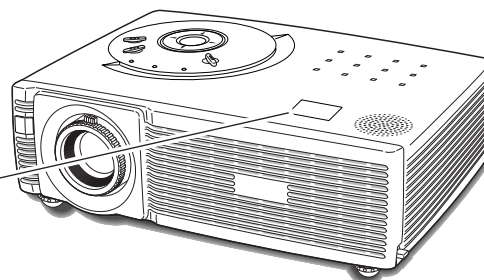
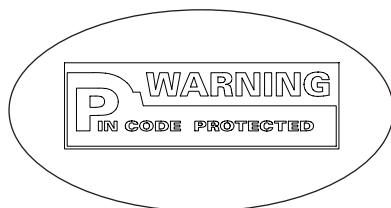

EIKI

A-key to better communications

U.S.A.

EIKI International, Inc.
30251 Esperanza
Rancho Santa Margarita
CA 92688-2132
U.S.A.
Tel : 800-242-3454 (949)-457-0200
Fax : 800-457-3454 (949)-457-7878
E-Mail : usa@eiki.com

Deutschland & Österreich

EIKI Deutschland GmbH
Am Frauwald 12
65510 Idstein
Deutschland
Tel : 06126-9371-0
Fax : 06126-9371-14
E-Mail : info@eiki.de

Canada

EIKI CANADA - Eiki International, Inc.
P.O. Box 156, 310 First St. - Unit 2,
Midland, ON, L4R 4K8, Canada
Tel : 800-563-3454 (705)-527-4084
Fax : 800-567-4069 (705)-527-4087
E-Mail : canada@eiki.com

Eastern Europe

EIKI CZECH spol. s.r.o.
Umělecká 15
170 00 Praha 7
Czech Republic
Tel : +42 02 20570024
+42 02 20571413
Fax : +42 02 20571411
E-Mail : easterneurope@eiki.de

Japan & Worldwide

EIKI Industrial Company Limited.
4-12 Banzai-Cho, Kita-Ku, Osaka,
530-0028 Japan
Tel : +81-6-6311-9479
Fax : +81-6-6311-8486

WorldWide Website <http://www.eiki.com>

Free Manuals Download Website

<http://myh66.com>

<http://usermanuals.us>

<http://www.somanuals.com>

<http://www.4manuals.cc>

<http://www.manual-lib.com>

<http://www.404manual.com>

<http://www.luxmanual.com>

<http://aubethermostatmanual.com>

Golf course search by state

<http://golfingnear.com>

Email search by domain

<http://emailbydomain.com>

Auto manuals search

<http://auto.somanuals.com>

TV manuals search

<http://tv.somanuals.com>