



MULTIMEDIA PROJECTOR

MODEL **LC-XNB1U**



OWNER'S INSTRUCTION MANUAL

INFORMATION TO THE USER

NOTE : This equipment has been tested and found to comply with the limits for a Class A digital device, pursuant to Part 15 of FCC Rules. These limits are designed to provide reasonable protection against harmful interference when the equipment is operated in a commercial environment. This equipment generates, uses, and can radiate radio frequency energy and, if not installed and used in accordance with the instruction manual, may cause harmful interference to radio communications. Operation of this equipment in a residential area is likely to cause harmful interference in which case the user will be required to correct the interference at his own expense.

SAFETY PRECAUTIONS

WARNING:

TO REDUCE THE RISK OF FIRE OR ELECTRIC SHOCK, DO NOT EXPOSE THIS APPLIANCE TO RAIN OR MOISTURE.

This Projector has a grounding-type AC line plug. This is a safety feature to be sure that the plug will fit into the power outlet. Do not try to defeat this safety feature.

This projector produces intense light from the projection lens. Do not stare directly into the lens as possible eye damage could result. Be especially careful that children do not stare directly into the beam.

The Remote Control Unit, supplied to this projector, emits the laser beam as the Laser Pointer function from the Laser Light Window while pressing the LASER button. Do not look into the Laser Light Window or shine the laser beam on yourself or other people. Eye damage may result.

This projector should be set in the way indicated. If not, it may result in fire hazard.

If the projector will not be used for an extended time, unplug the projector from the power outlet.

READ AND KEEP THIS OWNER'S MANUAL FOR LATER USE.



CAUTION

**RISK OF ELECTRIC SHOCK
DO NOT OPEN**



CAUTION : TO REDUCE THE RISK OF ELECTRIC SHOCK, DO NOT REMOVE COVER (OR BACK). NO USER-SERVICEABLE PARTS INSIDE EXCEPT LAMP REPLACEMENT. REFER SERVICING TO QUALIFIED SERVICE PERSONNEL.



THIS SYMBOL INDICATES THAT DANGEROUS VOLTAGE CONSTITUTING A RISK OF ELECTRIC SHOCK IS PRESENT WITHIN THIS UNIT.



THIS SYMBOL INDICATES THAT THERE ARE IMPORTANT OPERATING AND MAINTENANCE INSTRUCTIONS IN THE OWNER'S MANUAL WITH THIS UNIT.

IMPORTANT:

For your protection in the event of theft or loss of this LC Data-Grade projector, please record the Model Number and Serial Number located on the rear of unit and retain this information. Refer to these numbers whenever you call upon your authorized dealer regarding this product.

Do not discard shipping carton and packing materials. These items may be needed for storage or future servicing.

Model No : LC-XNB1U

Serial No : _____

IMPORTANT SAFETY INSTRUCTIONS

All the safety and operating instructions should be read before the product is operated.

Read all of the instructions given here and retain them for later use. Unplug this projector from AC power supply before cleaning. Do not use liquid or aerosol cleaners. Use a damp cloth for cleaning.

Do not use attachments not recommended by the manufacturer as they may cause hazards.

Do not place this projector on an unstable cart, stand, or table. The projector may fall, causing serious injury to a child or adult, and serious damage to the projector. Use only with a cart or stand recommended by the manufacturer, or sold with the projector. Wall of shelf mounting should follow the manufacturer's instructions, and should use a mounting kit approved by the manufacturers.

Do not expose this unit to rain or use near water... for example, in a wet basement, near a swimming pool, etc...

Slots and openings in the back and bottom of the cabinet are provided for ventilation, to insure reliable operation of the equipment and to protect it from overheating.

The openings should never be covered with cloth of other materials, and the bottom opening should not be blocked by placing the projector on a bed, sofa, rug, or other similar surface. This projector should never be placed near or over a radiator or heat register.

This projector should not be placed in a built-in installation such as a book case unless proper ventilation is provided.

This projector should be operated only from the type of power source indicated on the marking label. If you are not sure of the type of power supplied, consult your authorized dealer or local power company.

Do not overload wall outlets and extension cords as this can result in fire or electric shock. Do not allow anything to rest on the power cord. Do not locate this projector where the cord may be damaged by persons walking on it.

Never push objects of any kind into this projector through cabinet slots as they may touch dangerous voltage points or short out parts that could result in a fire or electric shock. Never spill liquid of any kind on the projector.

Do not attempt to service this projector yourself as opening or removing covers may expose you to dangerous voltage or other hazards. Refer all servicing to qualified service personnel.

Unplug this projector from wall outlet and refer servicing to qualified service personnel under the following conditions:

- When the power cord or plug is damaged or frayed.
- If liquid has been spilled into the projector.
- If the projector has been exposed to rain or water.

- If the projector does not operate normally by following the operating instructions. Adjust only those controls that are covered by the operating instructions as improper adjustment of other controls may result in damage and will often require extensive work by a qualified technician to restore the projector to normal operation.
- If the projector has been dropped or the cabinet has been damaged.
- When the projector exhibits a distinct change in performance-this indicates a need for service.

When replacement parts are required, be sure the service technician has used replacement parts specified by the manufacturer that have the same characteristics as the original part. Unauthorized substitutions may result in fire, electric shock, or injury to persons.

Upon completion of any service or repairs to this projector, ask the service technician to perform routine safety checks to determine that the projector is in safe operating condition.



This projector is equipped with a grounding type AC line plug. Should you be unable to insert the plug into the outlet, contact your electrician. Do not defeat the safety purpose of this grounding type plug.

Follow all warnings and instructions marked on the projectors.

For added protection to the projector during a lightning storm, or when it is left unattended and unused for long periods of time, unplug it from the wall outlet. This will prevent damage due to lightning and power line surges.



An appliance and cart combination should be moved with care. Quick stops, excessive force, and uneven surfaces may cause the appliance and cart combination to overturn.

If the projector is to be built into a compartment or similarly enclosed, the minimum distances must be maintained. Do not cover the ventilation slot on the projector. Heat build-up can reduce the service life of your projector, and can also be dangerous.

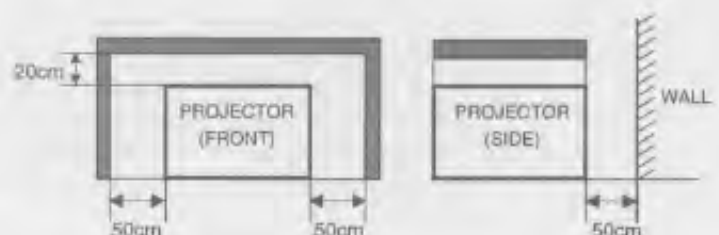

TABLE OF CONTENTS

FEATURES AND DESIGN	5	COMPUTER MODE	25
		SELECTING COMPUTER MODE	25
		SELECTING COMPUTER SYSTEM	25
		PC ADJUSTMENT	26
		COMPATIBLE COMPUTER SPECIFICATIONS	27
		PICTURE IMAGE ADJUSTMENT	28
		PICTURE POSITION ADJUSTMENT	30
		PICTURE SCREEN ADJUSTMENT	30
PREPARATION	6	VIDEO MODE	31
NAME OF EACH PART OF THE PROJECTOR	6	SELECTING VIDEO MODE	31
SETTING UP THE PROJECTOR	7	SELECTING COLOR SYSTEM	31
CONNECTING THE AC POWER CORD	8	PICTURE IMAGE ADJUSTMENT	32
VENTILATION	8	PICTURE SCREEN ADJUSTMENT	32
MOVING THE PROJECTOR	9		
CONNECTING THE PROJECTOR	10	MCI MODE	33
TERMINALS OF THE PROJECTOR	10	OPERATING THE PC CARD SLOT	33
CONNECTING TO THE VIDEO EQUIPMENT	11	SHOW THE DATA IN THE MEMORY CARD	34
CONNECTING TO THE COMPUTER	12	PICTURE IMAGE ADJUSTMENT	35
		PICTURE POSITION ADJUSTMENT	36
		PICTURE SCREEN ADJUSTMENT	36
		WRITE DATA INTO THE MEMORY CARD	37
		SMART MEDIA AND PC CARD ADAPTER	38
BEFORE OPERATION	16		
OPERATION OF THE REMOTE CONTROLS	16		
TOP CONTROLS AND INDICATORS	18		
OPERATING ON-SCREEN MENU	19		
BASIC OPERATION	22	SETTING	40
TURNING ON / OFF THE PROJECTOR	22	SETTING MENU	40
ADJUSTING THE PICTURE	23	SETTING LANGUAGE	40
PICTURE FREEZE / NO SHOW FUNCTION	23		
CURSOR FUNCTION	23	APPENDIX	41
SOUND ADJUSTMENT	24	OPERATING WIRELESS MOUSE	41
		MAINTENANCE	42
		TROUBLESHOOTING	44
		TECHNICAL SPECIFICATIONS	46

TRADEMARKS

- Apple, Macintosh, and PowerBook are trademarks or registered trademarks of Apple Computer, Inc.
- IBM and PS/2 are trademarks or registered trademarks of International Business Machines, Inc.
- Windows and PowerPoint are registered trademarks of Microsoft Corporation.
- Each name of corporations or products in the owner's manual is a trademark or a registered trademark of its respective corporation.

FEATURES AND DESIGN

This Multimedia Projector is designed with most advance technology for portability, durability, and ease for use. The projector utilizes built-in multimedia features, a palette of 16.77 million colors, and matrix liquid crystal display (LCD) technology.

◆ Compatibility

This projector is compatible with many different types of personal computers and video devices, including;

- IBM-compatible computers, including laptops, up to 1280 x 1024 resolution.
- Apple Macintosh and PowerBook computers up to 1280 x 1024 resolution.
- Various video equipments using any of the world wide video standards, including NTSC, NTSC4.43, SECAM, PAL, and PAL-M.

◆ Image Resolution

Picture Image is projected in the resolution of 1024 x 768. The projector provides computer images just as they appear on your computer's monitor. Screen resolutions between 1024 x 768 and 1280 x 1024 are compressed to 1024 x 768. The projector cannot display screen resolutions above 1280 x 1024. If your computer's screen resolution is higher than 1280 x 1024, reset it to a lower resolution before you connect the projector.

◆ Portability

This projector is extremely compact in size and weight. Having a sophisticated shape like an attaché case with a retractable carrying handle, the projector will help you make powerful presentation wherever you go.

◆ Automatic Multiscanning System

This projector can detect output signals from most personal computers currently distributed. It is free from complicated adjustments to project picture images from PC.

◆ Multilanguage

MENU DISPLAY is displayed with; English, Deutsch, Français, Italiano, Español, or Japanese

◆ PC CARD SLOT

This projector has a PC CARD SLOT for easier presentation. Pictures can be projected just by inserting a memory card including image data and the presentation data can be edited by the software "Media Card Imager" (supplied) easily. Refer to the pages 33 - 39 and the Owner's Manual for Media Card imager for operations.

◆ Laser Pointer and Cursor Function

The Laser Pointer and Cursor functions are provided on this projector and the Remote Control Unit. These functions are easily controlled with the Remote Control. Refer to the pages 16 and 23 for operations.

◆ Other Features

This projector has Picture Freeze and Mute functions, and Air Pad Remote Control.

◆ Accessories

This projector comes with the parts listed below. Check to make sure all are included. If any parts are missing, contact to a sales dealer.

- Owner's Manual.
- AC Power Cord.
- Wireless Remote Control Unit.
- Batteries for Remote Control Unit.
- VGA Cable.
- VGA/MAC Adapter.
- Mouse Cable for PS/2 port.
- Mouse Cable for serial port.
- Mouse Cable for ADB port.
- MCI Cable (RS-232C Cable).
- Media Card Imager for Windows 95 (CD-ROM) and Owner's Manual for this software.
- SmartMedia (Memory Card).
- PC Card Adapter for SmartMedia.
- Lens Cover.
- Carrying Bag.

PREPARATION

NAME OF EACH PART OF THE PROJECTOR

FRONT OF THE CABINET

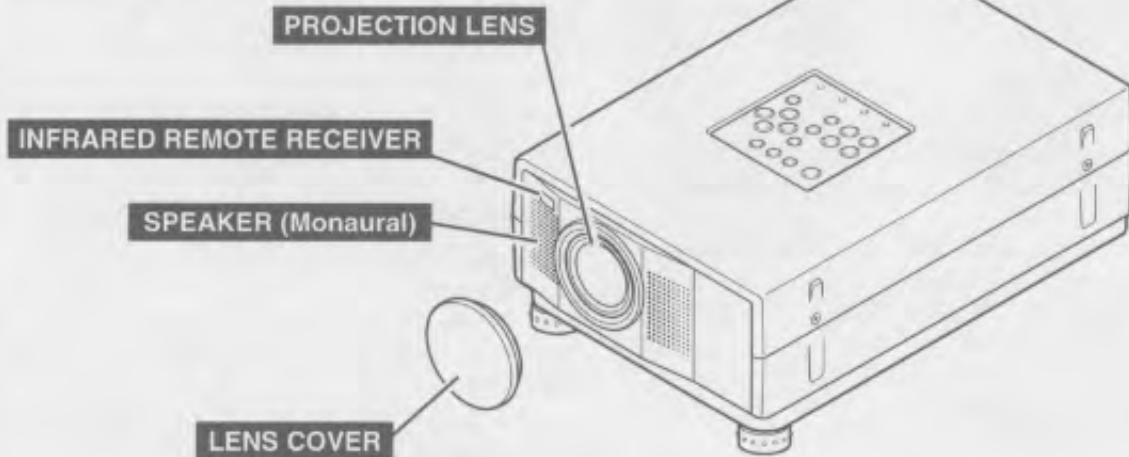

BACK OF THE CABINET

EXHAUST VENT



HOT AIR EXHAUSTED !

Air blown from the exhaust vent is hot. When using or installing the projector, following attention should be taken.

- Do not put a flammable object near this part. Keep heat-sensitive objects away from the exhaust vent.
- Do not touch this part especially screws and metallic parts. This part will become hot while the projector is used.

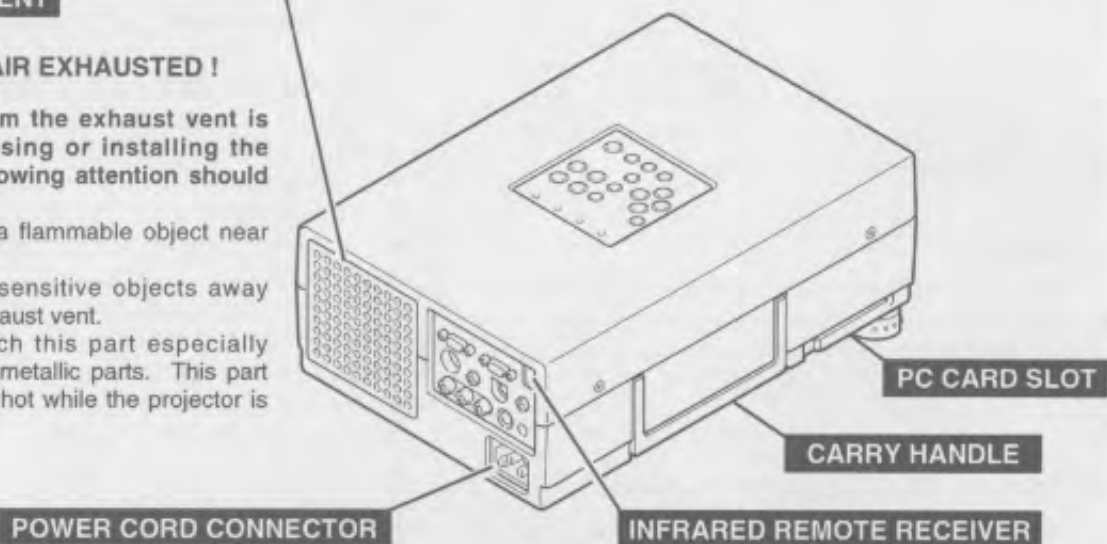

BOTTOM OF THE CABINET

AIR INTAKE VENT

This Air Intake Vent should not be blocked.

LAMP COVER

ADJUSTABLE FEET



SETTING-UP THE PROJECTOR

Positioning the Projector

- This projector is basically designed to project on a flat projection surface.
- The projector can be focused from 4.6'(1.4m) ~ 35.4'(10.8m).
- Refer to the figure below to adjust the screen size.

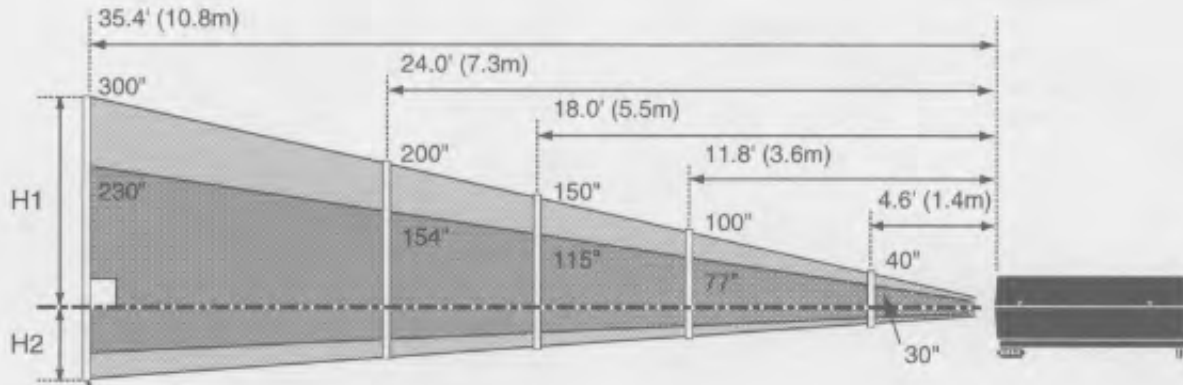

Screen Size (W x H) mm	30"	60"	100"	150"	200"	300"
Height (H1)	17.1"(435mm)	34.3"(870mm)	57.1"(1451mm)	85.7"(2177mm)	114.3"(2903mm)	171.4"(4354mm)
Height (H2)	0.9"(22mm)	1.7"(44mm)	2.9"(73mm)	4.3"(109mm)	5.7"(145mm)	8.6"(218mm)

ROOM LIGHT

The brightness in the room has a great influence on the quality of a picture. Adjust the light little darker, and fine pictures are provided.

Adjustable Feet

Picture tilt and projection angle can be adjusted by twisting ADJUSTABLE FEET. Projection angle can be adjusted 0 to 2 degrees by rotating Adjustable Feet.

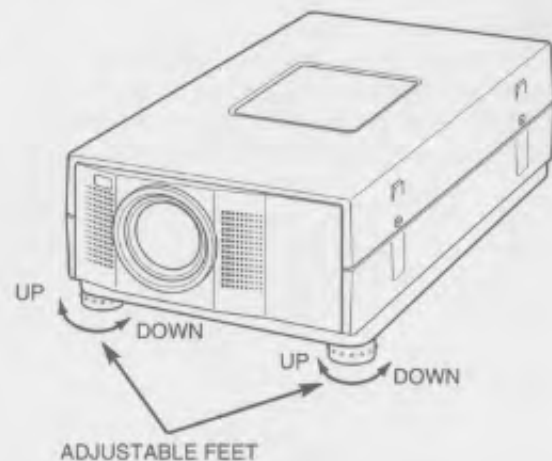

CONNECTING THE AC POWER CORD

This projector uses nominal input voltages of 100-120 V AC. The projector automatically selects the correct input voltage. It is designed to work with single-phase power systems having a grounded neutral conductor. To reduce the risk of electrical shock, do not plug into any other type of power system.

Consult your authorized dealer or service station if you are not sure of the type of power supply being in use.

Connect the projector with the peripheral equipment before turning the projector on. (Refer to pages 10 ~15 for connection.)

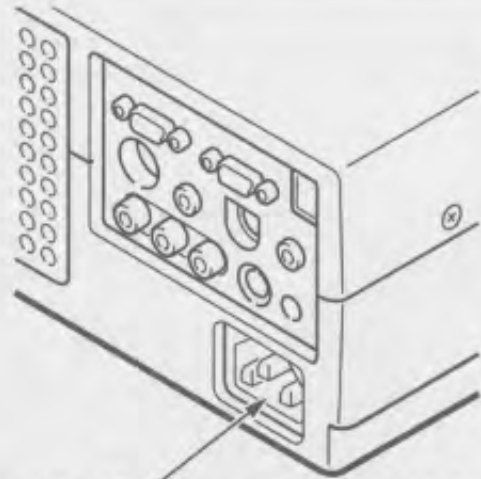

Connect the AC power supply cord (provided) to the projector.

The socket-outlet must be near this equipment and must be easily accessible.



CAUTION

For the safety, unplug the AC Power Cord when the appliance is not used.

When this projector is connected to the outlet with the AC Power Cord, the appliance is in Stand-by Mode and consumes a little electric power.

Projector side (Female)

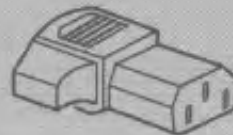

AC outlet side (Male)



Ventilation

This projector is equipped cooling fans for protection from overheating. Pay attention to the following to ensure the ventilation and avoid a possible risk of fire and malfunction.

- Do not cover the vent slot.
- Keep the rear grill at least one meter away from any object.
- Make sure that there is no object under the projector. An obstacle under the projector may prevent the projector from taking the cooling air through the bottom vent slot.

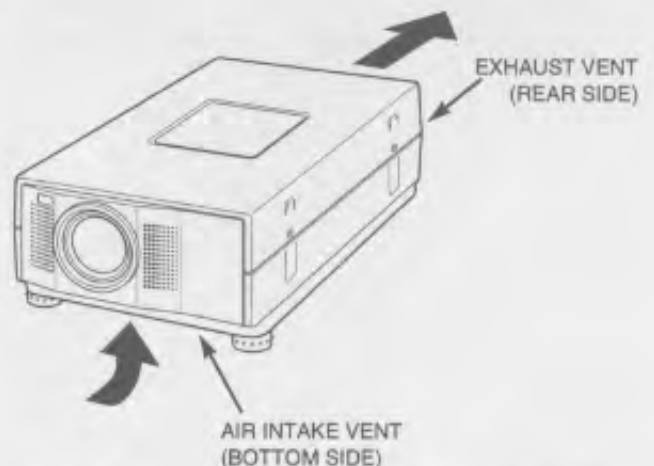

Moving the Projector

Use the Carry Handle when moving the Projector.

- Replace the lens cover and rotate the feet fully clockwise (to shorten the feet) when moving the projector to prevent damage to the cabinet.

NOTE

The carrying bag (supplied) is intended for protection from dust and scratches on the surface of the cabinet, and it is not designed to protect the LCD projector from external shock.

Do not drop the projector, subject it to strong forces, or put other things on the cabinet when carrying the projector with this bag. Do not transport the projector through a courier or transport services with this bag. The projector can be damaged.

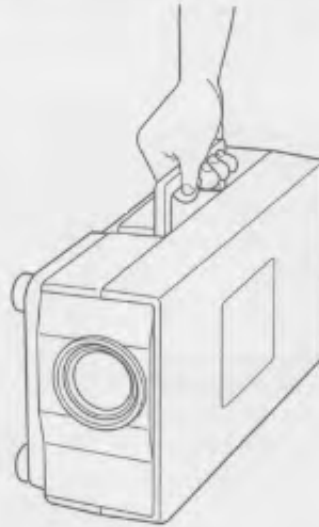

CAUTION IN CARRYING OR TRANSPORTING THE PROJECTOR

- Do not drop or give a shock to the projector, otherwise damages or malfunctions may result.
- When carrying the projector, use a carrying case recommended by Eiki.
- Do not transport the projector by using a courier or transport service in an unsuitable transport case. This may cause damage to the projector. To transport the projector through a courier or transport service, use a case recommended by Eiki.
- For carrying or transportation cases, contact a Eiki authorized dealer.

CONNECTING THE PROJECTOR

TERMINALS OF THE PROJECTOR

COMPUTER INPUT TERMINAL

Connect the computer output to this terminal.
(Refer to P12 -15.)

MONITOR OUTPUT TERMINAL

Connect to the monitor to this terminal.
(Refer to P12 -15.)

CONTROL PORT CONNECTOR

When controlling the computer with the Remote Control of this projector, connect the mouse port to this terminal.
(Refer to P12 -15.)

MCI SERIAL TERMINAL

This terminal is used to connect a computer to edit (write and read) the data of PC card with "Media Card Imager."
(Refer to P12 -15, 37.)

COMPUTER AUDIO INPUT JACK

Connect the audio output from the computer to this terminal.
(Refer to P12 -15.)

AUDIO OUTPUT JACK

Connect the audio amplifier to this terminal.
(Refer to P12 -15.)

AUDIO INPUT JACKS

Connect the audio outputs from the video equipment to these terminals.
(Refer to P11.)

- When the audio output is monaural, connect it to the Left jack.

VIDEO INPUT JACK

Connect the S-VIDEO output from the video equipment to this terminal.
(Refer to P11.)

S-VIDEO INPUT JACK

Connect the S-VIDEO output from the video equipment to this terminal.
(Refer to P11.)

RESET BUTTON

This projector adopts micro computer to control the appliance. The micro computer rarely work incorrectly and may not control the projector properly. In that case, press RESET button with sharpened tool (like pen) to shut down the appliance. The projector is switched off.
Do not use RESET button unreasonably.

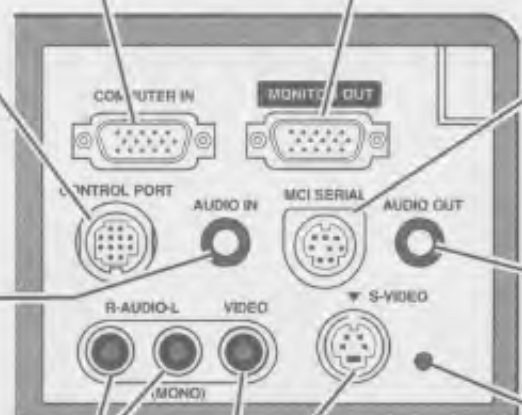

COMPUTER INPUT / MONITOR OUTPUT TERMINAL

Terminal : HDB15-PIN

Connect the display output terminal of the computer to COMPUTER INPUT with the VGA Cable (supplied). And connect the monitor to MONITOR OUTPUT with the monitor cable (not supplied). When connecting the Macintosh computer, the MAC/VGA Adapter is required.

Pin Configuration



1	Red Input	9	Non Connect
2	Green Input	10	Ground (Vert.sync.)
3	Blue Input	11	Sense 0
4	Sense 2	12	Sense 1
5	Ground (Horiz.sync.)	13	Horiz. sync.
6	Ground (Red)	14	Vert. sync.
7	Ground (Green)	15	Reserved
8	Ground (Blue)		

CONTROL PORT CONNECTOR

Terminal : MULTI-POLE 12-PIN

When controlling the computer with the projector's Wireless Remote Control Unit, connect control port (PS/2, Serial or ADB port) on your computer to this terminal.
(Three types of cables are supplied.)

Pin Configuration

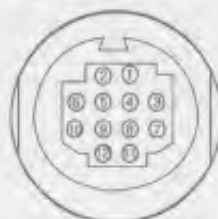

	PS/2	Serial	ADB
1	---	T X D	---
2	CLK	---	ADB
3	DATA	---	---
4	---	---	---
5	---	R X D	---
6	---	---	---
7	---	READY	---
8	---	---	---
9	GND	GND	GND
10	---	---	---
11	---	---	---
12	---	---	---

CONNECTING TO THE VIDEO EQUIPMENTS



Video / Audio Output S-VIDEO Output

Use Cables and Adapter indicated below.

- VIDEO CABLE (not supplied)
- S-VIDEO CABLE (not supplied)
- AUDIO CABLE (not supplied)

Use the either of VIDEO jack or S-VIDEO jack. When the both jacks are connected, the S-VIDEO jack has priority over the VIDEO jack.

Video Audio Cable (Not supplied) S-VIDEO Cable (Not supplied)

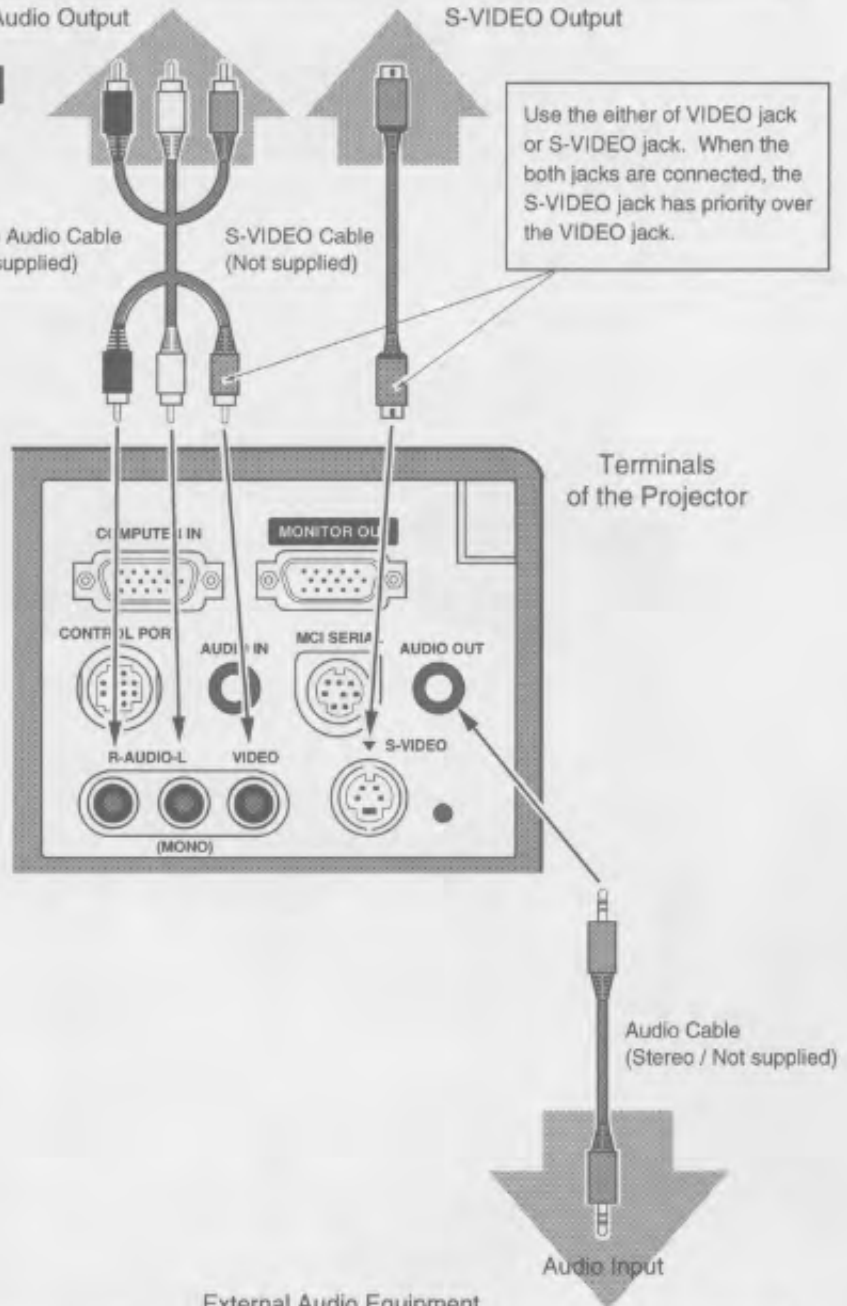

NOTE : When connecting the cable, the power cords of both the projector and the external equipment should be disconnected from AC outlet. Turn the projector and peripheral equipment on before the computer is switched on.

External Audio Equipment

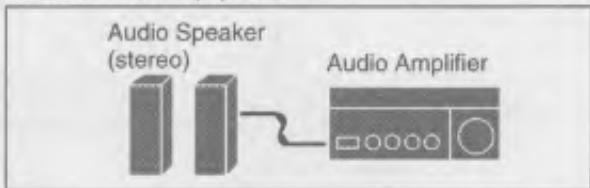

CONNECTING TO THE IBM-COMPATIBLE COMPUTER

To connect with the IBM-compatible computer, refer to the figure below.

Use Cables and Adapter indicated below.

- VGA CABLE (supplied)
- MOUSE CABLE FOR PS/2 PORT or SERIAL PORT (supplied)
- MCI SERIAL CABLE (supplied)
- MONITOR CABLE (not supplied)
- AUDIO CABLE (stereo /not supplied)

◆ Be sure to connect the MOUSE CABLE corresponding with the terminal of your computer.



NOTE :

When connecting the cable, the power cords of both the projector and the external equipment should be disconnected from AC outlet. Turn the projector and peripheral equipment on before the computer is switched on.

IBM-COMPATIBLE COMPUTERS (VGA / SVGA / XGA / SXGA)

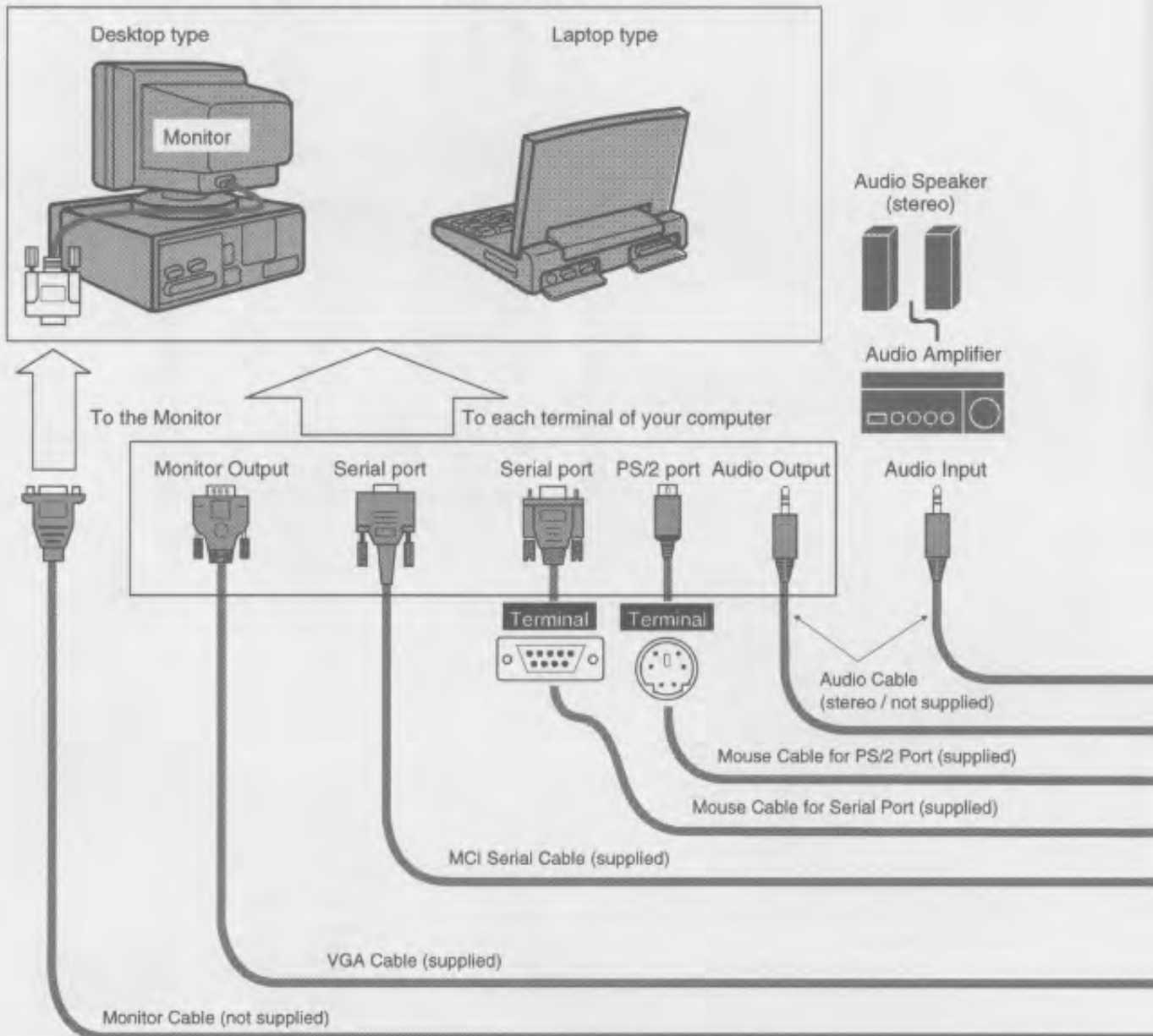

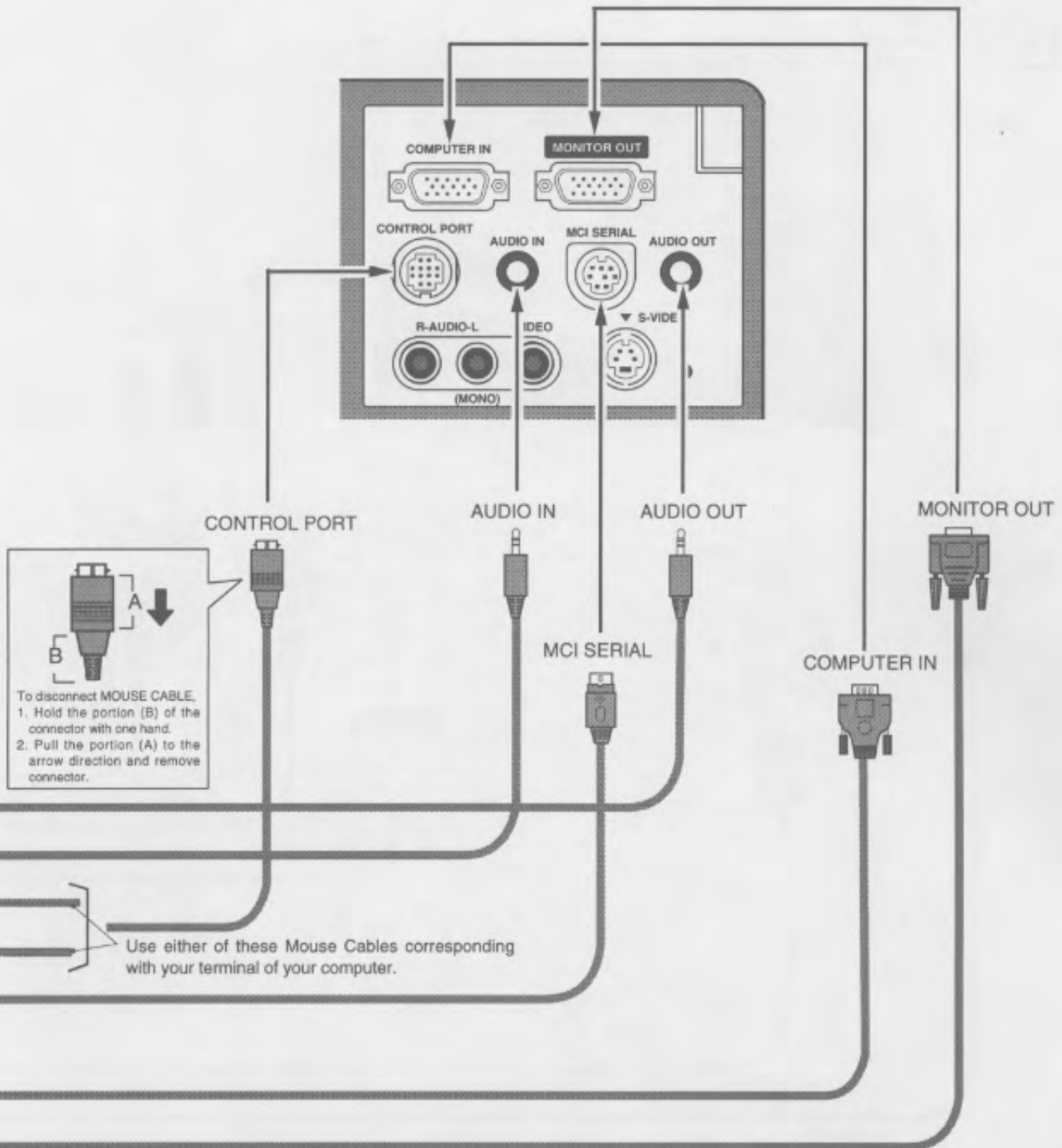

CONNECTION TO THE MACINTOSH COMPUTER

To connect with the Macintosh computer, refer to the figure below.

Use Cables and Adapter indicated below.

- VGA CABLE (supplied)
- VGA/MAC ADAPTER (supplied)
- MOUSE CABLE FOR ADB PORT (supplied)
- MONITOR CABLE (not supplied)
- PC AUDIO CABLE (stereo / not supplied)



NOTE :

When connecting the cable, the power cords of both the projector and the external equipment should be disconnected from AC outlet. Turn the projector and peripheral equipment on before the computer is switched on.

MACINTOSH COMPUTERS (VGA / SVGA / XGA / SXGA)

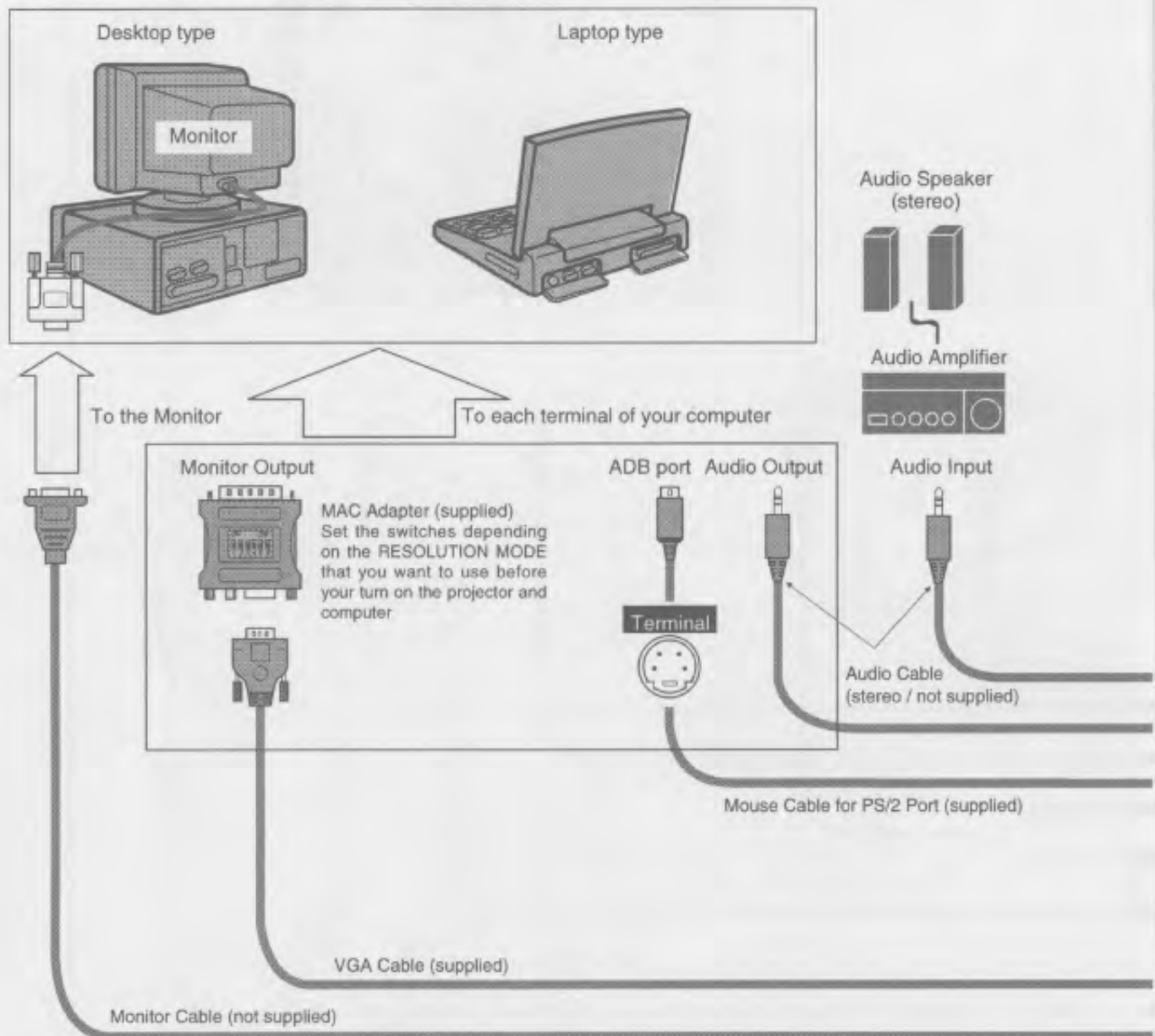

◆ MAC/VGA ADAPTER

Set the switches as shown in the table below depending on the RESOLUTION MODE that you want to use before your turn on the projector and computer.

	1	2	3	4	5	6
13" MODE (640 x 480)	ON	ON	OFF	OFF	OFF	OFF
16" MODE (832 x 624)	OFF	ON	OFF	ON	OFF	OFF
19" MODE (1024 x 768)	OFF	ON	ON	OFF	OFF	OFF
21" MODE (1152 x 870)	ON	ON	ON	ON	OFF	OFF

ON
OFF

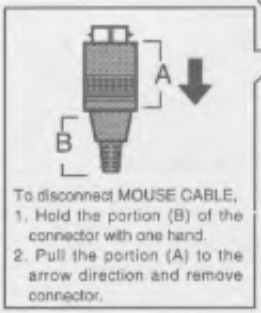
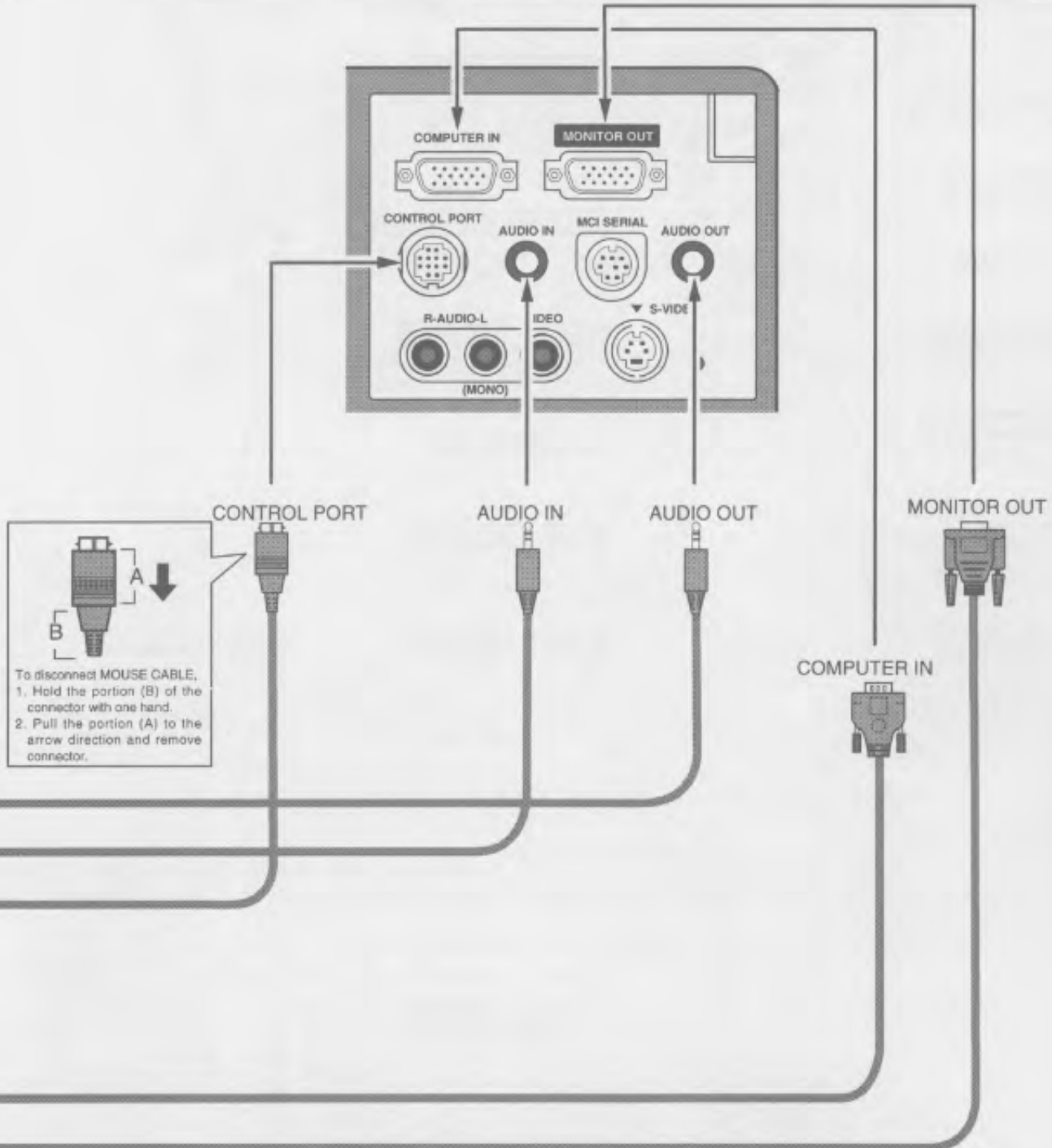
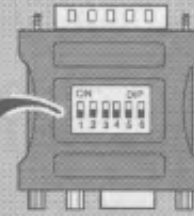

BEFORE OPERATION

OPERATION OF THE REMOTE CONTROL

This remote control unit is not only able to operate the projector but also usable as a wireless mouse for a PC. POINT button and two CLICK buttons are used for wireless mouse operation. (Refer to page 41.) Wireless mouse is usable when PC mouse pointer is displayed on the screen, the wireless mouse cannot be used when the On-Screen Menu is displayed.

VIDEO BUTTON

Used to select VIDEO source. (P31)

COMPUTER / MCI BUTTON

Used to select source either COMPUTER or MCI mode. (P25)

VOLUME BUTTONS

Used to adjust volume. (P24)

FOCUS BUTTON

Used to adjust focus. (P23)

MUTE BUTTON

Used to mute sound. (P24)

AUTO IMAGE BUTTON

Use to operate AUTO IMAGE function. (P 29)

CURSOR BUTTON

Used to display CURSOR on the screen. (P23)

POINT BUTTON

Used to select an item on the MENU. It is also used to pan the image in DIGITAL ZOOM mode. (P30, 36)

LASER BUTTON

Used to operate laser pointer function. The laser beam is emitted while pressing this button.

ZOOM BUTTON

Used to adjust zoom. (P23)

POWER ON-OFF BUTTON

Used to turn the projector on or off. (P22)

PAGE BUTTON

Used to move to next / previous page of the data in memory card. This buttons are activated in MCI mode only. (P34)

FREEZE / NO SHOW BUTTON

Used to stop the picture or to turn the picture into black image. (P23)

NORMAL BUTTON

Used to reset to normal picture adjustment preset by the factory. (P29, 32)

MENU BUTTON

Used to call MENU operation. (P19)

D.ZOOM BUTTON

Used to turn the projector into DIGITAL ZOOM mode. (P30, 36.)

FRONT CLICK BUTTON

Used as right button of PC mouse in wireless mouse operation. It is also used to compress the image in DIGITAL ZOOM mode. (P30, 36)



SELECT BUTTON

Used to execute the item selected, or to increase or decrease the values in certain items such as CONTRAST or BRIGHTNESS. It is also used to expand the image in DIGITAL ZOOM mode. (P30, 36)

LASER POINTER button

This remote control emits a laser beam as the Laser Pointer from the Laser Light Window. When the LASER button is pressed, the laser light goes on: When the button is released, light goes off. Laser light is emitted with the RED light which tells the laser beam being emitted. The laser emitted is a class II laser; therefore, do not look into the Laser Light Window or shine the laser beam on yourself or other people. The three marks to the right are the caution labels for the laser beam.

CAUTION: Use of controls or adjustments or performance of procedures other than those specified herein may result hazardous radiation exposure.



Laser Light Window

These caution labels are put on the remote control.

<p>CAUTION</p> <p>LASER RADIATION- DO NOT STARE INTO BEAM</p> <p>MAX OUTPUT: 1mW WAVELENGTH: 650nm CLASS II LASER PRODUCT</p> <p>This product is compliant with CE (EN 60825-1, Annex B)</p>	<p>LASER RADIATION- DO NOT STARE INTO BEAM CLASS II LASER PRODUCT LASER STRAHLUNG- NICHT IN DEN STRAHLEN BLICKEN</p> <p>LASER-KLASSE 2 レーザー放射クラス2レーザー製品 ビームをのぞき込まないこと IEC60825-1, Annex B MAX OUTPUT (最大出力): 1mW WAVELENGTH (波長): 650nm</p>
-----------------------------------------------------------------------------------------------------------------------------------------------------------------------------------------------------------------	---------------------------------------------------------------------------------------------------------------------------------------------------------------------------------------------------------------------------------------------------------------------------------



<p>AVOID EXPOSURE-LASER RADIATION IS EMITTED FROM THIS APERTURE</p> <p>レーザー光の出口 ビームをのぞき込まないこと</p>

Remote Control Batteries Installation

1 Remove the battery compartment lid.

Press the lid downward and slide it.



2 Slide the batteries into the compartment.

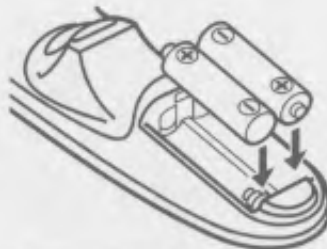

For correct polarity (+ and -), be sure the battery terminals are in contact with the pins in the compartment.

3 Replace the compartment lid.

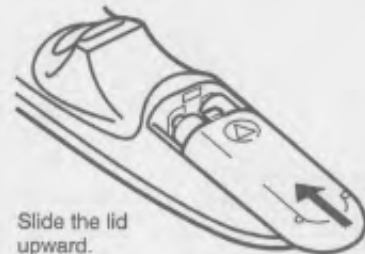

Slide the lid upward.



To insure safe operation, please observe the following precautions :

- Use (2) AA type alkaline batteries.
- Replace two batteries at the same time.
- Do not use a new battery with a used battery.
- Avoid contact with water or liquid.
- Do not drop the remote control unit.
- If batteries have leaked on the remote control, carefully wipe the case clean and load new batteries.

Operating Range of the Remote Control

Point the remote control toward the projector (Receiver Window) whenever pressing the buttons. Maximum operating range for the remote control is about 16.4' (5m) and 60° front and rear of the projector

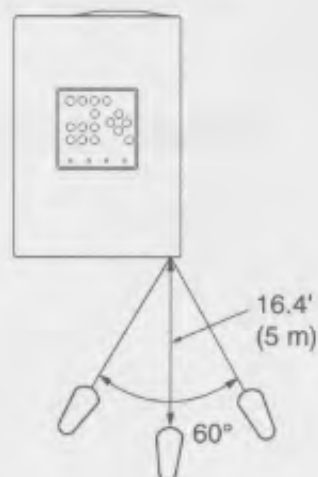
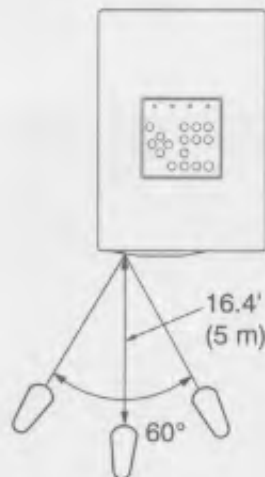

TOP CONTROLS AND INDICATORS

MODE BUTTON

Used to select input source.
(Computer, Video and MCI)
(Refer to P25 and 31.)

POWER ON-OFF BUTTON

Used to turn the projector on
or off. (Refer to P22.)

PAGE BUTTONS

Used to move next/previous
page of the data in the memory
card plugged into PC CARD
SLOT. These buttons are used
to stop or resume AUTO-PLAY
function. Page buttons are
activated in MCI mode.
(Refer to P34.)

VOLUME BUTTONS

Used to adjust volume.
(Refer to page 24.)

FOCUS BUTTON

Used to select focus adjust.
(Refer to page 23.)

LAMP INDICATOR

This indicator is lit in dim
when the projector is turned
on. And the light is brightened
when the projector is in stand-
by mode.

READY INDICATOR

This indicator is lit in green
when the projector is ready
to be turned on.

WARNING TEMP. INDICATOR

This indicator flashes red
when internal projector
temperature is too high.
(Refer to page 42.)

LAMP REPLACE INDICATOR

This indicator turns to yellow
when the life of the projection
lamp draws to an end.
(Refer to page 43.)

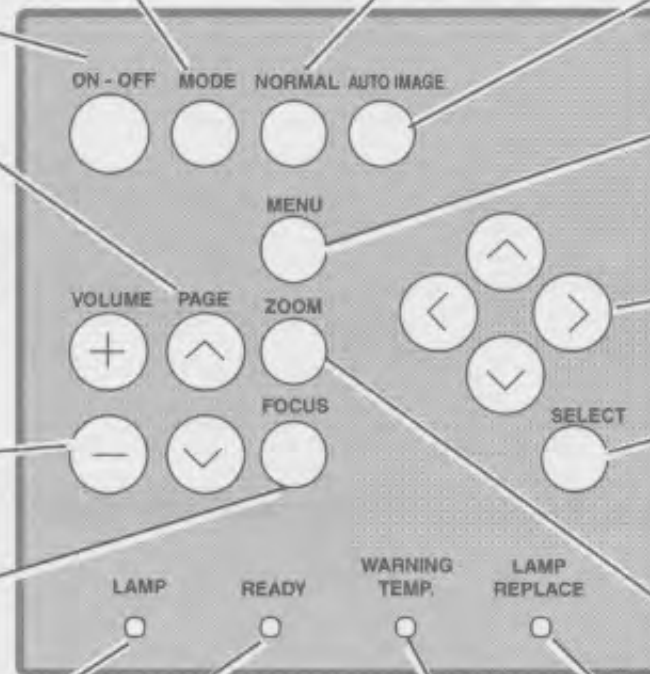

NORMAL BUTTON

Used to reset to normal picture
adjustment preset by factory.
(Refer to P29 and 32.)

AUTO IMAGE BUTTON

Used to operate AUTO IMAGE
function.
(Refer to page 29.)

MENU BUTTON

Used to active or terminate the
MENU operation.
(Refer to page 19.)

POINT BUTTONS

Used to move the pointer.
(Refer to page 19.)

SELECT BUTTON

Used to execute the item
selected or to adjust the values
in certain items on the MAIN
MENU DISPLAY.

ZOOM BUTTON

Used to select zoom adjust.
(Refer to page 23.)

OPERATING ON-SCREEN MENU

HOW TO OPERATE ON-SCREEN MENU

You can control and adjust this projector through ON-SCREEN MENU. Refer to the following pages to operate the each adjustment on the ON-SCREEN MENU.

1 MOVING THE POINTER

Move the pointer (see the NOTE below) by pressing POINT button(S) on the TOP CONTROL or the REMOTE CONTROL(S).

2 SELECT THE ITEM

Select the item by pressing SELECT button.

NOTE :Pointer is the icon on the ON-SCREEN Menu to select the item. See the figures on the section "FLOW OF ON-SCREEN MENU" below.

WIRELESS REMOTE CONTROL

POINT BUTTON

Used to move the Pointer to UP/ DOWN/ RIGHT/ LEFT.



SELECT BUTTON

Used to select the item.

TOP CONTROL

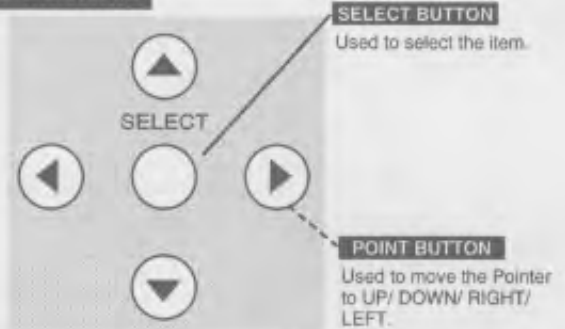

SELECT BUTTON

Used to select the item.

POINT BUTTON

Used to move the Pointer to UP/ DOWN/ RIGHT/ LEFT.

FLOW OF ON-SCREEN MENU

Display ON-SCREEN MENU

- 1 Press MENU button to display the ON-SCREEN MENU (MENU BAR). The red frame is the POINTER.

Select the MENU

- 2 Move the POINTER (red frame) to the ITEM ICON that you want to select by pressing POINT RIGHT/ LEFT buttons.
- 3 Select the ITEM by pressing SELECT button. The dialog box of the ITEM appears.

Control and adjust through ON-SCREEN MENU

- 4 Move the POINTER downward by pressing POINT DOWN button. (The shape of POINTER become an arrow.)
- 5 Move the POINTER to the ITEM that you want to adjust and adjust the ITEM by pressing SELECT button. Refer to the following pages for details of respective adjustments.

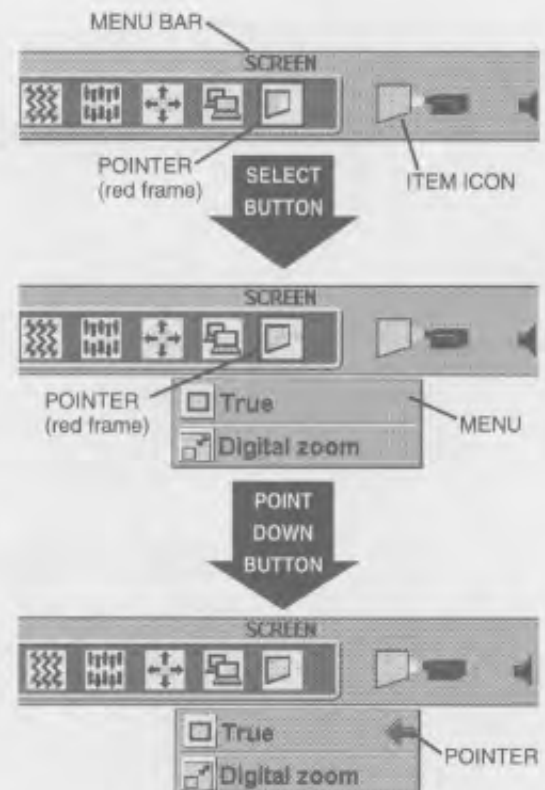

MENU BAR

MENU BAR IN COMPUTER MODE

Press MENU BUTTON while being in Computer mode.

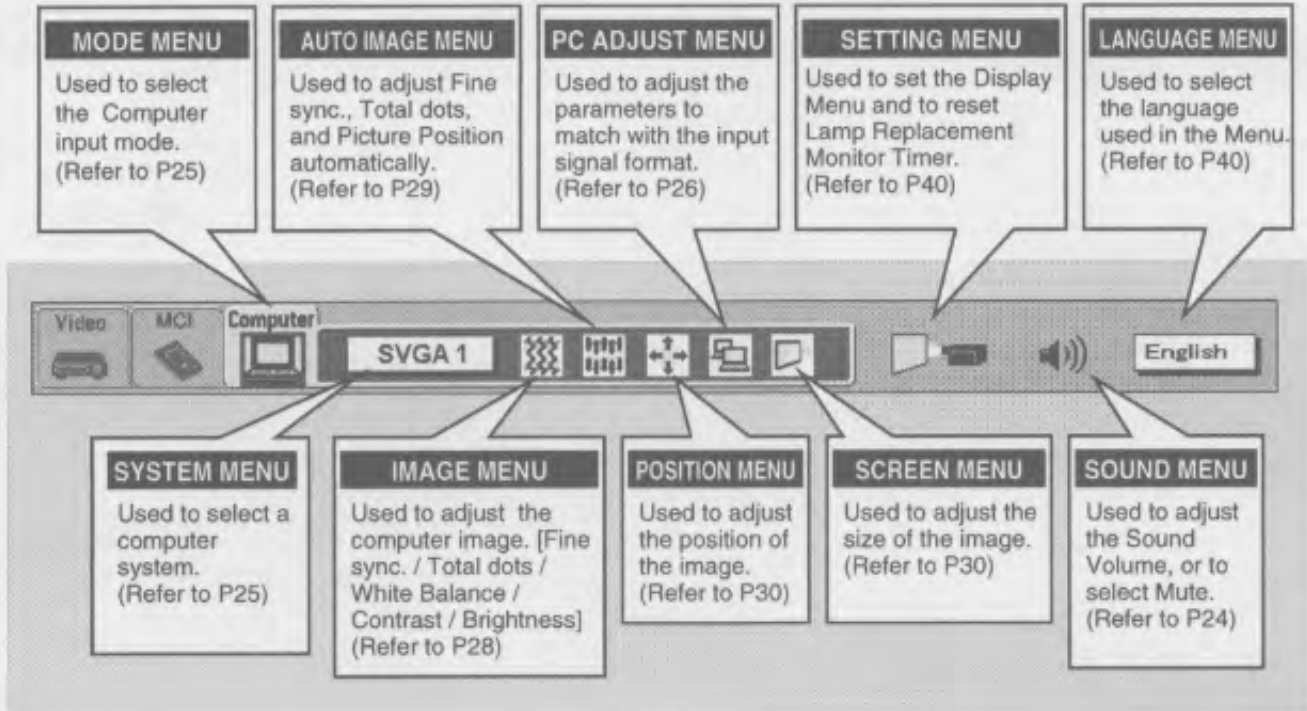

MENU BAR IN VIDEO MODE

Press MENU BUTTON while being in Video mode.

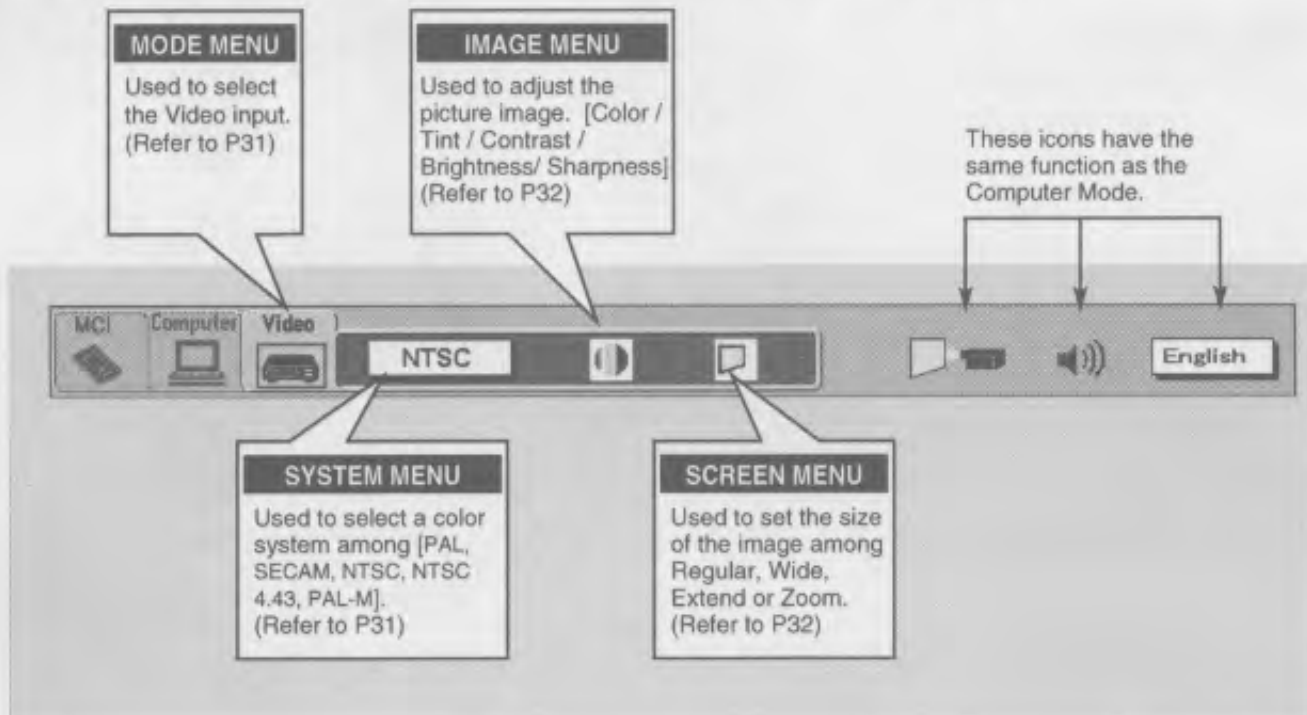

MENU BAR IN MCI MODE

Press MENU BUTTON while being in MCI mode.

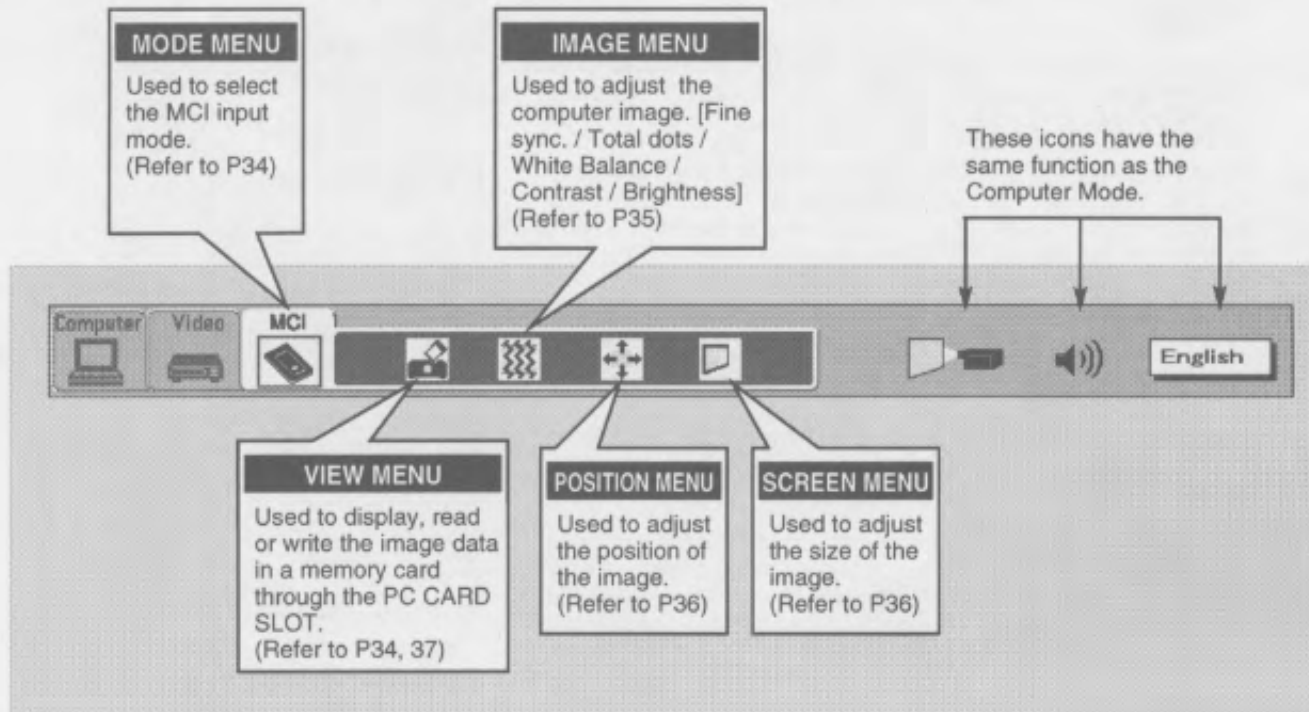

TURNING ON / OFF THE PROJECTOR

Turning on the Projector

- 1 Complete the peripheral connections (with Computer, VCR, and etc.) before turning on the projector. (Refer to "CONNECTING TO THE PROJECTOR" on Pages 10~15 for connecting those equipment.
- 2 Connect the projector's AC power cord into a wall outlet. The LAMP POWER indicator lights RED, and the READY indicator lights GREEN.
- 3 Press the power ON-OFF button on the Remote Control Unit or on the Top Control to ON. The LAMP POWER indicator dims, and the Cooling Fans start to operate. The Preparation Display appears on the screen and the count-down starts. The signal from the source appears after 30 seconds.



The Preparation Display disappears after 30 seconds.

Turning off the Projector

- 1 Press the power ON-OFF button on the Remote Control Unit or on the Top Control, and the message "Power off?" appears on the screen.
- 2 Press again the power ON-OFF button to turn off the projector. The LAMP POWER indicator lights bright and the READY indicator turns off. The Cooling Fans operate for 90 seconds after the projector is turned off. (During this "Cooling Down" period, this appliance cannot be turned on.)
- 3 When the cooling the projector has finished, the READY indicator turns to green again and you can turn the projector on. To power down completely, disconnect the AC power cord.

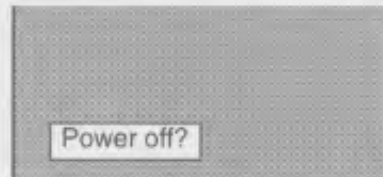

The message disappears after 4 seconds.



TO MAINTAIN THE LIFE OF THE LAMP, ONCE YOU TURN IT ON, WAIT AT LEAST 5 MINUTES BEFORE TURNING IT OFF.

When the TEMPERATURE WARNING indicator flashes red, the projector is automatically turned off. Wait at least 5 minutes before turning the projector on again.

If the TEMPERATURE WARNING indicator continues to flash, follow procedures below:

1. Press the power ON-OFF button to OFF.
2. Check the air filters for dust accumulation.
3. Remove dust with vacuum cleaner. (See "AIR FILTER CARE AND CLEANING" section on page 46.)
4. Press the power ON-OFF button to ON.

If the TEMPERATURE WARNING indicator still continues to flash, call your authorized dealer or service station.

NOTE : The Cooling Fan may work for cooling while the projector is turned off. When the Cooling Fan is working, TEMPERATURE WARNING INDICATOR flashes red.

ADJUSTING THE IMAGE

ZOOM Adjustment

- 1 Press ZOOM button on the Top Control or the Remote Control to turn into the ZOOM mode.
- 2 Adjust the size of the image by pressing POINT UP/DOWN button. Press UP button to have the image larger, and press DOWN button to have the smaller.



The message disappears after 4 seconds.

FOCUS Adjustment

- 1 Press FOCUS button on the Top Control or the Remote Control to turn into the FOCUS mode.
- 2 Adjust the focus of the image by pressing POINT UP or DOWN button.

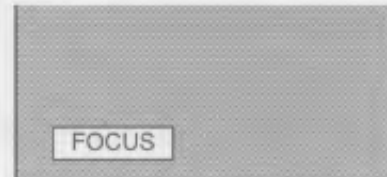

The message disappears after 4 seconds.

PICTURE FREEZE / NO SHOW FUNCTION

Press the FREEZE / NO SHOW button on the Remote Control Unit to turn the picture remained on-screen or turn the picture into black image. These function is cancelled when the FREEZE / NO SHOW button is pressed again or any other function button is pressed.

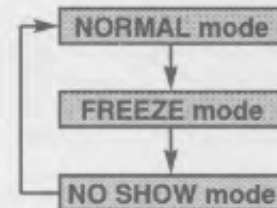

CURSOR FUNCTION

This projector can display a cursor by pressing cursor button on the Remote Control. The cursor can be controlled with the POINT buttons. To terminate the Cursor Function, press CURSOR button again.

NOTE : The cursor settings set with the "Media Card Imager" is not available in this projector.

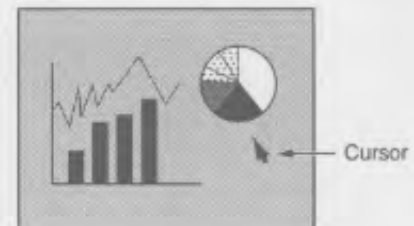

SOUND ADJUSTMENT

Direct Operation

Sound Volume Adjustment

Press the VOLUME (+/-) buttons (located on the Top Control or on the Remote Control Units) to adjust the volume. The Volume dialog box appears on the screen for a few seconds.

(+) button to increase the volume, and (-) button decreasing.

Sound Mute Setting

Press the MUTE button on the Remote Control Units to cut off the sound. To restore the sound to its previous level, press again or press Volume buttons.

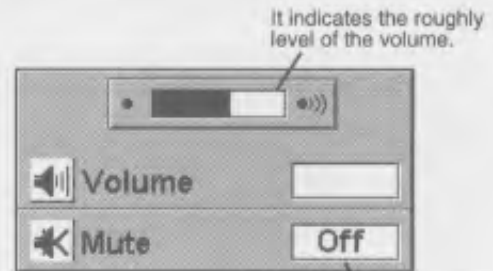

Press the MUTE button to set the Mute function On or Off.

The display disappears after 4 seconds.

Menu Operation

- 1 Press the MENU button and the ON-SCREEN MENU will appear. Press the POINT LEFT/RIGHT buttons to select SOUND and press the SELECT button. Another dialog box SOUND ADJUST Menu will appear.
- 2 Press the POINT DOWN button and a red-arrow icon will appear. Move the arrow to the item that you want to select by pressing the POINT UP/DOWN buttons.

Volume Move the arrow to ▲ or ▼ of "Volume" by pressing the POINT UP/ DOWN buttons. To increase the volume, point the arrow to ▲ and then press the SELECT button. To decrease the volume point the arrow to ▼ and then press the SELECT button.

Mute To cut off the audio sound, point the arrow to "Mute" and then press the SELECT button. The Mute display is changed On from Off and the sound is cut off. To restore the sound to its previous volume level, set the Mute to Off.

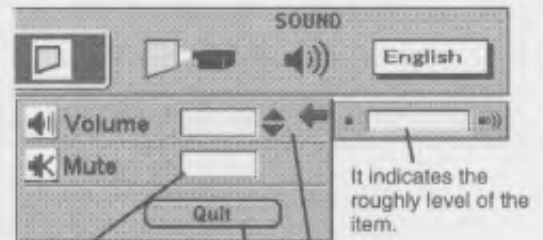

Move the arrow to the item and then press the SELECT button.

Move the arrow to ▲ or ▼ and press the SELECT button.

It closes the Sound Menu.

SELECTING COMPUTER MODE

Direct Operation

Press the MODE button on the Top Control or the COMPUTER / MCI button on Remote Control Unit. Select the Mode among COMPUTER, VIDEO, or MCI mode.

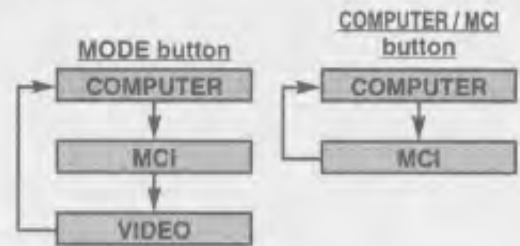

Menu Operation

Press the MENU button and the ON-SCREEN MENU will appear. Press the POINT LEFT/RIGHT buttons to select Computer  and press the SELECT button.

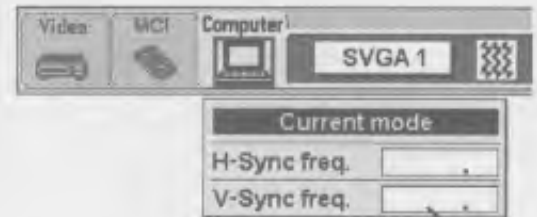

Providing the information of the computer detected by the projector.

CURRENT MODE DISPLAY

When selecting the Computer Mode, the Current Mode display appears. It shows the information of the computer of the mode selected.

SELECTING COMPUTER SYSTEM

Automatic Multiscanning system

This projector automatically adapt to most different types of computer based on VGA, SVGA or XGA (refer to "COMPATIBLE COMPUTER SPECIFICATION" on page 27). When selecting Computer, this projector become automatically suited to the incoming signal and projectors the proper image without any special setting. (Setting of the Computer System may be required when connecting some computers.)

Note : The projector may provides the messages below.

Go PC adj. The projector cannot discriminate or detect the input signal from the computer. Adjust and set the computer system manually. (Refer to page 26.)

No signal There is no signal input from the computer. Make sure the connection of the computer and the projector is set correctly. (Refer to TROUBLESHOOTING on page 44.)



SYSTEM BOX

It displays the SYSTEM being selected.

Selecting Computer System Manually

To set the Computer system manually, select the mode on the ON-SCREEN MENU.

- 1 Press the MENU button and the ON-SCREEN MENU will appear. Press the POINT LEFT/RIGHT buttons to select SYSTEM and press the SELECT button. Another dialog box COMPUTER MODE Menu will appear. (The COMPUTER MODE Menu also appears by pressing the SYSTEM button on the Top Control or the Remote Control Units.)
- 2 Press the POINT DOWN button and a red-arrow icon will appear. Move the arrow to the system that you want to set, and then press SELECT button.

The system being selected.



The systems on this dialog box can be selected.

When this mark is displayed as black, more computer system modes will be available. Move the arrow to this mark and then press the SELECT button, and another mode will be displayed.

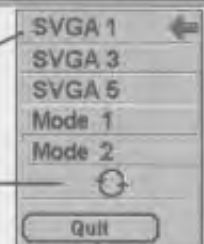

It closes the SYSTEM Menu.

PC ADJUSTMENT

This Projector can automatically detect display signals from most personal computers currently distributed. However, some computers employ special signal formats which are different from the standard ones and may not be detected by this projector. If this happens, the projector cannot reproduce a proper image and the image is recognized as a flickering picture, a non-synchronized picture, a non-centered picture or a skewed picture.

This projector has PC ADJUSTMENT function, to enable you to precisely adjust several parameters to match with the input signal format. The projector has eight independent memory areas where you can store the parameter you have set. This enables you to recall the setting for a specific computer whenever you need it.

- 1 Press the MENU button and the ON-SCREEN MENU will appear. Press the POINT LEFT/RIGHT buttons to select PC ADJUST and press the SELECT button. Another dialog box "Where to reserve" Menu will appear.
- 2 In this dialog box, you can store the parameter into the area from "Mode 1" to "Mode 8." When memorizing the new computer parameter, select the Mode with the message of "Free" by pressing the POINT UP/DOWN buttons and SELECT button. To change the parameters of the Mode previously set, select the Mode with "Stored."
- 3 When the Mode is selected, Parameter adjustment dialog box appears. Adjust the each item to match with your computer.

- Total lines** The number of the total vertical lines. Adjust the number to match your PC image.
- Total dots** The number of the total dots in one horizontal period. Adjust the number to match your PC image.
- Horizontal** Adjustment of the horizontal picture position. When the image is not centered on the screen, adjust this item.
- Vertical** Adjustment of the vertical picture position. When the image is not centered on the screen, adjust this item.
- Clamp** Adjustment of the clamp level. When the image has a dark bar(s), try this adjustment.
- Height** Adjusting the vertical height of the picture image.
- Width** Adjusting the horizontal width of the picture image.

- 4 When the parameter data adjustment finishes to be set, select "Stored" and press the SELECT button. "OK?" dialog box is displayed for confirmation.

Each of the keys operates as follow.

- Reset** It recall the parameter data that previously adjusted.
- Mode free** It clear the parameter data previously set the selected Mode.
- Stored** It stores the parameters in the memory.
- Quit** It closes the PC ADJUST Menu.

- 5 To select the Mode manually adjusted in PC ADJUSTMENT Menu, select the mode at the SYSTEM SELECT Menu. (Refer to page 25.)

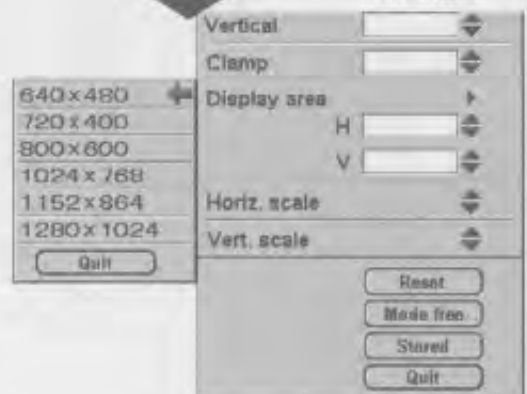
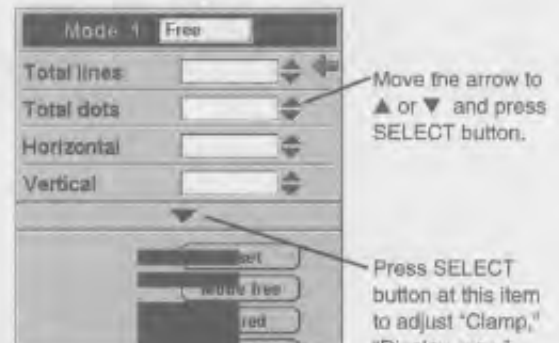
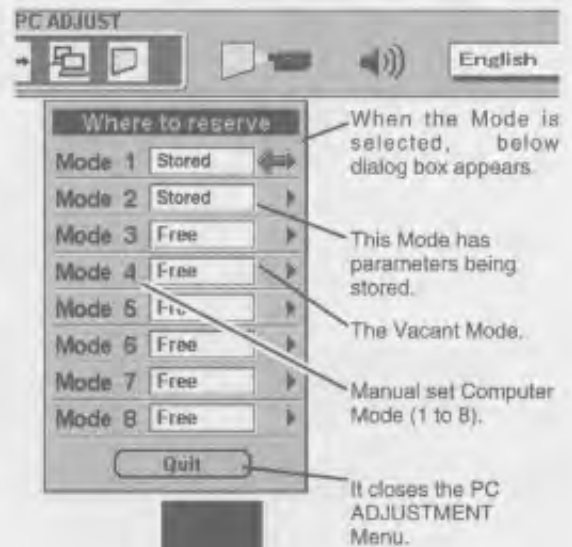

COMPATIBLE COMPUTER SPECIFICATIONS

Basically this projector can accept the signal from all computers with the V, H-Frequency below mentioned and less than 160 MHz of Dot Clock.

ON-SCREEN DISPLAY	RESOLUTION	H-Freq. (kHz)	V-Freq. (Hz)	ON-SCREEN DISPLAY	RESOLUTION	H-Freq. (kHz)	V-Freq. (Hz)
VGA 1	640 x 480	31.47	59.88	XGA 5	1024 x 768	60.31	74.92
VGA 2	720 x 400	31.47	70.09	XGA 6	1024 x 768	48.50	60.02
VGA 3	640 x 400	31.47	70.09	XGA 7	1024 x 768	44.00	54.58
VGA 4	640 x 480	37.86	74.38	XGA 8	1024 x 768	63.48	79.35
VGA 5	640 x 480	37.86	72.81	XGA 9	1024 x 768 (Interlace)	36.00	43.59
VGA 6	640 x 480	37.50	75.00	XGA 10	1024 x 768	62.04	77.07
VGA 7	640 x 480	43.269	85.00	XGA 11	1024 x 768	61.00	75.70
MAC LC13	640 x 480	34.97	66.60	XGA 12	1024 x 768 (Interlace)	35.522	43.48
MAC 13	640 x 480	35.00	66.67	XGA 13	1024 x 768	46.90	58.20
MAC1 6	832 x 624	49.72	74.55	XGA 14	1024 x 768	47.00	58.30
MAC 19	1024 x 768	60.24	75.08	XGA15	1024 x 768	58.03	72.0
MAC21	1152 x 870	68.68	75.06	SXGA 1	1152 x 864	64.20	70.40
MAC	1280 x 960	75.00	75.08	SXGA 2	1280 x 1024	62.50	58.60
MAC	1280 x 1024	80.00	75.08	SXGA 3	1280 x 1024	63.90	60.00
RGB	768 x 576 (Interlace)	15.625	25	SXGA 4	1280 x 1024	63.34	59.98
RGB	640 x 480 (Interlace)	15.734	30	SXGA 5	1280 x 1024	63.74	60.01
				SXGA 6	1280 x 1024	71.69	67.19
SVGA 1	800 x 600	35.156	56.25	SXGA 7	1280 x 1024	81.13	76.107
SVGA 2	800 x 600	37.88	60.32	SXGA 8	1280 x 1024	63.98	60.02
SVGA 3	800 x 600	46.875	75.00	SXGA 9	1280 x 1024	79.976	75.025
SVGA 4	800 x 600	53.674	85.06	SXGA 10	1280 x 960	60.00	60.00
SVGA 5	800 x 600	48.08	72.19	SXGA 11	1152 x 900	61.20	65.20
SVGA 6	800 x 600	37.90	61.03	SXGA 12	1152 x 900	71.40	75.60
SVGA 7	800 x 600	34.50	55.38	SXGA 13	1280 x 1024 (Interlace)	50.00	43.00
SVGA 8	800 x 600	38.00	60.51	SXGA 14	1280 x 1024 (Interlace)	50.00	47.00
SVGA 9	800 x 600	38.60	60.31	SXGA 15	1280 x 1024	63.37	60.01
SVGA 10	800 x 600	32.70	51.09	SXGA 16	1280 x 1024	76.97	72.00
SVGA 11	800 x 600	38.00	60.51	SXGA 17	1152 x 900	61.85	66.00
XGA 1	1024 x 768	48.36	60.00	SXGA 18	1280 x 1024 (Interlace)	46.43	43.35
XGA 2	1024 x 768	68.677	84.997	SXGA 19	1280 x 1024	63.79	60.18
XGA 3	1024 x 768	60.023	75.03	SXGA 20	1280 x 1024	91.146	85.024
XGA 4	1024 x 768	56.47	70.07				

NOTE : Specifications are subject to change without notice.

PICTURE IMAGE ADJUSTMENT

Adjust Picture Image Manually

- 1 Press the MENU button and the ON-SCREEN MENU will appear. Press the POINT LEFT/RIGHT buttons to select IMAGE  and press the SELECT button. Another dialog box PICTURE IMAGE ADJUSTMENT Menu will appear.
- 2 Press the POINT DOWN button and a red-arrow icon will appear. Move the arrow to ▲ or ▼ of the item that you want to change by pressing the POINT UP/DOWN buttons. To increase the value, point the arrow to ▲ and then press the SELECT button. To decrease the value point the arrow to ▼ and then press the SELECT button.

Fine sync

Adjust the picture as necessary to eliminate flicker from the display. (From 0 to 127.) This item can be adjusted by pressing the FINE SYNC. button on the Top Control or the Remote Control Units.

Total dots

The number of the total dots in one horizontal period. Adjust the number to match your PC image.

White Balance (Red / Green / Blue)

Point to ▼ to adjust the color of image lighter, and select ▲ to adjust the image deeper. (From 0 to 63.)

Contrast

Point to ▼ to adjust the image lighter, and select ▲ to adjust the image deeper. (From 0 to 63.)

Brightness

Point to ▼ to adjust the image darker, and select ▲ to adjust the image brighter. (From 0 to 63.)

Each of the keys operates as follow.

Reset It recalls the data previously adjusted.

Stored It stores the adjusted data in the memory.

Quit It closes the PICTURE IMAGE ADJUSTMENT Menu.

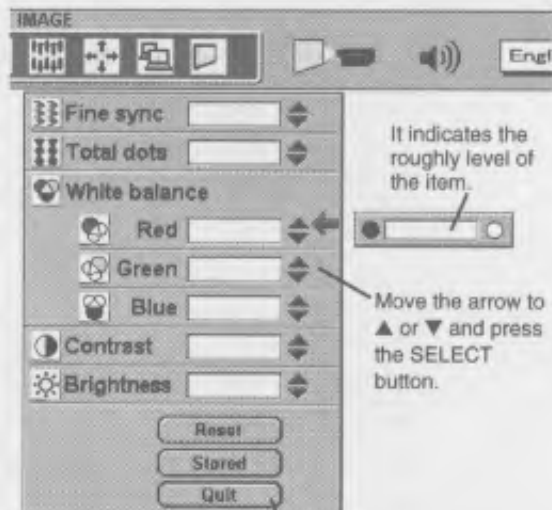

It indicates the roughly level of the item.

Move the arrow to ▲ or ▼ and press the SELECT button.

It closes the PICTURE IMAGE ADJUSTMENT Menu.

Auto Image Function

The Auto Image function is provided to automatically adjust Fine sync., Total dots, and Picture Position for most computers.

- 1 Press the MENU button and the ON-SCREEN MENU will appear. Press the POINT LEFT/RIGHT buttons to select AUTO IMAGE  and press the SELECT button. Another dialog box AUTO IMAGE Menu will appear.
- 2 Move the arrow to an item that you want to adjust by pressing the POINT UP/DOWN button. Change the setting On or Off by pressing the SELECT button.

Fine sync Adjust the picture as necessary to eliminate flicker from the display. This item can be adjusted manually. (Refer to page 28.)

Total Dots The number of the total dots in one horizontal period. This item can be adjusted manually. (Refer to page 28.)

Position Adjustment of the position of the image. This item can be adjusted manually. (Refer to page 30.)

- 3 Move the arrow to "Go!" and press the SELECT button to start the Auto Image function. This adjustment can be executed by pressing AUTO IMAGE button on the Top Control and the Remote Control.

NOTE : The Fine sync., Total dots, and Picture Position of some computers may not be fully adjusted with the Auto Image Function. In that case, manually adjustments is required to make fine image. (Refer to PICTURE IMAGE ADJUSTMENT on page 28 to adjust "Fine sync." or "Total dots" and PICTURE POSITION ADJUSTMENT on page 30 to adjust Picture Position.)

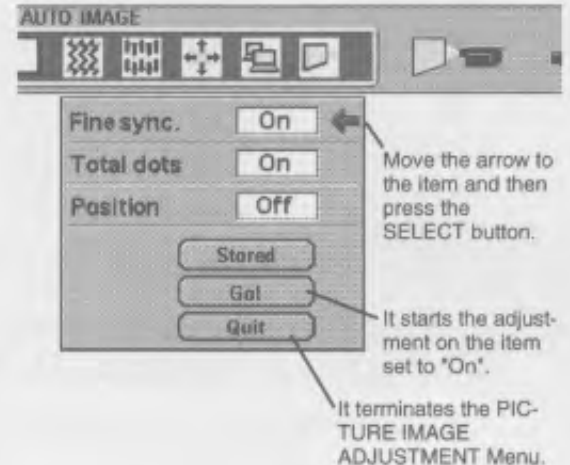

Normal Function

The normal picture level is preset on this projector by the factory and can be restored anytime by pressing the NORMAL button (located on the Top Control or on the Remote Control Units). The "Normal" display will be displayed on the screen for a few seconds.

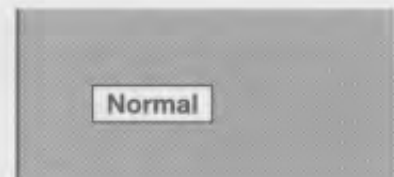

PICTURE POSITION ADJUSTMENT

The position of the image can be adjusted vertically and horizontally through PICTURE POSITION ADJUSTMENT.

- 1 Press the MENU button and the ON-SCREEN MENU will appear. Press the POINT LEFT/RIGHT buttons to select POSITION  and press the SELECT button. Another dialog box PICTURE POSITION Menu will appear.
- 2 Select the arrow to the direction (described as ←, →, ↑ or ↓) that you want to adjust by pressing the POINT UP/DOWN buttons, and then press the SELECT button.

Each of the keys operates as follow.

- Reset** It recalls the setting data previously set.
- Stored** It stores the setting data in the memory.
- Quit** It closes the PICTURE POSITION Menu.

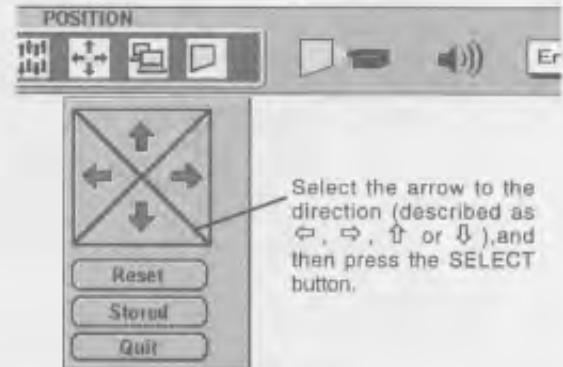

PICTURE SCREEN ADJUSTMENT

This projector has a picture screen resize function, which enables you to display the image in desirable size.

- 1 Press the MENU button and the ON-SCREEN MENU will appear. Press the POINT LEFT/RIGHT buttons to select SCREEN  and press the SELECT button. Another dialog box PICTURE SCREEN Menu will appear.
- 2 To adjust the image size or pan the image, move the arrow to Digital zoom by pressing POINT UP/DOWN buttons and then press SELECT button. The ON-SCREEN menu and SCREEN ADJUST menu will disappear. The magnifying-glass icon and the message "D. Zoom" is displayed to indicate Digital Zoom mode.
- 3 To cancel Digital Zoom mode, press the other buttons except SELECT / FRONT CLICK / POINT / LASER / CURSOR buttons. To adjust the image to the screen size (1024 x 768), press NORMAL button.
- 4 To turn the image into its original size select True in the dialog box. When the original image size is larger than the screen size (1024 x 768), this projector becomes Digital Zoom mode automatically.

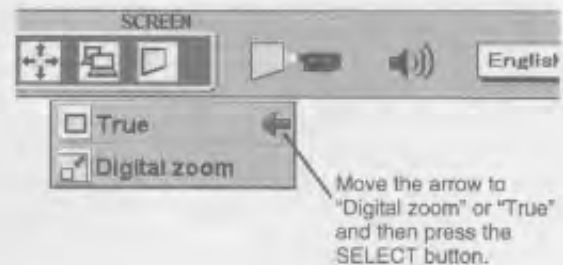

Expand function

To expand the image size, press SELECT button. The image is magnified by degrees. The maximum size of the projected image in expand mode is 4 times as large as the screen size (1024 x 768).

Compress function

To compress the image size, press FRONT CLICK button. The size of image is reduced by degrees. The minimum size of the projected image in compress mode is 640 x 480 in VGA, 800 x 600 in SVGA, or 1024 x 768 in XGA / SXGA.

Panning function

To pan the image, press POINT UP/DOWN/LEFT/RIGHT buttons. Panning function can work only when the image is larger than the screen size.

- This projector cannot display in the resolution more than 1280 X 1024. If your computer's screen resolution is higher than 1280 X 1024, reset the resolution to the lower before connecting the projector.
- The image data in other than XGA (1024 x 768) is modified to fit the screen size in the initial mode.
- The normal "Panning Operation" may not function properly if the computer system prepared with the "PC Adjust" is used.

SELECTING VIDEO MODE

Direct Operation

Press the MODE button on the Top Control or the VIDEO button on the Remote Control Units. Select the Mode among COMPUTER, VIDEO, or MCI mode.

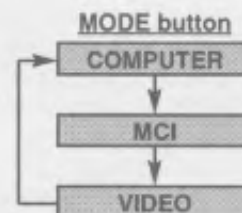

Menu Operation

Press the MENU button and the ON-SCREEN MENU will appear. Press the POINT LEFT/RIGHT buttons to select Video  and press the SELECT button.



SELECTING COLOR SYSTEM

- 1 Press the MENU button and the ON-SCREEN MENU will appear. Press the POINT LEFT/RIGHT buttons to select SYSTEM and press the SELECT button. Another dialog box VIDEO SYSTEM Menu will appear. (The display also appears by pressing the SYSTEM button on the Top Control or the Remote Control Units.)
- 2 Press the POINT DOWN button and a red-arrow icon will appear. Move the arrow to "Auto", and then press the SELECT button.

Auto

The projector automatically detects the incoming Video system, and adjusts itself to optimize its performance. When the Video System is PAL-M select the system manually.

PAL / SECAM / NTSC / NTSC4.43 / PAL-M

If the projector cannot reproduce the proper video image, it is required to select a specific broadcast signal format among PAL, SECAM, NTSC, NTSC 4.43, or PAL-M.

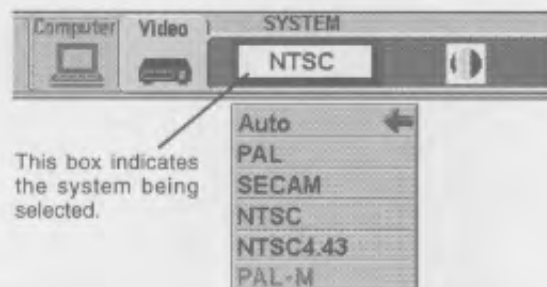

PICTURE IMAGE ADJUSTMENT

Adjusting the Picture Image

- 1 Press the MENU button and the ON-SCREEN MENU will appear. Press the POINT LEFT/RIGHT buttons to select IMAGE  and press the SELECT button. Another dialog box PICTURE IMAGE ADJUSTMENT Menu will appear.
- 2 Press the POINT DOWN button and a red-arrow icon will appear. Move the arrow to ▲ or ▼ of the item that you want to change by pressing the POINT UP/DOWN buttons. To increase the value, point the arrow to ▲ and then press the SELECT button. To decrease the value point the arrow to ▼ and then press the SELECT button.

- Colour** Point to ▼ to adjust the image lighter, and select ▲ to adjust the image deeper. (From 0 to 63.)
- Tint** Point to ▼ to adjust the colour more purple, and select ▲ to adjust more green. (From 0 to 63.)
- Contrast** Point to ▼ to adjust the image lighter, and select ▲ to adjust the image deeper. (From 0 to 63.)
- Brightness** Point to ▼ to adjust the image darker, and select ▲ to adjust the image brighter. (From 0 to 63.)
- sharpness** Point to ▼ to adjust the image softer, and select ▲ to adjust the image sharper. (From 0 to 63.)

Each of the keys operates as follow.

- Reset** It recalls the data previously adjusted.
- Stored** It stores the data in the memory.
- Quit** It closes the PICTURE IMAGE ADJUSTMENT Menu.

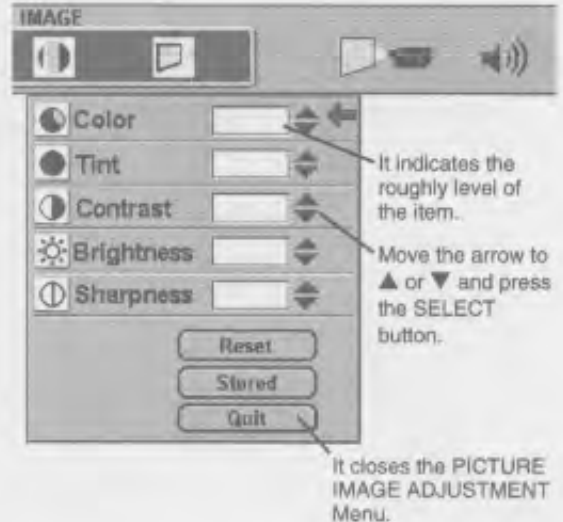

Normal Function

The normal picture level is preset on this projector by the factory and can be restored anytime by pressing the NORMAL button (located on the Top Control or on the Remote Control). The "Normal" display will be displayed on the screen for a few seconds.

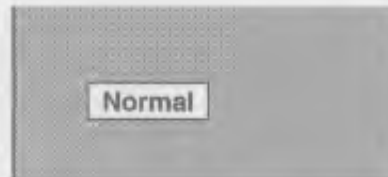

PICTURE SCREEN ADJUSTMENT

This projector has a picture screen resize function, which enables you to display the image in desirable size.

- 1 Press the MENU button and the ON-SCREEN MENU will appear. Press the POINT LEFT/RIGHT buttons to select SCREEN  and press the SELECT button. Another dialog box PICTURE SCREEN ADJUSTMENT DISPLAY will appear.
- 2 Press the POINT DOWN button and a red-arrow icon will appear. Move the arrow to the screen size that you want to set, and then press the SELECT button.

- Regular** Normal Video Image size with 4 x 3 aspect ratio.
- Wide** It compresses the image vertically to Wider Video Image size with 16 x 9 aspect ratio.

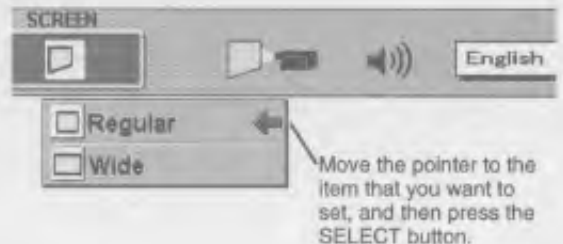

OPERATING THE PC CARD SLOT

This projector has PC CARD SLOT on its side. Pictures in a memory card (SmartMedia with PC Card Adapter or PC card) can be displayed just by inserting the card into PC CARD SLOT. It is unnecessary to connect with other input equipment. Media Card Imager (supplied with CD-ROM) can edit the image data and record it into a memory card for projecting with the projector.

PC with Windows 95

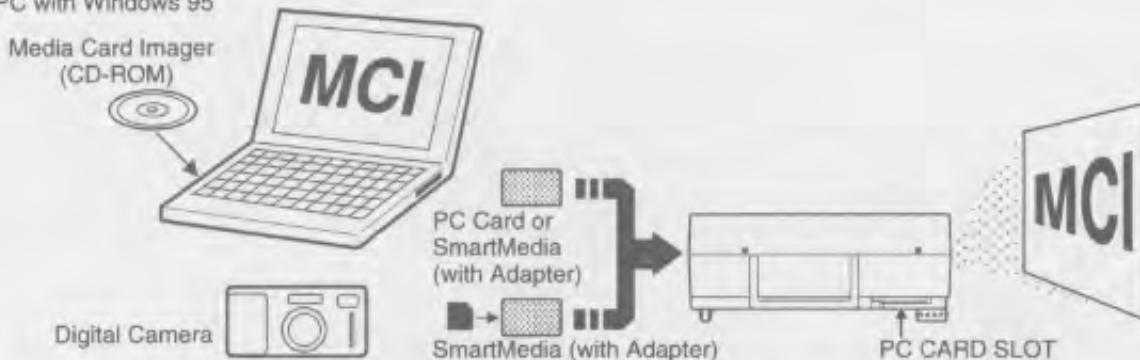

Available Data

This projector can project the image data as follow through PC CARD SLOT.

- The data edited by "Media Card Imager."
- The data of the resolution between VGA (640 X 480) and SXGA (1280 X 1024) in Bit Map type (BMP) or JPEG type (JPG), such as Digital Camera data, can be also displayed.

(Some image data in SXGA size may not be displayed properly. In that case, reset the resolution to the lower.)

Refer to "SHOW THE DATA IN THE MEMORY CARD" on page 34 to display the image data.

Available Card

SmartMedia (with PC Card Adapter) or Type II PCMCIA-ATA Card can be used with this projector. (Those memory cards are supplied with this projector.)

Refer to SMARTMEDIA AND PC CARD ADAPTER on pages 38 and 39 for operation.

NOTE : Some PCMCIA Adapter or PC Card is not available for this projector and cannot provide the image data. In that case, use our SmartMedia and PC Card Adapter.

How to Load a PC Card Into the Projector

LOAD

Insert PC Card Adapter (with SmartMedia) or PC card into PC CARD SLOT. Make sure EJECT button pops out.

NOTE : Do not insert the card in the reverse. The card can be damaged.

UNLOAD

Press EJECT button, and the memory card pops out.

NOTE : Do not take the card out while the PC CARD SLOT loading. Data and the card can be damaged.

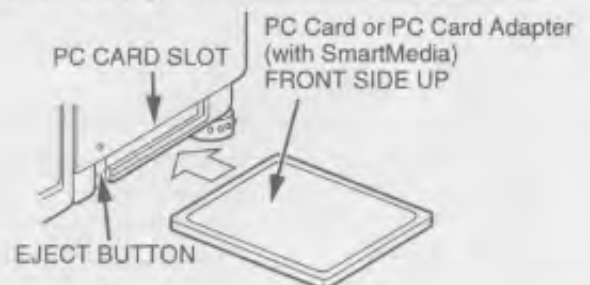

Media Card Imager

Media Card Imager (CD-ROM) is attached to this projector to edit the image data for projecting. Installation of Media Card Imager is recommended. Refer to Owner's Manual of Media Card Imager for installation and operation.



PC CARD INDICATOR
DO NOT REMOVE THE MEMORY CARD WHILE THIS INDICATOR IS LIT. THE DATA IN THE MEMORY CARD CAN BE DAMAGED.

SHOW THE DATA IN THE MEMORY CARD

Display Data on Screen

- 1 When the memory card is inserted into PC CARD SLOT, mode is automatically set to MCI mode and the first Page of the latest Index is projected on the screen. (To turn Video/Computer mode to MCI mode manually, press the MODE button on the Top Control or the COMPUTER / MCI button on the Remote Control, or select MCI mode in the ON-SCREEN MENU referring the page 25.)
 - 2 To change the page, press PAGE (^) or (v) buttons. And to select described Index or Page in the table, follow the instructions of INDEX SELECTION and PAGE SELECTION.
- This projector can project only the image data edited with Media Card Imager or the data in Bit Map type or in JPEG type through PC CARD SLOT. Other data is not available and should be edited and written in a memory card with Media Card Imager before loading PC CARD SLOT.
(The data in Bit Map type or in JPEG type, such as the data captured with a digital camera, can be projected directly through PC CARD SLOT.)
 - If there are the data edited with Media Card Imager and other data (such as in Bit Map type or JPEG type) together in a memory card, the data edited by Media Card Imager has a priority to be projected with the LCD projector. The other image data in Bit Map type or JPEG type are not projected. In that case, edit those data and record in the memory card with Media Card Imager.

Index and Page

The data edited with Media Card Imager is a Index consisting of several Pages. To project the Page, select the Index and then select the Page in the Index.

Index Selection

- 1 Press the MENU button and the ON-SCREEN MENU will appear. Press the POINT LEFT/RIGHT buttons to select VIEW and press the SELECT button. Another dialog box VIEW SETTING menu will appear.
- 2 Press the POINT DOWN button and a red-arrow icon will appear. Move the arrow to "Index", and then press the SELECT button. The table of Indexes in the memory card will appear.
- 3 Press POINT UP/DOWN/LEFT/RIGHT buttons to move to the Index that you want to project and press SELECT button. The first Page of the Index selected is displayed. Press SELECT button again to display the table of Pages.

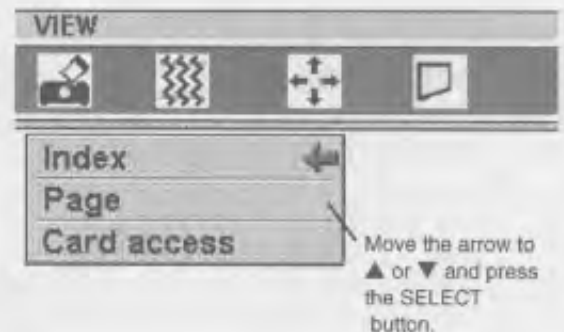

Page Selection

- 1 Press the MENU button and the ON-SCREEN MENU will appear. Press the POINT LEFT/RIGHT buttons to select VIEW and press the SELECT button. Another dialog box VIEW SETTING menu will appear.
- 2 Press the POINT DOWN button and a red-arrow icon will appear. Move the arrow to "Page", and then press the SELECT button. The table of pages of the index card will appear.
- 3 Press POINT UP/DOWN/LEFT/RIGHT buttons to move to the Page that you want to project and press SELECT button. The page selected is displayed on the screen. The table of Pages can be displayed by pressing SELECT button when the page is displayed on full screen.

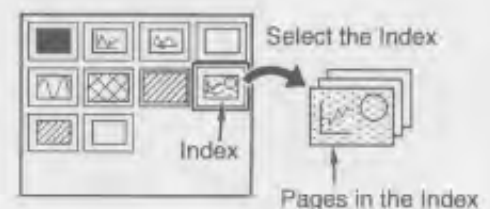

PICTURE IMAGE ADJUSTMENT

Adjust Picture Image Manually

- 1 Press the MENU button and the ON-SCREEN MENU will appear. Press the POINT LEFT/RIGHT buttons to select IMAGE  and press the SELECT button. Another dialog box PICTURE IMAGE ADJUSTMENT Menu will appear.
- 2 Press the POINT DOWN button and a red-arrow icon will appear. Move the arrow to ▲ or ▼ of the item that you want to change by pressing the POINT UP/DOWN buttons. To increase the value, point the arrow to ▲ and then press the SELECT button. To decrease the value point the arrow to ▼ and then press the SELECT button.

Fine sync

Adjust the picture as necessary to eliminate flicker from the display. (From 0 to 127.) This item can be adjusted by pressing the FINE SYNC. button on the Top Control or the Remote Control Units.

Total dots

The number of the total dots in one horizontal period. Adjust the number to match your PC image.

White Balance (Red / Green / Blue)

Point to ▼ to adjust the color of image lighter, and select ▲ to adjust the image deeper. (From 0 to 63.)

Contrast

Point to ▼ to adjust the image lighter, and select ▲ to adjust the image deeper. (From 0 to 63.)

Brightness

Point to ▼ to adjust the image darker, and select ▲ to adjust the image brighter. (From 0 to 63.)

Each of the keys operates as follow.

Reset It recalls the data previously adjusted.

Stored It stores the adjusted data in the memory.

Quit It closes the PICTURE IMAGE ADJUSTMENT Menu.

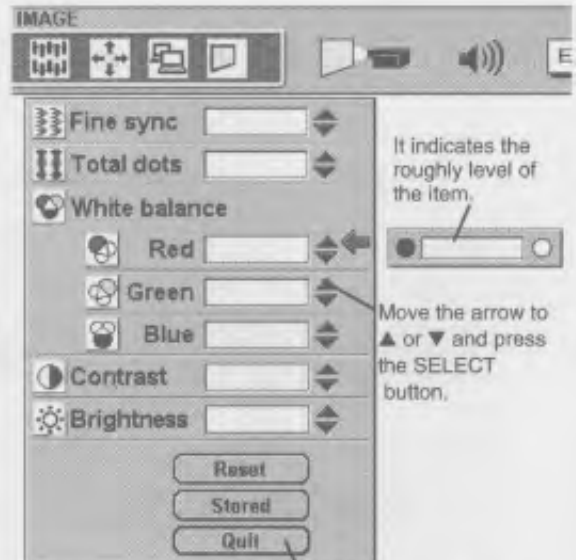

Normal Function

The normal picture level is preset on this projector by the factory and can be restored anytime by pressing the NORMAL button (located on the Top Control or on the Remote Control Units). The "Normal" display will be displayed on the screen for a few seconds.

Normal

PICTURE POSITION ADJUSTMENT

The position of the image can be adjusted vertically and horizontally through PICTURE POSITION ADJUSTMENT.

- 1 Press the MENU button and the ON-SCREEN MENU will appear. Press the POINT LEFT/RIGHT buttons to select POSITION  and press the SELECT button. Another dialog box PICTURE POSITION Menu will appear.
- 2 Select the arrow to the direction (described as ←, →, ↑ or ↓) that you want to adjust by pressing the POINT UP/DOWN buttons, and then press the SELECT button.

Each of the keys operates as follow.

- Reset** It recalls the setting data previously set.
- Stored** It stores the setting data in the memory.
- Quit** It terminates the PICTURE POSITION Menu.

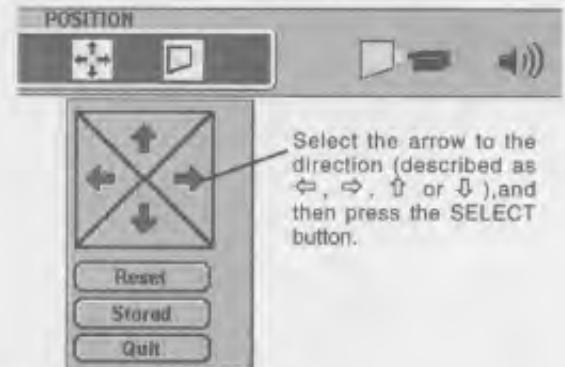

PICTURE SCREEN ADJUSTMENT

This projector has a picture screen resize function, which enables you to display the image in desirable size.

- 1 Press the MENU button and the ON-SCREEN MENU will appear. Press the POINT LEFT/RIGHT buttons to select SCREEN  and press the SELECT button. Another dialog box PICTURE SCREEN Menu will appear.
- 2 To adjust the image size or pan the image, move the arrow to Digital zoom by pressing POINT UP/DOWN buttons and then press SELECT button. The ON-SCREEN menu and SCREEN ADJUST menu will disappear. The magnifying-glass icon and the message "D. Zoom" is displayed to indicate Digital Zoom mode.
- 3 To cancel Digital Zoom mode, press the other buttons except SELECT / FRONT CLICK / POINT / LASER / CURSOR buttons. To adjust the image to the screen size (1024 x 768), press NORMAL button.
- 4 To turn the image into the screen size, select True in the dialog box.

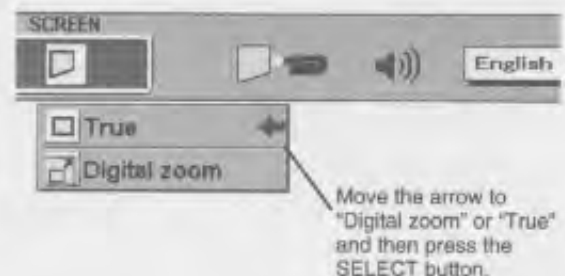

Expand function

To expand the image size, press SELECT button. The image is magnified by degrees. The maximum size of the projected image in expand mode is 4 times as large as the screen size (1024 x 768).

Compress function

To compress the image size, press FRONT CLICK button. The size of image is reduced by degrees. The minimum size of the projected image in compress mode is 640 x 480 in VGA, 800 x 600 in SVGA, or 1024 x 768 in XGA / SXGA.

Panning function

To pan the image, press POINT UP/DOWN/LEFT/RIGHT buttons. Panning function can work only when the image is larger than the screen size.

- This projector cannot display in the resolution more than 1280 X 1024. If your computer's screen resolution is higher than 1280 X 1024, reset the resolution to the lower before connecting the projector.
- The image data in other than XGA (1024 x 768) is modified to fit the screen size in the initial mode.

WRITE DATA INTO MEMORY CARD

The data edited by Media Card Imager in the computer can be written in or read from the memory card with the PC or this projector.

The data edited by Media Card Imager is written in Bit Map type (BMP) or JPEG type (JPG).

Access to the Card with the Projector

If your computer doesn't have the PC card write equipment, the data can be written or read by connecting with this projector.

NOTE : This operation can be made only by Media Card Imager in PC.

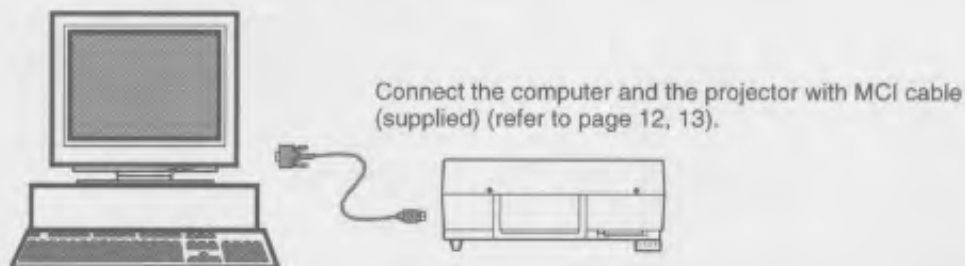

- 1 Connect the projector with your computer by the MCI cable (supplied). (Refer to "CONNECTING COMPUTER" on Page 12.) Insert the memory card into PC CARD SLOT of the projector. And then, turn on the projector and the computer.
- 2 Press the MENU button and the ON-SCREEN MENU will appear. Press the POINT LEFT/RIGHT buttons to select View and press the SELECT button. Another dialog box VIEW SETTING Menu will appear.
- 3 Press POINT DOWN button and a red arrow appear. Move the arrow to Card access by pressing POINT UP/DOWN button. And then press SELECT button. "Ready to access" is displayed. Operate Media Card Imager of PC to write/read the data in the PC card. (Refer to Owner's Manual of Media Card Imager for operation.)

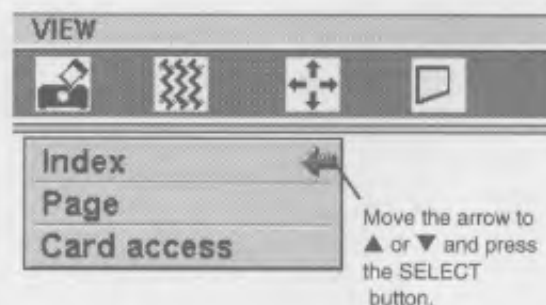

NOTE : Connect the projector to the computer with MCI Cable before turning those appliances on.
Do not press any button while read/write the data through MCI Cable. Those operations are canceled and the data in the memory card may be damaged.

SMARTMEDIA AND PC CARD ADAPTER

SmartMedia and PC Card Adapter are provided with this LCD projector. SmartMedia can be used as a PC card conforming to the PC Card Standard-ATA by combining with PC Card Adapter.

Install / Remove the SmartMedia

INSTALL

Insert SmartMedia fully into PC Card Adapter. Make sure EJECT button pops out.

NOTE

- The front side of SmartMedia has Contact Area on its surface. The front side of PC Card Adapter has Eject button on the left side of the slot.
- Do not insert SmartMedia in the reverse. The card and the data can be damaged.

REMOVE

To remove SmartMedia, fully press in the EJECT button. The card pops out, then take out the card.

NOTE

- Do not pull SmartMedia by force. It may damage SmartMedia or PC Card Adapter.

PC Card Adapter
(supplied)

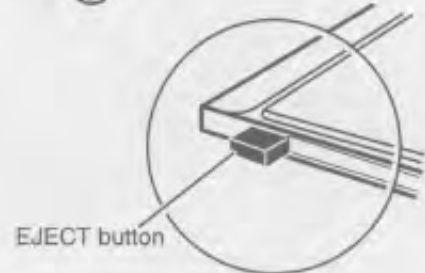
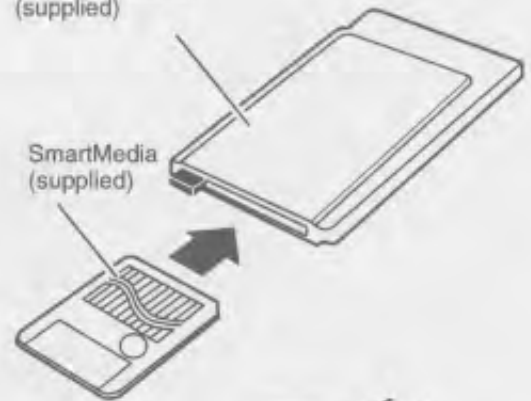

① Contact Area

Data is written in Contact Area. Never scratch or stain this area.

② Write Protect Area

Affix Write Protect Sticker onto Write Protect Area to prevent from accidental erasure.

③ Index Area

Affix Index Label onto Index Area.

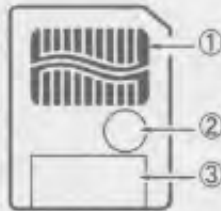

CAUTION

Write Protect Sticker is not available for PC. When PC attempts to read the data from SmartMedia with Write Protect Sticker, it provides the error messages or the control of PC becomes insecure because of the property of the interface. When the error messages are displayed, press any key to return to the normal display. It is recommended, however, SmartMedia should be used on PC without Write Protect Sticker.

IMPORTANT NOTE

THE DATA STORED ON THE MEMORY CARD (SMARTMEDIA OR PC CARD) MAY BE DAMAGED OR LOST BECAUSE OF THE DAMAGE OF THE MEMORY CARD OR THE ACCIDENTAL ERASURE. IT IS RECOMMENDED THAT ANY IMPORTANT DATA SHOULD BE COPIED ONTO SEPARATE MEDIA, SUCH AS A FLOPPY DISK, A HARD DISK, OR A MO DISK. WE SHALL NOT BE LIABLE FOR ANY DAMAGE OR LOSS OF PROFITS ARISING FROM THE LOSS OF DATA BECAUSE OF THE ACCIDENTAL OPERATION AND THE DAMAGE OF A MEMORY CARD OR APPLIANCES. REFER TO OWNER'S MANUAL OF MEDIA CARD IMAGER FOR OPERATING THE SOFTWARE.

Precautions and Specifications of the appliance.

SmartMedia

- SmartMedia is a precision device. Do not bend it, drop it, subject it to strong forces or shocks or place where strong static electrical charge can be generated.
- Do not touch the surface of the Contact Area with fingers or allow it to be stained with foreign materials. Store SmartMedia inside its protective case when it is not used.
- SmartMedia is a consumable item. The data may not be written in or read from SmartMedia by using for a long time. In that case, replace SmartMedia with new one.

Memory capacity : 8MB

Operating voltage : 3.3 V DC

Usage environment

Temperature : 0~55 °C (during use)
-20~65 °C (during storage)

Humidity : less than 95%
(during use, during storage)

PC Card Adapter

- Do not bend it, drop it, subject it to strong forces or shocks or place where strong static electrical charge can be generated.
- Do not insert materials other than SmartMedia. The adapter may be damaged. Store PC Card Adapter inside its protective case when it is not used.
- Do not shake the adapter, turn off the appliances, or remove SmartMedia from the PC Card Adapter during writing or reading data. It may damage the data in SmartMedia.

Operating voltage : 5 V DC

Usage environment

Temperature : 0~55 °C (during use)
-20~65 °C (during storage)

Humidity : less than 95%
(during use, during storage)

This adapter can be adapted to only our SmartMedia indicated below.

Available SmartMedia

: 3.3V / 5V, 2MB / 4MB / 8MB / 16MB

SETTING MENU

- 1 Press the MENU button and the ON-SCREEN MENU will appear. Press the POINT LEFT/RIGHT buttons to select SETTING  and press the SELECT button. Another dialog box SETTING Menu will appear.
- 2 Press the POINT DOWN button and a red-arrow icon will appear. Move the arrow to the item that you want to set, and then press the SELECT button to set it "On" or "Off".

Blue back When this function is in the "On" position, this projector will produce a blue image without video noise on the screen when the video source is unplugged or turned off.

Display When this function is in the "On" position, the On-Screen Displays always appear when adjustments are made. (The following displays disappear by switching this function "Off.")

- Preparation Display
(The Number-counting down Display)
- Mode Display
- Volume Display
- Mute Display
- Normal Display

Ceiling When this function is in the "On" position, the top / bottom and the left / right reversed picture is provided to project the image from a ceiling mounted projector.

Rear When this function is in the "On" position, the left / right reversed picture is provided to project the image to a rear projection screen.

Split wipe Turn this function "On" position in the SETTING menu. The picture will change into next one by sliding black image side ways like drawing the black curtains when the input source is turned into another one.

Lamp age The Lamp age function is designed to reset the lamp replacement monitor timer. When replacing the lamp, reset the lamp replacement monitor timer by using this function. (Refer to page 43.)



Set the Pointer to the item, and then press the SELECT button.



SETTING LANGUAGE

The language used in the ON-SCREEN MENU is selectable from among English, German, French, Italian, Spanish and Japanese.

- 1 Press the MENU button and the ON-SCREEN MENU will appear. Press POINT LEFT/RIGHT buttons to select LANGUAGE  and press the SELECT button. Another dialog box LANGUAGE Menu will appear.
- 2 Press the POINT DOWN button and a red-arrow icon will appear. Move the arrow to the language that you want to set, and then press the SELECT button.



Move the Pointer to the language that you want to set, and then press the SELECT button.

OPERATING WIRELESS MOUSE

The Wireless Remote Control Unit is not only able to operate the projector but also usable as a wireless mouse for a PC. POINT buttons and two CLICK buttons are used for wireless mouse operation. Wireless mouse is usable when PC mouse pointer is displayed on the screen. When the menu or indicator of the projector is displayed on the screen instead of the PC mouse pointer, the wireless mouse cannot be used.

Installation

To use the Wireless Remote Control Unit as the Wireless Mouse for a PC, installation of the mouse driver (not supplied) is required. Make sure that the mouse driver is properly installed in your computer. And make sure that the mouse port of the computer connected to Control Port is activated.

- 1 Connect the mouse port of your computer to the Control Port of the projector with the Mouse Cable. (Refer to page 14 and 15 for connection.)
- 2 Turn the projector on first, and then turn on your computer. When the computer is switched on first, the Wireless Mouse may not work properly.

Note : When the computer has no mouse port, connect the Serial Port of the computer to Control Port of the projector with the Mouse Cable for Serial Port.

Controlling Wireless Mouse

When controlling the pointer of the computer, operate the Wireless Mouse with POINT button, SELECT button, and FRONT CLICK button on the Wireless Remote Control Unit.

POINT button

Used to move the pointer. The pointer is moved according to the direction you are pressing.

SELECT (REAR CLICK) button

This button has the same function as the left button in a PC mouse.

FRONT CLICK

This button has the same function as the right button in a PC mouse. Pressing this button dose not affect any operation when in Menu mode.

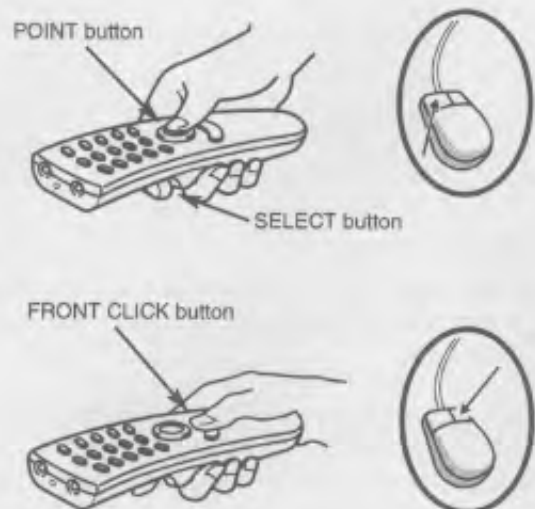

MAINTENANCE

TEMPERATURE WARNING INDICATOR

The TEMPERATURE WARNING Indicator flashes red when the internal temperature of the projector exceeds the normal temperature. The Indicator stops to flash when the temperature of the projector become normal.

When the TEMPERATURE WARNING Indicator continues to flash, make sure the matters below.

- 1 The Ventilation slots of the projector are blocked. In such an event, reposition the appliance so that the ventilation slots are not obstructed.
- 2 Air filter is clogged with dust particles. Remove dust from the air filter by following instruction in the AIR FILTER CARE AND CLEANING section below.
- 3 If the TEMPERATURE WARNING Indicator remains on after performing the above checks, the Cooling Fans or the Internal Circuits may be malfunctioning. Request service from an authorized dealer or service station.

AIR FILTER CARE AND CLEANING

The Removable Air Filters prevent dust from accumulating on the surface of the Projection Lens and the Projection Mirror. Should the Air Filters become clogged with dust particles, they will reduce the Cooling Fans' effectiveness and may result in internal heat build up and effect on the life of the projector.

To clean the Air Filters, follow the cleaning procedures below:

- 1 Turn the power off, and disconnect the AC power cord from the AC outlet.
- 2 Remove the air filter cover. Press the cover latch sideways and lift the cover.
- 3 Remove the air filter from the filter cover.
- 4 Clean the air filter with a vacuum cleaner.
- 5 Replace the air filter. Make sure that air filter cover is fully inserted.



CAUTION

Do not operate the projector with the Air Filter removed. The dust is stuck on the LCD Panel and the Mirror, and it may spoil the fine picture image.

RECOMMENDATION

We recommend to avoid dusty/smoky place for operating the projector. Using in dusty place may cause the picture of poor quality.

When using under the dusty or smoky conditions, dust may accumulate on the liquid crystal panel and lens inside it, and may resultantly be projected on the liquid crystal panel and lens inside it, and may resultantly be projected on the screen together with the picture.

When the above symptoms are noticed contact your authorized dealer or service station for the cleaning.

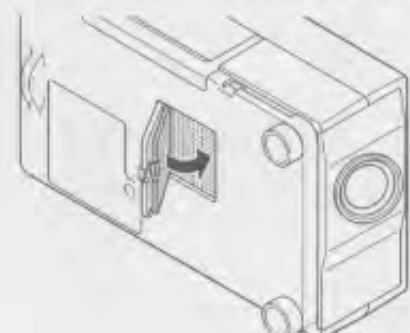
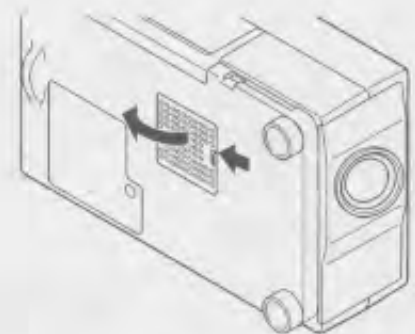

LAMP REPLACEMENT Indicator

When the Lamp of this projector draws to an end, the LAMP REPLACEMENT indicator lights yellow. When the image become dark or the color of the image become unnatural, replacement of the Lamp is required.

Lamp Replacement



CAUTION

- For continued safety, replace with a lamp assembly of the same type.
- Allow the projector to cool for at least 45 minutes before you open the lamp cover. The inside of the projector can become very hot.
- Do not drop the lamp assembly or touch the glass bulb! The glass can shatter and may cause injury.

Follow these steps to replace the lamp assembly.

- 1 Turn off the projector and disconnect the AC plug. Allow the projector to cool for at least 45 minutes.
- 2 Remove a screw with a screwdriver and remove the lamp cover.
- 3 Remove 2 screws with a screwdriver and pull out the lamp assembly by grasping the handle.
- 4 Replace the lamp assembly.
- 5 Replace the Lamp Assembly and tighten 2 screws. Make sure that the Lamp Assembly is set properly. And replace the Lamp Cover and tighten a screw.
- 6 Connect the AC Power Cord to the projector and turn the projector on.
- 7 Reset the Lamp Replacement Monitor Timer (refer to the section "Lamp Replacement Monitor Timer" below.)

NOTE: Do not reset the LAMP REPLACEMENT MONITOR TIMER, when the lamp is not replaced.

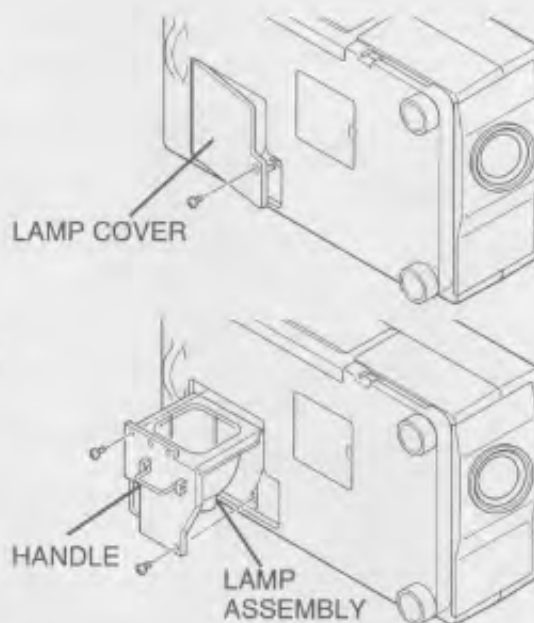

Lamp Replacement Monitor Timer

Be sure to reset the Lamp Replacement Monitor Timer when the Lamp Assembly is replaced. When the Lamp Replacement Monitor Timer is reset, the LAMP REPLACEMENT indicator stops to lighting.

- 1 Turn the projector on, and press the MENU button and the ON-SCREEN MENU will appear. Press the POINT LEFT/RIGHT buttons to select SETTING  and press the SELECT button (refer to the page 40). Another dialog box SETTING MENU Menu will appear.
- 2 Press the POINT DOWN button and a red-arrow icon will appear. Move the arrow to Lamp age, and then press the SELECT button. The message of "Lamp replace monitor Reset?" is displayed.
- 3 Select [Yes] to reset the Timer.

Do not reset the Lamp Replacement Monitor Timer, except after the lamp is replaced.

Cleaning the Projection Lens

Follow these steps to clean the projection lens:

- 1 Apply a non-abrasive camera lens cleaner to a soft, dry cleaning cloth. Avoid using an excessive amount of cleaner. Abrasive cleaners, solvents or other harsh chemicals might scratch the lens.
- 2 Lightly wipe the cleaning cloth over the lens.
- 3 When you don't use the projector, replace the lens cover.

TROUBLESHOOTING

Before calling your dealer or service station for assistance, check the matters below once again.

1. Make sure you have connected the projector to your equipment as described in section "CONNECTING THE PROJECTOR" on pages 10 ~ 15.
2. Check cable connection. Verify that all computer, video and power cord are properly connected.
3. Verify that all power is switched on.
4. If the projector still does not produce the image, re-start the computer.
5. If the image still does not appear, unplug the projector from the computer and check the computer monitor's display. The problem may be with your graphics controller rather than with the projector. (When you reconnect the projector, remember to turn the computer and monitor off before you power up the projector. Power the equipment back in order of : Projector and computer.)
6. If the problem still exists, check with following chart.

Problem:	Try these Solution
No power.	<ul style="list-style-type: none"> ● Plug the projector into the AC outlet. ● Be sure READY Indicator light is On. ● Wait one minute after the projector is turned OFF before turning the projector back on. <p>NOTE : After pressing the power ON-OFF switch to OFF, make sure the projector works as follow.</p> <ol style="list-style-type: none"> 1. The LAMP indicator will light and the READY indicator will turn off. 2. after one minute, the READY indicator will light green again and the projector may be turned on by pressing the power ON-OFF button. <ul style="list-style-type: none"> ● Check the TEMPERATURE WARNING indicator. If the indicator flashes red, the projector cannot be turned on. (See "TURNING ON/OFF THE PROJECTOR" section on page 22.) ● Check the Projection Lamp. (Refer to the page 43.)
Image is out of focus.	<ul style="list-style-type: none"> ● Adjust the focus ● Make sure the projection screen is at least 4.6' (1.4m) from the projector. ● Check the projection lens to see if it needs cleaning. <p>NOTE : Moving the projector from a cool temperature location to a warm temperature location may result in moisture condensation on the lens. In such an event, leave the projector OFF and wait until condensation disappears.</p>
Picture is L/R reversed.	<ul style="list-style-type: none"> ● Check Ceiling / Rear feature. (See "SETTING" section on page 40.)
Picture is T/B reversed.	<ul style="list-style-type: none"> ● Check Ceiling feature. (See "SETTING" section on page 40.)
Some displays are not seen during the Operation.	<ul style="list-style-type: none"> ● Check Display feature.(See "SETTING" section on page 40.)
No image.	<ul style="list-style-type: none"> ● Check the connection between the computer or video equipment and the projector. ● When turning the projector on, it is about 30 seconds to display the image. ● Check the system that you select is corresponding with the computer or the video equipment. ● Make sure the temperature is not out of the Operating Temperature (5° - 35°).
No sound.	<ul style="list-style-type: none"> ● Check audio cable connection from audio input source. ● Adjust the audio source. ● Press VOLUME (+) button. ● Press MUTE button.

Problem:	Try these Solution
Remote Control Units dose not work.	<ul style="list-style-type: none"> ● Check the batteries. ● Make sure anything is blocking between the Remote Receiver and the Remote Control Units. ● Make sure you are not too far from the projector when using the Remote Control Units. Maximum operating range is 16.4 feet (5m).
Wireless Mouse function does not work.	<ul style="list-style-type: none"> ● Check the cable connection between the projector and the computer. ● Check the mouse setting on your computer. ● Turn the projector before your turn on the computer.
The image data in memory card isn't displayed.	<ul style="list-style-type: none"> ● Check the memory card is inserted properly into PC CARD SLOT. ● Check SmartMedia or PC Card Adapter is set properly. ● Check MCI mode is selected. ● Check the image data is recorded in the memory card properly. ● Start the projector again.
The image data can't be written in, read from the memory card.	<ul style="list-style-type: none"> ● Check the projector is turned on. ● Check "Card access" in VIEW menu is selected. ● Check MCI Cable is connected properly. ● Check the memory card is inserted properly into PC CARD SLOT. ● Check Media Card Imager (supplied) is installed in your computer properly. ● Check the setting in Media Card Imager (like Serial Port Setting) is set properly.

WARNING :

High voltages are used to operate this projector. Do not attempt to open the cabinet.

TECHNICAL SPECIFICATIONS

Projector Type	Multi-media Projector
Dimensions (W x H x D)	8.46" x 4.88" x 12.85" (215mm x 124mm x 326.5mm)
Net Weight	9.48 lbs (4.3 kg)
LCD Panel System	0.9" TFT Active Matrix type, 3 panels
Panel Resolution	1,024 x 768 dots
Number of Pixels	2,359,296 (1,024 x 768 x 3 panels)
Color System	PAL, SECAM, NTSC, NTSC4.43 and PAL-M
Scanning Frequency	H-sync. 15 ~ 100 KHz, V-sync. 50 ~ 100 Hz
Projection Image size (Diagonal)	Adjustable from 30" to 300"
Contrast Ratio	250 : 1
Horizontal Resolution	800 TV lines
Projection Lens	F 1.7 ~ 2.0 lens with f 33.2mm ~ 43.1mm Motor zoom and focus
Throw Distance	1.4m ~ 10.8m
Projection Lamp	120 W
Projection Mirror	Diachronic Mirror and X - prism system
AV Input Jacks	RCA Type x 1 (Video, Audio R and L) and DIN 4 pin (S-Video) x 1
Computer Input Jacks	(VGA) HDB 15 Terminal x 1
Control Port Jack	Multi-pole 12 pin (Control Port) x 1
MCI Serial Port	Serial Port DIN 8 pin
Monitor Output Jack	(VGA) HDB 15 Terminal x 1
Computer Audio Input Jack	Mini Jack (stereo)
Audio Output Jack	Mini Jack (stereo)
Internal Audio Amp	1W RMS (Monaural)
Built-in Speaker	1 speaker, 1.57" x 1.18" (40mm x 30mm)
Feet Adjustment	0" to 2"
Voltage	AC 100 ~ 120 V, 50 / 60 Hz
Power Consumption	2.2 A (Max. Ampere)
Operating Temperature	41 °F ~ 95 °F (5 °C ~ 35 °C)
Storage Temperature	14 °F ~ 140 °F (-10 °C ~ 60 °C)
Remote Control Transmitter	Power Source : AA Type x 2 Operating Range : 16.4' (5m) / ±30' Dimensions : 2.2" x 1.4" x 7.6" (56mm x 35mm x 193mm) Net Weight : 0.23 lbs (105 g) (including batteries) Laser Pointer : Class II Laser (Max. Output : 1mW / Wave length : 660±20nm)
Accessories	Owner's Manual AC Power Cord Remote Control Transmitter and Batteries VGA Cable VGA / MAC Adapter Mouse Cable (for PS/2 port x 1, for Serial port x 1, and for ADB port x 1) MCI Cable (RS-232C) Media Card Imager for Windows 95 (CD-ROM) and Owner's Manual for this software SmartMedia and PC Card Adapter Lens Cover Carrying Bag

● The specifications are subject to change without notice.



This symbol on the nameplate means the product is Listed by Underwriters Laboratories Inc. It is designed and manufactured to meet rigid U.L. safety standards against risk of fire, casualty and electrical hazards.

EIKI

Audio Visual/Video Products

EIKI INTERNATIONAL, INC.

26794 Vista Terrace Drive, Lake Forest,
CA. 92630-8113, U.S.A.

TEL (949) 457-0200 FAX (949) 457-7878

IN CANADA, EIKI CANADA

865 Heritage Drive P.O. Box 156
Midland Ontario L4R 4K8 Canada

TEL (705) 527-4084 FAX (705) 527-4087

Printed in Japan

Part No. 610 278 8181 (1AA6P1P1819-- M6WB)

© 1999 Eiki International, Inc.

Free Manuals Download Website

<http://myh66.com>

<http://usermanuals.us>

<http://www.somanuals.com>

<http://www.4manuals.cc>

<http://www.manual-lib.com>

<http://www.404manual.com>

<http://www.luxmanual.com>

<http://aubethermostatmanual.com>

Golf course search by state

<http://golfingnear.com>

Email search by domain

<http://emailbydomain.com>

Auto manuals search

<http://auto.somanuals.com>

TV manuals search

<http://tv.somanuals.com>