

# Instructions for Use

## ■ User's Manual

# RadiForce® RS110

Color LCD Monitor

English

Deutsch

Français

中文

日本語

## Important

Please read this User's Manual carefully to familiarize yourself with safe and effective usage. Please retain this manual for future reference.

## Wichtig

Lesen Sie die dieses Benutzerhandbuch aufmerksam durch, um sich mit der sicheren und effizienten Bedienung vertraut zu machen. Bewahren Sie dieses Handbuch zum späteren Nachschlagen auf.

## Important

Veuillez lire attentivement ce Manuel d'utilisation afin de vous familiariser avec ce produit et de l'utiliser efficacement et en toute securite. Veuillez conserver ce manuel pour reference ulterieure.

## 重要

请仔细阅读用户手册，掌握如何安全、有效地使用本产品。  
请保留本手册，以备日后参考。

## 重要

ご使用前には必ずこの取扱説明書をよくお読みにになり、正しくお使いください。  
この取扱説明書は大切に保管してください。



For U.S.A. , Canada, etc. (rated 100-120 Vac) Only

## FCC Declaration of Conformity

**We, the Responsible Party**

EIZO Inc.

5710 Warland Drive, Cypress, CA 90630

Phone: (562) 431-5011

**declare that the product**

Trade name: EIZO

Model: RadiForce RS110

**is in conformity with Part 15 of the FCC Rules. Operation of this product is subject to the following two conditions: (1) this device may not cause harmful interference, and (2) this device must accept any interference received, including interference that may cause undesired operation.**

This equipment has been tested and found to comply with the limits for a Class B digital device, pursuant to Part 15 of the FCC Rules. These limits are designed to provide reasonable protection against harmful interference in a residential installation. This equipment generates, uses, and can radiate radio frequency energy and, if not installed and used in accordance with the instructions, may cause harmful interference to radio communications. However, there is no guarantee that interference will not occur in a particular installation. If this equipment does cause harmful interference to radio or television reception, which can be determined by turning the equipment off and on, the user is encouraged to try to correct the interference by one or more of the following measures.

- \* Reorient or relocate the receiving antenna.
- \* Increase the separation between the equipment and receiver.
- \* Connect the equipment into an outlet on a circuit different from that to which the receiver is connected.
- \* Consult the dealer or an experienced radio/TV technician for help.

Changes or modifications not expressly approved by the party responsible for compliance could void the user's authority to operate the equipment.

### Note

Use the attached specified cable below or EIZO signal cable with this monitor so as to keep interference within the limits of a Class B digital device.

- AC Cord
- Shielded Signal Cable (Enclosed)

## Canadian Notice

This Class B digital apparatus complies with Canadian ICES-003.

Cet appareil numérique de le classe B est conforme à la norme NMB-003 du Canada.

# Instructions for Use

## ■ User's Manual





# RadiForce® RS110

Color LCD Monitor

It shall be assured that the final system is in compliance to IEC60601-1-1 requirements.

## SAFETY SYMBOLS

This manual uses the safety symbols below. They denote critical information. Please read them carefully.

	<p><b>WARNING</b></p> <p>Failure to abide by the information in a WARNING may result in serious injury and can be life threatening.</p>
	<p><b>CAUTION</b></p> <p>Failure to abide by the information in a CAUTION may result in moderate injury and/or property or product damage.</p>
	<p>Indicates a prohibited action.</p>
	<p>Indicates to ground for safety.</p>

- Power supplied equipment can emit electromagnetic waves, that could influence, limit or result in malfunction of the monitor. Install the equipment in a controlled environment, where such effects are avoided.
- This is a monitor intended for use in a medical image system. It does not support the display of mammography images for diagnosis.
- This product has been adjusted specifically for use in the region to which it was originally shipped. If operated outside this region, the product may not perform as stated in the specifications.

---

No part of this manual may be reproduced, stored in a retrieval system, or transmitted, in any form or by any means, electronic, mechanical, or otherwise, without the prior written permission of EIZO Corporation.

EIZO Corporation is under no obligation to hold any submitted material or information confidential unless prior arrangements are made pursuant to EIZO Corporation's receipt of said information. Although every effort has been made to ensure that this manual provides up-to-date information, please note that EIZO monitor specifications are subject to change without notice.

---

Macintosh and Mac OS are registered trademarks of Apple Inc.

Windows and Windows Vista are registered trademarks of Microsoft Corporation in the United States and other countries.

VESA is a registered trademark or a trademark of Video Electronics Standards Association in the United States and other countries.

EIZO, the EIZO Logo, ColorEdge, DuraVision, FlexScan, FORIS, RadiForce, RadiCS, RadiNET, Raptor, and ScreenManager are registered trademarks of EIZO Corporation in Japan and other countries.

All other company and product names are trademarks or registered trademarks of their respective owners.

---

# TABLE OF CONTENTS

TABLE OF CONTENTS.....	3
 PRECAUTIONS .....	4
Notice for this monitor.....	8
1. Introduction.....	10
1-1. Features .....	10
1-2. Package Contents .....	10
1-3. Controls and Connectors .....	11
2. Cable Connection .....	13
2-1. Before Connecting.....	13
2-2. Connecting the signal cable .....	14
2-3. Connecting Two PCs to the Monitor .....	17
3. Adjustment and Settings.....	18
3-1. How to use the ScreenManager.....	18
3-2. ScreenManager menu.....	19
3-3. Screen Adjustment (Analog Input) .....	20
3-4. Color Adjustment.....	23
3-5. Mode Preset Function <Setup>-<Mode Preset>.....	26
3-6. Power Saving Function <PowerManager> .....	26
3-7. Off Timer <Others>-<Off Timer> .....	27
3-8. Adjustment Lock Function .....	28
3-9. Power Indicator Function <Others>-<Power Indicator >.....	28
3-10. Setting the Orientation of the Menu .....	29
3-11. Displaying Low Resolutions .....	29
4. Making Use of USB (Universal Serial Bus) .....	31
5. How to attach the optional arm.....	33
6. Troubleshooting.....	34
7. Specifications.....	37
8. Glossary .....	41
APPENDIX .....	i

# ⚠ PRECAUTIONS

## IMPORTANT!

- This product has been adjusted specifically for use in the region to which it was originally shipped.  
If operated outside the region to which it was originally shipped, the product may not perform as stated in the specifications.
- To ensure personal safety and proper maintenance, please read this section and the caution statements on the unit (refer to the figure below).

### [Location of the Caution Statements]

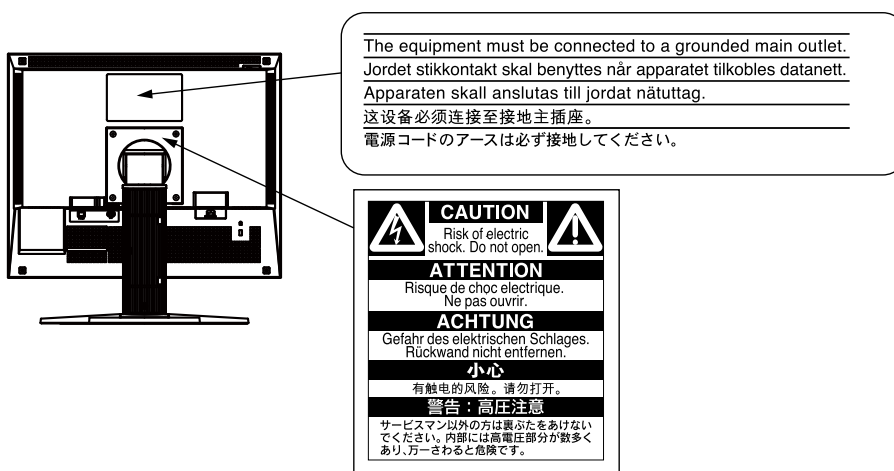

### [Symbols on the unit]

Symbol	Location	This symbol indicates
	Rear	Main Power Switch Press to turn the monitor's main power off.
	Rear	Main Power Switch Press to turn the monitor's main power on.
	Front Control Panel	Power Button Press to turn the monitor's power on or off.
	Rear Name Plate	Alternating current
	Rear	Alerting electrical hazard
	Rear	Caution Refer to SAFETY SYMBOLS section in this manual.

## WARNING

If the unit begins to emit smoke, smells like something is burning, or makes strange noises, disconnect all power connections immediately and contact your dealer for advice.

Attempting to use a malfunctioning unit may result in fire, electric shock, or equipment damage.

### Do not open the cabinet or modify the unit.

Opening the cabinet or modifying the unit may result in fire, electric shock, or burn.



### Refer all servicing to qualified service personnel.

Do not attempt to service this product yourself as opening or removing covers may result in fire, electric shock, or equipment damage.

### Keep small objects or liquids away from the unit.

Small objects accidentally falling through the ventilation slots into the cabinet or spillage into the cabinet may result in fire, electric shock, or equipment damage. If an object or liquid falls/spills into the cabinet, unplug the unit immediately. Have the unit checked by a qualified service engineer before using it again.



### Place the unit at the strong and stable place.

A unit placed on an inadequate surface may fall and result in injury or equipment damage. If the unit falls, disconnect the power immediately and ask your dealer for advice. Do not continue using a damaged unit. Using a damaged unit may result in fire or electric shock.

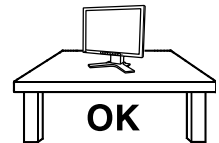

### Use the unit in an appropriate location.

Not doing so may result in fire, electric shock, or equipment damage.

- Do not place outdoors.
- Do not place in the transportation system (ship, aircraft, trains, automobiles, etc.)
- Do not place in a dusty or humid environment.
- Do not place in a location where water is splashed on the screen (bathroom, kitchen, etc.).
- Do not place in a location where the steam comes directly on the screen.
- Do not place near heat generating devices or a humidifier.
- Do not place in a location where the product is subject to direct sunlight.
- Do not place in an inflammable gas environment.

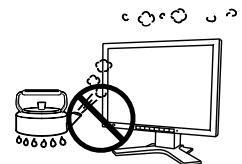

**To avoid danger of suffocation, keep the plastic packing bags away from babies and children.**

### Use the enclosed power cord and connect to the standard power outlet of your country.

Be sure to remain within the rated voltage of the power cord.

Not doing so may result in fire or electric shock.

Power supply: 100-120/200-240Vac 50/60Hz

## **WARNING**

---

**To disconnect the power cord, grasp the plug firmly and pull.**  
Tugging on the cord may damage and result in fire or electric shock.

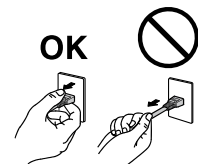

**The equipment must be connected to a grounded main outlet.**  
Failure to do so may result in fire or electric shock.



### **Use the correct voltage.**

- The unit is designed for use with a specific voltage only. Connection to another voltage than specified in this User's Manual may cause fire, electric shock, or equipment damage.  
Power supply: 100-120/200-240Vac 50/60Hz
- Do not overload your power circuit, as this may result in fire or electric shock.

### **Handle the power cord with care.**

- Do not place the cord underneath the unit or other heavy objects.
- Do not pull on or tie the cord.

If the power cord becomes damaged, stop using it. Use of a damaged cord may result in fire or electric shock.



**For the electrical safety, do not connect or disconnect the power cord in the presence of patients.**

### **Never touch the plug and power cord if it begins to thunder.**

Touching them may result in electric shock.



### **When attaching an arm stand, please refer to the user's manual of the arm stand and install the unit securely.**

Not doing so may cause the unit to become unattached, which may result in injury or equipment damage. Before installation, make sure that desks, walls, and others an arm stand is fixed on have adequate mechanical strength. When the unit is dropped, please ask your dealer for advice. Do not continue using a damaged unit. Using a damaged unit may result in fire or electric shock. When reattaching the tilt stand, please use the same screws and tighten them securely.

### **Do not touch a damaged LCD panel directly with bare hands.**

The liquid crystal that may leak from the panel is poisonous if it enters the eyes or mouth.

If any part of the skin or body comes in direct contact with the panel, please wash thoroughly. If some physical symptoms result, please consult your doctor.





## WARNING

**Fluorescent backlight lamps contain mercury (the products that have LED backlight lamps contain no mercury), dispose according to local, state or federal laws.**

Exposure to elemental mercury can result in effects on the nervous system, including tremor, memory loss, and headache.

## CAUTION

**Handle with care when carrying the unit.**

Disconnect the power cord and cables when moving the unit. Moving the unit with the cord attached is dangerous. It may result in injury.

**Carry or place the unit according to the correct specified methods.**

- When carrying the unit, grasp and hold firmly as shown in the illustration below.
- Do not unpack or carry the unit only by a single person, since the large size unit is so heavy.

Dropping the unit may result in injury or equipment damage.



OK

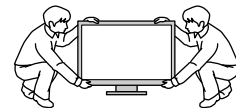

OK

**Do not block the ventilation slots on the cabinet.**

- Do not place any objects on the ventilation slots.
- Do not install the unit in a closed space.
- Do not use the unit laid down or upside down.

Blocking the ventilation slots prevents proper airflow and may result in fire, electric shock, or equipment damage.



**Do not touch the plug with wet hands.**

Doing so may result in electrical shock.



**Use an easily accessible power outlet.**

This will ensure that you can disconnect the power quickly in case of a problem.

**Periodically clean the area around the plug.**

Dust, water, or oil on the plug may result in fire.

**Unplug the unit before cleaning it.**

Cleaning the unit while it is plugged into a power outlet may result in electric shock.

**If you plan to leave the unit unused for an extended period, disconnect the power cord from the wall socket after turning off the power switch for the safety and the power conservation.**

**This product is only suitable for a patient environment, but not for contact with a patient.**

# Notice for this monitor

- This product is intended to be used in displaying and viewing digital images for diagnosis of X-ray or MRI, etc. by trained medical practitioners. It does not support the display of mammography images for diagnosis.
- This product has been adjusted specifically for use in the region to which it was originally shipped. If the product is used outside the region, it may not operate as specified in the specifications.
- This product may not be covered by warranty for uses other than those described in this manual.
- The specifications noted in this manual are only applicable when the following are used:
  - Power cords provided with the product
  - Signal cables specified by us
- Only use optional products manufactured or specified by us with this product.
- As it takes about 30 minutes for the performance of electrical parts to stabilize, adjust the monitor 30 minutes or more after the monitor power has been turned on.
- Monitors should be set to a lower brightness to reduce changes in luminosity caused by long-term use and maintain a stable display.
- When the screen image is changed after displaying the same image for extended periods of time, an afterimage may appear. Use the screen saver or timer to avoid displaying the same image for extended periods of time.
- Periodic cleaning is recommended to keep the monitor looking new and to prolong its operation lifetime (Refer to “Cleaning” (page 9).)
- The screen may have defective pixels or a small number of light dots on the screen. This is due to the characteristics of the panel itself, and is not a malfunction of the product.
- The backlight of the LCD panel has a fixed lifetime. When the screen becomes dark or begins to flicker, please contact your dealer.
- Do not press on the panel or edge of the frame strongly, as this may result in display malfunctions, such as interference patterns, etc. If pressure is continually applied to the panel, it may deteriorate or damage your panel. (If the pressure marks remain on the panel, leave the monitor with a black or white screen. The symptom may disappear.)
- Do not scratch or press on the panel with any sharp objects, as this may result in damage to the panel. Do not attempt to brush with tissues as this may scratch the panel.
- When the monitor is cold and brought into a room or the room temperature goes up quickly, dew condensation may occur on the interior and exterior surfaces of the monitor. In that case, do not turn the monitor on. Instead wait until the dew condensation disappears, otherwise it may cause some damage to the monitor.

---

## Cleaning

### NOTE

- Chemicals such as alcohol and antiseptic solution may cause gloss variation, tarnishing, and fading of the cabinet or panel, and also quality deterioration of the image.
- Never use any thinner, benzene, wax, and abrasive cleaner, which may damage the cabinet or panel.

### Tips

- The optional ScreenCleaner is recommended for cleaning the cabinet and panel surface.

If necessary, the stains on the cabinet and panel surface can be removed by moistening part of a soft cloth with water.

## To use the monitor comfortably

- An excessively dark or bright screen may affect your eyes. Adjust the brightness of the monitor according to the environmental conditions.
- Staring at the monitor for a long time tires your eyes. Take a 10-minute rest every hour.

# 1. Introduction

Thank you very much for choosing an EIZO Color Monitor.

## 1-1. Features

---

- Dual inputs compliant (DVI-I and D-Sub mini 15 pin connectors)
- DVI (p.41) digital input (TMDS (p.42)) compliant
- Horizontal scan frequency     Analog: 30 - 82 kHz  
   Digital: 30 - 65 kHz
- Vertical scan frequency         Analog: 49 - 86 Hz (1280 x 1024: 49 - 76 Hz)  
   Digital: 59 - 61 Hz (VGA text: 69 - 71 Hz)
- Frame synchronous mode       57.5 - 62.0 Hz supported
- Resolution                         1M pixels (Landscape: 1280 × 1024 dots (H × V))
- CAL Switch function for selecting an optimal calibration mode (p. 23)
- Selectable DICOM (p. 41) Part 14 complied screen
- USB (Universal Serial Bus) hub support (p. 31)
- The quality control software “RadiCS LE” (for Windows) used to calibrate the monitor is included (refer to the EIZO LCD Utility Disk).
- The utility software “ScreenManager Pro for Medical” (for Windows) to control the monitor from a PC with mouse/keyboard is included (refer to the EIZO LCD Utility Disk).
- The utility software “ToneCurve Tuning Utility” (for Windows), which can adjust the tone setting of the monitor from the computer, is included (refer to the ToneCurve Tuning Utility Disk).
- The height adjustable stand incorporated
- Slim bezel
- The Portrait display capability (rotate 90 degrees clockwise)

## 1-2. Package Contents

---

Please contact your local dealer for assistance if any of the listed items are missing or damaged.

- |                                |                                 |
|--------------------------------|---------------------------------|
| • LCD Monitor                  | • EIZO LCD Utility Disk         |
| • Power Cord                   | • ToneCurve Tuning Utility Disk |
| • Digital Signal Cable (DD300) | • User's Manual                 |
| • EIZO USB Cable (UU300)       | • LIMITED WARRANTY              |
|                                | • Recycling Information         |

---

### Tips

- Please retain the packing materials for future transport of the monitor.
-

## 1-3. Controls and Connectors

### Front

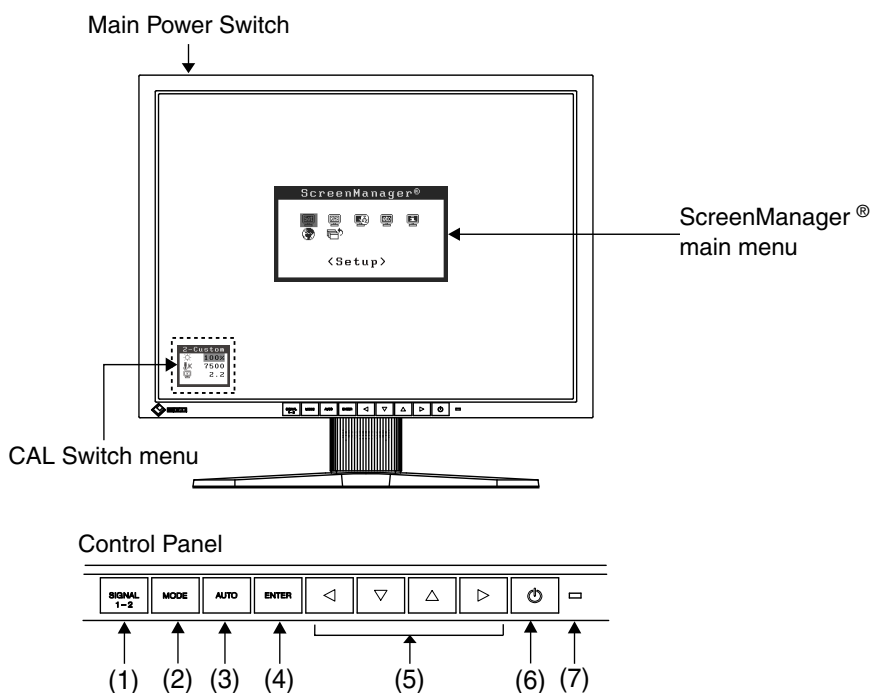

(1)	Input Signal Selection Button	Switches input signals for display when two PCs are connected to the monitor.
(2)	Mode Button	Displays the CAL Switch menu (p. 23).
(3)	Auto Adjustment Button	Performs the function to adjust the screen automatically. (analog input only)
(4)	Enter Button	Displays the ScreenManager menu, determines an item on the menu screen, and saves values adjusted.
(5)	Control Buttons* <sup>1</sup> (Left, Down, Up, Right)	Chooses an adjustment item or increases/decreases adjusted values for advanced adjustments using the ScreenManager menu. (p. 18)
(6)	Power Button	Turns the power on or off.
(7)	Power indicator* <sup>2</sup>	Indicates monitor's operation status Blue: Operational Orange: Power saving Flashing orange slowly: Power off (Main Power is on) Off: Main Power off

\*<sup>1</sup> When the monitor is oriented in the portrait position, these buttons can be changed to Up, Left, Right, and Down.

\*<sup>2</sup> To disable the power indicator while the monitor is operational, see p. 28. For power indicator status when using the "Off Timer," see p.27.

## Rear

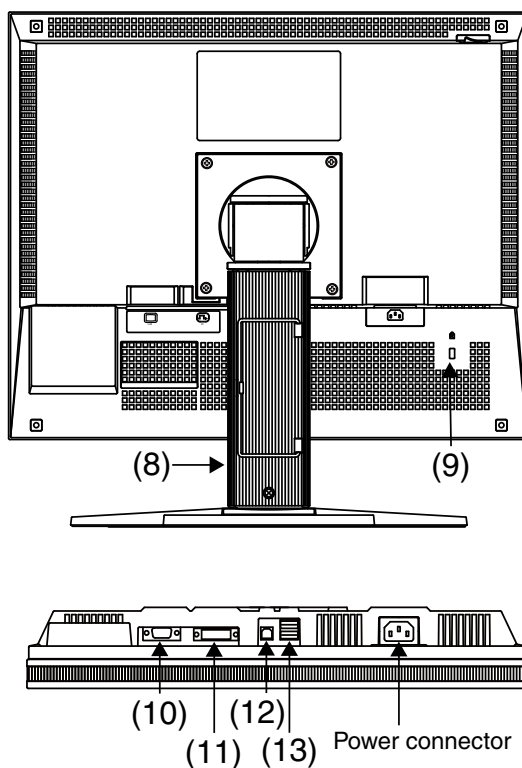

(8)	Stand <sup>*3</sup>	Used to adjust the height and angle of the monitor screen.
(9)	Security lock slot	Allows for connection of a security cable. This lock supports Kensington's MicroSaver security system.
(10)	Input signal connector	D-Sub mini 15 pin Connector (SIGNAL1)
(11)	Input signal connector	DVI-I Connector (SIGNAL2)
(12)	USB port (Up)	Connects the USB cable in order to use the provided software.
(13)	USB port (Down)	Connects a peripheral USB device.

<sup>\*3</sup> The LCD monitor has the capability of the Portrait/Landscape display. (The panel pivots in the clockwise direction 90°.)

The LCD monitor can be used with an optional arm stand by removing the stand. (p. 33)

## 2. Cable Connection

### 2-1. Before Connecting

Before connecting your monitor to the PC, change the display screen settings (resolution (p.42) and frequency) in accordance with the charts below.

#### Tips

- When your computer and monitor support VESA DDC, the appropriate resolution and the refresh rate are set just by plugging your display into the computer without any manual settings.

#### Analog Input

Resolution	Mode	Frequency	Dot Clock
640 x 480	VGA	60 Hz	135 MHz (Max.)
640 x 480	VESA	~ 85 Hz	
720 x 400	VGA TEXT	70 Hz	
800 x 600	VESA	~ 85 Hz	
1024 x 768	VESA	~ 85 Hz	
1152 x 864	VESA	75 Hz	
1280 x 960	VESA	60 Hz	
1280 x 1024	VESA	~ 75 Hz	

#### Digital Input

Resolution	Mode	Frequency	Dot Clock
640 x 480	VGA	60 Hz	108 MHz (Max.)
720 x 400	VGA TEXT	70 Hz	
800 x 600	VESA	60 Hz	
1024 x 768	VESA	60 Hz	
1280 x 1024	VESA	60 Hz	

## 2-2. Connecting the Signal Cable

**NOTE**

- Be sure that the power switches of both the PC and the monitor are OFF.
- Refer to the PC user's manual when connecting the monitor.

**1 Plug the signal cable into the connector on the rear of the monitor and the other end of the cable into the video connector on the PC.**

After connecting, secure the cable connectors with the attached screw-in fasteners.

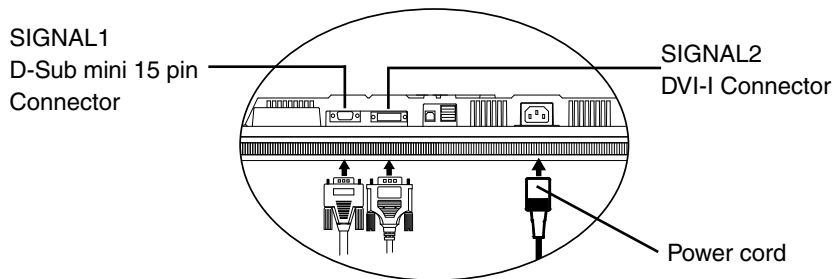

### Analog Input

Connect to SIGNAL1 (D-Sub 15 pin Connector).

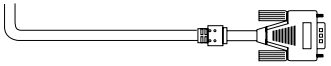
Signal Cable	Connector on PC	PC
Signal cable (MD-C87 optional) 	Video Output Connector / D-Sub mini 15 pin	<ul style="list-style-type: none"> <li>• Standard graphics card</li> <li>• Power Macintosh G3 (Blue &amp; White) / Power Mac G4 (VGA)</li> </ul>

### Digital Input

Connect to SIGNAL2 (DVI-I Connector).

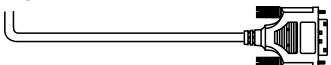
Signal Cable	Connector on PC	PC
Signal cable (DD300 enclosed) 	Video Output Connector / DVI	<ul style="list-style-type: none"> <li>• Exclusive graphics board (p. 39)</li> </ul>

**2 Connect the power cord to the power connector on the rear of the monitor.**



- 3 Thread the power cord and signal cable through the cable holder on the rear of the monitor stand.

**NOTE**

- When threading the cables through the cable holder, lead them to the cable entrance side and pinch the projection to open the cable entrance.
- It is recommended that some slack be left in the cables to allow for smooth adjustment of the monitor stand and easy rotation between the portrait and landscape positions.

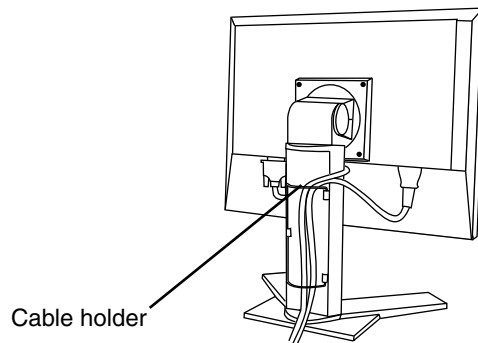

- 4 Connect the other end of the power cord to a power outlet.

 **WARNING**

**Use the enclosed power cord and connect to the standard power outlet of your country.**

Be sure to remain within the rated voltage of the power cord. Not doing so may result in fire or electric shock.

**The equipment must be connected to a grounded main outlet.**

Not doing so may result in fire or electric shock.



- 5 Turn on the monitor's power by pressing the Power Button.

The monitor's power indicator will light up blue.

### **6 Turn on the PC's power.**

The image will appear.

If an image does not appear, refer to “6. Troubleshooting” (p. 34) for additional advice.

Refer to “3-3. Screen Adjustment (In case of Analog Input Signal)” (p. 20) and adjust the screen for analog input.

If using the monitor in the digital input signal, it displays the image correctly based on its pre-setting data.

When finished, turn off the PC and the monitor.

---

#### **Tips**

- Adjust the brightness of the screen depending on the brightness of your environment.
  - Be sure to take adequate rests. A 10-minute rest period each hour is suggested.
- 

### **7 When using the software “RadiCS LE” (for Windows), “ScreenManager Pro for Medical” (for Windows) or “ToneCurve Tuning Utility”, connect the monitor to an USB compliant Windows computer (or other USB hub) with an USB cable.**

Refer to “4. Making Use of USB (Universal Serial Bus)” (p. 31).

## 2-3. Connecting Two PCs to the Monitor

Two PCs can be connected to the monitor through the Signal 1 and the Signal 2 on the back of the monitor.

### Selecting the Active Input

The Input Signal Selection Button on the control panel can be used to select either Signal 1 or Signal 2 as the active input at any time. Every time the button is pressed, the input changes. When the signal is switched, the active signal type (Signal 1 or 2/ Analog or Digital) appears at the top right corner of the screen.

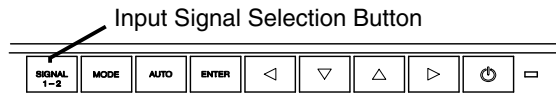

### The Priority Input Signal

This function is used to select which PC will have priority to control the monitor by selecting <Input Priority> in the ScreenManager <Setup> menu (See p. 18 to use the ScreenManager). In the case of only one signal being present at either input, the monitor automatically detects and displays that signal.

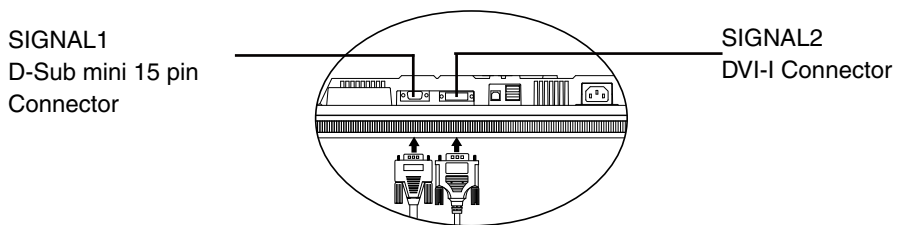

Priority Setting	Performance
1 Input from Signal 1	<p>The input signal from “Signal 1” is displayed in the following cases.</p> <ul style="list-style-type: none"> <li>• When the monitor is turned on.</li> <li>• When the PC for the “Signal 1” is turned on while displaying the image of the “Signal 2”.</li> <li>• When the PC for the “Signal 1” is recovered from the Power saving mode while displaying the image of the “Signal 2”.</li> </ul>
2 Input from Signal 2	<p>The input signal from “Signal 2” is displayed in the following cases.</p> <ul style="list-style-type: none"> <li>• When the monitor is turned on.</li> <li>• When the PC for the “Signal 2” is turned on while displaying the image of the “Signal 1”.</li> <li>• When the PC for the “Signal 2” is recovered from the Power saving mode while displaying the image of the “Signal 1”.</li> </ul>
Manual	<p>The monitor will not detect signals automatically in this mode. Select the active input by pressing the Input Signal Selection Button on the monitor’s control panel.</p>

#### Tips

- When the “1” or “2” is selected, the power saving mode of the monitor activates only if both PCs are in power saving mode.

# 3. Adjustment and Settings

## 3-1. How to use the ScreenManager

Screen adjustments and settings can be performed with the ScreenManager (OSD) and buttons of the monitor.

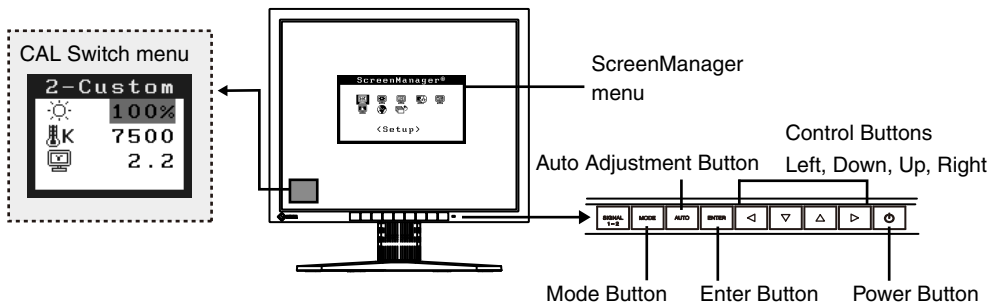

### NOTE

- The ScreenManager menu and the CAL Switch menu cannot be displayed at the same time.

### 1. Enter the ScreenManager.

Press the Enter Button once to display the main menu of the ScreenManager.

### 2. Making Adjustments and Settings.

- (1) Select the desired sub menu icon using the Control Buttons and press the Enter Button. The sub menu appears.
- (2) Use the Control Buttons to select the desired setting icon and press the Enter Button. The setting menu appears.
- (3) Use the Control Buttons to make all required adjustments and press the Enter Button to save the settings.

### 3. Exiting the ScreenManager.

- (1) To return to the main menu, select the <Return> icon or press the Down Button twice, followed by the Enter Button.
- (2) To exit the ScreenManager, select the <Exit> icon or press the Down Button twice, followed by the Enter Button.

### Tips

- Double clicking the Enter Button also exits the ScreenManager menu.

## 3-2. ScreenManager menu

Using ScreenManager menu controls the screen adjustment and settings. Refer to the “Explanation” column in the following table for each detailed functions.

### Functions

The following table shows all the ScreenManager’s adjustment and setting menus. “\*” indicates adjustments of analog input only and “\*\*” indicates digital input only.

Main menu	Sub menu	Explanation	
Setup	Mode Preset	3-5. Mode Preset Function <Setup>-<Mode Preset> (p. 26)	
	Input Priority	Select the priority input signal. (p. 17)	
Screen*	Clock	3-3. Screen Adjustment (Analog Input) (p. 20)	
	Phase		
	Position		
	Resolution		
	Range Adjustment		
	Signal Filter		
Color**	Brightness	3-4. Color Adjustment (p. 23)	
	Temperature		
	Gamma		
	Saturation		
	Hue		
	Gain		
	6 Colors		
	Reset		
PowerManager	DVI DMPM**	3-6. Power Saving Function <PowerManager> (p. 26)	
	VESA DPMS*		
Others	Screen Size	3-11. Displaying Low Resolutions (p. 29)	
	Smoothing		
	Border Intensity		
	Off Timer	Set the monitor’s off timer to on or off (p. 27).	
	Menu Settings	Menu Size	Change the size of the menu.
		Menu Position	Adjust the menu position.
		Menu Off Timer	Set the menu displaying time.* <sup>2</sup>
		Translucent	Set the transparency of the background.
		Orientation	Change the orientation of the ScreenManager for monitor’s portrait position.
	Power Indicator	Make non-light for blue lighting when the screen is displayed(p. 28).	
	Reset	Return to the factory default settings(p.38).	
Information	Information	Review the ScreenManager’s settings, model name, serial number and usage time* <sup>3</sup> .	

Main menu	Sub menu	Explanation
Language	English, German, French, Spanish, Italian, Swedish, Chinese(Simplified), Chinese(Traditional) and Japanese	Select the ScreenManager's language.

<sup>\*1</sup> The adjustable functions depend on the selected CAL Switch mode. (p. 24)

<sup>\*2</sup> The display time of the CAL Switch menu can be adjusted.

<sup>\*3</sup> Due to factory inspection, the usage time may not be "0 hours" at time of shipping.

## 3-3. Screen Adjustment (Analog Input)

---

Screen adjustments for the LCD monitor should be used in suppressing screen flickering and also for adjusting the screen to its proper position. It is also recommended to use the ScreenManager function when first installing the display or whenever changing the system.

### NOTE

- Allow the LCD monitor to stabilize for at least 30 minutes before making image adjustments.
- 

### Adjustment Procedure

About how to use the ScreenManager, refer to p. 18.

#### 1. Press the Auto Adjustment Button on the control panel.

The message "Your setting will be lost, if you press again now." appears and remains on the screen for 5 seconds. While the message is on the screen, press the Auto Adjustment Button again to automatically adjust the clock, phase, screen position and resolution. If you do not wish to do adjust the screen, do not press the Auto Adjustment Button again.

### NOTE

- The Auto Adjustment function is intended for use on the Macintosh and on AT-compatible PC running Windows. It may not work properly in either of the following cases.  
When running an AT-compatible PC on MS-DOS (Not windows). The background color for the "wall paper" or "desktop" pattern is set to black.
  - It cannot work correctly using with some graphics cards.
- 

If the appropriate screen cannot be made by using the Auto Adjustment Button, adjust the screen through the following procedures. If the appropriate screen can be made, proceed to step 3.

## 2. Adjust the advanced setting by using <Screen> menu in the ScreenManager.

(1) Vertical bars appear on the screen.

→  Use the <Clock> (p. 41) adjustment.

Select the “Clock” and eliminate the vertical bars by using the Right and Left of the Control Buttons. Do not press the Control Buttons continuously, as the adjustment value will change quickly and make it difficult to locate the most suitable adjustment point.

If the horizontal flickering, blur or bars appear, proceed to “Phase” adjustment as follows.

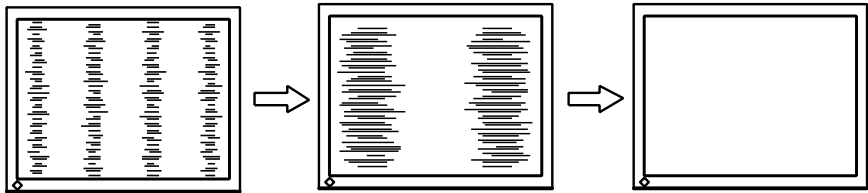

(2) Horizontal flickering, blurring or bars appear on the screen.

→  Use the <Phase> (p. 41) adjustment.

Select the <Phase> and eliminate the horizontal flickering, blurring or bars by using the Right and Left Buttons.

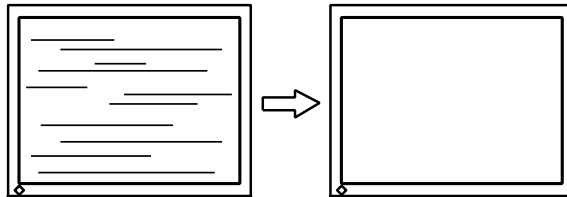

### NOTE

- Horizontal bars may not completely disappear from the screen depending on the PC.

(3) The screen position is incorrect.

→  Use the <Position> adjustment.

The correct displayed position of the monitor is decided because the number and the position of the pixels are fixed. The <Position> adjustment moves the image to the correct position.

Select <Position> and adjust the position of the upper left corner of the image by using the Up, Down, Right and Left Buttons in order to align the screen.

If vertical bars of distortion appear after finishing the <Position> adjustment, return to <Clock> adjustment and repeat the previously explained adjustment procedure (“Clock” → “Phase” → “Position”).

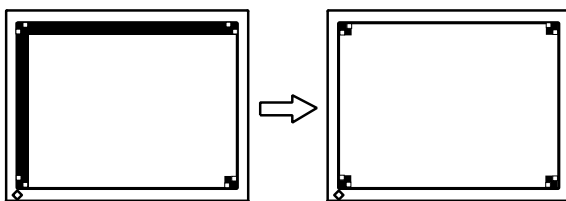

(4) Screen image is smaller or larger than the actual screen images.

→  Use the <Resolution> adjustment.

Adjustment is needed when the input signal resolution and the resolution now being displayed are different.

Select <Resolution> and confirm if the resolution now being displayed is the same as the input resolution. If it is not, adjust the vertical resolution using the Up and Down Button and adjust the horizontal resolution using the Right and Left Buttons.

Extra image is displayed due to excessive dots.

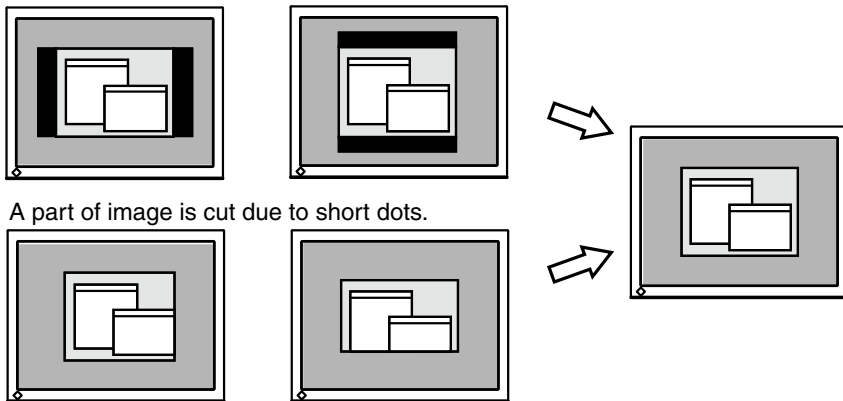

A part of image is cut due to short dots.

### 3. Adjust the output signal range (Dynamic Range) of the signal.

→  Use the <Range Adjustment> (p. 42) of <Screen> menu.

This controls the level of output signal range to display the whole color gradation (256 colors).

[Procedure]

Press the Auto Adjustment Button on the control panel while displaying the <Range Adjustment> menu to automatically adjust the range. The screen blanks for a moment and adjusts the color range to display the whole color gradation of the current output signal.



## 3-4. Color Adjustment

### Simple Adjustment [CAL Switch mode]

The most suitable display mode is available by pressing the Mode Button on the control panel.

The <Brightness>, <Temperature>, and <Gamma> settings can be adjusted on the CAL Switch menu.

### CAL Switch Modes

Mode		Description
1 - DICOM	*	Used to display images in the DICOM mode
2 - Custom	*	Used to adjust color setting preferences
3 - CAL	*	Used for monitor calibration
4 - Text		Suitable for displaying text from word processing or spreadsheet software

\* All modes can be calibrated independently.

The mode name can also be changed using the calibration kit (RadiCS LE / see Optional, p. 39).

### How to use the CAL Switch Function

#### [Entering the CAL Switch menu]

Press the Mode Button.

#### [Selecting the CAL Switch mode]

Press the Mode Button while the CAL Switch menu is displayed.

Pressing Mode Button allows you to select the following mode.

1-DICOM → 2-Custom → 3-CAL → 4-Text → 1-DICOM

#### [Making color adjustments in CAL Switch mode]

1. Select the desired setting icon with the Up and Down Button.
2. Adjust the value of the selected item with the Left and Right Button.

#### [Closing the CAL Switch menu]

Press the Enter Button.

#### NOTE

- The ScreenManager menu and CAL Switch menu cannot be displayed at the same time.
- When switching between modes, the monitor can be set to display only the specified modes, skipping any unnecessary modes (see p.26 3-5. Mode Preset Function <Setup> <Mode Preset>).
- In some modes, <Temperature> and/or <Gamma> settings may be fixed at the default values (p. 24).
- Detailed color settings for each mode can be adjusted in the <Color> menu of the ScreenManager (p. 24).

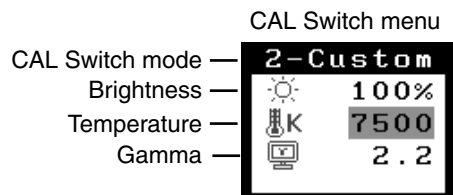









## Advanced Adjustments[Adjustment menu]

The color settings for each CAL Switch mode can be adjusted and saved in the <Color> menu of the ScreenManager.

### Available settings

The settings available for adjustment and the icons displayed in the ScreenManager will differ depending on which CAL Switch mode is selected. Refer to the following table as needed.

“√”: Adjustable “-”: Fixed at the factory

Icons	Settings	CAL Switch Mode			
		1 - DICOM	2 - Custom* <sup>2</sup>	3 - CAL	4 - Text
	Brightness <sup>1</sup>	√	√	√	√
	Temperature <sup>1</sup>	-	√	-	√
	Gamma <sup>1</sup>	-	√	-	√
	Saturation	-	√	-	√
	Hue	-	√	-	√
	Gain	-	√	-	-
	6 colors	-	√	-	-
	Reset	√	√	√	√









<sup>1</sup> These settings can also be adjusted on the CAL Switch menu (p. 23).

<sup>2</sup> When calibration is performed in this mode using the calibration kit (RadiCS LE / see Optional, p. 39), only the brightness and reset settings can be adjusted.

### NOTE

- Allow the monitor to warm up for at least 30 minutes before making color adjustments.
- The <Reset> setting restores the default color settings in the <Color> menu for the selected CAL Switch mode.
- Because each monitor is subject to individual differences, colors may appear slightly different, even for the same image, when several monitors are lined up side-by-side. When aligning the color on several monitors, use visual judgment to fine-tuning the settings.

## Adjustment Contents

Menu	Description	Adjustable Range
Brightness 	Sets the brightness of the screen	0~130%
Temperature (p. 42) 	Sets the color temperature	6500 K~15000 K in 500 Kincrements (including 9300 K).
	<p><b>Tips</b></p> <ul style="list-style-type: none"> <li>• The values shown in the Kelvin (K) are available only as reference.</li> <li>• While color temperature is adjusted, &lt;Gain&gt; is adjusted automatically according to the color temperature.</li> <li>• When &lt;Gain&gt; is set, color temperature setting is disabled, and is set to “OFF”.</li> <li>• Setting the temperature under 6500 K or over 15000 K invalidates the color temperature setting. (The color temperature setting turns “OFF”.)</li> </ul>	
Gamma (p. 41) 	Sets the gamma value	1.8~2.6
Saturation 	To change the saturation	-100~100 Selecting the minimum level (-100) makes the image monochrome.
	<p><b>NOTE</b></p> <ul style="list-style-type: none"> <li>• The &lt;Saturation&gt; adjustment may cause undisplayable color tone.</li> </ul>	
Hue 	Sets the hue value(for flesh tones, etc.)	-100~100
	<p><b>NOTE</b></p> <ul style="list-style-type: none"> <li>• The &lt;Hue&gt; adjustment may cause undisplayable color tone.</li> </ul>	
Gain (p. 42) 	Sets the gain for each color (red, green, and blue)	0~100% By adjusting the red, green and blue color tones for each mode, custom colors can be defined. Display a white or gray background image and adjust the <Gain>.
	<p><b>Tips</b></p> <ul style="list-style-type: none"> <li>• Values shown in percentages are meant only as a reference.</li> <li>• The &lt;Temperature&gt; setting invalidates this setting. The &lt;Gain&gt; setting varies with color temperature.</li> </ul>	
6 colors 	Sets <Saturation> and <Hue> for each color (red, yellow, green, cyan, blue, and magenta)	Hue : -100~100 Saturation : -100~100
Reset 	Restores the default color settings for the selected mode	Select the <Reset>.

## 3-5. Mode Preset Function <Setup>-<Mode Preset>

When CAL Switch mode is selected, the computer can be forced to display only specified modes. Use this function when the display modes are restricted or when the display should not be changed needlessly.

### [How to set]

1. Select <Mode Preset> in the ScreenManager <Setup> menu.
2. Set each mode to “On” or “Off”.

### NOTE

- You cannot disable all modes. Set one or more modes to “On”.

### [How to cancel]

1. Select <Mode Preset> in the ScreenManager <Setup> menu.
2. Set the mode that you wish to display to “On”.

## 3-6. Power Saving Function <PowerManager>

The <PowerManager> menu in the ScreenManager enables to set the power saving.

### NOTE

- Do your part to conserve energy, turn off the monitor when you finished using it. Disconnecting the monitor from the power supply is recommended to save energy completely.
- Even if the monitor is in a power saving mode, USB compliant devices function when they are connected to the monitor’s USB (both the upstream and the downstream ports). Therefore, power consumption of the monitor will change according to the connected devices even if the monitor is in a power saving mode.

### Digital input

This monitor complies with the “DVI DMPM” (p. 41).

### [How to set]

1. Set the PC’s power saving settings.
2. Select “DVI DMPM” in the <PowerManager> menu.

### [Power saving system]

PC	Monitor	Power Indicator
On	Operation	Blue
Power saving/ Off mode	Power saving	Orange

### [Power Resumption Procedure]

Operate the mouse or keyboard to return to a normal screen.  
Power on the PC to return a normal screen from the Off mode of the PC.

## Analog Input

This monitor complies with the “VESA DPMS” (p. 42).

### [How to set]

1. Set the PC's power saving settings.
2. Select “VESA DPMS” in the <PowerManager> menu.

### [Power saving system]

PC		Monitor	Power Indicator
Operation		Operation	Blue
Power saving	STAND-BY SUSPEND OFF	Power saving	Orange

### [Power Resumption Procedure]

Operate the mouse or keyboard to return to a normal screen.

## 3-7. Off Timer <Others>-<Off Timer>

The off timer function causes the monitor to turn off automatically after a predetermined amount of time has lapsed. This function was created to reduce the afterimages particular to LCD monitors, which appear when the screen is left on for long periods without use.

### [How to set]

1. Select <Off Timer> in the ScreenManager <Others> menu.
2. Select “Enable” and press the Right and Left Buttons to adjust the “On Period” (1 to 23 hours).

### [Off timer system]

PC	Monitor	Power Indicator
Operating time (1H - 23H)	Operational	Blue
Last 15 min. in operating time	Advance Notice * <sup>1</sup>	Flashing blue
Operating time expired	Power off	Flashing orange slowly

\*<sup>1</sup>Advance notice (Power Indicator flashing blue) will be given 15 minutes before the monitor automatically enters the “Power Off” mode. To delay entering the “Power Off” mode, press the Power Button during the advance notice period. The monitor will continue to operate for an additional 90 minutes.

### [Power Resumption Procedure]

Press the Power Button to return to a normal screen.

#### NOTE

- The off timer function works while the PowerManager is active, but there is no advance notice before the monitor's power is turned off.

## 3-8. Adjustment Lock Function

---

Use the “Adjustment Lock” function to prevent any accidental changes.

Locked functions	<ul style="list-style-type: none"><li>• Display, adjustment, and setting of the ScreenManager</li><li>• Brightness adjustments to the CAL Switch mode</li></ul>
Unlocked function	<ul style="list-style-type: none"><li>• Selection of the CAL Switch mode with the Mode Button</li><li>• Input Signal Selection Button</li></ul>

### [To lock]

1. Switch off the monitor’s power by the Power Button on the control panel.
2. Hold down the Auto Adjustment Button and turn the monitor's power on.

### [To unlock]

1. Switch off the monitor’s power by the Power Button on the control panel.
2. Hold down the Auto Adjustment Button once again and turn the power back on.

---

### **NOTE**

- The adjustment lock function may activate when calibration is performed with the calibration kit (RadiCS LE / see Optional, p. 39). The monitor can be unlocked using the same unlocking procedure described above.
- 

## 3-9. Power Indicator Function <Others><Power Indicator >

---

Use the function to keep the power indicator without light while the monitor is operational. (The power indicator is set by default to light when the power is turned on.)

### [How to set]

1. Select <Power Indicator> in the ScreenManager <Others> menu.
2. Select “Disable”.

## 3-10. Setting the Orientation of the Menu

This function allows you to change the orientation of the ScreenManager when using the monitor screen in vertical display position.

### [Procedure]

1. Select <Orientation> in the ScreenManager <Others> menu.
2. Set the orientation to "Portrait".

## 3-11. Displaying Low Resolutions

With this function, low-resolution images, such as VGA 640x480, can be displayed at a desired size. In addition, it is possible to adjust or set smoothing for such images and the brightness for blank border areas.

### Changing the Screen Size

### [Procedure]

1. Select <Screen Size> in the ScreenManager <Others> menu.
2. Select the screen size with the Up and Down Buttons.

Menu	Explanation
Full Screen	Stretches the image to cover the full screen, regardless of the image's resolution. Since the vertical resolution and the horizontal resolution are enlarged at different rates, some images may appear distorted.
Enlarged	Enlarges the image on the screen, regardless of the image's resolution. Since the vertical resolution and horizontal resolution are enlarged at same rates, some horizontal or vertical image may disappear.
Normal	Displays the image at the actual Screen resolution.

Example: Displaying 1024 x 768

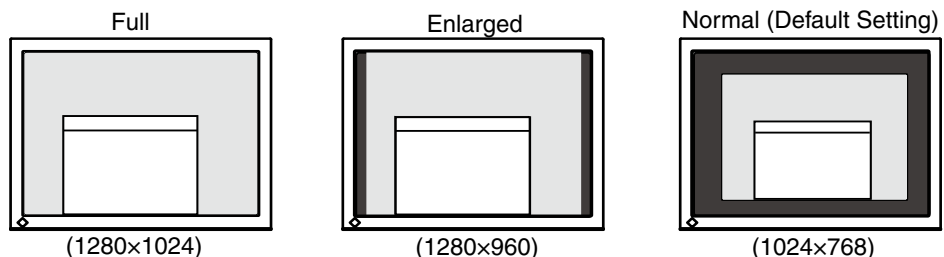

### Smoothing the blurred texts

Image smoothing can be adjusted if text or lines appear blurred when the display is set to "Full Screen" or "Enlarged" mode.

#### **[Procedure]**

1. Select < Smoothing> in the ScreenManager <Others> menu.
2. Select a suitable level of the smoothing from 1 to 5 (Soft to Sharp) with the Right and Left Buttons.

---

#### **NOTE**

- Smoothing setting may not be required depending on the display resolution. (You cannot choose the smoothing icon.)
- 

#### **Adjusting the brightness of the black area surrounding the displayed image**

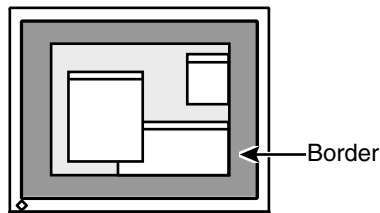

#### **[Procedure]**

1. Select <Border Intensity> in the ScreenManager <Others> menu.
2. Adjust the border intensity with the Right and Left Buttons.  
The Left and Right Buttons makes the border darker and brighter respectively.



## 4. Making Use of USB (Universal Serial Bus)

This monitor provides a hub which supports the USB standard. When connecting to a USB compliant PC or another hub, the monitor functions as a hub to which the USB compliant peripherals can be easily connected.

### **Required system environment**

- PC equipped with USB ports or another USB hub connected to the USB compliant PC
- Windows 2000/XP/Vista/7/8 // Mac OS 9.2.2 and Mac OS X 10.2 or later
- USB Cable (UU300, enclosed)

### **NOTE**

- The USB hub function may not work properly depending on the PC or peripherals. Please consult the manufacturer of each device about the USB support.
- Using the USB Rev. 2.0 compatible PC or peripherals is recommended.
- If the monitor is in the power saving mode, or if the monitor is connected to the power outlet with the monitor turned off, all the devices connected to the USB ports (upstream and downstream) work. Therefore, power consumption of the monitor varies with connected devices even in the power saving mode.
- The followings are procedures for the Windows 2000/XP/Vista/7/8 and Mac OS.

### **Connecting to the USB Hub**

- 1** Connect the monitor to the PC with the signal cable (p. 14) first, then turn on the PC.
- 2** Connect the upstream port of the monitor to the downstream port of the USB compliant PC or another hub by using the USB cable.

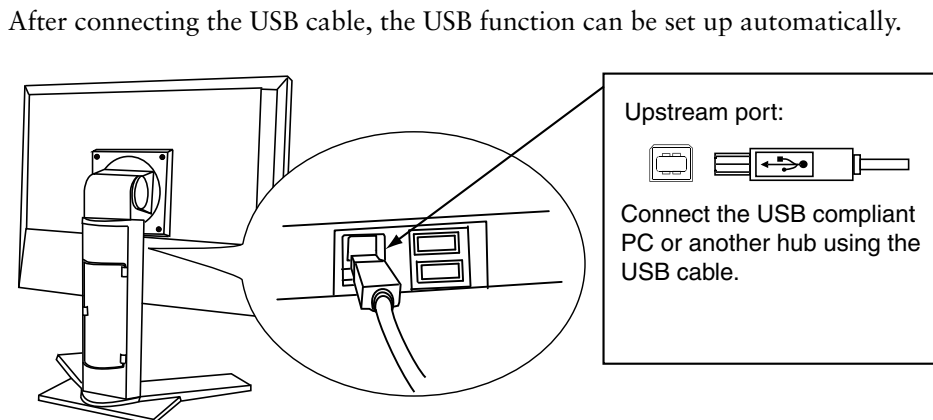

**3** After setting up, the monitor's USB hub is available for connecting USB compliant peripherals to the downstream ports of the monitor.

Connecting Example

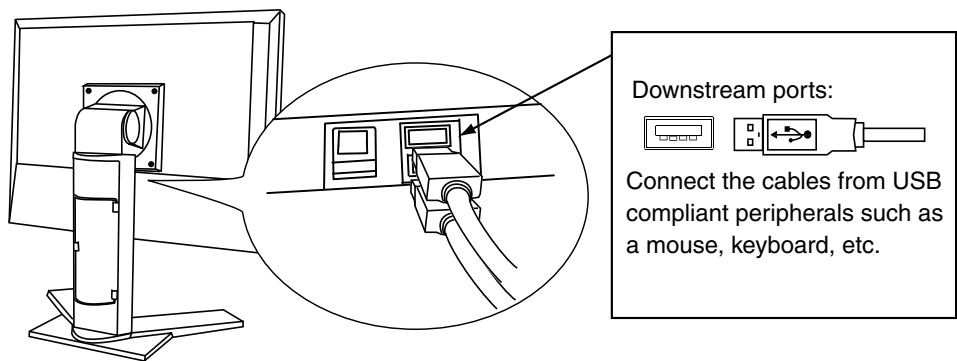
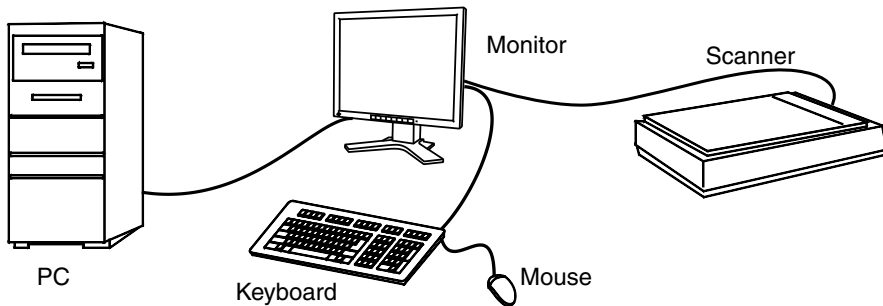

**To use “RadiCS LE” (for Windows), “ScreenManager Pro for Medical” (for Windows) or “ToneCurve Tuning Utility”**

Refer to the corresponding User's Manual on the CD-ROM disk in order to install and use the software. When using the above softwares, you will need to connect a PC to the monitor with the supplied USB cable.

# 5. How to attach the optional arm

An optional arm (or an optional stand) can be attached by removing the stand section. Please refer to our web site for the corresponding optional arm (or optional stand).  
<http://www.eizo.com>

## NOTE

- When attaching an arm or stand, follow the instructions of their user's manual.
- When using another manufacturer's arm or stand, confirm the following in advance and select one conforming to the VESA standard.
  - Clearance between the screw holes: 100 mm × 100 mm
  - Thickness of plate: 2.6 mm
  - Strong enough to support weight of the monitor unit (except the stand) and attachments such as cables
- When using an arm or stand, attach it to meet the following tilt angles of the monitor.
  - Up 45 degrees, down 45 degrees (horizontal display, and vertical display rotated 90 degrees clockwise)
- Connect the cables after attaching an arm or a stand.
- Do not adjust the height of the stand removed from the monitor. When adjusted without attached monitor, it causes the personnel injury or the damaged to the stand.
- Since the monitor and arm or stand are so heavy, dropping them may result in injury or equipment damage.

## Setup Procedure

- 1** Lay the LCD monitor on a soft cloth spread over on a stable surface with the panel surface facing down.
- 2** Remove the stand. (Prepare a screwdriver.)  
 Unscrew the two screws securing the unit and the stand with the screwdriver.
- 3** Attach the monitor to the arm or stand.  
 Secure the monitor to the arm or stand using the screws specified in the user's manual of the arm or stand.

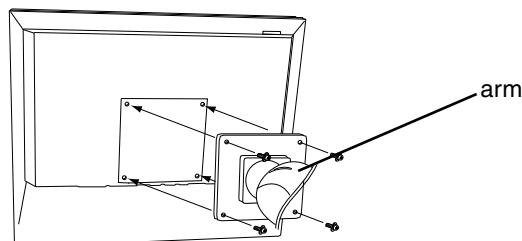



# 6. Troubleshooting

If a problem persists even after applying the suggested remedies, contact an EIZO dealer.

- No picture problems → See No.1 ~ No.2
- Imaging problems → See No.3 ~ No.14
- Other problems → See No.15~ No.18
- USB problems → See No.19

Problems	Points to check with possible solutions
1. No picture Indicator status: Off	<ul style="list-style-type: none"> <li>• Check that the power cord is connected correctly. If the problem persists, turn off the monitor power for a few minutes, then turn it back on and try again.</li> <li>• Try pressing the Power Button.</li> </ul>
Indicator status: Orange	<ul style="list-style-type: none"> <li>• Switch the signal input by pressing the Input Signal Selection Button on the front control panel.</li> <li>• Try pressing a key on the keyboard or clicking the mouse (p. 26).</li> <li>• Try turning the PC on.</li> </ul>
Indicator status: Blue	<ul style="list-style-type: none"> <li>• Set each RGB adjusting value in &lt;Gain&gt; to higher level. (p. 25).</li> </ul>
Indicator status: Flashing orange	<ul style="list-style-type: none"> <li>• Try pressing the Power Button.</li> </ul>
2. The message below appears.	These messages appear when the signal is not inputted correctly, even if the monitor functions properly.
<ul style="list-style-type: none"> <li>• The message appears when the signal is not input. (This is displayed for about 40 seconds)</li> </ul> <div data-bbox="196 1108 502 1271" style="border: 1px solid black; padding: 5px; margin: 10px 0;"> <p style="text-align: center;"><b>Signal Check</b></p> <p style="text-align: center;">Signal 2</p> <p style="text-align: center;">fH: 0.0kHz fV: 0.0Hz</p> </div>	<ul style="list-style-type: none"> <li>• The message might appear because some PCs do not output the video signal immediately after powering on. If the image is displayed correctly after a short time, there is no problem with the monitor.</li> <li>• Check that the PC is turned on.</li> <li>• Check whether the signal cable is connected properly.</li> <li>• Switch the signal input by pressing the Input Signal Selection Button on the front control panel.</li> </ul>
<ul style="list-style-type: none"> <li>• The message appears when the signal is out of input range. (Example)</li> </ul> <div data-bbox="196 1456 502 1619" style="border: 1px solid black; padding: 5px; margin: 10px 0;"> <p style="text-align: center;"><b>Signal Error</b></p> <p style="text-align: center;">Signal 2</p> <p style="text-align: center;">fD: 165.0MHz fH: 75.0kHz fV: 60.0Hz</p> </div>	<ul style="list-style-type: none"> <li>• Check whether the signal setting of your PC matches the resolution and the vertical frequency settings for the monitor.</li> <li>• Reboot the PC.</li> <li>• Use the graphics board's utility software to change the frequency setting. (Refer to the manual of the graphics board.)</li> </ul> <p>fD : Dot Clock (Displayed only when the digital signal inputs)</p> <p>fH : Horizontal Frequency</p> <p>fV : Vertical Frequency</p>

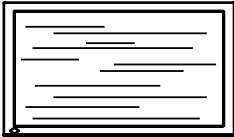
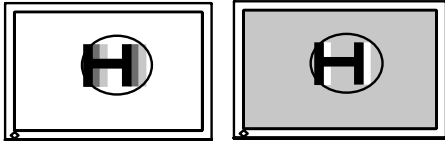
Problems	Points to check with possible solutions
3. The screen is too bright or too dark.	<ul style="list-style-type: none"> <li>Adjust the &lt;Brightness&gt; . (The LCD monitor backlight has a fixed life span. When the screen becomes dark or begins to flicker, please contact your dealer.)</li> </ul>
4. Letters and lines appear blurred.	<ul style="list-style-type: none"> <li>Check whether the signal setting of your PC matches the resolution and the vertical frequency settings for the monitor.</li> <li>Adjust the blurred lines using &lt;Smoothing&gt; (p.29)</li> </ul>
5. Afterimages appear.	<ul style="list-style-type: none"> <li>Use a screen saver or off timer function for a long-time image display.</li> <li>Afterimages are particular to LCD monitors. Avoid displaying the same image for a long time.</li> </ul>
6. The screen has defective pixels (e.g. slightly light or dark).	<ul style="list-style-type: none"> <li>This is due to the characteristics of the panel itself and not the LCD product.</li> </ul>
7. Interference patterns or pressure marks remain on the screen.	<ul style="list-style-type: none"> <li>Leave the monitor with a white or black screen. The symptom may disappear.</li> </ul>
8. Noise appears on the screen.	<ul style="list-style-type: none"> <li>When entering the signals of analog input, select 1 to 4 in &lt;Signal Filter&gt; from the &lt;Screen&gt; menu to change the mode</li> </ul>
9. Display position is incorrect.  	<ul style="list-style-type: none"> <li>Adjust image position so that it is displayed properly within the display area using the &lt;Position&gt; adjustment (p.21).</li> <li>If the problem persists, use the graphics board's utility if available to change the display position.</li> </ul>
10. Screen image is smaller or larger than the actual screen images.	<ul style="list-style-type: none"> <li>Adjust the resolution using the &lt;Resolution&gt;. (p.22)</li> </ul>
11. Vertical bars of distortion appear.  	<ul style="list-style-type: none"> <li>Decrease the vertical bars using the &lt;Clock&gt;. (p.21).</li> </ul>
12. Horizontal bars of distortion appear.  	<ul style="list-style-type: none"> <li>Decrease the horizontal bars using the &lt;Phase&gt;(p.21).</li> </ul>
13. The characters and images have several vertical bars on their right side.  	<ul style="list-style-type: none"> <li>Adjust the characters and images using the &lt;Signal Filter&gt;.</li> </ul>

## 6. Troubleshooting

Problems	Points to check with possible solutions
<p>14. Distortion appears like the figure below.</p> 	<ul style="list-style-type: none"> <li>• This happens when both composite (X-OR) input signal and separate vertical synchronizing signal are input. Please select one of the two.</li> </ul>
<p>15. The &lt;Smoothing&gt; cannot be selected.</p>	<ul style="list-style-type: none"> <li>• Smoothing setting may not be required depending on the display resolution. (You cannot choose the smoothing icon.)</li> <li>• &lt;Smoothing&gt; is disabled when the screen is displayed in the 1280 x 1024.</li> <li>• Select "Normal" during &lt;Screen Size&gt;.</li> <li>• The image size is doubled both in horizontally and vertically to (i.e. 1280 x 960 enlarged from 640 x 480) provide clear focus which does not require this function.</li> </ul>
<p>16. The ScreenManager main menu does not operate.</p>	<ul style="list-style-type: none"> <li>• Make sure that the adjustment lock is off (p. 28).</li> </ul>
<p>17. CAL Switch mode does not operate.</p>	<ul style="list-style-type: none"> <li>• Make sure that the adjustment lock is off (p. 28).</li> </ul>
<p>18. The Auto Adjustment Button does not operate.</p>	<ul style="list-style-type: none"> <li>• The Auto Adjustment Button does not operate when the digital signal is input.</li> <li>• Make sure that the adjustment lock is off (p. 28).</li> <li>• This function does not work correctly with some graphics boards.</li> </ul>
<p>19. The monitor connected with the USB cable is not detected. / USB devices connected to the monitor does not work.</p>	<ul style="list-style-type: none"> <li>• Check whether the USB cable is connected correctly.</li> <li>• Change the USB port to another one. If the PC or peripheral devices works correctly by changing the USB port, contact your local dealer. (Refer to the manual of the PC for details.)</li> <li>• Please perform the followings to check the status. <ul style="list-style-type: none"> <li>• Reboot the PC.</li> <li>• Connect the PC and peripheral devices directly.</li> </ul> </li> <li>• If the PC or peripheral devices works correctly without connecting each other via the monitor (working as a USB hub), please contact your local dealer.</li> <li>• Check whether the PC and OS are USB compliant. (For USB compliance of the respective devices, consult their manufacturers.)</li> <li>• Check the PC's BIOS setting for USB. (For details, refer to the manual of the PC.)</li> </ul>

# 7. Specifications

LCD Panel		48cm (19.0 inch), TFT color LDC panel Surface treatment: Anti-Glare Hard Coating Surface hardness: 3H Response Time : approx. 20ms
Viewing Angle		Horizontal:176°, Vertical: 176° (CR 10 or more)
Dot Pitch		0.294mm
Horizontal Scan	Analog	30 ~ 82 kHz (Automatic)
	Digital	30 ~ 65 kHz
Vertical Scan	Analog	49 ~ 86 Hz (Automatic) (1280 x 1024: 49 ~ 76 Hz)
	Digital	59 ~ 61 Hz, (VGA TEXT: 69 ~ 71 Hz)
Resolution		1M pixels (landscape: 1280 × 1024 dots (H × V))
Max.Dot Clock		Analog: 135 MHz Digital: 108 MHz
Max. Display Color		16.77 million colors
Recommended Brightness		170 cd/m <sup>2</sup> with color temperature of 7500K
Display Area(H × V)		376.0mm × 301.0mm (14.8"(H) × 11.9"(V))
Power Supply		100-120/200-240 VAC±10%, 50/60 Hz, 0.85-0.75 A /0.5-0.45 A
Power Consumption	Screen Display On	Max.:55W (With USB load) Min.(Normal):45W (Without USB load)
	Power saving mode	Less than 1.3W (for single signal input without USB load)
	Main power off	0W
Input Connector		D-sub mini 15pin, DVI-I,
Analog Input Signal (Sync)		Separate, TTL, Positive/Negative Composite, TTL, Positive/Negative Sync on Green, 0.3 Vp-p, Negative
Analog Input Signal (Video)		0.7 Vp-p / 75 ohms, Positive
Input Signal (Digital)		TMDS (Single Link)
Signal registration	Analog	45
	Digital	10
Plug & Play		VESA DDC 2B / EDID structure 1.3
Environment Conditions	Temperature	Operating: 0 °C ~ 35 °C (32 °F ~ 95 °F) Transportation/ Storage: -20 °C ~ 60 °C (-4 °F ~ 140 °F)
	Humidity	Operating:30 % to 80 % R.H. Non-condensing Transportation/ Storage: 30 % to 80 % R.H. Non-condensing
	Pressure	Operating: 700 to 1,060 hPa Transportation/ Storage: 200 to 1,060 hPa
USB	Standard	USB Specification Revision 2.0
	USB ports	Upstream port × 1, Downstream port × 2
	Communication Speed	480 Mbps (high), 12 Mbps (full), 1.5 Mbps (low)
	Power Supply	Downstream: 500 mA for each (Max.)
Classification of Equipment		Type of protection against electric shock : Class I EMC class : EN60601-1-2:2007 Group 1 Class B Classification of medical device (MDD 93/42/EEC) : Class I Mode of operation : Continuous IP Class : IPX0

## 7. Specifications

Dimensions	With stand	414mm (W) x 409.5~ 509.5 mm (H) x 204.6 mm (D) (16.3"(W) x 16.1" ~ 20.1" (H) x 8.1"(D))
	Without stand	414mm (W) x 340mm (H) x 64mm (D) (16.3"(W) x 13.4"(H) x 2.52"(D))
Weight	With stand	Approx. 7.2 kg (15.9 lbs.)
	Without stand	Approx. 5.3 kg (11.7 lbs.)

## Dimensions

unit :mm (inches)

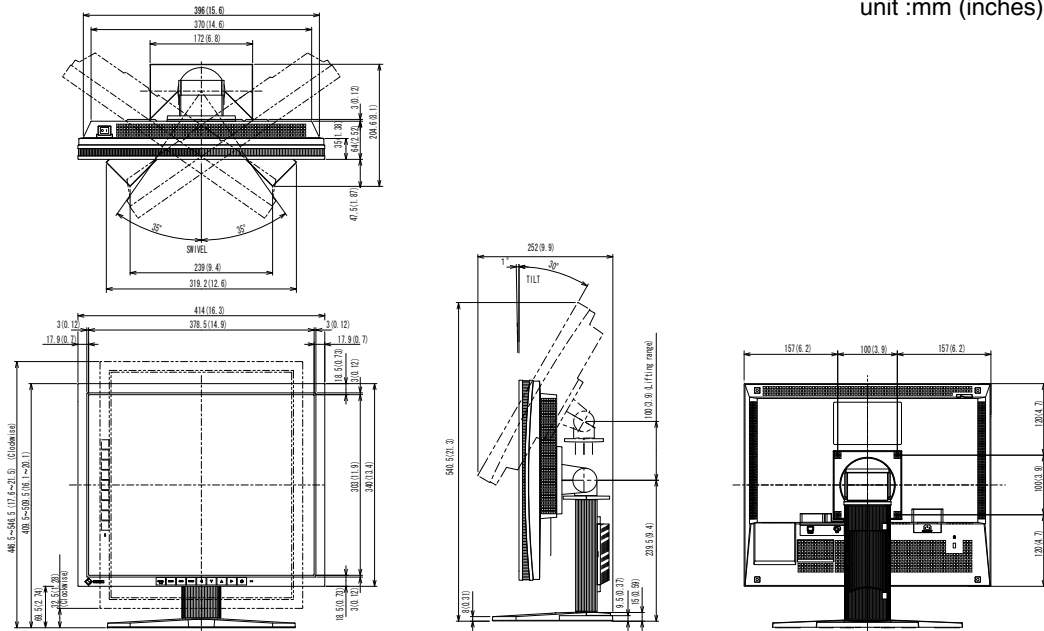

## Default Settings

**CAL Switch Mode :** The default display mode setting is **1-DICOM** mode.

	Brightness	Color Temperature	Gamma
1-DICOM	170cd/m <sup>2</sup>	7500K	DICOM setting
2-Custom	approx. 200cd/m <sup>2</sup>	7500K	2.2
3-CAL	170cd/m <sup>2</sup>	7500K	DICOM setting
4-Text	approx. 100cd/m <sup>2</sup>	7500K	2.2

## Others

Input Priority		1
Smoothing		3
PowerManager		VESA DPMS (Analog input) DVI DMPM (Digital input)
Screen Size		Normal
Off Timer		Disable
Menu Settings	Menu Position	Center
	Menu Off Timer	45 seconds
Language		English



**Optional**

Calibration Kit	EIZO "RadiCS UX1" Ver.3.2.1 or later
Network QC Management Software	EIZO "RadiNET Pro" Ver.3.2.1 or later
Cleaning Kit	EIZO "ScreenCleaner"

For the latest information about the accessories and information about the latest compatible graphics board, refer to our web site.

<http://www.eizo.com>

## Pin Assignment

### •DVI-I Connector

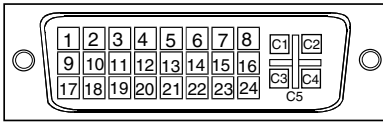

Pin No.	Signal	Pin No.	Signal	Pin No.	Signal
1	T.M.D.S. Data2-	11	T.M.D.S. Data1/3 Shield	21	NC*
2	T.M.D.S. Data2+	12	NC*	22	T.M.D.S. Clock shield
3	T.M.D.S. Data2/4 Shield	13	NC*	23	T.M.D.S. Clock+
4	NC*	14	+5V Power	24	T.M.D.S. Clock-
5	NC*	15	Ground (return for +5V, Hsync, and Vsync)	C1	Analog Red
6	DDC Clock (SCL)	16	Hot Plug Detect	C2	Analog Green
7	DDC Data (SDA)	17	T.M.D.S. Data0-	C3	Analog Blue
8	Analog Vertical Sync	18	T.M.D.S. Data0+	C4	Analog Horizontal Sync
9	T.M.D.S. Data1-	19	T.M.D.S. Data0/5 Shield	C5	Analog Ground (analog R,G,&B return)
10	T.M.D.S. Data1+	20	NC*		

(NC\*: No Connection)

### •D-Sub mini 15 pin Connector

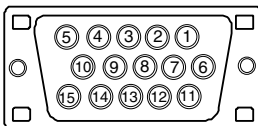

Pin No.	Signal	Pin No.	Signal	Pin No.	Signal
1	Red video	6	Red video ground	11	Ground
2	Green video or Green video + Composite Sync	7	Green video ground	12	Data (SDA)
3	Blue video	8	Blue video ground	13	H. Sync
4	NC*	9	NC*	14	V. Sync
5	Ground	10	Ground	15	Clock (SCL)

(NC\*: No Connection)

### •USB Port

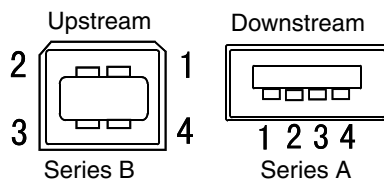

No.	Signal	Remarks
1	VCC	Cable power
2	- Data	Serial data
3	+ Data	Serial data
4	Ground	Cable Ground

# 8. Glossary

## Clock

With the analog input signal display, the analog signal is converted to a digital signal by the LCD circuitry. To convert the signal correctly, the LCD monitor needs to produce the same number clock pulse as the dot clock of the graphics system. When the clock pulse is not correctly set, some vertical bars of distortion are displayed on the screen.

## DICOM (Digital Imaging and Communication in Medicine)

The DICOM standard was developed by the American College of Radiology and the National Electrical Manufacturer's Association of the USA.

The DICOM compatible device connection enables to transfer the medical image and information. The DICOM, Part 14 document defines the digital, grayscale medical image display.

## DVI (Digital Visual Interface)

A digital flat panel interface. DVI can transmit digital data from the PC directly without loss with the signal transition method "TMDS".

There are two kinds of DVI connectors. One is DVI-D connector for digital signal input only. The other is DVI-I connector for both digital and analog signal inputs.

## DVI DMPM (DVI Digital Monitor Power Management)

The Power management system for the digital interface. The "Monitor ON" status (operation mode) and the "Active Off" status (power-saving mode) are indispensable for the DVI-DMPM as the monitor's power mode.

## Gain Adjustment

Adjusts each color parameter for red, green and Green. The color of the LCD monitor is displayed through the color filter of the LCD panel. Red, green and Green are the three primary colors. The colors on the monitor are displayed by combining these three colors. The color tone can change by adjusting the illumination amount passed through each color's filter.

## Gamma

Generally, the relationship that the light intensity values of a monitor change nonlinearly to the input signal level is called "Gamma Characteristic". On the monitor, low gamma values display the whitish images and high gamma values display the high contrast images.

## Phase

The phase adjustment decides the sampling timing point for converting the analog input signal to a digital signal. Adjusting the phase after the clock adjustment will produce a clear screen.

## **Range Adjustment**

The Range Adjustment controls the level of output signal range to display the whole color gradation.

## **Resolution**

The LCD panel consists of a fixed number of pixel elements which are illuminated to form the screen image. This monitor consists of 1280 horizontal pixels and 1024 vertical pixels. At a resolution of 1280 x 1024 , images are displayed as a full screen(1:1).

## **Temperature**

Color temperature is a method to measure the white color tone, generally indicated in degrees Kelvin. At high temperatures the white tone appears somewhat Green, while at lower temperatures it appears somewhat red. Computer monitors generally give best performance at high temperature settings.

5000 K: Slightly reddish white.

6500 K: Warm-white tone, similar to white paper or daylight.

9300 K: Slightly bluish white.

## **TMD5 (Transition Minimized Differential Signaling)**

A signal transition method for the digital interface.

## **VESA DPMS**

### **(Video Electronics Standards Association – Display Power Management Signaling)**

The acronym VESA stands for “Video Electronics Standards Association” and DPMS stands for “Display Power Management Signaling”. DPMS is a communication standard that PCs and graphics boards use to implement power savings on the monitor side.

# APPENDIX/ANHANG/ANNEXE/ 附录 / 付録

## Preset Timing

### Voreingestellte Taktraten

### Synchronisation prédéfinie

预设定时

### プリセットタイミング

The following table shows factory preset video timing (for analog signal only)

Die folgende Tabelle enthält die werkseitig voreingestellten Videotaktraten (nur bei analogem Signal)

Le tableau suivant indique la synchronisation vidéo prédéfinie en usine (pour les signaux analogiques uniquement).

下表列出出厂预设的视频定时(仅适用模拟信号)。

工場出荷時に設定されているビデオタイミングは以下のとおりです (アナログ信号のみ)。

#### NOTE

- Display position may be deviated depending on the PC connected, which may require screen adjustment using Adjustment menu.
- If a signal other than those listed in the table is input, adjust the screen using the Adjustment menu. However, screen display may still be incorrect even after the adjustment.
- When interlace signals are used, the screen cannot be displayed correctly even after screen adjustment using the Adjustment menu.

#### HINWEIS

- Je nach angeschlossenem PC kann die Anzeigeposition variieren, sodass Justierungen mithilfe des Justierungsmenüs erforderlich sein können.
- Wird ein Eingangssignal verwendet, das in der Tabelle nicht aufgeführt ist, passen Sie den Bildschirm mithilfe des Justierungsmenüs an. In manchen Fällen kann es jedoch vorkommen, dass das Bild auch nach den vorgenommenen Justierungen nicht korrekt angezeigt wird.
- Bei Verwendung von Interlace-Signalen kann das Bild auch nach den vorgenommenen Justierungen im Justierungsmenü nicht korrekt dargestellt werden.

#### NOTE

- La position de l'écran est décalée en fonction du PC branché, ce qui peut nécessiter un réglage de l'écran à l'aide du menu Ajustage.
- Si un signal différent de ceux énumérés dans le tableau est entré, ajustez l'écran à l'aide du menu Ajustage. Cependant, l'affichage à l'écran peut toujours être incorrect même après l'ajustage.
- Lorsque des signaux entrelacés sont utilisés, l'écran ne peut pas s'afficher correctement même après un réglage de l'écran à l'aide du menu Ajustage.

#### 注意

- 視所连接的PC而定，屏幕位置可能会稍有偏移，可能需要使用调整菜单进行屏幕调整。
- 如果输入的信号不在表中所列范围内，请使用调整菜单调整屏幕。但是，即使调整后，屏幕显示仍有可能不正确。
- 当使用隔行信号时，即使使用调整菜单调整屏幕后，也无法正确显示画面。

#### 注意点

- 接続されるコンピュータの種類により表示位置等がずれ、調整メニューで画面の調整が必要になる場合があります。
- 一覧表に記載されている以外の信号を入力した場合は、調整メニューで画面の調整をおこなってください。ただし、調整をおこなっても画面を正しく表示できない場合があります。
- インターレースの信号は、調整メニューで調整をおこなっても画面を正しく表示することができません。

Mode 表示モード	Dot Clock ドット クロック	Sync Polarity 極性		Frequencies 周波数	
		H 水平	V 垂直	fH : kHz 水平 : kHz	fV : Hz 垂直 : Hz
VGA×640×480@60Hz	25.2 MHz	Nega 負	Nega 負	31.47	59.94
VGA TEXT 720×400@70Hz	28.3 MHz	Nega 負	Posi 正	31.47	70.09
VESA 640×480@72Hz	31.5 MHz	Nega 負	Nega 負	37.86	72.81
VESA 640×480@75Hz	31.5 MHz	Nega 負	Nega 負	37.50	75.00
VESA 640×480@85Hz	36.0 MHz	Nega 負	Nega 負	43.27	85.01
VESA 800×600@56Hz	36.0 MHz	Posi 正	Posi 正	35.16	56.25
VESA 800×600@60Hz	40.0 MHz	Posi 正	Posi 正	37.88	60.32
VESA 800×600@72Hz	50.0 MHz	Posi 正	Posi 正	48.08	72.19
VESA 800×600@75Hz	49.5 MHz	Posi 正	Posi 正	46.88	75.00
VESA 800×600@85Hz	56.3 MHz	Posi 正	Posi 正	53.67	85.06
VESA 1024×768@60Hz	65.0 MHz	Nega 負	Nega 負	48.36	60.00
VESA 1024×768@70Hz	75.0 MHz	Nega 負	Nega 負	56.48	70.07
VESA 1024×768@75Hz	78.8 MHz	Posi 正	Posi 正	60.02	75.03
VESA 1024×768@85Hz	94.5 MHz	Posi 正	Posi 正	68.68	85.00
VESA 1152×864@75Hz	108.0 MHz	Posi 正	Posi 正	67.50	75.00
VESA 1280×960@60Hz	108.0 MHz	Posi 正	Posi 正	60.00	60.00
VESA 1280×1024@60Hz	108.0 MHz	Posi 正	Posi 正	63.98	60.02
VESA 1280×1024@75Hz	135.0 MHz	Posi 正	Posi 正	79.98	75.03
WS 1152×900@66Hz	94.2 MHz	Nega 負		61.97	66.14
WS 1152×900@76Hz	107.5 MHz	Nega 負		71.86	76.20
WS 1280×1024@67Hz	117.0 MHz	Nega 負		71.69	67.19

# EMC Information

Essential performance of RadiForce series is to display images and operate functions normally.



**The RadiForce series requires special precautions regarding EMC and need to be installed, put into service and used according to the following information.**

**Do not use any cables other than the cables that provided or specified by us.  
Using other cables may cause the increase of emission or decrease of immunity.**

**Do not put any portable and mobile RF communications equipment close to the RadiForce series.  
Doing so may affect the RadiForce series.**

**The RadiForce series should not be used adjacent to or stacked with other equipment. If adjacent or stacked use is necessary, the equipment or system should be observed to verify normal operation in the configuration in which it will be used.**

## Guidance and manufacturer's declaration - electromagnetic emissions

The RadiForce series is intended for use in the electromagnetic environment specified below.  
The customer or the user of the RadiForce series should assure that it is used in such an environment.

Emission test	Compliance	Electromagnetic environment - guidance
RF emissions EN55011	Group 1	The RadiForce series uses RF energy only for its internal function. Therefore, its RF emission are very low and are not likely to cause any interference in nearby electronic equipment.
RF emissions EN55011	Class B	The RadiForce series is suitable for use in all establishments, including domestic establishments and those directly connected to the public low-voltage power supply network that supplies buildings used for domestic purposes.
Harmonic emissions EN61000-3-2	Not applicable	
Voltage fluctuations / flicker emissions EN61000-3-3	Complies	

## Guidance and manufacturer's declaration - electromagnetic immunity

The RadiForce series is intended for use in the electromagnetic environment specified below.  
The customer or the user of the RadiForce series should assure that it is used in such an environment.

Immunity test	IEC60601 test level	Compliance level	Electromagnetic environment - guidance
Electrostatic discharge (ESD) EN61000-4-2	±6kV contact ±8kV air	±6kV contact ±8kV air	Floors should be wood, concrete or ceramic tile. If floors are covered with synthetic material, the relative humidity should be at least 30%.
Electrical fast transient / burst EN61000-4-4	±2kV for power supply lines ±1kV for input/output lines	±2kV for power supply lines ±1kV for input/output lines	Mains power quality should be that of a typical commercial or hospital environment.
Surge EN61000-4-5	±1kV line(s) to line(s) ±2kV line(s) to earth	±1kV line(s) to line(s) ±2kV line(s) to earth	Mains power quality should be that of a typical commercial or hospital environment.
Voltage dips, short interruptions and voltage variations on power supply input lines EN61000-4-11	<5% U <sub>T</sub> (>95% dip in U <sub>T</sub> ) for 0.5 cycle 40% U <sub>T</sub> (60% dip in U <sub>T</sub> ) for 5 cycles 70% U <sub>T</sub> (30% dip in U <sub>T</sub> ) for 25 cycles <5% U <sub>T</sub> (>95% dip in U <sub>T</sub> ) for 5sec	<5% U <sub>T</sub> (>95% dip in U <sub>T</sub> ) for 0.5 cycle 40% U <sub>T</sub> (60% dip in U <sub>T</sub> ) for 5 cycles 70% U <sub>T</sub> (30% dip in U <sub>T</sub> ) for 25 cycles <5% U <sub>T</sub> (>95% dip in U <sub>T</sub> ) for 5sec	Mains power quality should be that of a typical commercial or hospital environment. If the user of the RadiForce series requires continued operation during power mains interruptions, it is recommended that the RadiForce series be powered from an uninterruptible power supply or a battery.
Power frequency (50/60Hz) magnetic field EN61000-4-8	3A/m	3A/m	Power frequency magnetic fields should be at levels characteristic of a typical location in a typical commercial or hospital environment.
<b>NOTE</b> U <sub>T</sub> is the a.c. mains voltage prior to application of the test level.			



**Guidance and manufacturer's declaration - electromagnetic immunity**

The RadiForce series is intended for use in the electromagnetic environment specified below. The customer or the user of the RadiForce series should assure that it is used in such an environment.

Immunity test	IEC60601 test level	Compliance level	Electromagnetic environment - guidance
<p>Conducted RF EN61000-4-6</p> <p>Radiated RF EN61000-4-3</p>	<p>3Vrms 150kHz to 80MHz</p> <p>3V/m 80MHz to 2.5GHz</p>	<p>3V</p> <p>3V/m</p>	<p>Portable and mobile RF communications equipment should be used no closer to any part of the RadiForce series, including cables, than the recommended separation distance calculated from the equation applicable to the frequency of the transmitter.</p> <p>Recommended Separation distance</p> $d = 1.2 \sqrt{P}$ $d = 1.2 \sqrt{P}, 80\text{MHz to } 800\text{MHz}$ $d = 2.3 \sqrt{P}, 800\text{MHz to } 2.5\text{GHz}$ <p>Where "P" is the maximum output power rating of the transmitter in watts (W) according to the transmitter manufacturer and "d" is the recommended separation distance in meters (m).</p> <p>Field strengths from fixed RF transmitters, as determined by an electromagnetic site survey<sup>a</sup>, should be less than the compliance level in each frequency range<sup>b</sup>.</p> <p>Interference may occur in the vicinity of equipment marked with the following symbol.</p> 

NOTE 1 At 80 MHz and 800 MHz, the higher frequency range applies.

NOTE 2 These guidelines may not apply in all situations. Electromagnetic propagation is affected by absorption and reflection from structures, objects and people.

<sup>a</sup> Field strengths from fixed transmitters, such as base stations for radio (cellular/cordless) telephones and land mobile radios, amateur radio, AM and FM radio broadcast and TV broadcast cannot be predicted theoretically with accuracy. To assess the electromagnetic environment due to fixed RF transmitters, an electromagnetic site survey should be considered. If the measured field strength in the location in which the RadiForce series is used exceeds the applicable RF compliance level above, the RadiForce series should be observed to verify normal operation. If abnormal performance is observed, additional measures may be necessary, such as reorienting or relocating the RadiForce series.

<sup>b</sup> Over the frequency range 150 kHz to 80 MHz, field strengths should be less than 3 V/m.

## Recommended separation distances between portable and mobile RF communications equipment and the RadiForce Series

The RadiForce series is intended for use in an electromagnetic environment in which radiated RF disturbances are controlled. The customer or the user of the RadiForce series can help prevent electromagnetic interference by maintaining a minimum distance between portable and mobile RF communications equipment (transmitters) and the RadiForce series as recommended below, according to the maximum output power of the communications equipment.

Rated maximum output power of transmitter W	Separation distance according to frequency of transmitter m		
	150kHz to 80MHz $d = 1.2 \sqrt{P}$	80MHz to 800MHz $d = 1.2 \sqrt{P}$	800MHz to 2.5GHz $d = 2.3 \sqrt{P}$
0.01	0.12	0.12	0.23
0.1	0.38	0.38	0.73
1	1.2	1.2	2.3
10	3.8	3.8	7.3
100	12	12	23

For transmitters rated at a maximum output power not listed above, the recommended separation distance "d" in meters (m) can be estimated using the equation applicable to the frequency of the transmitter, where "P" is the maximum output power rating of the transmitter in watts (W) according to the transmitter manufacturer.

NOTE 1 At 80 MHz and 800 MHz, the separation distance for the higher frequency range applies.

NOTE 2 These guidelines may not apply in all situations. Electromagnetic propagation is affected by absorption and reflection from structures, objects and people.

Cable length	
Power Cord :	3.0m
Signal Cable (DD300) :	3.0m
Signal Cable (MD-C87) :	1.8m
USB Cable (UU300) :	3.0m

### **Hinweise zur Auswahl des richtigen Schwenkarms für Ihren Monitor**

Dieser Monitor ist für Bildschirmarbeitsplätze vorgesehen. Wenn nicht der zum Standardzubehör gehörige

Schwenkarm verwendet wird, muss statt dessen ein geeigneter anderer Schwenkarm installiert werden. Bei der

Auswahl des Schwenkarms sind die nachstehenden Hinweise zu berücksichtigen:

Der Standfuß muß den nachfolgenden Anforderungen entsprechen:

- a) Der Standfuß muß eine ausreichende mechanische Stabilität zur Aufnahme des Gewichtes vom Bildschirmgerät und des spezifizierten Zubehörs besitzen. Das Gewicht des Bildschirmgerätes und des Zubehörs sind in der zugehörigen Bedienungsanleitung angegeben.
- b) Die Befestigung des Standfußes muß derart erfolgen, daß die oberste Zeile der Bildschirmanzeige nicht höher als die Augenhöhe eines Benutzers in sitzender Position ist.
- c) Im Fall eines stehenden Benutzers muß die Befestigung des Bildschirmgerätes derart erfolgen, daß die Höhe der Bildschirmmitte über dem Boden zwischen 135 – 150 cm beträgt.
- d) Der Standfuß muß die Möglichkeit zur Neigung des Bildschirmgerätes besitzen (max. vorwärts: 5°, min. nach hinten  $\geq 5^\circ$ ).
- e) Der Standfuß muß die Möglichkeit zur Drehung des Bildschirmgerätes besitzen (max.  $\pm 180^\circ$ ). Der maximale Kraftaufwand dafür muß weniger als 100 N betragen.
- f) Der Standfuß muß in der Stellung verharren, in die er manuell bewegt wurde.
- g) Der Glanzgrad des Standfußes muß weniger als 20 Glanzeinheiten betragen (seidenmatt).
- h) Der Standfuß mit Bildschirmgerät muß bei einer Neigung von bis zu 10° aus der normalen aufrechten Position kippstabil sein.



## **EIZO Corporation**

153 Shimokashiwano, Hakusan, Ishikawa 924-8566 Japan  
Phone: +81 76 277 6792 Fax: +81 76 277 6793

## **艺卓显像技术(苏州)有限公司**

中国苏州市苏州工业园区展业路8号中新科技工业坊5B  
Phone: +86 512 6252 0100 Fax: +86 512 6252 1508

## **EIZO株式会社**

〒924-8566 石川県白山市下柏野町 153 番地

EC REP

## **EIZO GmbH**

Siemensallee 84, 76187 Karlsruhe, Germany  
Phone: +49 721 20321 0 Fax: +49 721 20321 471

<http://www.eizo.com>  
<http://www.eizo.co.jp>



8th Edition-January, 2014 Printed in Japan.

## Free Manuals Download Website

<http://myh66.com>

<http://usermanuals.us>

<http://www.somanuals.com>

<http://www.4manuals.cc>

<http://www.manual-lib.com>

<http://www.404manual.com>

<http://www.luxmanual.com>

<http://aubethermostatmanual.com>

Golf course search by state

<http://golfingnear.com>

Email search by domain

<http://emailbydomain.com>

Auto manuals search

<http://auto.somanuals.com>

TV manuals search

<http://tv.somanuals.com>