

# User's Manual

# ColorEdge® CG19

## Calibration Color LCD Monitor

### Important

Please read this User's Manual carefully to familiarize yourself with safe and effective usage procedures. Please retain this manual for future reference.

This manual is checked under the browser settings shown below. Text size can change for another one through browser setting.

#### **Microsoft Internet Explorer:**

Text size: Medium

Encoding: Western European

## SAFETY SYMBOLS



## PRECAUTIONS

## 1. INTRODUCTION

### 1-1.Features

### 1-2.Package Contents

### 1-3.Controls & Connectors

## 2. CABLE CONNECTION

### 2-1.Before Connecting

### 2-2.Connecting the Signal Cable (D-Sub or DVI)

### 2-3.Connecting the Signal Cable (ADC)

### 2-4.Connecting Two PCs to the Monitor

### 2-5.How to remove the Tilt Stand

## 3. ScreenManager

### 3-1.How to use the ScreenManager

### 3-2.ScreenManager Adjustments and Settings

### 3-3.FineContrast

### 3-4.Useful Functions

## 4. ADJUSTMENT

### 4-1.Screen Adjustment

### 4-2.Displaying a low resolution

### 4-3.Color Adjustment

### 4-4.Power-save Setup

## 5. MAKING USE OF USB (Universal Serial Bus)

## 6. TROUBLESHOOTING

## 7. CLEANING

---

## 8. SPECIFICATION

---

## 9. GLOSSARY

---

### APPENDIX/ ANHANG/ ANNEXE

---

About TCO'03 (Applicable to  
gray)





About TCO'99 (Applicable to  
black)

FCC Declaration of  
Conformity

Hinweis zur Ergonomie /  
Recycle Auskunft / Hinweise  
zur Auswahl des richtigen  
Schwenkarms für Ihren  
Monitor

## SAFETY SYMBOLS

This manual uses the safety symbols below. They denote critical information. Please read them carefully.

	<b>WARNING</b>  Failure to abide by the information in a <b>WARNING</b> may result in serious injury and can be life threatening.
	<b>CAUTION</b>  Failure to abide by the information in a <b>CAUTION</b> may result in moderate injury and/or property or product damage.
	Indicates a prohibited action.
	Indicates to ground for safety.

---

Copyright© 2004 EIZO NANA O CORPORATION All rights reserved.

No part of this manual may be reproduced, stored in a retrieval system, or transmitted, in any form or by any means, electronic, mechanical, or otherwise, without the prior written permission of EIZO NANA O CORPORATION.

EIZO NANA O CORPORATION is under no obligation to hold any submitted material or information confidential unless prior arrangements are made pursuant to EIZO NANA O CORPORATION's receipt of said information. Although every effort has been made to ensure that this manual provides up-to-date information, please note that EIZO monitor specifications are subject to change without notice.

---

ENERGY STAR is a U.S. registered mark.

Apple and Macintosh are registered trademarks of Apple Computer, Inc.

VGA is a registered trademark of International Business Machines Corporation.

DPMS is a trademark and VESA is a registered trademark of Video Electronics Standards Association.

Windows is a registered trademark of Microsoft Corporation.

PowerManager is a trademark of EIZO NANA O CORPORATION.

ScreenManager, ColorEdge and EIZO are registered trademarks of EIZO NANAO CORPORATION in Japan and other countries.

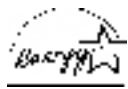

As an ENERGY STAR® Partner, EIZO NANAO CORPORATION has determined that this product meets the ENERGY STAR guidelines for energy efficiency.

## PRECAUTIONS

### IMPORTANT!

- This product has been adjusted specifically for use in the region to which it was originally shipped. If operated outside the region to which it was originally shipped, the product may not perform as stated in the specifications.
- To ensure personal safety and proper maintenance, please read this section and the caution statements on the unit (refer to the figure below).

#### [Location of the Caution Statements]

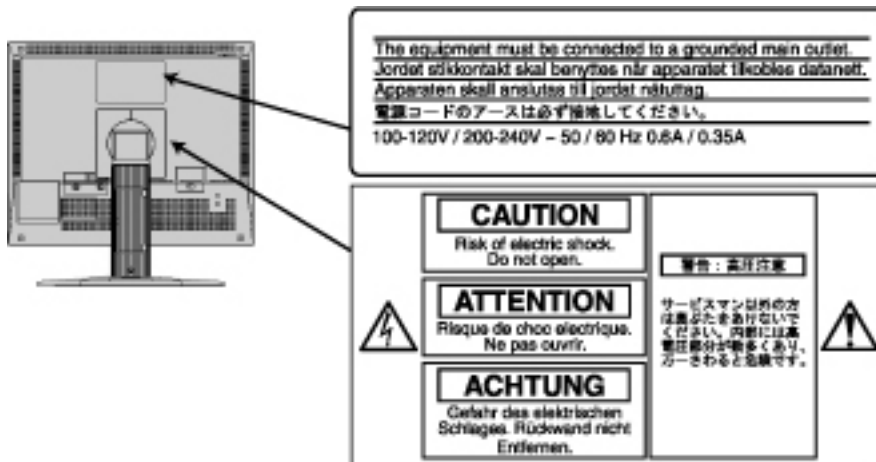

## WARNING

**If the unit begins to emit smoke, smells like something is burning, or makes strange noises, disconnect all power connections immediately and contact your dealer for advice.**

Attempting to use a malfunctioning unit may result in fire, electric shock, or equipment damage.

**Do not open the cabinet or modify the unit.**

Opening the cabinet or modifying the unit may result in fire, electric shock, or burn.



## Refer all servicing to qualified service personnel.

Do not attempt to service this product yourself as opening or removing covers may result in fire, electric shock, or equipment damage.

---

## Keep small objects or liquids away from the unit.

Small objects accidentally falling through the ventilation slots into the cabinet or spillage into the cabinet may result in fire, electric shock, or equipment damage.

If an object or liquid falls/spills into the cabinet, unplug the unit immediately. Have the unit checked by a qualified service engineer before using it again.



## Place the unit at the strong and stable place.

A unit placed on an inadequate surface may fall and result in injury or equipment damage.

If the unit falls, disconnect the power immediately and ask your dealer for advice. Do not continue using a damaged unit. Using a damaged unit may result in fire or electric shock.



## Set the unit in an appropriate location.

Not doing so may result in fire, electric shock, or equipment damage.

- Do not place outdoors.
- Do not place in the transportation system (ship, aircraft, trains, automobiles, etc.)
- Do not place in a dusty or humid environment.
- Do not place in a location where the steam comes directly on the screen.
- Do not place near heat generating devices or a humidifier.



**To avoid danger of suffocation, keep the plastic packing bags away from babies and children.**



---

**Use the enclosed power cord and connect to the standard power outlet of your country.**

Be sure to remain within the rated voltage of the power cord.  
Not doing so may result in fire or electric shock.

---

**To disconnect the power cord, grasp the plug firmly and pull.**

Tugging on the cord may damage and result in fire or electric shock.



---

**The equipment must be connected to a grounded main outlet.**

Not doing so may result in fire or electric shock.



---

**Use the correct voltage.**

\* The unit is designed for use with a specific voltage only. Connection to another voltage than specified in this User's Manual may cause fire, electric shock, or equipment damage.

\* Do not overload your power circuit, as this may result in fire or electric shock.

---

**Handle the power cord with care.**

\* Do not place the cord underneath the unit or other heavy objects.

\* Do not pull on or tie the cord.



If the power cord becomes damaged, stop using it. Use of a damaged cord may result in fire or electric shock.

---

**Never touch the plug and power cord if it begins to thunder.**

Touching them may result in electric shock.



---

**When attaching an arm stand, please refer to the user's manual of the arm stand and install the unit securely with the enclosed screws.**

Not doing so may cause the unit to become unattached, which may result in injury or equipment damage. When the unit is dropped, please ask your dealer for advice. Do not continue using a damaged unit. Using a damaged unit may result in fire or electric shock. When reattaching the tilt stand, please use the same screws and tighten them securely.

---

**Do not touch a damaged LCD panel directly with bare hands.**

The liquid crystal that may leak from the panel is poisonous if it enters the eyes or mouth.

If any part of the skin or body comes in direct contact with the panel, please wash thoroughly. If some physical symptoms result, please consult your doctor.



---

**Follow local regulation or laws for safe disposal.**

The backlight of the LCD panel contains mercury.

 **CAUTION**

**Handle with care when carrying the unit.**

Disconnect the power cord and cables when moving the unit. Moving the unit with the cord attached is dangerous. It may result in injury.

---

**When handling the unit, grip the bottom of the unit firmly with both hands ensuring the panel faces outward before lifting.**

Dropping the unit may result in injury or equipment damage.





---

**Do not block the ventilation slots on the cabinet.**

- \* Do not place any objects on the ventilation slots.
- \* Do not install the unit in a closed space.
- \* Do not use the unit laid down or upside down.



Blocking the ventilation slots prevents proper airflow and may result in fire, electric shock, or equipment damage.

---

**Do not touch the plug with wet hands.**

Doing so may result in electrical shock.



---

**Use an easily accessible power outlet.**

This will ensure that you can disconnect the power quickly in case of a problem.

---

**Periodically clean the area around the plug.**

Dust, water, or oil on the plug may result in fire.

---

**Unplug the unit before cleaning it.**

Cleaning the unit while it is plugged into a power outlet may result in electric shock.

**If you plan to leave the unit unused for an extended period, disconnect the power cord from the wall socket after turning off the power switch for the safety and the power conservation.**

In order to suppress the luminosity change by long-term use and to maintain the stable luminosity, use of a monitor in lower brightness is recommended.

---

The screen may have defective pixels. These pixels may appear as slightly light or dark area on the screen. This is due to the characteristics of the panel itself, and not the product.

---

The backlight of the LCD panel has a fixed life span. When the screen becomes dark or begins to flicker, please contact your dealer.

---

Do not press on the panel or edge of the frame strongly, as this may result in damage to the screen. There will be prints left on the screen if the pressed image is dark or black. If pressure is repeatedly applied to the screen, it may deteriorate or damage your LCD panel. Leave the screen white to decrease the prints.

---

Do not scratch or press on the panel with any sharp objects, such as a pencil or pen as this may result in damage to the panel. Do not attempt to brush with tissues as this may scratch the LCD panel.

# 1. INTRODUCTION

Thank you very much for choosing an EIZO Color Monitor.

## 1-1. Features

- The exclusive use calibration software calibrates the monitor characteristics and generate colorprofile.
- Dual inputs compliant
- [DVI](#) Digital input ([TMDS](#)) compliant.
- ADC (Apple Display Connector) inputs compliant.
- [Horizontal scanning frequency]  
Analog: 30 - 82 kHz  
Digital: 30 - 65 kHz  
[Vertical scanning frequency]  
Analog: 49 - 86 Hz Vertical (1280 x 1024: 49 - 75 Hz)  
Digital: 59 - 61 Hz (VGA text: 69 - 71 Hz))  
[Resolution] 1280 dots x 1024 lines
- Support to [sRGB](#) standard
- The height adjustable stand incorporated
- Ultra slim bezel incorporated
- The Portrait/Landscape display capability
- Attaching the "Adjustment Certificate" to describe the monitor color characteristics individually.

## 1-2. Package Contents

Please contact your local dealer for assistance if any of the listed items are missing or damaged.

- \* LCD Monitor
- \* Power Cord
- \* Signal Cable (FD-C35/FD-C39)
- \* Signal Cable (FD-C16)
- \* EIZO USB Cable (MD-C93)
- \* EIZO LCD Utility Disk
- \* User's Manual (in the CD-ROM)
- \* Calibration software  
"ColorNavigator" (in the CD-ROM)
- \* Setup Guide
- \* ColorNavigator Quick Reference
- \* LIMITED WARRANTY
- \* Adjustment Certificate

**NOTE**

- \* Please retain the packing materials for future transference.

## 1-3. Controls & Connectors

### Front

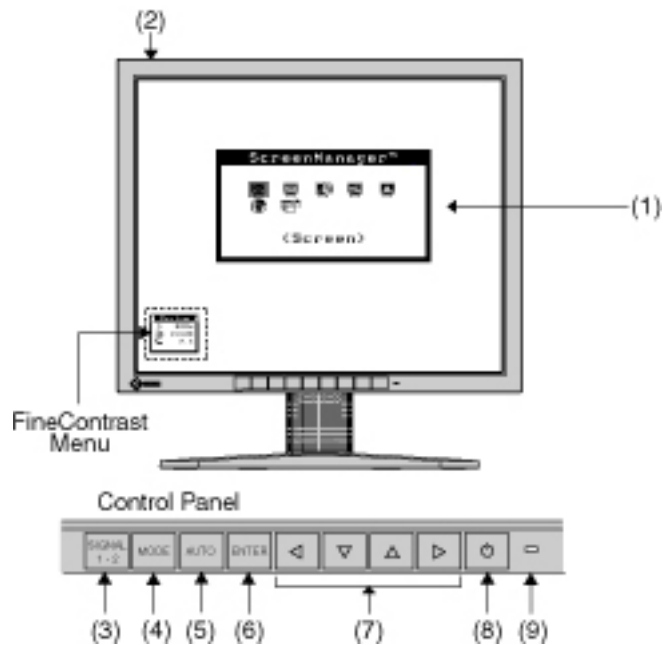

- (1) ScreenManager®
- (2) Main Power Switch
- (3) Input Signal Selection Button
- (4) Mode Button\*<sup>1</sup>
- (5) Auto Adjustment Button
- (6) Enter Button
- (7) Control Buttons (Up, Down, Left, Right)\*<sup>2</sup>
- (8) Power Button
- (9) Power Indicator\*<sup>3</sup>

Blue	Operation
Yellow	Power saving
Flashing yellow (2 times for each)	Power save mode Digital only
Flashing yellow slowly	Power is off (Main power is on)
Off	Power off

- \*<sup>1</sup> Pressing the Mode button once allows you to display a FineContrast menu. Pressing the Mode button more than once allows you to select a FineContrast mode. (The main menu of ScreenManager and the FineContrast menu cannot be displayed at the same time.)
- \*<sup>2</sup> These buttons are changed to Up, Left, Right, Down in case of selecting "Portrait" for <Orientation> of ScreenManager <Others>.
- \*<sup>3</sup> Blue lighting, when the screen is displayed (Operation mode), is made to non-light, see "[Power Indicator](#)"
- Regarding the power indicator for the "Off Timer", see "[3-4. Useful Functions](#)".

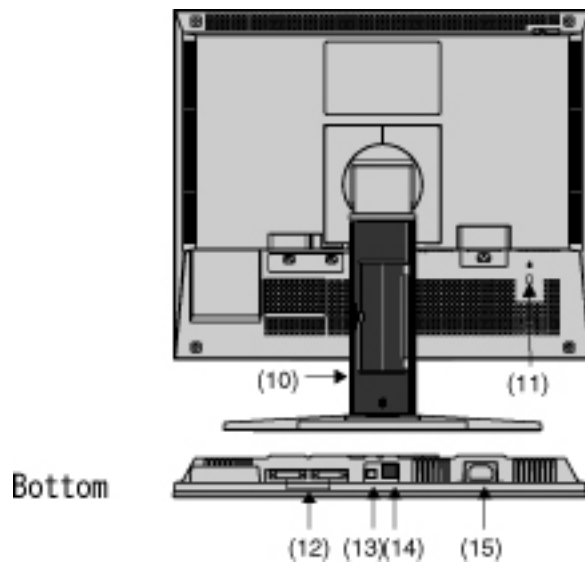

- (10) Height Adjustable Stand (Detachable)\*<sup>4</sup>
- (11) Security Lock Slot\*<sup>5</sup>
- (12) DVI-I Input Connector (SIGNAL 1, SIGNAL 2)
- (13) USB Port (1 Upstream)
- (14) USB Port (2 Downstream)
- (15) Power Connector

\*<sup>4</sup> The LCD monitor has the capability of the Portrait/Landscape display. (The panel pivots in the clockwise direction 90°.) The LCD monitor can be used with an optional arm stand by removing the stand. (see "[2-5. How to remove the Tilt Stand](#)").

\*<sup>5</sup> Allows for connection of a security cable. This lock supports Kensington's MicroSaver security system.

For further information, please consult:

Kensington Technology Group  
2855 Campus Drive, San Mateo, CA 94403 USA  
Tel: 800-650-4242, x3348  
Intl: 650-572-2700, x3348 / Fax: 650-572-9675  
<http://www.kensington.com>

## 2. CABLE CONNECTION

### 2-1. Before Connecting

Before connecting your monitor to the PC, change the display screen settings ([resolution](#) and frequency) in accordance with the charts below.

#### NOTE

- \* When your computer and display support VESA DDC, the suitable resolution and the refresh rate are set by just plugging your display into the computer without any manual settings.

#### Analog Input

Resolution	Frequency	Dot Clock	Remarks
640 x 480	~ 85 Hz	135 MHz (Max.)	VGA, VESA
640 x 480	67 Hz		Apple Macintosh
720 x 400	70 Hz		VGA TEXT
720 x 480	60 Hz		VESA
800 x 600	~ 85 Hz		VESA
832 x 624	75 Hz		Apple Macintosh
1024 x 768	~ 85 Hz		VESA
1152 x 864	75 Hz		VESA
1152 x 870	75 Hz		Apple Macintosh
1152 x 900	~ 76 Hz		SUN WS
1280 x 960	60 Hz		VESA
1280 x 960	75 Hz		Apple Macintosh
1280 x 1024	~75 Hz		VESA
1280 x 1024	67 Hz		SUN WS

## Digital Input

The monitor supports the following resolutions only.

Resolution	Frequency	Dot Clock	Remarks
640 x 480	60 Hz	108 MHz (Max.)	VGA
720 x 400	70 Hz		VGA TEXT
720 x 480	60 Hz		VESA Safe Mode
800 x 600	60 Hz		VESA
1024 x 768	60 Hz		VESA
1280 x 1024	60 Hz		VESA

### 2-2. Connecting the Signal Cable (For the Computer Employing D-Sub or DVI Connector)

#### NOTE

\* Be sure that the power switches of both the PC and the monitor are OFF.

1. Plug the signal cable into the connector at the rear of the monitor and the other end of the cable into the video connector on the PC.

After connecting, secure the connection with the screw-in fasteners.

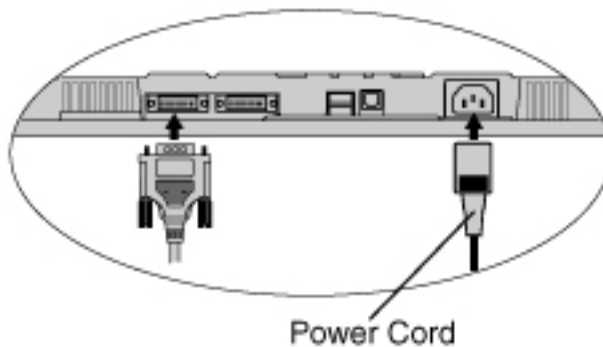

## Analog Input

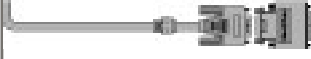

Signal Cable	Connector	PC
Signal Cable (FD-C16 enclosed) 	Video Output Connector D-Sub 15 pin Input Connector (monitor) / DVI	Standard graphics card Macintosh G3 (Blue & White) /Power Mac G4 (VGA)
Signal Cable (FD-C16 enclosed) + Macintosh Adapter (Optional) 	Video Output Connector D-Sub 15 pin Input Connector (monitor) / DVI	Macintosh

### Digital Input

Signal Cable	Connector	PC
Signal Cable (FD-C35/FD-C39 enclosed) 	Video Output Connector / DVI Input Connector (monitor) / DVI	Digital graphics card Power Mac G4 / G5 (DVI)

**2.Plug the power cord into the power connector on the rear of the monitor.**

**3.Lead the power cord and signal cable into the cable holder at rear of the monitor.**

**NOTE**

- \* The cables are recommended to lead with slight sag for the smooth motion of the stand and the Portrait/Landscape display.

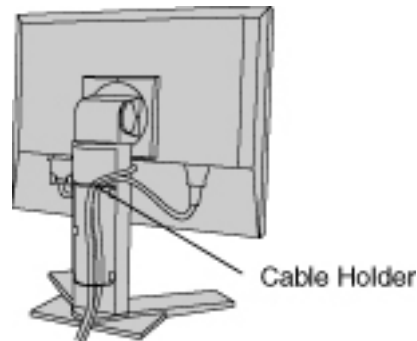
**4. Plug the other end of the power cord into a power outlet.**

The monitor's power indicator will flash yellow slowly.

** WARNING**

---

**Use the enclosed power cord and connect to the standard power outlet of your country.**

Be sure to remain within the rated voltage of the power cord. Not doing so may result in fire or electric shock.

---

**The equipment must be connected to a grounded main outlet.**



Not doing so may result in fire or electric shock.

---

## 5. Turn on the monitor's power button and then switch on the PC's power.

The monitor's power indicator will light up (blue).

If an image does not appear, refer to the "[6. TROUBLESHOOTING](#)" for advice.

Whenever finished, turn off the PC and the monitor.

### NOTE

- \* When turning on the monitor, the kind of the input signal (Signal1 or 2/Analog or Digital) is displayed for a few seconds on the right top corner of the screen.
- \* Adjust brightness of the screen depending on the brightness of your environment.
- \* Be sure to take adequate rests. A 10-minute rest period each hour is suggested.

## 2-3. Connecting the Signal Cable (For the Computer Employing ADC)

When connecting a Power Mac G4 / G5 through ADC (Apple Display Connector), change the input signal settings of monitor in advance to turn on the Power Mac.

### NOTE

- \* Be sure that the power switches of both the PC and the monitor are OFF.

## 1. Plug the signal cable into the connector at the rear of the monitor and the other end of the cable into the video connector on the PC.

After connecting, secure the connection with the screw-in fasteners.

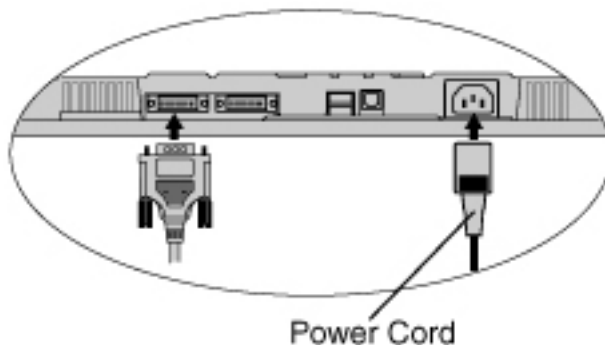

## To input the Signal through ADC

Signal Cable	Connector	PC
Signal Cable (FD-C35/FD-C39 enclosed) +ADC-DVI display adapter (commercially available)	Video Output Connector / ADC Input Connector (monitor) / DVI	Power Mac G4 / G5 (ADC)

**NOTE**

\* ADC-DVI display adapter is required if the monitor connects to Power Mac G4 / G5. The adapter is commercially available.

**2.Plug the power cord into the power connector on the rear of the monitor.**

**3.Lead the power cord and signal cable into the cable holder at rear of the monitor.**

**NOTE**

\* The cables are recommended to lead with slight sag for the smooth motion of the stand and the Portrait/Landscape display.

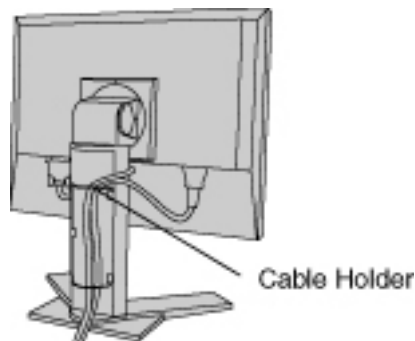

#### 4. Plug the other end of the power cord into a power outlet.

The monitor's power indicator will flash yellow slowly.

### WARNING

---

**Use the enclosed power cord and connect to the standard power outlet of your country.**

Be sure to remain within the rated voltage of the power cord. Not doing so may result in fire or electric shock.

---

**The equipment must be connected to a grounded main outlet.**



Not doing so may result in fire or electric shock.

---

#### 5. Press the power button while pressing the Input Signal Selection button.

The Input Selection menu is appeared on the screen.

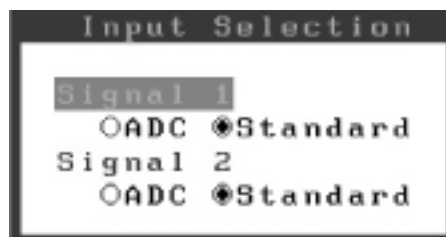
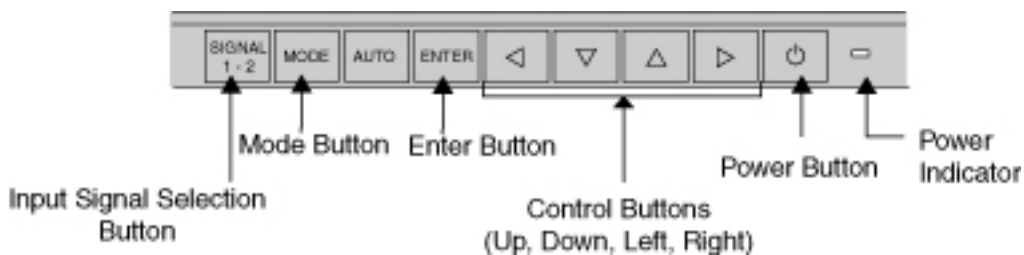

## 6. Change the input selection setting of the connector in the Input Selection menu to "ADC".

Press Enter button to complete the setting and the menu closes.

## 7. Switch on the PC's power.

The monitor's power indicator will light up (blue).

If an image does not appear, refer to the "[6. TROUBLESHOOTING](#)" for advice.

Whenever finished, turn off the PC and the monitor.







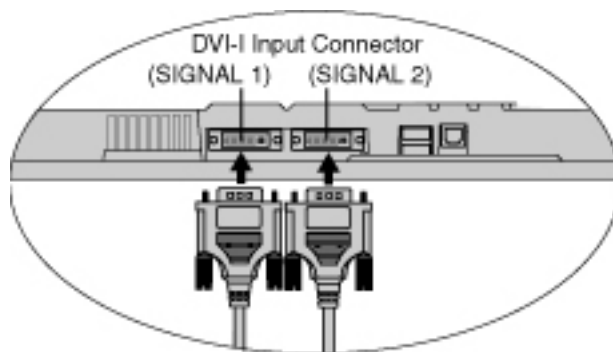

### NOTE

- \* When turning on the monitor, the kind of the input signal (Signal1 or 2/Analog or Digital) is displayed for a few seconds on the right top corner of the screen.
- \* Adjust brightness of the screen depending on the brightness of your environment.
- \* Be sure to take adequate rests. A 10-minute rest period each hour is suggested.
- \* When changing the signal connector except ADC, open the Input Selection menu again and change the setting to "Standard".
- \* To <Reset> the settings in the <Others> menu through ScreenManager, the settings of Input Selection will revert to the default setting.

## 2-4. Connecting two PCs to the Monitor

Two PCs can be connected to the monitor through DVI-I connector and D-sub mini 15 pin connector on the back of the monitor.



(EX.1)	Digital	ADC	Signal Cable (FD-C35 / FD-C39 enclosed) +ADC-DVI display adapter (commercially available) 	Signal Cable (FD-C16 enclosed) 	D-Sub mini 15 pin	Analog
(EX.2)	Digital	ADC	Signal Cable (FD-C35 / FD-C39 enclosed) +ADC-DVI display adapter (commercially available) 	Signal Cable (FD-C16 enclosed) + Macintosh Adapter (Optional) 	D-Sub 15 pin	Analog
(EX.3)	Digital	DVI-D	Signal Cable (FD-C35 / FD-C39 enclosed) 	Signal Cable (FD-C16 enclosed) 	D-Sub mini 15 pin	Analog
(EX.4)	Digital	DVI-D	Signal Cable (FD-C35 / FD-C39 enclosed) 	Signal Cable (FD-C16 enclosed) + Macintosh Adapter (Optional) 	D-Sub 15 pin	Analog

## Selecting the Active Input

The Input Signal Selection button on the control panel can be used to select either SIGNAL 1 or SIGNAL 2 as the active input at any time. Every time the button is pressed, the input changes. When switching the signal, the kind of the input signal (Signal 1 or 2/ Analog or Digital) is displayed for a few seconds on the right top corner of the screen.



## The Priority Input Signal

This function is used to select which PC will have priority to control the monitor when utilizing two PCs. The monitor constantly checks the input signals and switches automatically in accordance with the "Input Priority" setting (see table below). Once a priority is set, whenever a change of signal is detected at the selected input, the monitor will switch the input to that signal.

In this case of only one signal being present at either input, the monitor automatically detects and displays that signal.

<b>Priority Settings</b>	<b>Performance</b>
1 (SIGNAL1)	If signals from both inputs are present, the monitor gives preference of Signal 1 in the following cases. <ul style="list-style-type: none"><li>• When the power of the monitor is turned ON.</li><li>• When the signal input to Signal 1 is changed even if active input was Signal 2.</li></ul>
2 (SIGNAL2)	If signals from both inputs are present, the monitor gives preference to Signal 2 in the following cases. <ul style="list-style-type: none"><li>• When the power of the monitor is turned ON.</li><li>• When the signal input to Signal 2 is changed even if active input was Signal 1.</li></ul>



Manual	The monitor will not detect signals automatically in this mode. Select the active input by pressing the input signal selection button on the monitor's control panel.
--------	---

**NOTE**

- \* When "1" or "2" is selected, the power saving mode of the monitor activates only if both PCs are in power saving mode.

## 2-5. How to remove the Tilt Stand

The LCD monitor can be used with an arm by removing the tilt stand and attaching the arm or stand to the LCD monitor.

Using our optional arm or stand is recommended. (Ask your local dealer for information.)

**NOTE**

- \* If you will use the arm or stand of other manufacturers, confirm the followings to the manufacturers before selecting.
  - Hole spacing on the arm mounting: 100 mm x 100 mm (VESA compliant)
  - Supportable Weight: Total weight of the monitor (without stand) and attaching equipment such as a cable
  - TÜV/GS approved arm or stand
- \* Please connect cables after attaching an arm stand.

## Setup Procedure

**1. Hold the center of the stand mounting cover and slide them rightward or leftward to remove the mounting cover.**



**2. Lay the LCD monitor down. Do not scratch the panel.**

**3. Remove the tilt stand by loosening the screws. (4 pcs of M4 x 15 mm)**

**4. Attach an arm stand to the LCD monitor securely.**

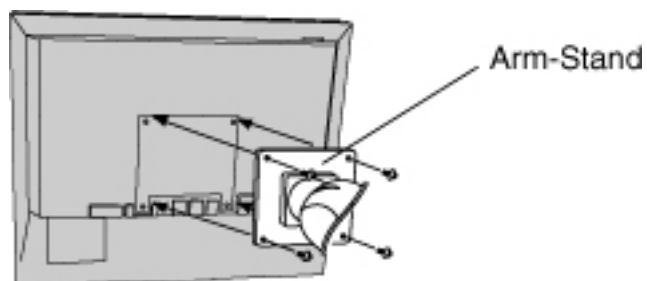

## 3. ScreenManager

### 3-1. How to use the ScreenManager

ScreenManager allows you to adjust screen performance through the main menu and select a FineContrast mode easily.

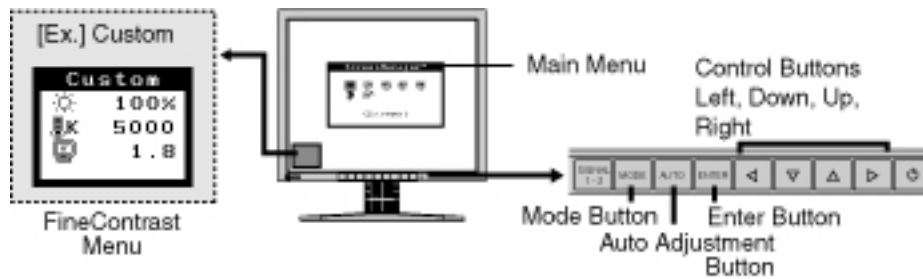

#### NOTE

\* Main Menu and FineContrast menu cannot be activated at the same time.

### 1. Entering the ScreenManager

Press the Enter button once to display the main menu of the ScreenManager.

### 2. Making Adjustments and Settings

- (1) Select the desired sub menu icon using the Control buttons and press the Enter button. The sub menu appears.
- (2) Use the Control buttons to select the desired setting icon and press the Enter button. The setting menu appears.
- (3) Use the Control buttons to make all required adjustments and press the Enter button to save the settings.

### 3.Exiting the ScreenManager

- (1) To return to the main menu, select the <Return> icon or press the Down button twice, followed by the Enter button.
- (2) To exit the ScreenManager, select <Exit> icon or press the Down button twice, followed by the Enter button.

#### NOTE

\* Double clicking the Enter button at any time also exits the ScreenManager menu.

#### FineContrast menu

Pressing the Mode button allows you to select the best suited mode for screen display from 3 FineContrast modes; Custom, sRGB and CAL. To exit the menu, press the Enter button.

### 3-2. ScreenManager Adjustments and Settings

The following table shows all the ScreenManager's adjustment and setting menus. "\*" indicates adjustments of analog input only and "\*\*\*" indicates digital input only.

Main menu	Sub menu	Reference
Screen	Clock	*
	Phase	*
	Position	*
	Resolution	*
	Range Adjustment	*
	Smoothing	
	Signal Filter	*
Color (Custom) *1	Brightness	
	Temperature	
	Gamma	
	Saturation	
	Hue	
	Gain	
	6 Colors	
		<a href="#">4-1. Screen Adjustment</a>
		<a href="#">4-3. Color Adjustment</a>

	Reset			
PowerManager	DVI DMPM	**	<a href="#">4-4. Power-save Setup</a>	
	VESA DPMS	*		
Others	Screen Size		<a href="#">4-2. Displaying a low resolutions</a>	
	Border Intensity			
	Input Priority		<a href="#">Select the priority input signal.</a>	
	Off Timer		<a href="#">Set the monitor's off timer to on or off.</a>	
	Beep		Set the monitor's beeper to on or off.	
	Menu Settings	Menu Size		Change the size of the menu.
		Menu Position		Adjust the menu position.
		Menu Off Timer		Set the menu displaying time. *2
		Translucent		Set the transparency of the background.
	Orientation		Change the orientation of the ScreenManager for monitor's portrait position.	
	Power Indicator		Make non-light for blue lighting when the screen is displayed (see " <a href="#">Power Indicator setting</a> ").	
Reset		<a href="#">Return to the factory default settings.</a>		
Information	Information		Review the ScreenManager's settings, model name, serial number and usage time. *3	
Language	English, German, French, Spanish, Italian, Swedish and Japanese		Select the ScreenManager's language.	

\*1 The adjustable functions on the <Color> menu depend on the selected FineContrast mode. The above table shows the sub menus when the "Custom" mode is selected (see "[4-3. Color Adjustment](#)").

\*2 The displaying time of the FineContrast menu cannot be changed.

\*3 Due to the inspection on the factory, the usage time may not "0 hour" at shipping.

### 3-3. FineContrast

This function allows you to select the best suited mode for screen display.

## To select the Mode

Pressing the Mode button allows you to select the best suited mode for screen display from 3 FineContrast modes; Custom, sRGB and CAL. Color settings each mode can be adjusted by using the <Color> menu of the ScreenManager.

## Exit

Press the Enter button to exit the menu.

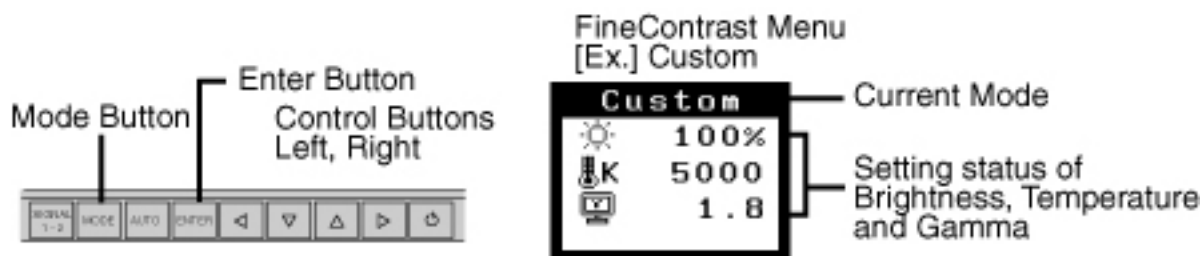

## FineContrast Mode

Selectable FineContrast modes are as follows.

Custom	To adjust the color settings according to your preference.
sRGB	To display the screen images based on those original colors (ex. over the Internet).
CAL	The mode only for calibration software

## Color Adjustment of the Mode Settings

<Brightness>, <Temperature> and <Gamma> settings can be adjusted on the FineContrast menu. Select the desired function icon with the Up/Down Control buttons and adjust with the Left/Right Control buttons. (Setting(s) of <Temperature> and/or <Gamma> is defined as standard default in some modes.

## Detailed Adjustments

The detailed color settings of each mode can be adjusted by using the <Color> menu of the ScreenManager.

### NOTE

\* "CAL" mode can be adjusted only by Calibration Software "ColorNavigator" .

## 3-4. Useful Functions

### Adjustment Lock

Use the "Adjustment Lock" function to prevent any accidental changes.

Locked function	<ul style="list-style-type: none"><li>• Settings in the ScreenManager</li><li>• Auto Adjustment Button</li></ul>
Unlocked function	<ul style="list-style-type: none"><li>• Selecting of the FineContrast mode by the Mode button / Adjustments</li><li>• Input Signal Selection Button</li></ul>

#### [To lock]

Switch off the monitor's power by the power button on the front control panel. Press on the Auto Adjustment button while switching on the monitor's power.

#### [To unlock]

Switch off the monitor's power by the power button on the front control panel, then hold Down the Auto Adjustment button once again and turn the power back on.

## Off Timer

The off timer function causes the monitor to automatically enter a power off state after a predetermined amount of time has lapsed. This function was created to reduce [afterimage](#) characteristics that are particular to LCD monitors when the monitor screen is left on for a long period without use.

### [Procedure]

- (1) Select <Off Timer> in the ScreenManager <Others> menu.
- (2) Select "Enable" and press the Right and Left buttons to adjust the "On Period" (1 to 23 hours).

### [Off Timer System]

PC	Monitor	Power Indicator
On Period (1H - 23H)	Operation	Blue
Last 15 min. in "On period"	Advance Notice *1	Blue Flashing
"On period" expired	Power off	Flashing yellow slowly

\*1 Advance notice (Power Indicator flashing blue) will be given 15 minutes before the monitor automatically enters the "Power Off" mode. To delay entering the "Power Off" mode, press the power button during the advance notice period. The monitor will continue to operate for an additional 90 minutes.

### [Power Resumption Procedure]

Press the power button to return a normal screen.

#### NOTE

\* The off timer function works while the PowerManager is active, but there is no advance notice before the monitor's power is switched off.



---

## **Power Indicator setting**

Light off the power indicator. This function is available for the multiple panels settings.

### **[Procedure]**

- (1) Select <Power Indicator> in the ScreenManager <Others> menu.
- (2) Select "Disable".

---

## **EIZO Logo Disappearing Function**

When switching on the power button on the front control panel, the EIZO logo is displayed for a while. If you desire to display or undisplay this logo, use this function. (Default is logo appearing.)

### **[To undisplay]**

Switch off the monitor's power by the power button, then hold Down the Enter button once again and turn the power back on.

### **[To display]**

Switch off the monitor's power by the power button, then hold Down the Enter button once again and turn the power back on.

---

## **Automatically Selecting the Input Signal Function**

The monitor will automatically detect the inputted signal of either the connection for display. (Default: this function is set ("Auto").)

### **Connecting Two PCs to the Monitor**

When the one computer is switched off or entering the power saving mode, the monitor will automatically display the other signal.

Use the ScreenManager to switch the input signal manually.

### **[Procedure]**

- (1) Select <Input Signal> in the <Others> menu.
- (2) Select <Manual>.

## 4. ADJUSTMENT

**The monitor displays the digital input image correctly based on its pre-setting data.**

### 4-1. Screen Adjustment

Screen adjustments for the LCD monitor should be used in suppressing screen flickering and also for adjusting the screen to its proper position. There is only one correct position for each display mode. It is also recommended to use the ScreenManager function when first installing the display or whenever changing the system. For convenience, an easy set-up program installed on the utility disk to assist in the set-up procedure is provided.

#### **NOTE**

- \* Allow the LCD monitor to stabilize for at least 20 minutes before making image adjustments.

#### **Adjustment Procedure**

##### **1. Push the Auto Adjustment Button on the control panel.**

The message "Your setting will be lost, if you press again now." appears and remains on the screen for 5 seconds. While the message is on the screen, press the Auto Adjustment button again to automatically adjust the clock, phase, screen position and resolution. If you do not wish to do adjust the screen, do not press the Auto Adjustment button again.

#### **NOTE**

- \* The Auto sizing function is intended for use on the Macintosh and on AT-compatible PC running Windows. It may not work properly in either of the following cases.  
When running an AT-compatible PC on MS-DOS (Not windows). The background color for the "wall paper" or "desktop" pattern is set to black.

**If the appropriate screen cannot be made by using the Auto Adjustment button, adjust the screen through the following procedures. If the appropriate screen can be made, proceed to [step 4](#).**

## 2.Run the "Screen Adjustment Program".

Having read the "Readme.txt" file, run the "Screen Adjustment Program" in the enclosed EIZO LCD Utility Disk. Step by step, adjustment is provided by the wizard guide. (If using the Windows, the program can be directly run from the menu screen of the CD-ROM.)

### NOTE

- \* If the user's operating system has no utility disk (e.g. OS/2), we recommend setting the desktop pattern to that as shown in the diagram on the following.

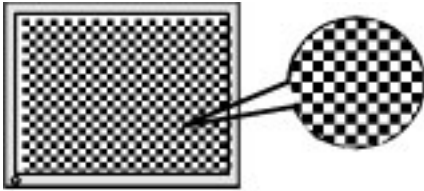

## 3.Adjust by using <Screen> menu in the ScreenManager.

### (1) Vertical bars appear on the screen

=>  Use the <Clock> adjustment.

Select the <Clock> and eliminate the vertical bars by using the Right and Left of the Control buttons.

Do not continuously press the Control buttons, as the adjustment value will change quickly and make it difficult to locate the most suitable adjustment point. If the horizontal flickering, blur or bars appear, proceed to <Phase> adjustment as follows.



**(2) Horizontal bars appear on the screen.**

=>  Use the **<Phase>** adjustment.

Select the <Phase> and eliminate the horizontal flickering, blurring or bars by using the Right and Left buttons.



**NOTE**

\* Horizontal bars may not completely disappear from the screen depending on the PC.

**(3) The screen position is incorrect.**

=>  Use the **<Position>** adjustment.

The correct displayed position of the monitor is decided because the number and the position of the pixels are fixed. The <Position> adjustment moves the image to the correct position.

Select <Position> and adjust the position by using the Up, Down, Right and Left buttons.

If vertical bars of distortion appear after finishing the <Position> adjustment, return to <Clock> adjustment and repeat the previously explained adjustment procedure. ("Clock" => "Phase" => "Position").

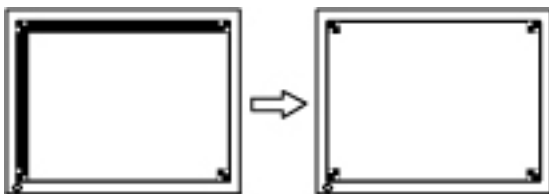

(4) **Screen image is smaller or larger than the actual screen images.**

=>  Use the **<Resolution>** adjustment.

Adjustment is needed when the input signal resolution and the resolution now being displayed are different.

Select **<Resolution>** and confirm if the resolution now being displayed is the same as the input resolution. If it is not, adjust the vertical resolution using the Up and Down button and adjust the horizontal resolution using the Right and Left buttons.

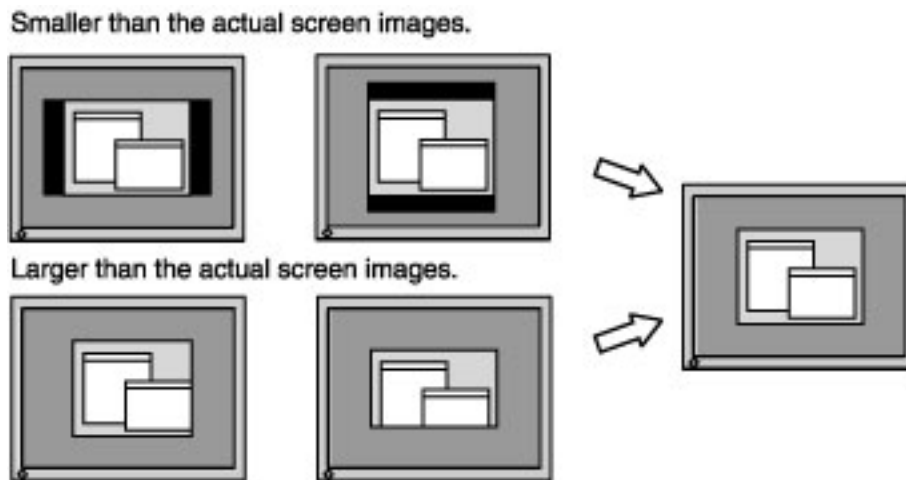

**4. Adjust the output signal range (Dynamic Range) of the signal.**

=>  Use the **<Range Adjustment>** of **<Screen>** menu.

This controls the level of output signal range to display the whole color gradation (256 colors).

**[Procedure]**

Select the **<Range Adjustment>** in the ScreenManager and press the Auto Adjustment button on the control panel to adjust the Range Adjustment.

The screen blanks for a moment and adjusts the color range to display the whole color gradation of the current output signal.

## 4-2. Displaying a Low Resolution

The lower resolutions are enlarged to full screen automatically. Using the **<Screen Size>** function in the **<Others>** menu enables to change the screen size.

## 1. Enlarge the screen size when displaying a low resolution.

=>  Select the <Screen Size>.

Select the <Screen Size> in the others menu and select the screen size by using the Up and Down buttons.

Menu	Function
Full	Displays the picture on the screen in full, irrespective of the picture's resolution. Since the vertical resolution and the horizontal resolution are enlarged at different rates, some image may appear distorted.
Enlarged	Displays the picture on the screen in full, irrespective of the picture's resolution. Since the vertical resolution and horizontal resolution are enlarged at the same rates, some horizontal or vertical image may disappear.
Normal	Displays the picture at the actual screen resolution.

Example: Displaying 1024 x 768

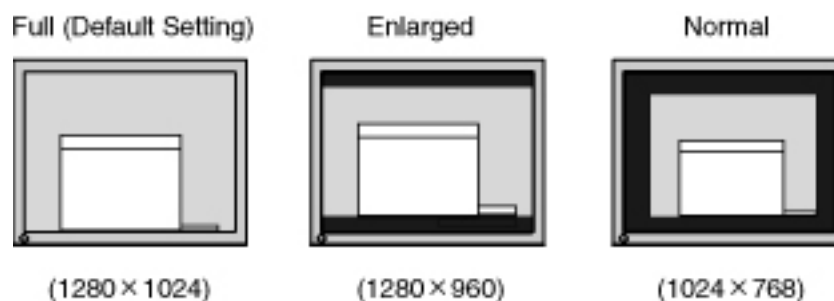

## 2. Smooth the blurred texts of the enlarged screen.

=>  Switch the <Smoothing> setting.

Select the suitable level 1-5 (Soft-Sharp).

Select <Smoothing> in the <Screen> menu and adjust by using the Right and Left buttons.

**NOTE**

\* <Smoothing> is disabled when the screen is displayed in the following resolutions.

- 1280 x 1024
- The image size is doubled both in horizontally and vertically to (i.e. 1280 x 960 enlarged from 640 x 480) provide clear focus which does not require this function.

### 3. Set the brightness of the black area surrounding the displayed image.

=>  Set the <Border Intensity>.

In the "Enlarge" mode or "Full Screen" mode, the outer area (border) is usually black. Select <Border Intensity> in the <Others> menu and adjust by using the Right and Left buttons.

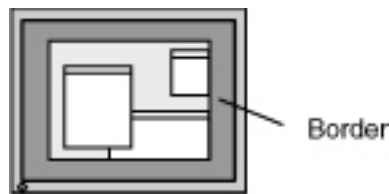

## 4-3. Color Adjustment

Color settings of each FineContrast mode can be adjusted and saved by using the <Color> menu of the ScreenManager.









In the analog input, perform the [<Range Adjustment>](#) before making the color adjustments.

### Adjustment Items

The adjustable items and displayed icons on the <Color> menu depend on the selected FineContrast mode.



"\*": Settable/Adjustable "-": Fixed at the factory



Icons	Functions	FineContrast Modes		
		sRGB	Custom	CAL
	Brightness**	*	*	-
	Temperature**	-	*	-
	Gamma**	-	*	-
	Saturation	-	*	-
	Hue	-	*	-
	Gain	-	*	-
	6 colors	-	*	-
	Reset	-	*	-







\*\*These settings can be also adjusted on the FineContrast menu.

#### NOTE

- \* Allow the LCD monitor to stabilize for at least 20 minutes before making image adjustments. (Allow the monitor to warm Up for at least 20 minutes before making adjustments.)
- \* Performing the <Reset> of the <Color> menu returns the color settings of the selected mode to the default settings.
- \* The values shown in percentages represent the current level within the specific adjustment. They are available only as a reference tool. (To create a uniform white or black screen, the percentages for each will probably not be the same.)

## Adjustment Contents

Menu	Function Descriptions	Adjustable Range
Brightness 	To set the brightness of the screen	0 ~ 100%
<a href="#">Temperature</a> 	To set the color temperature	4,000 ~ 10,000 K in 500 K increments (including 9,300 K). Default setting is 5,000K

	<p><b>NOTE</b></p> <ul style="list-style-type: none"> <li>* The values shown in the Kelvin are available only as a reference tool.</li> <li>* Adjusting the &lt;Gain&gt; turns the &lt;Temperature&gt; adjustment "OFF".</li> <li>* Setting the temperature under 4,000 K or over 10,000 K invalidates the color temperature setting. (The color temperature's setting turns "OFF".)</li> </ul>	
<a href="#">Gamma</a>	To set the gamma value	1.8 ~ 2.6 (in 0.2 increments)
	<p><b>NOTE</b></p> <ul style="list-style-type: none"> <li>* If setting the gamma value, the using the monitor in the digital signal input is recommended.</li> <li>If using the monitor in the analog input signal, set the gamma value from 1.8 to 2.2.</li> </ul>	
Saturation	To change the saturation	-16 ~ 16 Setting the minimum level (-16) turns the image to the monochrome.
	<p><b>NOTE</b></p> <ul style="list-style-type: none"> <li>* The &lt;Saturation&gt; adjustment may cause undisplayable color tone.</li> </ul>	
Hue	To change the flesh color, etc.	-20 ~ 20
	<p><b>NOTE</b></p> <ul style="list-style-type: none"> <li>* The &lt;Hue&gt; adjustment may cause undisplayable color tone.</li> </ul>	
<a href="#">Gain</a>	To change each color (red, green and blue)	0 ~ 100% By adjusting the red, green and blue color tones for each mode, custom colors can be defined. Display a white or gray background image and adjust the <Gain>.
	<p><b>NOTE</b></p> <ul style="list-style-type: none"> <li>* The values shown in the percentage are available only as a reference tool.</li> <li>* Setting the &lt;<a href="#">Temperature</a>&gt; invalidates the &lt;Gain&gt; adjustment. &lt;Gain&gt; setting returns to the default setting.</li> </ul>	
6 colors	To adjust <Saturation> and <Hue> in each color (Red, Yellow, Green, Cyan, Blue and Magenta)	Hue: -20 ~ 20 Saturation: -16 ~ 16
		
Reset	To return the color settings of the selected mode to the default settings	Select the <Reset>.
		

## 4-4. Power-save Setup

The <PowerManager> menu in the ScreenManager enables to set the power-save setup.

### NOTE

- \* Do your part to conserve energy, turn off the monitor when you are finished using it. Disconnecting the monitor from the power supply is recommended to save energy completely.
- \* Even if the monitor is in a power saving mode, USB compliant devices function when they are connected to the monitor's USB (both the Upstream and the Downstream ports). Therefore, power consumption of the monitor will change according to the connected devices even if the monitor is in a power saving mode.

## Analog Input

This monitor complies with the "[VESA DPMS](#)" standard.

### To use the PC's Power Saving System (VESA DPMS).

#### [Procedure]

- (1) Set the PC's power saving settings.
- (2) Select "VESA DPMS" in the <PowerManager> menu.

#### [Power saving system]

PC		Monitor	Power Indicator
Operation		Operation	Blue
Power saving	STAND-BY SUSPEND OFF	Power saving	Yellow

#### [Power Resumption Procedure]

Operate the mouse or keyboard to return to a normal screen.

## Digital Input

This monitor complies with the "[DVI DMPM](#)".

### [Procedure]

- (1) Set the PC's power saving settings.
- (2) Select "DVI DMPM" from the <PowerManager> menu.

### [Power saving system]

PC	Monitor	Power Indicator
Operation	Operation	Blue
Power saving	Power saving	Yellow
Off mode	Power saving*1	Flashing yellow (2 times for each)

\*1 Power saving through the PC's off mode is only supported when "Manual" is selected on the ScreenManager's <Input Priority>.

### [Power Resumption Procedure]

Operate the mouse or keyboard to return to a normal screen .  
Power on the PC to return a normal screen from the Off mode of the PC.

## 5. MAKING USE OF USB (Universal Serial Bus)

This monitor provides a hub which supports the USB standard. When connecting to a USB compliant PC or another hub, the monitor functions as a hub which the USB compliant peripherals can be easily connected.

### Required System Environment

- \* PC equipped with USB ports or another USB hub connected to the USB compliant PC
- \* Windows 98/2000/XP//Mac OS 8.5.1 or later
- \* EIZO USB Cable (MD-C93, enclosed)

#### NOTE

- \* The USB hub function may not work properly depending on the PC, OS or peripherals. Please consult the manufacturer of each device about the USB support.
- \* Using the USB Rev . 2.0 compatible PC or peripherals is recommended.
- \* When the monitor is not on, the peripherals connected to the downstream ports will not operate.
- \* Even if the monitor is in a power saving mode, the devices connected to the monitor's USB ports (both the upstream and the downstream) will function.
- \* The followings are procedures for the Windows 98/Me/2000/XP and Mac OS.

### Connecting to the HUB USB

- 1.Connect the monitor to the PC with the signal cable first, then turn on the PC.**

**2. Connect the upstream port of the monitor to the downstream port of the USB compliant PC or another hub by using the USB cable.**

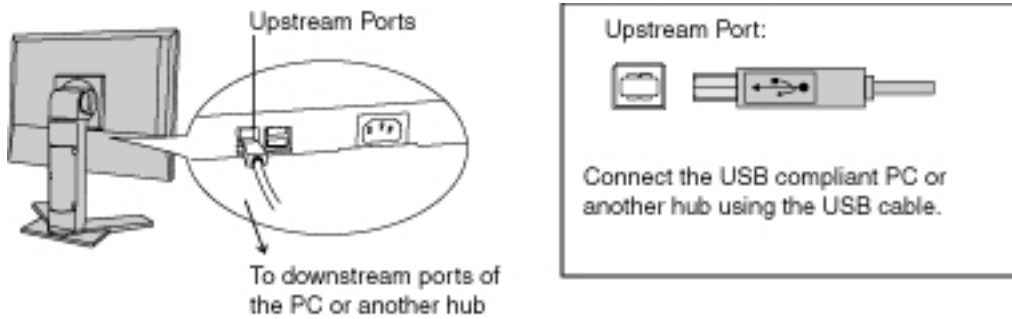

After connecting the USB cable, the USB function can be set up automatically.

**3. After setting up, the monitor's USB hub is available for connecting USB compliant peripherals to the downstream ports of the monitor.**

### Connecting Examples

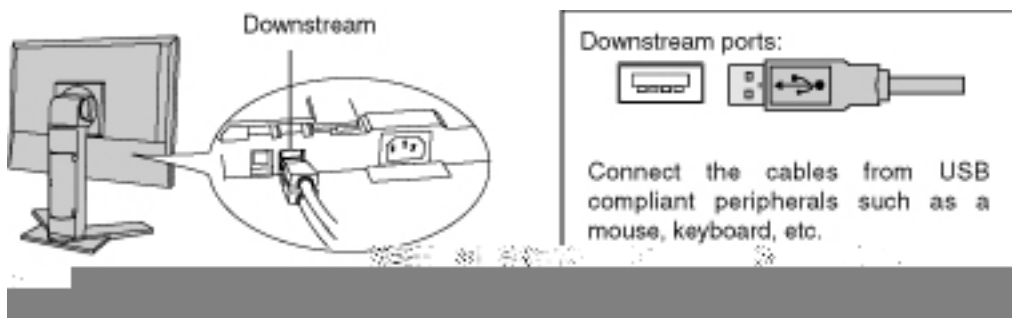



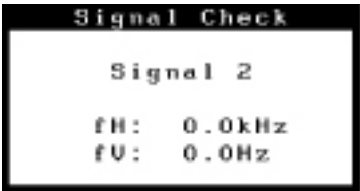

## 6. TROUBLESHOOTING

If a problem persists even after applying the suggested remedies, contact an EIZO dealer.

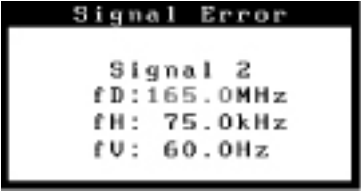
- No picture problems : See No.1 ~ No.2
- Imaging problems : See No.3 ~ No.14
- Other problems : See No.15 ~ No.18
- USB problems : See No.19 ~ No.20

Problems	Points to check with possible solutions
<b>1. No picture</b>  Indicator status: Off	<input type="checkbox"/> Check that the power cord is correctly connected. If the problem persists, turn off the monitor power for a few minutes, then turn it back on and try again.
Indicator status: Blue	<input type="checkbox"/> Check the Brightness setting.
Indicator status: Yellow	<input type="checkbox"/> Switch the signal Input by pressing the input signal selection button on the front control panel. <input type="checkbox"/> <a href="#">Try pressing a key on the keyboard, or clicking the mouse.</a>
Indicator status: Slowly flashing Yellow	<input type="checkbox"/> Try pressing the power button
Indicator status: Flashing Yellow (twice for each)	<input type="checkbox"/> Try turning the PC on.
<b>2. Following messages appear. (Error messages shown below will remain on the screen for 40 seconds.)</b>  	<p>These messages appear when the signal is not inputted correctly, even if the monitor functions properly.</p> <input type="checkbox"/> When the image is displayed correctly after a short time, there is no problem with the monitor. (Some PCs do not output the signal soon after powering on.) <input type="checkbox"/> Check that the PC is turned ON. <input type="checkbox"/> Check that the signal cable is properly connected the PC or graphics board. <input type="checkbox"/> Switch the signal input by pressing the Input Signal Selection button on the front control panel.

<p>Whenever an error signal message appears, the signal frequency will be displayed in red. (Example)</p> 	<p>[ ] Use the graphics board's utility software to change the frequency setting. (Refer to the manual of the graphics board.)</p>
<p><b>3. Display position is incorrect.</b></p> 	<p>[ ] Adjust the image position using the &lt;<a href="#">Position</a>&gt;.</p> <p>[ ] If the problem persists, use the graphics board's utility software to change the display position if available.</p>
<p><b>4. Screen image is smaller or larger than the actual screen images.</b></p>	<p>[ ] Adjust the resolution using the &lt;<a href="#">Resolution</a>&gt;.</p>
<p><b>5. Vertical bars of distortion appear.</b></p> 	<p>[ ] Decrease the vertical bars using the &lt;<a href="#">Clock</a>&gt;.</p>
<p><b>6. The characters and images have several vertical bars on their right side.</b></p> 	<p>[ ] Adjust the characters and images using the &lt;<a href="#">Signal Filter</a>&gt;.</p>

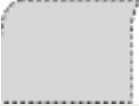

<p><b>7. Horizontal bars of distortion appear.</b></p> 	<p>[ ] Decrease the horizontal bars using the <a href="#">Phase</a>.</p>
<p><b>8. Letters and lines appear blurred.</b></p>	<p>[ ] Adjust the blurred lines using <a href="#">Smoothing</a>.</p>
<p><b>9. Distortion appears like the figure below.</b></p> 	<p>[ ] This happens when both composite (X-OR) input signal and separate vertical synchronizing signal are input. Please select one of the two.</p>
<p><b>10. The screen is too bright or too dark.</b></p>	<p>[ ] Adjust the <a href="#">Brightness</a> (The backlight of the LCD monitor has a fixed life span. When the screen becomes dark or begins to flicker, please consult your dealer.)</p>
<p><b>11. Afterimages appear.</b></p>	<p>[ ] When the screen image is changed after displaying the same image for a long period, an afterimage may appear. The "Afterimage" can be removed gradually by changing the displayed image. Use the <a href="#">Off Timer</a> function and avoid keeping the screen on all the time.</p>
<p><b>12. The screen has defective pixels (e.g. slightly light or dark).</b></p>	<p>[ ] This is due to the characteristics of the panel itself, and not the LCD product.</p>
<p><b>13. Fingerprints remain on the screen.</b></p>	<p>[ ] Leaving the screen white may solve the problem.</p>
<p><b>14. The noise appears on the screen.</b></p>	<p>[ ] Change the mode in <a href="#">Signal Filter</a> in the <a href="#">Screen</a> menu.</p>

<p><b>15. The &lt;Smoothing&gt; cannot be selected.</b></p>	<p>[ ] &lt;Smoothing&gt; is disabled when the screen is displayed in the 1280 x 1024.</p> <p>[ ] &lt;Smoothing&gt; is disabled when "Normal" is selected in the &lt;Screen Size&gt; menu.</p> <p>[ ] The image size is doubled both in horizontally and vertically to (i.e. 1280 x 960 enlarged from 640 x 480) provide clear focus which does not require this function.</p>
<p><b>16. The Main menu of ScreenManager does not operate.</b></p>	<p>[ ] The adjustment lock is probably on. <a href="#">To unlock</a>: switch the LCD monitor off. Then, while pressing the Autadjustment button switch, the power on.</p>
<p><b>17. The Auto adjustment button does not operate.</b></p>	<p>[ ] The adjustment lock is probably on. To unlock: switch the LCD monitor off. Then, while pressing the Auto adjustment button, switch the power on.</p>
<p><b>18. Frequency does not change after installing "Monitor information file" in the attached utility disk on Windows 98/Me/2000/XP.</b></p>	<p>[ ] Use the graphics board's utility software to change the input signal frequency.</p>
<p><b>19. USB function cannot be setup.</b></p>	<p>[ ] Check that the USB cable is correctly connected.</p> <p>[ ] Check that the PC and OS are USB compliant. (For verification of USB support, consult the manufacturer of each system.)</p> <p>[ ] Check the PC's BIOS setting for USB. ( For details, refer to the manual of the PC.)</p>
<p><b>20. PC is hung up. / The peripherals connected to the downstream ports do not operate.</b></p>	<p>[ ] Check that the USB cable is correctly connected.</p> <p>[ ] Check the downstream ports by connecting the peripherals to other downstream ports. If the problem is solved by doing this, contact an EIZO dealer. (For details, refer to the manual of the PC.)</p>

[ ] Try executing the following method.

- Restarting the PC - Restarting the PC
- Connecting the PC and peripherals directly

If the problem is solved by doing this, contact an EIZO dealer.

## 7. CLEANING

Periodic cleaning is recommended to keep the monitor looking new and to prolong its operation lifetime.

### **NOTE**

- \* Never use thinner, benzene, alcohol (ethanol, methanol, or isopropyl alcohol), abrasive cleaners, or other strong solvents, as these may cause damage to the cabinet or LCD panel.

### **Cabinet**

To remove stains, wipe the cabinet with a soft, lightly moistened cloth using a mild detergent. Do not spray wax or cleaner directly into the cabinet. (For details, refer to the manual of the PC.)

### **LCD Panel**

- The LCD surface can be cleaned with a soft cloth, such as cotton or lens paper.
- If necessary, stubborn stains can be removed by moistening part of a cloth with water to enhance its cleaning power.

## 8. SPECIFICATION

LCD Panel	48 cm (19.0 inch), TFT color LCD panel with Anti-Glare Hard Coating Viewing Angle: H: 170°, V: 170° (CR>10)
Dot Pitch	0.294 mm
Horizontal Scan Frequency	Analog: 30 - 82 kHz (Automatic) Digital: 30 - 65 kHz
Vertical Scan Frequency	Analog: 49 - 86 Hz (Automatic) (1280 x 1024: 49 - 75 Hz) Digital: 59 Hz - 61Hz, (VGA Text : 69 - 71 Hz)
Resolution	1280 dots x 1024 lines
Dot Clock (Max.)	Analog: 135 MHz, Digital: 108 MHz
Display Colors	16 million colors (max.)
Display Area	376 mm (H) x 301 mm (V) (14.8" (H) x 11.9" (V)) (Viewable image size: 481 mm (19.0"))
Power Supply	100-120VAC±10% 50/60 Hz, 0.6A 200-240 VAC±10%, 50 Hz, 0.35 A
Power Consumption	Min.: 54 W Max: 60 W (With USB hub) Power Saving Mode : Less than 3 W
Input Connector	DVI-I x 2
Analog Input Signal (Sync)	a) Separate, TTL, Positive/Negative b) Composite, TTL, Positive/Negative
Analog Input Signal (Video)	0.7Vp-p/75 ohms, Positive
Input Signal (Digital)	TMDS (Single Link)
Signal registration	Analog : 45 (Preset: 25) Digital : 10 (Preset: 6)
Plug & Play	VESA DDC 2B
Dimensions	414 mm (W) x 409.5 - 509.5 mm (H) x 202.7 mm (D) (16.3"(W) x 16.1" - 20.1"(H) x 8.0"(D))
Dimensions (without stand)	414 mm (W) x 340 mm (H) x 64 mm (D) (16.3"(W) x 13.4"(H) x 2.52"(D))
Weight	8.1 kg (17.9 lbs.)
Weight (without stand)	5.8 kg (12.8 lbs.)
Temperature	Operating: 0 °C - 35 °C (32 °F - 95 ° F) Storage: -20 °C - 60 °C (-4 °F - 140 ° F) Humidity 30% to 80% R.H. Non-condensing
USB standard	Rev. 2.0 complied

Communication speed	480Mbps(high), 12 Mbps (full), 1.5 Mbps (low)
Downstream power supply	500 mA for each (Max.)
USB ports	Upstream port x 1, Downstream port x 2
Certifications and Standards 100-120 VAC	NRTL/C-TÜV, FCC-B, TCO'03*1, TCO'99*2, EPA ENERGY STAR Program, TÜV/Rheinland Ergonomics Approved
Certifications and Standards 200-240 VAC	CE, CB, TÜV Rheinland/GS, TCO'03*1, TCO'99*2, EPA ENERGY STAR Program, TÜV/Rheinland Ergonomics Approved

\*1 Applicable to gray (standard) color version only.

\*2 Applicable to black color version only.

## Default settings

	Analog input	Digital input
Brightness	100%	100%
Smoothing	3	
Temperature	5,000K	
FineContrast Mode	Custom	
PowerManager	VESA DPMS	DVI DMPM
Screen Size	Full	
Input Priority	Signal 1	
Off Timer	Disable	
Menu Settings	Menu Size	Normal
	Menu Off Timer	45 seconds
Beep	On	
Language	English	
Input Selection	Standard	

## Beeper settings

Short beep	ScreenManager item selected. ScreenManager parameter adjusted to minimum or maximum limit. Input Signal Selection button pressed.
Long beep	Auto Adjustment button pressed. ScreenManager data-save executed.
4 short beeps	Monitor not connected correctly. PC turned off. Monitor received unsupported signal frequency.
2 short beeps every 15 sec.	Monitor is in the advance notice mode of the Off Timer. The power will be off within fifteen minutes.

## Dimensions

Unit mm (inches)

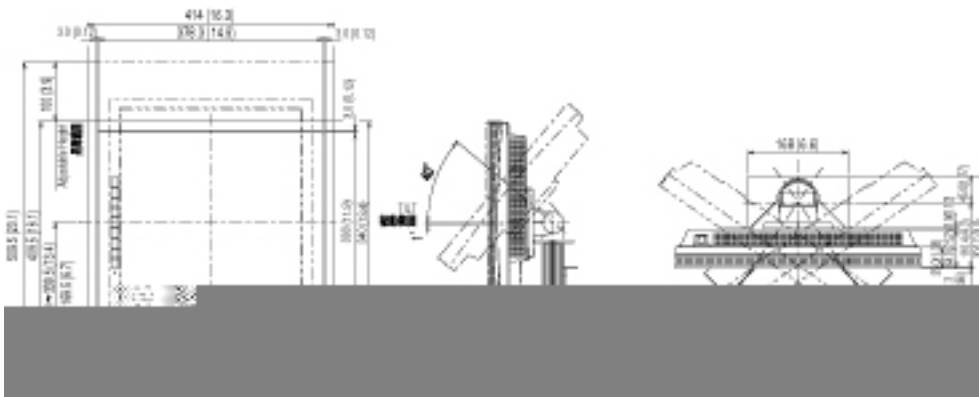

## Pin Assignment

### DVI-I Connector



Pin No.	Signal	Pin No.	Signal	Pin No.	Signal
1	TMDS Data 2-	11	TMDS Data 1/3 Shield	21	NC
2	TMDS Data 2+	12	NC	22	TMDS Clock Shield
3	TMDS Data 2/4 Shield	13	NC	23	TMDS Clock+
4	NC*	14	+5V Power	24	TMDS Clock-
5	NC	15	Ground (return for +5V, Hsync and Vsync)	C1	Analog Red
6	DDC Clock (SCL)	16	Hot Plug Detect	C2	Analog Green
7	DDC Data (SDA)	17	TMDS Data0-	C3	Analog Blue
8	Analog Vertical Sync	18	TMDS Data0+	C4	Analog Horizontal Sync
9	TMDS Data1-	19	TMDS Data0/5 Shield	C5	Analog Ground (analog R, G, & B return)
10	TMDS Data1+	20	NC		

(\*NC: No Connection)

## USB Ports

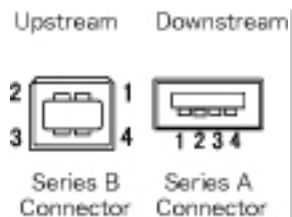

No.	Signal	Signal
1	VCC	Cable power
2	-Data	Serial data
3	+Data	Serial data
4	Ground	Cable Ground



### **Afterimage**

The Afterimage is particular to LCD monitors when the monitor screen is left on for a long period without use. The "Afterimage" can be removed gradually by changing the displayed image.

### **Clock**

With the analog input signal display, the analog signal is converted to a digital signal by the LCD circuitry. To convert the signal correctly, the LCD monitor needs to produce the same number clock pulse as the dot clock of the graphics system. When the clock pulse is not correctly set, some vertical bars of distortion are displayed on the screen.

### **Color Temperature (Temperature)**

Color Temperature is a method to measure the white color tone, generally indicated in degrees Kelvin. At high temperatures the white tone appears somewhat blue, while at lower temperatures it appears somewhat red. Computer monitors generally give best performance at high temperature settings.

5,000 K: Slightly reddish white.

6,500 K: Warm-white tone, similar to white paper or daylight.

9,300 K: Slightly bluish white.

## **DVI (Digital Visual Interface)**

A digital flat panel interface. DVI can transmit digital data from the PC directly without loss with the signal transition method "TMDS".

There are two kinds of DVI connectors. One is DVI-D connector for digital signal input only. The other is DVI-I connector for both digital and analog signal inputs.

## **DVI DMPM (DVI Digital Monitor Power Management)**

The Power management system for the digital interface. The "Monitor ON" status (operation mode) and the "Active Off" status (power-saving mode) are indispensable for the DVI-DMPM as the monitor's power mode.

## **Gain Adjustment**

Adjusts each color parameter for red, green and blue. The color of the LCD monitor is displayed through the color filter of the LCD panel. Red, green and blue are the three primary colors. The colors on the monitor are displayed by combining these three colors. The color tone can change by adjusting the illumination amount passed through each color's filter.

## **Gamma**

Generally, the relationship that the light intensity values of a monitor change nonlinearly to the input signal level is called "Gamma Characteristic". On the monitor, low gamma values display the whitish images and high gamma values display the high contrast images.

## **Phase**

The phase adjustment decides the sampling timing point for converting the analog input signal to a digital signal. Adjusting the phase after the clock adjustment will produce a clear screen.

## **Range Adjustment**

The Range Adjustment controls the level of output signal range to display the whole color gradation.

## **Resolution**

The LCD panel consists of a fixed number of pixel elements which are illuminated to form the screen image. The EIZO CG19 display panel consists of 1280 horizontal pixels and 1024 vertical pixels. At a resolution of 1280 x 1024, all pixels are displayed as a full screen.

## **sRGB (Standard RGB)**

"International Standard for Red, Green, and Blue color space" A color space was defined with the aim of the color matching between applications and hardware devices, such as monitors, scanners, printers and digital cameras. As a standard default space, sRGB allows Internet users to closely match colors.

## **TMDS (Transition Minimized Differential Signaling)**

A signal transition method for the digital interface.

## **VESA DPMS (Video Electronics Standards Association - Display Power Management Signaling)**

The acronym VESA stands for "Video Electronics Standards Association", and DPMS stands for "Display Power Management Signaling". DPMS is a communication standard that PCs and graphics boards use to implement power savings on the monitor side.

**Preset Timing Chart for Analog input  
Timing-Übersichten für Analog Eingang  
Synchronisation des Signaux pour Analog numerique**

Based on the signal diagram shown below 25 factory presets have been registered in the monitor's microprocessor.

Der integrierte Mikroprozessor des Monitors unterstützt 25 werkseitige Standardeinstellungen (siehe hierzu die nachfolgenden Diagramme).

25 signaux ont été enregistrés en usine dans le microprocesseur du moniteur, conformément au diagramme de synchronisation ci-dessous.

Mode	Dot Clock	Sync Polarity		Frequencies	
	MHz	H	V	H	V
VGA 640×480	25.2 MHz				

VESA 640×480	31.5 MHz	Nega	Nega	37.5	75.0
VESA 640×480	36.0 MHz	Nega	Nega	43.3	85.0
VESA 800×600	36.0 MHz	Posi	Posi	35.2	56.3
VESA 800×600	40.0 MHz	Posi	Posi	37.9	60.3
VESA 800×600	50.0 MHz	Posi	Posi	48.1	72.2
VESA 800×600	49.5 MHz	Posi	Posi	46.9	75.0
VESA 800×600	56.3 MHz	Posi	Posi	53.7	85.1
VESA 1024×768	65.0 MHz	Nega	Nega	48.4	60.0
VESA 1024×768	75.0 MHz	Nega	Nega	56.5	70.1
VESA 1024×768	78.8 MHz	Posi	Posi	60.0	75.0
VESA 1024×768	94.5 MHz	Posi	Posi	68.7	85.0
VESA 1152×864	108.0 MHz	Posi	Posi	67.5	75.0
VESA 1280×960	108.0 MHz	Posi	Posi	60.0	60.0
VESA 1280×1024	108.0 MHz	Posi	Posi	64.0	60.0
VESA 1280×1024	135.0 MHz	Posi	Posi	80.0	75.0

[Applicable to gray cabinet.]



## **Congratulations!**

The display you have just purchased carries the TCO'03 Displays label. This means that your display is designed, manufactured and tested according to some of the strictest quality and environmental requirements in the world. This makes for a high performance product, designed with the user in focus that also minimizes the Impact on our natural environment.

Some of the features of the TCO'03 Display requirements:

### **Ergonomics**

Good visual ergonomics and image quality in order to improve the working environment for the user and to reduce sight and strain problems. Important parameters are luminance, contrast, resolution, reflectance, colour rendition and image stability.

### **Energy**

- Energy-saving mode after a certain time - beneficial both for the user and environment
- Electrical safety

### **Emissions**

- Electromagnetic fields
- Noise emissions

### **Ecology**

- The products must be prepared for recycling and the manufacturer must have a certified environmental management system such as EMAS or ISO 14000
- Restrictions on
  - chlorinated and brominated flame retardants and polymers

- heavy metals such as cadmium, mercury and lead.

The requirements included in this label have been developed by TCO Development in co-operation with scientists, experts, users as well as manufacturers all over the world. Since the end of the 1980s TCO has been involved in influencing the development of IT equipment in a more user-friendly direction. Our labeling system with displays in 1992 and is now requested by users and IT-manufacturers all over the world.

For more information, please visit

[www.tcodevelopment.com](http://www.tcodevelopment.com)



For U.S.A, Canada, etc. (rated 100-120 Vac) Only

**FCC Declaration of Conformity**

We, the Responsible Party      EIZO NANAO TECHNOLOGIES INC.  
   5710 Warland Drive, Cypress, CA 90630  
   Phone: (562) 431-5011

declare that the product      Trade name: EIZO  
   Model: ColorEdge CG19

is in conformity with Part 15 of the FCC Rules. Operation of this product is subject to the following two conditions: (1) this device may not cause harmful interference, and (2) it

## **Hinweis zur Ergonomie**

Dieser Monitor erfüllt die Anforderungen an die Ergonomie nach EK1-ITB 2000 mit dem Videosignal, 1280 Punkte X 1024 Zeilen, RGB analog, 0,7 Vp-p und mindestens 75,0 Hz Bildwiederholfrequenz, non interlaced. Weiterhin wird aus ergonomischen Gründen empfohlen, die Grundfarbe Blau nicht auf dunklem Untergrund zu verwenden (schlechte Erkennbarkeit, Augenbelastung bei zu geringem Zeichenkontrast.)

---

## **Recycle Auskunft**

Die Rücknahme dieses Produktes nach Nutzungsende übernimmt EIZO in Deutschland zusammen mit dem Partner von Roll MBB Recycling GmbH. Dort werden die Geräte in ihre Bestandteile zerlegt, die dann der Wiederverwertung zugeführt werden. Um einen Abholtermin zu vereinbaren und die aktuellen Kosten zu erfahren, benutzen Sie bitte folgende Rufnummer: 02153-73 35 00. Weitere Informationen finden Sie auch unter der Internet-Adresse: [www.eizo.de](http://www.eizo.de).

---

## **Recycling Information for customers in Switzerland:**

All recycling information is placed in the SWICO's website.

<http://www.swico.ch>

## **Recycling-Informationen für Kunden in der Schweiz:**

Alle Informationen zum Thema Recycling finden Sie auf der Homepage des Branchenverbandes SWICO.

<http://www.swico.ch>

## **Renseignements de recyclage pour les clients en Suisse:**

Vous trouvez tous les renseignements pour le sujet de recyclage sur la page WEB de l'UNION DE BRANCHE SWICO.

<http://www.swico.ch>

---

## **Recycling Information for customers in USA:**

All recycling information is placed in the Eizo Nanao Technologies, Inc.'s website.

<http://www.eizo.com/contact/index.html>

---

## **Återvinnings information för kunder i Sverige:**

All information om återvinning finns på Eizo Nordics hemsida:

[www.eizo.se](http://www.eizo.se)

---

## **Hinweise zur Auswahl des richtigen Schwenkarms für Ihren Monitor**

Dieser Monitor ist für Bildschirmarbeitsplätze vorgesehen. Wenn nicht der zum Standardzubehör gehörige Schwenkarm verwendet wird, muss statt dessen ein geeigneter anderer Schwenkarm installiert werden. Bei der Auswahl des Schwenkarms sind die nachstehenden Hinweise zu berücksichtigen:

Der Standfuß muß den nachfolgenden Anforderungen entsprechen:

- a) Der Standfuß muß eine ausreichende mechanische Stabilität zur Aufnahme des Gewichtes vom Bildschirmgerät und des spezifizierten Zubehörs besitzen. Das Gewicht des Bildschirmgerätes und des Zubehörs sind in der zugehörigen Bedienungsanleitung angegeben.
- b) Die Befestigung des Standfusses muß derart erfolgen, daß die oberste Zeile der Bildschirmanzeige nicht höher als die Augenhöhe eines Benutzers in sitzender Position ist.

- c) Im Fall eines stehenden Benutzers muß die Befestigung des Bildschirmgerätes derart erfolgen, daß die Höhe der Bildschirmmitte über dem Boden zwischen 135 - 150 cm beträgt.
- d) Der Standfuß muß die Möglichkeit zur Neigung des Bildschirmgerätes besitzen (max. vorwärts:  $5^\circ$ , min. nach hinten  $\geq 5^\circ$ )
- e) Der Standfuß muß die Möglichkeit zur Drehung des Bildschirmgerätes besitzen (max.  $\pm 180^\circ$ ). Der maximale Kraftaufwand dafür muß weniger als 100 N betragen.
- f) Der Standfuß muß in der Stellung verharren, in die er manuell bewegt wurde.
- g) Der Glanzgrad des Standfusses muß weniger als 20 Glanzeinheiten betragen (seidenmatt).
- h) Der Standfuß mit Bildschirmgerät muß bei einer Neigung von bis zu  $10^\circ$  aus der normalen aufrechten Position kippstabil sein.

## Free Manuals Download Website

<http://myh66.com>

<http://usermanuals.us>

<http://www.somanuals.com>

<http://www.4manuals.cc>

<http://www.manual-lib.com>

<http://www.404manual.com>

<http://www.luxmanual.com>

<http://aubethermostatmanual.com>

Golf course search by state

<http://golfingnear.com>

Email search by domain

<http://emailbydomain.com>

Auto manuals search

<http://auto.somanuals.com>

TV manuals search

<http://tv.somanuals.com>