

**Uniden®**

**ELT 560**

**SERIES**

**OWNER'S**

**MANUAL**

**OWNER'S MANUAL**

# Contents

Welcome/Features/Terminology/		Using Your Phone	34	Room/Baby Monitor	56
Accessibility	2	From the Handset Speakerphone	34	Intercom	57
Controls & Functions	4	Receiving a call/AutoTalk		Transferring a Call	58
Setting up the Phone	6	set to OFF	35	Note on Power Sources	59
Choose the best location	6	Hanging Up	35	Power Failure	59
Battery Backup Feature	7	Switching to the Handset		Battery replacement and handling	59
Install the rechargeable		Speakerphone During a Call	35	Warning	59
battery pack	8	Moving out of range	35	General Information	60
Low battery alert	9	Call Waiting	36	AC Adapter Information	60
Cleaning the battery charging		Placing a Call on Hold	37	Battery Information	60
contacts	9	Conferencing	37	Troubleshooting	61
Connect the base and charge the		Redialing Calls	37	System Reset	63
handset	10	Using the Handset Volume		Liquid Damage	64
Expanding Your Phone	11	Setting Menu	39	Precautions & Warranty	65
Backwards/Forwards Compatibility	11	Mute	40	I.C. Notice	67
Connect the expansion		Mute the Handset Microphone	40	Index	68
handset's charger	12	Tone Dialing Switch Over	41		
Register the Handset	12	Privacy Mode	41		
Register the ELX500 expansion		Find Handset	41		
handset to the main base	13	Reminder	42		
Changing the Digital Security Code	14	Using the Phonebook	46		
Installing the Holster	14	Creating and Editing			
Optional Headset Installation	15	Phonebook Entries	46		
Installing Uniden's Cordless Telephone		Storing Caller ID or Redial			
Customization Tool	16	Numbers in the Phonebook	49		
Using the Interface	17	Managing the Phonebook	50		
Example of the standby mode		Checking the number of			
display	17	stored entries	51		
Display Icons	17	Changing the sorting order	51		
Soft Key Function	18	Naming phonebook groups	52		
Entering text	20	Making Calls with the Phonebook	52		
Main Menu Options	21	Caller ID Features	53		
System Setup Menu	22	Using the Caller ID List	53		
System Setup	22	Deleting Caller ID numbers	54		
Setting the Ringer Options	27	Multi-Handset Features	55		
Display Settings	30	Using DirectLink Mode	55		

# Welcome

Thank you for purchasing a Uniden Multi-Handset phone. The USB connection lets you use your personal computer to edit your phonebook, download schedule reminders, and even import contacts from MicroSoft Outlook.

**Note: Illustrations in this manual are used for explanation purposes. Some illustrations in this manual may differ from the actual unit.**



As an Energy Star<sup>®</sup> Partner, Uniden has determined that this product or product models meets the Energy Star<sup>®</sup> guidelines for energy efficiency. Energy Star<sup>®</sup> is a U.S. registered mark.

# Features

- 5.8GHz Digital Expandable
- Caller ID/Call Waiting Deluxe Options
- Customize Handset Profiles Using Personal Computer
- 100 Phonebook Names (4 Numbers Per Name)
- Downloadable Images
- Recordable Ringer Tones
- Calendar with Schedule Reminder Capability
- Battery Backup During Power Failure

Uniden<sup>®</sup> is a registered trademark of Uniden America Corporation. AutoStandby, DirectLink, IntegriSound and Random Code are trademarks of Uniden America.

Microsoft and Windows are either registered trademarks or trademarks of Microsoft Corporation in the United States and/or other countries.

# Terminology

- **Standby mode** - The handset is not in use. If it is off the cradle, no line has been activated. No dial tone is present.
- **Talk mode** - A telephone line has been activated on the handset, enabling a dial tone.

# Accessibility

Uniden provides a customer service hotline for accessibility questions. If you have a disability and need customer service assistance or if you have any questions about how Uniden's products can accommodate persons with disabilities, please call the accessibility voice/TTY line:  
1-800-874-9314

A representative is available to talk to you M-F, 8:00 am to 5:00 pm, CST. After hours, you can leave us a message, and we will call you back. Information is also available on our website, [www.uniden.com](http://www.uniden.com), under the "Accessibility" link.

# Controls & Functions

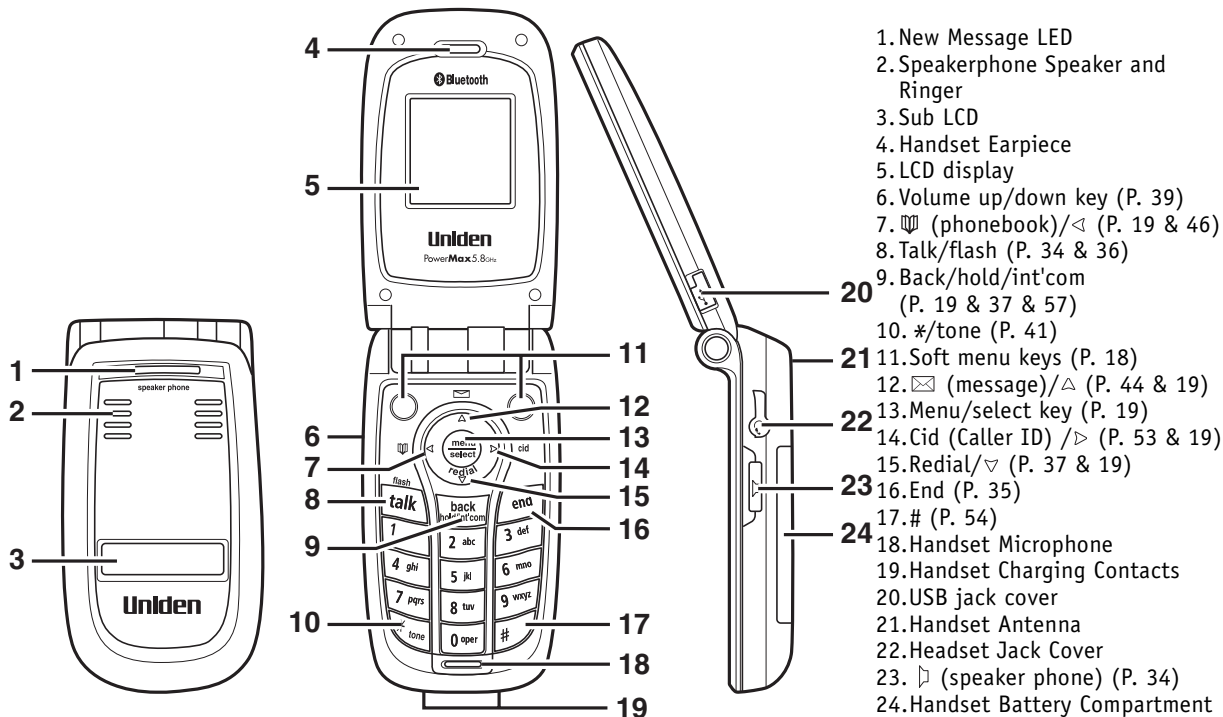

1. New Message LED
2. Speakerphone Speaker and Ringer
3. Sub LCD
4. Handset Earpiece
5. LCD display
6. Volume up/down key (P. 39)
7. ☰ (phonebook)/◀ (P. 19 & 46)
8. Talk/flash (P. 34 & 36)
9. Back/hold/int'com (P. 19 & 37 & 57)
10. \*/tone (P. 41)
11. Soft menu keys (P. 18)
12. ✉ (message)/△ (P. 44 & 19)
13. Menu/select key (P. 19)
14. Cid (Caller ID) /▷ (P. 53 & 19)
15. Redial/▽ (P. 37 & 19)
16. End (P. 35)
17. # (P. 54)
18. Handset Microphone
19. Handset Charging Contacts
20. USB jack cover
21. Handset Antenna
22. Headset Jack Cover
23. ▷ (speaker phone) (P. 34)
24. Handset Battery Compartment

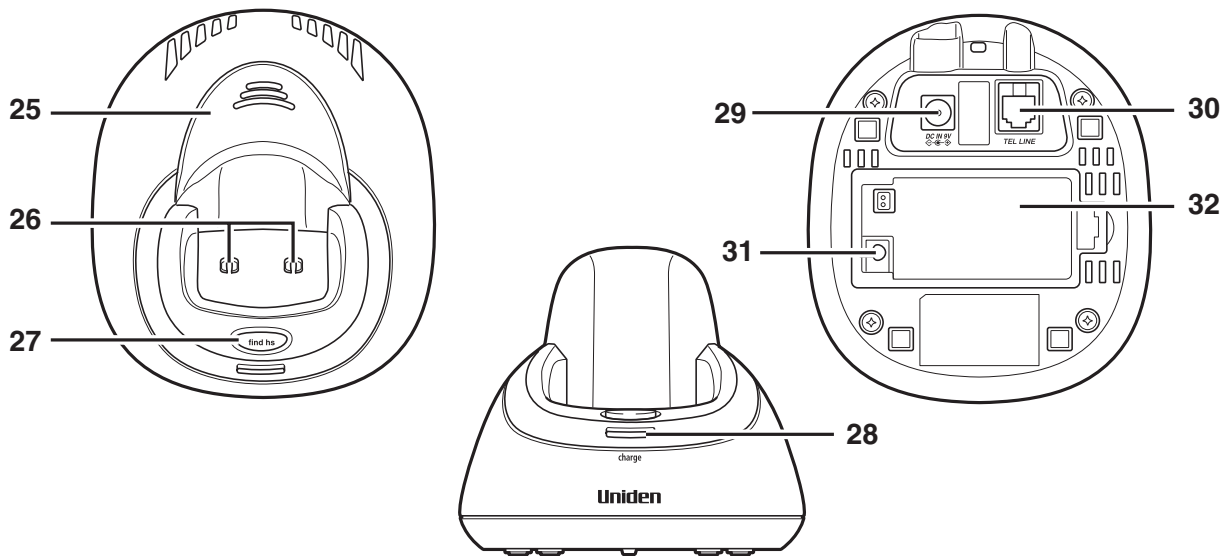

- 25. Base Antenna
- 26. Base Charge Contacts
- 27. Find hs (handset) (P. 41)
- 28. Handset Charge LED
- 29. DC IN 9V Jack
- 30. TEL LINE Jack
- 31. Registration button
- 32. Base Battery Compartment



For maximum range:

- Do not hold the handset where you would block the signal.

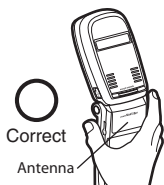

- Metal and reinforced concrete may affect cordless telephone performance.

## Setting up the Phone

### Choose the best location

When choosing a location for your new phone, here are some important guidelines you should consider:

Avoid heat sources, such as radiators, air ducts, and sunlight

Avoid television sets and other electronic equipment

Avoid noise sources such as a window by a street with heavy traffic

Avoid microwave ovens

Avoid excessive moisture, extremely low temperatures, dust, mechanical vibration, or shock

Avoid personal computers

Choose a central location

Avoid other cordless telephones

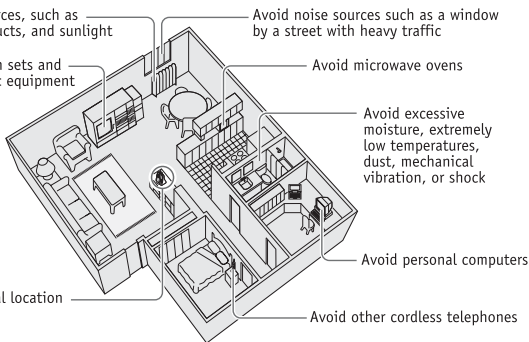

- The location should be close to both a phone jack and a continuous power outlet (one which is not connected to a switch).
- The base and handset should be kept away from sources of electrical noise such as motors, Microwave ovens, and fluorescent lighting.
- For better reception, place the base as high as possible.
- The base should be placed in an open area for optimum range and reception.
- If your home has specially wired alarm equipment connected to phone line, be sure that installing the system does not disable your alarm equipment. If you have questions about what will disable alarm equipment, contact your telephone company or a qualified installer.
- The base should be placed in an open area for optimum range and reception.

## Battery Backup Feature

The battery backup allows you to make and receive calls during a power failure. You can use any handset or the base, just as you would normally.

### Install the power backup battery in the base

- 1) Open the battery case cover by pressing the release button on the bottom of the base as shown.
- 2) Plug the battery connector (red and black wires) into the jack inside the battery compartment. (The connector notches fit into the grooves of the jack only one way). Match the wire colors to the polarity label in the battery compartment, connect the battery and listen for a click to insure connection.
- 3) Make sure you have a good connection by gently pulling on the battery wires. If the connection is secure, the battery jack will remain in place.
- 4) Place the battery case cover back on the base.
- 5) Align the tabs on the cover with the grooves on the base, and press down the cover until it clicks into place.

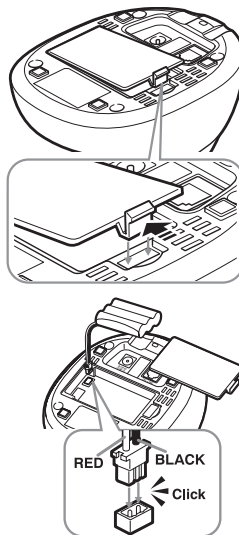

- To use the battery backup feature, you need to connect the AC adapter to the base, and charge the base battery at least for 24 hours.
- During initial setup, the AC Adapter must be connected to activate the base unit. Once activated, you can make or receive calls using battery backup.
- Use only the Uniden (BT-446) rechargeable battery pack supplied with your cordless telephone.





Use only the Uniden (BT-0002) rechargeable battery pack supplied with your cordless telephone.

## Install the rechargeable battery pack

Follow the steps below if you need to install a battery.

- 1) Press down on the handset battery case cover (use the finger indentation for a better grip) and slide the cover downward to remove.
- 2) Place the battery pack in the battery compartment with the connectors on the battery and on the compartment aligned.
- 3) Place the battery case cover back on the handset and slide it upwards until it clicks into place.

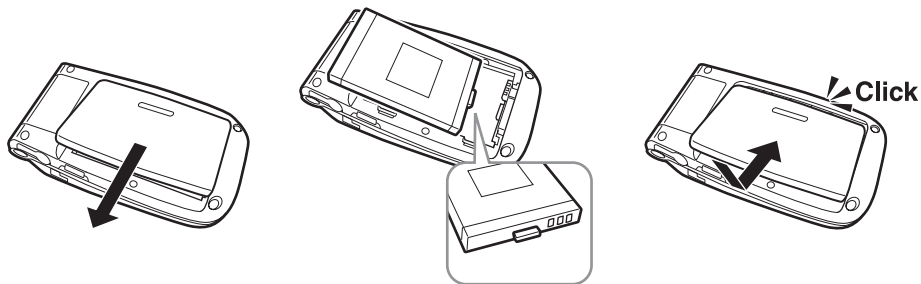

## Low battery alert

When the battery pack is very low, the phone is programmed to eliminate functions in order to save power.

The battery pack needs to be charged when:

- The empty battery icon appears.
- Low Battery appears in the display.

If the phone is in standby mode, none of the keys will operate. If you are on a call, complete your conversation as quickly as possible, and return the handset to the cradle.

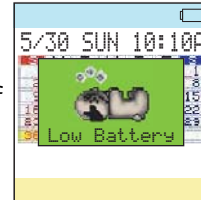

## Cleaning the battery charging contacts

To maintain a good charge, clean the charging contacts on the handset once a month. Dampen a cloth with plain water. Gently rub the damp cloth over the charging contacts until all visible dirt is removed. Dry the contacts thoroughly before returning the handset to the cradle.

**Caution:** Do not use paint thinner, benzene, alcohol, or other chemical products. Doing so may discolor the surface of the telephone and damage the finish.

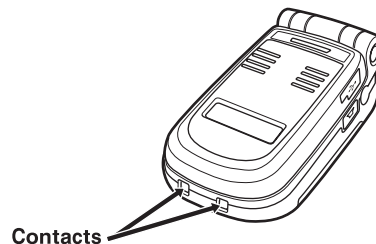

- Even when the battery pack is not being used, it will gradually discharge over a long period of time.
- For optimum performance, be sure to return the handset to the cradle after each telephone call.
- If the handset is left off of the base, the actual talk mode duration will be reduced respective to the amount of time the handset is off the cradle.



- Use only the supplied AD-800 AC adapter. Do not use any other AC adapter.
- Do not place the power cord where it creates a trip hazard or where it could become chafed and create a fire or electrical hazard.
- Don't place the base in direct sunlight or subject it to high temperatures. The battery may not charge properly.



If your telephone outlet isn't modular, contact your telephone company.

## Connect the base and charge the handset

- 1) Connect the AC adapter to the **DC IN 9V** jack.

Place the base close to the AC outlet to avoid long extension cords.

- 2) Connect the AC adapter to a continuous power supply (i.e., an outlet that is not controlled by a switch).
- 3) Close the handset and place it in the base with the smaller LCD screen facing forward.

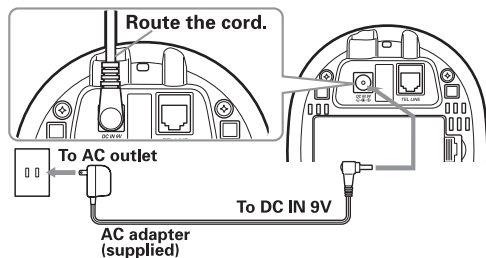

- 4) Make sure that the **charge** LED illuminates. If the LED does not illuminate, check to see that the AC adapter is plugged in and the handset makes good contact with the base charging contacts.
- 5) **Charge your handset at least 10 hours before plugging into the phone line.**
- 6) Once the handset battery pack is fully charged, connect the telephone line cord to the **TEL LINE** jack and to a telephone outlet.



To move the phone to a different telephone outlet, first unplug AC adapter and remove the battery. Connect the telephone cord first, then replace the battery and connect the AC adapter.

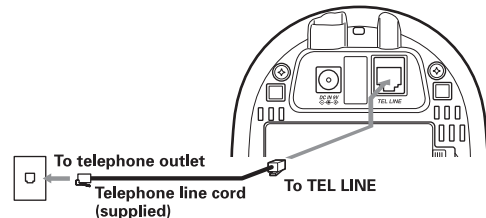

# Expanding Your Phone

Your phone can support a total of ten handsets. Expansion handsets do not need to be connected to a phone jack. Expansion handsets allow you to use additional features such as DirectLink Mode and up to 3-way conference calling. Expansion handsets need to be registered to the base before they will operate.

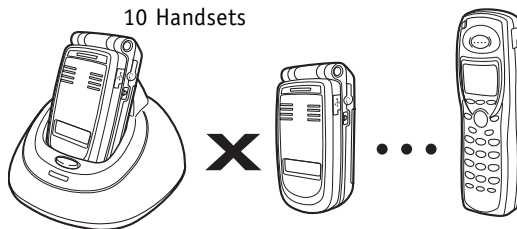

## Backwards/Forwards Compatibility

Your phone is compatible with other Uniden 5.8GHz Digital Expandable Handsets. Compatible models include the **TCX860** and **ELX500**. (please check [www.uniden.com](http://www.uniden.com) for an updated list of expansion handset compatible with this series.)



- Older handsets may not support some of this model's advanced features.
- If you have any trouble with your phone, visit our web site at [www.uniden.com](http://www.uniden.com) or call our Customer Hotline at 1- 800-297-1023 (Mon -Fri 7 am to 7pm, Sat/ Sun 9 am to 5pm, CST). (Phone support is closed on holidays.)



•Use only the supplied AD-0005 AC adapter. Do not use any other AC adapter.

•Your phone maybe compatible with other Uniden 5.8Ghz Digital Expandable Systems. Look for the technology icon on our boxes or visit our website for a list of compatible models.

## Connect the expansion handset's charger

The handset is powered by a rechargeable battery pack. The battery recharges automatically when the handset is placed in the charger.

- 1) Connect the AC adapter to the DC IN 9V jack and to a standard 120V AC wall outlet.
- 2) Set the charger on a desk or tabletop, and place the handset in the charger with the sub-LCD screen facing forward.
- 3) Make sure that the **charge** LED illuminates.  
If the LED does not illuminate, check to see that the AC adapter is plugged in and the handset makes good contact with the charger charging contacts.
- 4) Charge the handset battery pack for at least 10 hours before using your new expansion handset for the first time.

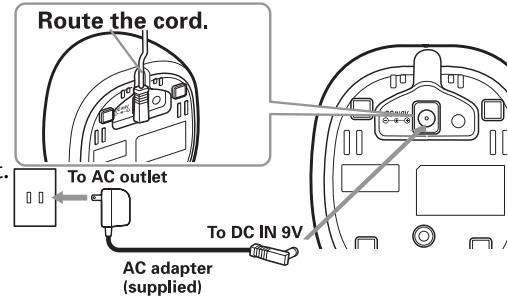

## Register the Handset

Any handsets supplied with the phone are registered to the base by the factory. Pre-registered handsets display a handset ID number. Handsets that have not been registered display **MUST** place the handset in base to register! Models may vary, refer to Owners Manual for help. in the LCD, and Handset must be registered in the sub LCD. When you register an extra handset to the base, the handset ID will be assigned. Only one handset can be registered at a time.

## Register the ELX500 expansion handset to the main base

Before the expansion handset is registered, the battery pack **MUST** be charged for **10 hours**.

To register an ELX500 handset, simply place it in the main base.

While the handset is registering, `Handset Registering` will appear in the LCD. When `Registration complete.` is displayed, the handset has been registered to the base. If `Registration failed.` appears, please try these steps again.

### To register a TCX860 handset, follow the steps below:

- 1) Remove the battery compartment cover from the back of the main base.
- 2) Press and hold the **Registration** button in the battery compartment.
- 3) Keep pressing the **Registration** button until the **handset charge** LED on main base start to blink.
- 4) On the handset, press and hold # until you hear a beep.

While the handset is registering, `Handset Registering` will appear in the LCD. When `Registration complete.` is displayed, the handset has been registered to the base. If `Registration failed.` appears, please try these steps again.

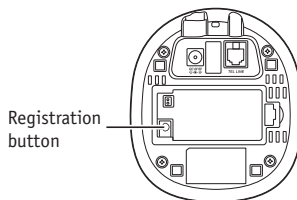



note

## Changing the Digital Security Code

The digital security code is an identification code used to connect the handset and the base unit. Normally, setting the code is not necessary. In the rare situation that you suspect another cordless telephone is using the same security code, you can change the code. To change the digital security code:

1. Perform the "System Reset" options ("De-register the Handset" and "Replacing the Base Setting") for all the handsets you have (see page 63).
2. Re-register each handset by following the steps on page 12.

## Installing the Holster

You must remove the holster to charge the handset.

- Line up the groove on the back of the handset with the groove on the holster. The handset fits in the holster only one way.
- Slide the phone into the holster.
- Use the spring clip to attach the holster to your belt or pocket.

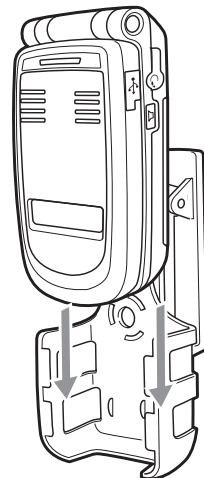

# Optional Headset Installation

Your phone may be used with an optional headset

To use an optional headset, insert the headset plug into the headset jack. Your phone is ready for hands-free conversations. (Headsets may be purchased by calling Uniden's Customer Hotline. See page 59.)

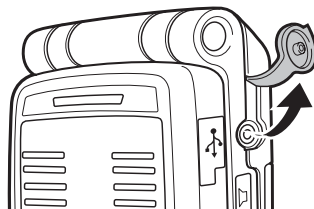



# Installing Uniden's Cordless Telephone Customization Tool

This phone includes Uniden's Cordless Telephone Customization Tool for your Windows PC. You can use this application to completely configure your phone, download pictures for wallpaper, and import contacts from Microsoft® Outlook®.

NOTE: The Uniden's Cordless Telephone Customization Tool application requires Microsoft®, Windows® 98SE, Windows ME, Windows 2000, Windows XP and more than 150MB free hard drive space.

- 1) Insert the Uniden's Cordless Telephone Customization Tool CD into your computer's CD-ROM drive. The installation application should start automatically.
- 2) If the application doesn't start, go to the **Start** menu and select **Run**.
- 3) In the window, type **d:\autorun.exe** (where **d** is the letter assigned to your CD-ROM drive), and click **OK**.
- 4) Once the software is installed, connect the USB cable to the handset and your PC as shown.
- 5) Customize your Uniden Cordless Handset.

For complete instructions on using the Uniden's Cordless Telephone Customization Tool, see the help file on the CD-ROM.

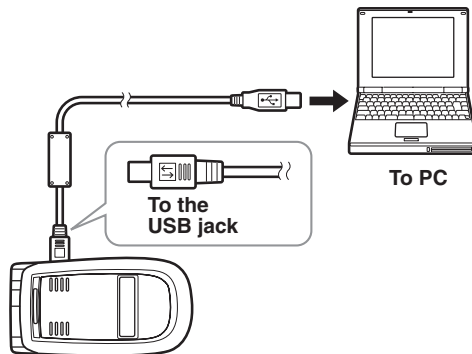

# Using the Interface

## Example of the standby mode display

### • Handset

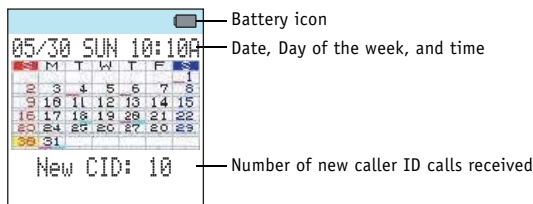

### • Sub-LCD

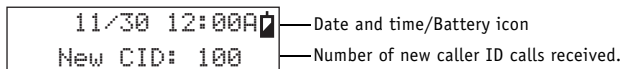

If you do not press a key within 30 seconds, the phone will time out and exit the menu mode. When setting Date and Time, the time-out period is extended to two minutes.

## Display Icons

ICON		DESCRIPTION
<b>Handset</b>	<b>Sub-LCD</b>	
		<b>Battery</b> icons indicate the handset battery status. This icon cycles depending on the battery status (empty, low, medium, and full).
		<b>Ringer off</b> icon indicates that ringer is turned off.
		<b>Mute</b> icon appears when you mute the handset.
		<b>Speaker</b> icon appears when the handset speaker phone is used.
	-	When a new message is received, an envelope icon is displayed on the LCD screen.
		<b>Privacy</b> icon appears when the Privacy Mode is turned on.

## Soft Key Function

"Soft" keys are keys that change function during the operation of the phone. There are two soft keys on the handset.

The text right above the soft key indicates that key's current function. For example, when the phone is in the main menu, pressing soft key 2 make a selection. When the phone is in talk mode, pressing soft key 2 brings up the options menu. Complete information on the features controlled by the soft keys can be found under each feature.

### In Main Menu Handset

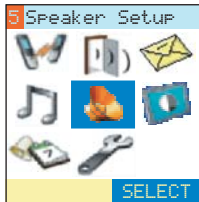

Soft key 2

### In talk mode

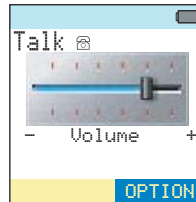

Soft key 2

To make menu selections, please follow the instructions below:

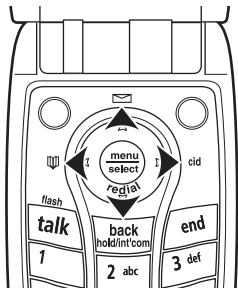

Press **menu/select**.

Highlight the option you want by pressing the up, down, right, or left key on the handset. This will move the cursor; the option currently highlighted appears in reversed out text:

Select the highlighted option by pressing the **menu/select** key.

To exit the **MENU** and return to standby, press the **end** key on the handset.

To go back a level in the menu, press the **back/hold/int'com**.



If you do not press a key within 30 seconds, the phone will time out and exit the menu mode. When setting Date and Time, the time-out period is extended to two minutes.

## Entering text

You can use the number keypad on your phone to enter text by referring to the letters printed on each number key.

When you press the number key in a text entry field, the phone displays the first letter printed on the number key. Press the number key twice to display the second letter and three times to display the third. Capital letters are displayed first, then lower case letters, then the number on the key.

If two letters in a row use the same number key, enter the first letter, then use the right key to move the cursor to the next position to enter the second letter.

For example, to enter Movies:

- 1) Press 6 once to enter M.
- 2) Use right key to move the cursor to the right.
- 3) Press 6 six times to enter o.
- 4) Press 8 six times to enter v.
- 5) Press 4 six times to enter i.
- 6) Press 3 five times to enter e.
- 7) Press 7 eight times to enter s.
- 8) Press **menu/select** to end your text entry.

If you make a mistake while entering a name, use right or left key to move the cursor to the incorrect character. Press the **DELETE** soft key to erase the incorrect character, and then enter the correct character. To delete all characters in the text entry field, press and hold the **DELETE** soft key.

	Number of times key is pressed								
keys	1	2	3	4	5	6	7	8	9
1	1								
2 abc	A	B	C	a	b	c	2		
3 def	D	E	F	d	e	f	3		
4 ghi	G	H	I	g	h	i	4		
5 jkl	J	K	L	j	k	l	5		
6 mno	M	N	O	m	n	o	6		
7 pqrs	P	Q	R	p	q	r	s	7	
8 tuv	T	U	V	t	u	v	8		
9 wxyz	W	X	Y	w	x	y	z	9	
	&	<	>	<	>	/	(blank)	--	--
0 oper	.	,	:	?	!	@	'	"	*
	#	0							

# Main Menu Options

Your phone has the following main menu options:

**DirectLink, Room Monitor, Messages, Reminder, Speaker Setup, Display Options, Ringer Options, System Setup.**

Note:

- If you do not press a key within 30 seconds, the phone will time out and exit the menu mode. When setting Date and Time, the time-out period is extended to two minutes.
- All of these options can be configured in the Uniden's Cordless Telephone Customization Tool.

## Main Menu Options



Direct Link



Room Monitor



Messages



Ringer Options



Speaker Setup



Display Options



Reminder



System Setup





(System Setup)

Handset

Open to Answer

Any Key Answer

# System Setup Menu

## System Setup

### Handset Setup

The following submenu options must be set separately for each handset.

#### Open to Answer

Open to Answer lets you answer the phone by opening the cover of the handset. To turn on Open to Answer, go to **Open to Answer** and select **On**. A confirmation tone tells you that Open to Answer is active.

#### Any Key Answer

Any Key Answer lets you answer the phone by pressing any key on the number pad. To turn on Any Key Answer, go to **Any Key Answer** and select **On**. A confirmation tone tells you that Any Key Answer is active.

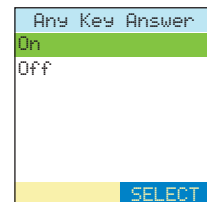
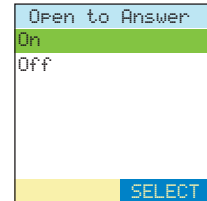

## Banner Display

You can change the name your phone displays on the screen. If you have more than one handset, you can use the banner name to identify your handset during handset-to-handset functions like intercom and DirectLink. Go to **Banner Display** and enter the name you want to use. You can use up to 10 characters. Use the **DELETE** soft key to delete an existing handset name. Press **menu/select** when you're finished.

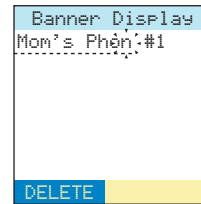

## Key Touch Tone

Key Touch Tone is the tone your keypad makes when keys are pressed.

To turn off the tone, go to **Key Touch Tone** and select **Off**. A confirmation tone tells you that the tone has been deactivated.

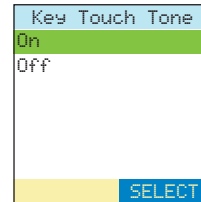

## Call Privacy

If you don't want other registered handsets to interrupt you on a call, you can turn on privacy mode. As long as your handset is in privacy mode, other handsets won't be able to join your call or make any calls of their own. To turn on privacy mode, go to **Call Privacy** and select **On**. You can turn on privacy mode when the phone is in standby or when you're already on a call.

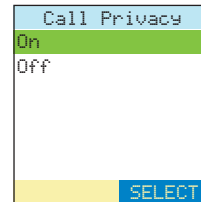

(System Setup)

Handset

Banner Display

Key Touch Tone

Call Privacy





(System Setup)

Handset

Unique ID

Global

## Unique ID

You can assign special ringer tones to anyone in your phonebook. When your phone gets a call, it looks up the Caller ID information in your phonebook; if you've assigned a distinctive ringer and pictures to that number, the phone uses it so you know who's calling. To turn on distinctive ringing, go to **Unique ID** and select **On**. A confirmation tone tells you that distinctive ringing is active.



When viewing a Caller ID entry, the picture that corresponds to the Phonebook Unique ID setting appears. If the Unique ID is set to **Off**, the phone uses the default picture for viewing Caller ID entries.

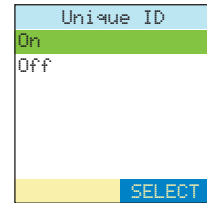

## Global Setup

Global settings apply to the handset and ELX500 handsets. If you change something under the global menu, you change it for all handsets. Only one handset can change global settings at a time, and you have to make sure the phone is not currently being used.



Some features may not be supported by older handsets.



## Date and Time

To change the date and time shown in the display, go to Date & Time. Use the up, down, right, left keys to highlight the part you want to change (date, time, AM/PM). Use the number keypad, or **tone/\*** to change each part. Press **menu/select** when you're finished.

Note: If you don't press any keys for two minutes when setting the date and time, the phone will exit the menu mode.

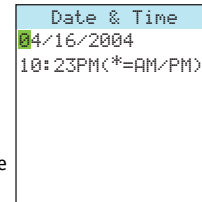

(System Setup)

Global

Date and Time

Call Waiting

## Call Waiting

Your phone supports Caller ID on Call Waiting, so you can see the name and number of someone who calls when you're already on the line. Your phone also supports Call Waiting Deluxe, which gives you a choice of how you want to handle a waiting call. You'll need to subscribe to these features with your phone company before you can use them.

To let your phone support these features, go to Call Waiting. Select **On**, and the phone will display the CallWaitDeluxe screen. Select **On**. (You have to turn on Call Waiting before you can turn on Call Waiting Deluxe.) A confirmation tone tells you that your phone is ready to use these features.

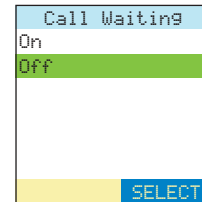



(System Setup)

Global

Area Code

Dial Mode

## Area Code

If you can make a call by dialing only 7 digits (instead of 10), you can program your local area code in your phone. If you get a call from within your area code, you'll only see the 7-digit phone number. If you get a call from outside your area code, you'll see all 10 digits.

To enter an area code, go to **Area Code**. Use the number keypad to enter your 3-digit area code. Press **menu/select** when you're finished.

Area Code
12
DELETE

## Dial Mode

Your phone can communicate with the telephone network in two different ways: tone dialing and pulse dialing. These days, most phone networks use a method called tone dialing, so your phone comes programmed for tone dialing.

If your phone company uses **pulse** dialing, you'll need to change your phone's dial mode. There's an easy way to tell: try making a call. If your call connects, your phone's setting is fine. If not, go to **Dial Mode** and select **Pulse**. A confirmation tone tells you you've changed the dial mode, and you can try making a call again.

Dial Mode
Tone
Pulse
SELECT

## Setting the Ringer Options

This menu lets you customize the ringer settings in your phone. You can set these options separately for each handset.



(Ringer Options)

### Ringer Tone

You can set a different ringer for each handset. This phone comes with 10 prerecorded songs and 15 different ringer tones; you can also record your own ringer tones (see page 28).

- Songs: Beethoven's Symphony #9 [Beethoven9], Fur Elise [Elise], Home Sweet Home [Hm Swt Hm], Lorri Song #6 [Lorri Song], WT Overture, Twinkle Star, Je Te Veux, Star Spangled Banner [Star Spangl], Old MacDonald [Old MacDld], We Wish You A Merry Christmas [Merry-Xmas]
  - Ringer tones: Flicker, Clatter, Coin Toss, Synthesize, Finish Line, Soft Alert, Wake Up, Lighting Bug, Bebop, Tone Board, Chirp, Party Clap, Reminder, Burble, TeleTone.
- 1) Go to **Ringer Tones** and highlight the ringer you want. (each ringer will sound as you highlight it.)
  - 2) Select a ringer from the list.
  - 3) Press **menu/select** to confirm the setting. You'll hear a confirmation tone, and the phone will go back to the menu.

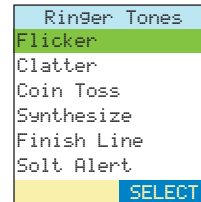

Ringer Tones



(Ringer Options)

Vibrate All

Call Vibrate

### Vibrate All

The vibrate alert causes the handset to vibrate when an incoming call is received. For safety reasons, the handset will not vibrate while it is charging in base. To turn on the Vibrate Alert for all incoming calls, intercom pages, etc., go to *Vibrate All* and select *On*. A confirmation tone tells you that Vibrate Alert is active.

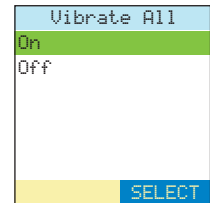

### Call Vibrate

You can choose a vibrate pattern (4 patterns (1-4) and Off). To set Vibrate Alert, go to *Vibrate Pattern* and then select the pattern. Selecting OFF will turn off the vibrate feature for incoming calls only. A confirmation tone tells you that Call Vibrate is active.

### Customize Your Own Distinctive Ringer Tones (Handset Only)

Your phone can store up to 5 different recordings to use as ringer tones (a total of 100 seconds). Each recording must be less than 20 seconds long.

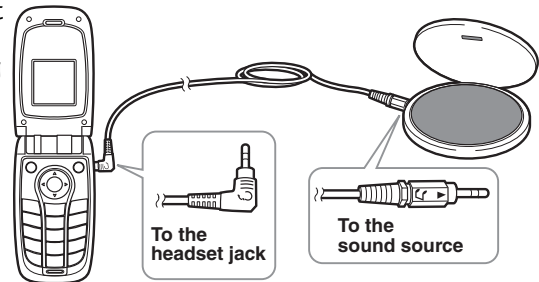

## Storing Ringer Tones

- 1) Connect the audio recording cable to the handset and sound source (e.g.stereo or cd player). Insert one end of the audio recording cable into the handset's headset jack and the other end into the sound source.  
You can also simply use the handset's microphone by holding the handset close to the sound source.
- 2) Go to Rec/Edit Rings.
- 3) Select a location from 1-5, and press the **OPTIONS** soft key.
- 4) Select Record. To start recording, press the **RECORD** soft key.  
The LCD displays 20 and then begins to count down.
- 5) When you are finished recording, press the **STOP** soft key. The phone will play the recorded ringer. To re-record the ringer, press the **ReRec** soft key while playing the ringer.
- 6) Enter the title of this ringer (up to 12 digits) using the number keypad, the **DELETE** soft key, right, or left key.
- 7) Press **menu/select**, you will hear a confirmation tone, and Done! appears.



## Playing the Ringer

- 1) Go to Rec/Edit Rings.
- 2) Select a ringer to play, and press the **OPTIONS** soft key.
- 3) Use the up/down key to select Play. To stop, press **menu/select** or the **STOP** soft key.

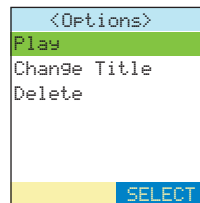

## Changing Ringer Name

- 1) Go to *Rec/Edit Rings*.
- 2) Select a ringer you want to change the title, and press the **OPTIONS** soft key.
- 3) Use the up/down key to select *Change Title*.
- 4) Edit the title of this ringer (up to 12 characters) using the number keypad, the **DELETE** soft key, right, or left key.  
When you are finished, press **menu/select**, you will hear a confirmation tone, and *Done!* appears.



## Deleting the Ringer

To delete a ringer tone, go to *Rec/Edit Rings*, and select the ringer you want to delete. Press **OPTIONS** soft key. Use the up/down key to select *Delete*. Select *Yes*. You will hear a confirmation tone, and *Deleted!* appears. The ringer is deleted from the list, and the phone stays on the ringer list.

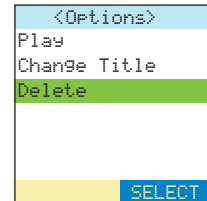

## Display Settings

The following submenu options must be set separately for each handset.



## Wallpaper/Image Displays

Your phone has 33 preset wallpaper/images to choose from. You can customize or replace 30 of these images using the software application CD-ROM supplied with this phone.

During standby mode the wallpaper will display on the Handset's LCD Screen. To set your wallpaper, scroll through the Wall Paper options, and press the **VIEW** soft key. Press **menu/select** to activate the wallpaper of your choice. You can download images using the PC Cordless Customization Tool and use them for your wallpaper.

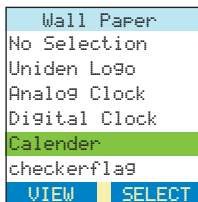

(Display Options)

Wall Paper

Color Scheme

## Color Scheme

You can change the color of your phone's display. There are 5 different colors to choose from: Sky Blue, Haze Gray, Chic Purple, Coral Red, and Lime Green.

To change the color of the display, go to Color Scheme and select the color you want. As you scroll through the options, the phone displays the highlighted color for you.







(Display Options)

LCD Contrast

### LCD Contrast

LCD Contrast adjusts the handset's display. To adjust the contrast, go to LCD Contrast. Use the up/down key to adjust the contrast. Press **menu/select** to activate it. you will hear a confirmation tone.



## Animation Type

Your phone has 4 different system animations (Dog, Car, Frog and Abstract) with 10 different animation schemes:



delete



done



page



talk



Low Battery



end



unavailable

To set your animation type, scroll through Animation Type options, and press the **VIEW** soft key. Press *menu/select* to activate the animation type of your choice.



## Language

You can change the language the menu display will use. Choose from English, French, or Spanish. To change the language, go to Language and select English, Français (French), or Español (Spanish). You'll hear a confirmation tone, and the display will use the selected language.



(Display Options)

Animation Type

Language



- When you dial the number, hyphens are inserted between numbers.
- If the line is already in use, all registered handsets that are not currently in use will display "InUse."
- For best performance, use the speaker phone in a quiet room and let the caller finish speaking before you speak. If you or the other party has difficulty hearing, adjust the speaker volume.

## Using Your Phone

- 1) Remove the handset from the charging cradle.
- 2) Flip the top panel up.
- 3) Press **talk/flash**.
- 4) Listen for the dial tone.
- 5) Dial the number.

OR

- 1) Remove the handset from the charging cradle.
- 2) Flip the top panel up.
- 3) Dial the number.

If you need the phone to pause before dialing more digits (for example, to enter an access code or extension), press **menu/select**, and select **Pause Entry** from the list. P appears in the display, which represents a 2-second pause.

- 4) Press **talk/flash**.

### From the Handset Speakerphone

- 1) Remove the handset from the charging cradle.
- 2) Flip the top panel up.
- 3) Press **Speaker Phone** on the side of the handset.
- 4) Listen for the dial tone.
- 5) Dial the number.
- 6) When the other party answers, talk into the microphone in the bottom of the handset.

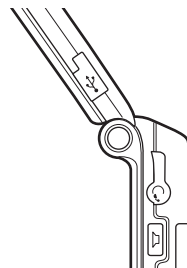
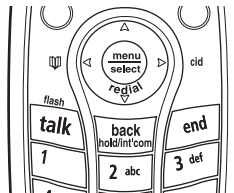

## Receiving a call/AutoTalk set to OFF

Handset is in the cradle	Handset is off the cradle
1) Remove the handset from the charging cradle. 2) Flip the top panel up. 3) Press <b>talk/flash</b> .	1) Flip the top panel up. 2) Press <b>talk/flash</b> .

### Hanging Up

Press **end** or close the top panel.

### Switching to the Handset Speakerphone During a Call

To switch a normal call to the speakerphone, press **▷** (speaker phone) on the handset. To switch from a speakerphone call to a normal call, press **▷** (speaker phone).

### Moving out of range

If you move your handset farther from the base unit during a call, you might start to hear more noise than usual. If you go too far from the base, you'll hear a beep and see **No Signal Press HELP** on the display. The base will stay connected to the caller for another 35 seconds, so you can move back within range to return to the call.



- If Open to Answer is ON, the phone will automatically answer the call when you flip the top panel up (see page 22 for setting).
- If Any Key Answer is set to On, you can also press any number key on the keypad to answer a call (see page 22 for setting).
- While using the handset speaker phone or a headset, closing the top panel will not hang up the call.
- To scroll through the help, press the **>>|** soft key or right key.



- You must subscribe through your local telephone company to receive Call Waiting or Caller ID on call waiting service.
- Your phone can't show call waiting caller ID information when a call is on hold.

## Call Waiting

If you hear a call waiting tone while you're on a call, press **talk/flash** to switch to the new call. After a short pause, you'll hear the new caller. Press **talk/flash** again to go back to the original caller.

## Call Waiting Deluxe

If you subscribe to Call Waiting Deluxe (CWDX) from your phone company, you have several different options when you get a call waiting call. When you hear the call waiting tone, instead of answering the call, you can press **menu/select** or the **OPTION** soft key, and then select **CallWaitDeluxe**. Then, use the up/down key or press 1-7 to choose from the following options:

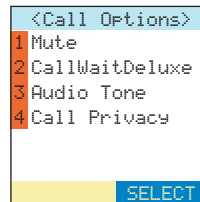

Option	Definition	Press
Ask to Hold	A prerecorded message tells the caller that you'll be available shortly, and the call is place on hold.	1
Tell Busy	A prerecorded message tells the caller you are busy, and the waiting call is disconnected.	2
Forward	The caller is sent to your voice mail box, if available.	3
Answer/Drop 1	Disconnects the first call, and connects to the new caller.	4
Conference	Starts a conference call with your first and second callers.	5
Drop First/Drop Last	During a conference call, allows you to choose to drop the first or last caller.	6 / 7

## Placing a Call on Hold

During a call, press **back/hold/int'com** and then **end**, to put the call on hold. Press **talk/flash** to go back to the call.

## Conferencing

If you have more than one handset, two handsets can talk to the outside caller at the same time in a conference call. Once a call is in progress, press **talk/flash** to join the call. To hang up, press **end**. The other handset will still be connected after you hang up. If the other handset is in privacy mode, you won't be able to join the call.

## Redialing Calls

You can quickly redial the last 20 phone numbers for each handset.

With the phone in standby mode, press **redial/▽** on the handset. This brings up the redial list. Use the up/down key to scroll through the numbers, and select the number you want to dial. Press **talk/flash** (or **▷**) or the **CALL** soft key to dial the selected number.

You can also display the redial list with the phone in talk mode. After selecting the redial number, press the **DIAL** soft key to redial the number.

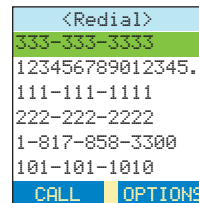
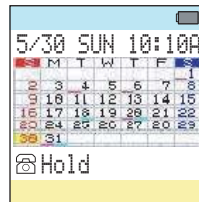

- If you leave a call on hold for more than 5 minutes, warning tone sounds and Hold reminder! Answer held line appears, and the line will disconnect in 15 seconds.
- If someone is using another handset in Privacy Mode, Unavailable appears in the display and you cannot join the call.



- Each redial record can store up to 32 digits.
- To store redial numbers in the Phonebook, see page 49.

### Deleting Redial Records

If you want to delete a phone number from the redial list, go to the redial list in standby mode, and select the number you want to delete. Press the **OPTIONS** soft key, and select `Delete Selection`, and then `Yes`. Press **menu/select**. If you want to delete all the redial records, select `Delete All`, and then `Yes`. Press **menu/select**.

## Using the Handset Volume Setting Menu

**Ringer:** Adjust the handset ringer volume

You can choose from three different ringer volume settings on your handset: off, low, and high. When the phone is in standby mode, go to Ringer Options, and then select Ringer Volume. Use the up/down key to select volume level and press **menu/select**. Use the up/down key to select the ringer volume, and **menu/select**. You will here a confirmation tone.

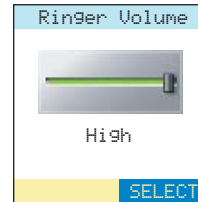

**Ear speaker:**

You can choose from six volume levels for the earpiece speaker. To adjust the earpiece volume, go to Speaker Setup menu, and select Earpiece Volume and select the volume level you want to use.

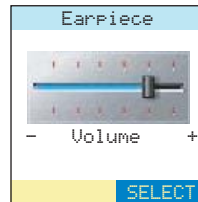

You can also adjust the earpiece volume during a call by pressing the  $\Delta$  or  $\nabla$  key on the side of the handset, and then up (to make it louder) or down (to make it softer).





(Speaker Setup)

Speaker Volume

Audio Tone

### **Speaker:** Adjust the handset speaker volume

You can choose from six volume levels for the handset speakerphone. To adjust the speaker volume, go to Speaker Setup menu, and select **Speaker Volume** select the volume level you want to use.

You can also adjust the handset speaker volume during a call by pressing the  $\nabla$  or  $\triangle$  key on the side of the handset, and then up (to make it louder) or down (to make it softer).

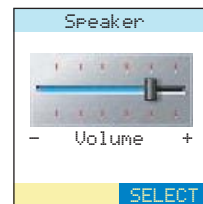

### **Audio Tone**

If you aren't satisfied with the audio quality of your phone, you can adjust the Audio Tone of the earpiece. Your phone gives you three audio tone options: low, natural or high. Go to Speaker Setup menu, and select **Audio Tone** and select the option that sounds best to you.

(Audio tone adjustments only apply to the earpiece, not the speakerphone.)

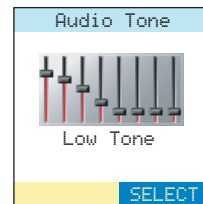

### **Mute**

While the handset is ringing, you can mute the handset ringer for this call by pressing **end** on the handset.

### **Mute the Handset Microphone**

When you're on the phone, press the **OPTIONS** key and select **Mute** to turn off the microphone so the caller can't hear you. The display shows **Mute On** while the microphone is muted. To turn off muting, repeat the above step again.

## Tone Dialing Switch Over

If your telephone company uses pulse dialing, you can switch over to tone dialing after the call connects. This feature is useful when you need tone dialing to use any automated menu systems, such as telephone bank tellers, telephone prescription refills, customer support menus, etc.

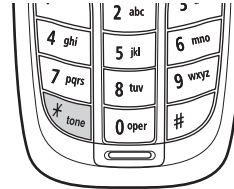

If your phone is set to pulse dialing mode, make your call normally. Once your call connects, press the **\*/tone** key. Any digits you enter from then on will be sent as tone digits. When this particular call ends, the phone automatically returns to pulse dialing mode.

## Privacy Mode

Privacy mode prevents interruption from other registered handsets. This works only when the phone is in use. While on a call, press the **OPTIONS** soft key on the handset. Use the up/down key to select Call Privacy and **P** appears in the display. To exit Privacy Mode, use the same procedure. Privacy Mode Off appears.

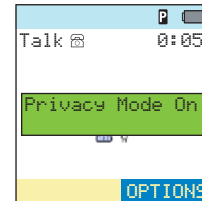

## Find Handset

To locate the handset, press **find hs** on the base when the phone is in standby mode. All handsets beep for 60 seconds, and Paging appears on the handset display. To cancel paging, press any key on the handset or **find hs** on the base.

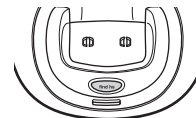



Before using this feature, you must set date and time (see page 25).



## Reminder



Date & Time must be set to use the Calendar features. To set Date & Time, scroll to Global System Setup options.

Your phone has a built-in calendar that you can use to schedule reminders and appointments (all the way through December 31, 2099). You can set alarms for up to 30 different events.

A pop-up screen appears and reminder tone sounds when the scheduled time & date comes. To show detailed info on the reminder, press the **VIEW** soft key. To mute the reminder tone, press the **MUTE** key.

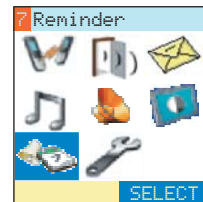

To reset the reminder and clear the screen, press **end** when reminder tone stops. To dismiss Reminder display press

**DISMISS** appears. Press the **DIMISS** soft key. The phone returns to standby mode.

## Scheduling a reminder

Select the Reminder option to show Reminder (Calendar). Today is highlighted. If the reminder is set for the morning, a bar appears in the lower left of the date number; if the reminder is set for the afternoon or evening, a bar appears in the lower right of the date number. Use up, down, right or left key to move the cursor to the date.

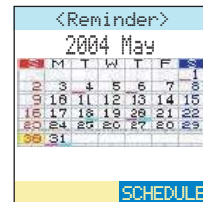

- 1) Press **menu/select** to select a date.
- 2) Press the **STORE** soft key to add a reminder.
- 3) Press **menu/select** to set the date and time.
- 4) Use the number keypad or **\*/tone** to select the hours and minutes. Press **menu/select** when you're finished.
- 5) To change the title, select **!** and press **menu/select**. Use the number keypad, left, right key, and the **DELETE** soft key. Press **menu/select** when you're finished.
- 6) If you want to set recurrence, select **Q**, and press **menu/select**. Select the frequency of the recurrence (None, Daily, Weekly, Monthly, Yearly) from the list. Press **menu/select** when you're finished.
- 7) If you want your phone to ring when this reminder occurs, move to the line marked with **J** and press **menu/select**. Select the ringer tone you want the phone to ring. Press **menu/select** when you're finished.
- 8) To enter a description for this reminder, select **!** and press **menu/select**. Edit Message appears. You can enter up to 80 characters. Press **menu/select** when you're finished.
- 9) When everything is correct, press the **DONE** soft key.



### Editing and deleting reminders

You can edit reminders by pressing the **SCHEDULE** soft key, then select the reminder and press the **OPTIONS** key. Select **Edit Selection**, and you can edit the date, time, reminder tone, and text the same way you entered them for a new entry.

To delete reminders, select the reminder and press the **OPTIONS** soft key. Select **Delete Selection**. To delete all reminders, select **Delete All**.



You must subscribe to voice mail service from your telephone company in order to use this feature. The voice mail service company will provide you with the access number.

## Using One Touch Voice Mail Access

If you subscribe to voice mail service, you can use your phone to access your voice mailbox. The new message LED flashes whenever you have messages waiting in your voice mailbox. Just program the handset with your access number, and you can get your messages at the touch of a button on the handset. (The voice mail service provider will supply you with the access number. This number may be simply a phone number. Refer to the provider's literature).

When you have messages, press . If you have not entered the access number or it has been deleted, when you press , No access no. Store number in Edit Voice Mail appears and you will hear a beep. The phone returns to standby mode.

## Programming your Voice Mail Access Number

Your phone can program or delete the voice mail access number. To edit voice mail number, go to Edit Voice Mail and then enter your personal access number (up to 20 digits). Press **menu/select** when you're finished.

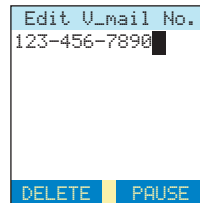

If you have an access number already entered, the current number will appear in the display. To delete that number, press the **DELETE** soft key. If you need to have the phone wait before sending the next digits, press the **PAUSE** soft key. Press **menu/select** when you're finished.

A P appears in the display each time you press the **PAUSE** soft key; each pause inserts a two-second delay in the dialing sequence, and each pause counts as one digit.

## Voice Mail Tone

If your voice mail service uses an SDT message signal to alert you of a new voice mail message, you will need to turn on the Voice Mail Tone.

If your voice mail service uses an FSK message signal to alert you of new voice mail messages, you can turn the Voice Mail Tone off. To turn off Voice Mail Tone, go to Voice Mail Tone and select Off.

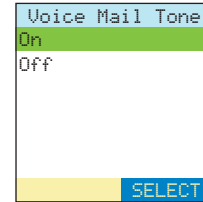

(System Setup)

Global

Voice Mail  
Tone

## Resetting the New Message LED

If the LED remains on after you've retrieved your messages, you may need to reset the indicators. With the phone in standby mode, press and hold **find hs** on the base until the paging sound stops (about 5 seconds).



## Using the Phonebook

Your phone lets you store up to 100 entries in each handset. You can store up to 4 phone numbers for each name in your phonebook (for a total of 400 numbers), and you can assign names to groups for easy searching. You can store a distinctive ringer tone and picture display to each or group.

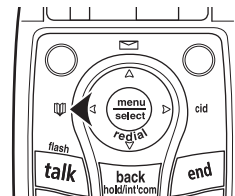
You can enter your phonebook by pressing the phonebook key on the handset.



### Creating and Editing Phonebook Entries

Press  and the **STORE** soft key for the first entry. From the 2nd entry on, press , and then the **OPTIONS** soft key. Select **New Entry** to store, or **Edit Selection** to edit the location. Enter as much of the following information as you want. Press **menu/select** to enter each entry and confirm the selection. When you're finished, press the **DONE** soft key to save this phonebook entry.



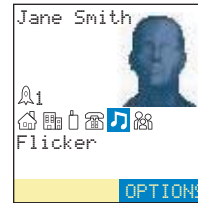

### Step 1: Name

Select  and use the keypad to enter the name for this entry. You can enter up to 16 characters. If you don't want to enter a name, your phone will store this entry as No Name. Press **menu/select** when you're finished, and your phone will go back to the current phonebook entry.



### Step 2: Number

Select  and enter a phone number for this entry. If you need your phone to pause between digits when it's dialing (for example, to enter an extension or an access code), press the **PAUSE** soft key to insert a two-second pause. You'll see a P in the display. You can stack more than one pause together if two seconds isn't long enough. Each pause counts as one digit; you can enter up to 20 digits for the phone number. Press **menu/select** when you're finished.

You can select an icon to remind you which number this is: home  work  mobile  or general phone number . Press **menu/select** when you're finished.

### Step 3: Unique Ring

Select  to attach a special ring to this phone. Select the ringer tone you want the phone to use when this person calls, or select No Selection to have the phone use its regular ringer tone. Press **menu/select** when you're finished, and your phone will go back to the current phonebook entry.



#### Step 4: Unique Display

Select  to attach a special screen display to this entry. Select the display you want the phone to use when this person calls, or select **No Selection** to have the phone use its regular display. You can press the **VIEW** soft key to see the display choices:

Press **menu/select** when you're finished, and your phone will go back to the current phonebook entry.

#### Step 5: Phonebook Group

Select  to place this entry into a phonebook group. Select the group (0-9) you want this entry to belong to, or select **No Selection** to leave the entry outside of any group. Press **menu/select** when you're finished, and your phone will go back to the current phonebook entry. See page 52 for information and editing groups names.

#### Step 6: Speed Dial

Select **0-9** to save this number to one of the 10 speed dial numbers or **No Selection** if you don't want to save it to a speed dial number. If there's already a phone number saved to the speed dial number you select, your phone will ask if you want to overwrite the number. Press **menu/select** when you're finished, and your phone will go back to the current phonebook entry. (see page 52 to make a call using a speed dial.)

## Storing Caller ID or Redial Numbers in the Phonebook

You can store Caller ID or redial numbers in your phonebook so you can use them later. Go to the Caller ID list or redial list and select the number you want to store. (If the Caller ID information didn't include the number, then you can't store it.).

- 1) With the phone in standby mode, go to the Caller ID list or redial list and select the number you want to store.
- 2) Press **OPTIONS** soft key, and then select `Add to Phonebook`.
- 3) Use the up/down key to select `New Entry` to enter a new phonebook location. If you want to added a number to the existing phonebook location, select `Store & Edit`, and then select a location to edit.
- 4) Enter each entry and confirm the selection by following the steps in pages 47-48.

## Storing and Editing Numbers from the Dial Operation

- 1) With the phone in standby mode, enter the number to store using the number keypad.
- 2) Press **menu/select** and select `Add to Phonebook`.
- 3) Use the up/down key to select `New Entry` to enter a new phonebook location. If you want to added a number to the existing phonebook location, select `Store & Edit`, and then select a location to edit.
- 4) Enter each entry and confirm the selection by following the steps in pages 47-48.

## Managing the Phonebook

With the **OPTIONS** soft key, you can delete phonebook entries, copy entries to another handset, check how many empty phonebook and speed dial entries you have available, sort your phonebook by groups, and name phonebook groups.

### Deleting phonebook entries

Go to the phonebook and select the entry you want to delete. Press the **OPTIONS** soft key and select `Delete Selection`. Your phone will ask you to confirm select `Yes`.

To delete all the entries from your phonebook, go to the phonebook and press the **OPTIONS** soft key. Select `Delete All`. Your phone will ask you to confirm select `Yes`.

### Copying phonebook entries to another handset

Note: When you copy entries to another handset, the group, unique ringer, unique display, and speed dial information won't be transferred. Your phone will cancel the copying process if any one of the following things occurs:

- If the handset you are copying to doesn't have enough memory (the phone will show "Not enough memory in receiving unit").
- If the handset you are copying to already has that phone number in its phonebook.
- A call comes in during the copying process.

To copy a single entry, go to the Phonebook and select the entry you want to copy. Press the **OPTIONS** soft key and then select **COPY Selection**. Select the handset you want to copy to the entry to.

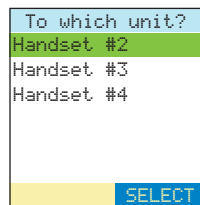

To copy all the phonebook entries, go to the phonebook and press the **OPTIONS** soft key without selecting an entry. Select then **COPY All**. Select the handset you want to copy to the entry to. Your phone will ask you to confirm select **Yes**.

### Checking the number of stored entries

To see how many phonebook entries you have, go to the phonebook and press the **OPTIONS** soft key and select **PhoneBk Capacity**. The phone will show you how many stored names (entries) and how many stored phone numbers (total) you have.



To see your speed dial entries, go to the phonebook and press the **OPTIONS** key and select **Check # Dial**. The phone will show you which speed dial numbers have phone numbers stored in them.

### Changing the sorting order

To change the sorting of your phonebook, go to the phonebook and press the **OPTIONS** soft key and select **Sort**. Select **Alphabetically** by pressing **menu/select** to see the list of names in alphabetical order; select **GROUP** by pressing **menu/select** to see the list of groups in alphabetical order. For alphabetical order, enter a letter from the keypad to jump to the first entry beginning with that letter.

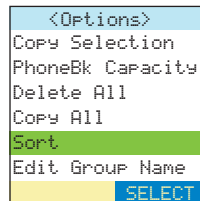

## Naming phonebook groups

Your phone comes with 10 groups to organize your phonebook. You can name groups things like "Family" or "Friends" or "Softball team" to let you find entries in your phonebook more quickly.

Follow the steps below to name a group:

- 1) Go to the Phonebook and select the **OPTIONS** soft key.
- 2) Scroll down to `Edit Group Name` and press **menu/select**.
- 3) Scroll down to the group number you want to edit, and press **menu/select**.
- 4) Use the number keypad to enter a name for this group. Press **menu/select** when finished.

## Making Calls with the Phonebook

To call someone in your phonebook, go to the phonebook and select that person's phonebook entry, and then press **menu/select**. Select the number (one of the four available) that you want to call, and then press **talk/flash** or **⏏**. You can also dial the number with the phone in talk mode. After select number, press the **DIAL** soft key. The number at the top of the list will dial.

## Using the Speed Dial

With the phone in standby mode. Press and hold the number of the speed dial entry you want to call until the phonebook entry appears. Select the number (one of the four available) that you want to call, and then press **talk/flash** or **⏏**.

# Caller ID Features

If you subscribe to Caller ID from your phone company, your phone will show you the caller's phone number and name (if available) whenever a call comes in.

If you subscribe to both Call Waiting and Caller ID the phone also shows you the name and the number of call waiting calls (that is, calls that come in while you're on the line.)

## Using the Caller ID List

You can store up to 100 Caller ID numbers in each handset. To see the Caller ID list, press the **cid** key on the handset. The phone will show the Caller ID list. You can use the up/down key to scroll through the list, or you enter a letter with the keypad to jump to the first caller ID name that starts with that letter.

If you want to see how many Caller ID numbers are stored in your phone, Press **cid**, and then the **OPTIONS** soft key. Select CID Capacity.

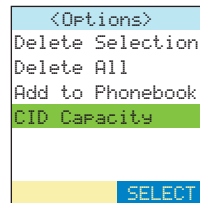
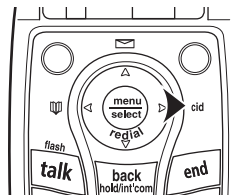
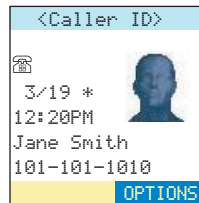



When you delete a Caller ID number, you delete it permanently.

### Calling someone from the Caller ID list

Go to the Caller ID list and select the number you want to call. If you need to add a "1" to the number for a long distance call, press *\*/tone*. If you need to add your saved area code to the number, press *#*. Then press *talk/flash* or  $\triangleright$  to dial the number.

### Deleting Caller ID numbers

To delete only one Caller ID number, go to the Caller ID list and select the number you want to delete. Press the **OPTIONS** soft key, and select `Delete Selection`. When the phone asks you to confirm, select `Yes`.

To delete all the Caller ID numbers, go to the Caller ID list and press the **OPTIONS** soft key. Select `Delete All`. When the phone asks you to confirm, select `Yes`.

# Multi-Handset Features

The features in this section require a minimum of two handsets to operate. To add additional handsets to your system, see "Expanding Your Phone" on page 11.

## Using DirectLink Mode

In DirectLink Mode, a pair of handsets can function as two-way radios. DirectLink Mode does not interfere with the main base's ability to make or receive telephone calls. You must set both handsets to DirectLink Mode to make a directlink call.

To enter DirectLink mode, Select Direct Link option in the main menu. And then press the **ENTER** soft key. Direct Link Mode complete. appears.

To make a DirectLink call, press the **DirectLink** soft key. Select the handset you want to call. To cancel the call, Press **end**. To answer a DirectLink call, Press **talk/flash** or  $\triangleright$ . Press **end** when you want to hang up.

To exit DirectLink mode and be able to receive normal phone calls again, press the **CANCEL** soft key, and then press the **OK** soft key.

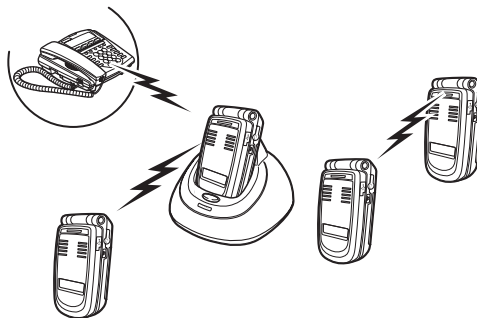

- If the party is out of range, **Unavailable** appears in the display, and the operation will be canceled.
- While a pair of handsets are in Intercom DirectLink Monitor, they cannot be used to make or receive calls. Other handsets can still make and receive calls.





- This feature only works when the handset is within the range of the base.
- If the party is out of range, *Unavailable* appears in the display, and the operation will be canceled.
- While a pair of handsets are in Room/Baby Monitor mode, they cannot be used to make or receive calls. Other handsets can still make and receive calls. (The monitoring handset hears a ringer tone.)

## Room/Baby Monitor

This feature allows you to monitor sounds in another room. Place a handset in the room you wish to monitor; it will function as a microphone. A second handset can be used as a remote speaker, allowing you to monitor sounds in the room.

### Using Room/Baby Monitor

To enter Room Monitor mode, press **menu/select**. Then select the Room Monitor. Select the handset you want to monitor. Press **end** when you want to stop monitoring.

To prevent the monitoring of a particular handset, simply turn off the Room Monitor feature on that handset.

To turn off the Room Monitor, go to System Setup, Handset and then Room Monitor. Select Off. You will hear a confirmation tone.

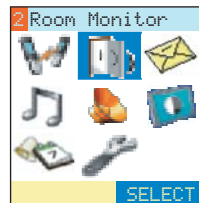
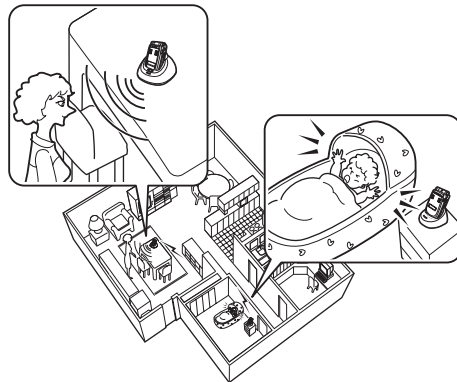

## Intercom

You can use the intercom to talk to another handset without using the phone line. While the phone is in standby mode, press **back/hold/int'com**. Select the handset you want to page. If you select **All**, all other handsets will be paged.

If the handset you're trying to page is busy, the phone displays `System busy Please try later`. If the handset you're trying to page is out of range, the phone displays `No Signal Press HELP`. The page is canceled.

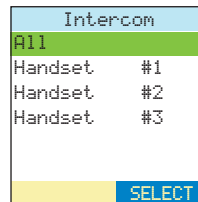

## Answering an intercom page

When the handset receives an intercom page, it sounds a tone and shows the ID of the handset that is paging. To answer the page, pick up the handset and press **talk/flash** or **⏏** on the handset.

- If you receive an outside/intercom call or page while selecting the other handset, the operation is canceled.
- If the party does not answer within one minute, the operation is canceled.
- During an intercom call, if you receive a call, you will hear a ringer tone from the ear speaker.
- If all handsets are paged, only the first party to answer the page will connect.
- If you do not select a handset within 30 seconds, the operation will be canceled.

To hang up an intercom page, press **end** on either handset.

## Transferring a Call

You can transfer a call from one handset to another. During a call, press **back/hold/int'com**; this will put the call on hold. Select the handset you want to page. If you select **All**, all other handsets will be paged. To cancel the page and go back to the caller, press **talk /flash**.

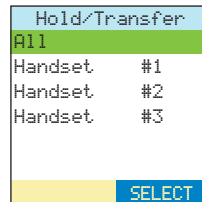

## Answering a transfer page

When the handset receives a transfer page, it sounds a tone and shows the ID of the handset that is paging. Press **talk/flash** or **▷** to answer the page. If you want to accept the transfer and talk to the outside caller, press **talk/flash**.

# Note on Power Sources

## Power Failure

The phone use the backup battery in the base. It provides power backup in the event of a power failure or outage. You will be able to make or receive calls with the telephone.

## Battery replacement and handling

When the operating time becomes short, even after the battery is recharged, please replace the battery. With normal usage, your battery should last about one year.

## Warning

To avoid the risk of personal injury or property damage from fire or electrical shock, use only Uniden AD-800 AC adapters and Uniden BT-0002 and BT-446 battery backs with your phone.

### Caution

- Use only the specified Uniden battery pack (BT-0002 and BT-446).
- Do not remove the batteries from the handset to charge them.
- Never throw the battery into a fire, disassemble them, or heat them.
- Do not remove or damage the battery casing.



- A replacement Uniden adapter or battery may be purchased by calling 1-800-554-3988 (Mon - Fri 8 am to 5 pm, CST).
- Use only the Uniden (BT-0002 and BT446) rechargeable battery packs supplied with your cordless phone.

## General Information

The phone complies with FCC Parts 15 and 68. Operating temperature:  
0 °C to +50 °C (+32 °F to +122 °F)

### AC Adapter Information

AC Adapter part number: AD-800  
Input Voltage: 120V AC 60Hz  
Output Voltage: 9V DC 350mA

### Battery Information

Battery part number:	BT-0002 (Handset)	BT-446 (Base)
Capacity:	980mAh, 3.7V	800mAh, 3.6V

Specifications, features, and availability of optional accessories are all subject to change without prior notice.

# Troubleshooting

If your phone is not performing to your expectations, please try these simple steps first. If these steps do not solve your problem, please call our Customer Hotline at 1-800-297-1023. (Mon - Fri 7 am to 7 pm, Sat/Sun 9 am to 5 pm, CST. Phone support is closed on holidays.)

Symptom	Suggestion
The <b>charge</b> LED won't illuminate when the handset is placed in the cradle.	<ul style="list-style-type: none"><li>• Make sure the AC adapter is plugged into the base or the charger (if you have more than one handset) and wall outlet.</li><li>• Make sure the handset is properly seated in the cradle.</li><li>• Make sure the charging contacts on the handset are clean.</li></ul>
The audio sounds weak.	<ul style="list-style-type: none"><li>• Move the handset and/or base away from metal objects or appliances and try again.</li><li>• Make sure that you are not too far from the base.</li></ul>
Can't make or receive calls.	<ul style="list-style-type: none"><li>• Make sure that you are not too far from the base.</li><li>• Make sure the line is not in use. If an outside call is already using a line, you cannot use that line to make another outside call.</li><li>• Check both ends of the base telephone line cord.</li><li>• Make sure the AC adapter is plugged into the base and wall outlet.</li><li>• Disconnect the AC adapter and the backup battery.</li><li>• Change the Digital Security Code (see page 14).</li></ul>
The handset doesn't ring or receive a page.	<ul style="list-style-type: none"><li>• Make sure that you are not too far from the base.</li><li>• Charge the battery pack in the handset for 10 hours by placing the handset on the base or charging cradle.</li><li>• Change the Digital Security Code (see page 14).</li></ul>
Severe noise interference.	<ul style="list-style-type: none"><li>• Keep the handset away from microwave ovens, computers, remote control toys, wireless microphones, alarm systems, intercoms, room monitors, fluorescent lights, and electrical appliances.</li><li>• Move to another location or turn off the source of interference.</li></ul>

Symptom	Suggestion
The Caller ID does not display.	<ul style="list-style-type: none"><li>• The call was placed through a switchboard.</li><li>• Call your local telephone company to verify your Caller ID service is current. There may be a problem with your Caller ID service.</li></ul>
You cannot register the handset at the base.	<ul style="list-style-type: none"><li>• Charge the battery pack for 10 hours.</li><li>• Change the Digital Security Code (see page 14).</li></ul>
The handset doesn't communicate with other handsets.	<ul style="list-style-type: none"><li>• Change the Digital Security Code (see page 14).</li><li>• Make sure that you have registered all handsets.</li></ul>
An extra handset can't join the conversation.	<ul style="list-style-type: none"><li>• Make sure there are not 2 handsets already using the conference feature.</li><li>• Make sure that another handset is not in privacy mode.</li></ul>
Room Monitor feature does not work.	<ul style="list-style-type: none"><li>• Make sure to place the handset(s) within the range of the base.</li></ul>

## System Reset

### De-register the Handset

- 1) Press and hold **end** and **#** for more than 5 seconds. Select Deregister HS.
- 2) The phone will ask you to confirm the deregistration. Select Yes.

When the base information is deleted, the handset displays

MUST Place the handset in base to register! Models may vary, refer to Owners Manual for help. Re-register the handset to the base (see page 12).

### Replacing the Base Setting

- 1) Press and hold **end** and **#** for more than 5 seconds. Select Replacing Base.
- 2) Select Yes.
- 3) You will hear a confirmation tone. The base information will be deleted.

When the base information is deleted, the handset displays

MUST Place the handset in base to register! Models may vary, refer to Owners Manual for help. Re-register the handset to the base (see page 12).

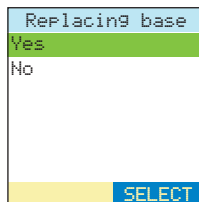
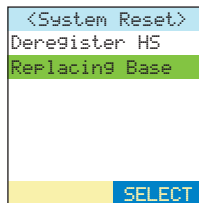
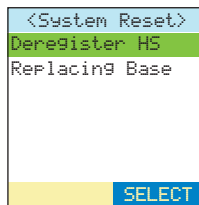



# Liquid Damage

Moisture and liquid can damage your cordless phone. Follow the steps below if your phone gets wet:

Case	Action
If the handset or base is exposed to moisture or liquid, but only the exterior plastic housing is affected.	Wipe off the liquid, and use as normal.
If moisture or liquid has entered the plastic housing (i.e. liquid can be heard in the phone or liquid has entered the handset battery compartment or vent openings on the base).	<p><b>Handset:</b></p> <ol style="list-style-type: none"><li>1) Remove the battery cover and leave it off for ventilation.</li><li>2) Disconnect the battery pack. Leave the battery cover off and the battery pack disconnected for at least 3 days.</li><li>3) Once the handset is completely dry, reconnect the battery pack and the battery cover.</li><li>4) Recharge the handset's battery pack for 20 hours before using.</li></ol> <p><b>Base:</b></p> <ol style="list-style-type: none"><li>1) Disconnect the AC adapter from the base, cutting off electrical power.</li><li>2) Disconnect the telephone cord from the base.</li><li>3) Let dry for at least 3 days.</li></ol> <p><b>IMPORTANT:</b> You must <b>unplug the telephone line while recharging the battery packs</b> to avoid charge interruption.</p> <p><b>CAUTION:</b> DO NOT use a microwave oven to speed up the drying process. This will cause permanent damage to the handset, base and the microwave oven.</p> <p>After following these steps, if your cordless telephone does not work, please call our Customer Service Hotline at 1-800-297-1023.</p>

## Precautions!

Before you read anything else, please observe the following:

### Warning!

Uniden America Corporation DOES NOT represent this unit to be waterproof. To reduce the risk of fire, electrical shock, or damage to the unit, DO NOT expose this unit to rain or moisture.

## Rechargeable Lithium Ion and Nickel-Metal-Hydride Battery Warning

- This equipment contains rechargeable Lithium Ion and Nickel-Metal-Hydride battery.
- The rechargeable batteries contained in this equipment may explode if disposed of in a fire.
- Nickel is a chemical known to state of California to cause cancer.
- Do not short-circuit the battery.
- Do not charge the rechargeable battery used in this equipment in any charger other than the one designed to charge this battery as specified in the owner's manual. Using another charger may damage the battery or cause the battery to explode.

## Rechargeable Batteries Must Be Recycled or Disposed of Properly



The exclamation point within an equilateral triangle is intended to alert the user to the presence of important operating and maintenance (servicing) instructions in the literature accompanying the appliance.

Uniden works to reduce lead content in our PVC coated cords in our products and accessories.

### Warning!

The cords on this product and/or accessories contain lead, a chemical known to the State of California to cause birth defects or other reproductive harm. **Wash hands after handling.**

## Important Safety Instructions

When using your telephone equipment, basic safety precautions should always be followed to reduce the risk of fire, electric shock and injury to persons, including the following:

1. Do not use this product near water, for example, near a bath tub, wash bowl, kitchen sink or laundry tub, in a wet basement or near a swimming pool.
2. Avoid using a telephone (other than a cordless type) during an electrical storm. There may be a remote risk of electric shock from lightning.

3. Do not use the telephone to report a gas leak in the vicinity of the leak.
4. Use only the power cord and batteries indicated in this manual. Do not dispose of batteries in a fire. They may explode. Check with local codes for possible battery disposal instructions.
5. Do not disassemble any component of this product.

## SAVE THESE INSTRUCTIONS

### CAUTION

Risk of explosion if battery is replaced by an incorrect type. Dispose of used batteries according to the instructions. Do not open or mutilate the battery, and disconnect the battery before shipping this product.

## The FCC Wants You To Know

This equipment complies with Part 68 of the FCC rules and the requirements adopted by the ACTA. On the bottom of this equipment is a label that contains, among other information, a product identifier in the format US:AAAEQ#TXXXX. If requested, this number must be provided to the telephone company.

An applicable Universal Service Order Codes (USOC) certification for the jacks used in this equipment is provided (i.e., RJ11C) in the packaging with each piece of approved terminal equipment.

A plug and jack used to connect this equipment to the premises wiring and telephone network must comply with the applicable FCC Part 68 rules and requirements adopted by the ACTA. A compliant telephone cord and modular plug is provided with this product. It is designed to be connected to a compatible modular jack that is also compliant. See installation instructions for details.

The REN is used to determine the number of devices that may be connected to a telephone line. Excessive RENs on a telephone line may result in the devices not ringing in response to an incoming call. In most but not all areas, the sum of RENs should not exceed five (5.0). To be certain of the number of devices that may be connected to a line, as determined by the total RENs, contact the local telephone company. For products approved after July 23, 2001, the REN for this product is part of the product identifier that has the format US:AAAEQ#TXXXX. The digits represented by # are the REN without a decimal point (e.g., 03 is a REN of 0.3). For earlier products, the REN is separately shown on the label.

If this equipment causes harm to the telephone network, the telephone company will notify you in advance that temporary discontinuance of service may be required. But if advance notice isn't practical, the telephone company will notify the customer as soon as possible. Also, you will be advised of your right to file a complaint with the FCC if you believe it is necessary.

The telephone company may make changes in its facilities, equipment, operations or procedures that could affect the operation of the equipment. If this happens the telephone company will provide advance notice in order for you to make necessary modifications to maintain uninterrupted service.

Please follow instructions for repairing, if any (e.g. battery replacement section); otherwise do not substitute or repair any parts of the device except as specified in this manual. Connection to party line service is subject to state tariffs. Contact the state public utility commission, public service commission or corporation commission for information. This equipment is hearing aid compatible.

Should you experience trouble with this equipment, please contact Uniden customer service at 800-297-1023. If the equipment is causing harm to the telephone network, the telephone company may request that you disconnect the equipment until the problem is resolved.

NOTICE: According to telephone company reports, AC electrical surges, typically resulting from lightning strikes, are very destructive to telephone equipment connected to AC power sources. To minimize damage from these types of surges, a surge arrester is recommended.

Changes or modifications to this product not expressly approved by Uniden, or operation of this product in any way other than as detailed in the owner's manual, could void your authority to operate this product.

This device complies with part 15 of the FCC rules. Operation is subject to the following two conditions: (1) This device may not cause harmful interference, and (2) This device must accept any interference received, including interference that may cause undesired operation. Privacy of communications, may not be ensured when using this phone. To insure the safety of users, the FCC has established criteria for the amount of radio frequency energy various products may produce depending on their intended usage. This product has been tested and found to comply with the FCC's exposure criteria. For body worn operation, the FCC RF exposure guidelines were also met when used with the Uniden accessories supplied or designed for this product. Use of other accessories may not ensure compliance with FCC RF exposure guidelines and should be avoided.

## Radio Interference

Radio interference may occasionally cause buzzing and humming in your cordless handset, or clicking noises in the base. This interference is caused by external sources such as TV, refrigerator, vacuum cleaner, fluorescent lighting, or electrical storm. Your unit is NOT DEFECTIVE. If these noises continue and are too distracting, please check around your home to see what appliances may be causing the problem. In addition, we recommend that the base not be plugged into a circuit that also powers a major appliance because of the potential for interference. Be certain that the antenna on the unit is fully extended when needed.

In the unlikely event that you consistently hear other voices or distracting transmissions on your phone, you may be receiving radio signals from another cordless telephone or other source of interference. If you cannot eliminate this type of interference, you need to change to a different channel.

Finally, it should be noted that some cordless telephones operate at frequencies that may cause interference to nearby TVs and VCRs. To minimize or prevent such interference, the base of the cordless telephone should not be placed near or on top of a TV or VCR. If interference is experienced, moving the cordless telephone farther away from the TV or VCR will often reduce or eliminate the interference.

### Cordless Telephone Privacy

Cordless telephones are radio devices. Communications between the handset and base of your cordless telephone are accomplished by means of radio waves which are broadcast over the open airways. Because of the inherent physical properties of radio waves, your communications can be received by radio receiving devices other than your own cordless telephone unit. Consequently, any communications using your cordless telephone may not be private.

### One Year Limited Warranty

**Important:** Evidence of original purchase is required for warranty service.

**WARRANTOR:** UNIDEN AMERICA CORPORATION ("Uniden") ELEMENTS OF WARRANTY: Uniden warrants, for one year, to the original retail owner, this Uniden Product to be free from defects in materials and craftsmanship with only the limitations or exclusions set out below.

**WARRANTY DURATION:** This warranty to the original user shall terminate and be of no further effect 12 months after the date of original retail sale. The warranty is invalid if the Product is (A) damaged or not maintained as reasonable or necessary, (B) modified, altered, or used as part of any conversion kits, subassemblies, or any configurations not sold by Uniden, (C) improperly installed, (D) serviced or repaired by someone other than an authorized Uniden service center for a defect or malfunction covered by this warranty, (E) used in any conjunction with equipment or parts or as part of any system not manufactured by Uniden, or (F) installed or programmed by anyone other than as detailed by the owner's manual for this product.

**STATEMENT OF REMEDY:** In the event that the product does not conform to this warranty at any time while this warranty is in effect, warrantor will either, at its option, repair or replace the defective unit and return it to you without charge for parts, service, or any other cost (except shipping and handling) incurred by warrantor or its representatives in connection with the performance of this warranty. Warrantor, at its option, may replace the unit with a new or refurbished unit. THE LIMITED WARRANTY SET FORTH ABOVE IS THE SOLE AND ENTIRE WARRANTY PERTAINING TO THE PRODUCT AND IS IN LIEU OF AND EXCLUDES ALL OTHER WARRANTIES OF ANY NATURE WHATSOEVER, WHETHER EXPRESS, IMPLIED OR ARISING BY OPERATION OF LAW, INCLUDING, BUT NOT LIMITED TO ANY IMPLIED WARRANTIES OF MERCHANTABILITY OR FITNESS FOR A PARTICULAR PURPOSE. THIS WARRANTY DOES NOT COVER OR PROVIDE FOR THE REIMBURSEMENT OR PAYMENT OF INCIDENTAL OR CONSEQUENTIAL DAMAGES. Some states do not allow this exclusion or limitation of incidental or consequential damages so the above limitation or exclusion may not apply to you.

**LEGAL REMEDIES:** This warranty gives you specific legal rights, and you may also have other rights which vary from state to state. This warranty is void outside the United States of America and Canada.

**PROCEDURE FOR OBTAINING PERFORMANCE OF WARRANTY:** If, after following the instructions in the owner's manual you are certain that the Product is defective, pack the Product carefully (preferably in its original packaging). Disconnect the battery from the Product and separately secure the battery in its own separate packaging within the shipping carton. The Product should include all parts and accessories originally packaged with the Product. Include evidence of original purchase and a note describing the defect that has caused you to return it. The Product should be shipped freight prepaid, by traceable means, to warrantor at:

#### Uniden America Service

4700 Amon Carter Blvd.

Fort Worth, TX 76155

(800) 297-1023, 7:00 a.m. to 7:00 p.m. Monday through Friday; 9:00 a.m. through 5:00 p.m., Saturday and Sunday; all Central Time,

# I.C. Notice

## TERMINAL EQUIPMENT

**NOTICE:** This equipment meets the applicable Industry Canada Terminal Equipment Technical Specifications. This is confirmed by the registration number. The abbreviation, IC, before the registration number signifies that registration was performed based on a Declaration of Conformity indicating that Industry Canada technical specifications were met. It does not imply that Industry Canada approved the equipment.

**NOTICE:** The Ringer Equivalence Number (REN) for this terminal equipment is marked on the equipment itself. The REN assigned to each terminal equipment provides an indication of the maximum number of terminals allowed to be connected to a telephone interface. The termination on an interface may consist of any combination of devices subject only to the requirement that the sum of the Ringer Equivalence Numbers of all the devices does not exceed five.

## RADIO EQUIPMENT

The term "IC:" before the radio certification number only signifies that Industry Canada technical specifications were met.

Operation is subject to the following two conditions: (1) this device may not cause interference, and (2) this device must accept any interference, including interference that may cause undesired operation of the device. "Privacy of communications may not be ensured when using this telephone".

# Index

## A

Animations . . . . .	33
Anykey Answer . . . . .	22
Area Code . . . . .	26
Audio Tone . . . . .	40

## B

Backup battery . . . . .	7
Banner . . . . .	23
Battery	
Installation . . . . .	8
Replacement . . . . .	59

## C

Calendar . . . . .	42
Call privacy . . . . .	23
Call transfer feature . . . . .	58
Call Vibrate . . . . .	28
Caller ID	
Call Waiting . . . . .	36
CWDX . . . . .	36
Color Scheme . . . . .	31
Conference . . . . .	37

## D

Date & time . . . . .	25
Delete ringer . . . . .	30
De-register the Handset . . . . .	63
Dial mode . . . . .	26
Digital security code . . . . .	14
DirectLink . . . . .	55

## E

Expanding your phone . . . . .	11
--------------------------------	----

## F

Find handset . . . . .	41
------------------------	----

## G

General information . . . . .	60
Global set . . . . .	24

## H

Handset setup . . . . .	22
Hands-free conversation . . . . .	34
Hanging up . . . . .	35
Headset installation . . . . .	15
Hold . . . . .	37
Holster . . . . .	14

## I

I.C. notice . . . . .	67
Important safety instructions . . . . .	65
Intercom . . . . .	57

## K

Key touch tone . . . . .	23
--------------------------	----

## L

Language . . . . .	33
Liquid damage . . . . .	64
Low battery . . . . .	9

## M

Main Menu Options . . . . .	21
Mute	
Handset ringer . . . . .	40
Microphone . . . . .	40

## O

Open to Answer . . . . .	22
Out of range . . . . .	35

## P

Phonebook	
Capacity . . . . .	51
Copying entries . . . . .	50
Group . . . . .	48
Making calls . . . . .	52
Name . . . . .	47
Number . . . . .	47
Sort order . . . . .	51
Speed dial . . . . .	48
Unique display . . . . .	48
Unique ring . . . . .	47
Power failure . . . . .	59
Precautions . . . . .	65
Privacy mode . . . . .	23

## R

Receiving a call . . . . .	35
Record ringer . . . . .	28
Redialing a call . . . . .	37
Register the handset . . . . .	12
Reminder . . . . .	42
Ringer Tone	
Changing . . . . .	30
Deleting . . . . .	30
Playing . . . . .	29
Storing . . . . .	29
Ringer tone . . . . .	27
Ringer volume . . . . .	39
Room/baby monitor . . . . .	56

## S

Setting up	
base unit . . . . .	10
Telephone Line . . . . .	10

Soft Key . . . . .	18
Speaker phone . . . . .	34
Speaker Setup . . . . .	39
Speaker volume	
Handset . . . . .	40
Storing a caller ID or redial number	49
System Setup . . . . .	22
<b>T</b>	
Tone dial . . . . .	41
Transferring a call . . . . .	58
Troubleshooting . . . . .	61
<b>U</b>	
Uniden's Cordless Telephone	
Customization Tool . . . . .	16
Unique ID . . . . .	24
Unique Ring . . . . .	47
<b>V</b>	
Vibrate All . . . . .	28
<b>W</b>	
Wallpaper . . . . .	31
Warranty . . . . .	66

## At Uniden, we'll take care of you!

Thank you for purchasing a Uniden product. If you have any questions or problems,  
**please do not return this product to the place of purchase.**



### Having Trouble?

Our customer care specialists are here to help you! Visit our website at [www.uniden.com](http://www.uniden.com) or call our customer hotline at **1-800-297-1023**, Mon-Fri, 7 a.m. to 7 p.m. or Sat/Sun, 9 a.m. to 5 p.m. CST. (Phone support is closed on holidays.)



### Need a Part?

To order headsets, additional handsets, replacement batteries or other accessories, visit our website at [www.uniden.com](http://www.uniden.com) or call 1-800-554-3988, Mon-Fri, 8 a.m. to 5 p.m. CST.



### Help for our Special Needs Customers

If you need special assistance due to a disability or have questions on the accessibility features of this product, please call **1-800-874-9314 (voice or TTY)**

# Uniden®

May be covered under one or more of the following U.S. patents:

4,797,916	5,381,460	5,426,690	5,434,905	5,491,745	5,493,605
5,533,010	5,574,727	5,581,598	5,650,790	5,660,269	5,661,780
5,663,981	5,671,248	5,696,471	5,717,312	5,732,355	5,754,407
5,758,289	5,768,345	5,787,356	5,794,152	5,801,466	5,825,161
5,864,619	5,893,034	5,912,968	5,915,227	5,929,598	5,930,720
5,960,358	5,987,330	6,044,281	6,070,082	6,125,277	6,253,088
6,314,278	6,418,209	6,618,015	6,671,315	6,714,630	6,782,098
6,788,920	6,788,953				

Other patents pending.

FOR  
ACCESSORIES,  
GO ONLINE @  
WWW.UNIDEN.COM

**REGISTER ONLINE TODAY!**

**THANK YOU FOR BUYING A UNIDEN PRODUCT.**

A World Without Wires | **Uniden®**



## Free Manuals Download Website

<http://myh66.com>

<http://usermanuals.us>

<http://www.somanuals.com>

<http://www.4manuals.cc>

<http://www.manual-lib.com>

<http://www.404manual.com>

<http://www.luxmanual.com>

<http://aubethermostatmanual.com>

Golf course search by state

<http://golfingnear.com>

Email search by domain

<http://emailbydomain.com>

Auto manuals search

<http://auto.somanuals.com>

TV manuals search

<http://tv.somanuals.com>