

---

GDVRH Series

# DIGITAL VIDEO RECORDERS

User Guide



GDVRH-604 4 Channels

GDVRH-608 8 Channels

GDVRH-616 16 Channels



## SAFETY PRECAUTIONS



### **CAUTION:**

**TO REDUCE THE RISK OF ELECTRIC SHOCK, DO NOT REMOVE COVER (OR BACK).  
NO USER SERVICEABLE PARTS INSIDE. REFER SERVICING TO QUALIFIED  
SERVICE PERSONNEL.**



The lightning flash with arrowhead symbol, within an equilateral triangle, is intended to alert the user to the presence of an insulated “dangerous voltage” within the product’s enclosure that may be of sufficient magnitude to constitute a risk of electric shock to persons.



The exclamation point within an equilateral triangle is intended to alert the user to the presence of important operating and maintenance (servicing) instructions in the literature accompanying the appliance.

### **WARNING:**

**TO PREVENT FIRE OR ELECTRIC SHOCK HAZARD,  
DO NOT EXPOSE THIS APPLIANCE TO RAIN OR MOISTURE.**

---

# Contents

<b>Disclaimer</b> .....	5
<b>Warning</b> .....	5
<b>Caution</b> .....	6
<b>Preventing Malfunction</b> .....	7
<b>Regulatory</b> .....	7
<b>Package Contents</b> .....	8
<b>I.CONTROLS</b> .....	9
1. Front Panel .....	9
2. Rear Panel Connectors .....	11
3. Remote Controller .....	13
4. Virtual Keypad for Mouse Control.....	14
<b>II. INSTALLATION &amp; CONNECTIONS</b> .....	15
1. Camera, Monitor, Audio, Alarm sensor and Power cord .....	15
2. Alarm inputs and Alarm outs.....	16
2.1. Connection of N.O (Normally Open) .....	16
2.2. Connection of N.C (Normally Close).....	17
3. PTZ and controller connection .....	18
3.1. Connecting the Speed Dome directly into DVR .....	18
3.2. Connecting Both Speed Dome and DVR via J-box.....	18
3.3. Connecting Single User with 2 DVR Configuration .....	19
<b>III.QUICK START PAGE</b> .....	21
<b>IV.LIVE VIEWING</b> .....	23
1. Display Overview .....	23
2. Multi-screen Display and Sequencing .....	25
2.1. Screen Display. ....	25
2.2. Multi-screen Display and Switch Sequencing Display.....	25
3. Quick button for multi screen Display.....	26
3.1. Quick multi split mode change.....	26
3.2. Repositioning .....	26
4. Zooming.....	27
5. Spot Monitor.....	28
<b>V. OPERATION</b> .....	29

---

1. LOG IN/OUT.....	29
2. NAVIGATION THE MENU .....	30
<b>VI. SETUP .....</b>	<b>31</b>
1. DISPLAY .....	31
1.1. GENERAL .....	31
1.2. SWITCH Setup (Monitor Configure) .....	32
1.3. EVENT .....	33
2. CAMERA .....	34
2.1. Video Adjustment .....	34
2.2. PTZ Set up .....	35
2.3. Camera Title .....	36
2.4. Motion Detection Setting.....	37
2.5. Privacy Mask .....	38
3. RECORD .....	38
3.1. Record General .....	39
3.2. Resolution & Recording speed Setting .....	40
3.3. Continues /Normal Recording .....	41
3.4. Event Recording .....	42
3.5 Continues + Event (Motion/Alarm) Recording .....	44
4. SCHEDULE .....	44
4.1. CHART Setup .....	45
4.2. Holiday Setup .....	46
5. DISK .....	47
5.1. DISK Manager.....	48
5.2. Recording DISK.....	50
5.3. S.M.A.R.T STATUS.....	51
6. NETWORK .....	52
6.1. ETHERNET.....	52
6.2. GENERAL .....	53
6.3. EMAIL.....	54
6.4. SMTP .....	59
6.5. DDNS (Dynamic DNS).....	60
6.6 Router & Port Forwarding.....	62
7. DEVICE .....	64
7.1. GENERAL .....	64
7.2. ALARM.....	65

---

7.3. PTZ EVENT .....	67
<b>8. SYSTEM .....</b>	<b>68</b>
8.1. GENERAL .....	68
8.2. TIME .....	69
8.3. ACCOUNT .....	70
8.4. UPDATE .....	72
8.5. INFO .....	73
<b>VII. PAN/TILT ZOOM CONTROL .....</b>	<b>74</b>
1. P.T.Z. Menu .....	74
2. Preset & Tour .....	76
3. Custom Functions .....	78
4. Auto Pan / Auto Tilt / Power .....	78
<b>VIII. PLAYBACK /SEARCH .....</b>	<b>79</b>
1. Playback .....	79
2. Time Search .....	79
2.1 Multi Channel Playback.....	79
2.2 Preview Search (Single Channel Playback) .....	80
2.3 Event Record Search .....	81
2.4 Event Source Search .....	82
2.5 Motion Area Search (Single Channel Playback) .....	83
3. Go to Search .....	84
4. Log List Search .....	85
<b>IX. BACKUP .....</b>	<b>86</b>
1. Manual Back up .....	86
1.1 Internal DVD- R/W .....	86
1.2 External USB HDD/ Memory Stick .....	88
1.3 Back up Range Setup .....	88
2. Auto Back up(FTP) .....	89
3. Log List Back up .....	90
<b>X. SPECIFICATION .....</b>	<b>91</b>

---

## Disclaimer

- The information in this manual is believed to be accurate and reliable as of the date of publication. The information contained herein is subject to change without notice. Revisions or New editions to this publication may be issued to incorporate such change
- We makes no warranties for damages resulting from corrupted or lost data due to a mistaken operation or malfunction of the Digital Video Recorder, the software, the hard drives, personal computers, peripheral devices, or unapproved/unsupported devices.

## Warning

- Do not cover the ventilation opening or slots on the outer casing. To prevent the appliance from overheating, provide at least two inches of air space around the vent and the slots.
- Do not drop metallic parts through slots. This could permanently damage the Digital Video Recorder. Immediately turn the DVR's power off or unplug the power cord from the power outlet. Contact a qualified service personnel authorized by your equipment distributor
- Do not attempt to disassemble or alter any part of the equipment that is not expressly described in this guide. Disassembly or alteration may result in high voltage electrical shock. Qualified service personnel authorized by your equipment distributor should conduct internal inspections, alterations and repairs.
- Stop operating the equipment immediately if it emits smoke or noxious fumes. Failure to do so may result in fire or electrical shock. Immediately turn the DVR's power off, remove the power cable from the power outlet. Confirm that smoke and fume emissions have ceased. Please consult your DVR distributor.
- Stop operating the equipment if a heavy object is dropped or the casing is damaged. Do not strike or shake. Failure to do so may result in fire or electrical shock. Immediately turn the DVR's power off or unplug the power cord from the power outlet. Please consult your DVR distributor.
- Do not allow the equipment come into contact with, or become immersed in, water or other liquids. Do not allow liquids to enter the interior. The DVR has not been waterproofed. If the exterior comes into contact with liquids or salt air, wipe it dry with a soft, absorbent cloth. In the event that the water or other foreign substances enter the interior, immediately turn the DVR's Power off or unplug the power cord from the power outlet. Continued use of the equipment may result in fire or electrical shock. Please consult your DVR distributor.
- Do not use substances containing alcohol, benzene, thinners or other flammable substances to clean or maintain the equipment. The use of these substances may lead to fire. Use a

---

dry cloth on a regular periodic basis and wipe away the dust and dirt that collects on the device. In dusty, humid or greasy environments, the dust that collects around the ventilation or the slots on the outer casing over long periods of time may become saturated with humidity and short-circuit, leading to fire.

- Do not cut, damage, alter or place heavy items on the power cord. Any of these actions may cause an electrical short circuit, which may lead to fire or electrical shock.
- Do not handle the device or power cord if your hands are wet. Handling it with wet hands may lead to electrical shock. When unplugging the cord, ensure that you hold the solid portion of the plug. Pulling on the flexible portion of the cord may damage or expose the wire and insulation, creating the potential for fires or electrical shocks.
- Use only the recommended power accessories. Use of power sources not expressly recommended for this equipment may lead to overheating, distortion of the equipment, fire, electrical shock or other hazards.
- Do not place the batteries near a heat source or expose them to direct flame or heat. Neither should you immerse them in water. Such exposure may damage the batteries and lead to the leakage of corrosive liquids, fire, electrical shock, explosion or serious injury.
- Do not attempt to disassemble, alter or apply heat to the batteries. There is serious risk of injury due to an explosion. Immediately flush with water any area of the body, including the eyes and mouth, or clothing that comes into contact with the inner contents of the battery. If the eyes or mouth contact these substances, immediately flush with water and seek medical assistance from a medical professional.
- Avoid dropping or subjecting the batteries to severe impacts that could damage the casings. It could lead to leakage and injury.
- Do not short-circuit the battery terminals with metallic objects, such as key holders. It could lead to overheating, burns and other injuries.
- The supplied power supply and power cord are designed for exclusive use with the Digital Video Recorder. Do not use it with other products or batteries. There is a risk of fire and other hazards.

## Caution

- Do not operate the appliance beyond its specified temperature, humidity or power source ratings. Do not use the appliance in an extreme environment where there is high temperature or high humidity. Use the device at temperatures within +0°C - +40°C (32°F - 104°F) and humidity below 90 %. The normal operating power source for this device is 100V-240V AC 50/60Hz.

---

## Preventing Malfunction

- Avoid Strong Magnetic Fields. Never place the DVR in close Proximity to electric motors or other equipment generating strong electromagnetic fields. Exposures to strong magnetic fields may cause malfunctions or corrupt image data.
- Avoid Condensation Related Problems. Moving the equipment rapidly between hot and cold temperatures may cause condensation (water droplets) to form on its external and internal surfaces. You can avoid this by placing the equipment in an airtight, resalable plastic bag and letting it adjust to temperature changes slowly before removing it from the bag.
- If Condensation forms inside the Digital Video Recorder. Stop using the equipment immediately if you detect condensation. Continued use may damage the equipment. Remove the power cord from the power outlet and wait until the moisture evaporates completely before resuming use.

## Regulatory

**FCC Compliance** : This equipment has been tested and found to comply with the limits for a Class A digital device, pursuant to part 15 of the FCC Rules. These limits are designed to provide reasonable protection against harmful interference when the equipment is operated in a commercial environment. This equipment generates, uses, and can radiate radio frequency energy and, if not installed and used in accordance with the instruction manual, may cause harmful interference to radio communications. Operation of this equipment in a residential area is likely to cause harmful interference in which case the user will be required to correct the interference at his own expense.



**NOTE:** THE MANUFACTURER IS NOT RESPONSIBLE FOR ANY RADIO OR TV INTERFERENCE CAUSED BY UNAUTHORIZED MODIFICATIONS TO THIS EQUIPMENT. SUCH MODIFICATIONS COULD VOID THE USER'S AUTHORITY TO OPERATE THE EQUIPMENT.

### CAUTION

- Risk of Explosion if Battery is replaced by an Incorrect Type. Dispose of Used Batteries according to the Instructions.
- The socket-outlet shall be installed near the equipment and shall be easily accessible



---

# Package Contents

Please check the package and contents for visible damage. If any components are damaged or missing, do not attempt to use the unit, contact the supplier immediately. If the unit must be returned, it must be shipped in the original packing box.

CONTENTS	QUANTITY	REMARK
DIGITAL VIDEO RECORDER	1 UNIT	
CLIENT SOFTWARE CD	1	
REMOTE CONTROLLER	1	
Audio In Cable Connector (1~8CH, 9~16CH)	1	4CH,8CH
	2	16CH
BATTERY (AAAsize)	2	
POWER CORD	1	
USER GUIDE	1	
LOOP BACK CABLE	1	16CH ONLY

# I.CONTROLS

## 1. Front Panel

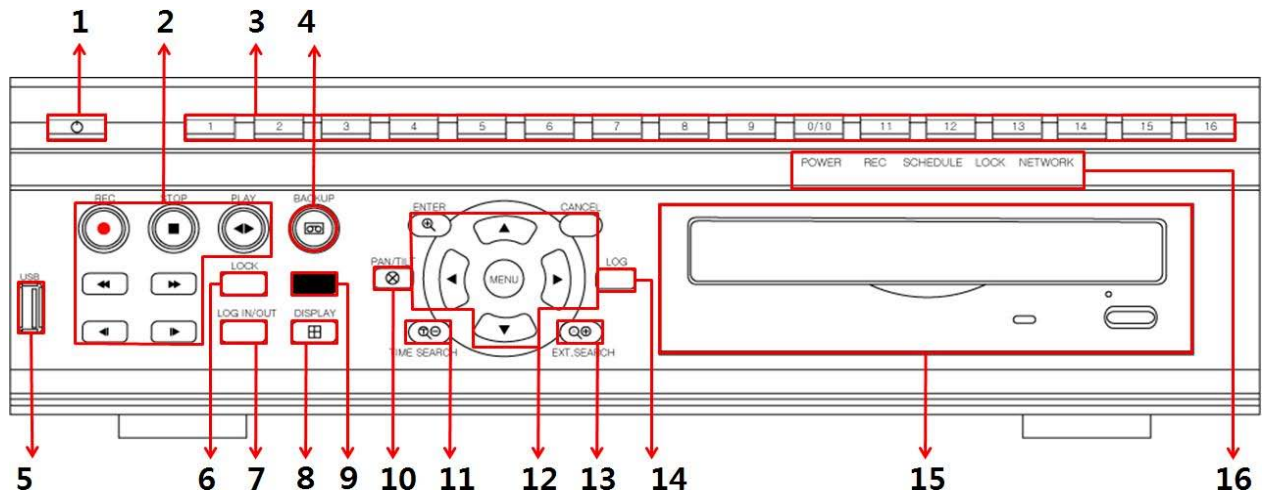

1) **POWER**  : Press this button to turn the power on; press again to turn the power off. The POWER LED (red) lights/goes off when the power is on/off.

2) **Playback / Record Control** : Used to Start and Stop Recording or Playback.

3) **Numeric [0~16]** : These buttons have a number of functions to enter data and to make selections. They are used to enter numerical data when prompted for the password, to make channel/camera selection, to choose the day in schedule option, and to enter alphabets to label each channel.

4) **BACKUP**: Press this button to begin making a backup copy of the hard drive. If there is no peripheral recording device connected, this button cannot be used.

5) **USB**  : USB compliant port allows use of memory sticks to backup video files or S/W upgrade.

6) **LOCK**: Press this button to lock all units' key buttons including the remote controller. The LOCK LED (green) lights/goes off when the lock is on/off. To release press it again and enter the administrator password.

7) **LOG IN/OUT** : Toggles log in and out.

---

**8) DISPLAY:** Press this button to display the cameras in multi-screen mode or to switch sequence function.

**9) Remote control signal receiver :** Do not block the receiver as the remote controller needs the line of sight to the receiver.

**10) PAN/TILT:** Press this button to control a PAN/TILT/ZOOM camera via RS-485 connection.

**11) TIME SEARCH:** Press this button to display the Time Search menu.

\* This button is used for [-] : To Decrease settings

**12) MENU, DIRECTION, ENTER, CANCEL:**

\* [ENTER]: Press this button to enter the sub menu..

\* [CANCEL]: Press this button to exit menu without saving.

\* [Direction▲▼◀▶]: In Menu setup mode, used to move the cursor.

In Zoom mode, used to move the zoom are..

\* [MENU] : Press this button to display the MAIN MENU. Press this button to exit with saving changes.

**13) EXT. Search :** Press this button to start external HDD search.

\* This button is used for [+] : To Increase settings

**14) LOG :** Press this button to display the LOG-list screen.

**15) ODD :** CD/DVD - RW.

**16) Mode Indicator:** Five LEDs display the status of the Digital Video Recorder. From the left, Power (red), Recording (red), Scheduled Recording (green), Lock (green) and Network (green).

## 2. Rear Panel Connectors

### 4-Channel

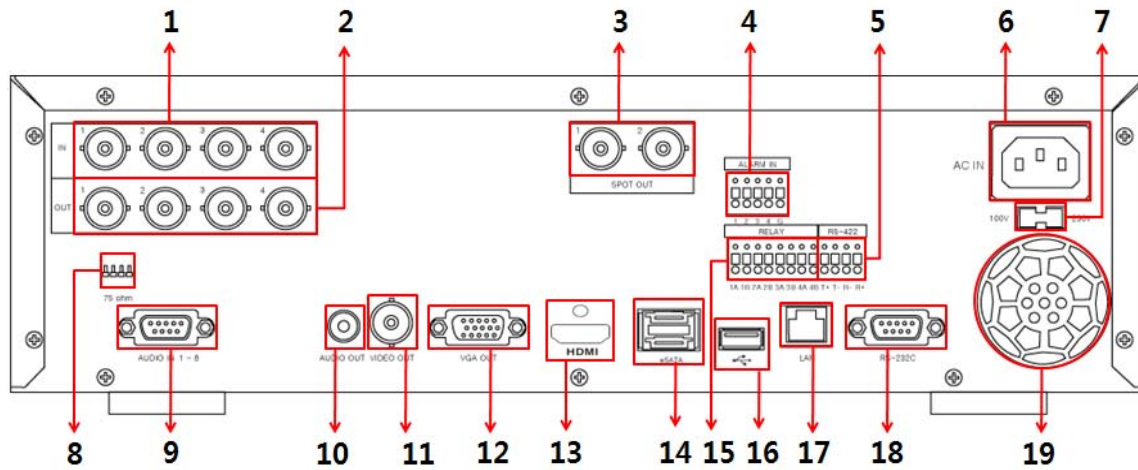

### 8-Channel

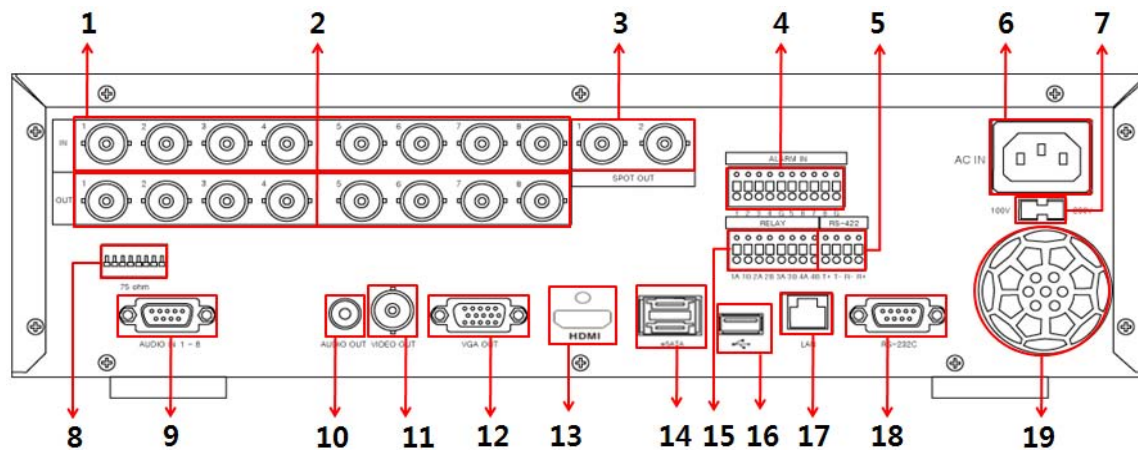

### 16-Channel

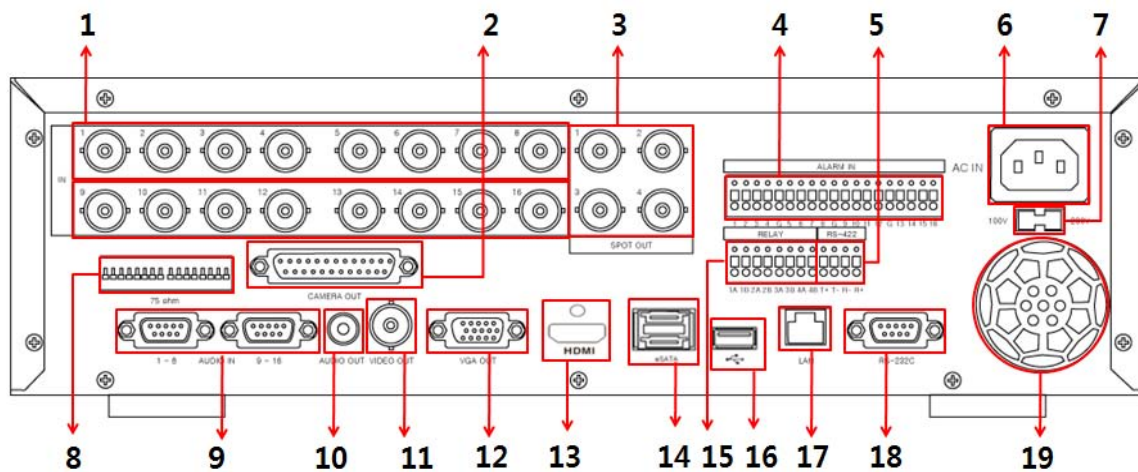

- 
- 1) **Camera Inputs** : BNC input connectors (4 / 8 / 16CH)
  - 2) **Camera Outputs** : LOOP-OUT connectors ( 4 / 8CH : BNC, 16CH : D-SUB to BNC )
  - 3) **Spot out connector** : 4 / 8CH : 2SPOT OUT, 16CH : 4SPOT OUT
  - 4) **ALARM IN** : 4/8/16 alarm/sensor inputs
  - 5) **RS-422** : For connecting to PTZ camera.
  - 6) **AC power socket**
  - 7) **110V or 230V Power selection Switch.**
  - 8) **75 Ohm Termination (1~4 / 1~8/ 1~16)**
  - 9) **AUDIO Input connectors** : D-SUB to RCA ( 4 / 8CH : 1~8CH , 16CH : 1~8CH,9~16CH )
  - 10) **AUDIO Output (1) connectors:** RCA
  - 11) **Composite Monitor Output** : BNC standard composite video output connector.
  - 12) **VGA out connector.**
  - 13) **HDMI out connector.**
  - 14) **eSATA connector:** For connecting e-SATA compatible devices.
  - 15) **ALARM OUT : 1~4**
  - 16) **USB 2.0 connector: For connecting USB compatible devices.**
  - 17) **RJ-45 Ethernet Port:** For connecting to remote PC via Ethernet network.**10/100/1000 BASE-T**
  - 18) **RS-232C [D-SUB 9PIN]** : For connecting to Debugging.
  - 19) **Power Fan**

### 3. Remote Controller

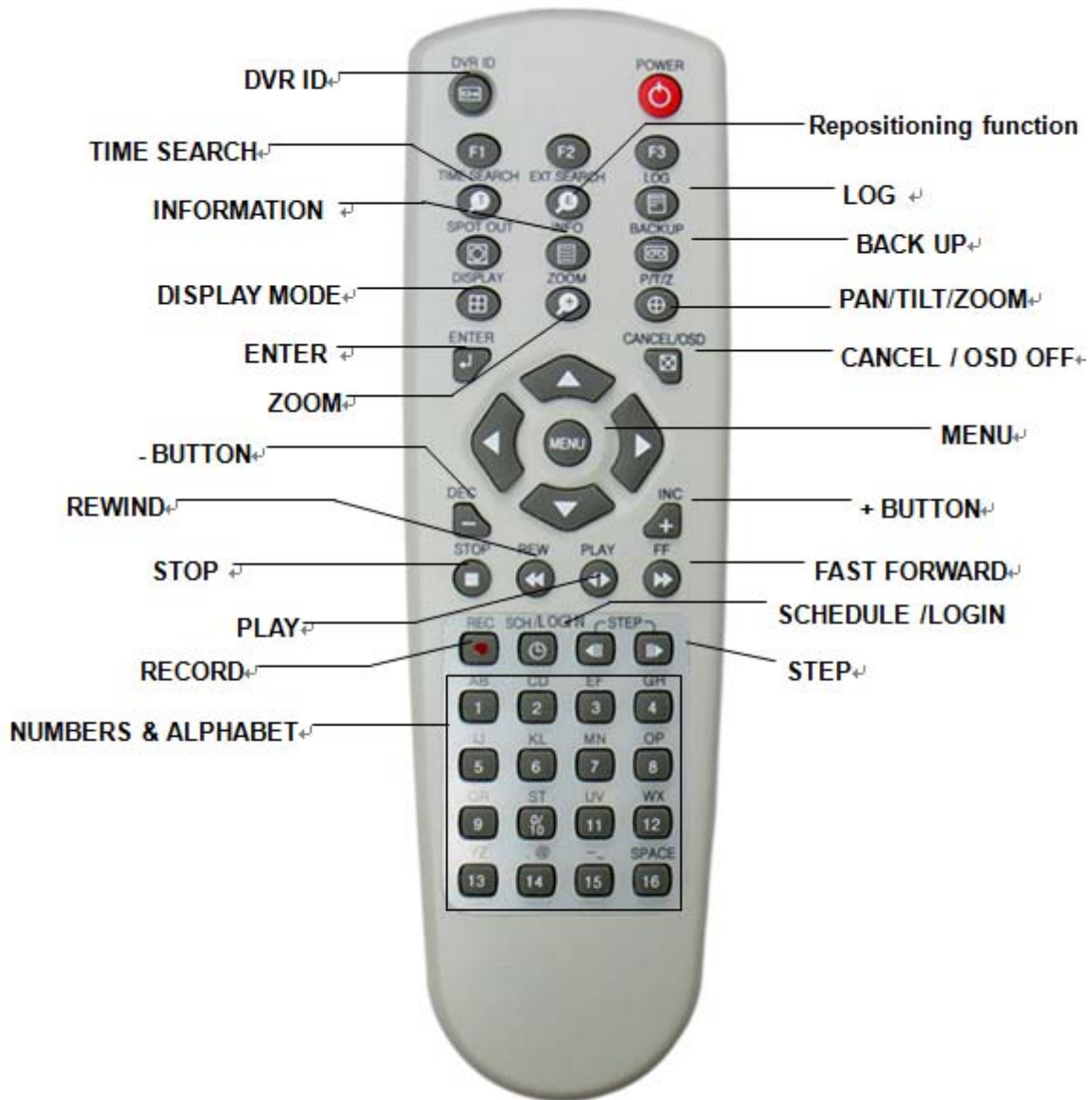

**DVR ID:** Set the proper DVR System ID through which to operate. Press the ID button, and then press the number button within two seconds to select the system ID of the DVR. If you set the System ID to Zero, you can control multiple DVRs at the same time.

---

## 4. Virtual Keypad for Mouse Control

This DVR provides a virtual on-screen keyboard to perform the control by mouse. Connect a mouse via USB port before use. If you click right button of your mouse in Live mode and Playback mode, you will see following virtual controller. This Virtual Keyboards operate similarly, but display different fields depending on the task being performed.



<Virtual Control Panel>



<Virtual Keyboard>

# II. INSTALLATION & CONNECTIONS

## 1. Camera, Monitor, Audio, Alarm sensor and Power cord

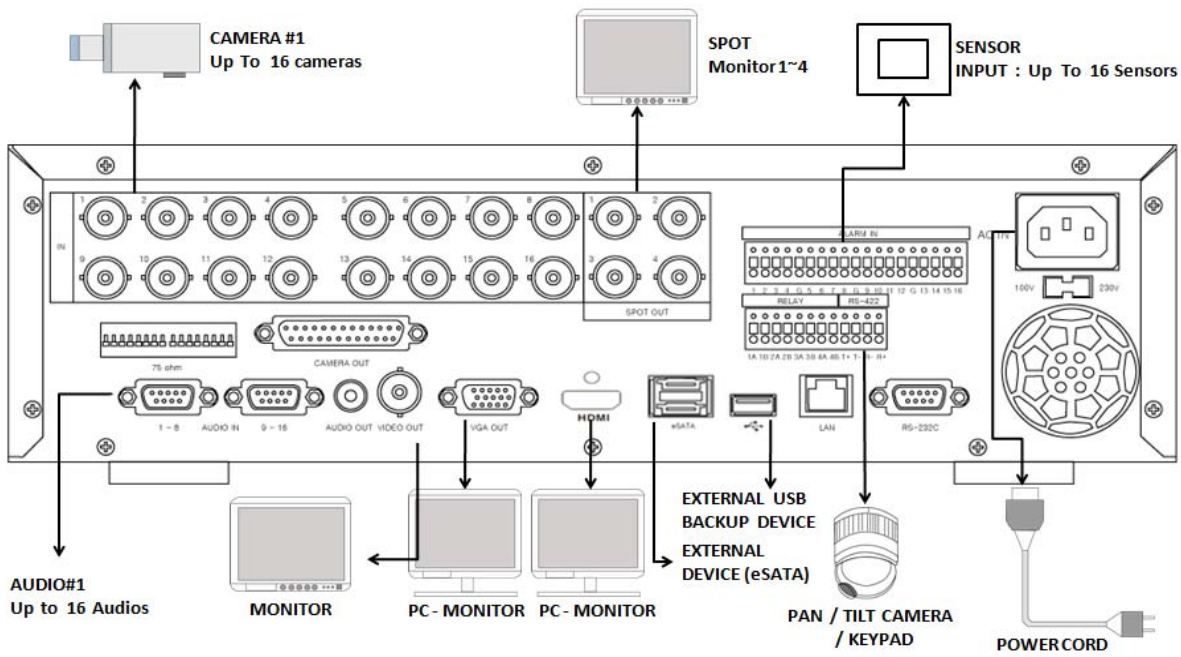

- Audio

Audio	Input	Output
impedance (0 dB)	10 k Ohm	300 ohm
voltage range	1 Vpp	1.4 Vpp



## 2. Alarm inputs and Alarm outs

### 2.1. Connection of N.O (Normally Open)

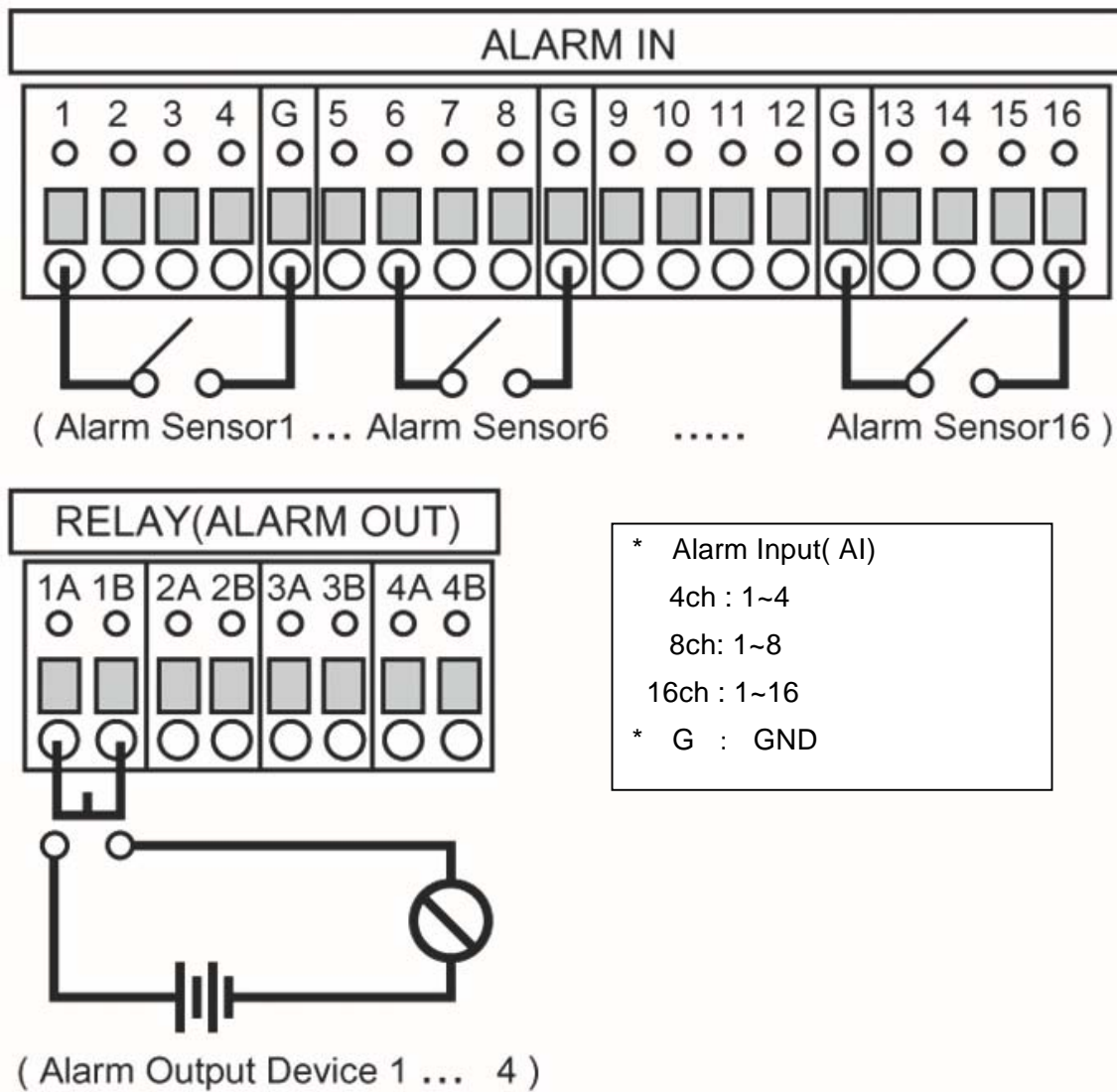

The maximum of Alarm output is 1A 30VDC, 0.5A 125V AC.

## 2.2. Connection of N.C (Normally Close)

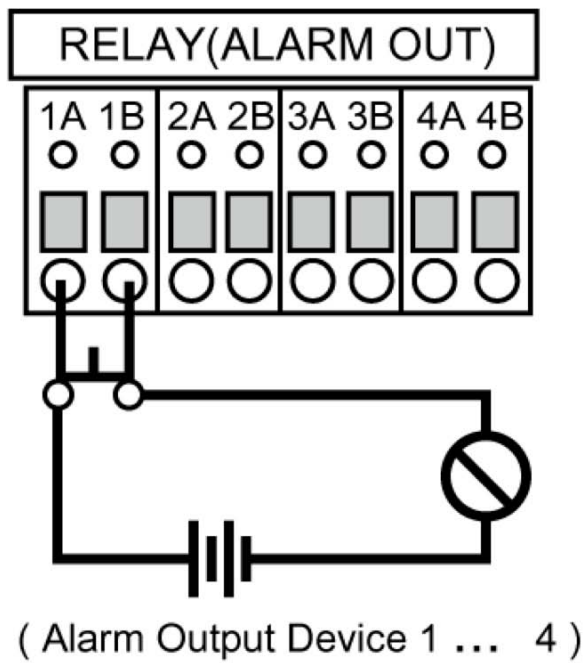
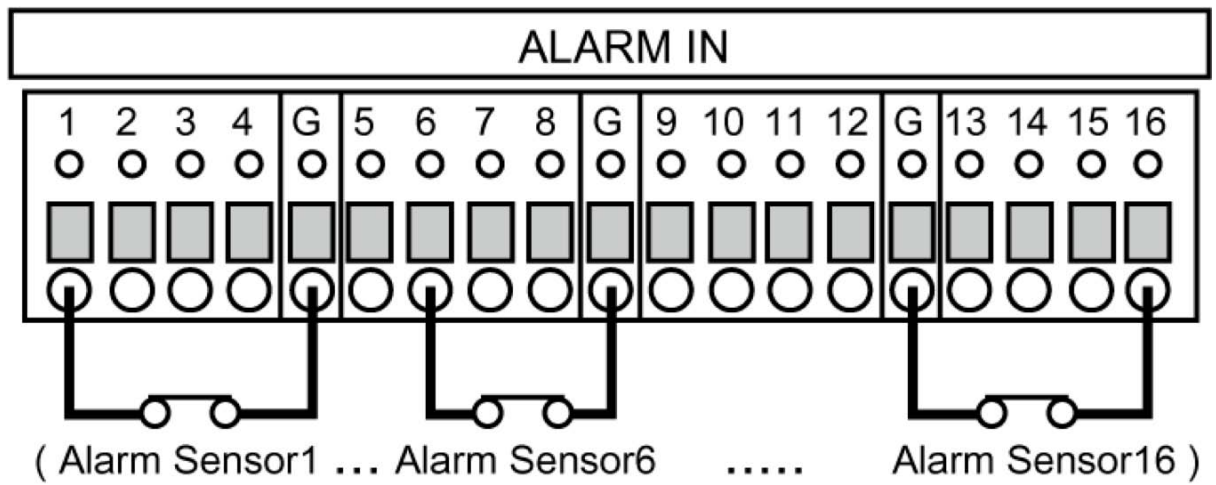

### 3. PTZ and controller connection

#### 3.1. Connecting the Speed Dome directly into DVR

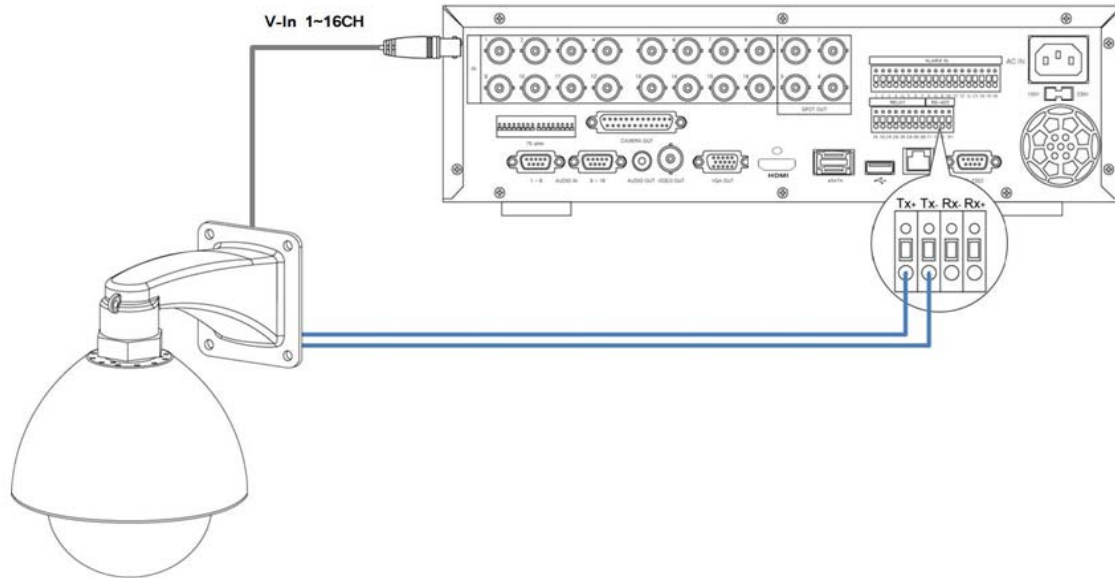

#### 3.2. Connecting Both Speed Dome and DVR via J-box

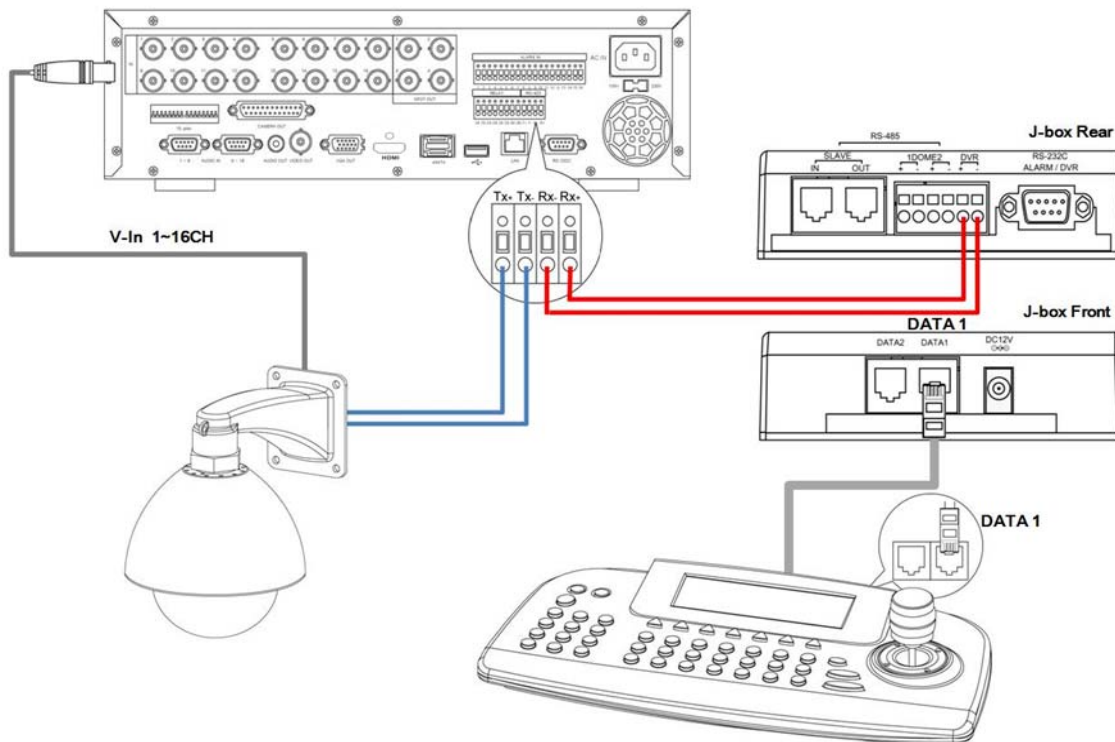

### 3.3. Connecting Single User with 2 DVR Configuration

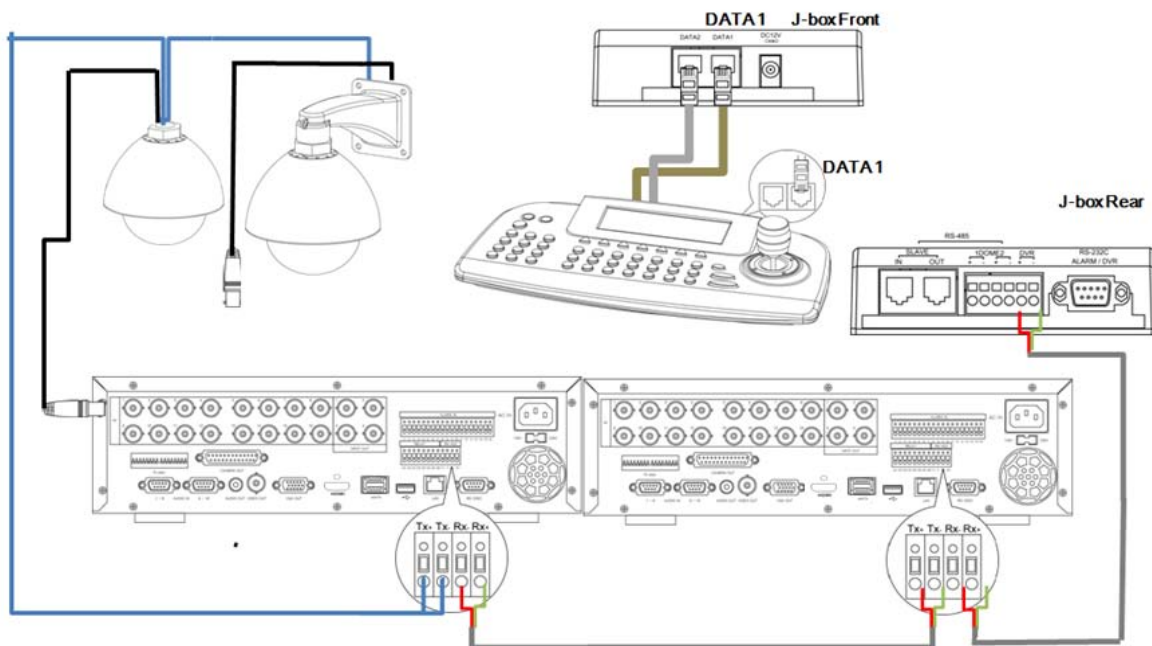

- Multiple PTZ cameras are connected by daisy-chaining the camera connection.
- Multiple Keyboards are connected by cascade connection.

---

#### **4. PC system requirement for Network connection.**

- (a) Pentium-4 2.0GHz or Higher
- (b) 512MB RAM
- (c) Windows 2000, ME, Windows XP, Window Vista, Window 7
- (d) 16MB Video Card
- (e) 10/100/1000-BaseT Ethernet Port
- (f) CAT-5/6 UTP Cable for LAN

(Crossover cable for direct connect to PC)

**<Disclaimer>**

**The connection and remote viewing of the DVR may not be successful on all PC's due to the variety of PC's internet connection settings.  
Please contact the technical support for further assistance.**

# III. QUICK START PAGE



ADMIN and the default password is "000000"



The Default User ID "admin" and password to run the EMS software is "0"

---

## Time & Date Setting

When the DVR is powered on for the very first time, the time and date are set as default to January 1, 2009 Thursday 01:00:00. Before any other operation of the Digital Video Recorder, it is important to setup the time and the date. Please refer to page 63 for setting the time and the date on the DVR.



# IV.LIVE VIEWING

## 1. Display Overview

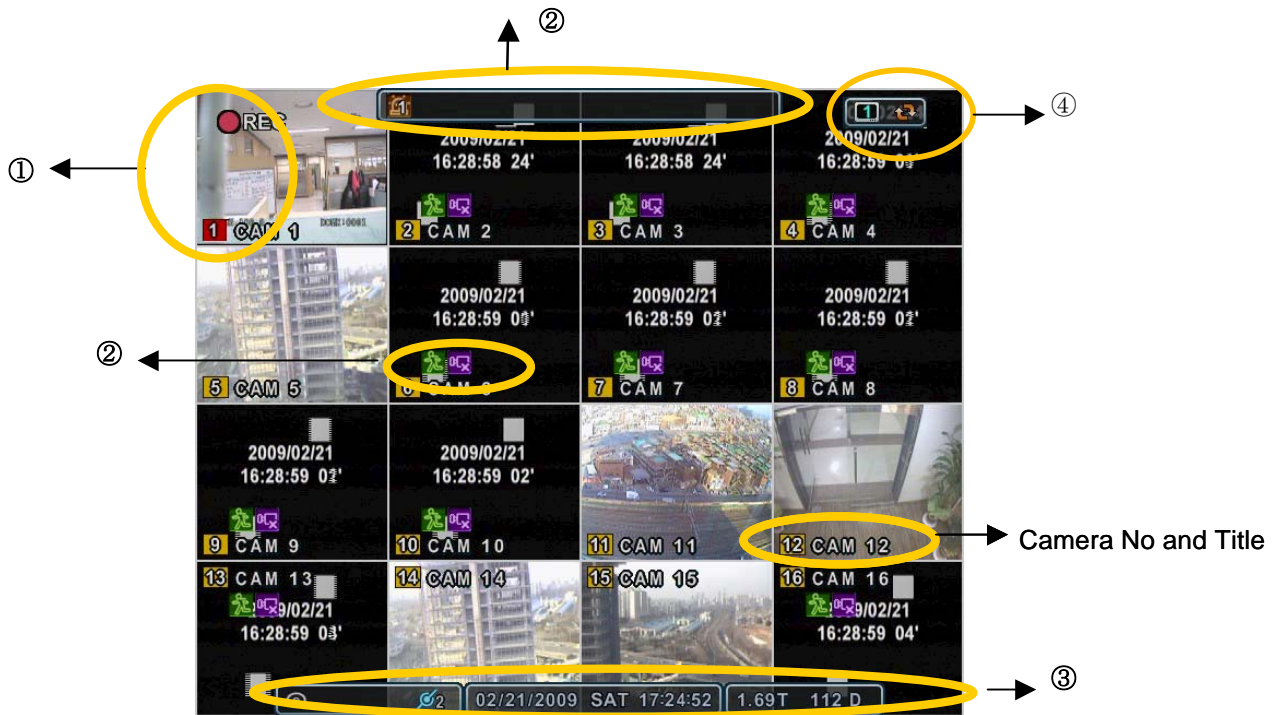

### 1. Recording Mode



Background color of Number will be different based on the recording status.

- 1) Red - Event (Motion/Alarm) Recording
- 2) Yellow - Continues Recording
- 3) Black - No Recording.

### 2. Event Indicator

(1) (2) (3)



- (1) Indicate **Alarm** In terminal is triggered by an alarm sensor.

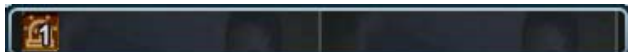

To appear Alarm window, press **[UP]** button. This button toggles between Shows or Hide the Alarm Window.



- (2) Indicate **Motion** detected. To disappear, press **[CANCEL]** button.
- (3) Indicate **Video Loss** during Recording. To disappear, press **[CANCEL]** button.



(1)(2)(3)(4)(5)(6)

### 3. Status Bar

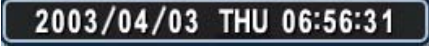

- (1) Indicate **Built-in CD/DVD R/W** is connected. It's changed to blue color while it's doing backup.
- (2) Indicate an **USB Device is connected on Front panel**. It's changed to blue color while it's doing backup.
- (3) Indicate an **USB Device is connected on Rear panel**. It's changed to blue color while it's doing backup.
- (4) Indicate Login() or Locking status
- (5) Indicate **Audio** Data is stored the selected time during playback and turn to blue color.
- (6) It shows **Number of Client**, which is connected to Network.(MAX:10)
- (7) : Displays Month, Year, Time and Date.
- (8) : Show you the remaining recording time of the DVR. If remaining HDD capacity is less than 5GB, this blue "Recycling" icon will be shown up.

### 4. Spot Monitor indicate



: Show you Selected Spot Number and status

---

## 2. Multi-screen Display and Sequencing

### 2.1. Screen Display.

Select any camera for Full screen display by pressing the Number button of the desired camera.

### 2.2. Multi-screen Display and Switch Sequencing Display.



- 1) Press **[DISPLAY]** buttons to activate the multiscreen display. It is changed the order as shown below among your choice of SPLIT MODE.
- 2) To start Auto Sequence, press **[DISPLAY]** buttons for 2 seconds to begin full screen sequencing.
- 3) The sequence mode and dwell times are programmable. For detailed information about configuring those, see "**Switch Setup**". If the sequence mode is not activated, it moves to Quad mode instead of Sequencing.

### 3. Quick button for multi screen Display.

#### 3.1. Quick multi split mode change

- Press F1 button on the remote controller + <Number>

For example, press F1 button then number 8.

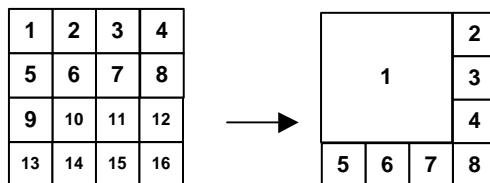

The eight channel view mode will be displayed.

**<Note>** 6,4,8,10,13 split mode must be checked on <Split mode> to use this function.

#### 3.2. Repositioning

It is possible to reposition the camera from the bigger window with the one from a smaller one. It is used on 6,7,8,9,10, 13,16 split mode

- ① Press **F2 button** on the remote controller.  Mark will be displayed.
- ② Press Numeric button you wish to switching display.



- ③ Press **[MENU]** button to exit here with saving changes.  
Press **[Cancel]** to exit without change.  
Press **[DISPLAY]** button to rearrange.

**<Note> How to control on KEYPAD**

1. Multi Screen (F1 function) = 16+ Display , 4+ Display button, and so on..
2. Repositioning (F2 function) = 99+ Display button
3. Auto Sequence Start = Shift & Display(at the same time)

---

## 4. Zooming

During live view mode, it is possible to zoom into a section of the screen to get a close-up view of the screen.

1. To activate the digital zoom, select the full screen display of the camera you wish to zoom.
2. Then press the **[ZOOM]** button on IR Remote controller. Zoom area box pops up, as shown below: x2

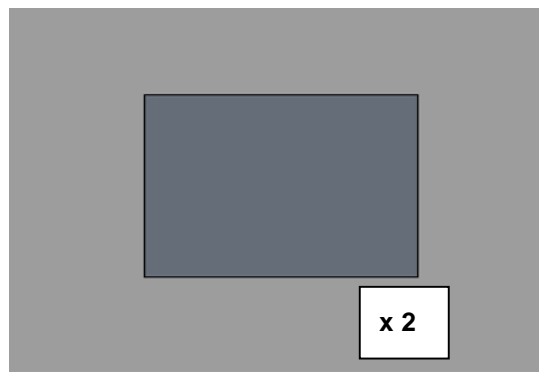

3. Move the box to the desired position using Direction [ ▲ ▼ ◀ ▶ ] buttons.
4. Press [CANCEL] button to return normal mode.

### <Note>

- This function is limited while it's playback in this model.
- If the Zoom button is pressed while in a multiscreen display, zoom operation is not activated.

---

## 5. Spot Monitor

In addition to the Main Monitor, attaching a Spot Monitor enables user to monitor specific channels independently from the main monitor. Press **[Spot]** button on the remote controller, DVR will be changed into SPOT mode.

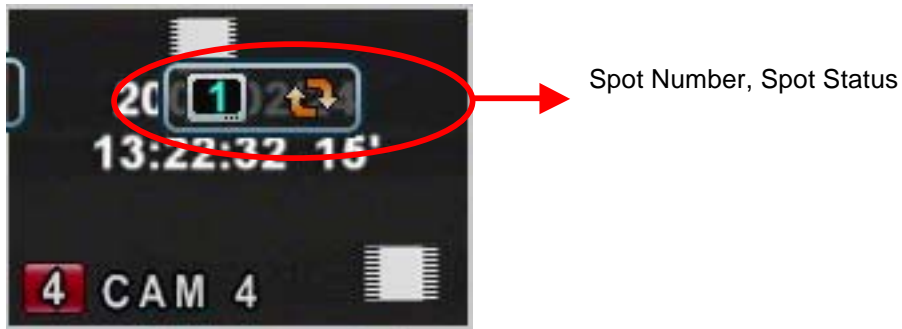

- 1) [INC/DEC]: Sport out control will be changed from SPOT 1-2-3-4-A-1
- 2) [Spot/Cancel]: Press Spot buttons for 2 seconds or [CANCEL] button to exit Main Monitor.  
If there is no input, it will automatically exit into Main mode after 5 seconds.
- 3) [#CH] – Press Spot button on remote controller, then press number button you wish watch as full screen.
- 4) [Display]- Press Spot button then [Display] for 2 seconds to start auto switch cameras. Sequence interval can be set from the Sequential Setup.

---

# V. OPERATION

## 1. LOG IN/OUT.

You must log on to the DVR with valid password to operate the DVR. By default, it comes with one login account; ADMIN and the default password is "000000".

**<Note >** If you are logging on for the first time, the system does not prompt you to change the default password. Therefore, it's strongly recommended to change the "PASSWORD" when you install the DVR. Refer to [System Setup].

### 1. Login

- 1) On the front panel or remote control, press the power button.
- 2) When the DVR is powered on, it will start to scan DVR status.
- 3) Live Viewing screen will appear after initialization about 50sec. It can be delayed when you have defect HDD, it will try to fix for logical problem but it will show you warning message for physical problem.
- 4) On the front panel or remote control, press Login. Using the mouse, click wherever the login dialog box pops up.
- 5) Login Icon  will be displayed on status bar.

### 2. Logout

On the front panel or remote control, press LOGIN. Using the mouse, click wherever on monitor, Virtual remote control will be appeared. The login icon will be disappeared on starts bar, indication you are logged off.

---

## 2. NAVIGATION THE MENU

1. Log on the DVR at admin level or user with configure level.  
\* User with configure feature is limited to access [DISK and System Menu].
2. On the front panel or remote control, press **[MENU]**. Using the mouse, click wherever on monitor, Virtual remote control will be appeared.
3. Use Direction buttons [**▲▼◀▶**] to select the desired menu. Using the mouse, click the menu. Items selected in the menu are represented in color.



4. Press **[ENTER]** button to select the menu and display Sub-Menu. Using the mouse, double click.
5. Use Left/ Right buttons [**◀▶**] to select on TAP menu. Selected items changed into **[Orange]** color.

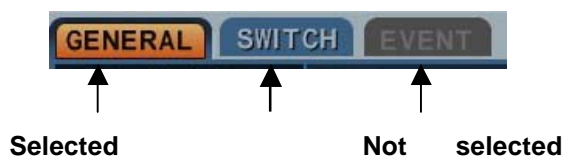

**\* It is automatically saved changes when you move between TAP menus.**

6. The menus are displayed with options on the left-hand column and settings in the right hand column. A cursor (highlighted menu) can be moved using the Direction buttons [**▲▼◀▶**].
7. Press **[-, +]** button to change the value or select options. By mouse, using Wheel.



8. Press **[MENU]** button to exit a menu with saving changes.  
Press **[CANCEL]** to exit a menu without changes.

# VI. SETUP

## 1. DISPLAY

### 1.1. GENERAL



1. The menus are displayed with options on the left-hand column and settings in the right hand column. A cursor (highlighted menu) can be moved using the Direction buttons [▲▼◀▶].
2. Change below options using [DEC/INC] buttons.

ITEM	ADJUSTMENT
STATUS BAR	<ul style="list-style-type: none"> <li>• Select “Show” or “Hide” below status bar on Main Monitor.</li> </ul>
CAMERA INFO	<ul style="list-style-type: none"> <li>• Select On-Screen-Display information for Camera Number and Title.</li> </ul>
BORDER LINE	<ul style="list-style-type: none"> <li>• Select Board Line between cameras. [GRAY → WHITE → BLUE → BLACK → DARK GRAY]</li> </ul>
BACKGROUND	<ul style="list-style-type: none"> <li>• Select Background color on NO VIDEO status. [GRAY → WHITE → BLUE → BLACK → DARK GRAY]</li> </ul>
OSD ALIGNMNET	<ul style="list-style-type: none"> <li>• The main video output can be displayed on a VGA and analog monitor. Video can be displayed on both monitor simultaneously. Select On-Screen-Display coordinates on Monitor. <ul style="list-style-type: none"> <li>- Under scan: Displays properly at CCTV Monitors</li> <li>- Over scan: Displays properly at VGA Monitors.</li> </ul> </li> </ul>
SPLIT MODE	<ul style="list-style-type: none"> <li>• Display is changed the order as shown below among your choice of SPLIT MODE.</li> </ul>

3. Save changes and exit the menu, press [MENU] button.  
Exit the menu without making changes, press [CANCEL] button.



## 1.2. SWITCH Setup (Monitor Configure)

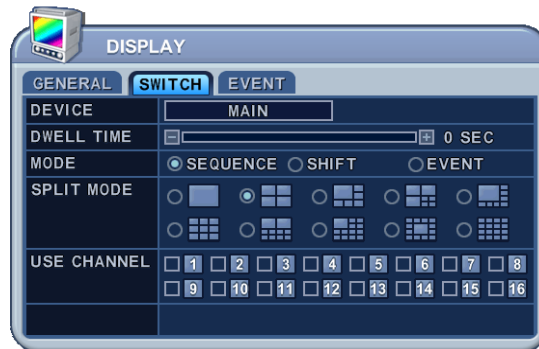

1. The menus are displayed with options on the left-hand column and settings in the right hand column. A cursor (highlighted menu) can be moved using the Direction buttons [**▲▼◀▶**].

2. Settings

1) Device: Each Monitor may be configured in different way.

**[MAIN → SPOT1 → SPOT2 → SPOT3 → SPOT4]**

2) Dwell Time: Select the interval that each camera or Multi screen mode is displayed in a rotation. Use [**-, +**] button to change : **[1 second ~ 30 second]**

3) Mode: Select the appropriate monitor display to making any adjustment. This Mode will be activated while it's in Switch Mode.

a. **Sequence:** Automatic Sequence.

b. **Shift:** Selected camera will be displayed after dwell time.

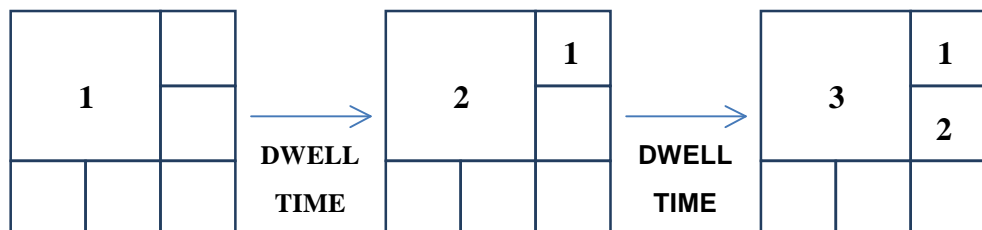

c. **Event:** To display particular camera in full screen or in multi mode when event triggered.

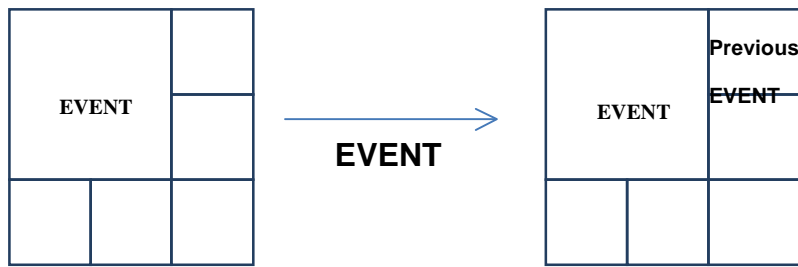

4) SPLIT MODE : Select desired sequence mode to switching.  
**<note>***This function is limited to use on SPOT Monitor in this model.*

5) USE CHANNEL: Select the cameras to be included or excluded from the automatic switching.

3. Save changes and exit the menu, press [MENU] button.  
 Exit the menu without making changes, press [CANCEL] button.

4. Press [Display] button for 2 seconds to start Auto Switch cameras on Main Monitor.  
 Press [Spot] button then [Display] for 2 seconds to start auto switch cameras on Spot Monitor

### 1.3. EVENT

This menu will be activated when you select <EVENT> Mode for Switch. Event menu will allows customization of motion, alarm and video loss.



When selected event trigger such as alarm, motion or video loss, it will be displayed at the monitor that is configured for event.

## 2. CAMERA



1. Press Left/Right buttons [ ◀ ▶ ] or number

button to select the desired camera

2. Camera Channel option is highlighted and the camera settings are displayed.

The menus are displayed with options in the left-hand column and settings in the right hand column.

### 2.1. Video Adjustment

To Configure Camera Settings:

1. Select Camera number button to configure the desired camera.
2. Select Category to “TUNE”.



ITEM	DEFAULT	ADJUSTMENT
BRIGHTNESS	50%	• The brightness of each camera can be adjusted by pressing [-,+] buttons.
CONTRAST	50%	• The contrast of each camera can be adjusted by pressing [-,+] buttons.
COLOR	50%	• The color of each camera can be adjusted by pressing [-,+] buttons.
SATURATION	50%	• The saturation of each camera can be adjusted by pressing [-,+] buttons.

## 2.2. PTZ Set Up

PTZ devices are connected to the RS-422 ports located on the back of the unit. Multiple PTZ cameras are connected by daisy-chaining the camera connections. This DVR allows you to address and control multiple PTZ cameras on an individual basis.

To Configure PTZ Setup ,

- 1) Select Camera number button to configure the desired camera.
- 2) Press [Enter] to configure PTZ Setup.



The menus are displayed with options in the left-hand column and settings in the right hand column.

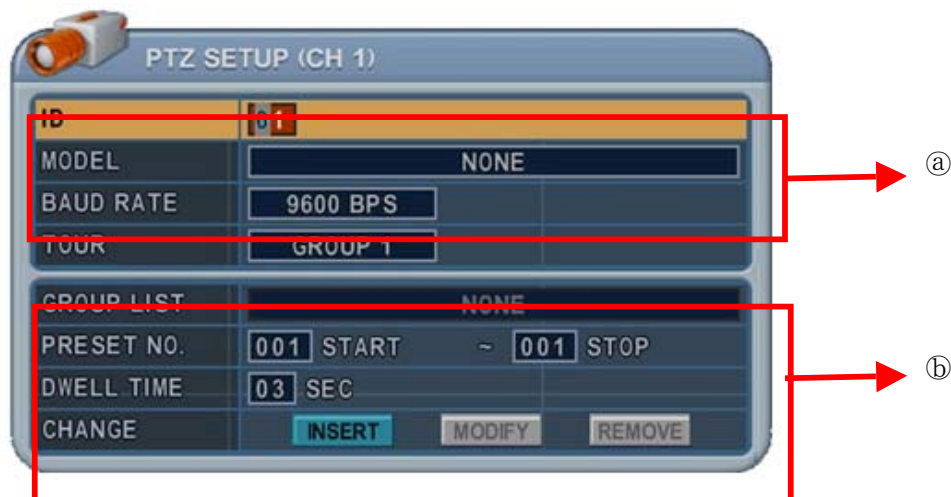

### a. Communication Settings.

: Configure the appropriate model and then enter the corresponding baud rate and PTZ ID (address).

b. **Tour Group**: Preset Tour allows a camera to move though a programmed sequence of PTZ presets. Please refer to **<PTZ controlling>** for more detail.

## 2.3. Camera Title

Allows you to create a unique name for each camera. The camera title has the following guidelines:

- Characters: A to Z, 0 to 9. Special characters are supported by network.
- Length: up to 12 characters, including spaces.

To create a camera title, use the virtual keyboard or press the appropriate numeric button on the IR Remote or the front panel.



<Virtual Keyboard via Mouse>

No	1st	2nd	3rd	No	1st	2nd	3rd
1	A	B	1	9	Q	R	9
2	C	D	2	10/0	S	T	10
3	E	F	3	11	U	V	11
4	G	H	4	12	W	X	
5	I	J	5	13	Y	Z	
6	K	L	6	14	.	@	
7	M	N	7	15	-	_	
8	O	P	8	16	SPACE		

<on IR Remote Controller or Front Panel >

To save changes and exit the menu, press the [MENU] button.

To exit the menu without making changes, press the [CANCEL] button.

---



## 2.4. Motion Detection Setting

To Configure Motion Area :

1. Select Camera number button to configure the desired camera.
2. Select Category for “**GRID**”. Settings are shown at default levels.



- 1) Motion Level : The sensitivity settings are : 1: Low sensitivity ~ Level 20: High sensitivity. **By default , the level is set to 10.**
- 2) Motion Grid : The area property is highlighted and motion detection can now be observed in the view window. **By default, it's set to OFF.**

-  : Select All. Press [Enter] to select.
-  : : Clear All. Press [Enter] to select.
-  : Select specific. Press [Enter] to select.

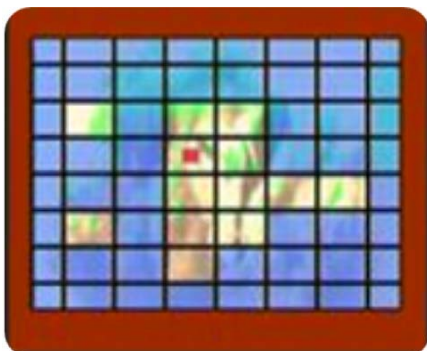

To define the motion view area cell-by-cell, do the following:

On the front panel or remote control, press any of direction buttons to highlight a cell in the motion detection area, then press [INC/+] . This area is selected and the cells are highlighted in a blue colour.

---

## 2.5. Privacy Mask

Privacy Mask allows you to mask certain areas in the surveillance video for privacy protection under related laws, policies and regulations. Areas applied with privacy masks will not be displayed. Once you've set up the Privacy Mask, by selecting positions that need video masking, the covered placement is displayed in Live View, Recording and Playback.

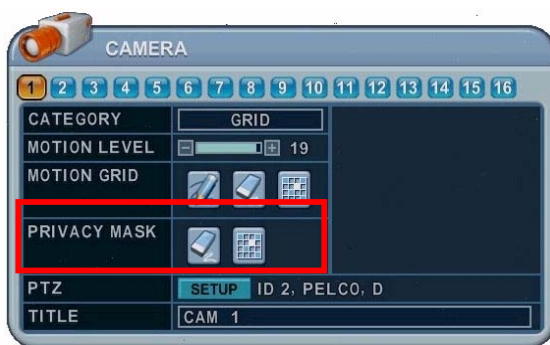

To Configure Privacy Mask:

1. Select Camera number button to configure the desired camera.
2. Select Category for "**GRID**".



3. The Privacy Mask creates a masking rectangle of a selected size then positions it on the video image. To define the Privacy Mask area, do the following;



- 1) On the front panel, or remote control, press any of directional buttons to highlight an area in the Privacy Mask area. Select cells which you want to hide, one at a time, and then press [INC/+].
- 2) The area is selected and the cells are highlighted in a blue color.
- 3) The area property is highlighted and privacy mask can now be observed in the view window. **By default, it's set to OFF.**
  -  : Clear All. Press [Enter] to select.
  -  : Select specific. Press [Enter] to select.

## 3. RECORD

### 3.1. Record General



1. The menus are displayed with options in the left-hand column and settings in the right hand column. A cursor (highlighted menu) can be moved using the directional buttons [▲▼◀▶].
2. Change the options shown below using the [DEC/INC] buttons.
  - 1) **Schedule Use:** This enables or disables Night Zone. **By default "OFF"**.
  - 2) **Boot up Record:** The DVR starts recording without pressing the [REC] button when it is set to "ON".
  - 3) **Disk Overwrite:** Selects the record policy of the hard disk drive.
    - **ON:** **By default**, the hard disk drive overwrites from the beginning when it becomes full.
    - **OFF:** Stops recording when the HDD is full.
  - 4) **Auto Delete:** Allows you to configure when the DVR automatically deletes all data from HDD. It leaves the data for a selected duration from the current time. [NONE → 12HOURS → 1DAY~ 6DAYS → 1WEEK ~ 4WEEKS-> 30 DAYS]
  - 5) **Pre-Record:** Determines the duration the DVR stores recorded video prior to the beginning of Event Recording [5SEC ~ 300 SEC]. **By default 5 sec.**
  - 6) **Post-Record:** Determines the duration the DVR continues to record for after an Event detection [5SEC ~ 300 SEC]. **By default 5 sec.**

<Note> 1. Alarm/Motion Duration is extended if there is another Alarm/Motion detected whilst Event Recording.

2. When recording, the Pre-Record and Post-Record will not be activated.

3. To save changes and exit the menu, press the [MENU] button.  
To exit the menu without making changes, press the [CANCEL] button.

< Approximate File Size >



Quality	NTSC			PAL			UNIT
	720*480	720*240	360*240	720*576	720*288	360*288	
LOW	11.7	5.8	2.9	14.0	7.0	3.5	KB
MIDDLE	15.0	7.5	3.8	18.0	9.0	4.5	KB
HIGH	18.3	9.2	4.6	22.0	11.0	5.5	KB
SUPER	21.7	10.8	5.4	26.0	13.0	6.5	KB
ULTRA	25.0	12.5	6.3	30.0	15.0	7.5	KB

\* This is calculated theoretically and in actuality may be different depending upon Video Signals or other contributing conditions.

### 3.2. Resolution & Recording Speed Setting

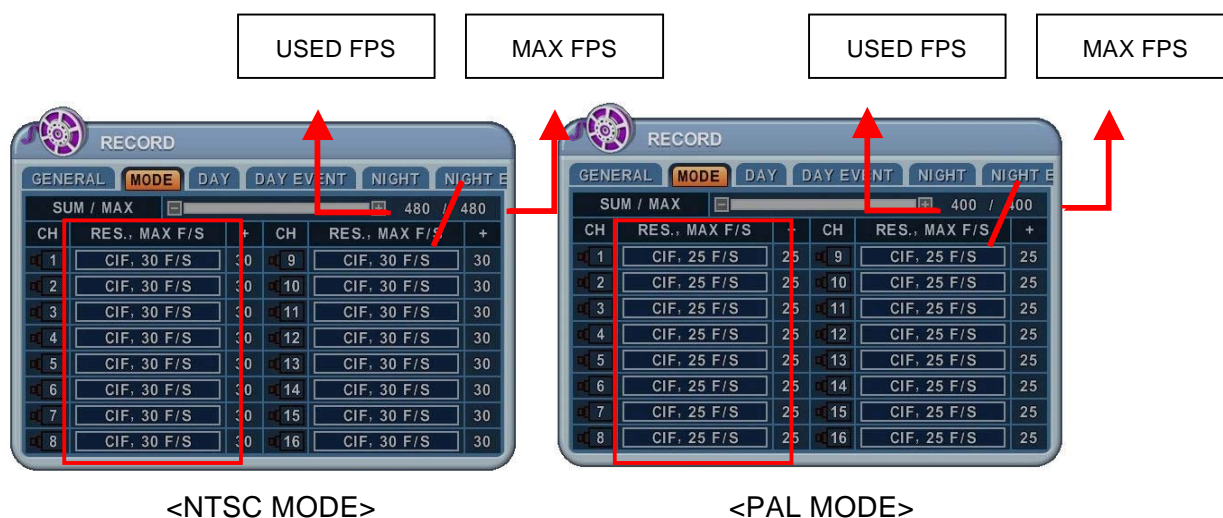

This DVR records each camera individually and then multiplexes them. You can individually set up resolution and recording speed for each channel. D1 stands for NTSC 720\*480 (PAL 720\*576), Field stands for 720\*240 (PAL 720\*288) and CIF for 360\*240 (PAL 360\*288)

To make them global recording settings, select desired channel then press the split button to copy to other channels.

**<Note> Total fps is displayed in SUM/MAX. MAX : NTSC is 480 and PAL is 400. If the sum of fps is over than MAX fps this warning message pops up and the last channel is automatically disabled.**



### 3.3. Continues /Normal Recording

The DVR comes with certain preset settings from the factory. Therefore, once the DVR is installed immediate recording is possible by pressing the record button. By default, audio, alarm, motion recording are off.



The DVR records video data continuously over a 24 hour period. Recording setup is for normal recording. Different settings can be configured for each camera. To copy the setting to another channel, press **[Display]** button.

ITEM	ADJUSTMENT
RES.	•Display selected resolution in MODE tab.
RATE	• Select recording speed for each camera.
QUALITY	• Specify the record picture quality for each camera. ULTRA → SUPER → <b>HIGH</b> → MIDDLE →LOW

### 3.4. Event Recording

Users can set different event recording parameters on a camera by camera basis. Set the continuous recording to [OFF] and configure the Event Recording speed and Quality for each camera.



Determine whether Alarm, Motion, Video Loss is used for EVENT recording on the [DAY EVENT] tab.

#### 1) Alarm Recording

One Alarm input can be configured to one channel. One camera channel can be assigned to multiple alarm inputs.



- Press [-, +] button to change the value or select options. With a mouse, use the wheel.
- [\*] indicates multiple alarm sources are selected.
- Please refer to [Device/Alarm] for Alarm inputs and outputs.

## 2) Motion Recording

One Motion detection can be configured to one channel. One camera channel can be assigned to multiple motion detection.

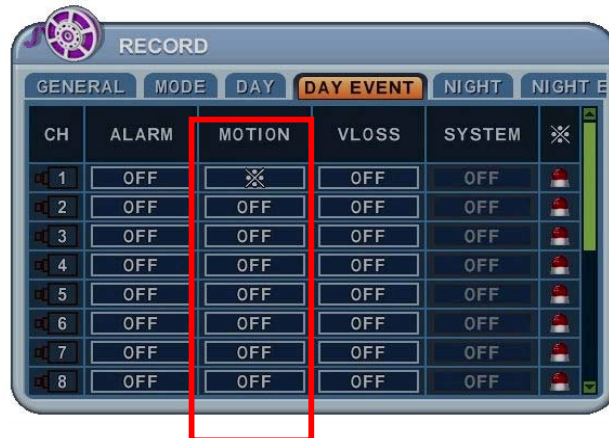

- Press [-, +] button to change the value or select options. With a mouse, use the wheel.
- [⊗] indicates multiple alarm sources are selected.
- Please refer to [CAMERA] menu for Motion setup.

**<Note>** There may be cases when the recorder's built-in motion detection function does not operate properly due to the condition of the input video signal or other factors.

## 3) Multi Event Recording.

- Video Loss:** When Video Loss occurs it can be configured to one channel. One camera channel can be assigned to multiple Video Losses

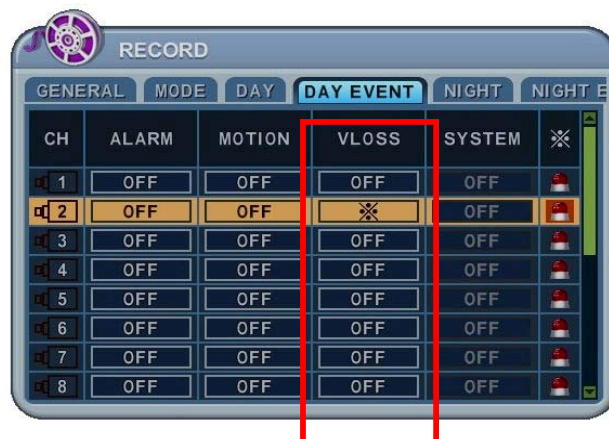

### b. Event Edit



- Press [enter] to edit multiple events. The menus are displayed with options in the left-hand column and settings in the right hand column. A cursor (highlighted menu) can be moved using the directional buttons [▲▼◀▶] on the IR remote or front panel.



- Change options using the [DEC/INC] buttons on IR remote or by clicking the mouse button.
- System menu are not activated in this section

### 3.5 Continuous + Event (Motion/Alarm) Recording

Continuous and Event recording can be set simultaneously. The DVR records video continuously over a 24 hour period, but if an Event occurs, the recording speed and picture quality can be set to values different from continuous recording values.

<Example>



Pressing the **REC** button, **Normal** recording starts with High picture quality at 3F/S. When an **Event** is triggered on this channel, it changes to record with Super picture quality at 30 F/S. It reverts back to **Normal** Recording after the Event duration ends.

**<Note>** Please determine Event source, such as Motion, Alarm, Video Loss on the **[DAY EVENT]** tab.

## 4. SCHEDULE

When the schedule is on, users can define their own daytime, night time, as well as specified date settings. A schedule can be used to record selected cameras at different times, change record rates, and select whether Alarm or Event is enabled. By selecting Schedule Use “on” Record setup, Night Mode will be activated.



#### 4.1. CHART Setup

The schedule chart shows a graphical representation of the defined record mode. Night mode will be set by default. However, the schedules are only displayed if a corresponding schedule has been configured in the schedule menu.

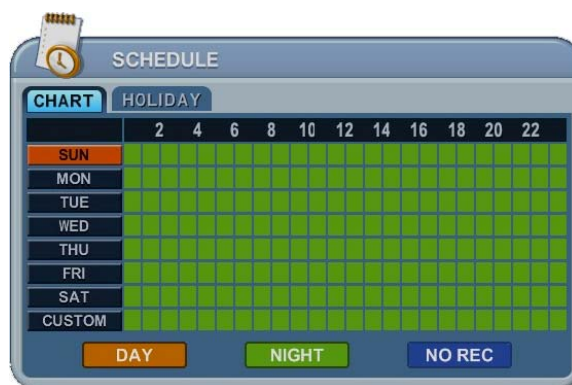

- \* DAY (Yellow): Follows day setting on record.
- \* Night (Green): Automatically follows night setting.
- \* No Record (Blue): The video is displayed, but is not recorded.

- 1) A cursor (highlighted menu) can be moved using the directional buttons [▲▼◀▶].
- 2) Select each day to configure, press [Enter] or click the mouse button.

3) Detailed menu pops up for the selected day, as shown below.



- a. Use [-, +] button to change the values.
    - Mode : [Night] → [Day] → [No Rec]
    - BEGIN: The time recording starts.
    - END: The time recording ends. The end time must not be before the starting time or the same as the starting time.
  - b. Save changes and exit the menu, press the [MENU] button.  
Exit the menu without making changes, press the [CANCEL] button.
- 4) Copying Schedule
- a. A cursor (highlighted menu) can be moved using the directional buttons [▲▼◀▶] on Day (Sun – Sat)
  - b. Press [Display] button on the desired setting.

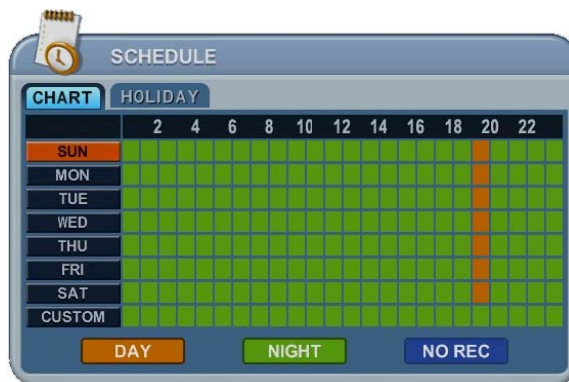

## 4.2. Holiday Setup

This allows you to create up to 32 holidays. If a holiday schedule occurs on the same date

---

as a weekday schedule, the holiday schedule overrides the weekday schedule.



- 1) A cursor (highlighted menu) can be moved using the directional buttons [▲▼◀▶].
- 2) Select each day to configure, press [Enter] or click the mouse button.
- 3) Use the [-, +] buttons to change the values.
  - Mode : [OFF] → [Day] → [Night] → [No Rec] → [Sun~Sat] → [Custom]
  - Date: The date Holiday starts.
  - Days: The holiday duration [1 to 15 days].

## 5. DISK



## 5.1. DISK Manager

Disk Manger is used to format hard disks and to assign the HDD usages, such as back up or mirroring.



### 1. Select

- 1) The menus are displayed with options for all installed HDD's or ODD list.
- 2) Press up/down [ $\blacktriangle$ / $\blacktriangledown$ ] buttons to highlight Hard Disk or ODD, then press [-, +] button to select. Using the mouse, click the HDD option.
- 3) Device & Size: This information lists the installed drives and their respective capacities, which is not currently used.
- 4) Status:
  - a. Unknown: New installed Disk.
  - b. Empty: Formatted but not used in current DVR.
  - c. CD/DVD: CD or DVD is installed for back up use.
  - d. Record Data: HDD stored Recording data but not used in current DVR.
  - e. Back Up Data: HDD stored Back up data.
  - f. Other Data: Neither Back Up nor Recording Data, including AVI file.

<Note>: Disconnected Disks disappear from the Disk Menu.

### 2. Action :

- 1) None: By default.
- 2) **Assign to Record**: Initialise the selected HDD. It formats the drive and all data on the drive is erased. External SATA HDD can be used to extend HDD capacity. Selected HDD will move to [Recording Disk] after formatting.
- 3) **Mirror: Mirror on INT -A**  
:This DVR utilises two internal/external HDD's for recording. Writing duplicate data to other HDD in order to protect against loss of data in the event of a device failure.  
**\*<Warning> This HDD must be same with or bigger than original size.**
- 4) **Assign to Record & Mirror**: This menu is activated when you select two HDD's

at the same time. It automatically configures one HDD for Recording and the other for Mirroring.

**5) Initialise for Back Up:**

Selected device, such as Media or External HDD, is formatted for backup use. Here's the guide for backing up data to various devices.



Once you press the start button, this pop-up window is displayed to ask you to confirm the initialising for back up: YES or NO.

**6) Link Record Disk**

: This function is used for adding [used HDD] from the same model without formatting.

**< Note: There are limitations for using this function >**

- A. DVR should be empty (NO HDD). If RECORDING DISK's exist it does not work.
- B. The used HDD should be from same series. It's does not work with different series.
- C. There should be no time duplication in the HDD.

Device	ODD (Media)		HDD	
	CD/DVD±R	CD/DVD ±RW	SATA	USB
Media can be formatted	X	O	O	X
Device can be formatted on a PC using FAT 32, NTFS File system.	X	X	O	O
Media must be formatted on DVR before backing up or exporting data to the device.	X	O	△	△

**<Note1>** USB flash memory is working without format.

**<Note2>** if a FAT32 /NTFS formatted external USB device is installed, <Assign to Stream> feature is disabled. It's limited to back up only.

3. Press the [ + ] button to start selected action.

4. Save changes and exit the menu, press the [MENU] button.

Exit the menu without making changes, press the [CANCEL] button.

## 5.2. Recording DISK

This information lists the installed drives, how the DVR records video and their respective capacities which are currently being used for recording.



### 1. Size, Range

: This displays current recorded data size, HDD size and indicated stored data range, and where the writing progress is running

### 2. Device

Displays logical Master and Slave device in mirroring. Upper device is the Master and the other is used for slave. If the slave HDD reaches 100% synchronisation, Master HDD can be removed as well.

### 3. Status

- 1) Stable: The HDD is in a stable condition.
- 2) Re-sync: Force all pending buffered disk writes to the NEW installed disk.
- 3) Recover: Recover all mismatched data between the mirrored disks.

### 4. Action: Remove HDD.

The "Are you sure?" dialogue box opens.



Press the up/down [  ] buttons to YES or NO, then press the [-, +] button to select.

---

### 5.3. S.M.A.R.T STATUS

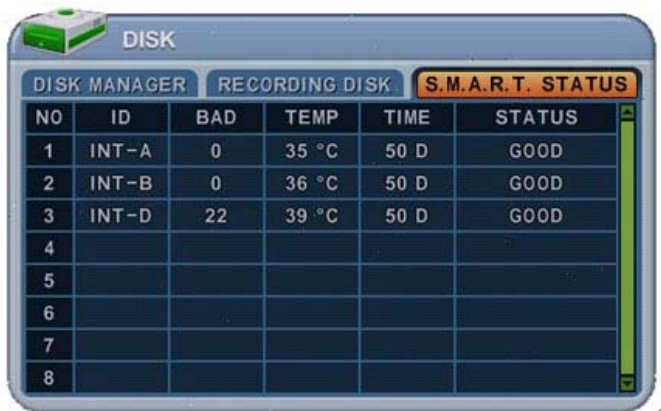

Displays HDD information, such as Bad Sector, Temperature and HDD running time. S.M.A.R.T information has slight differences between depending on the HDD manufacturer. We recommend changing the HDD if its status is in <PRE-FAIL>

**\*NOTE : Please refer to STATUS explanation**

Status	Explanation
GOOD	GOOD
PRE-FAIL	Alerts that may be a problem
PAST PRE-FAIL	“PRE-FAIL” occurred before
FAIL	Find problem / need to replace

---

## 6. NETWORK

A static service consists of an IP address that remains constant for the duration of the contract of the internet service, whereas a dynamic service has an IP address that changes every time a new connection is made through the provided modem, or recurrently in a given period of time. Though most internet service providers offer both solutions, this manual will distinguish between the two solutions, according to the commonly available service types, to configure the DVR for the networking purposes.

### 6.1. ETHERNET

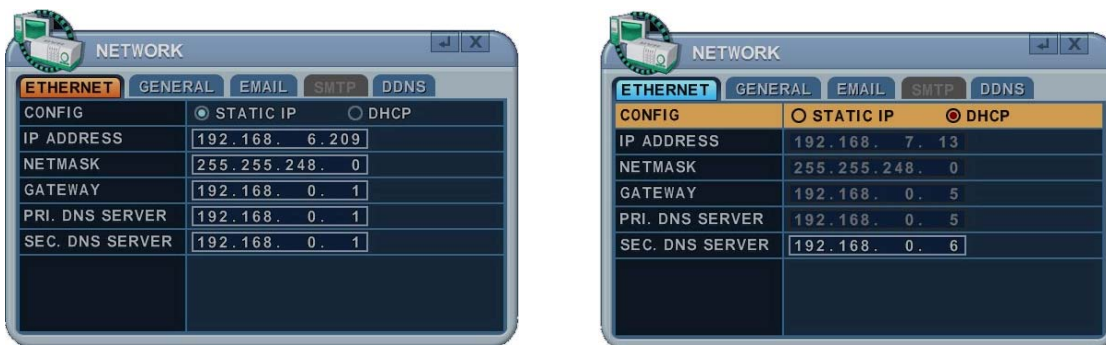

#### 1. Static IP

If a Static IP is selected, the following settings are available:

- 1) **IP Address:** Enter the static IP address
- 2) **Netmask:** Enter the IP address of the subnet mask.
- 3) **Gateway:** Enter the IP address for the internet gateway server.
- 4) **PRI.DNS Server:** Verify the name of the domain name system.
- 5) **SEC.DNS Server:** Enter the IP address of the backup domain name system (DNS) server that the DVR will use to convert name to IP address. This server is used if the primary DNS server fails.

**<Note>** if you do not set up the DNS server correctly, it will have problem with mail sending.

#### 2. DHCP: Dynamic Host Configuration Protocol.

It is automatically set on from Local DHCP if there is a Local DHCP server (i.e. the local Router). If DHCP is set to ON, the IP address, Gateway and subnet Mask are assigned by the DHCP server (i.e. the Local Area Network Router).

## 6.2. GENERAL



1. Access Port: Select "0001 ~ 9999"  
Enter the port number the client uses to communicate with the DVR over the internet. The default port is 7000. It is recommended to use a port above 1000.
2. Bandwidth: Select the network bandwidth to limit the amount of network resources allocated to client connection. The default is unlimited: " 4 KBPS ~ 8 MBPS"
3. Block
  - 1) Ping Block: No response to ping. By default OFF.
  - 2) Scan Block: No response to Auto Scan from EMS. By default OFF.
4. Stream Mode: Select network stream mode. Choose between Dual or Optimised
  - 1) Dual: Streaming the video/audio data with a specified quality, it's independent of recording configuration.

**<Note>** Max Dual Stream for Network

NTSC	Available F/S by channel		
16 CH	CIF, 7 F/S		
8 CH	CIF, 7 F/S	CIF, 15 F/S	
4 CH	CIF, 7 F/S	CIF, 15 F/S	CIF, 30 F/S

PAL	Available F/S by channel		
16 CH	CIF, 6 F/S		
8 CH	CIF, 6 F/S	CIF, 12 F/S	
4 CH	CIF, 6 F/S	CIF, 12 F/S	CIF, 25 F/S

- 2) Optimised: Stream the video/audio data with a maximised throughput. It depends on the recording configuration but use manufacturer's own method. It provides better network streaming rate.

### Example

RECORDING SETUP		NETWORK STREAM	
D1/2CIF,CIF	30 (25) FPS	D1/2CIF,CIF	30 (25) FPS
D1/2CIF,CIF	1~15 (1~12) FPS	D1/2CIF,CIF	15 (12) FPS

5. Stream Property: Is activated when you select dual streaming.
6. Access Host and Host List: Allows you to access or deny specific IP address.  
To allow or deny remote access requires you to enter a range of IP addresses as an IP address and mask. Host List will be activated when you select deny or allowed.



7. Auto Port FWD: Select the ADD button to automatically open ports for Router communication with UPNP compliance.
8. 2 Way Audio: Support 2 way Audio between DVR and Remote Software.

### 6.3. EMAIL

This DVR allows you to specify the events that generate notification. Sends e-mail notification if an event occurs, such as alarm, motion detected etc.

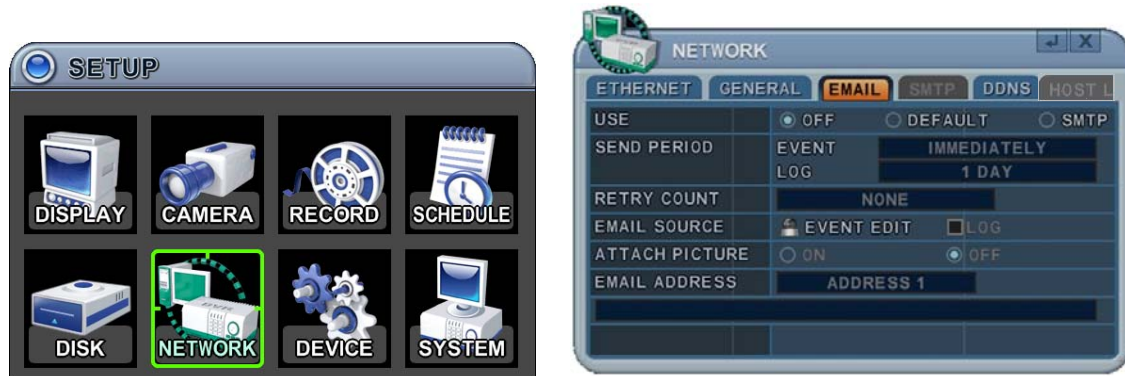

The mail server can use either the DVR mail server or your existing e-mail settings. The menus are displayed with options in the left-hand column and settings in the right hand column. A cursor (highlighted menu) can be moved using the directional buttons [▲▼◀▶].

1. **USE:** Select the e-mail notification ON or OFF. The default is OFF. Press the [-, +] buttons to select. Using the mouse, click the option to select mail server.
  - 1) **Default:** Default it is provided by manufacturer. Mail notification options and mail address settings are available.
  - 2) **SMTP:** SMTP Configuration tab is activated to set up your own mail settings.
  
2. **Send Period:** e-mail will be sent at selected intervals.
  - 1) Event: [Immediately, 10 Minutes, 1 hour, 1 Day]
  - 2) Log: [1 Day, 1 Week]
  
3. **Retry Count:** Select the number of retry attempts to send e-mail after failure.
  
4. **E-mail Source:** Event must be specified using notification options.
  - 1) Event Edit. Notifications can be enabled for each channel for Alarm, Motion, Video Loss and System (HDD Fail, Record Fail, HDD Full etc.). Press the [enter] button to select.





5. Log: This DVR will mail Log List at selected intervals.
6. Attach Picture: While in recording mode, a picture can be attached to mail.
7. E-mail Address: 5 mail addresses can be configured for mail notification.

## 6.4. SMTP

This menu is activated when you check <SMPT> on EMAIL.

The following settings are only needed if you are NOT using the DVR mail server.

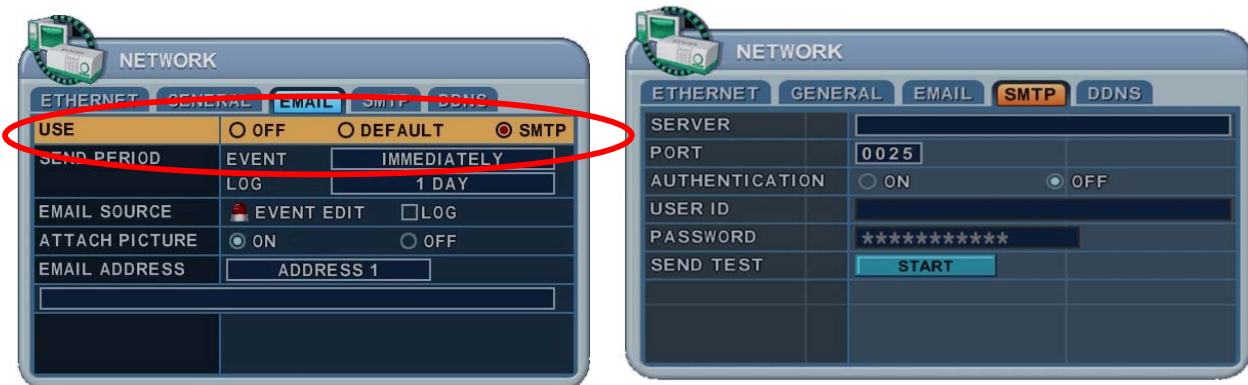

1. Server: Enter the e-mail server name or IP address. To set server name, use the virtual keyboard, or press the appropriate numeric button on IR Remote or front panel.
2. Port: Define the port the SMTP server will communicate through. By default, it is set to 25.
3. Authentication: Check this <ON> if your mail server requires authentication.
4. User ID & Password: Enter the user ID/name and password for the SMTP Server. (It is recognised as Lower Case, even though it's displayed in Upper Case).
5. Send Test: Test to send e-mail.
6. Save changes and exit the menu, press the [MENU] button.  
Exit the menu without making changes, press the [CANCEL] button.

## 6.5. DDNS (Dynamic DNS)

This DVR offers free dynamic DNS update. It keeps track of your changing IP address. It's easiest to use.



The menus are displayed with options in the left-hand column and settings in the right hand column. A cursor (highlighted menu) can be moved using the directional buttons [▲▼◀▶].

1. **USE:** Select DDNS ON or OFF. The default is OFF. Press the [-, +] buttons to select. Using the mouse, click the option to select DDNS provider.

1) **Default:** Default it is provided by manufacturer. We offer DDNS service for remote at <http://www.dvrhost.com>

If you are using <Default> for DDNS, you do not need to setup anything. It does not allow you to create a host name; it's provided by the DVR. Press the [info] button on IR remote or Front Panel, then check your host name and Mac address.

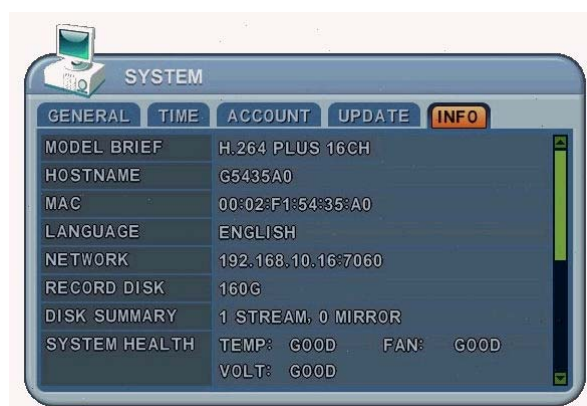

For example, <http://G747474.dvrhost.com:7400>

---

2) **DYNDNS:** To use your own domain name service or “dyndns.com”

2. The following settings are only needed if you are NOT using the default.
  - 1) Domain Name: Enter the name you set for the DDNS web configuration.
  - 2) User ID: Enter your user ID.
  - 3) Password: Enter your password.
  - 4) Update Test: Click the Update Test button to confirm the connection. A success message will appear.
3. Save changes and exit the menu, press the [MENU] button.  
Exit the menu without making changes, press the [CANCEL] button.

## 6.6 Router & Port Forwarding

A majority of networks will often consist of a single IP address which shares internet access through a router. This IP address may be any external (public) static IP address or any dynamic IP address issued by the Internet Service Provider.

The purpose of a router is to enable multiple personal computers and any other devices that require internet connection to access the internet simultaneously. Most routers by default enable (open) commonly used ports so that mainstream applications such as Hypertext Transfer Protocol (HTTP, Port 80), File Transfer Protocol (FTP, Port 21), Telnet (Port 23) and Post Office Protocol 3 (POP3, Port 110) are used.

To solve the firewall problem, and let a visitor into the network, the user instructs the router to allow traffic to pass through on a given port. This is known as Port Forwarding, as the router forwards (directs) all internet requests on a specific port to the local machine. With port forwarding, external visitors are able to connect to the DVR while other internal devices remain protected.

Here is the example of DVR connection.

Network	Router	DVR IP Setting	PC Connect position			PC Connect position		CF
			① LAN			② WAN		
			A	B	C	B	C	
Static IP	use	STATIC	○	△	X	★	★	
		DHCP	○	▲	X	☆	★	Check the DVR IP of info and set into Router.
	x	STATIC	○	○	○	○	○	
		DHCP						N/A [Need Local DHCP Server]
DHCP	use	STATIC	○	△	X	★	★	
		DHCP	○	△	X	★	★	Check the DVR IP of info and set into Router
	x	STATIC						N/A
		DHCP				△	△	PPPOE is not supported



## 7. DEVICE

### 7.1. GENERAL

This DVR support 4/8/16 channel Audio, Alarm Inputs, 4 x Relay Outputs and supports HDMI output.



1. The menus are displayed with options in the left-hand column and settings in the right hand column. A cursor (highlighted menu) can be moved using the directional buttons [▲▼◀▶].

1) DISPLAY : Please decide output video resolution

- It can be set to the correct video resolution on the monitor.

[800\*600 → 1024\*768 → 1280\*720 → 1280\*1024

→ 1600\*1200 → 1680\*1050 → 1920\*1080I →

1920\*1080P ]

- **HDMI AUTO**

Automatically detects and sets the HDMI resolution on the monitor connected to the DVR. It might display “no video” if a VGA monitor is not able to support high resolution.

#### <NOTE>

In order to connect HDMI and VGA output to use both monitors, please set up as the lowest resolution without selecting HDMI AUTO.

2) Audio Record: Select audio recording device use: ON or OFF.

The audio data is always recorded in real time unlike the video data, which can be recorded in various modes, including real time. There may be a slight delay in synchronisation of the audio to video

3) Keypad Model: Select Joystick Controller and Baud Rate.

4) Extend Device: Select a model of POS/ATM.

5) PTZ Event: DURATON [OFF,1SEC ~ 5 SEC]: Select PTZ EVENT duration.

6) Alarm Out: DURATON [OFF,1SEC ~ 5 SEC]: Select Alarm duration.

2. Save changes and exit the menu, press the [MENU] button.  
Exit the menu without making changes, press the [CANCEL] button.

## 7.2. ALARM

This DVR supports 4/8/16 Alarm Inputs and 4 x Relay Outputs. One Alarm Input can be configured to one Relay Output. One relay output can be assigned to multiple Alarm Inputs.



1. Use the Left/Right buttons [◀▶] to select "ALARM" menu tab. The menus are displayed with options in the left-hand column and settings in the right hand column. A cursor (highlighted menu) can be moved using the directional buttons [▲▼◀▶].
  2. **INPUT:** Change the input type. Use the [-, +] buttons to change the values.
  3. **OUTPUT:** you can configure how the Relay Outputs are controlled: automatic or manual.
    - 1) **Use:** Change the output type.
    - 2) **Inactive:** Select turn off method of Relay Out.
      - a. **Event (Automatic):** Relay Out is turned OFF when the event expires. This setting is configured globally.
      - b. **Manual:** Relay Out is turned OFF from this menu <Control>.
    - 3) **Event Edit**
- Press [enter] to edit multiple events. The menus are displayed with options in the left-hand column and settings in the right hand column. A cursor (highlighted menu) can be moved using the directional buttons [▲▼◀▶] on the IR remote or front panel.



- 
- Change the options below using the [DEC/INC] buttons on the IR remote, or click the mouse.
  - System menu contains below
    - HDD Disk Fail
    - Record System Fail
    - Temperature Warning.
    - Fan Lock Warning
    - Voltage Warning
    - Low RTC Battery Warning
    - External Device Event
    - Network Link Disconnected
    - Admin Login
    - Power Recovery
    - Disk Full
    - Invalid Password in Sequence
    - Auxiliary Event (Reserved )

4) Control: Manual stops for relay output and buzzer.

#### 4. Buzzer

##### 1) USE

- **ON:** The Buzzer sounds if an alarm is triggered. The buzzer sounds for the duration of the RECORD TIME. This buzzer relates to Alarm Out. Configure Alarm Out to "ON" for Alarm Buzzer.
- **OFF:** Disables the ALARM BUZZER function.

##### 2) **Inactive:** Select turn OFF Buzzer

- a. Event (Automatic):** Buzzer is turned OFF when the event time expires.
- b. Manual:** Buzzer is turned OFF from this menu <Control>.

5. Save changes and exit the menu, press the [MENU] button.

Exit the menu without making changes, press the [CANCEL] button.



### 7.3. PTZ EVENT

When an Alarm is triggered, Motion detected or Video Loss occurs, this DVR sends a preset command to a PTZ camera. The PTZ option must be enabled and a protocol must be assigned to the camera channel.

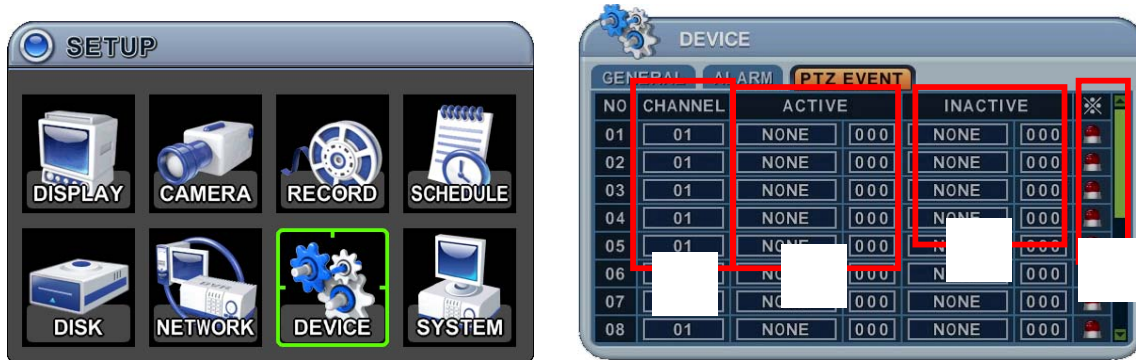

1. Channel: Select desired PTZ camera.
2. Active: Configure PTZ action [ **NONE** → **GOTO** → **TOUR** ] and Preset number or Tour group when an event is detected.
3. Inactive: Select Camera position after the event duration expires.
4. Event Edit.

Press [enter] to edit multiple events. The menus are displayed with options in the left-hand column and settings in the right hand column. A cursor (highlighted menu) can be moved using the directional buttons [▲▼◀▶] on the IR remote or front panel.



**<Note>** Do NOT set up Motion detection on the PTZ camera used for a PTZ event. The signal will be looped.

5. Save changes and exit the menu, press the [MENU] button.  
Exit the menu without making changes, press the [CANCEL] button.

## 8. SYSTEM

### 8.1. GENERAL



1. **Control ID:** Each DVR that is preconfigured with the control ID is enabled to respond to, and be operated by, the remote control.
  - To select the DVR to be controlled with the remote controller, press and hold the DVR ID button. While holding the DVR ID button, press the appropriate DVR ID number. For example, enter 05 for DVR ID 05, enter 43 for DVR ID 43 etc. Set the ID of IR controller on "00" to control multiple DVR's at the same time, whatever the DVR ID is.
2. **DVR Name:** Type a DVR name to distinguish its location when you have several DVR's on a Network.
3. **KEY TONE:** By default, the DVR emits a beep every time a button is pressed. Set the key tone to OFF to turn the button beep off. By default it's "ON"
4. **PB DEINTERLACE**
  - ON: Reduces image flicker but also reduces picture quality.
  - OFF: Better picture quality for still images but may have flicker on moving pictures.
5. **AUTO LOGOUT:** You can configure the DVR to automatically log users out. By default it's "OFF". [OFF → 1 Minute → **3 Minute** → 5 Minute → 10 Minute]
6. **S.M.A.R.T. MONITOR:** Turn ON or OFF to display HDD information in the SMART STATUS tab of the DISK menu.

## 8.2. TIME

Make sure to set up your Date and Time before starting to Record.



1. Use Left/Right buttons [◀▶] to select on “Time” menu tab. The menus are displayed with options in the left-hand column and settings in the right hand column. A cursor (highlighted menu) can be moved using the directional buttons [▲▼◀▶]. Press the [-, +] buttons to change the values.

**1) Time Zone:** Refer to <Appendix 1: Time Zone Chart>

Selects the time zone where the DVR is located. Time Zone contains DST (Daylight Saving Time) ON. If you choose Time Zone with DST, there is no change in the system time stamp for recorded data. When the Daylight Saving End date and time occurs the DVR's time goes back one hour.

**2) Date Format:** Select Date display format.

[ MM/DD/YYYY → DD/MM/YYYY → YYYY/MM/DD ]

**3) NTP SYNC:** The internal time of DVR can be synchronised with an external time source using NTP (Network Time Server) Configuration. If the NTP option is ON, the DATE and Time option is inactivate.

**4) NTP Server:** Allows you to use a public or private NTP server. Enter the IP address of the server or domain. The default setting is public “pool.ntp.org”.

<Note> Time Sync. Interval: Min 64 sec. Max 1024 sec.

**5) NTP TEST:** Test whether NTP Server works or fails.

**6) Date & Time:** Set current time and date.

2. Save changes and exit the menu, press the [MENU] button.

Exit the menu without making changes, press the [CANCEL] button.



---

#### 4) **Channel**

Allow each user different live channels for monitoring.

#### 5) **Password**

Enter the 6 characters for the new password, and then re-enter the same password under the CONFIRM section. An asterisk is displayed for each character entered.

2. Save changes and exit the menu, press the [MENU] button.

Exit the menu without making changes, press the [CANCEL] button.

<NOTE > Please make sure you download all of files below (15M).

x6k\_all.00.00.00.img

## 8.4. UPDATE

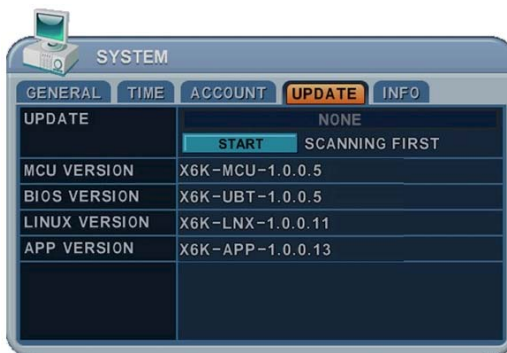

1. Download the latest firmware file and copy to USB Flash memory stick in the **Root** directory.



2. Connect or insert into Front USB (please stop recording first).

3. Use directional buttons to move to the [Start] button. Press the **[+]** button to find upgrade files. If the DVR finds a valid upgrade file, the update menu is activated.

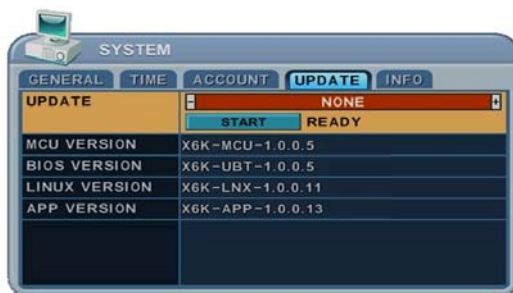

4. Press the **[-, +]** buttons to find correct upgrade file. Version information is displayed. If there are several valid update files, please check the display for the correct one.



**NOTE 1** Do not switch OFF or PRESS any key during the update process.

**NOTE 2** Please consult your distributor or installer before update this DVR.

5. Use the directional buttons to move to the [Start] button, then press **[+]** button to start updating.

While updating, an "in progress" message is displayed.

6. After the update process is complete, a "Success" message is displayed. Press the **[+]** button to restart. The DVR issues a single beep, if Micom update is included.



## 8.5. INFO

System information contains brief model information, Mac Address and installed HDD status.



Press the info button on the remote control or front panel. The system information is displayed. Use the directional button to move to the next page.

## VII. PAN/TILT ZOOM CONTROL





PTZ control is available for supported third-party dome cameras. The PTZ option must be configured for each camera channel. For PTZ setup, refer to Camera Menu> **PTZ setup**.

The layout of the PTZ interface conforms to the layout of the front of the DVR or the remote controller. Menu button is the guide anchor position for all other buttons. When in PTZ interface mode, all buttons are used for the PTZ related operation.

### 1. P.T.Z. Menu

- 1) To activate the Pan/Tilt Control, select the full screen display of the camera you wish to control.
- 2) Then press the **[P/T/Z/FOCUS]** button. A shortcut Menu box pops up, as shown below.



INDICATOR	ACTIONS
 <p>[ENTER] [CANCEL]</p>	<ul style="list-style-type: none"> <li>• Press this button to display “<b>HELP</b>” Menu. Press <b>[ENTER]</b> Button again, or <b>[CANCEL]</b> button to cancel Help Menu.</li> </ul>  <ul style="list-style-type: none"> <li>• Press this button to cancel “<b>PAN/TITL</b>” Operation.</li> </ul>
 <p>[MENU] Button</p>	<ul style="list-style-type: none"> <li>• PTZ camera control interface is extended to use all functions. Press this button again to go to the short-cut menu.</li> </ul> 
	<ul style="list-style-type: none"> <li>• To Tilt Up and Down.</li> <li>• To Pan Right and Left.</li> </ul>



---

	• Zoom In and Out.
---	--------------------

### 1.1 How to Control PTZ Using a Mouse

Users can control PTZ camera using the mouse controller.  
It follows the mouse cursor instead of using the directional button to move.

- 1) Press the PTZ button on the virtual remote controller.



- 2) PTZ menu and control box is displayed like the picture shown below.
- 3) Place the mouse cursor inside the rectangle boundary. Move the mouse cursor, while pressing the left mouse button, in the direction you want to go.

**Note. Mouse cursor cannot move out of the rectangle while the left mouse button is being pressed.**





- 4) Press the  menu button to display the virtual PTZ controller. Zoom In/Out, Go To, Tour and other functions can be controlled using the virtual PTZ controller.

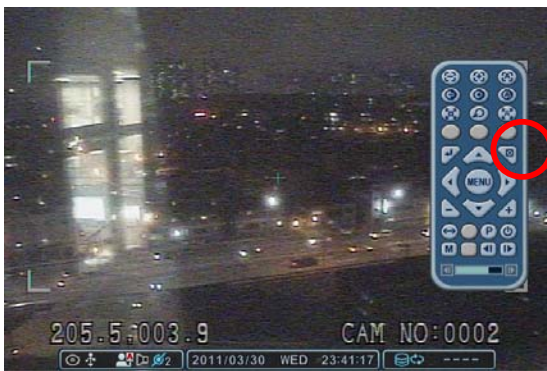

- 5) To escape from PTZ mode, press the ESC button on the PTZ controller. Or click right button, outside the control box, to return to the virtual remote controller. Then click the ESC button.



## 2. Preset & Tour

Button	Function
	Set preset position; SPOT OUT on remote controller Move the PTZ into the desired location. Press the Preset button. Custom 1 illuminates. Set the # for the Preset location. Press Enter to save and exit.
	Go to preset position; INFO on remote controller Press Go to button. Enter the desired Preset # and press Enter.
	Start Auto Tour; BACKUP on remote controller Press Auto Tour Button. Press the + button and enter the range of Preset and press Enter.

## 2.1 Tour Group

A preset Tour Group allows a camera to move through a programmed sequence of PTZ presets.



### 1) Communication settings.

:Configure appropriate model and then enter the corresponding baud rate, PTZ ID (address). Please refer to the PTZ manufacturer's instruction manual for proper jumper settings to match the protocol settings to the DVR.

2) **Tour:** There are 4 programmable Tours. Use the [-, +] buttons to change the values [Group 1 → Group 2 → Group 3 → Group 4]

3) There is sub menu of each Tour group. The menus are displayed with options in the left-hand column and settings in the right hand column.

a. **Group List:** Each Tour Group can consist of up to 10 preset positions.



b. **Preset no. :** Enter the start preset no and stop preset.

c. **Dwell Time:** Set the pause between end of current preset and the start of the next preset.



d. **Change:** Add, modify or clear the Tour list using this option.

f. Repeat the procedure in **step b** to **d** to add Tour list.

### 3. Custom Functions

Button	Function
	PTZ custom function 1; DISPLAY on remote controller
	PTZ custom function 2; ZOOM on remote controller
	PTZ custom function 3; P/T/Z on remote controller

### 4.Auto Pan / Auto Tilt / Power

Button	Function
	Auto Pan; STOP on remote controller
	Auto Tilt; REW on remote controller
	Power On / OFF; FF on remote controller

### 6 . PTZ Camera Model – PAN/TILT/ZOOM Camera List

#	Model Name	3X	Speed	Preset	Go to	Tour	A. Pan	A.Tilt	Pat	Me	Esc/ Enter
1	PELCO, D	o	o	o	o	o	o		o	o	
2	RVT, EZ Protocol	o	o	o	o	o			o	o	o
3	PELCO, P	o	o	o	o	o	o		o	o	
4	Hitron, Fastrax 2	o	o	o	o	o			o	o	o
5	Bosch, Auto Dome										
6	MERIT LINLIN										
7	APPROMEDIA										
8	LG,MULTIX CAM/DOME										
9	BBV,PROTOCOL V2										

**<Note> Speed has 0~8 steps**

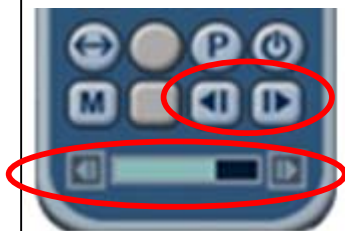

1 (Slow) – 8 (Fast)

# VIII.PLAYBACK /SEARCH Channel

The DVR supports 2 playback modes; Playback and Search. The DVR offers a variety of search functions that enable you to quickly and efficiently locate and review a specific period from the database. It supports three different search modes: Date/Time, Event, Event Area and Log Search.

## 1. Playback

When the [PLAY] button is pressed, the DVR starts to play back any recorded data from the latest data, whether in live or recording mode. When the DVR reaches the end of the recorded data, it stops the playback.

During the playback, the DVR may be played back in reverse, paused, speed search up to 16 times the normal speed, or move through picture by picture.

## 2. Time Search

### 2.1 Multi Channel Playback

1. Press the  [Time Search] button to access the time search table. Day will be displayed. The data is colour-coded by category: EVENT (Red) > Normal (Yellow)



2. Use the [+] button to navigate to the desired **Day→Hour→Minute (5min) →Minute (30 sec)**. Use the [-] button to go back Minute (30sec) →Minute (5min) →Hour→Day.

When using the mouse, the wheel is used for the [+/-] button.

**<Note>** Use the [Play] button to move to the end of data

Use the [Rewind] or [Fast-forward] buttons to move to the next page.

3. To review all channels, press the [ENTER] button on the slot on the bar. When

using the mouse, double click.

Channel

- The DVR starts the playback mode, displaying all channels. Any channel number or the DISPLAY button may be pressed to change the display mode.

## 2.2 Preview Search (Single Channel Playback)

The DVR allows you to quickly review a single channel of playback over a period of Day, Hour, and Minute.

- Press the  **[Time Search]** button to access the time search table. Day will be displayed.

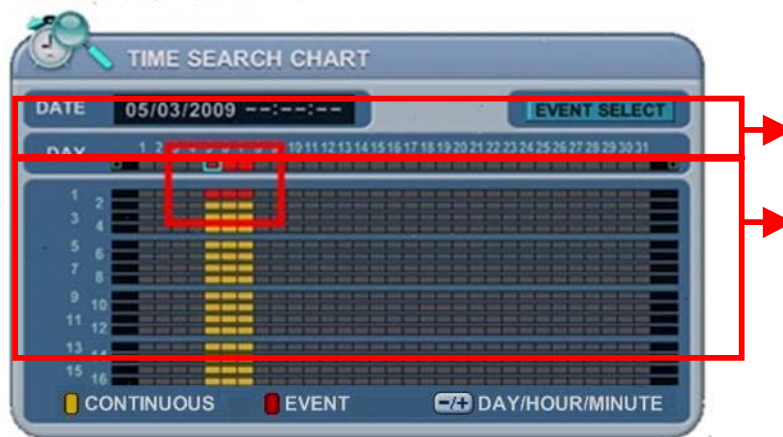

- Choose the desired channel to review by pressing a numeric button.

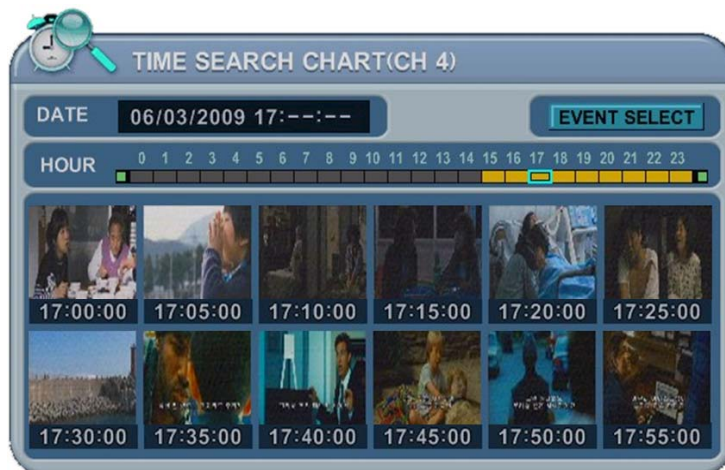

- Use the **[+]** button to navigate to the desired **Day→Hour→Minute (5min) →Minute (30sec)**. Use the **[-]** button to go back Minute (30sec) →Minute (5min) →Hour→Day. When using the mouse, the wheel is used for **[+/-]** button.
- While reviewing snapshot, use numeric buttons to review other channel.
- Use the directional button to select snapshot and, press the **[ENTER]** button. Using mouse, double click.
- The DVR starts the playback mode, displaying the selected channel. Any channel

number, or the DISPLAY button, can be pressed to change the display mode.

### 2.3 Event Record Search

Event Record search feature allows you to search for recorded video by event. The time search table displays time events. As a default, the TIME SEARCH CHART displays CONTINUOUS recording (Yellow) and EVENT recording (Red). TIME SEARCH CHART displays different outcomes according to the SEARCH MODE below.

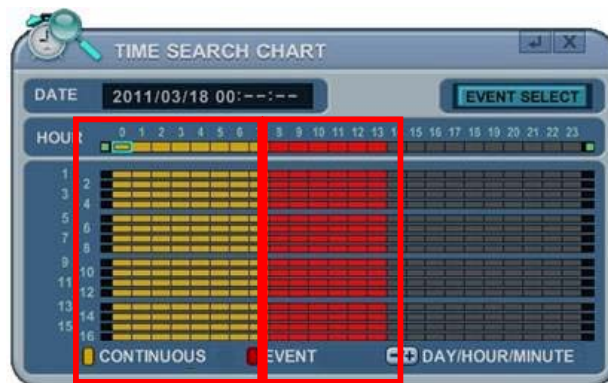

[FIGURE 1]

1. Press the “Event Select “ button to change search mode.

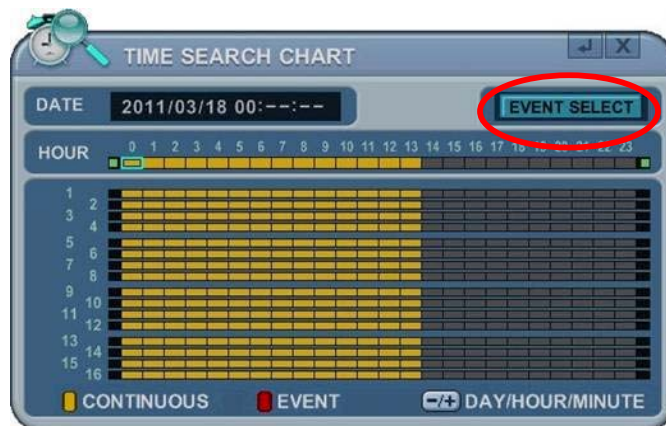

2. Press [Enter] to set up. Press [+/-] button to select “event record”.



3. Press [+/-] button to select “SEARCH MODE “(Event Source /Motion Area). By selecting Search Mode, TIME SEARCH CHART displays different outcomes.

<Note> EVENT RECORD is set by default and makes the TIME SEARCH CHART display EVENT recording in Red as above FIGURE 1.

## 2.4 Event Source Search

Event source search feature allows you to search the recording data for ALARM, MOTION and VLOSS events previously triggered on the DVR.

1. Press [+/-] button to select "Event Source" in search mode.  
And select the event source (Alarm, Motion, Vloss) which you want to search.

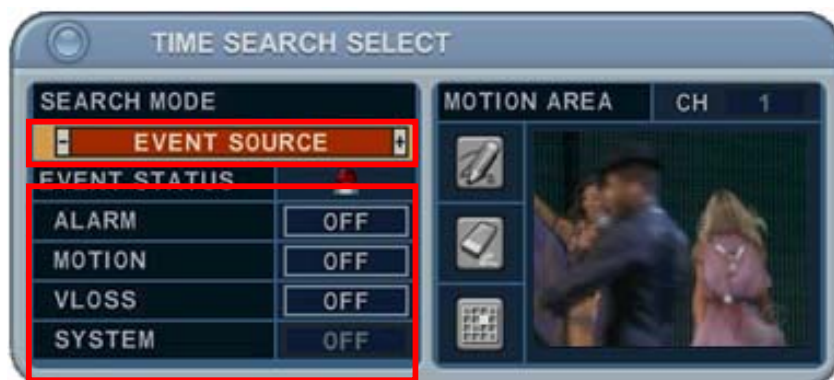

- 1) ALARM: Select Alarm Input 1~4.
  - 2) MOTION: Select the channel 1~16.
  - 3) VLOSS (Video Loss): Select the channel 1~16.
  - 4) SYSTEM: Inactivated
2. Users can have multiple selections by pressing  icon, as shown below.





## 2.5 Motion Area Search (Single Channel Playback)

The DVR searches for recorded video that matches the search area defined by selected cells.

1. Select "MOTION AREA" (single channel playback) to search the recording data that has motion in a specific area on a certain channel.

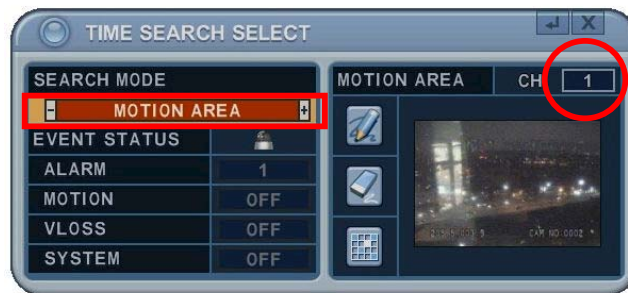

2. Press the [+/-] button to select the channel you want to search.
3. Select the motion area you want to search.

 : Select all grids

 : Deselect all grids

 : Select grids, one by one, by pressing the [+/- ] button

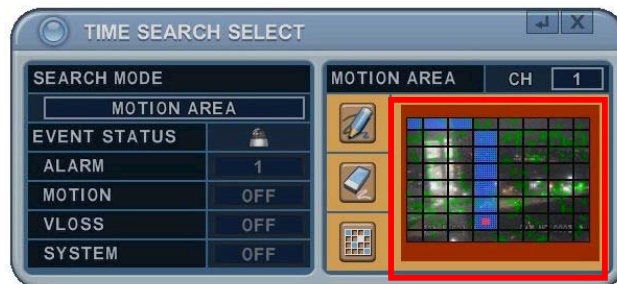

4. Press the MENU button and the TIME SEARCH CHART displays recording data, in red, to show what's happened on that channel.



---

### 3. Go to Search



1. Press the [Time Search] button for 2 second and the [Time Input] menu pops up.
2. Set the date and time you wish to search.
3. Press [Enter] or [Menu] to start searching.

**Note**> 1) Log list is saved on HDD.

;) For more detailed information press 

## 4. Log List Search

The logs can be used to search, and to review, any point in time of the recorded data. Alarm, Motion, Video Loss and system related logs can be searched and played back directly from the time of the incident.

1. To start an Event Search, press the  **[Log]** button on the IR Remote and the Log List Menu pops up, as shown below.

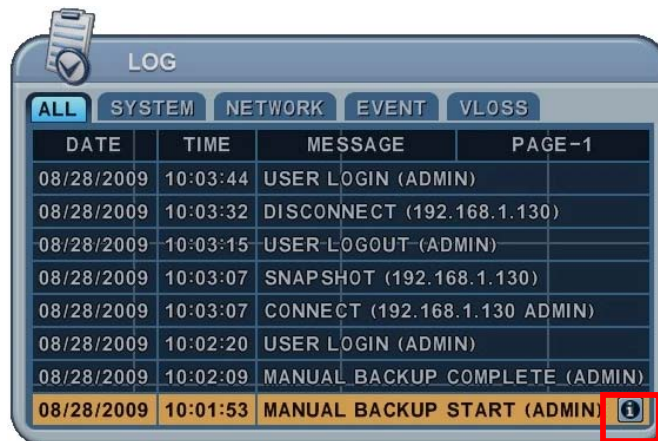

MENU TAB	CONDITION
ALL	• A list of all events since the initial DVR power on procedure.
SYSTEM	• Shows the System List.
NETWORK	• Shows the NETWORK List.
EVENT	• Shows the Events List.
VIDEO LOSS	• Shows Video Loss List.

2. Use the Up/Down buttons [**▼▲**] to the desired “Time” to playback. Use the Left/Right buttons [**◀▶**] to move to the NEXT page.
3. Press the **[ENTER]** button to start playback.



---

# IX.BACKUP

## 1. Manual Back Up

### 1.1 Internal DVD- R/W

**<Note>** Backup process to the CD-RW and DVD-RW only works on manual method, due to the limited capacity of the medium.

1. Insert a blank Media Disk into Built-in CD (not BDVR).

**<Note>**

Please note that CD/DVD-RW disks must be formatted before backup. Disk Format is discussed in the Disk Manu.

2. Press the [BACKUP] button on IR Remote and the backup menu appears.

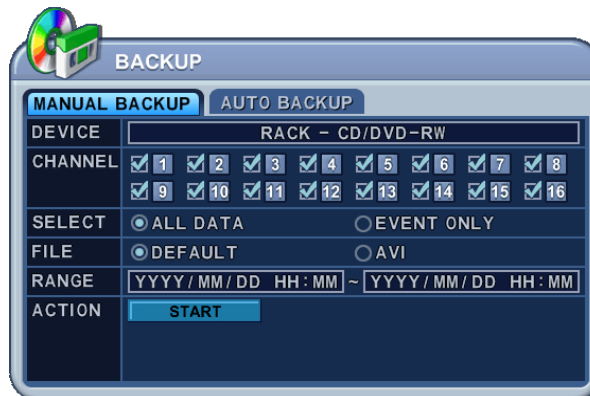

3. Use the [-, +] buttons to change device selection: Rack-CD/DVD RW
4. Use the [-, +] button to select a channel. All channels are set by default.
5. Select the data for BACKUP.
  - (1) ALL Data: Normal Recording Data
  - (2) Event Only: Event Recording Data.
6. File format when saving is “.s” AVI is not supported for CD/DVD
7. Select the time range starting time and ending time.
8. Enter the numbers as required in 24-hour format, then move to **START**.
9. Press the [+] button to start BACKUP.

\* CD/DVD indicator changes to a light blue colour when the backup is in session.



- The progress of the backup is displayed at the bottom of the window as a percentage of the entire backup process. Please note that the internal CD-RW icon's colour will change to blue to signify that backup is in progress. The OSD disappears by pressing cancel button. However, pressing the Backup button again will show the Backup status. It is recommended that playback is not performed while the DVR is in a backup session..

10. When finished, the CD icon will change to Grey, and the media is ejected.

- If there is not enough space on the media the DVR automatically ejects the disk when it's full and resume the process once new media is inserted into the drive.

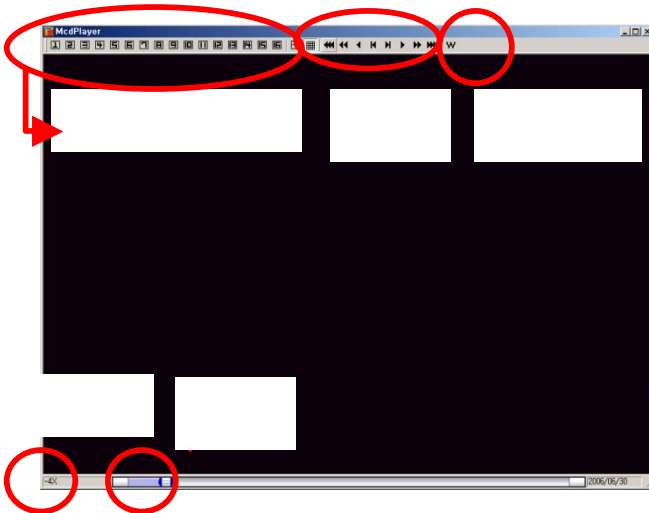

\* The CD Playback software will simply “**auto-run**” and does not require any software installation on your PC.

<Note> Please Refer to [LOCAL PLAYER] section to read about back-up devices.

<Note 2> When you back up as Multi-Section the Play List pops up instead of Auto Run.

SERIAL	BACKUP TIME	CLIP TIME
W180288	2006/07/01 15:57:02	2006/06/30 18:25:00
W180288	2006/07/01 16:00:09	2006/06/30 19:00:00
W180288	2006/07/01 16:01:57	2006/06/30 19:05:00

OK Cancel

---

## 1.2 External USB HDD/ Memory Stick

The external drive procedure is the same as using the internal CD/DVD-RW for backup.



To read USB backup HDD in Window, format to FAT32 or NTFS.

To backup as an AVI File, set the file format to AVI using the [+] button.

## 1.3 Back up Range Setup

Press the [◀] button to set backup start time and press the [▶] button to set the end. Selected time changes to a Violet colour.

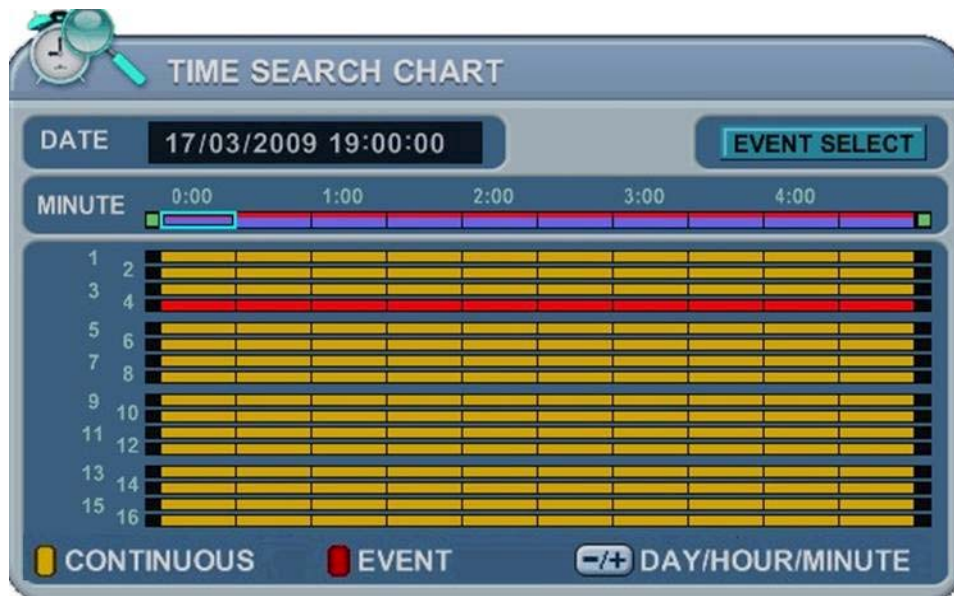

Selected backup time is displayed on the backup range.

[LOG IN/OUT] button is toggled for the range.

## 2. Auto Back Up (FTP)

1. Use the [-, +] button to change the selected device to FTP

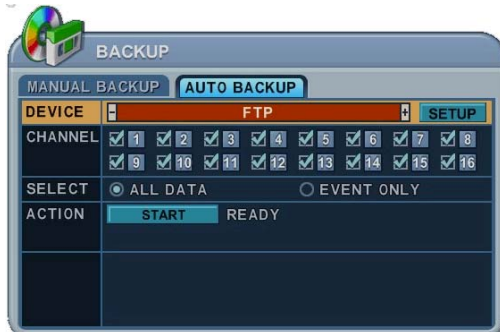

2. Use the directional buttons to move to FTP Setup. The menus are displayed with options in the left-hand column and settings in the right hand column.



ITEM	ADJUSTMENT
Server	<ul style="list-style-type: none"> <li>• Select Highlight FTP Server and then press numeric buttons to define an FTP server.</li> </ul>
Port	<ul style="list-style-type: none"> <li>• Define the port that the FTP server will communicate through.</li> </ul>
User ID	<ul style="list-style-type: none"> <li>• Enter the user ID of FTP Server. (It only recognises lower case letters even though it's displayed as capitals)</li> </ul>
Password	<ul style="list-style-type: none"> <li>• Enter the password. (It only recognises lower case letters even though it's displayed as capitals)</li> </ul>
Connection	<ul style="list-style-type: none"> <li>• Select PASSIVE mode or REGULAR Mode.</li> </ul>
BACKUP PATH	<ul style="list-style-type: none"> <li>• The path should be made in the FTP server in advance. Mac address is set with the default in consideration of the scenario where lots of DVR's backup files to the same FTP server.</li> </ul>

**<Note>** Please Refer to [LOCAL PLAYER]/ [Mini-Player] section to read about back-up file

### 3. Log List Back Up

- 1 . Plug the USB memory stick into the USB port.
- 2 . Press the “Log” button to see the DVR Log List.



The screenshot shows a 'LOG' window with a clipboard icon in the top left. Below the title are tabs for 'ALL', 'SYSTEM', 'NETWORK', 'EVENT', and 'VLOSS'. The 'ALL' tab is selected. The main area is a table with columns: DATE, TIME, MESSAGE, and PAGE-1. The last row is highlighted in yellow.

DATE	TIME	MESSAGE	PAGE-1
08/28/2009	10:03:44	USER LOGIN (ADMIN)	
08/28/2009	10:03:32	DISCONNECT (192.168.1.130)	
08/28/2009	10:03:15	USER LOGOUT (ADMIN)	
08/28/2009	10:03:07	SNAPSHOT (192.168.1.130)	
08/28/2009	10:03:07	CONNECT (192.168.1.130 ADMIN)	
08/28/2009	10:02:20	USER LOGIN (ADMIN)	
08/28/2009	10:02:09	MANUAL BACKUP COMPLETE (ADMIN)	
08/28/2009	10:01:53	MANUAL BACKUP START (ADMIN)	

- 3 . Press the “back up” button to save the log list to USB memory stick.
  - 1) Use the [-, +] buttons to select a device.
  - 2) Select type of Log List from ALL, SYSTEM, NETWORK, EVENT and VLOSS.
  - 3) Select the time range - start and end time.
  - 4) Press the [+ ] button to start the BACKUP.

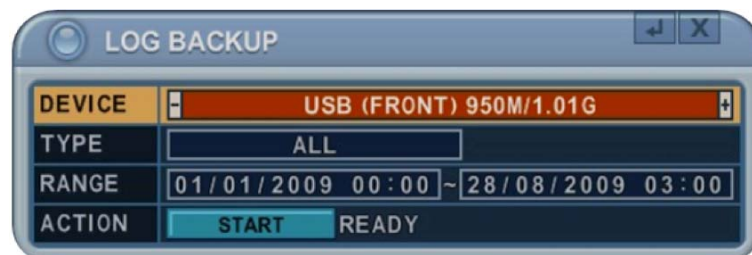

The screenshot shows a 'LOG BACKUP' window with a back arrow and an 'X' button in the top right. It contains a form with the following fields:

DEVICE	USB (FRONT) 950M/1.01G
TYPE	ALL
RANGE	01/01/2009 00:00 ~ 28/08/2009 03:00
ACTION	START READY



# X.SPECIFICATION

Specification	4CH	8CH	16CH
<b>System</b>			
Multiple Function	Quadruplex		
Operating System	EMBEDDED LINUX		
Video Input/ Loop Out	4 IN, 4 OUT	8 IN, 8 OUT	16 IN, 16 OUT
Video Output	Main	1 Composite, 1 VGA, 1 HDMI (1080P)	
	Spot	4 / 8ch – 2, 16ch – 4 (Programmable)	
Alarm In/Out (Relay)	4 IN, 4 OUT	8 IN, 4 OUT	16 IN, 4 OUT
Audio Record	4 IN, 1 OUT	8 IN, 1 OUT	16 IN, 1 OUT
Communication	RS-232C, RS-422, Ethernet (1 GIGA), USB 2.0		
Power	100V ~ 240V, Selectable		
<b>Display &amp; Recording</b>			
Compression	H.264		
Picture Bit Rate (30fps/Ch)	0.6 ~ 7 Mbps/ch @30fps		
Live Display Resolution	720 x 480 (NTSC) / 720 x 576 (PAL)		
Live Display Speed	4 / 8 / 16 CH Real Time		
Display Split Mode	1, 4, 6, 7, 8, 9, 10, 13, 16		
Recording Speed	120fps 720 x 480 (NTSC), 100fps 720 x 576 (PAL)		
	240fps 720 x 240 (NTSC), 200fps 720 x 288 (PAL)		
	480fps 360 x 240 (NTSC), 400fps 260 x 288 (PAL)		
Recording Mode	Continuous, Time Limit, Alarm, Motion, Schedule		
Recording Quality	Low, Middle, High, Super, Ultra		
Motion Detection	Area	8 x 8 selectable	
	Sensitivity	20 Sensitivity Levels	
<b>Search &amp; Playback</b>			
Search Method	SMART Search, Date & Time, Event, Log Search		
Playback of Backup File	Mini Player (Auto copy), EMS, AVI		
Playback Speed	Multi Level (Full Frame Reverse PB supported)		
<b>Backup &amp; Storage</b>			
Backup Storage Interface	2 x USB 2.0 , 2 x SATA (SATA-II), 1 Giga LAN		
Backup Device	External HDD, CD/DVD-RW , USB Flash Memory Stick		
Internal HDD & Capacity	Up to 4 Internal HDDS (SATA-i)		
External HDD& Capacity	Up to 10 External HDDS (SATA-II with PMP Capable) via e-SATA x 2		

DATA Archiving	Ethernet, Remote PC, External Recording Devices, FTP
<b>Time</b>	
Time Zone	Selectable
DST	AUTO
Time Synchronization	Supported via NTP server
<b>Miscellaneous</b>	
Controls	Mouse, IR Remote, Front Key, SMS, EMS, IE
Firmware upgrade	Via USB
Power Consumption	50W
Operation Temperature	0°C~40°C
Dimension / Weight	350(W)*180(D)*82(H)/3.5Kg

Revised June, 2011

### Appendix 1: Time Zone Chart

Standard Time	Time Zone
GMT+00:00	Standard
	European DST
GMT+01:00	Standard
	European DST
	Namibia DST
GMT+02:00	Standard
	Israel DST
	European DST
	Lebanon DST
	Jordan DST
	Russia DST
	Egypt DST
GMT+03:00	Standard
	Russia DST
GMT+03:30	Iran DST
GMT+04:00	Standard
	Azerbaijan DST
	Russia DST
GMT+04:30	Standard
GMT+05:00	Pakistan DST
	Russia DST
GMT+05:30	Standard
GMT+05:45	Standard
GMT+06:00	Standard
	Russia DST
GMT+06:30	Standard
GMT+07:00	Standard
	Russia DST
GMT+08:00	Standard
	Russia DST
GMT+09:00	Standard
	Russia DST
GMT+09:30	Standard
	Australia DST

GMT+10:00	Standard
	Russia DST
	Australia DST
GMT+11:00	Standard
	Russia DST
GMT+12:00	Standard
	New Zealand DST
GMT+13:00	Standard
GMT-01:00	Standard
	European DST
GMT-02:00	Standard
GMT-03:00	Standard
	Brazil DST
	European DST
GMT-04:00	Uruguay DST
	Chile DST
GMT-04:30	US DST
	Standard
GMT-05:00	Standard
	US DST
GMT-06:00	Standard
	Mexico DST
	US DST
GMT-07:00	Standard
	Mexico DST
	US DST
GMT-08:00	Standard
	Mexico DST
	US DST
GMT-09:00	Standard
	US DST
GMT-10:00	Standard
GMT-11:00	Standard

## WEEE Symbol Information



### **Correct Disposal of This Product (Waste Electrical & Electronic Equipment)**

(Applicable in the European Union and other European countries with separate collection systems)

This marking shown on the product or its literature, indicates, that it should not be disposed with other household wastes at the end of its working life. To prevent possible harm to the environment or human health from uncontrolled waste disposal, please separate this from other types of wastes and recycle it responsibly to promote the sustainable reuse of material resources.

Household users should contact either the retailer where they purchased this product, or their local government office, for details of where and how they can take this item for environmentally safe recycling.

Business users should contact their supplier and check the terms and conditions of the purchase contract. This product should not be mixed with other commercial wastes for disposal.

---

**<Memo>**

## Free Manuals Download Website

<http://myh66.com>

<http://usermanuals.us>

<http://www.somanuals.com>

<http://www.4manuals.cc>

<http://www.manual-lib.com>

<http://www.404manual.com>

<http://www.luxmanual.com>

<http://aubethermostatmanual.com>

Golf course search by state

<http://golfingnear.com>

Email search by domain

<http://emailbydomain.com>

Auto manuals search

<http://auto.somanuals.com>

TV manuals search

<http://tv.somanuals.com>