



GARAGE DOOR OPENER MODELS

PowerMax® 1200/1500, SC 1200/1500, TriloG™ 1200/1500, PowerLift® 900, GPower™ 900,
SilentMax® 1000/1200, CB 1000/1200, IntelliG® 1000/1200

SCREW/BELT/CHAIN DRIVES



OPERATION & MAINTENANCE MANUAL

Includes INTELLICODE 2 Remote Control. Safe-T-Beam® System must be installed to close door.
For use only with residential sectional or one piece overhead garage doors.

Homelink® and Car2U® compatible.



Need help or have questions? DO NOT RETURN to the store. Call us: 800-354-3643

**For Answers and Assistance:
1.800.354.3643
or visit www.geniecompany.com**

**SAVE THIS MANUAL FOR FUTURE REFERENCE
INSTALLER: LEAVE THIS MANUAL WITH HOMEOWNER**

WARNING

To reduce the risk of injury to persons or damage to property – Use this opener only with a one-piece or sectional door.

Genie, Genie logo, Intellicode, Safe-T-Beam, IntelliG, PowerMax, PowerLift, ChainMax and SilentMax are registered trademarks TriloG and GPower are trademarks of GMI Holdings, Inc., dba The Genie Company
Homelink is a registered trademark of Johnson Controls Technology Company. Car2U is a registered trademark of Lear Corporation. ©The Genie Company 2012 PN#38209501773, 9/2012

38209501773

Table of Contents

TRANSMITTER COMPLIANCE STATEMENT

Transmitters comply with all United States and Canadian legal requirements as of the date of manufacture. No warranty is made that they comply with all legal requirements of any other jurisdiction. If transmitters are to be used in another country, the importer must determine compliance with any local laws and regulations which may differ from United States and Canadian requirements prior to use.

Los transmisores cumplen con todas las reglamentaciones legales de los Estados Unidos y del Canadá, en la fecha de fabricación. Ninguna garantía se da que cumplan con todas las reglamentaciones legales de ninguna otra jurisdicción. Si los transmisores se van a utilizar en otro país, el importador debe determinar si cumplen con las reglamentaciones y leyes locales que puedan ser diferentes a las reglamentaciones de los Estados Unidos y del Canadá, antes de usar los mismos.

Les émetteurs sont conformes à la réglementation américaine et canadienne à compter de leur date de fabrication. Aucune garantie n'est stipulée indiquant qu'ils sont conformes à toutes les prescriptions juridiques d'autres autorités. Si les émetteurs sont utilisés dans d'autres pays, il incombe à l'importateur d'en déterminer leur conformité aux lois et règles locales pouvant différer de celles des États-Unis et du Canada avant toute utilisation desdits émetteurs.

Sendegeräte entsprechen allen gesetzlichen Bestimmungen in den USA und Kanada zum Zeitpunkt der Herstellung. Wir übernehmen keine Gewährleistung für die Einhaltung aller gesetzlichen Bestimmungen in anderen Ländern. Sollen Sendegeräte in anderen Ländern eingesetzt werden, so muss der Importeur vor dem Gebrauch sicherstellen, dass die Sendegeräte auch solchen lokalen Bestimmungen entsprechen, welche von den Bestimmungen der USA und Kanadas abweichen.

截止于制造日期,传动装置符合美国和加拿大的所有法律要求。不提供传动装置符合任何其他司法地区所有法律要求之担保。如果传动装置需在任何其他国家使用,进口商必须在使用之前确定装置符合与美国和加拿大要求不同之所有地方法规条例。

截止于制造日期,传动装置符合美国和加拿大的所有法律要求。不提供传动装置符合任何其他司法地区所有法律要求之担保。如果传动装置需在任何其他国家使用,进口商必须在使用之前确定装置符合与美国和加拿大要求不同之所有地方法规条例。

截止于制造日期,传动装置符合美国和加拿大的所有法律要求。不提供传动装置符合任何其他司法地区所有法律要求之担保。如果传动装置需在任何其他国家使用,进口商必须在使用之前确定装置符合与美国和加拿大要求不同之所有地方法规条例。



Need help or have questions? Call us:
800-354-3643. DO NOT RETURN
to the store.

1	Safety Information	
	Safety Notifications	3
	Important Safety Instructions.....	3
	Infrared Protection Function	3
2	Features	
	Safety	4
	Opener	4
3	Required Programming	
	Introduction.....	5
	Overview of Powerhead Controls	5
	Travel Limits	
	Closing Garage Door (DOWN Limits).....	6
	Opening Garage Door (UP Limits)	7
	Wall Console Overview	8
	Series III Wall Consoles with Black Buttons ..	8
	Series II Wall Consoles with White Buttons ...	8
	Force and Speed Control.....	9
	Contact Reverse Test	9
	Remotes/New Intellicode 2 Openers	10
4	Optional Programming	
	Keypad.....	12
	Clearing Memory for Remotes	13
	Intellicode 1 Remotes.....	14
5	One Piece Doors	
	Attaching Door Bracket to Door	15
	Attaching Door Arm to Door Bracket	15
6	Maintenance and Adjustments	
	Maintenance Safety.....	16
	Regular Maintenance	16
	Corrective Maintenance.....	17
	Adjustment Guides	18
7	Wiring Diagram	20
8	Troubleshooting	21
9	Warranty	23

SAVE THESE INSTRUCTIONS

READ AND FOLLOW ALL INSTRUCTIONS

1 Safety Information

OVERVIEW OF POTENTIAL HAZARDS READ THIS SAFETY INFORMATION

CONVENTIONS USED IN THESE INSTRUCTIONS

Garage doors are large, heavy objects that move with the help of springs under high tension and electric motors. Since moving objects, springs under tension, and electric motors can cause injuries, your safety and the safety of others depend on you reading the information in this manual. If you have questions or do not understand the information presented, call your nearest trained door system technician or visit our website at www.geniecompany.com

The following safety alert symbol and signal words are used throughout this manual to call attention to and identify different levels of hazard and special instructions.





This is the safety alert symbol. This symbol alerts you to potential hazards that can kill or hurt you and others.

All safety messages will follow the safety alert symbol and the word "DANGER", "WARNING", or "CAUTION".

- **DANGER** indicates an imminently hazardous situation which, if NOT avoided, will result in death or serious injury.
- **WARNING** indicates a potentially hazardous situation which, if NOT avoided, could result in death or serious injury.
- **CAUTION** indicates a potentially hazardous situation which, if NOT avoided, may result in injury or property damage.
- The word **NOTE** is used to indicate important steps to be followed or important considerations.

IMPORTANT SAFETY INSTRUCTIONS

Potential Hazard	Effect	Prevention
	▲ WARNING Could result in Death or Serious Injury	Keep people clear of opening while door is moving. DO NOT allow children to play with the door opener. DO NOT operate a door that jams or one that has a broken spring.
	▲ WARNING Could result in Death or Serious Injury	Turn OFF power before removing opener cover. When replacing cover, make sure wires are NOT pinched or near moving parts. Opener must be fully grounded.
	▲ WARNING Could result in Death or Serious Injury	DO NOT try to remove, install, repair or adjust springs or anything to which door spring parts are fastened, such as, wood blocks, steel brackets, cables or other like items. Installations, repairs and adjustments must be done by a trained door system technician, using proper tools and instructions.

IMPORTANT INSTALLATION INSTRUCTIONS

▲ WARNING

TO REDUCE THE RISK OF SEVERE INJURY OR DEATH

READ AND FOLLOW ALL SAFETY, INSTALLATION AND OPERATION INSTRUCTIONS. If you have any questions or do not understand an instruction, call The Genie® Company or your local Genie® Factory Authorized Dealer.

- **DO NOT** install operator on an improperly balanced door. An improperly balanced door could cause severe injury. Repairs and adjustments to cables, spring assembly, and other hardware must be made by a trained service person using proper tools and instructions.
- Remove all ropes, and disable all locks connected to the door before installing operator.
- Where possible, install the door opener 7 feet or more above the floor. For products having an emergency release, mount the emergency release within reach, but at least 6 feet above the floor and avoiding contact with vehicles to avoid accidental release.
- **DO NOT** connect the operator to the source of power until instructed to do so.
- Locate the wall console button: A) Within sight of door. B) At a minimum height of 5 feet so small children cannot reach it. C) Away from all moving parts of the door.
- Install the entrapment WARNING label next to the wall button or console, in a prominent location. Install the emergency release tag on, or next to, the emergency release handle.
- The operator must reverse when the door contacts a 1-1/2 inch high object on the floor at the center of the doorway. This is about the size of a 2" x 4" board laid flat.

2

Features

Begin here **ONLY AFTER** completing assembly and installation of the opener. Review the *Assembly and Installation* poster to ensure all steps have been performed.

Contact your Genie® Professional Dealer for an installation poster, if needed, or call 1-800-35GENIE. You may also visit www.geniecompany.com to download a PDF file.

SAFETY FEATURES

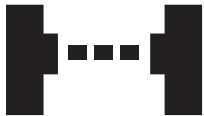

Safe-T-Beam® (STB) Non-Contact Reversing System

Puts an invisible beam across the door opening. The door stops and reverses to the full open position if anything passes through the beam. LED indicator lights on the powerhead and on the STBs provide a self-diagnostic code if an operational problem exists.

Safe-T-Reverse® Contact Reversing System

Automatically stops and reverses a closing door within two seconds of contact with an object.

Automatic ForceGuard™ Control

Automatically sets the force required to fully open and close the door for maximum safety.

Watch Dog™ Monitoring System

Monitors the Safe-T-Beam® system to ensure proper functionality and will automatically stop and reverse a closing door if a problem is detected.



Manual Emergency Release

Manually releases door from door opener. Used during a power failure or other emergency to allow manual opening and closing of door.



SmartSet™ Electronic Programming

Easily adjust the programming to reduce opening speed to a desired rate, vary limits and force, and program new remotes.



Automatic Lighting System

Two bulb lighting system supplies light for safer evening exits and entries. Turns **ON** when door is activated and automatically turns **OFF** 4 minutes later.



Integrated Motion Detection (Not available on all models)

Some units have motion detection built into the powerhead. Lights automatically turn **ON** when motion is detected for much safer movement through the garage. Lights will turn **OFF** after 4 minutes of no motion.

OPENER FEATURES



INTELLICODE® 2 Access Security System

A new generation superior encryption system that enhances the security of the door opener by continuously changing the access code each time the remote is used. The door opener responds to each new code only once. An access code copied from a working system and tried again, will not control the door opener.



Wall Console

Operates door opener from inside garage. The wall console has an indicator light with: Open/Close, Sure-Lock™, and independent light control buttons.



Home Link and Car2U® compatible. Refer to the programming instructions on page 11.



NOTE: Use this manual **ONLY** after completing assembly and installation of opener. Review Assembly/Installation Instructions poster. Check that all steps have been completed.

Contact your Genie® Professional Dealer for an *Assembly/Installation Instructions* poster, if needed, or call 1-800-35GENIE. You can also go to www.geniecompany.com to download a printable file.

INFRARED PROTECTION FUNCTION

1. The Safe-T-Beam® has no effect on the door during an opening cycle.
2. If the Safe-T-Beam® detects an obstruction when trying to close the door, it will not allow the door to close.
3. When the garage door is closing, if Safe-T-Beam® is interrupted by a person or obstacle, the garage door will stop its downward travel and reverse automatically to its fully opened position.
4. If the Safe-T-Beam® System fails, loses power, or is installed improperly, press and hold the wall console "open/close" button until the door reaches its fully closed position. If you release the "open/close" button on the wall console during the closing movement, the door will reverse automatically to its fully-opened position.

3

Required Programming

NOTE: Before you begin programming, check to make sure there are no objects in the garage door opening.

INTRODUCTION

Now that your Genie garage door opener is installed, you will want to program the opener so that the door opens and closes properly and all remote devices operate correctly. The following steps guide you through setting your opener so it functions properly for you.

The following information will take you through programming your opener's functional settings for use.

There are only 2 "required" programming processes you will need to follow to set up your garage door opener for operation:

1. "TRAVEL LIMITS"
2. "REMOTE PROGRAMMING"

Term Definitions:

Travel Limits programming allows you to set how far your door travels up or down in opening and closing your garage door.

Remote Programming synchronizes your remote control devices (remotes, wall console, and keypad) with the powerhead.

Force Control refers to how much power is needed to move (open/close) your particular door and does NOT require programming.

Speed Control refers to how fast or slow your opener opens and closes your particular door and is preset at the factory. This function does NOT require programming.

There are 4 programs (The 2 "Factory Set" programs are unlikely to need changes.)

1. Door Travel Limits Program
 - This program is used to set how far your door travels up and down.
2. Remote Programs (Default menu)
 - These show you how to program your remotes to synch with additional remote control devices, wall consoles, keypads, and the powerhead.
3. Door Force Program (Factory Set)
 - This program is only used for minor adjustments under certain circumstances.
4. Door Speed Program (Factory Set)
 - This program does not require manually initiated changes.

NOTE: The 3 programming buttons are for programming ONLY. These buttons should NOT be used to operate the opener once the Required Programming section has been successfully completed.

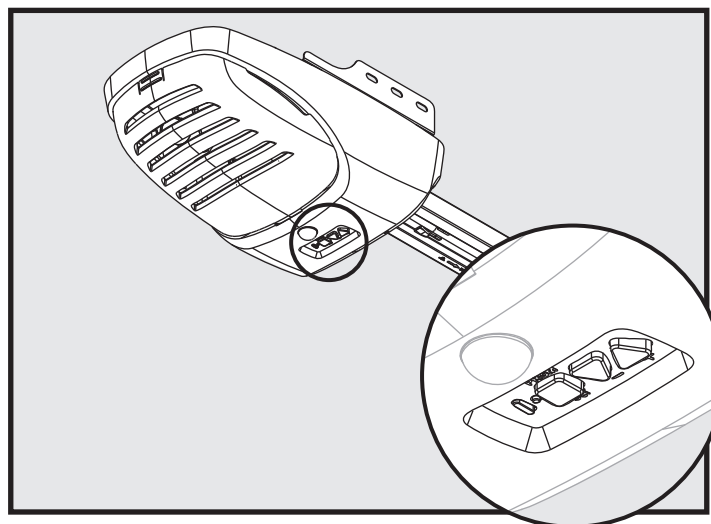

OVERVIEW OF POWERHEAD CONTROLS

This section describes the programming functions on the powerhead of the opener. Use the following information to familiarize yourself with the buttons, LED indicators and products used to program functions.

Powerhead: There are 3 programming buttons and 2 LED lights on the powerhead. Each of the buttons is used to enter and complete the setup programming. The LED lights indicate status or a function change by illuminating ON, OFF, or ON FLASHING in one of three different colors: blue, red or purple.

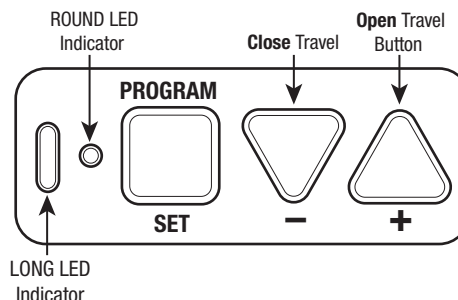

Located on bottom of Powerhead.



Enters into and selects programming menus.



Multi-function; move door during programming and advance through menus

3

Required Programming

TRAVEL LIMITS

⚠ WARNING

- Make sure doorway is in view and clear of obstacles and people to avoid injury or damage to property.
- **DO NOT** operate this unit from wall console before **LIMITS** are set. Severe damage to the opener can occur.
- The shuttle **MUST** be engaged to carriage **BEFORE** setting limits. See *Installation Poster* (if provided) or call Customer Service at 1-800-35GENIE or visit www.geniecompany.com

NOTE: If shuttle/bullet has **NOT** been engaged to carriage, do so now. See page 17.

NOTE: Before setting limits confirm wall console red indicator light (or backlight) is ON. If not illuminated, check for correct wiring or the Sure-Lock switch may be activated.

Closing Garage Door (Down Limits)

- 1** Lift the door open by hand until the shuttle/bullet engages the carriage on the rail.

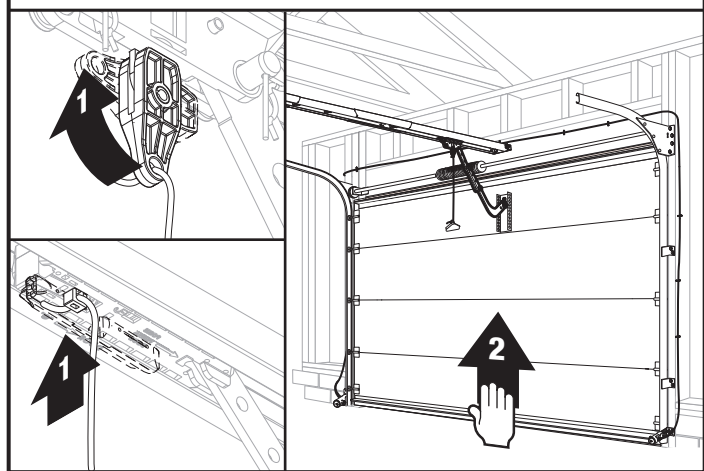

- 2** Press and hold the **down arrow button (-)** for 2 seconds until the long LED comes on blue (round LED remains off).

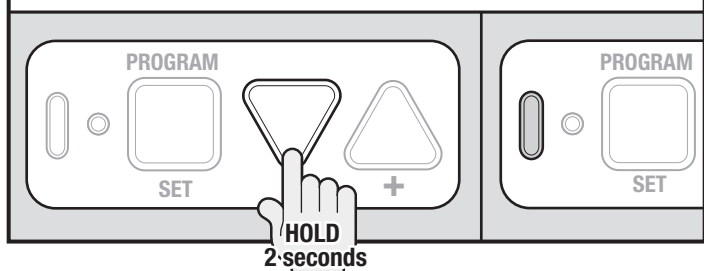

- 3** Release **down arrow button (-)** and the long LED will begin flashing.

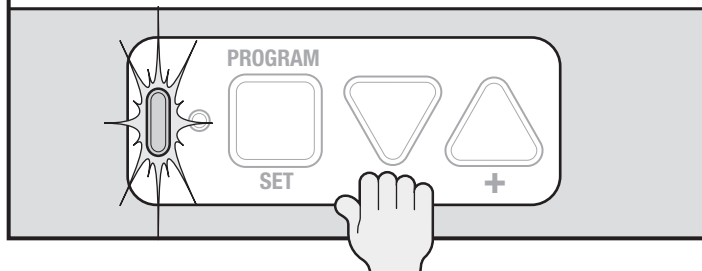

- 4** Press and hold the **down arrow button (-)** until garage door is fully closed on floor, then release.

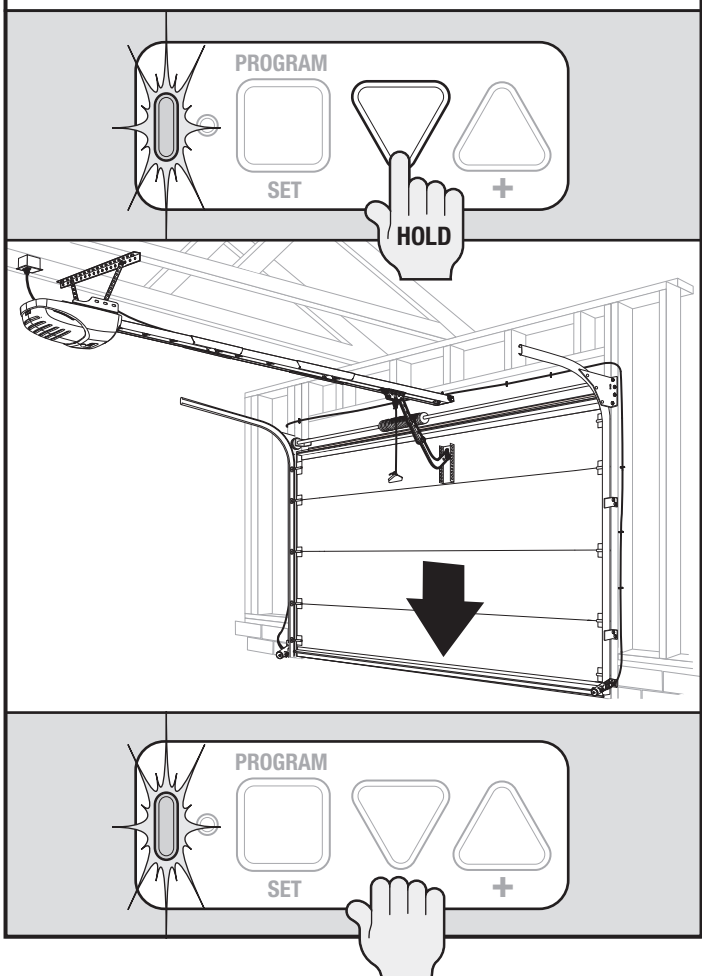

NOTE: You have **30 seconds** to execute each step. If you see **two solid red or flashing LEDs on the Powerhead**, you have run out of time and must go back to the beginning of the step and start over. You can restart as many times as necessary to complete each step.

(continued next page)

3

Required Programming

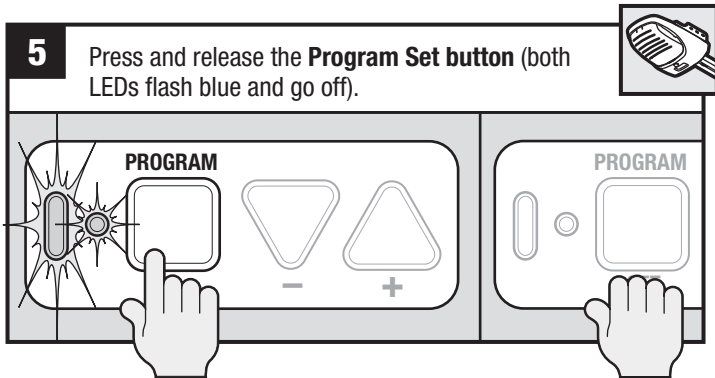

The DOWN (closed) limit is programmed.

Opening Garage Door (Up Limits)

NOTE: Beginning with garage door closed is recommended but not necessary.

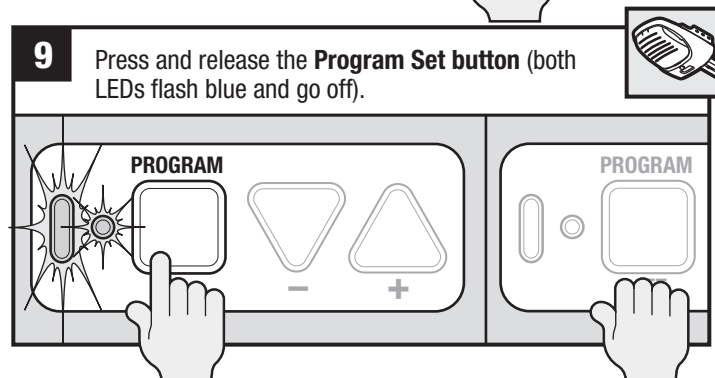
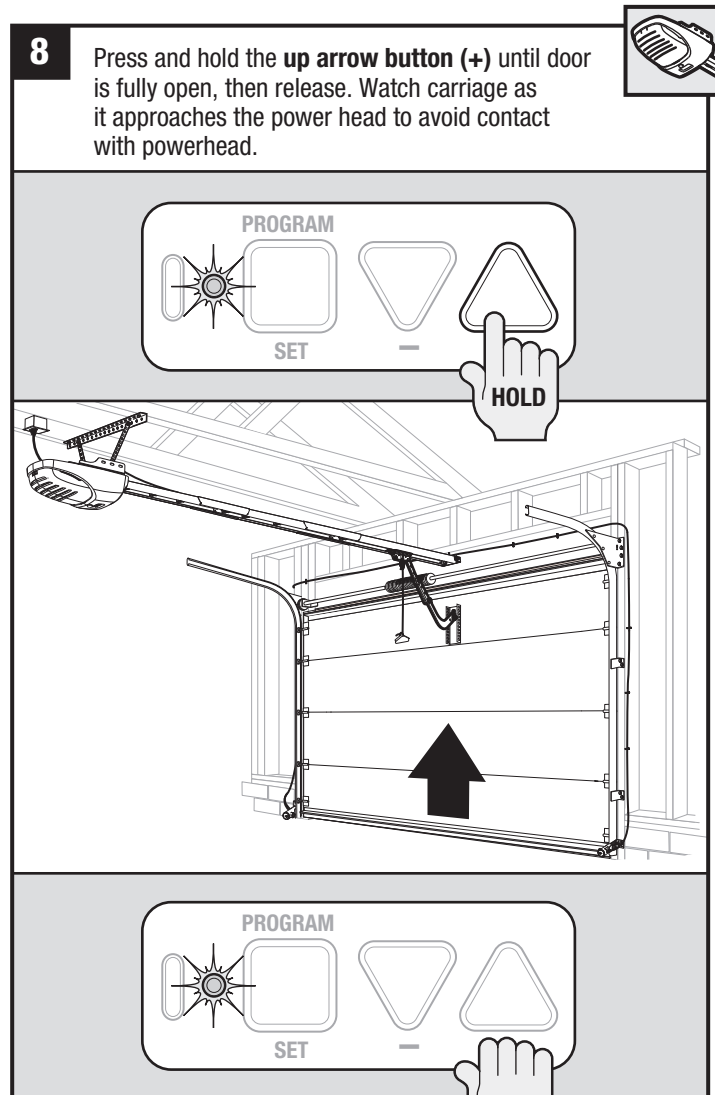
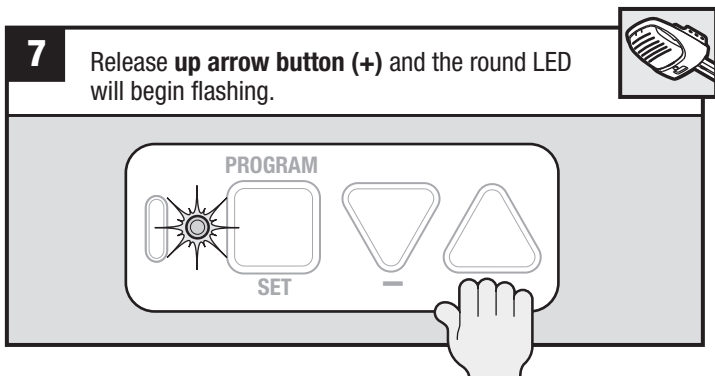
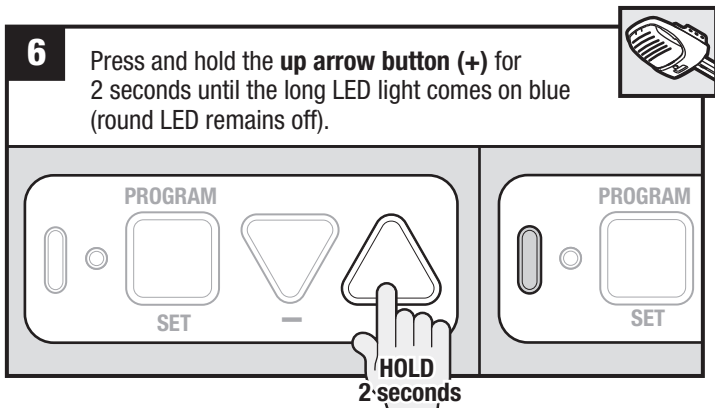

The UP (open) limit is programmed.

BOTH DOOR LIMITS ARE NOW PROGRAMMED.

3

Required Programming

WALL CONSOLE / Overview

This opener has a serial number sticker in which the serial numbers begin with 10 or higher.

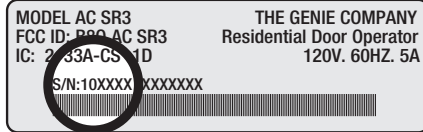

Wall consoles from other manufacturers may not work with openers of these serial number groups. Use only the wall console provided with this unit. Each wall console has three buttons.

In your carton you will find one of the following wall consoles:

Series II Wall Consoles with White Buttons

Indicator Light

Large white button will display Red when wall console is properly wired and Sure-Lock™ is OFF. When Sure-Lock™ is ON, this light is off

Open/Close Button

Use this button to open or close garage door. When Sure-Lock™ is ON, the Open/Close button will CLOSE the door only.

NOTE: Constant button pressure in the CLOSE mode will override STB fault in the powerhead and close door.

Independent Light Control Button

Use this button to turn powerhead lights ON. Powerhead lighting will remain ON until this button is pressed again or a door action has been completed.

NOTE: If opener has a Motion Detector sensor, it will keep powerhead lights ON as long as motion is detected.

Sure-Lock™ Button

When Sure-Lock™ is ON, the powerhead cannot be activated by the wall console or a remote.

- Press and release (or until red light goes off) to activate Sure-Lock™.
- Press and release to turn Sure-Lock™ OFF.

Open/Close Button

Opens and closes door from inside garage.

Indicator Light

- Red indicator backlight is ON.
- When Sure-Lock™ is ON, the indicator light is OFF

Sure-Lock™ Button

- LOCK disables controls after door is completely closed.
- UNLOCK allows controls to work normally.

Independent Light Control Button

Controls door opener lights from inside garage.

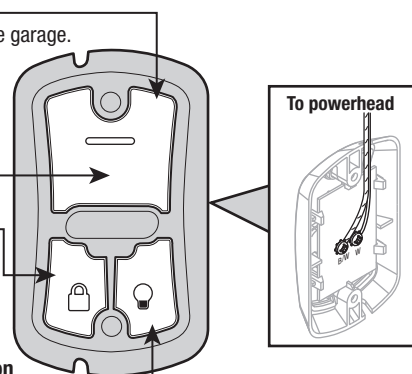

Series III Wall Consoles with Black Buttons

Indicator Light

Indicator light will display Red when wall console is properly wired and Sure-Lock™ is OFF. When Sure-Lock™ is ON, indicator light flashes.

Open/Close Button

Use this button to open or close garage door. When Sure-Lock™ is ON, the Open/Close button will CLOSE the door only.

NOTE: Constant button pressure in the CLOSE mode will override STB fault in the powerhead and close door.

Independent Light Control Button

Use this button to turn powerhead lights ON. Powerhead lighting will remain ON until this button is pressed again or a door action has been completed.

NOTE: If opener has a Motion Detector sensor, it will keep powerhead lights ON as long as motion is detected.

Sure-Lock™ Button

When Sure-Lock™ is ON, the powerhead cannot be activated by the wall console or a remote.

- Press and hold for 5 seconds (or until Indicator Light flashes) to activate Sure-Lock™.
- Press and release to turn Sure-Lock™ OFF.

Open/Close Button

Opens and closes door from inside garage.

Indicator Light

- Red indicator light is always ON.
- When Sure-Lock™ is ON, the indicator light flashes.

Sure-Lock™ Button

- LOCK disables controls after door is completely closed.
- UNLOCK allows controls to work normally.

Independent Light Control Button

Controls door opener lights from inside garage.

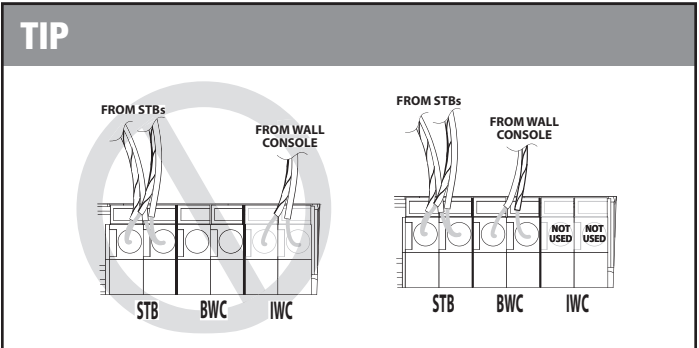
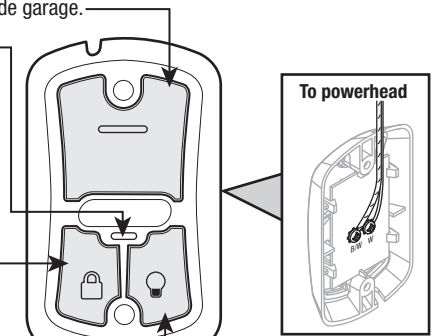

3

Required Programming

Force and Speed Control

These controls are factory programmed and automatically set themselves when you use the Wall Console to open and close the garage door for the first time. The door **MUST** complete a full cycle from open to close and close to open before it is fully set.

NOTE: Force or Speed controls **DO NOT** require programming. Force and Speed Limits are factory set and rarely require adjustments. Making adjustments to these settings is covered in Troubleshooting Section of this manual (pages 18-19).

- 10** Open and close your garage door using the Wall Console Open/Close button.

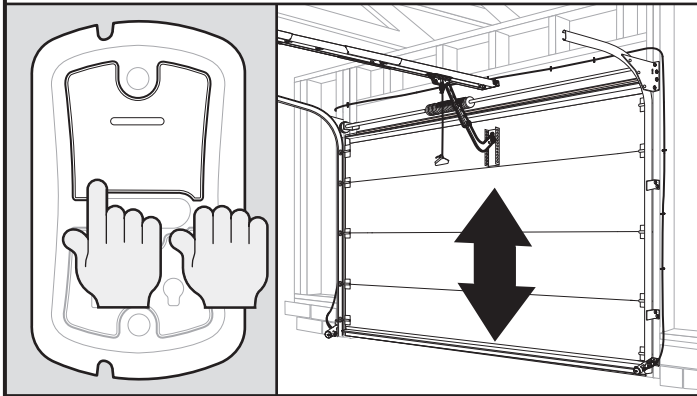

NOTE: Using these functions for the first time automatically sets the Force needed to open and close your garage door.

FORCE AND SPEED CONTROL ARE NOW SET.

Contact Reverse Test

NOTE: The Limit and Force settings **MUST BE COMPLETED** before performing the Contact Reverse Test.

- 11** Open the garage door using the Open/Close button on the Wall Console.

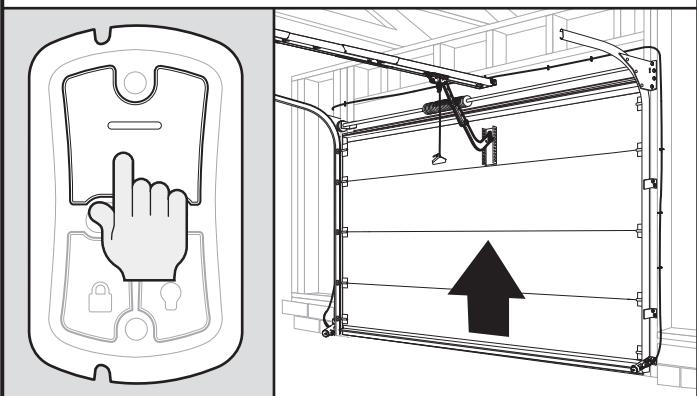

- 12** Lay a 2" x 4" board flat under the center of the door opening.

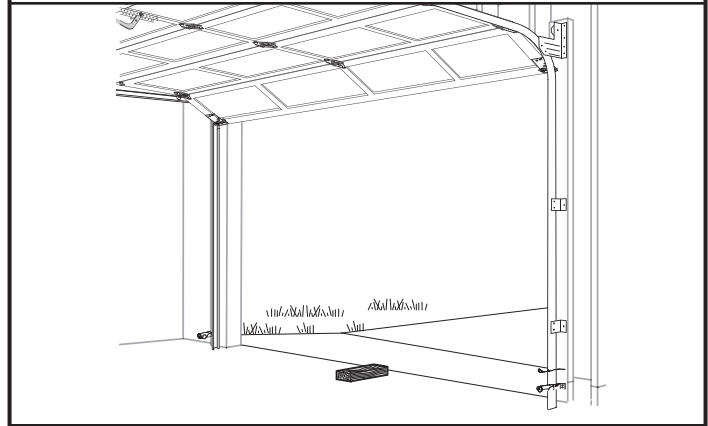

- 13** Close the garage door using the Open/Close button on the Wall Console.

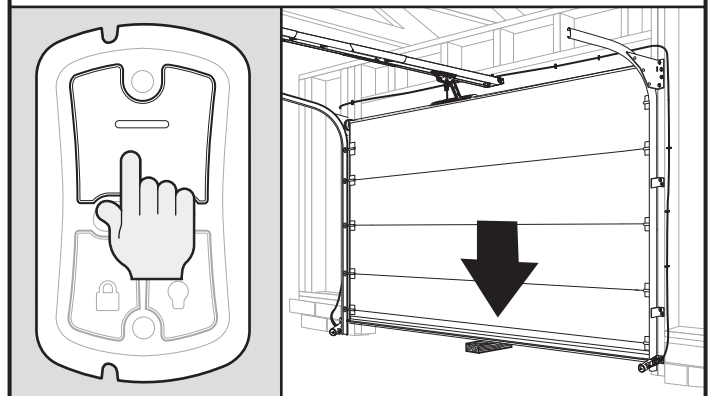

When the door contacts the board, it should stop and reverse direction within 2 seconds to the fully OPEN position. Red LED lights on the powerhead will begin to flash with the reversal of the door. The next cycle will clear the lights.

Contact Reverse Adjustment

If the door stops before contacting the board or if it does not reverse direction to fully open after contact with the board, it may be due to improperly set DOWN limits.

Repeat the Setting the Down Limit steps 1-5 to make certain the door is closing tight to the floor.

Repeat step 10 to set force limits.

Then repeat the WALL CONSOLE/Contact Reverse Test, steps 11-13.

Repeat this process as needed until door passes the Contact Reverse Test. For further help, refer to MAINTENANCE and ADJUSTMENTS, Regular Maintenance, pages 16-19.

3

Required Programming

REMOTES / New Intellicode 2 Openers

NOTE: The following instructions are for the remote control transmitters ("Remotes") provided with this opener. This Remote is preset for use with the Intellicode 2 Access Security System. Refer to page 14 for additional information on Intellicode 1 and 2 Remotes and how to switch from Intellicode 2 to Intellicode 1. See page 14 for programming instructions using Intellicode 1 Remotes.

NOTE: You have **30 seconds** to execute each step. If you see **two flashing red LEDs on the Powerhead**, you have run out of time and must go back to the beginning of the step and start over. You can restart as many times as necessary to complete each step.

NOTE: Each button on each Remote must be programmed **separately**, following these steps.

- 14** Press and hold the **Program Set button** (the round LED turns blue).

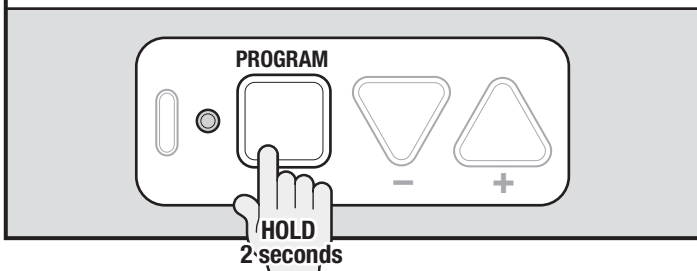

- 15** Release the **Program Set button** (the long LED begins flashing purple).

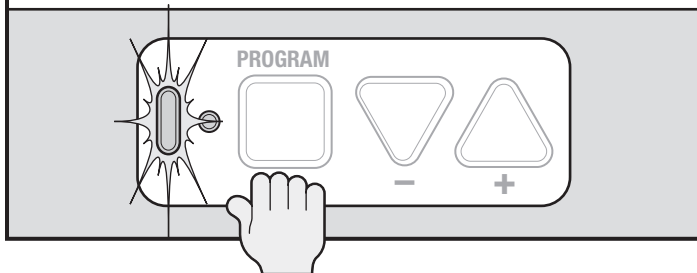

- 16** Remove protective film for battery from remote.

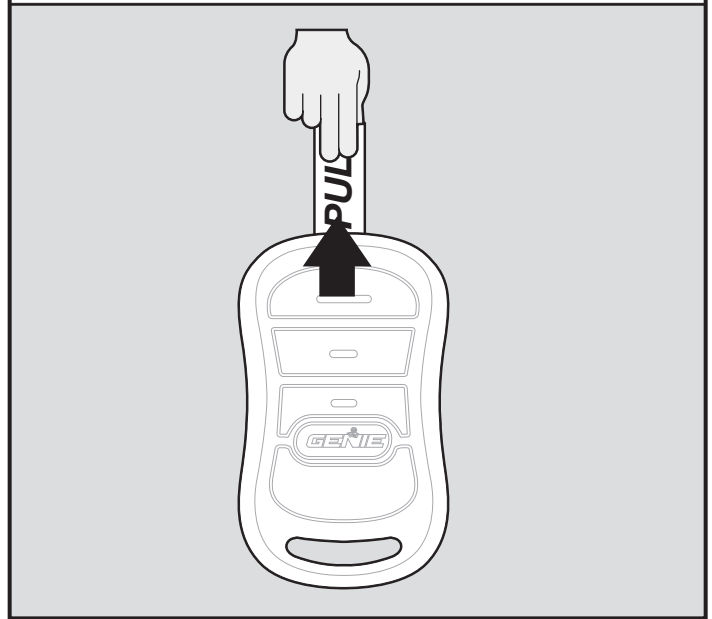

- 17** Press and release the button you have chosen on the Remote (long LED comes on purple).

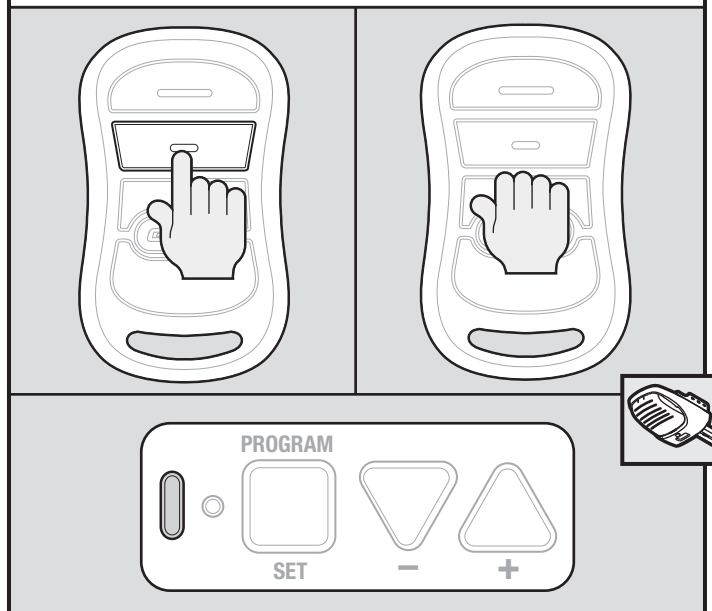

NOTE: Do NOT hold Remote too close to the Powerhead when programming Remote buttons.

(continued next page)

3

Required Programming

18 Press and release the same button on the remote (both LED's flash blue and then turn off).

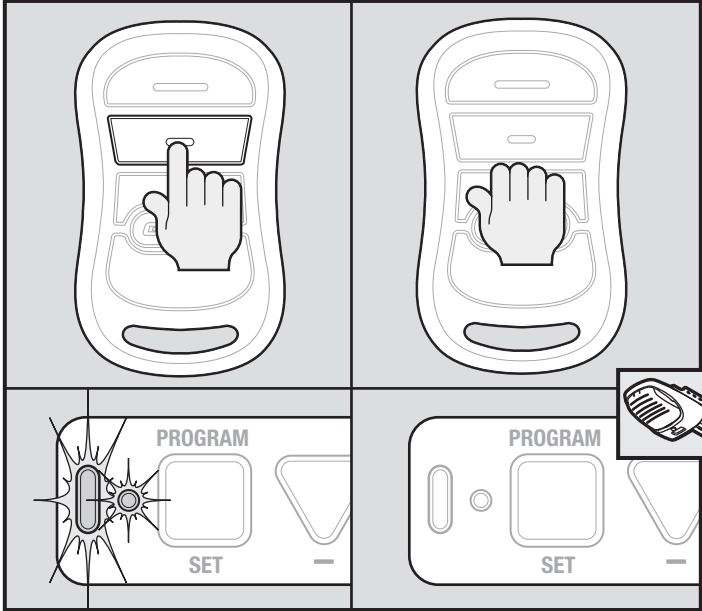

The Remote button is now programmed.

Repeat as necessary for additional Remotes.

To program the same Remote for other garage door openers, repeat the steps above using one of the other two Remote buttons.

Each Remote can be programmed for three door openers.

BASIC PROGRAMMING IS COMPLETE AND YOUR GARAGE DOOR IS READY TO USE!

***NOTE:** For Car2U and HomeLink, park the car outside the garage with the ignition key in the "Accessory" position. Follow the Car2U or HomeLink instruction to set the button in the car to Genie mode.*

IMPORTANT: Your HomeLink® device will ONLY respond to pressing THIS button on your Intellicode remote when it's searching to connect to your remote in "Learn Mode" as described in the HomeLink® instruction manual.

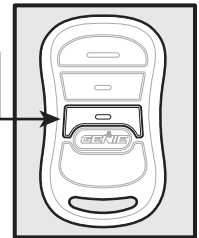

19 Press and release **the same button** on the remote (the door should open or close).

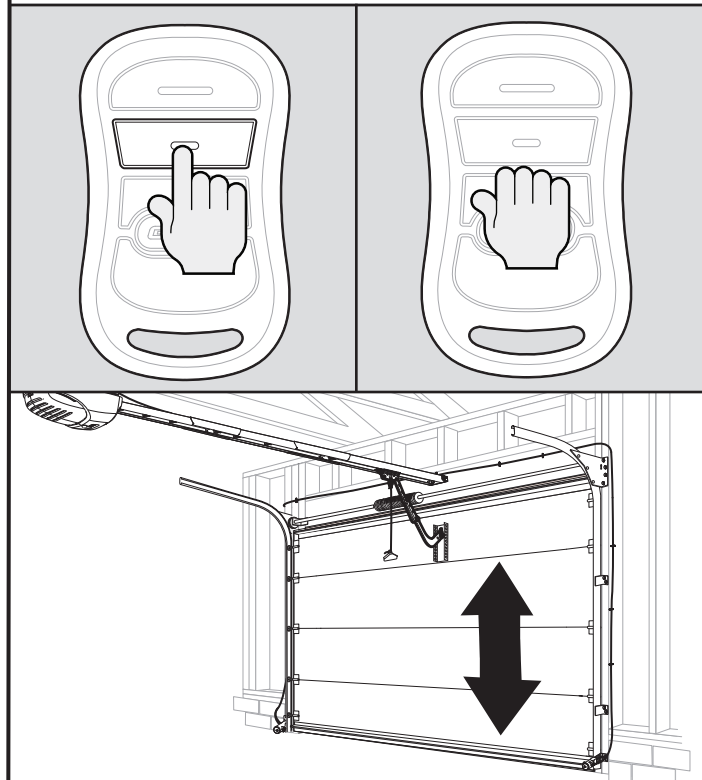

4 Optional Programming

PROGRAMMING THE WIRELESS KEYPAD

Setting Up a PIN

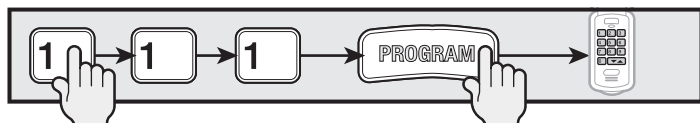
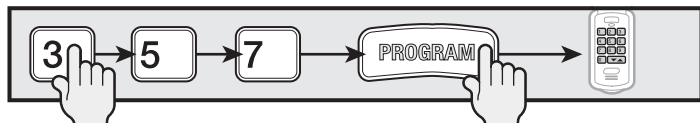

1. Press in order 3–5–7.
 2. Press the **Program key**.
 3. Enter your new PIN (3-8 characters).
 4. Press **Program key**.
- Your keypad is ready for programming.

Programming



Locate Your Opener's Programming Buttons and LED

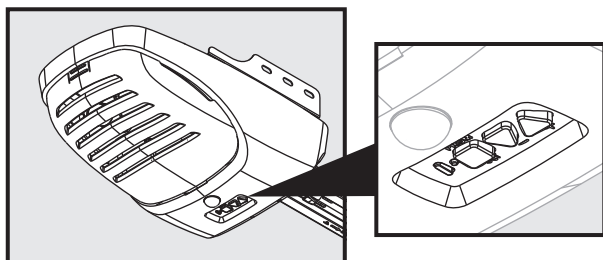

Synchronizing Keypad to Opener

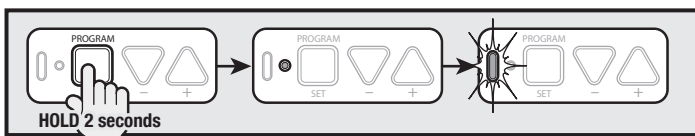

1. Press and hold **Program Set key** for 2 seconds. (The round LED turns blue and then goes off. The long LED will begin flashing purple)

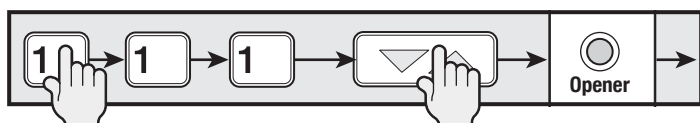

2. Enter your PIN.
3. Press **Up/Down key**. Opener LEDs will stay on steady.

Note: For multiple doors, see the full instructions packed with the keypad.

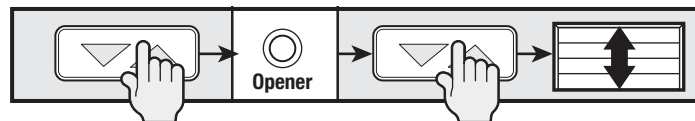

4. Press **Up/Down key** again. Opener LEDs will turn off.
5. Press **Up/Down key** again. Door opener will run.

NOTE: Pressing any key will stop or start the opener while the door is in motion. The door will automatically stop fully open or closed. When the door has stopped moving, pressing on any single button will activate door until backlight goes off (30 seconds)

NOTE: Rapid blinking of the red LED on the Powerhead indicates an error. When the blinking stops, you must start programming steps over.

Resetting PIN



If you have forgotten your PIN or you fear it may have fallen into unauthorized hands, you must erase the old programming.

To erase, follow these simple steps:

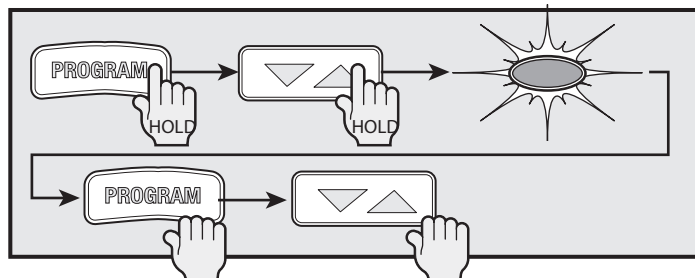

1. Press and hold **Program key** and then the **Up/Down key** for 5 seconds or until the LED starts to slowly blink. When blinking stops you have successfully erased the old programming.
2. Go back and follow the steps in "Setting Up a Pin" and "Programming"

Changing Your PIN

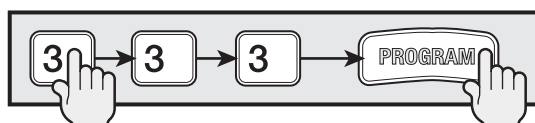
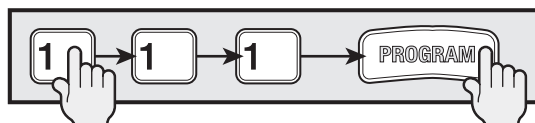

1. Enter your current PIN, then press **Program key**.
2. Enter your new PIN, press **Program key**.

Note: If you are still having trouble with the keypad, refer to the full instructions packed with the keypad.

4

Optional Programming

CLEARING MEMORY FOR REMOTES

- 1** Press the **Program Set button** on the Powerhead and hold 2 seconds, round LED comes ON.

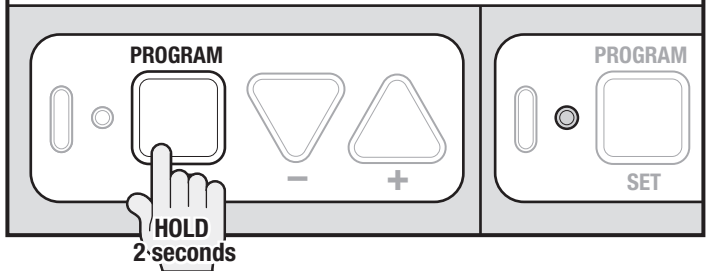

- 2** Release the **Program Set button**, round LED goes off and the long LED flashes purple.

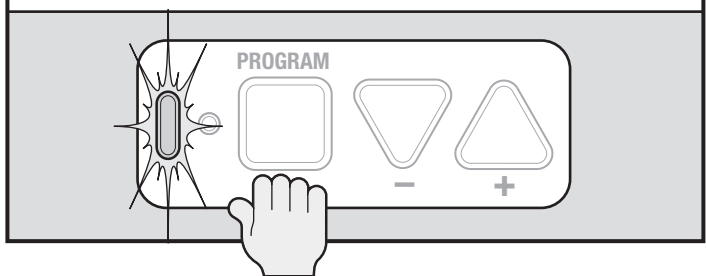

- 3** Press **up arrow button (+)** and **down arrow button (-)** simultaneously on the Powerhead and hold until both LEDs flash blue and then go OFF.

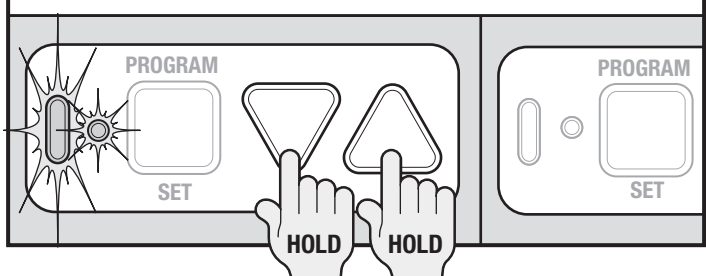

- 4** To verify that the memory is cleared, press a remote button that was previously programmed to the Powerhead.

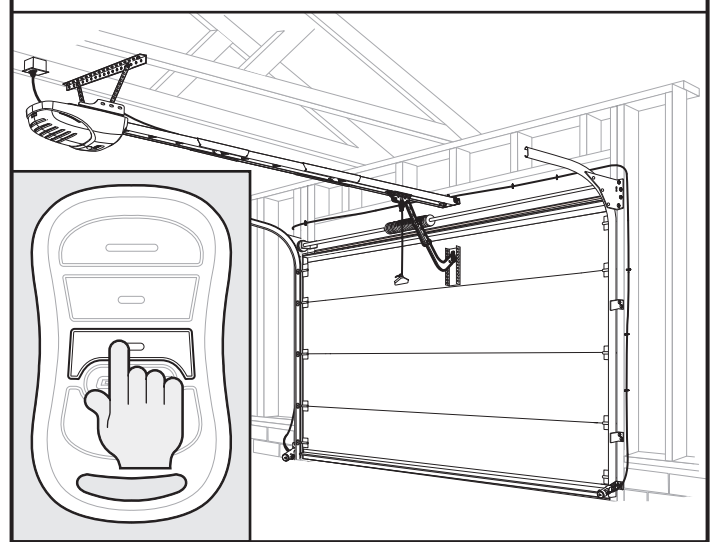

If the memory has been cleared, the Remote will not activate the door opener.

NOTE: The garage door opener will operate normally using the Wall Console.

NOTE: When the remote is pressed the round LED will flash blue but will not activate the door opener.

NOTE: Clearing Remotes from the Powerhead memory will clear ALL programmed Remotes and wireless Keypads. Your opener will no longer recognize any signal received from a missing Remote.

All remaining (or recovered) Remotes and wireless Keypads MUST BE reprogrammed as shown on pages 9 and 12.

(continued next page)

4 Optional Programming

INTELLICODE® 1 REMOTES



Remotes provided with this unit can operate other (Intellicode® 1) models of Genie® garage door openers. The default Intellicode® 2 setting must be changed to Intellicode® 1. (Follow these same steps to change Intellicode® 1 back to Intellicode® 2.)

NOTE: The button directly above the logo on the transmitter is preset to Intellicode® 1.

The LED color displayed on the Remote indicates the Intellicode® mode:

Red = Intellicode® 1 Green = Intellicode® 2

1 Select a Remote button NOT already programmed to the Powerhead. Press and hold the button for 10 seconds (both the RED and GREEN LEDs on the Remote turn ON).

2 Press and release the Remote button 3 times.

***Repeat Step 2 to turn the RED LED on the Remote back to GREEN for operation with Intellicode® 2 openers.

Once the LED on the Remote turns RED when the button is pressed, that button is programmed to the Intellicode® 1.

3 Find the Learn Code Button and Learn Code Indicator LED on your older Genie® door opener.

If your door opener has a black antenna wire and the serial number does not start with 10 or higher, the Learn Code Button and Indicator LED are located near the antenna. The light lens may need to be opened. If you use an external receiver, it may need to be opened to access the Learn Code Button and Indicator LED.

4 Press the Learn Code Button (the LED on the Opener flashes RED).

5 Press the Remote button 2 times (the LED on the Opener turns OFF).

6 Press the Remote button again. If the door moves, the Remote button is programmed to your opener.

If you have questions, see your Genie® instructions for this Intellicode® 1 model of opener.

NOTE: Choose the Genie® Remote using Intellicode® 1 button for this activity. All new Remotes have the button directly above the logo preset to Intellicode® 1.

This button is set to Intellicode® 1.

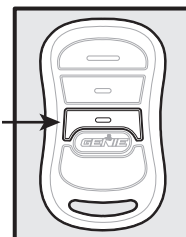

5 One-Piece Doors

ATTACHING DOOR BRACKET TO DOOR

- 1** Using bracket, mark holes on door or frame and drill $5/32$ " hole completely through door frame.

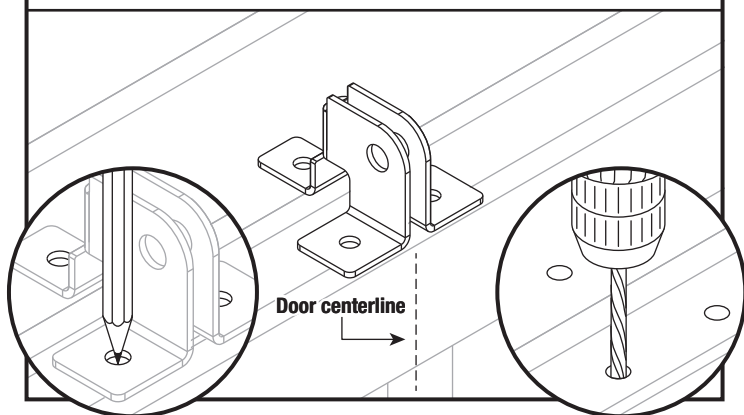

NOTE: Center bracket on door as high as possible, preferably top edge.

- 2** Secure bracket with $5/16$ " x 2" or $5/16$ " x 4-1/2" carriage bolts and nuts or drill $1/8$ " pilot holes and secure with 1-1/2" to 2" lag bolts. (Bolts, nuts, and screws not furnished.)

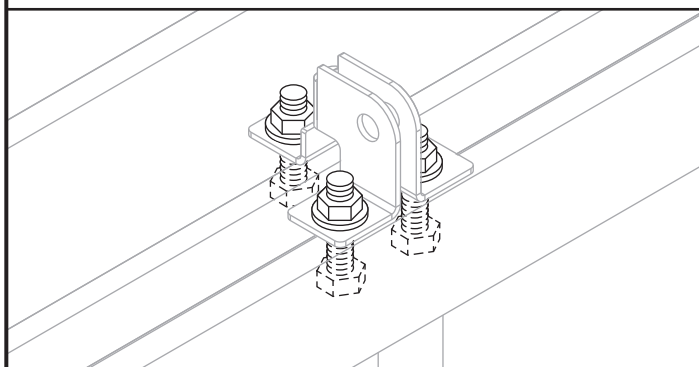

ATTACHING DOOR ARM TO DOOR BRACKET

- 1a** Screw drive models:
One-Piece Doors will only accept a straight door arm.

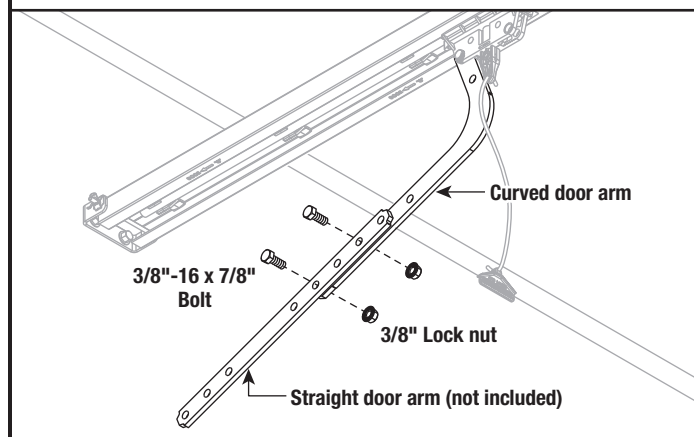

- 1b** Chain/belt drive models:
One-Piece Doors will only accept a straight door arm.

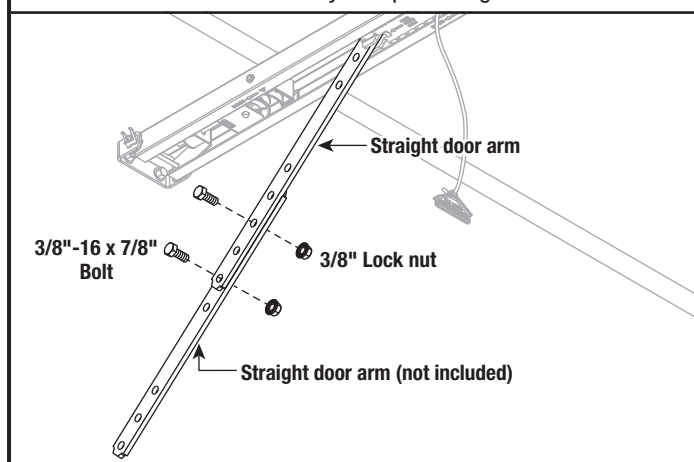

- 2** Secure door arm to the door bracket and with clevis pin and cotter pin.

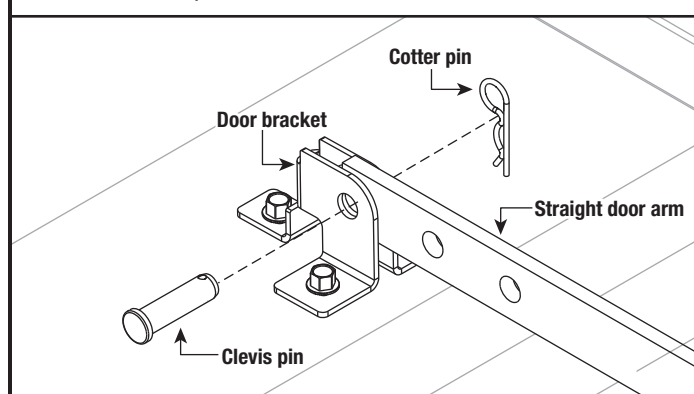

6

Maintenance and Adjustments

If you have any questions, please do not hesitate to contact customer service at: **1-800-35-GENIE** or visit www.geniecompany.com

IMPORTANT SAFETY INSTRUCTIONS

⚠ WARNING

TO REDUCE THE RISK OF SEVERE INJURY OR DEATH, READ AND FOLLOW ALL INSTRUCTIONS.

1. **NEVER** let children operate or play with the door controls.
2. Keep remote away from children.
3. **ALWAYS** keep the moving door in sight and away from people and objects until door is completely closed. **NO ONE SHOULD CROSS THE PATH OF THE MOVING DOOR.**
4. **NEVER GO UNDER A STOPPED, PARTIALLY OPEN DOOR.**
5. Test opener monthly. The door **MUST** reverse on contact with a 1-1/2" high object (or a 2" x 4" board laid flat) at the center of doorway on the floor. After adjusting either the force or limit of travel, retest door opener. Failure to adjust the opener properly may cause severe injury or death.
6. When possible, use emergency release only when door is closed. Use caution when using this release with the door open. Weak or broken springs are capable of increasing the rate of door closure and increasing the risk of severe injury or death.
7. **KEEP DOORS PROPERLY BALANCED.** See your garage door Owner's Manual. An improperly balanced door increases the risk of severe injury or death. Have a trained door system technician make repairs to cables, spring assemblies, and other hardware.

SAVE THESE INSTRUCTIONS

⚠ WARNING

- Garage door hardware (springs, cables, brackets, pulleys, etc.) are under extreme pressure and tension.
- **DO NOT** attempt to repair or adjust door springs or any hardware, and **DO NOT OPERATE** garage door automatically or manually if door is improperly balance or springs are broken.
- **CONTACT A TRAINED DOOR SYSTEM TECHNICIAN.**

REGULAR MAINTENANCE

Basic monthly maintenance tasks include:

- Contact Reverse
- Safe-T-Beam® System Check
- Door balance
- Lubricate door hardware

A. Contact Reverse Test

See page 9.

⚠ WARNING

Use of any other wall control can cause unexpected operation of the door and loss of lighting feature. Locate wall console within sight of door and far enough from door to prevent contacting it while operating the console. Control must be at least 5 feet above floor to prevent small children from operating it.

B. Safe-T-Beam® (STB) System Check

Check that both the RED and GREEN LEDs are ON steady. This indicates the system is working properly. If both LEDs are not ON steady, check the appropriate items below:

- STB red LED flashes.
 - Check for obstruction.
 - Check alignment.
 - Verify wire routing from STBs to STB connection in powerhead
 - Check for signal interference from another Safe-T-Beam® unit (for multiple door installations).
- No STB red or green LED displayed.
 - Check wiring and wire connections.

If the system appears to be working properly, perform the check as follows:

1. Start the door closing.
2. Pass an object through the beam. The door should stop and reverse to the fully open position.

C. Door Balance (Spring Tension)

Perform the check as follows:

- With the door closed, pull manual emergency release handle **DOWN** and let go to release door carriage assembly from drive system.
- Raise and lower the door manually—it should move freely and smoothly.
- Raise door manually about 3' to 4' feet and let go.

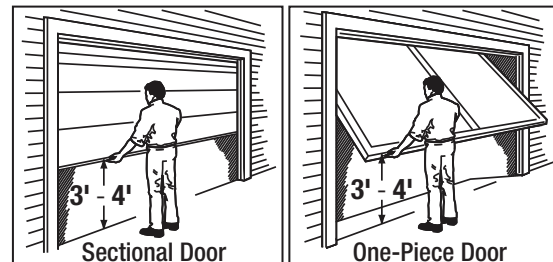

- Door should remain stationary or move very slowly.
 - If door moves quickly, **CONTACT A TRAINED DOOR SYSTEM TECHNICIAN** to have your door springs serviced.
- Close the door.

(continued next page)

6

Maintenance and Adjustments

REGULAR MAINTENANCE (continued)

- Screw drive models: Verify shuttle release lever is in ENGAGED (UP) position (pull release handle toward opener and let go)
- Chain/belt drive models: Verify bullet is engaged to carriage. Pull/release cord down and back towards opener and let go.

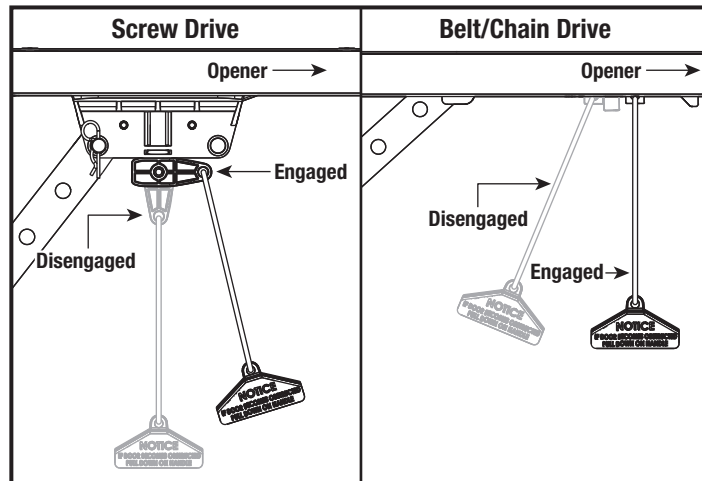

- Operate door using a remote or wall console.
- Door will re-attach itself to carriage assembly.

CORRECTIVE MAINTENANCE

Changing Light Bulbs



⚠ WARNING

- Use extreme caution when working from a ladder or step stool.
- When replacing light cover, make sure wires are not pinched or near moving parts.

1. Disconnect power to door opener.
 - Open powerhead light cover.
 - Remove light bulb(s).
 - Replace light bulb(s).
 - **DO NOT** use light bulbs with greater than 100 Watt rating, PowerLift® 900, GPower™ 900 require light bulbs of no more than 60 watts. Compact CFL's may also be used.
 - Close powerhead light cover.
2. Reconnect power to door opener.
 - Test light operation.

Reset Open/Close Travel Limit

Performing all eleven (11) Limits/Force setting steps (see pages 6-8) erases previous Limits/Force settings.

NOTE: The opener will not close the door automatically unless the Safe-T-Beam® System is installed and Limits are programmed.

Disengaging and Engaging Carriage/Bullet

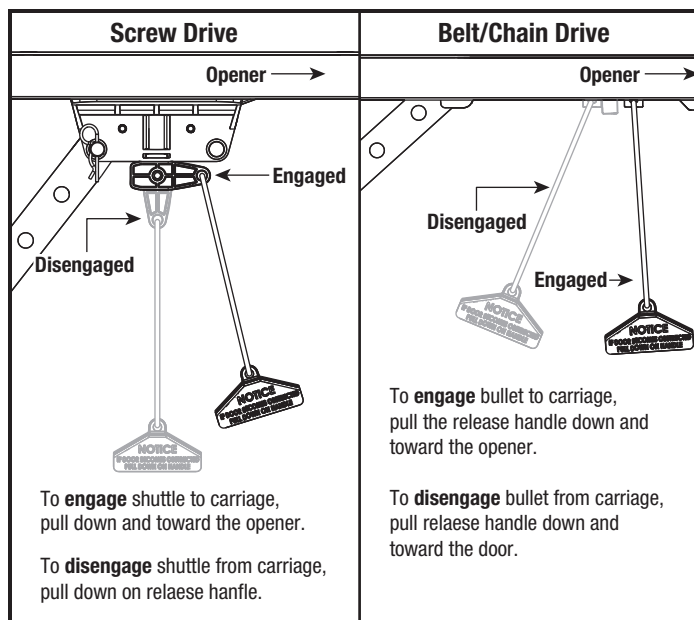

Remote Battery Replacement

Replace remote battery with a CR 2032 coin cell battery.

1. Open remote case using a washer or coin that fits into the slot at top of remote.
2. Replace battery.
3. Align components and snap case closed.

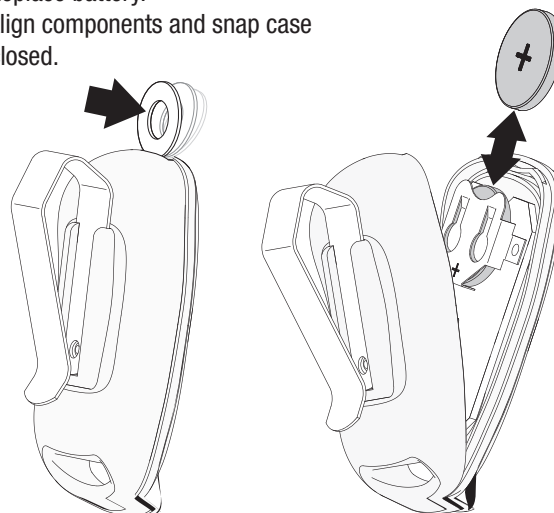

(continued next page)

6

Maintenance and Adjustments

ADJUSTMENT GUIDES

CAUTION

Door closing force is **FACTORY** set and requires no adjustment for *normal* operation.

- **NEVER** adjust the force settings to compensate for damage, including an unbalanced door, binding door track, or broken spring.
- Perform monthly a **CONTACT REVERSE TEST**. See page 8.









Force Settings

Force settings are pre programmed at the factory and “learned” during the Open/Close Limit settings steps (see pages 6-7). For normal use, these settings should not need adjustment with this unit.

However, conditions possibly requiring adjustment are:

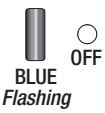
1. Doors with very stiff weather seals.
2. Doors that start down, STOP, and reverse before closing.
3. Doors that start up, but STOP before they completely open.

Force Adjustment

Action	LED Indication/Result
1 Press and hold both up and down buttons  2 seconds or until round LED turns RED.	 The Current UP FORCE SETTING will display. SEE CHART IN NEXT COLUMN.
2 Press either until you reach desired setting. 	USE CHART IN NEXT COLUMN
3 Press and release. 	LOCKS IN SETTING. Then the New DOWN FORCE SETTING will display. 
4 Press either until you reach the desired setting. 	USE CHART IN NEXT COLUMN 
5 Press and release. 	LOCKS IN SETTING. Both LEDs turn BLUE then OFF confirms both FORCE Settings are reset. 
FORCE SETTINGS DONE	

LED indicator colors: ○ OFF ● Blue ● Purple ● Red

Force Level	Powerhead LEDs	
	LONG LED	ROUND LED
Force Level 1	Off	● BLUE
Force Level 2	● BLUE	○ Off
Force Level 3	● BLUE	● BLUE
Force Level 4	Off	● PURPLE
Force Level 5	● PURPLE	○ Off
Force Level 6	● PURPLE	● PURPLE
Force Level 7	Off	● RED
Force Level 7	● RED	○ Off
Force Level 9	● RED	● RED

6

Maintenance and Adjustments

ADJUSTMENT GUIDES (continued)

Speed Settings (DC motors only)















Speed settings are pre-programmed at the factory for the maximum speed. Speed settings should not need adjustment with this unit.

However, travel speed for the opener can be adjusted to a slower speed in both the Open and Close directions, to minimize wear on heavier sectional doors.



NOTE: One-piece doors are automatically set to the slowest speed during Limits programming and cannot be adjusted.

There are 3-speed settings available for sectional doors. Please note that speed may be affected by door weight and balance, along with condition of door components and tracks.

Speed Adjustment

Action	LED Indication/Result
1 Press and hold for about 10 seconds or until both LEDs turn BLUE. Then release. 	 BLUE BLUE
2 Press twice. 	 BLUE BLUE
3 Press and release. 	 OFF Flashes BLUE 3 Times Then the Current Speed setting for OPENING travel will display. SEE CHART IN NEXT COLUMN.
4 Press either until you reach the desired setting.  	NOTE: Depending on the criteria mentioned above, you may not have the option to increase speed.
5 Press and release. 	LOCKS IN OPENING SETTING.  Flashes BLUE 3 Times OFF Then the Current Speed setting for CLOSING travel will display. SEE CHART IN NEXT COLUMN.
6 Press either until you reach the desired setting.  	NOTE: Depending on the criteria mentioned above, you may not have the option to increase speed.
7 Press and release. Both LEDs FLASH BLUE to confirm setting. 	LOCKS IN CLOSING SETTING.  FLASH BLUE FLASH BLUE
SPEED SETTINGS DONE	

LED indicator colors: ○ OFF ● Blue ● Purple ● Red

Speed Level	Powerhead LEDs		
	LONG LED		ROUND LED
High	RED		RED
Medium	PURPLE		PURPLE
Low	BLUE		BLUE

NOTE: PowerLift® 900, GPower™ 900 openers **DO NOT** have speed adjustments.

LOCATING SAFE-T-BEAM PAIRS: Source (Red LED) and Sensor (Green LED)

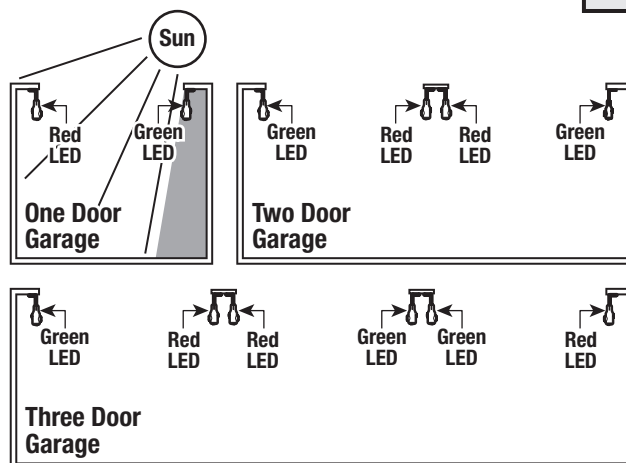
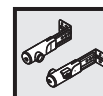

Single Garage Door

- Determine which side of the garage receives direct sunlight.
- Position the Source (Red LED) on the direct sunlight side

Multiple Garage Doors

- NEVER position Safe-T-Beam modules where signals will cross.
- Place the Source (Red LED) Safe-T-Beams on adjacent doors facing in opposite directions.

NOTE: Direct sunlight creates interference with Safe-T-Beam Sensor (Green LED). Sensor modules CAN be positioned further away from door opening if necessary to avoid sunlight but no further off the wall to maintain alignment with paired Source module.

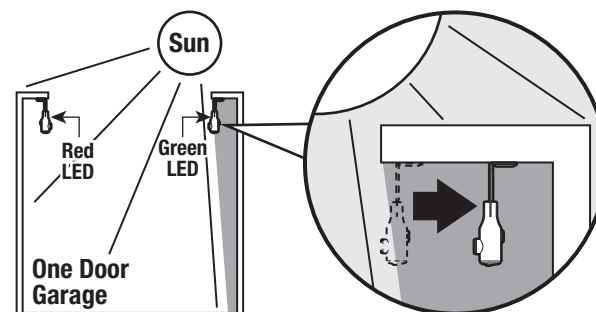

7

Wiring Diagram

Opener circuit wiring diagram. This wiring diagram is for reference only.

WARNING

OPENING COVER MAY CAUSE ELECTRIC SHOCK.

Disconnect power from opener prior to removing cover.

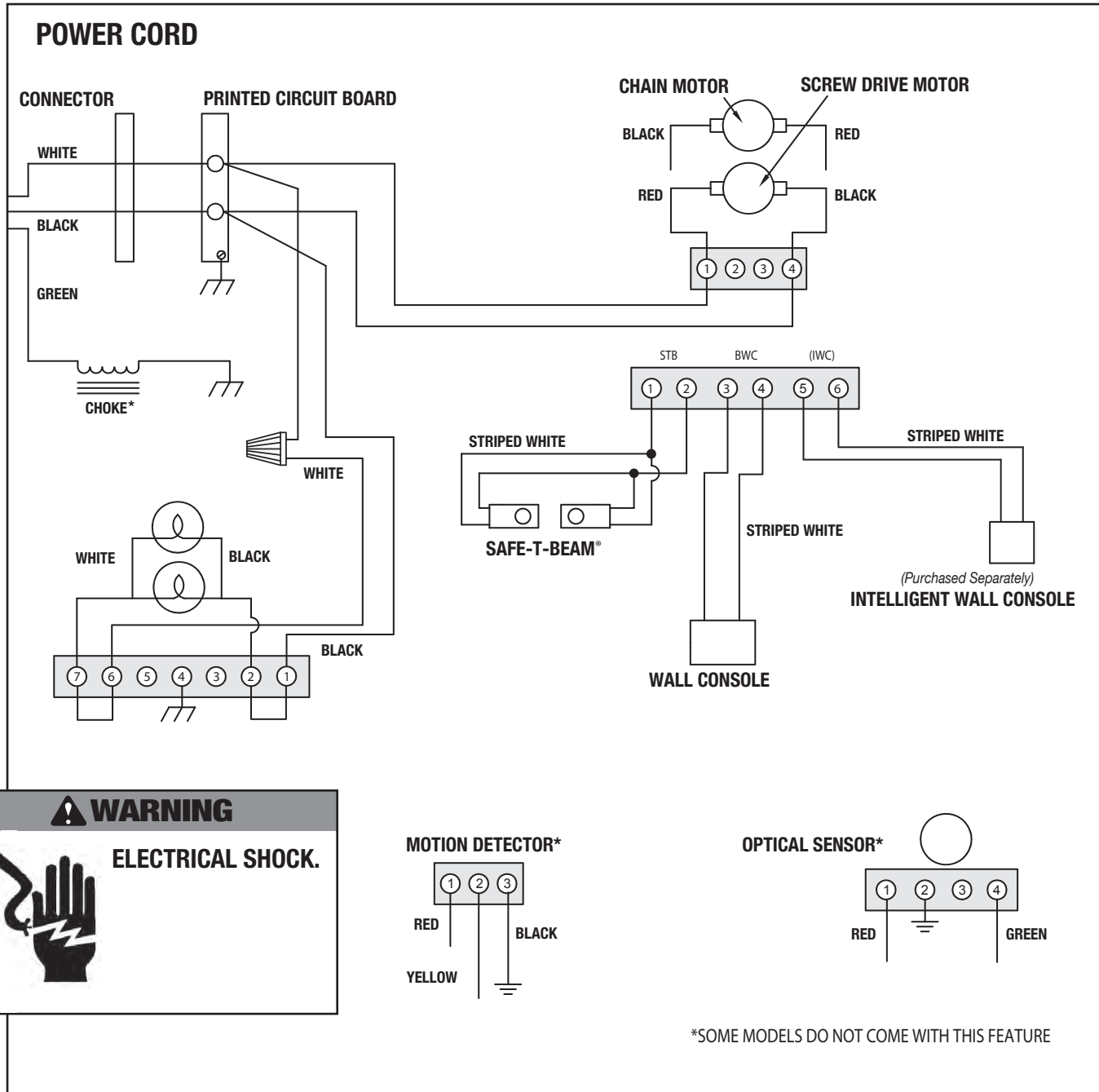

8

Troubleshooting

OPERATION



Need help or have questions? **DO NOT RETURN** to the store. Call us: **800-354-3643**

PROBLEM	WHAT TO DO
Opener does NOT run from wall console.	<ul style="list-style-type: none"> • Check power source. <ul style="list-style-type: none"> – Plug a lamp into outlet used for powerhead. If lamp works, power source is OK. – If not, check fuse or circuit breaker. • If power is OK, <ul style="list-style-type: none"> – Check connections at powerhead terminals and at wall console. – Limits must be set with door arm connected to door. • Check if wall console Sure-Lock™ is ON. Turn Sure-Lock™ OFF and check operation. • Check for reversed, broken or cut wires. Staples can cut insulation and short wires. Repair or replace.
Opener runs, but door does not move. Opener works from wall console, but NOT from remote.	<ul style="list-style-type: none"> • Make certain carriage is engaged into chain/belt bullet or screw drive shuttle. See page 6. Refer to Installation poster or download poster from www.geniecompany.com • Check to make sure chain/belt is not broken or OFF its pulley. • Check all remotes. • Replace remote battery with good one. <i>See page 17.</i> • Program remote to powerhead. <i>See pages 10-11.</i>
Remote has less than 25 feet operating range or no operation.	<ul style="list-style-type: none"> • Relocate remote inside car and/or point remote at garage door. • Replace battery. <i>See page 17.</i> • Reposition door opener antenna. • Remote LED does not come ON with button push – replace battery. <i>See page 17.</i> • Eliminate possible competing signals (satellite radio, FiOS® TV).
Door starts down, then STOPS and goes back up. OR Safe-T-Beam® System malfunction.	<ul style="list-style-type: none"> • If a NEW installation, check Door Arm position. Refer to Installation poster or download poster from www.geniecompany.com • Check if limits are properly set. <i>See pages 6-7.</i> • Check if Safe-T-Beam® Red LED is flashing. • Check Safe-T-Beam® system for beam obstruction or misalignment of lenses. • Check garage door for binding. • If an operational problem exists, and opener will not close, the opener can be forced to close as follows: Press and hold the wall console button until door is completely closed. • Check for interference from adjacent Safe-T-Beam® units. • Contact The Genie Company at 1-800-35GENIE.
Door starts down, then STOPS before it is closed. OR Door will only open.	<ul style="list-style-type: none"> • Check Safe-T-Beam® wire connections at powerhead and at STBs. <i>See page 8, STB instruction, poster or website.</i> • Check if limits are properly set. <i>See pages 6-7.</i> • Check CONTACT REVERSE. <i>See pages 8-9.</i> • Check garage door for binding. • Check closing “FORCE” adjustment. <i>See page 8.</i>
Door starts up, but STOPS before it is completely open.	<ul style="list-style-type: none"> • Check if limits are properly set. <i>See pages 6-7.</i> • Be sure door, opener, and springs are in good repair, properly lubricated and balanced. • Check closing “FORCE” adjustment. <i>See page 8.</i> • ▲ WARNING: If you suspect a problem with the garage door hardware or springs, contact The Genie Company at 1-800-35GENIE.
Door will only run closed.	<ul style="list-style-type: none"> • Check if limits are properly set. <i>See pages 6-7.</i> • Check Sure-Lock™. Sure-Lock™ should be OFF for normal operation. <i>See page 8.</i> • Check door balance, condition, and door spring. • Check opening “FORCE” adjustment. <i>See page 8.</i> • ▲ WARNING: If you suspect a problem with the garage door hardware or springs, contact The Genie Company at 1-800-35GENIE.
Door opener starts for no reason.	<ul style="list-style-type: none"> • Button stuck on wall console or remote. • Was a remote lost or stolen? Erase all remotes from powerhead memory and program new remotes. <i>See page 13.</i>

8

Troubleshooting

OPERATION (continued)

PROBLEM	WHAT TO DO
Noisy operation.	<ul style="list-style-type: none"> • Be sure all door fasteners are tight. • Be sure garage door is in good repair, properly lubricated and balanced. • Be sure opener is in good repair.
Door opener runs slow.	<ul style="list-style-type: none"> • Check operating condition of door. Door may need professional repair/adjustment. • Is this opener installed on a one-piece door? Normal speed for one-piece door is lowest speed setting. • If carriage travel is less than 6-feet, opener configures programming for a one-piece door. • Contact The Genie Company at 1-800-35GENIE concerning door speed.

POWERHEAD LEDS

Powerhead LED		Possible Problem	Solution
Round LED	Long LED		
OFF	OFF	Normal operation.	None required.
		No response from unit.	Check power supply. Contact a trained door system technician.
ON/RED/ STEADY	ON/RED/ STEADY	Limits NOT set properly.	Re-program limits, <i>see pages 6-7</i> .
ON/RED/ FLASHING	ON/RED/ FLASHING	Program error.	Unplug unit, wait 5 seconds, plug in.
		Component failure.	Contact a trained door system technician.
ON/BLUE/ FLASHING	OFF	Remote NOT programmed.	Program remote, <i>see pages 10-11</i> .
ON/PURPLE/ FLASHING	OFF	Intellicode® 1 remote NOT programmed.	Program remote using Intellicode® 2 remote, <i>see page 10</i> . Then program Intellicode® 1 remote using instructions on <i>page 14</i> .
ON/RED/ FLASHING	OFF	Safe-T-Beam® physical obstruction.	Remove obstruction, recheck unit.
		Safe-T-Beam® signal interference.	Check alignment of Safe-T-Beam® pair and nearest other Safe-T-Beam® pair, <i>see page 19</i> .
OFF	ON/RED/ FLASHING	Door contact in UP or DOWN travel.	Remove obstruction.
		Door component failure detected.	Check door spring, track, rollers, hinges and fixtures.
OFF	ON/RED/ STEADY	Thermal cutout	DO NOT unplug unit. Wait until LED clears before operating.



**PowerMax® 1200/1500, SC 1200/1500, TriloG™ 1200/1500, PowerLift® 900,
GPower™ 900, SilentMax® 1000/1200, CB 1000/1200, IntelliG® 1000/1200**

LIMITED WARRANTY

GMI Holdings, Inc d/b/a The Genie Company ("Seller") warrants to the original purchaser of the below identified, SilentMax® 1000/1200, CB 1000/1200, IntelliG® 1000/1200, PowerMax® 1200/1500, SC 1200/1500, TriloG™ 1200/1500, PowerLift® 900, or GPower™ 900 garage door openers, ("Product"), subject to all of the terms and conditions hereof, that the Product and all components thereof will be free from defects in materials and workmanship for the following period(s) of time, measured from the date of purchase:

SilentMax® 1000/1200, CB 1000/1200, IntelliG® 1000/1200,
MOTOR/GEARBOX- Seller warrants the motor/gearbox for the LIFETIME* of the product
BELT- Seller warrants the belt for a period of FIFTEEN (15) YEARS
CHAIN- Seller warrants the chain for a period of FIVE (5) YEARS

PowerMax® 1200/1500, SC 1200/1500, TriloG™ 1200/1500
MOTOR – Seller warrants the motor for the LIFETIME* of the Product
DRIVE SCREW – Seller warrants the drive screw for the LIFETIME* of the Product

PowerLift®, 900 , GPower™ 900
MOTOR – Seller warrants the motor for a period of FIFTEEN (15) YEARS
DRIVE SCREW – Seller warrants the drive screw for a period of FIVE (5) YEARS

CORE UNIT PARTS** - Seller warrants all other parts and components of the Core Unit for a period of FIVE (5) YEARS
ACCESSORIES - Seller warrants all accessories included with product for a period of ONE (1) YEAR

*Lifetime shall mean for as long as the original purchaser owns the home in which the product is originally installed

** The Core Unit consists of the powerhead, wired wall control, Safe-T-Beam® system, J-Arm and rail

Seller's obligation under this warranty is specifically limited to repairing or replacing, at its option, the Product or any part thereof which is determined by Seller to be defective during the applicable warranty period. Any labor charges are excluded and will be the responsibility of the purchaser.

This warranty gives you specific legal rights, and you may also have other rights which vary from state to state. This warranty is made to the original purchaser of the Product only, and is not transferable or assignable. This warranty applies only to Product installed in a residential or other non-commercial application. It does not cover any Product installed in commercial or industrial building applications. This warranty does not apply to any unauthorized or improper installation, alteration or repair of the Product, or to any Product or component which has been damaged or deteriorated due to misuse, abuse, neglect, accident, failure to provide necessary maintenance, normal wear and tear, or acts of God or any other cause beyond the reasonable control of Seller, and does not cover batteries, missing or damaged parts from clearance or open box sales, or repairs or maintenance to door components.

ALL EXPRESS AND IMPLIED WARRANTIES FOR THE PRODUCT, INCLUDING BUT NOT LIMITED TO ANY IMPLIED WARRANTIES OF MERCHANTABILITY AND FITNESS FOR A PARTICULAR PURPOSE, ARE LIMITED IN TIME TO THE APPLICABLE WARRANTY PERIOD REFLECTED ABOVE. NO WARRANTIES, WHETHER EXPRESS OR IMPLIED, WILL APPLY.

AFTER THE LIMITED WARRANTY PERIOD HAS EXPIRED. Some states do not allow limitations on how long an implied warranty lasts, so the above limitation may not apply to you.

IN NO EVENT SHALL GMI HOLDINGS, INC OR ITS PARENT OR AFFILIATES BE RESPONSIBLE FOR, OR LIABLE TO ANYONE FOR, SPECIAL, INDIRECT, COLLATERAL, PUNITIVE, INCIDENTAL OR CONSEQUENTIAL DAMAGES, even if Seller has been advised of the possibility of such damages. Such excluded damages include, but are not limited to, loss of use, cost of any substitute product, or other similar indirect financial loss. Some states do not allow the exclusion or limitation of incidental or consequential damages, so the above limitation or exclusion may not apply to you.

Claims under this warranty must be made promptly after discovery and within the applicable warranty period. To obtain warranty service, you must contact Genie® customer service and provide proof of the date and location of purchase and identification as the original purchaser. Call Genie® Customer Service toll free at 1-800-354-3643 to speak with a trained representative. Purchaser must allow Seller a reasonable opportunity to inspect Product claimed to be defective prior to removal or alteration of its condition. Upon determination by Seller that the Product or any part thereof is defective during the applicable warranty period (which may require purchaser to return the Product to Seller at purchaser's expense), Seller will supply the purchaser with replacement parts or, at its option, a replacement Product (shipping and handling of any replacement part(s) or replacement Product also at purchaser's expense). Seller may use new or reconditioned parts, or a new or reconditioned Product of the same or similar design.

There are no established informal dispute resolution procedures of the type described in the Magnuson-Moss Warranty Act.

PURCHASER: _____

INSTALLATION ADDRESS: _____

DATE PURCHASED: _____ SERIAL NUMBER: _____

OPENER MODEL: _____

REMOTE CONTROL MODEL: _____

DEALER NAME: _____

DEALER ADDRESS: _____

Garage Door Opener Accessories

Looking for Leading-Edge Technology or the Perfect Update/Replacement?

Genie® Has the Answer!

Did your garage door close?

Genie-Net™ technology “tells” you!

**LEADING-EDGE
TECHNOLOGY**



Closed Confirm™ Wireless Remote

(Works with Revolution Series 1500, 1200 and 1000 Models)

- Sleek and compact design
- Beeps and flashes green when garage door closes. Gives warning tone and flashes red when garage door does not close properly
- Network Adapter required

Easy operation at your finger tips

**“RETRO”
REPLACEMENT**



GenieMaster™ 3-Button Remote

- Compatible with all Genie garage door openers manufactured from 1993 to the present
- Operates up to 3 openers
- Large, easy to find buttons for activation

Convenience, Security All in One

**UPGRADE
WITH STYLE**



Keyless Entry Pad

- Wireless; can open door without remote
- Lighted keypad with flip-up cover
- Controls up to three openers



White Gray Tan Almond

Color-Match These Covers to Your Home –
4 Color Options by Special Order



Perfect Stop Parking System

- Garage parking guide for extra safety
- Ball and string system attaches to door – enables safe parking in garage



Universal Wall Push Button

- Easy to mount inside garage
- Used in addition to other remotes or wall buttons



Check out **NEW ACCESSORIES** and **PRODUCTS**; visit www.GenieCompany.com or call 1-800-35-GENIE.
Also available at Home Improvement outlets and other retail/commercial locations nationwide.

Free Manuals Download Website

<http://myh66.com>

<http://usermanuals.us>

<http://www.somanuals.com>

<http://www.4manuals.cc>

<http://www.manual-lib.com>

<http://www.404manual.com>

<http://www.luxmanual.com>

<http://aubethermostatmanual.com>

Golf course search by state

<http://golfingnear.com>

Email search by domain

<http://emailbydomain.com>

Auto manuals search

<http://auto.somanuals.com>

TV manuals search

<http://tv.somanuals.com>