

⚠ WARNING

- Severe injury or death can result if the door closing force is set too high.
- Never increase the door closing force above the minimum required to move the door.
- Never adjust force to compensate for a sticking or binding door.
- Perform monthly CONTACT REVERSE TEST as described on page 22 and in Section 10.

SETTING & TESTING OPEN/CLOSE LIMITS

The OPEN (UP) and CLOSE (DOWN) door positions are controlled by making the adjustments on the panel located on the bottom of the power head. The adjustments that can be made are:

- Close Travel Limit,
- Open Travel Limit,
- Adjust Closing Force
- Adjust Opening Force
- Transmitter Programming

A) ENGAGE CHAIN/BELT CONNECTOR TO CARRIAGE

1. Press and hold the "Close Travel Limit" button until the chain or belt connector advances and engages to the Carriage Assembly (Fig. 6-2).

B) CLOSE TRAVEL LIMIT

1. Press and hold the "Close Travel Limit" button until the door is fully closed.
2. You can quickly press and release the "Close Travel Limit" button to move the door in small increments. You can also use the "Open Travel Limit" button to move the door slightly in the UP direction.
3. Door is fully closed when the bottom edge of door presses firmly onto the ground.
4. Once the door is in the desired position, press and hold the "Close SET Limit" button for 5 seconds. The LED indicator light will blink green once. This stores the closed position in memory.

C) OPEN TRAVEL LIMIT

1. Press and hold the "Open Travel Limit" button to move the door to its fully opened position. This starts the opener moving in the UP direction.
2. Hold the "Open Travel Limit" button until the door is in the fully opened position that you desire, then release this button.
3. You can quickly press and release the "Open Travel Limit" button to move the door in small increments. You can also use the "Close Travel Limit" button to move the door slightly in the DOWN direction.
4. Once the door is in the desired position, press and hold the "Open SET Limit" button for 5 seconds. The LED indicator light will blink green twice. This stores the opened position in memory.

Limit Controls location on power head.

NOTE: Set Close Travel Limit before setting Open Travel Limit for unit to operate normally.

Unless limits are being reset do not press set limit buttons.

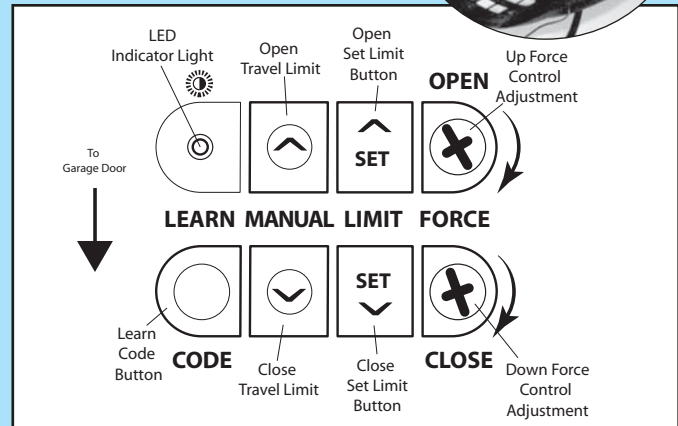
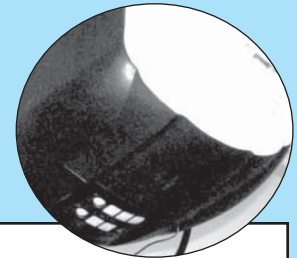

FIG. 6-1 Limit controls.

⚠ CAUTION

Failure to verify the engagement of the belt/chain connector will result in damage to rail components.

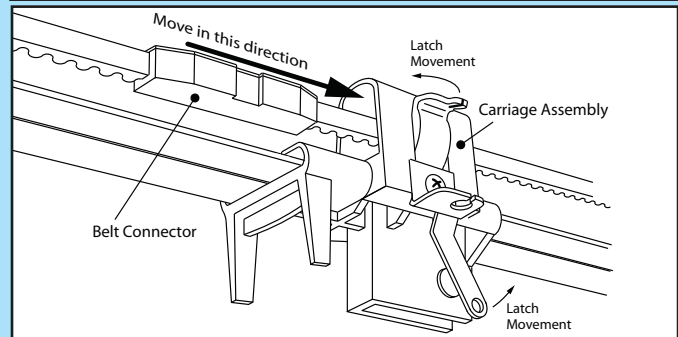
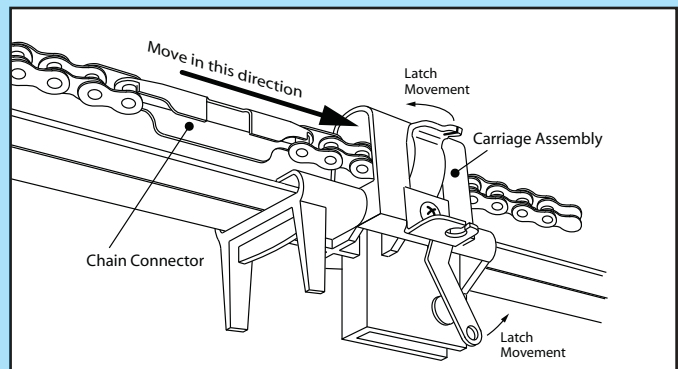

FIG. 6-2 Engage Chain/Belt Connector to Carriage.

⚠ CAUTION

Operation of the opener without the Chain or Belt Connector engaged to the Carriage Assembly will result in damage to rail components including the rail pulley.

CARRIAGE LOCK

The Carriage Lock can be manually engaged or disengaged.

- To disengage Carriage Lock
 - Pull handle downward **opener power head**.
- To engage Carriage Lock
 - Pull handle towards **door**.

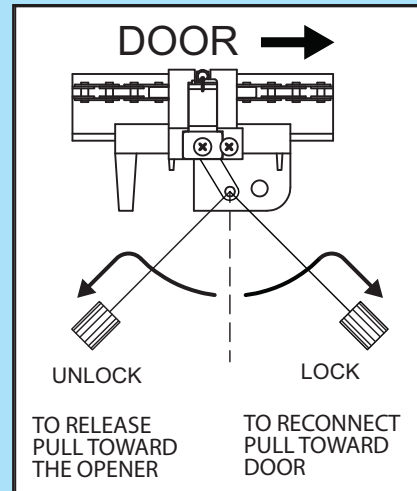

FIG. 6-3 Engage/Disengage Carriage Lock.

KEYED EMERGENCY RELEASE (PURCHASED SEPARATELY)

Obtain standard emergency release kit and **remove S-hook from the cable end** that attaches to the opener carriage.

1. Attach the emergency release cable loop end to the opener carriage as shown (FIG 6-4).

Properly connecting the release cable to the carriage fitting will enable the correct carriage release action for the opener.

⚠ WARNING

Improper connection of the emergency release cable to the opener carriage will result in a failure of the emergency release.

2. Follow the remaining installation instructions for the standard emergency release kit.
3. Test for correct operation of emergency release kit.

Keyed Emergency Release Operation Instructions

- Place key in slot.
- Rotate and **hold** key while lifting garage door 1 to 2 inches.
- Release key and continue opening garage door.

NOTE: The next normal operation of the opener or fully closing garage door manually will re-engage the emergency release mechanism.

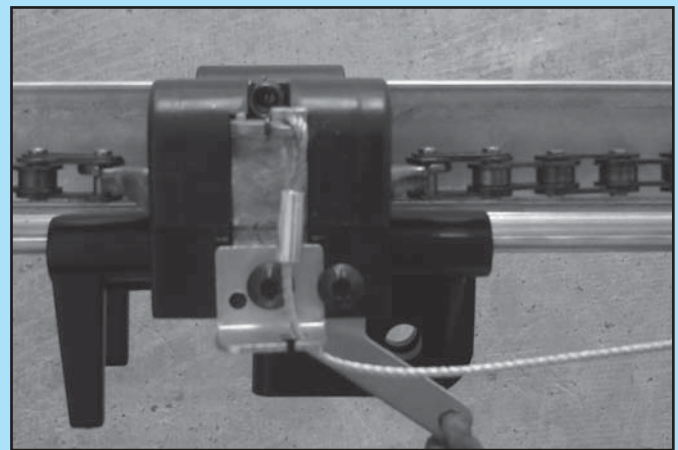







FIG. 6-4 Emergency release cable to carriage.

UP/DOWN FORCE

1. By turning the "Close Force Control"  clockwise, the **DOWN** force can be **increased**. By turning the "Close Force Control"  counter-clockwise, the **DOWN** force can be **decreased**. Set the **DOWN** force level at the minimum force required to close door without reversing.
2. Once the desired level is selected, this stores the necessary force level for the **DOWN** direction in memory.
3. By turning the "Open Force Control"  clockwise, the **UP** force can be **increased**. By turning the "Open Force Control"  counter-clockwise, the **UP** force can be **decreased**. Set the **UP** force level at the minimum force required to open door without stopping.
4. Once the desired level is selected, this stores the necessary force level for the **UP** direction in memory.

ERASE - OPEN/CLOSE TRAVEL LIMIT

1. Press and hold both of the "SET" buttons ( & ) together until the green indicator light blinks (about 5 seconds).
2. All close and open travel limit settings are erased. Then follow the steps above to reprogram close and open travel limits.

NOTE: The opener will not close the door automatically unless the Safe-T-Beam® System is installed.

CONTACT REVERSE TEST

The force adjustments and limit switch settings **MUST BE COMPLETED** before testing.

1. **Testing.**
 - Open garage door using Wall Control.
 - Place a 2" x 4" board (laid flat) under **center of garage door opening** (FIG. 6-6).
 - Close door using Wall Control.
 - When door contacts board, the door must stop (within 2 seconds) and reverse direction returning to open position.
2. **Adjustment.**
 - If the door does not properly reverse.
 - Check to see if door has "close" limit programmed. It should not have reached its "close" limit before hitting board.
 - If the door **STOPS** but does not reverse, decrease "**CLOSE FORCE**" control  setting slightly (turn it counter-clockwise).
 - Test again. Repeat as necessary until door reverses upon contacting board.

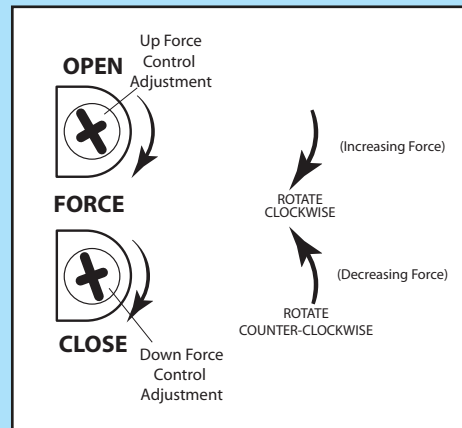

FIG. 6-5 Force Control Adjustment.

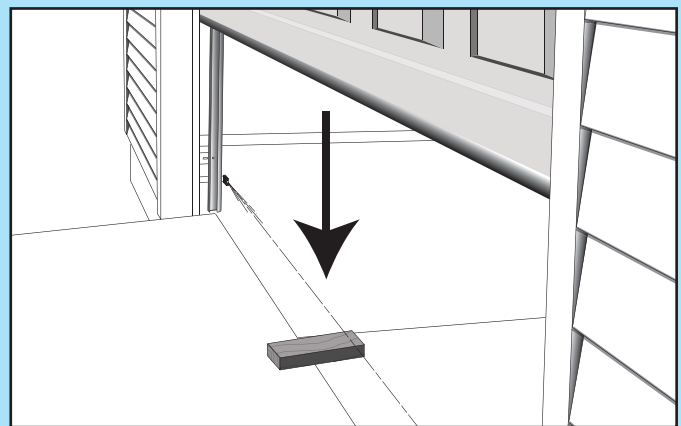

FIG. 6-6 2 x 4 under center of door opening.

7 PROGRAMMING REMOTE CONTROLS

⚠ WARNING

A moving door can cause serious injury or death.

1. Keep people clear of opening while door is moving.
2. Do NOT allow children to play with opener, including wall button, remote control, or Wireless Keypad.
3. During programming, the door opener could begin to run, so keep people and objects away from the moving door and its parts. To keep the door from moving, close the door and disconnect it from the Opener by pulling the Emergency Release.

NOTE: For remote control locate Box 3.

1a. Single Button Remote Programming.

NOTE: This opener can learn up to 7 transmitter buttons.

- Locate “Learn Code”  button and indicator LED on the power head (**Fig. 7-1**).
- Press and release “Learn Code” button.
 - Indicator LED will blink RED at a rate of twice per second.
- **Within 30 seconds**, push remote control button once.
 - Indicator LED will stop blinking and stay **ON**.
- Press remote control button again.
 - Red LED will go out. Remote is now programmed and ready for use.
- Press remote control button again, door will move.

1b. Multi Button Remote Programming.

NOTE: Each button on a multi-button remote is designed for use with 1 door. You cannot program 2 buttons to operate the same door, nor can you program 1 button to operate 2 doors. You can program a maximum of 7 different transmitters or wireless devices.

NOTE: Pushing two buttons on power head simultaneously will erase programmed memory and limits must be reset.

- For each button.
 - Program each button separately using the **Single Button Remote Programming steps**.

2. Operating.

- Press remote button once.
 - Door will move.
- Press button again.
 - Door will stop.
- Press button again.
 - Door will move in opposite direction.

NOTE: The door will stop automatically at the fully open or fully closed position.

LOST OR STOLEN REMOTE

1. Clear memory.

- Press and hold learn code button (on power head) for 10 seconds or until the red blinking indicator LED goes out.
- Program remaining or new remote controls as done previously. *Your door opener will no longer recognize any signal received from the missing remote control, or any other which has not been reprogrammed.*



NOTE: To program a **HomeLink®** and **Car2U®** device follow the **HomeLink®** or **Car2U®** instructions in your car owner's manual.

FCC and IC CERTIFIED

This device complies with FCC Part 15 and RSS 210 of Industry Canada. This equipment has been tested and found to comply with the limits for a Class B digital device, pursuant to Part 15 of the FCC Rules. These limits are designed to provide reasonable protection against harmful interference in a residential installation. This equipment generates, uses and can radiate radio frequency energy and, if not installed and used in accordance with the instructions, may cause harmful interference to radio communications. However, there is no guarantee that interference will not occur in a particular installation. If this equipment does cause harmful interference to radio or television reception, which may be determined by turning the equipment OFF and ON, the user is encouraged to try to correct the interference by one or more of the following measures:

- Re-orient or relocate the receiver antenna.
- Increase the separation between the opener and receiver.
- Connect the opener into an outlet on a circuit different from that to which the receiver is connected.
- Consult your local dealer.

Limit controls location on power head.

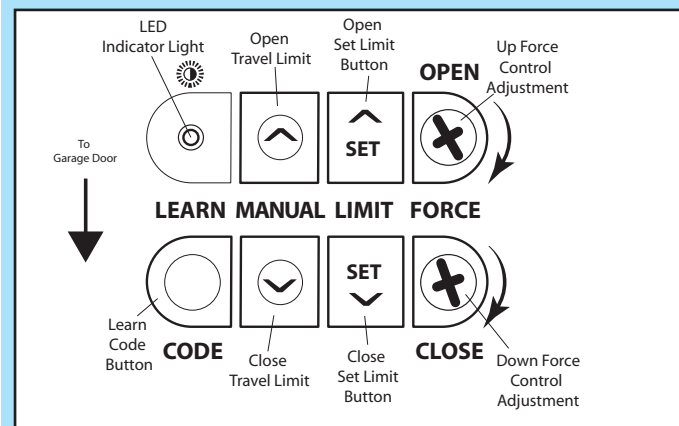
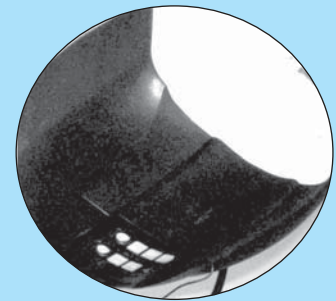

FIG. 7-1 Learn code button and LED

8 REMOTE CONTROL BATTERY REPLACEMENT AND VISOR CLIP INSTALLATION

1. Battery replacement.

- To open, gently push straight out on battery cover lock tab as shown. (Fig. 8-1).
- Slide open battery cover.
 - Remove old battery.
- Make sure new battery is facing proper direction (Match battery polarity with symbols inside battery housing) (Fig. 8-2).
 - Recommended replacement battery type: Alkaline **A23**, 12 volt.

NOTE: Batteries differ in care and maintenance. Follow the manufacturer's directions for battery maintenance, replacement, and use.

- Slip new battery into place.
 - Slide battery cover until it clicks shut.
- Operate remote to make sure it is working properly. (No re-programming is needed.)

2. Visor clip.

(The visor clip may come already installed.) You will have to install the visor clip if you choose to attach your remote to the car visor.

- Slide visor clip into back of remote control.
 - It will snap into place (Fig. 8-3).



FIG. 8-1 Open battery cover.

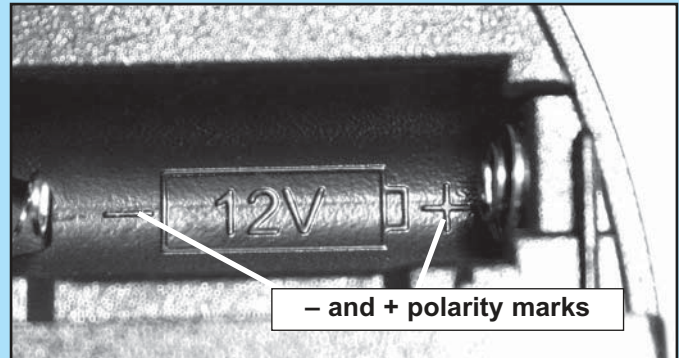

FIG. 8-2 Match battery polarity.



FIG. 8-3 Attach visor clip.

9 LIGHT BULB/LENS INSTALLATION

⚠ WARNING

For added safety and protection please unplug opener before installing light bulb.

NOTE: For lens covers locate Box 4.

1. Light bulb.

- Recommendations.
 - Do NOT use a short neck bulb.
 - Light bulbs should be no more than 60 Watts.
 - Use a **heavy duty service** bulb for longer life.
- Screw 1 bulb into each socket.

2. Lens.

- Select a white (lamp) cover.
- On the power head end nearest the garage door, line up lamp lens tabs on power head with corresponding slots in lens (Fig. 9-1).
- Slide lens onto power head. Make sure the tabs are fully engaged into lens slots (Fig. 9-2).
- Repeat for rear lens on power head.
- Plug power cord back into electrical outlet.
- Test lamp operation.

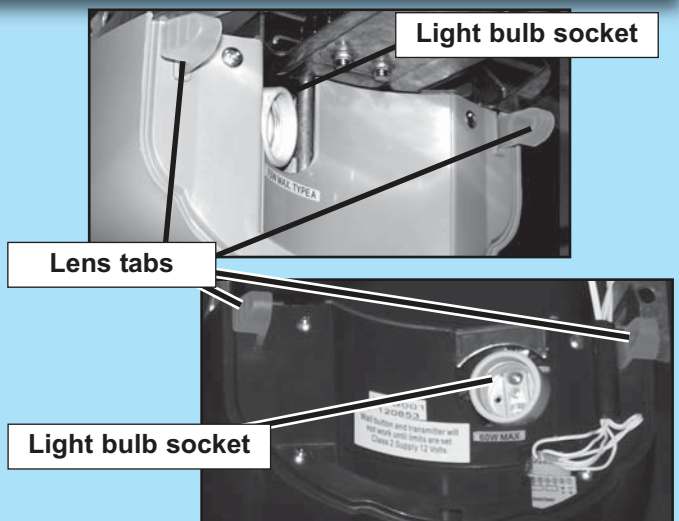

FIG. 9-1 Slide each lens onto motor cover.

FIG. 9-2 Fasten lens.



Free Manuals Download Website

<http://myh66.com>

<http://usermanuals.us>

<http://www.somanuals.com>

<http://www.4manuals.cc>

<http://www.manual-lib.com>

<http://www.404manual.com>

<http://www.luxmanual.com>

<http://aubethermostatmanual.com>

Golf course search by state

<http://golfingnear.com>

Email search by domain

<http://emailbydomain.com>

Auto manuals search

<http://auto.somanuals.com>

TV manuals search

<http://tv.somanuals.com>