

# Genie®



## Operator's Manual

*with Maintenance Information*

Fourth Edition  
First Printing  
Part No. 97866

### TMZ™-34/19

*This manual replaces  
part number 72895*

---

## Important

Read, understand and obey these safety rules and operating instructions before operating this machine. Only trained and authorized personnel shall be permitted to operate this machine. This manual should be considered a permanent part of your machine and should remain with the machine at all times. If you have any questions, call Genie Industries.

---

## Contents

	Page
Safety .....	1
Controls .....	8
Pre-operation Inspection .....	14
Maintenance .....	16
Function Tests .....	19
Workplace Inspection .....	24
Operating Instructions .....	25
Decals .....	32
Specifications .....	34
Reporting Safety Defects .....	35

---

## Contact us:

Internet: <http://www.genielift.com>  
 e-mail: [techpub@genieind.com](mailto:techpub@genieind.com)

---

## Notice

This operator's manual is for TMZ-34/19 machines after serial number T3499-796. It replaces operator's manual part number 72895.

---

Copyright © 1998 by Genie Industries

Second Edition: Third Printing, January 2002

Fourth Edition: First Printing, May 2005

"Genie" and "TMZ" are registered trademarks of Genie Industries in the USA and many other countries.

These machines comply with ANSI/SIA 92.2-1990.

 Printed on recycled paper

Printed in U.S.A.

---

# Safety Rules



---

## Danger

Failure to obey the instructions and safety rules in this manual will result in death or serious injury.

---

## Do Not Operate Unless:

- You learn and practice the principles of safe machine operation contained in this operator's manual.

### 1 Avoid hazardous situations.

**Know and understand the safety rules before going on to the next section.**

2 Always perform a pre-operation inspection.

3 Always perform function tests prior to use.

4 Inspect the workplace.

5 Only use the machine as it was intended.

- You read, understand and obey the manufacturer's instructions and safety rules—safety and operator's manuals and machine decals.
- You read, understand and obey employer's safety rules and worksite regulations.
- You read, understand and obey all applicable governmental regulations.
- You are properly trained to safely operate the machine.

SAFETY RULES

### Electrocution Hazards

This machine is not electrically insulated and will not provide protection from contact with or proximity to electrical current.

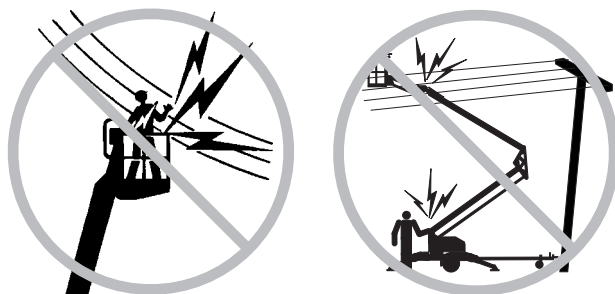

Maintain safe distances from electrical power lines and apparatus in accordance with applicable governmental regulations and the following chart.

Voltage Phase to Phase	Minimum Safe Approach Distance	
	Feet	Meters
0 to 300V	Avoid Contact	
300V to 50KV	10	3.05
50KV to 200KV	15	4.60
200KV to 350KV	20	6.10
350KV to 500KV	25	7.62
500KV to 750KV	35	10.67
750KV to 1000KV	45	13.72

Allow for platform movement, electrical line sway or sag and beware of strong or gusty winds.

Keep away from the machine if it contacts energized power lines. Personnel on the ground or in the platform must not touch or operate the machine until energized power lines are shut off.

Do not operate the machine during lightning or storms.

Do not use the machine as a ground for welding.

### Tip-over Hazards

Occupants, equipment and materials shall not exceed the maximum platform capacity.

<b>Maximum platform capacity</b>		
<b>ANSI &amp; CE models</b>	500 lbs	227 kg
<b>Maximum platform capacity</b>		
<b>CSA models</b>	440 lbs	200 kg
<b>Maximum platform capacity with</b>		
<b>Optional Platform Rotate</b>	440 lbs	200 kg
<b>Maximum occupants</b>		2

Do not raise the boom unless the machine is level. Do not set the machine up on a surface where it cannot be leveled using only the outriggers.

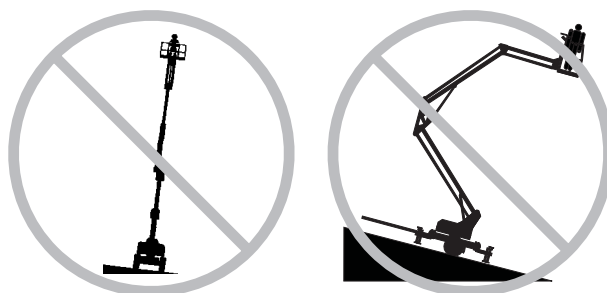

Do not raise the boom unless all four outriggers are lowered, the footpads are in firm contact with the ground and the machine is level.

Do not set the machine up unless it is on a firm surface. Avoid drop-offs, holes, unstable or slippery surfaces and other possible hazardous conditions.

Do not adjust or stow the outriggers when the boom is raised.

Do not operate the machine near drop-offs, holes, bumps, debris, unstable or slippery surfaces or other possible hazardous conditions.

## SAFETY RULES

Do not move the machine when the boom is raised.

Do not depend on the tilt alarm as a level indicator. The tilt alarm sounds in the platform only when the machine is on a severe slope.

When the tilt alarm sounds, immediately lower the boom and adjust the outriggers to level the machine. When the alarm sounds, boom up functions will not operate.

Do not alter or disable the limit switches.



Do not operate the machine in strong or gusty winds. Do not increase the surface area of the platform or the load. Increasing the area exposed to the wind will decrease machine stability.

Do not alter or disable machine components that in any way affect safety and stability.

Do not replace items critical to machine stability with items of different weight or specification.

Do not modify or alter an aerial work platform. Mounting attachments for holding tools or other materials onto the platform, toeboards or guard rail system can increase the weight in the platform and the surface area of the platform or load.

Do not transport tools and materials unless they are evenly distributed and can be safely handled by person(s) in the platform.

Do not place ladders or scaffolds in the platform or against any part of this machine.

Do not use the machine on a moving or mobile surface or vehicle.

Be sure all tires are properly inflated and in good condition and lug nuts are properly tightened.

Do not use batteries that weigh less than the original equipment. Four batteries are used as counterweight and are critical to machine stability. Each battery must weigh 75 pounds / 34 kg.

Do not push the machine or other objects with the boom.

Do not contact adjacent structures with the boom.

Do not tie the boom or platform to adjacent structures.

### Bodily Injury Hazard

Do not operate the machine with a hydraulic oil or air leak. An air leak or hydraulic leak can penetrate and/or burn skin.

Improper contact with components under any cover will cause serious injury. Only trained maintenance personnel should access compartments. Access by the operator is only advised when performing a pre-operation inspection. All compartments must remain closed and secured during operation.

## SAFETY RULES

### Collision Hazards

Be aware of boom position when rotating the turntable.

The machine must be on a level surface or secured before releasing the parking brake.

Use the parking brake to control the speed of the machine when pushing a machine that is not attached to a tow vehicle.

Check the work area for overhead obstructions or other possible hazards.

Do not lower the boom unless the area below is clear of personnel and obstructions.

Do not operate a boom in the path of any crane unless the controls of the crane have been locked out and/or precautions have been taken to prevent any potential collision.

No stunt driving or horseplay while operating the machine.

### Component Damage Hazards

Do not use the machine as a ground for welding.

Do not fully lower the booms unless the booms are aligned with the tongue. The booms must be lowered onto the boom rests.

### Lifting Hazards

Use proper lifting techniques to move, load or unload the machine.

Use proper lifting techniques when installing or removing the platform.

### Explosion and Fire Hazards

Do not operate the machine in hazardous locations or locations where potentially flammable or explosive gases or particles may be present.

### Damaged Machine Hazards

Do not use a damaged or malfunctioning machine.

Conduct a thorough pre-operation inspection of the machine and test all functions before each work shift. Immediately tag and remove from service a damaged or malfunctioning machine.

Be sure all maintenance has been performed as specified in this manual and the appropriate service manual.

Be sure all decals are in place and legible.

Be sure the operator's, safety and responsibilities manuals are complete, legible and in the storage container located on the platform.

## SAFETY RULES

## Towing Hazards

Read, understand and obey all of your tow vehicle manufacturer's recommendations, warnings and instructions before towing this machine.

Do not tow the machine unless the boom hold-down latches are securely locked in place.

Do not overload your tow vehicle. Check the manufacturer's Gross Vehicle Weight Rating (GVWR). To obtain the gross vehicle weight, add the tongue weight of the trailer to the vehicle weight (including vehicle, passengers and cargo).

Do not load cargo on the machine. The TMZ-34 is not designed to carry any extra cargo.

Be sure the hitch is securely attached to the tow vehicle.

Be sure the safety chains (if required) are securely attached to the tow vehicle.

Be sure that all driving lights are operational.

Be sure all hitch components, lights and mirrors and methods of attaching the trailer to the tow vehicle conform to local, state and federal regulations.

Do not tow the machine on public roads unless it meets all governmental regulations for towing.

Do not exceed 60 mph / 97 km/h. Obey all local and national towing speed laws.

Be sure to chock the wheels of the trailer when parking on a hill.

## Decal Legend

Genie product decals use symbols, color coding and signal words to identify the following:



Safety alert symbol—used to alert personnel to potential personal injury hazards. Obey all safety messages that follow this symbol to avoid possible injury or death.

### **▲ DANGER**

Red—used to indicate the presence of an imminently hazardous situation which, if not avoided, will result in death or serious injury.

### **▲ WARNING**

Orange—used to indicate the presence of a potentially hazardous situation which, if not avoided, could result in death or serious injury.

### **▲ CAUTION**

Yellow with safety alert symbol—used to indicate the presence of a potentially hazardous situation which, if not avoided, may cause minor or moderate injury.

### **CAUTION**

Yellow without safety alert symbol—used to indicate the presence of a potentially hazardous situation which, if not avoided, may result in property damage.

### **NOTICE**

Green—used to indicate operation or maintenance information.

## SAFETY RULES

## Personnel Lifting Configuration

### Tip-over Hazards

Do not use the platform as a crane.

Do not place loads outside the platform perimeter.

Do not place or attach overhanging loads to any part of the platform.

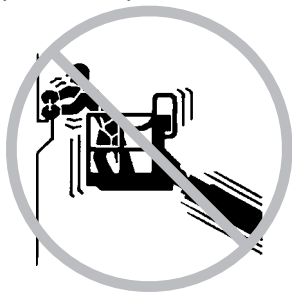

Do not push off or pull toward any object outside of the platform.

**Maximum allowable side force -**  
90 lbs / 400 N

Do not use the platform controls to free a platform that is caught, snagged or otherwise prevented from normal motion by an adjacent structure. All personnel must be removed from the platform before attempting to free the platform using the ground controls.

### Fall Hazards

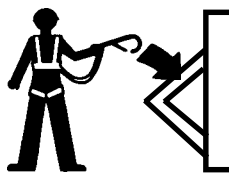

Occupants must wear a safety belt or harness and comply with applicable governmental regulations. Attach the lanyard to the anchor provided in the platform.

Lower the platform entry mid-rail or close the entry gate before operating.

Do not sit, stand or climb on the platform guard rails. Maintain a firm footing on the platform floor at all times.

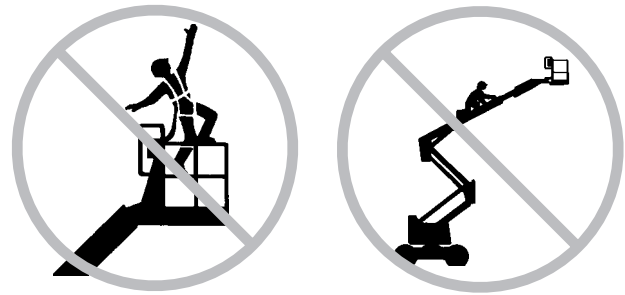

Do not climb down from the platform when raised.

Keep the platform floor clear of debris.

### Collision Hazard

Be aware of crushing hazards when grasping the platform guard rail.

## Material Lifting Configuration

### Collision Hazards

Do not raise the load unless the material lifting hook is properly secured to the machine.

Do not raise unless the load is properly balanced and secured to the machine.

Do not stand under or allow personnel under the load or the machine when the load is raised.

### Crushing Hazard

Use common sense and planning when operating the machine with the platform controls from the ground. Maintain safe distances between the operator, the machine and fixed objects.



## SAFETY RULES

## Battery Safety

---

### Burn Hazards

Batteries contain acid. Always wear protective clothing and eye wear when working with batteries.

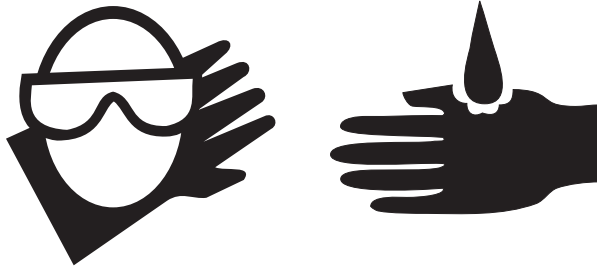

Avoid spilling or contacting battery acid. Neutralize battery acid spills with baking soda and water.

### Explosion Hazards



Keep sparks, flames and lighted tobacco away from batteries. Batteries emit an explosive gas.

The covers should be open during the entire charging cycle.

Do not contact the battery terminals or the cable clamps with tools that may cause sparks.

### Component Damage Hazards

Do not use any battery charger greater than 24V to charge the batteries.

Do not expose the batteries or the charger to water or rain.

### Electrocution Hazards

Connect the battery charger to a grounded, AC 3-wire electrical outlet only.



Inspect daily for damaged cord, cables and wires. Replace damaged items before operating.

Avoid electrical shock from contact with battery terminals. Remove all rings, watches and other jewelry.

### Tip-over Hazard

Do not use batteries that weigh less than the original equipment. Four batteries are used as counterweight and are critical to machine stability. Each battery must weigh 75 pounds / 34 kg.

### Lifting Hazard

Use the appropriate number of people and proper lifting techniques when lifting batteries.

# Controls

**Note:** Refer to the control panel pictures on the following pages to determine which panels are on your machine.

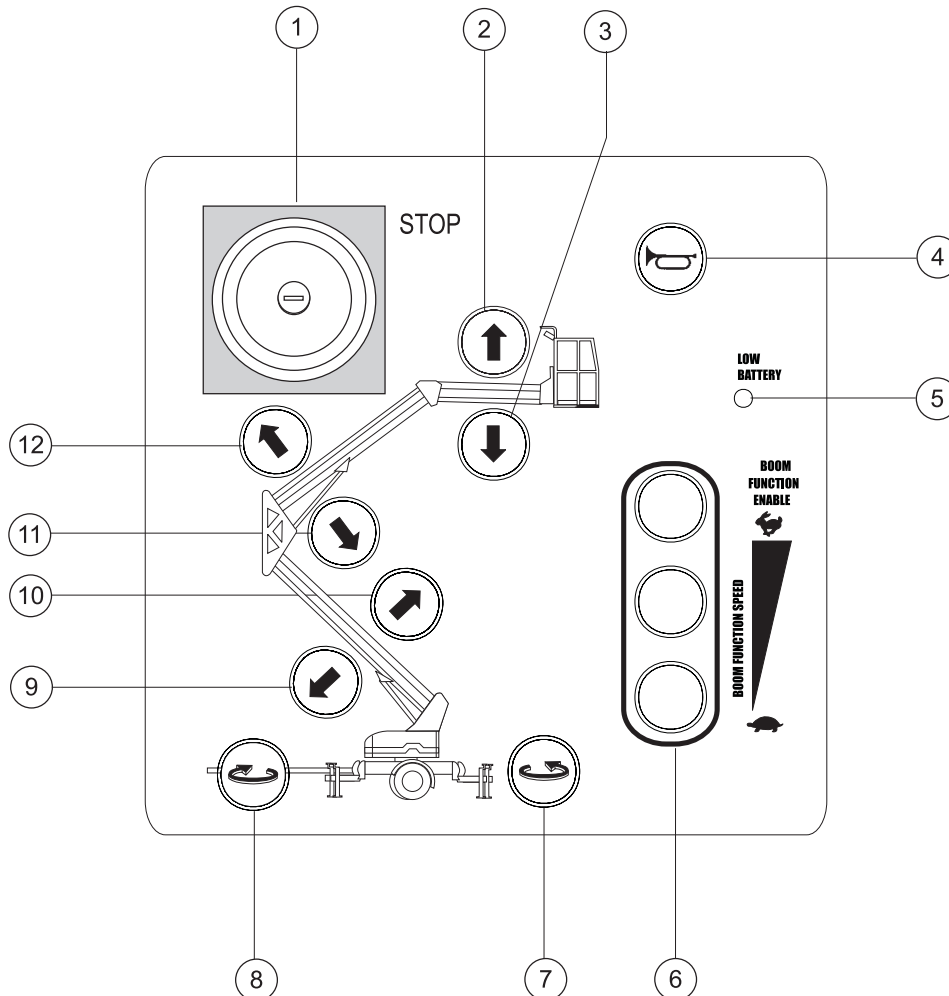

## Platform Control Panel

- |  |                                |
|--|--------------------------------|
| 1 Red Emergency Stop button            | 8 Turntable rotate left button |
| 2 Jib boom up button                   | 9 Secondary boom down button   |
| 3 Jib boom down button                 | 10 Secondary boom up button    |
| 4 Horn button                          | 11 Primary boom down button    |
| 5 Low battery indicator light          | 12 Primary boom up button      |
| 6 Function enable/speed select buttons |                                |
| 7 Turntable rotate right button        |                                |

CONTROLS

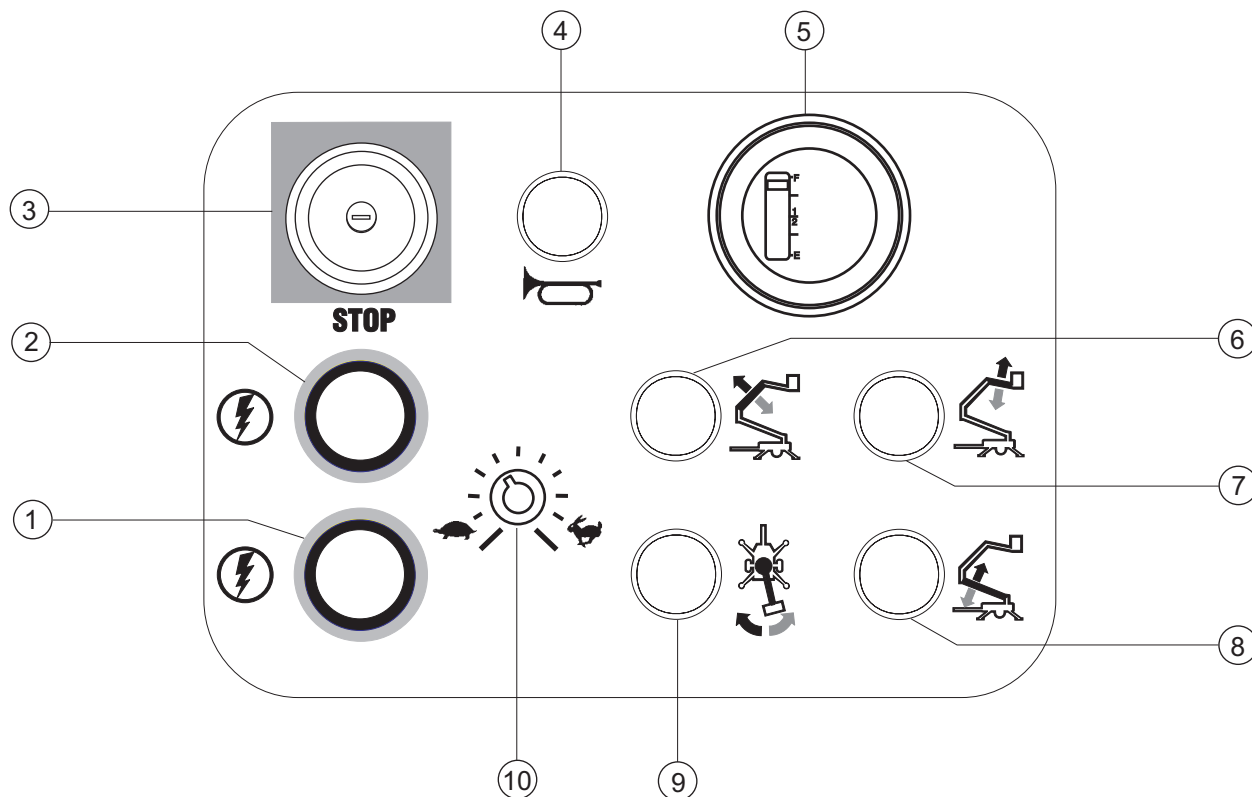

**Platform Control Panel**

- |  |  |
|--|--|
| <p>1 Function enable button for:<br/>                 Primary boom down<br/>                 Secondary boom down<br/>                 Jib boom down<br/>                 Turntable rotate right</p> <p>2 Function enable button for:<br/>                 Primary boom up<br/>                 Secondary boom up<br/>                 Jib boom up<br/>                 Turntable rotate left</p> | <p>3 Red Emergency Stop button</p> <p>4 Horn button</p> <p>5 Battery charge indicator</p> <p>6 Primary boom up/down button</p> <p>7 Jib boom up/down button</p> <p>8 Secondary boom up/down button</p> <p>9 Turntable rotate button</p> <p>10 Boom function speed controller</p> |
|--|--|

CONTROLS

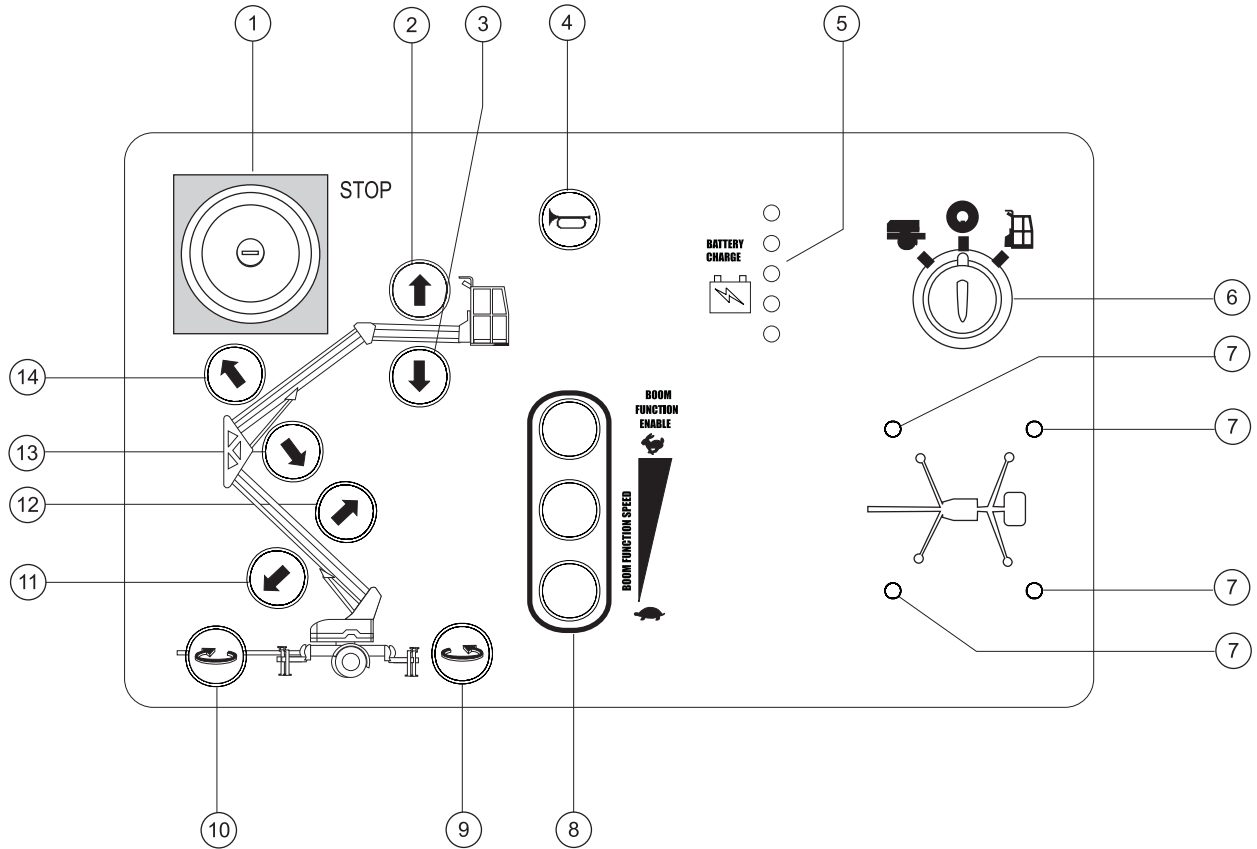

**Ground Control Panel  
(manual outriggers)**

- |  |  |
|--|--|
| 1 Red Emergency Stop button                    | 8 Function enable/speed select buttons |
| 2 Jib boom up button                           | 9 Turntable rotate right button        |
| 3 Jib boom down button                         | 10 Turntable rotate left button        |
| 4 Horn button                                  | 11 Secondary boom down button          |
| 5 Battery charge indicator                     | 12 Secondary boom up button            |
| 6 Key switch for ground/off/platform selection | 13 Primary boom down button            |
| 7 Outrigger interlock display lights (four)    | 14 Primary boom up button              |

CONTROLS

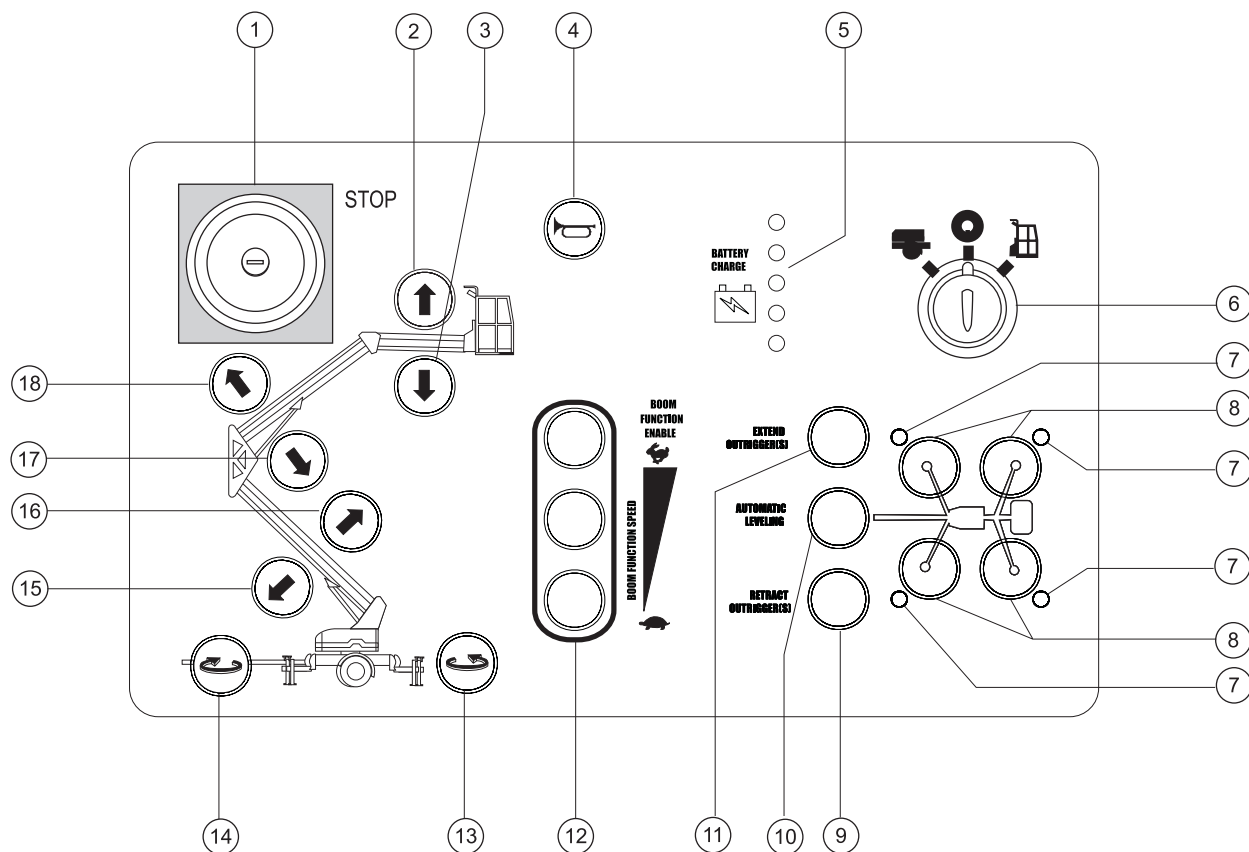

**Ground Control Panel  
(hydraulic outriggers)**

- 1 Red Emergency Stop button
- 2 Jib boom up button
- 3 Jib boom down button
- 4 Horn button
- 5 Battery charge indicator
- 6 Key switch for ground/off/platform selection
- 7 Outrigger interlock display lights (four)
- 8 Outrigger buttons (four)
- 9 Retract outrigger(s) enable button
- 10 Automatic leveling button
- 11 Extend outrigger(s) enable button
- 12 Function enable/speed select buttons
- 13 Turntable rotate right button
- 14 Turntable rotate left button
- 15 Secondary boom down button
- 16 Secondary boom up button
- 17 Primary boom down button
- 18 Primary boom up button

## CONTROLS

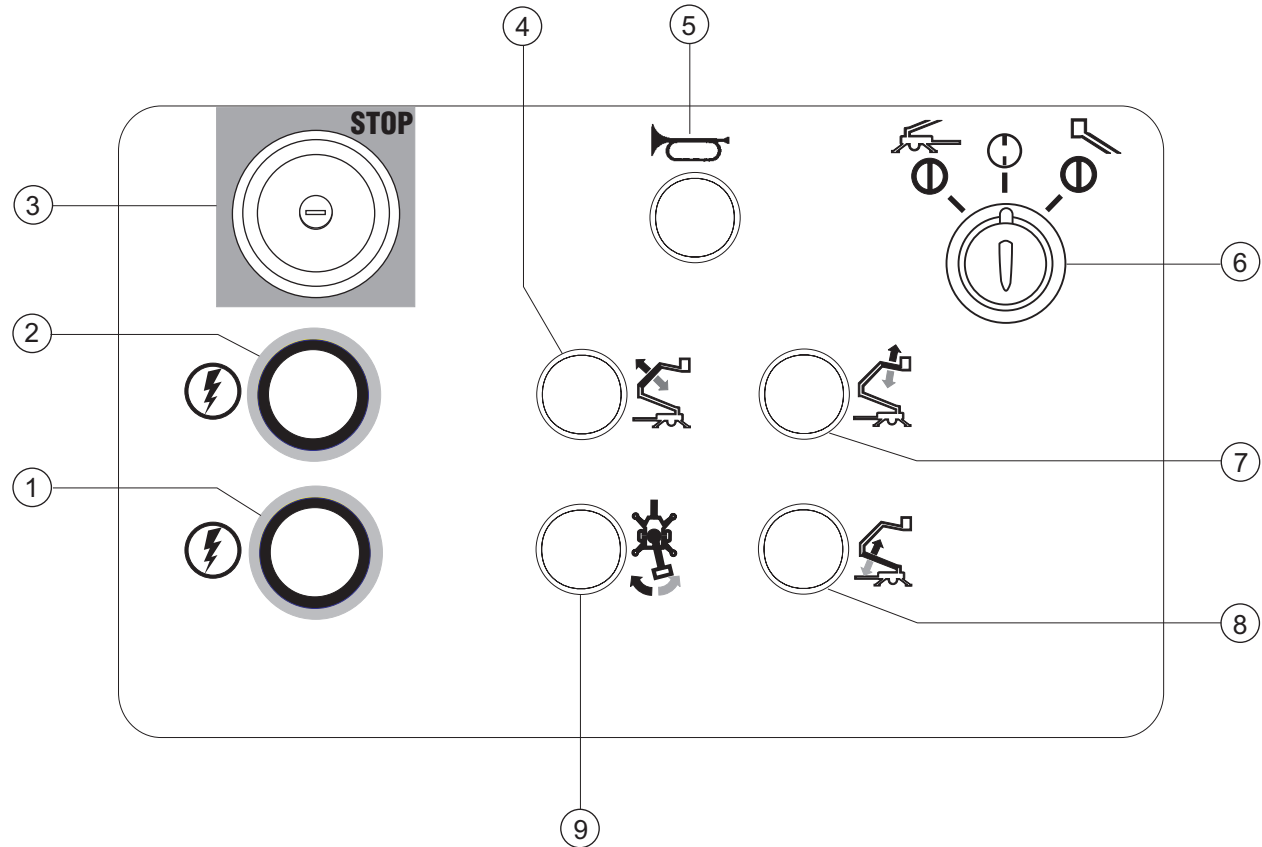

### Ground Control Panel (manual outriggers)

- |   |   |
|---|---|
| <p>1 Function enable button for:<br/>           Primary boom down<br/>           Secondary boom down<br/>           Jib boom down<br/>           Turntable rotate right</p> | <p>3 Red Emergency Stop button</p>                    |
| <p>2 Function enable button for:<br/>           Primary boom up<br/>           Secondary boom up<br/>           Jib boom down<br/>           Turntable rotate left</p>      | <p>4 Primary boom up/down button</p>                  |
|   | <p>5 Horn button</p>                                  |
|   | <p>6 Key switch for ground/off/platform selection</p> |
|   | <p>7 Jib boom up/down button</p>                      |
|   | <p>8 Secondary boom up/down button</p>                |
|   | <p>9 Turntable rotate button</p>                      |

## CONTROLS

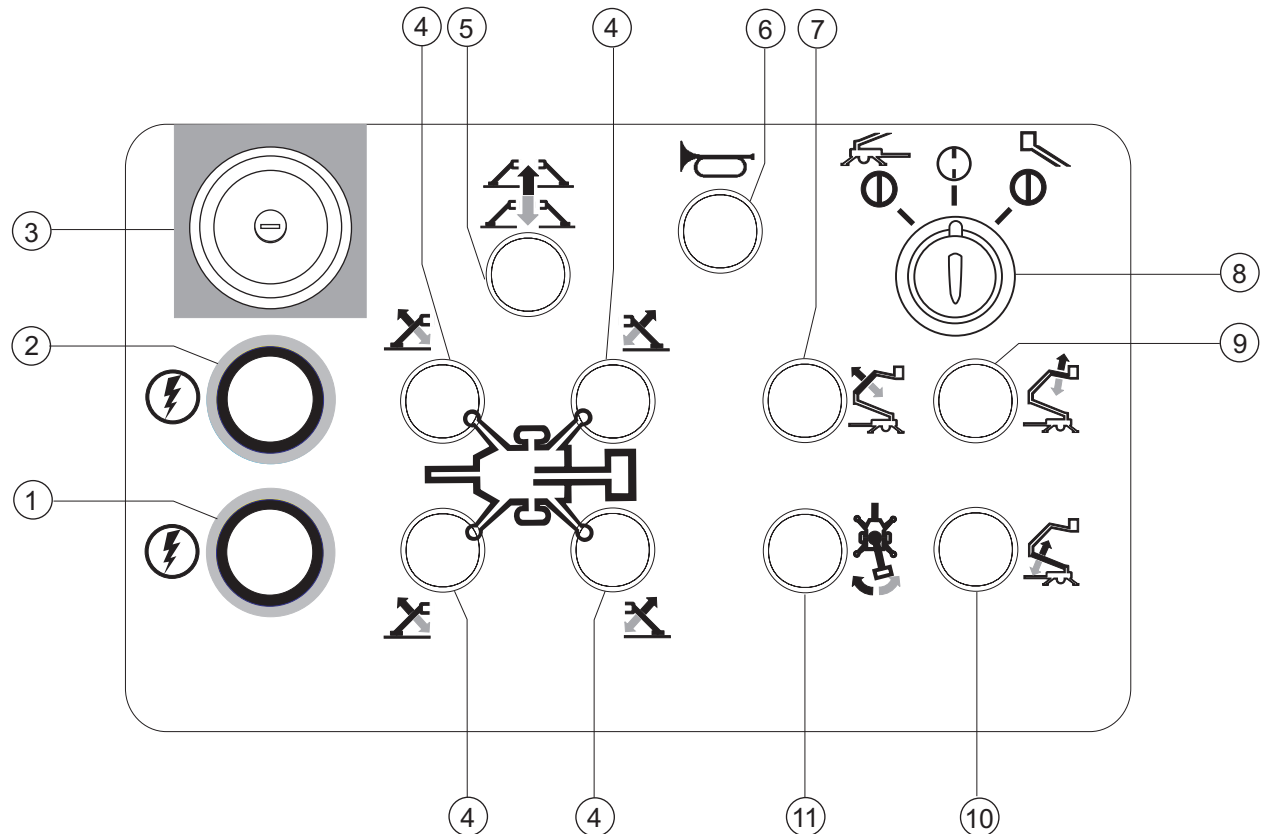

### Ground Control Panel (hydraulic outriggers)

- |  |   |
|--|---|
| <p>1 Function enable button for:<br/>           Primary boom down<br/>           Secondary boom down<br/>           Jib boom down<br/>           Turntable rotate right<br/>           Outrigger lower</p> <p>2 Function enable button for:<br/>           Primary boom up<br/>           Secondary boom up<br/>           Jib boom up<br/>           Turntable rotate left<br/>           Outrigger raise</p> | <p>3 Red Emergency Stop button</p> <p>4 Outrigger raise/lower button<br/>(individual outrigger)</p> <p>5 Outrigger auto level button</p> <p>6 Horn button</p> <p>7 Primary boom up/down button</p> <p>8 Key switch for ground/off/platform selection</p> <p>9 Jib boom up/down button</p> <p>10 Secondary boom up/down button</p> <p>11 Turntable rotate button</p> |
|--|---|

# Pre-operation Inspection



---

## Do Not Operate Unless:

- You learn and practice the principles of safe machine operation contained in this operator's manual.

1 Avoid hazardous situations.

### **2 Always perform a pre-operation inspection.**

**Know and understand the pre-operation inspection before going on to the next section.**

3 Always perform function tests prior to use.

4 Inspect the workplace.

5 Only use the machine as it was intended.

## Fundamentals

It is the responsibility of the operator to perform a Pre-operation Inspection and routine maintenance.

The pre-operation inspection is a visual inspection performed by the operator prior to each work shift. The inspection is designed to discover if anything is apparently wrong with a machine before the operator performs the function tests.

The pre-operation inspection also serves to determine if routine maintenance procedures are required. Only routine maintenance items specified in this manual may be performed by the operator.

Refer to the list on the next page and check each of the items.

If damage or any unauthorized variation from factory delivered condition is discovered, the machine must be tagged and removed from service.

Repairs to the machine may only be made by a qualified service technician, according to the manufacturer's specifications. After repairs are completed, the operator must perform a pre-operation inspection again before going on to the function tests.

Scheduled maintenance inspections shall be performed by qualified service technicians, according to the manufacturer's specifications and the requirements listed in the responsibilities manual.



## PRE-OPERATION INSPECTION

## Pre-operation Inspection

---

- Be sure that the operator's, safety and responsibilities manuals are complete, legible and in the storage container located on the platform.
- Be sure that all decals are legible and in place. See Decals section.
- Check for hydraulic oil leaks and proper oil level. Add oil if needed. See Maintenance section.
- Check for battery fluid leaks and proper fluid level. Add distilled water if needed. See Maintenance section.
- Check for proper tire pressure and lug nut torque. Add air to tires if needed. See Maintenance section.

Check the following components or areas for damage, improperly installed or missing parts and unauthorized modifications:

- Electrical components, wiring and electrical cables
- Hydraulic power unit, reservoir, hoses, fittings, cylinders and manifolds
- Boom components and wear pads
- Tires and wheels
- Trailer lights and reflectors
- Parking brake components
- Outriggers, leveling jacks and foot pads
- Limit switch, alarms and horn
- Nuts, bolts and other fasteners
- Platform entry mid-rail/gate
- Surge brake components (if equipped)
- Safety chains (if required)
- Mechanical brake components (if equipped)

- Axle components
- Beacon and alarms (if equipped)

Check entire machine for:

- Cracks in welds or structural components
- Dents or damage to machine

- Be sure that all structural and other critical components are present and all associated fasteners and pins are in place and properly tightened.
- Be sure that the machine is properly configured for use.  
Personnel lifting configuration: Be sure the platform is properly installed.  
Material lifting configuration: Be sure the material lifting hook is properly installed.
- Be sure that the batteries are in place and properly connected.
- Models equipped with surge brake systems: Check the hydraulic oil level in the surge brake. Check for leaks.
- After you complete your inspection, be sure that all compartment covers are in place and latched.

# Maintenance



## Observe and Obey:

- ☑ Only routine maintenance items specified in this manual shall be performed by the operator.
- ☑ Scheduled maintenance inspections shall be completed by qualified service technicians, according to the manufacturer's specifications and the requirements specified in the responsibilities manual.

## Maintenance Symbols Legend

### NOTICE

The following symbols have been used in this manual to help communicate the intent of the instructions. When one or more of the symbols appear at the beginning of a maintenance procedure, it conveys the meaning below.



Indicates that tools will be required to perform this procedure.



Indicates that new parts will be required to perform this procedure.

## Check the Hydraulic Oil Level



Maintaining the hydraulic oil at the proper level is essential to machine operation. Improper hydraulic oil levels can damage hydraulic components. Daily checks allow the inspector to identify changes in oil level that might indicate the presence of hydraulic system problems.

- 1 Be sure the boom is in the stowed position and the hydraulic outriggers (if equipped) are retracted.
  - 2 Visually inspect the oil level in the hydraulic power unit reservoir.
- ⦿ Result: The hydraulic oil level should be visible in the gauge.

---

### Hydraulic oil specifications

---

Hydraulic oil type	Dexron equivalent

---

## MAINTENANCE

## Check the Tires and Wheels



**WARNING** Bodily injury hazard. An over-inflated tire can explode and may cause death or serious injury.

**WARNING** Collision hazard. An excessively worn tire can cause poor handling and continued use could result in tire failure.

**WARNING** Tip-over hazard. Do not use temporary flat tire repair products.

Maintaining the tires and wheels in good condition is essential to safe operation and good performance. Tire and/or wheel failure could result in a machine tip-over. Component damage may also result if problems are not discovered and repaired in a timely fashion.

- 1 Check the tire surface and sidewalls for cuts, cracks, punctures and uneven or excessive tread wear.
- ⦿ Result: Replace the tire if uneven or excessive tread wear is found.

**NOTICE** Always replace the tire with specifications equal to original equipment manufacturer.

- 2 Check each wheel for damage, bends and cracks.
- ⦿ Result: Replace the wheel if any damage is found.
- 3 Check each tire with an air pressure gauge and add air as needed.

- 4 Check the torque of each lug nut.

---

### Tires and wheels - ANSI & CSA

---

Tire size	ST195/75D14	
Lug nut torque	80 ft-lbs	108 Nm
Tire pressure (cold)	65 psi	4.5 bar

---

### Tires and wheels - CE

---

Tire size	195/65R15 91T	
Lug nut torque	80 ft-lbs	108 Nm
Tire pressure (cold)	44 psi	3.0 bar

---

## MAINTENANCE

## Check the Batteries



Proper battery condition is essential to good performance and operational safety. Improper fluid levels or damaged cables and connections can result in component damage and hazardous conditions.

**NOTICE**

This procedure does not need to be performed on machines with sealed or maintenance-free batteries.

**AWARNING**

Bodily injury hazard. Batteries contain acid. Avoid spilling or contacting battery acid. Neutralize battery acid spills with baking soda and water.

- 1 Put on protective clothing and eye wear.
- 2 Be sure that the battery cable connections are tight and free of corrosion.
- 3 Be sure that the battery hold-down brackets are secure.
- 4 Remove the battery vent caps.
- 5 Check the battery acid level. If needed, replenish with distilled water to the bottom of the battery fill tube. Do not overfill.
- 6 Install the vent caps.

## Scheduled Maintenance

Maintenance performed quarterly, annually and every two years must be completed by a person trained and qualified to perform maintenance on this machine according to the procedures found in the service manual for this machine.

Machines that have been out of service for more than three months must receive the quarterly inspection before they are put back into service.

# Function Tests



---

## Do Not Operate Unless:

- You learn and practice the principles of safe machine operation contained in this operator's manual.

- 1 Avoid hazardous situations.
- 2 Always perform a pre-operation inspection.

### **3 Always perform function tests prior to use.**

#### **Know and understand the function tests before going on to the next section.**

- 4 Inspect the workplace.
- 5 Only use the machine as it was intended.

## Fundamentals

The function tests are designed to discover any malfunctions before the machine is put into service. The operator must follow the step-by-step instructions to test all machine functions.

A malfunctioning machine must never be used. If malfunctions are discovered, the machine must be tagged and removed from service. Repairs to the machine may only be made by a qualified service technician, according to the manufacturer's specifications.

After repairs are completed, the operator must perform a pre-operation inspection and function tests again before putting the machine into service.

## Set up

- 1 Position the machine directly below the desired work area.
- 2 Set the parking brake.
- 3 Disconnect the trailer lights, chains and surge brake safety cable from the vehicle.
- 4 Open the latch on the ball coupler.
- 5 Pull the jack release handle and rotate the tongue jack to the lifting position.
- 6 Raise the tongue by turning the jack handle.
- 7 Open all boom hold-down latches.
- 8 Release the jib hold-down straps (if equipped).

## FUNCTION TESTS

**Note:** Perform the appropriate function tests for your control system. Determine whether the control panels on your machine match the ones below or the ones on page 22. Follow the step-by-step instructions below the pictures to test all machine functions.

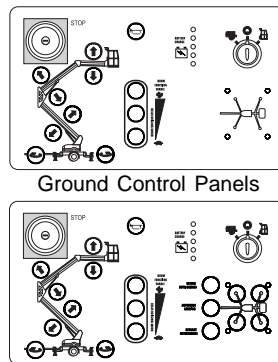
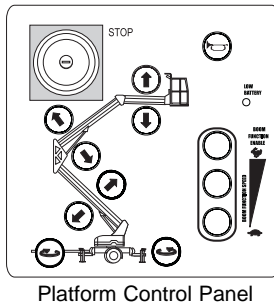

## At the Ground Controls

- 1 Insert the key and turn to ground control.
- 2 Pull out the red Emergency Stop buttons at the ground and platform controls.

- ⦿ Machines with LED diagnostic readout: LED should read ----.

**Note:** Machines with LED diagnostic readout perform a self-check when the power is turned on. The self-check takes about 5 seconds. Do not touch the buttons of the ground control panel until the self-check is done.

- 3 **Models with manual outriggers:** Select an outrigger. Maintain a firm grasp on the outrigger. Pull the outrigger release handle and lower the outrigger. Be sure the outrigger lock pin is locked. Repeat the procedure for each of the remaining outriggers.

Adjust the outriggers to level the machine and raise the wheels slightly off the ground. Level the machine using only the leveling jacks.

**Models with hydraulic outriggers:** Push and hold the auto-level button. Push and hold the extend outrigger button. The outriggers will lower and adjust to level the machine and raise the wheels slightly off the ground. Level the machine using only the outriggers.

- 4 Check the interlock display lights at the ground controls and on the turntable. Confirm that all four lights are on.

**Note:** If any interlock display light is flashing, the machine is not level. Adjust the leveling jacks or use the individual outrigger buttons to level the machine.

### Test Emergency Stop

- 5 Push in the ground red Emergency Stop button to the off position.
  - ⦿ **Result:** The power will shut off and all ground and platform control functions should not operate.
- 6 Pull out the red Emergency Stop button to the on position.

### Test Outrigger Interlock

- 7 Unscrew one leveling jack or use the leveling buttons to raise one outrigger until the corresponding interlock display light turns off.
  - ⦿ **Result:** Boom functions should not operate.
- 8 Return the leveling jack to the previous setting or use the leveling buttons to lower the outrigger.
- 9 Repeat the procedure for each outrigger.

## FUNCTION TESTS

**Test the Boom Functions**

- 10 Do not hold a function enable/speed select button. Attempt to activate each boom function button.
- ⦿ Result: All boom functions should not operate.
- 11 Press and hold a function enable/speed select button. Activate each boom function button.
- ⦿ Result: All boom functions should operate through a full cycle.

**Test the Tilt Sensor**

- 12 Raise the jib boom approximately 6 in / 15 cm. Raise the primary boom approximately 6 in / 15 cm off the boom rest. Raise the secondary boom approximately 6 in / 15 cm off the boom rest.

- 13 Locate the tilt sensor on the chassis near the ground controls.

- 14 Press down one side of the tilt sensor and place the tilt sensor test tool under one of the posts.

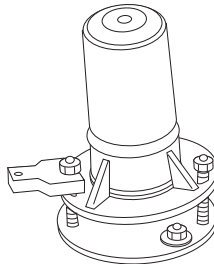

- ⦿ Result: The alarm, located in the platform, should sound after 1 second. The interlock display light should flash.
- 15 Test all ground and platform control functions.
- ⦿ Result: The primary boom up, the secondary boom up and the jib boom up functions should not operate. The primary boom down, the secondary boom down, the jib boom down and the turntable rotate functions should operate normally.
- 16 Remove the tilt sensor test tool.
- 17 Turn the key switch to platform control.

**At the Platform Controls**

- 18 Pull out the red Emergency Stop buttons at the ground and platform controls.

**Test Emergency Stop**

- 19 Push in the platform red Emergency Stop button to the off position.
- ⦿ Result: The power will shut off and all platform control functions should not operate.

**Test the Horn**

- 20 Pull out the red Emergency Stop button to the on position.
- 21 Push the horn button.
- ⦿ Result: The horn should sound.

**Test Machine Functions**

- 22 Do not hold a function enable/speed select button. Attempt to activate each boom function button.
- ⦿ Result: All boom functions should not operate.
- 23 Press and hold a function enable/speed select button.
- 24 Activate each boom function button.
- ⦿ Result: All boom functions should operate through a full cycle.

## FUNCTION TESTS

**Note:** Perform the appropriate function tests for your control system. Determine whether the control panels on your machine match the ones below or the ones on page 20. Follow the step-by-step instructions below the pictures to test all machine functions

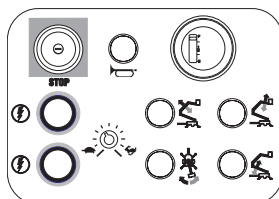

Platform Control Panel

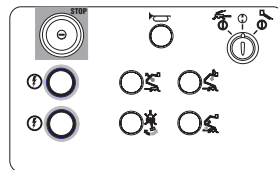

Ground Control Panels

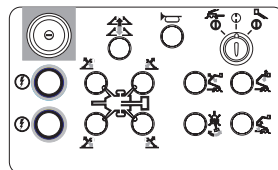

## At the Ground Controls

- 1 Insert the key and turn to ground control.
- 2 Pull out the red Emergency Stop buttons at the ground and platform controls.
- 3 **Models with manual outriggers:** Select an outrigger. Maintain a firm grasp on the outrigger. Pull the outrigger release handle and lower the outrigger. Be sure the outrigger lock pin is locked. Repeat the procedure for each of the remaining outriggers.

Adjust the outriggers to level the machine and raise the wheels slightly off the ground. Level the machine using only the outriggers. Use the bubble level to make sure the machine is level.

**Models with hydraulic outriggers:** Push and hold the yellow function enable button. Push and hold the auto level button or the individual outrigger buttons to lower the outriggers and level the machine. Level the machine using only the outriggers. Use the bubble level to make sure the machine is level.

## Test Emergency Stop

- 4 Push in the ground red Emergency Stop button to the off position.
- ⑥ Result: All ground and platform control functions should not operate.
- 5 Pull out the red Emergency Stop button to the on position.

## Test Outrigger Interlock

- 6 Unscrew one leveling jack or use the leveling buttons to raise one outrigger off the ground.
- ⑥ Result: All boom functions should not operate.
- 7 Return the leveling jack to the previous setting or use the leveling buttons to lower the outrigger.
- 8 Repeat the procedure for each outrigger.

## Test the Boom Functions

- 9 Do not push a function enable button. Attempt to activate each boom function button.
- ⑥ Result: All boom functions should not operate.
- 10 Push and hold the blue function enable button. Activate each boom function button.
- ⑥ Result: Primary boom up, primary boom extend, secondary boom up and turntable rotate right should all function.
- 11 Push and hold the yellow function enable button. Activate each boom function button.
- ⑥ Result: Primary boom down, primary boom retract, secondary boom down and turntable rotate left should all function.



## FUNCTION TESTS

**Test the Tilt Sensor**

12 Raise the jib boom approximately 6 in / 15 cm. Raise the primary boom approximately 6 in / 15 cm off the boom rest. Raise the secondary boom approximately 6 in / 15 cm off the boom rest.

13 Locate the tilt sensor on the chassis near the ground controls.

14 Press down one side of the tilt sensor and place the tilt sensor test tool under one of the posts.

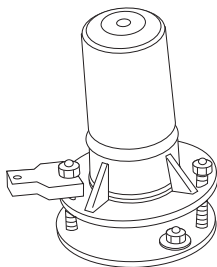

☉ Result: The alarm, located in the platform, should sound after 1 second.

15 Test all ground and platform control functions.

☉ Result: The primary boom up, the secondary boom up and the jib boom up functions should not operate. The primary boom down, the secondary boom down, the jib boom down and the turntable rotate functions should operate normally.

16 Remove the tilt sensor test tool.

17 Turn the key switch to platform control.

**At the Platform Controls**

18 Pull out the platform red Emergency Stop button to the on position.

**Test Emergency Stop**

19 Push in the platform red Emergency Stop button to the off position.

☉ Result: All ground and platform control functions should not operate.

**Test the Horn**

20 Pull out the red Emergency Stop button to the on position.

21 Push the horn button.

☉ Result: The horn should sound.

**Test Boom Functions and Function Enable**

22 Do not push a function enable button. Attempt to activate each boom function button.

☉ Result: All boom functions should not operate.

23 Push and hold the blue function enable button. Activate each boom function button.

☉ Result: Primary boom up, secondary boom up, jib boom up and turntable rotate right should all function.

24 Push and hold the yellow function enable button. Activate each boom function button.

☉ Result: Primary boom down, secondary boom down, jib boom down and turntable rotate left should all function.

# Workplace Inspection



---

## Do Not Operate Unless:

- You learn and practice the principles of safe machine operation contained in this operator's manual.

- 1 Avoid hazardous situations.
- 2 Always perform a pre-operation inspection.
- 3 Always perform function tests prior to use.

### 4 Inspect the workplace.

**Know and understand the work place inspection before going on to the next section.**

- 5 Only use the machine as it was intended.

## Fundamentals

The workplace inspection helps the operator determine if the workplace is suitable for safe machine operation. It should be performed by the operator prior to moving the machine to the workplace.

It is the operator's responsibility to read and remember the workplace hazards, then watch for and avoid them while moving, setting up and operating the machine.

## Workplace Inspection

Be aware of and avoid the following hazardous situations:

- drop-offs or holes
- bumps, floor obstructions or debris
- slopes that exceed the machine's leveling capability
- unstable or slippery surfaces
- overhead obstructions and high voltage conductors
- hazardous locations
- inadequate surface support to withstand all load forces imposed by the machine
- wind and weather conditions
- the presence of unauthorized personnel
- other possible unsafe conditions

# Operating Instructions



---

## Do Not Operate Unless:

- You learn and practice the principles of safe machine operation contained in this operator's manual.
  - 1 Avoid hazardous situations.
  - 2 Always perform a pre-operation inspection.
  - 3 Always perform function tests prior to use.
  - 4 Inspect the workplace.
  - 5 Only use the machine as it was intended.**

## Fundamentals

The Operating Instructions section provides instructions for each aspect of machine operation. It is the operator's responsibility to follow all the safety rules and instructions in the operator's, safety and responsibilities manuals.

Using the machine for anything other than lifting personnel, along with their tools and materials, to an aerial work site is unsafe and dangerous.

Only trained and authorized personnel should be permitted to operate a machine. If more than one operator is expected to use a machine at different times in the same work shift, they must all be qualified operators and are all expected to follow all safety rules and instructions in the operator's, safety and responsibilities manuals. That means every new operator should perform a pre-operation inspection, function tests, and a workplace inspection before using the machine.

## OPERATING INSTRUCTIONS

## Emergency Stop

Push in the red Emergency Stop button to the off position at the ground controls or the platform controls to stop all machine functions.

Repair any function that operates when either red Emergency Stop button is pushed in.

## Set up

- 1 Position the machine directly below the desired work area.
- 2 Set the parking brake.
- 3 Disconnect the trailer lights, chains and surge brake safety cable from the vehicle.
- 4 Open the latch on the ball coupler.
- 5 Pull the jack release handle and rotate the tongue jack to the lifting position.
- 6 Raise the tongue by turning the jack handle.
- 7 Open all boom hold-down latches.
- 8 Release the jib hold-down straps (if equipped).
- 9 Lower the outriggers and adjust to level the machine and raise the wheels slightly off the ground.
- 10 **If equipped:** Be sure that all four interlock display lights are on at the ground control panel and on the turntable.
- 11 **If equipped:** Check the bubble level to make sure the machine is level.

## Operation from Ground

- 1 Turn the key switch to ground control.
- 2 Pull out both ground and platform red Emergency Stop buttons to the on position.
- 3 Be sure the batteries are connected before operating the machine.

### To Position Platform

- 1 Press and hold a function enable button.
- 2 Press the appropriate boom function button according to markings on the control panel.

## Operation from Platform

- 1 Turn the key switch to platform control.
- 2 Pull out both ground and platform red Emergency Stop buttons to the on position.
- 3 Be sure that the batteries are connected before operating machine.

### To Position Platform

- 1 Press and hold a function enable button.
- 2 Press the appropriate boom function button according to markings on the control panel.
- 3 If equipped: Rotate the platform by turning the hand crank in either a clockwise or counterclockwise direction.

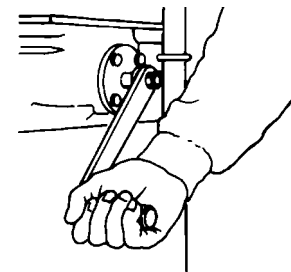

## OPERATING INSTRUCTIONS

## Manual Lowering

- 1 Open the power unit side turntable cover and locate the manual override valve.
- 2 Push and turn the brass knob clockwise to open the valve. The individual boom manual lowering valves will not function until this valve is open.
- 3 Locate the manual lowering valve at the base of the secondary boom cylinder and push the override knob until the secondary boom is fully lowered.
- 4 Locate the manual lowering valve at the base of the primary boom cylinder and push the override knob until the primary boom is fully lowered.
- 5 Locate the manual lowering valve at the base of the jib boom cylinder and push the override knob until the jib boom is fully lowered.
- 6 To operate the machine, push and turn counterclockwise to close the override valve.

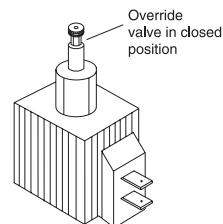
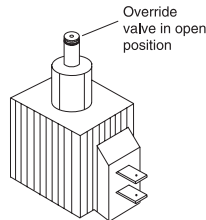

## Manual Turntable Rotation

- 1 Open the power unit side turntable cover.
- 2 Turn the override knob on the manifold in the counterclockwise direction.
- 3 Push the turntable in the desired direction.
- 4 Turn the override knob on the manifold in the clockwise direction to operate the machine.

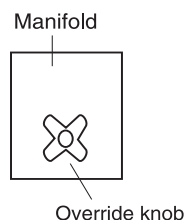

## Fall Protection

Personal fall protection equipment (PFPE) is required when operating this machine.

All PFPE must comply with applicable governmental regulations, and must be inspected and used in accordance with the PFPE manufacturer's instructions.

## Transport

- 1 Set the parking brake.
- 2 Secure the boom with the hold-down latches.
- 3 Attach the jib hold-down straps and latch properly (if equipped).
- 4 Raise the tongue by turning the jack handle.
- 5 Position the ball of the transport vehicle directly under the ball coupler.
- 6 Open the latch on the ball coupler.
- 7 Lower the tongue by turning the jack handle.
- 8 Close the latch on the ball coupler.
- 9 Attach the safety chains (if required) and the brake safety cable to the vehicle.
- 10 Pull the jack release handle and rotate the tongue jack to the stowed position.
- 11 Connect and test the trailer lights.
- 12 Release the parking brake.

## OPERATING INSTRUCTIONS

## Towing Information

Use the checklist provided on the back cover of this manual before towing and while on the road.

### **Driving a vehicle/trailer combination is different from driving a vehicle alone.**

Anticipate stops. Brake early.

Increase the distance between your vehicle and the vehicle in front of you to twice the normal following distance when towing a trailer. Allow more following distance in adverse weather.

Slow down for downgrades and shift your transmission into a lower gear.

Slow down for curves, adverse weather, hazardous road conditions and expressway exits.

Your vehicle/trailer combination may experience momentary disturbances. If a disturbance happens, do not brake, speed up or turn the steering wheel. Let off the gas pedal and keep the steering wheel in a straight ahead position, sufficient to maintain the lane of travel.

If the combination travels off the paved roadway, hold the steering wheel firmly. Let off the gas pedal. Do not apply your brakes. Do not turn sharply. Slow down below 25 mph / 40 km/h. Then gradually turn the steering wheel to get back on the roadway. Proceed with caution when entering traffic.

Set all tires to the proper pressure. Find the recommended cold pressures on the tire sidewall, owner's manual or on the trailer decal. Do not put more pressure in the tire than is on the tire sidewall. Tire pressures go up during driving. Do not let off this extra pressure.

When passing other vehicles, be sure to leave enough room for the extra length of the trailer. You will need to go much farther beyond the passed vehicle before you can return to your lane.

When turning with a trailer, avoid jerky or sudden movements.

Inspect all connections at each stop. Use the checklist provided on the back cover of this manual.

## Moving Machine Without a Tow Vehicle

Do not attempt to manually move a machine unless it is on a firm, level surface. Use the parking brake to control the speed of the machine while moving it.

## Backing Up with Trailer (if equipped with surge brake)

Surge brake systems are optional equipment on the Genie TMZ. If your machine is equipped with a surge brake, the system must be released before backing up.

Consult the surge brake system manual for specific instructions on each surge brake.

Be sure that the machine is returned to towing or operating configuration when finished.

## OPERATING INSTRUCTIONS

**After Each Use**

- 1 Select a safe parking location—firm level surface, clear of obstruction and traffic.
- 2 Rotate the turntable so that the platform is opposite the tongue of the machine.
- 3 Use the black arrows to properly align the turntable.
- 4 Lower the boom to the stowed position.
- 5 Secure the boom with the hold-down latches.
- 6 Turn the key switch to the off position and remove the key to secure from unauthorized use.
- 7 Chock the wheels.
- 8 Charge the batteries.

## OPERATING INSTRUCTIONS



## Material Lifting Configuration

---

### Observe and Obey:

- Maintain safe distances between the operator, the machine and fixed objects.
- Be aware of the direction the boom will travel when using the platform controls.

## Material Lifting Configuration Set up

- 1 Turn the key switch to the off position.
- 2 Remove the pin that secures the material lifting hook to the base. Remove the material lifting hook and replace the pin.
- 3 Disconnect the running lights and the platform controls from the platform.
- 4 Remove the platform controls. Open the clamp on the back of the platform controls and slide the controls up and off.
- 5 Open the controls side turntable cover.
- 6 Disconnect the electrical cord on the bottom right side of the ground control box. Connect the platform control cord disconnected in step 3 to the ground control box. Close the turntable cover.
- 7 Support the platform. Remove the toggle pin that secures the platform to the jib boom.
- 8 Lift the platform up and remove it from the machine.
- 9 To install the material lifting hook, insert the bottom rail into the platform mounting bracket and rotate up into position. Insert the toggle pin.
- 10 Operate the material lifting hook from the ground with the platform controls. The key switch should be turned to the platform control position.
- 11 Reverse the above process to install the platform and return the machine to a personnel lifting configuration.



## OPERATING INSTRUCTIONS



## Battery and Charger Instructions

### Observe and Obey:

- Do not use external charger or booster battery.
- Charge battery in a well-ventilated area.
- Use proper AC input voltage for charging as indicated on charger.
- Use only Genie authorized battery and charger.

## To Charge Battery

- 1 Be sure the batteries are connected before charging the batteries.
- 2 Open the turntable covers. The covers should remain open for the entire charging cycle.
- 3 Remove the battery vent caps and check the battery acid level. If necessary, add only enough distilled water to cover the plates. Do not overfill prior to the charge cycle.
- 4 Replace the battery vent caps.
- 5 Connect the battery charger to a grounded AC circuit.
- 6 Turn the battery charger on.
- 7 The charger will indicate when the battery is fully charged.
- 8 Check the battery acid level when the charging cycle is complete. Replenish with distilled water to the bottom of the fill tube. Do not overfill.

## Dry Battery Filling and Charging Instructions

- 1 Remove the battery vent caps and permanently remove the plastic seal from the battery vent openings.
- 2 Fill each cell with battery acid (electrolyte) until the level is sufficient to cover the plates.

Do not fill to maximum level until the battery charge cycle is complete. Overfilling can cause the battery acid to overflow during charging. Neutralize battery acid spills with baking soda and water.

- 3 Install the battery vent caps.
- 4 Charge the battery.
- 5 Check the battery acid level when the charging cycle is complete. Replenish with distilled water to the bottom of the fill tube. Do not overfill.

## Voltage Conversion

Some battery chargers are equipped with a multifunction fuse, which enables the operator to switch between 110-120 volts and 220-240 volts.

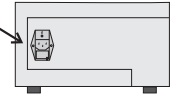
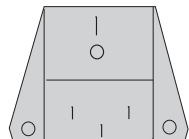
- 1 Locate the fuse drawer module on the front of the battery charger. 
- 2 To change voltage, pull the fuse drawer out, flip it over so the desired voltage range reads right side up, and return the drawer to the slot.
- 3 Check that the triangle next to the desired voltage range points to the triangle printed on the lip of the module. 

# Decals

## Decal Inspection

Use the pictures on the next page to verify that all decals are legible and in place.

Below is a numerical list with quantities and descriptions.

Part No.	Description	Quantity
27564	Danger - Electrocution Hazard	2
28157	Label - Dexron	1
28161	Warning - Crushing Hazard (Models with manual outriggers)	4
28161	Warning - Crushing Hazard (Models with hydraulic outriggers)	12
28164	Notice - Hazardous Materials	1
28171	Label - No Smoking	1
28174	Label - Power to Platform, 230V	2
28175	Caution - Compartment Access	1
28176	Notice - Missing Manuals	1
28235	Label - Power to Platform, 115V	2
28236	Warning - Failure To Read . . .	1
31060	Danger - Do not alter limit switch	1
35579	Notice - Max Cap, Hook, 500 lbs / 227 kg	1
37052	Notice - Max Cap, 500 lbs / 227 kg	1
37145	Label - Manual Lowering	4
40434	Label - Lanyard Anchorage	2
43658	Notice - Power to Battery Charger, 230V	1
44248	Notice - Max Cap, 440 lbs / 200kg	1
44980	Notice - Power to Battery Charger, 115V	1
44981	Label - Air Line to Platform	2
44986	Notice - Side Force, 90 lbs/400N (CE)	1
48719	Danger - General Safety, Platform	1
48723	Label - Parking Brake (Surge)	1
48726	Notice - Battery Charger Operating Instr.	1
48727	Danger - Battery/Charger Safety	1
48733	Danger - Tip-over (batteries)	1
48734	Battery Connection Diagram	1
49918	Notice - Material Lifting Operation	1

Part No.	Description	Quantity
52004	Label - Interlock Display Lights	2
52008	Danger - General Safety, Ground	1
52475	Label - Transport Tie-down	4
52496	Notice - Manual Rotation Instructions	1
52557	Label - Parking Brake (Mechanical)	1
62066	Cosmetic, Genie TMZ-34/19	2
62707	Warning - Towing Hazard	2
62719	Label - Arrow	2
62722	Notice - Max Cap, Hook, 440 lbs / 200 kg	1
65056	Label - Water Line to Platform	2
65066	Ground Control Panel Patch (Non-English panels only)	1
65067	Platform Control Panel Patch (Non-English panels only)	1
65068	Ground Control Panel Patch (Non-English panels only)	1
65303	Notice - Manual Lowering Instructions	1
65305	Notice - Operating Instructions, Platform	1
65307	Caution - Forklift Pockets	2
65309	Notice - Side Force, 90 lbs / 400 N	1
72899	Decal - Warning, Transport Instructions	1
72897	Notice - Tire Specifications, ANSI & CSA	2
72901	Notice - Operating Instructions, Ground	1
72908	Notice - Tire Specifications, CE	2
72971	Label, Transport to Canada	2
76095	Ground Control Panel	1
76096	Ground Control Panel (Auto-leveling)	1
76097	Platform Control Panel	1
82228	Label - Fault Codes	1
82232	Label - LED Readout	1
97777	Platform Control Panel	1
97778	Ground Control Panel	1
97814	Ground Control Panel (Auto-leveling)	1
97846	Notice - Operating Instructions, Platform	1
97847	Notice - Operating Instructions, Ground	1

DECALS

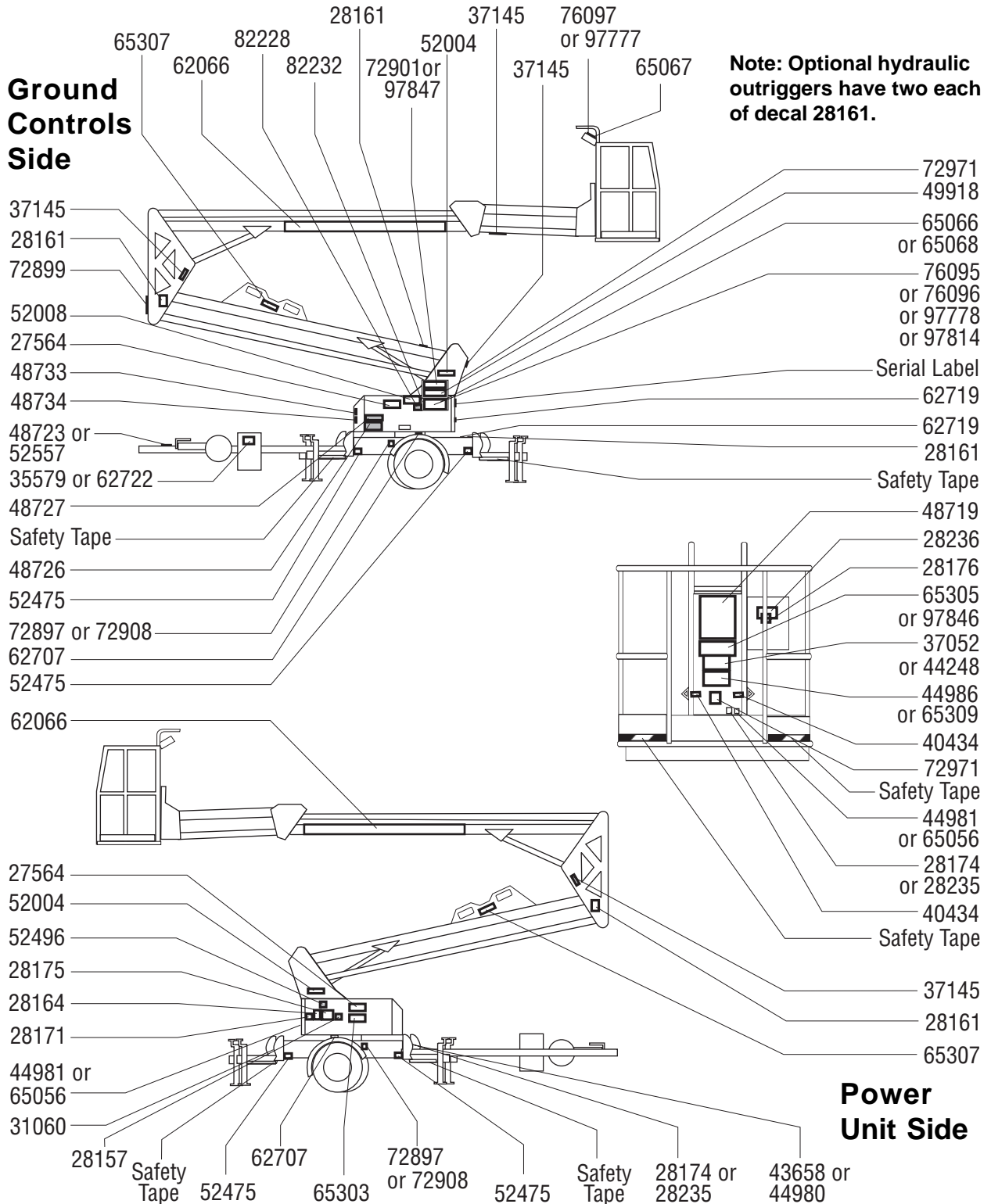

# Specifications

Height, working maximum	40 ft 12.2 m	Ground clearance	7 <sup>1</sup> / <sub>2</sub> in 19 cm
Height, platform maximum	34 ft 10.4 m	Hydraulic tank capacity	2.0 gallons 7.6 liters
Height, stowed maximum	6 ft 5 <sup>1</sup> / <sub>2</sub> in 1.97 m	Weight (Machine weights vary with option configurations)	See Serial Label
Horizontal reach maximum from centerline of machine	19 ft 9 in 6.0 m	Maximum towing speed	60 mph 97 km/h
Outrigger footprint (w x l)	10 ft x 11 ft 3.05 x 3.35 m	Maximum tongue weight ANSI & CSA	165 lbs 75 kg
Maximum load capacity ANSI & CE models	500 lbs 227 kg	Maximum tongue weight CE	220 lbs 100 kg
Maximum load capacity - CSA models & models with Optional Platform Rotate	440 lbs 200 kg	Airborne noise emissions Maximum sound level at normal operating workstations (A-weighted)	70 dB
Width	59 <sup>1</sup> / <sub>2</sub> in 151 cm	<b>Continuous improvement of our products is a Genie policy. Product specifications are subject to change without notice or obligation.</b>	
Length, stowed	19 ft 8 in 5.9 m		
Length, stowed (with mechanical or combination hitch)	20 ft 8 in 6.2 m		
Turntable rotation	358 degrees		
Power source	4 Group-GC2, 6V 225AH Batteries		
Platform dimensions, (length x width)	48 in x 30 in 122 cm x 76 cm		
Platform leveling	self-leveling		
AC outlet in platform	standard		
Tire size ANSI & CSA models	ST195/75D14 Load Range D		
Tire size CE models	195/65R15 91T		

---

# Reporting Safety Defects

**Genie Industries**  
**PO Box 97030**  
**Redmond, WA 98073-9730**

## Reporting Safety Defects

If you believe that your vehicle has a defect which could cause a crash or could cause injury or death, you should immediately inform the National Highway Traffic Safety Administration (NHTSA) in addition to Genie Industries.

If NHTSA receives similar complaints, it may open an investigation, and if it finds that a safety defect exists in a group of vehicles, it may order a recall and remedy campaign. However, NHTSA cannot become involved in any individual problems between you, your dealer or Genie Industries.

To contact NHTSA you may either call the Auto Safety Hotline toll-free at 1-800-424-9393 (366-0123 in Washington DC area) or write to:

**NHTSA**  
**U.S. Department of Transportation**  
**400 7th Street SW, (NSA-11)**  
**Washington DC 20590**

You can also obtain information about motor vehicle safety from the Hotline.

## Free Manuals Download Website

<http://myh66.com>

<http://usermanuals.us>

<http://www.somanuals.com>

<http://www.4manuals.cc>

<http://www.manual-lib.com>

<http://www.404manual.com>

<http://www.luxmanual.com>

<http://aubethermostatmanual.com>

Golf course search by state

<http://golfingnear.com>

Email search by domain

<http://emailbydomain.com>

Auto manuals search

<http://auto.somanuals.com>

TV manuals search

<http://tv.somanuals.com>