

Triplex Ceramic  
Plunger Pump  
Operating Instructions/  
Repair and Service  
Manual

# Model LP200, LP250 & LP250W-MT

---

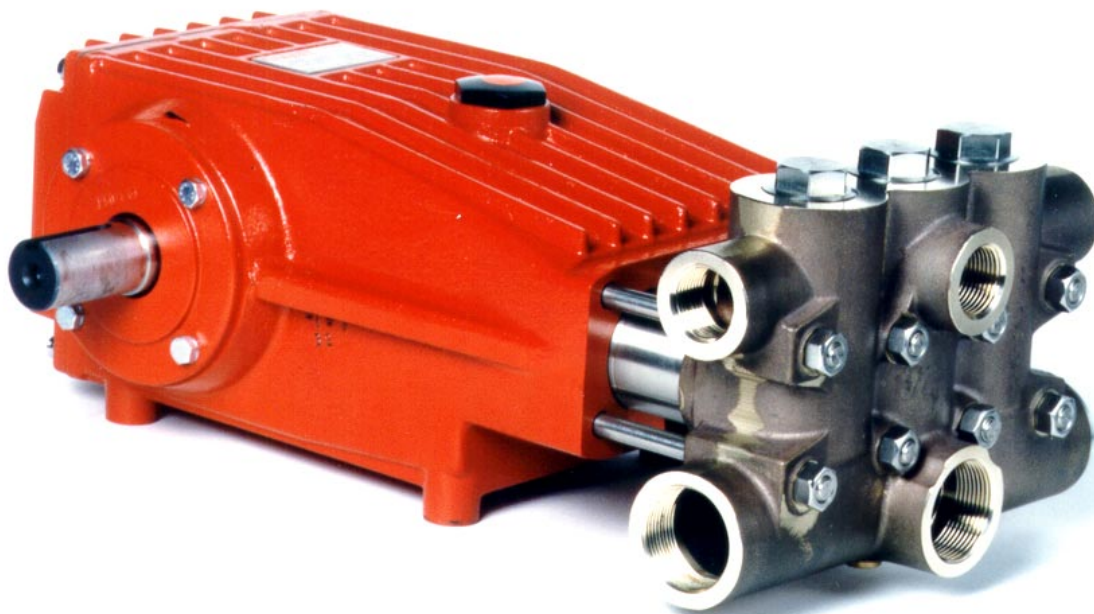

---

**GIANT**

Updated 5/02

**Contents:**

Installation Instructions:	page 2
LP200 Specifications:	page 3
Exploded View / Kits:	page 4
Parts List:	page 5
LP250/LP250W-MT Specifications:	page 6
Repair Instructions:	page 7-9
Torque Specifications:	page 9
Pump Mounting Selection Guide:	page 9
Trouble Shooting:	page 10
Recommended Spare Parts List:	page 10
Dimensions:	page 11
Warranty Information:	back page

# INSTALLATION INSTRUCTIONS

Installation of the Giant Industries, Inc., pump is not a complicated procedure, but there are some basic steps common to all pumps. The following information is to be considered as a general outline for installation. If you have unique requirements, please contact Giant Industries, Inc. or your local distributor for assistance.

1. The pump should be installed flat on a base to a maximum of a 15 degree angle of inclination to ensure optimum lubrication.
2. The inlet to the pump should be sized for the flow rate of the pump with no unnecessary restrictions that can cause cavitation. Teflon tape should be used to seal all joints. If pumps are to be operated at temperatures in excess of 140° F, it is important to insure a positive head to the pump to prevent cavitation.
3. The discharge plumbing from the pump should be properly sized to the flow rate to prevent line pressure loss to the work area. It is essential to provide a safety bypass valve between the pump and the work area to protect the pump from pressure spikes in the event of a blockage or the use of a shut-off gun.

4. Use of a dampener is necessary to minimize pulsation at drive elements, plumbing, connections, and other system areas. The use of a dampener with Giant Industries, Inc. pumps is optional, although recommended by Giant Industries, Inc. to further reduce system pulsation. Dampeners can also reduce the severity of pressure spikes that occur in systems using a shut-off gun. A dampener must be positioned downstream from the unloader.

5. Crankshaft rotation on Giant Industries, Inc. pumps should be made in the direction designated by the arrows on the pump crankcase. Reverse rotation may be safely achieved by following a few guidelines available upon request from Giant Industries, Inc. Required horsepower for system operation can be obtained from the charts on pages 3 and 6.

6. Before beginning operation of your pumping system, remember: Check that the crankcase and seal areas have been properly lubricated per recommended schedules. Do not run the pump dry for extended periods of time. Cavitation will result in severe damage. Always remember to check that all plumbing valves are open and that pumped media can flow freely to the inlet of the pump.

Finally, remember that high pressure operation in a pump system has many advantages. But, if it is used carelessly and without regard to its potential hazard, it can cause serious injury.

## IMPORTANT OPERATING CONDITIONS

**Failure to comply with any of these conditions invalidates the warranty.**

1. Prior to initial operation, add oil to the crankcase so that oil level is between the two lines on the oil dipstick. **DO NOT OVERFILL.**

**Use Giant gear lube oil (p/n 1154) or the equivalent SAE 90 Industrial gear oil.**

Crankcase oil should be changed after the first 50 hours of operation, then at regular intervals of 500 hours or less depending on operating conditions.

2. Pump operation must not exceed rated pressure, volume, or RPM. A pressure relief device must be installed in the discharge of the system.

3. Acids, alkalines, or abrasive fluids cannot be pumped unless approval in writing is obtained before operation from Giant Industries, Inc.

4. Run the pump dry approximately 10 seconds to drain the water before exposure to freezing temperatures.

# Specifications

## Model LP200

Volume .....	Up to 19.0 GPM
Discharge Pressure .....	Up to 2900 PSI
Inlet Pressure .....	Up to 90 PSI
Speed .....	Up to 1000 RPM
Plunger Diameter .....	28 mm
Stroke .....	42 mm
Crankcase Oil Capacity .....	100 fl.oz.
Temperature of Pumped Fluids .....	Up to 140 °F
.....	160°F up to 500 RPM
Inlet Port .....	(3) x 1-1/2" BSP
Discharge Port .....	(3) x 1" BSP
Crankshaft Mounting .....	Either Side
Shaft Rotation .....	Top of Pulley Towards Fluid End
Weight .....	116 lbs.
Crankshaft Diameter .....	35 mm

\* Intermittent duty for pump speeds in excess of 805 RPM

### PULLEY INFORMATION

Pulley selection and pump speed are based on a 1725 RPM motor and "B" section belts. When selecting desired GPM, allow for a ±5% tolerance on pumps output due to variations in pulleys, belts and motors among manufacturers.

1. Select GPM required, then select appropriate motor and pump pulley from the same line.
2. The desired pressure is achieved by selecting the correct nozzle size that corresponds with the pump GPM.

### HORSEPOWER INFORMATION

We recommend that a 1.1 service factor be specified when selecting an electric motor as the power source. To compute specific pump horsepower requirements, use the following formula:

$$HP = (GPM \times PSI) / 1440$$

<b>LP200 HORSEPOWER REQUIREMENTS</b>					
RPM	GPM	1000 PSI	1500 PSI	2000 PSI	2900 PSI
500	9.5	6.6	9.9	13.2	19.2
640	12.2	8.5	12.7	16.9	24.6
750	14.3	9.9	14.9	19.8	28.8
805	15.3	10.6	16.0	21.3	30.9
865	16.5	11.4	17.2	22.9	33.2
920	17.5	12.2	18.3	24.3	35.3
1000	19.0	13.2	19.8	26.5	38.4

# Exploded View - LP200, LP250 & LP250W-MT

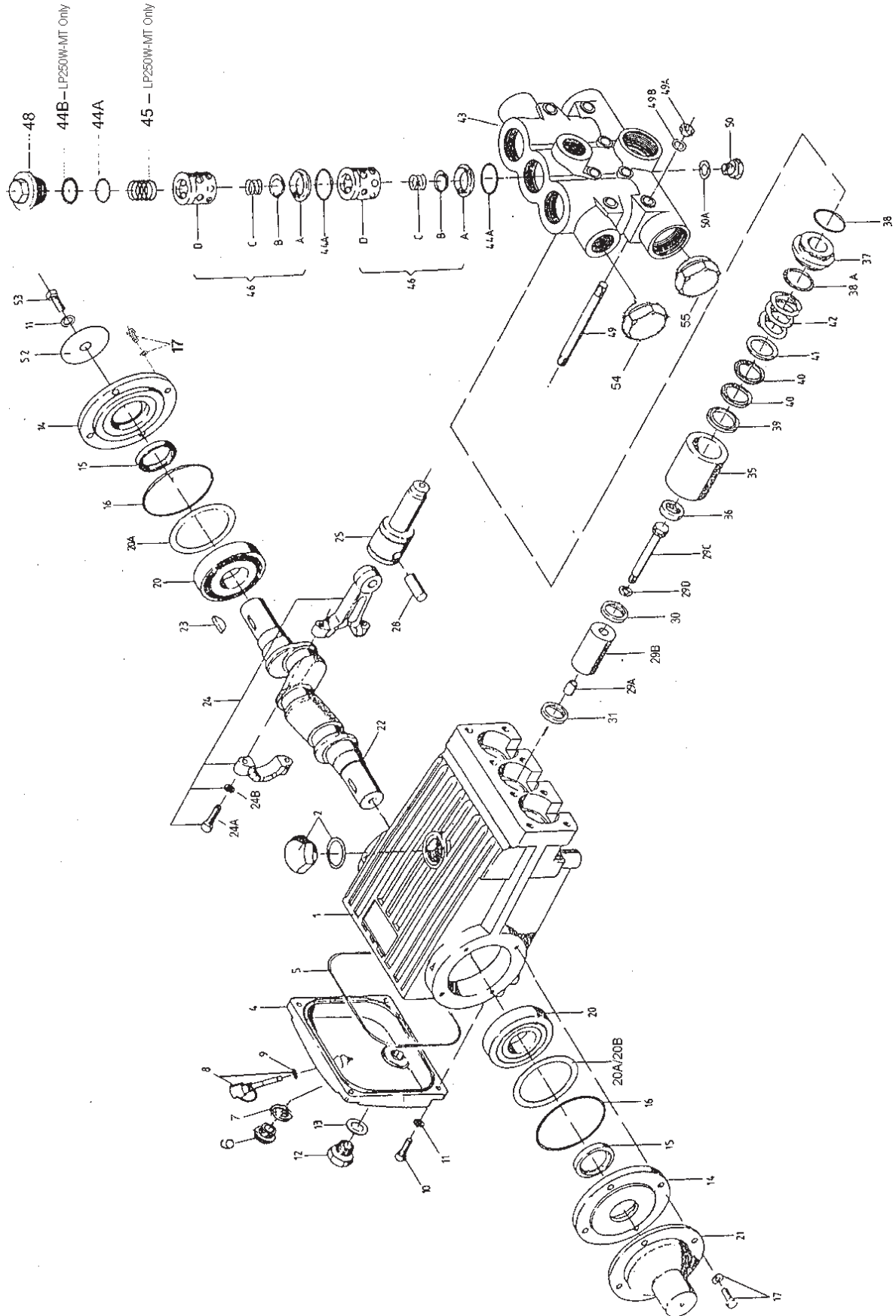

## LP200, LP250 & LP250W-MT PARTS LIST

ITEM	PART	DESCRIPTION	QTY	ITEM	PART	DESCRIPTION	QTY
1	07759	Crankcase	1	36	13360	Grooved Ring (LP250)	3
2	13000	Oil filler Plug Assy.	1	36	13025	Leakage Seal (LP250W-MT)	3
4	06085	Crankcase Cover	1	37	07170	Seal Case	3
5	07104	O-ring, Crankcase Cover	1	38	07140	O-Ring	3
6	07186	Oil Sight Glass	1	38A	12055	O-Ring	3
7	07187	Gasket for Sight Glass	1	39	13197	Pressure Ring (LP200)	3
8	06086	Oil Dipstick Assy	1	39	13026	Pressure Ring (LP250, LP250W-MT)	3
9	01009	O-Ring, Dipstick Assy.	1	40	13115	V-Sleeve (LP200)	6
10	01010	Cylinder Screw	4	40	13027	V-Sleeve (LP250, LP250W-MT)	6
11	01011	Spring Ring	5	41	13198	Support Ring (LP200)	3
12	07109	Plug	1	41	13028	Support Ring (LP250, LP250W-MT)	3
13	07182	Gasket	1	41	06702	Sleeve Support (LP255)	3
14	07111	Bearing Cover	2	42	07173	Tension Spring	3
15	07112	Radial Shaft Seal	2	43	13029	Valve Casing	1
16	07113	O-Ring	2	44A	07150	O-Ring	9
17	07114	Hexagon Screw	8	44B	06266	Support Ring for O-Ring (LP250W-MT only)	3
20	07116	Taper Roller Bearing	2	45	06078	Compression Spring (LP250W-MT)	3
20A	07117	Fitting Disc	1-3	46	07060	Valve Assembly	6
20B	13001	Fitting Disc	1-3	46A	07064	Valve Seat	6
21	07118	Shaft Protector	1	46B	07063	Valve Plate	6
22	13242	Crankshaft	1	46C	07062	Valve Spring	6
23	13243	Woodruff Key	1	46D	07066	Spacer Pipe	6
24	13340	Connecting Rod Assy.	3	48	07156	Plug	3
24A	13227	Hex Screw	3	48	06077	Plug (LP250W-MT)	3
24B	13278	Spring Washer	3	49	07157	Stud bolt	8
25	13341	Crosshead / Plunger Assy.	3	49A	07158	Hexagon Nut	8
28	13232	Crosshead Pin	3	49B	07159	Disc	8
29A	07125	Centering Sleeve	3	50	07423	Plug	1
29B	13220	Plunger Pipe (LP200)	3	50A	07161	Copper Ring	1
29B	13022	Plunger Pipe (LP250, LP250W-MT)	3	52	13020	Disc for Crankshaft	1
29C	07131	Tension Screw	3	53	13021	Hexagon Screw	1
29D	07755	Copper Ring	3	54	13321	Plug, 1" BSP	1
30	07789	Flinger	3	55	13322	Plug 1-1/2" BSP	1
31	07133	Oil Seal	3				
35	13196	Seal Sleeve (LP200)	3				
35	13024	Seal Sleeve (LP250, LP250W-MT)	3				
36	13228	Leakage Seal (LP200)	3				

## LP200, LP250 & LP250W-MT REPAIR KITS

### Plunger Packing Kits

#### LP200 # 9307

Item	Part #	Description	Qty.
36	13228	Leakage Seal	3
38	07140	O-Ring	3
38A	12055	O-Ring	3
40	13115	V-Sleeve	6

#### LP250, LP250W # 9308

Item	Part #	Description	Qty.
36	13360	Grooved Ring	3
38	07140	O-Ring	3
38A	12055	O-Ring	3
40	13027	V-Sleeve	6

#### LP250W-MT

Item	Part #	Description	Qty.
36	13025	Leakage Seal	3
38	07140	O-Ring	3
38A	12055	O-Ring	3
40	13027	V-Sleeve	6

#### # 9308-MT

### Valve Kit

#### # 09196

Item	Part #	Description	Qty.
46A	07064	Valve Seat	1
46B	07063	Valve Plate	1
46C	07062	Valve Spring	1

# Specifications

## Model LP250, LP250W-MT

Volume .....	Up to 26.0 GPM
Discharge Pressure .....	Up to 2200 PSI
Inlet Pressure .....	Up to 90 PSI
Speed .....	Up to 1000 RPM
Plunger Diameter .....	32 mm
Stroke .....	42 mm
Crankcase Oil Capacity .....	100 fl.oz.
Temperature of Pumped Fluids .....	Up to 140 °F
Inlet Port .....	1-1/24" BSP
Discharge Port .....	3 x 1" BSP
Crankshaft Mounting .....	Either Side
Shaft Rotation .....	Top of Pulley Towards Fluid End
Weight .....	110 lbs.
Crankshaft Diameter .....	35 mm

\* Intermittent duty for pump speeds in excess of 805 RPM

### PULLEY INFORMATION

Pulley selection and pump speed are based on a 1725 RPM motor and "B" section belts. When selecting desired GPM, allow for a ±5% tolerance on pumps output due to variations in pulleys, belts and motors among manufacturers.

1. Select GPM required, then select appropriate motor and pump pulley from the same line.
2. The desired pressure is achieved by selecting the correct nozzle size that corresponds with the pump GPM.

### HORSEPOWER INFORMATION

We recommend that a 1.1 service factor be specified when selecting an electric motor as the power source. To compute specific pump horsepower requirements, use the following formula:

$$HP = (GPM \times PSI) / 1440$$

LP250 HORSEPOWER REQUIREMENTS					
RPM	GPM	1000 PSI	1500 PSI	2000 PSI	2200 PSI
500	13.0	9.0	13.5	18.0	19.8
640	16.6	11.5	17.3	23.1	25.4
750	19.5	13.5	20.3	27.1	29.8
805	20.9	14.5	21.8	29.0	31.9
865	22.5	15.6	23.4	31.2	34.3
920	23.9	16.6	24.9	33.2	36.5
1000	26.0	18.0	27.1	36.1	39.7

## LP200, LP250 & LP250W-MT - REPAIR INSTRUCTIONS



1. With a 30mm wrench, remove the (3) plugs (48).



2. Remove the compression spring (45) & o-rings (44A & 44B-LP250W-MT only).



3. Remove the complete valve assembly (46) with valve pullers.

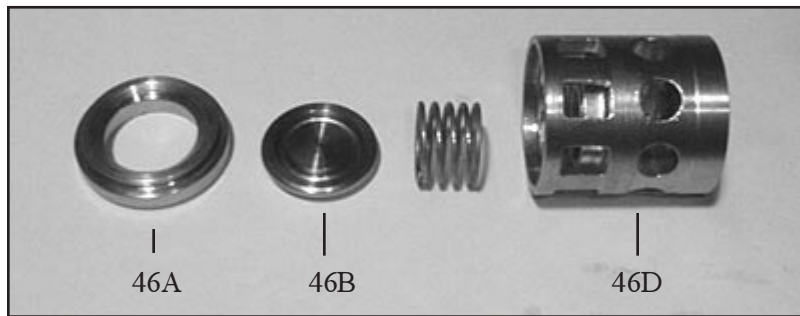

4. Loosen valve seats (46A) from spacer pipe (46D) by lightly hitting the valve plate (46B) with a plastic stick. Check sealing surface and replace worn parts. Reassemble with new o-rings (44A) if possible and oil them before installing. Tighten up tension plugs (48) to 107 ft.-lbs.



5. Loosen the 8 nuts (49A) with a 19mm wrench. Tap the back of the manifold (43) with a rubber mallet to dislodge and slide off the studs (49).



6. Pull seal sleeves (35) out of guides in crankcase (1).

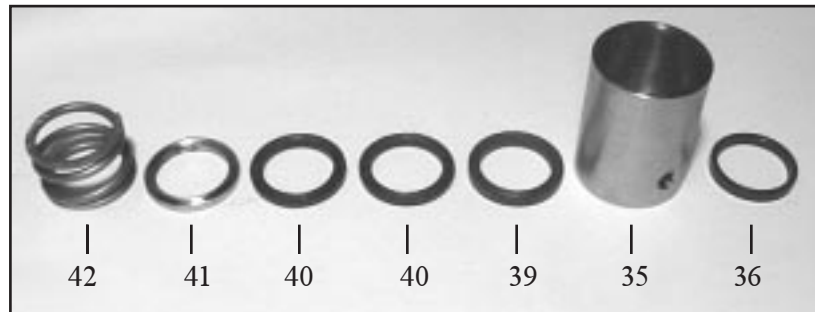

7. Remove the tension spring (42), support ring (41), v-sleeves (40), pressure ring (39), from the seal sleeve (35). Examine seals (36) carefully and replace if worn. Clean all parts.

## LP200, LP250 & LP250W-MT - REPAIR INSTRUCTIONS

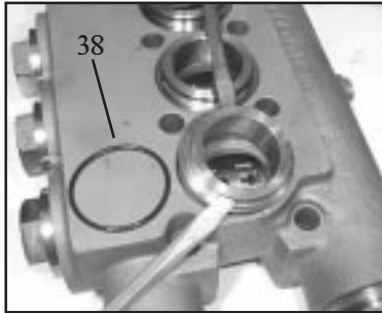

8. Remove seal case (37) from valve casing (43) and inspect o-ring (38).

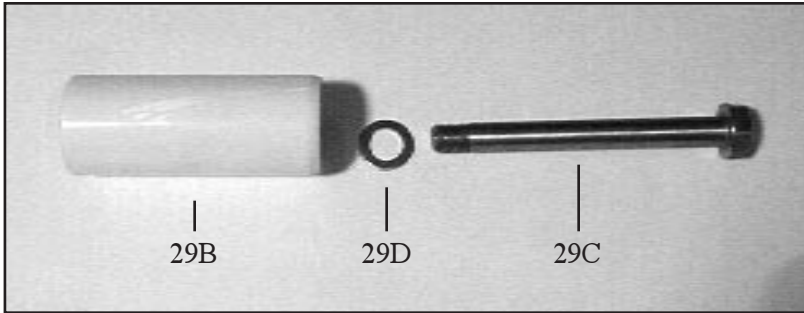

9. Check plunger surface (29B). If plunger pipe is worn out, loosen tension screws (29C) and pull off plunger pipe to the front. Clean front surface of plunger (25) thoroughly. Apply a thin coat of Loctite to the tension screw threads (29C). **Note: Care must be taken that no glue gets between the plunger pipe (29B) and the centering sleeve (29A).** Add new copper ring (29D).



10. Place new plunger pipe (29B) carefully through the oiled seals and push seal sleeve (35) with plunger pipe into the crankcase guide. **Note: Make sure weep hole is facing down.**



11. Tighten the tension screws (29C) to 310 in.-lbs. The plunger pipe (29B) should not be strained by over tightening of the tension screw (29C) or through damage to the front surface of the plunger; otherwise, it will probably break.



12. Place valve vasing (43) over studs and push firmly until seated against the crankcase (1). Tighten the hexagon nuts (49A) in a crosswise pattern (shown below) to 59 ft.-lbs.

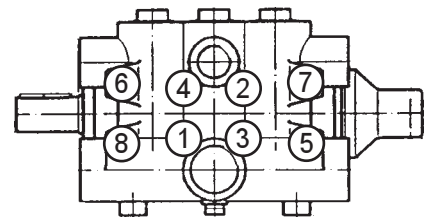



### To Dismantle Gear End

After removing valve casing (43) and plunger pipe (29B), drain oil. Remove gear cover (4) and bearing cover (14). Loosen connecting rod screws (24A) and push the front of the connecting rod (24) forward as far as possible into the crosshead guide.

**IMPORTANT!** Connecting rods (24) are marked for identification. Do not twist connecting rod halves. Connecting rod is to be reinstalled in the same position on shaft journals.

Turning the crankshaft (22) slightly, hit it out carefully to the side with a rubber hammer.

**IMPORTANT!** Do not bend the connecting rod (24) shanks. Check crankshaft (22) and connecting rod (24) surfaces, radial shaft seals (15) and taper roller bearings (20).

### To Reassemble

Using a soft tool, press in the outer bearing ring until the outer edge lines up with the outer edge of the bearing hole. Remove bearing cover (14) together with radial shaft seal (15) and o-ring (16). Fit crankshaft (22) through bearing hole on the opposite side. Press in outer bearing and tighten it inwards with the bearing cover, keeping the crankshaft in vertical position and turning slowly so that the taper rollers of the bearings touch the edge of the outer bearing ring. Adjust axial bearing clearance to at least 0.1mm and maximum 0.15mm by placing fitting discs (20A and 20B) under the bearing cover.

**IMPORTANT!** After assembly has been completed, the crankshaft should turn easily with very little clearance. Tighten connecting rod screws (24A) to 310 in.-lbs.

## LP200, LP250 & LP250W-MT TORQUE SPECIFICATIONS

<u>Position</u>	<u>Item#</u>	<u>Description</u>	<u>Torque Amount</u>
24	13340	Inner Hex Screw, Connecting Rod	310 in.-lbs.
29C	07131	Tension Screw, Plunger	310 in.-lbs.
48	07156	Plug, Discharge	107 ft.-lbs.
49A	07158	Hexagon Nut, Stud Bolts	59 ft.-lbs.

## Pump Mounting Selection Guide

### Bushings

**06496** - 35mm H Bushing

### Pulley & Sheaves

**07165** - 12.75" Cast Iron - 4 gr. - AB Section

### Rails

**07357** - Plated Steel Channel Rails  
(L=11.75"xW1.88"xH=3.00")

## PUMP SYSTEM MALFUNCTION

<u>MALFUNCTION</u>	<u>CAUSE</u>	<u>REMEDY</u>
The Pressure and/or the Delivery Drops	Worn packing seals Broken valve spring Belt slippage Worn or Damaged nozzle Fouled discharge valve Fouled inlet strainer Worn or Damaged hose Worn or Plugged relief valve on pump Cavitation  Unloader	Replace packing seals Replace spring Tighten or Replace belt Replace nozzle Clean valve assembly Clean strainer Repair/Replace hose Clean, Reset, and Replace worn parts Check suction lines on inlet of pump for restrictions Check for proper operation
Water in crankcase	High humidity Worn seals	Reduce oil change interval Replace seals
Noisy Operation	Worn bearings  Cavitation	Replace bearings, Refill crankcase oil with recommended lubricant Check inlet lines for restrictions and/or proper sizing
Rough/Pulsating Operation with Pressure Drop	Worn packing Inlet restriction  Accumulator pressure Unloader Cavitation	Replace packing Check system for stoppage, air leaks, correctly sized inlet plumbing to pump Recharge/Replace accumulator Check for proper operation Check inlet lines for restrictions and/or proper size
Pressure Drop at Gun	Restricted discharge plumbing	Re-size discharge plumbing to flowrate of pump
Excessive Leakage	Worn plungers Worn packing/seals Excessive vacuum Cracked plungers Inlet pressure too high	Replace plungers Adjust or Replace packing seals Reduce suction vacuum Replace plungers Reduce inlet pressure
High Crankcase Temperature	Wrong Grade of oil Improper amount of oil in crankcase	Giant oil is recommended Adjust oil level to proper amount

### Preventative Maintenance Check-List & Recommended Spare Parts List

Check	Daily	Weekly	50hrs	Every 500 hrs	Every 1500 hrs	Every 3000 hrs
Oil Level/Quality	X					
Oil Leaks	X					
Water Leaks	X					
Belts, Pulley		X				
Plumbing		X				
<b>Recommended Spare Parts</b>						
Oil Change (1 Gallon) p/n 1154			X	X		
Oil Seal Kit (1 kit/pump) (See page 5 for kit list)					X	
Valve Spare Parts (1 kit/pump) (See page 5 for kit list)						X

## LP200, LP250 & LP250W-MT DIMENSIONS

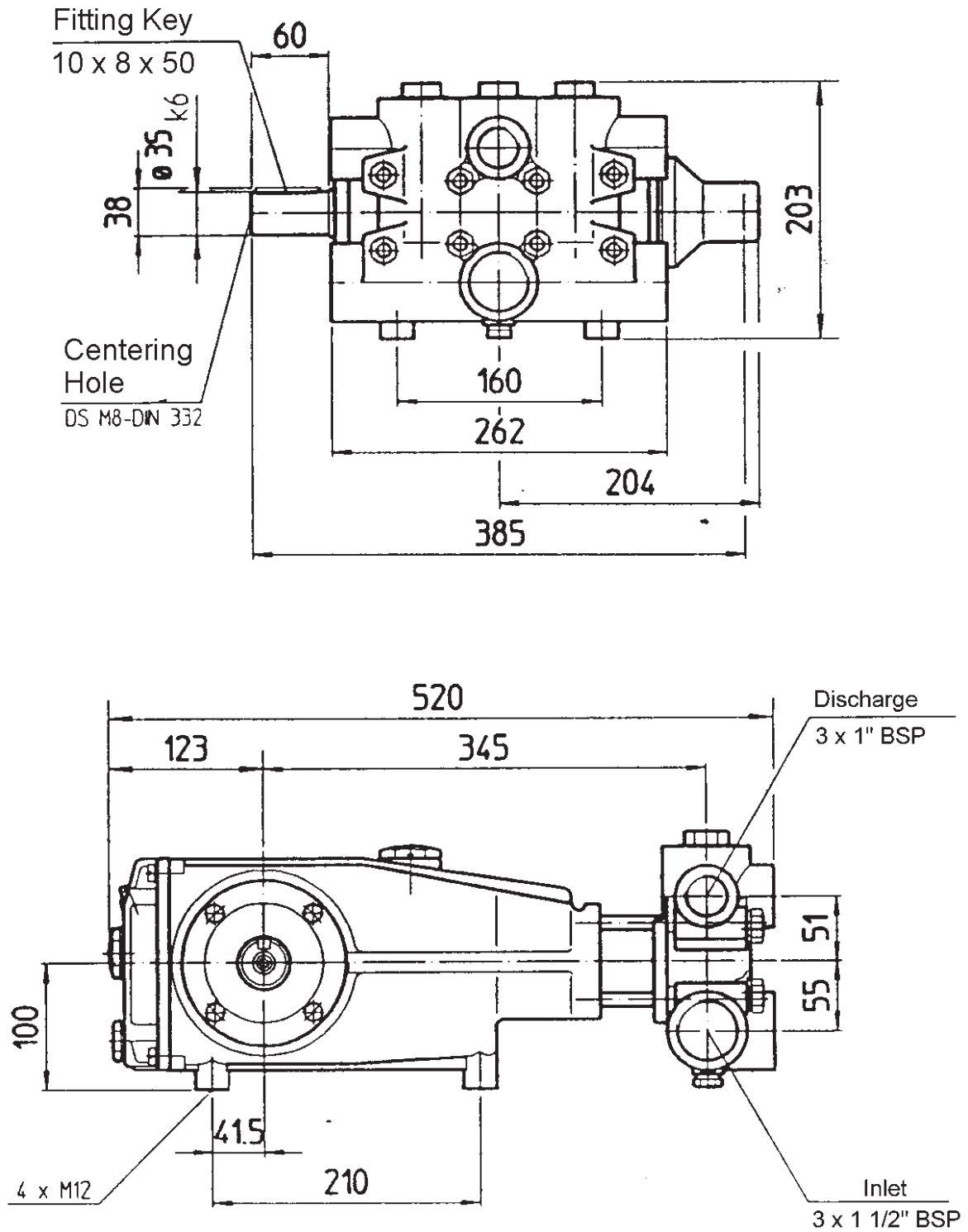

## GIANT INDUSTRIES LIMITED WARRANTY

Giant Industries, Inc. pumps and accessories are warranted by the manufacturer to be free from defects in workmanship and material as follows:

1. For portable pressure washers and car wash applications, the discharge manifolds will never fail, period. If they ever fail, we will replace them free of charge. Our other pump parts, used in portable pressure washers and in car wash applications, are warranted for five years from the date of shipment for all pumps used in NON-SALINE, clean water applications.
2. One (1) year from the date of shipment for all other Giant industrial and consumer pumps.
3. Six (6) months from the date of shipment for all rebuilt pumps.
4. Ninety (90) days from the date of shipment for all Giant accessories.

This warranty is limited to repair or replacement of pumps and accessories of which the manufacturer's evaluation shows were defective at the time of shipment by the manufacturer. The following items are NOT covered or will void the warranty:

1. Defects caused by negligence or fault of the buyer or third party.
2. Normal wear and tear to standard wear parts.
3. Use of repair parts other than those manufactured or authorized by Giant.
4. Improper use of the product as a component part.
5. Changes or modifications made by the customer or third party.
6. The operation of pumps and or accessories exceeding the specifications set forth in the Operations Manuals provided by Giant Industries, Inc.

Liability under this warranty is on all non-wear parts and limited to the replacement or repair of those products returned freight prepaid to Giant Industries which are deemed to be defective due to workmanship or failure of material. A Returned Goods Authorization (R.G.A.) number and completed warranty evaluation form is required prior to the return to Giant Industries of all products under warranty consideration. Call (419)-531-4600 or fax (419)-531-6836 to obtain an R.G.A. number.

Repair or replacement of defective products as provided is the sole and exclusive remedy provided hereunder and the MANUFACTURER SHALL NOT BE LIABLE FOR FURTHER LOSS, DAMAGES, OR EXPENSES, INCLUDING INCIDENTAL AND CONSEQUENTIAL DAMAGES DIRECTLY OR INDIRECTLY ARISING FROM THE SALE OR USE OF THIS PRODUCT.

THE LIMITED WARRANTY SET FORTH HEREIN IS IN LIEU OF ALL OTHER WARRANTIES OR REPRESENTATION, EXPRESS OR IMPLIED, INCLUDING WITHOUT LIMITATION ANY WARRANTIES OR MERCHANTABILITY OR FITNESS FOR A PARTICULAR PURPOSE AND ALL SUCH WARRANTIES ARE HEREBY DISCLAIMED AND EXCLUDED BY THE MANUFACTURER.



GIANT INDUSTRIES, INC., 900 N. Westwood Ave., P.O. Box 3187, Toledo, Ohio 43607  
PHONE (419) 531-4600, FAX (419) 531-6836, [www.giantpumps.com](http://www.giantpumps.com)  
© Copyright 2002 Giant Industries, Inc.

5/02LP200\_250\_250W\_MT.PM6

## Free Manuals Download Website

<http://myh66.com>

<http://usermanuals.us>

<http://www.somanuals.com>

<http://www.4manuals.cc>

<http://www.manual-lib.com>

<http://www.404manual.com>

<http://www.luxmanual.com>

<http://aubethermostatmanual.com>

Golf course search by state

<http://golfingnear.com>

Email search by domain

<http://emailbydomain.com>

Auto manuals search

<http://auto.somanuals.com>

TV manuals search

<http://tv.somanuals.com>