



**When you installing AGP card, please make sure the following notice is fully understood and practiced. If your AGP card has "AGP 4X notch" (show below), please make sure your AGP card is AGP 4X (1.5V).**



**Do not use AGP 2X card (3.3V) in this motherboard. It will burn and damage the motherboard due to Intel® 845 chipset can't support AGP 2X(3.3V).**

Example 1: Diamond Vipper V770 golden finger is compatible with 2X/4X mode AGP slot. It can be switched between AGP 2X(3.3V) or 4X (1.5V) mode by adjusting the jumper. The factory default for this card is 2X(3.3V). If you install this card in GA-8IDML series (or any AGP 4X only) motherboards without switching the jumper to 4X mode (1.5V), it will burn the motherboard.

Example 2: ATi Rage 128 Pro (Power Color) & SiS 305 golden finger is compatible with 2X/4X mode AGP slot, but it supports 2X(3.3V) only. If you install this card in GA-8IDML series (or any AGP 4X only) motherboards, it will burn the motherboard.

Note : Although Gigabyte's AG32S graphics card is based on ATi Rage 128 Pro chip, the design of AG32S is compliance with AGP 4X (1.5V) specification. Therefore, AG32S will work fine with Intel 845 / 850 based motherboards.



- ✍ The author assumes no responsibility for any errors or omissions that may appear in this document nor does the author make a commitment to update the information contained herein.
- ✍ Third-party brands and names are the property of their respective owners.
- ✍ Please do not remove any labels on motherboard, this may void the warranty of this motherboard.
- ✍ Due to rapid change in technology, some of the specifications might be out of date before publication of this booklet.
- ✍ Before you install PCI cards, please remove the Dual BIOS label from PCI slots if there is one.



**WARNING:** Never run the processor without the fan. It will overheat and damage the processor. **PERMANENT DAMAGE WILL OCCUR!**

**Mise en garde:** Ne faites jamais tourner le processeur sans que le dissipateur de chaleur soit correctement installé. **UN DDMYAGE PERMANENT PEUT RÉSULTER.**

**Achtung:** Der Prozessor darf nur in Betrieb genommen werden, wenn der Wärmehaube ordnungsgemäß montiert ist. **SONST KÖNNEN PERMANENTE SCHÄDEN ZUR FOLGE!**

**Advertencia:** Nunca haga funcionar el procesador sin el dissipador de calor instalado correctamente y fijado a la placa. **SE PRODURIRÁN DAÑOS PERMANENTES!**

**Atenção:** Nunca execute o processador sem o dissipador de calor estar adequadamente fixado a placa. **GRANDE DANO PERMAMENTE!**

**注意:** 处理器必须在散热器正确安装并固定到主板上才能运行。否则会导致永久性损坏。

**警告:** 处理器必须在散热器正确安装并固定到主板上才能运行。否则会导致永久性损坏。

**경고:** 이 프로세서가 작동하려면 열 방출기가 올바르게 설치되고 고정되어야 합니다. 그렇지 않으면 영구적인 손상을 입을 수 있습니다.

**警告:** 处理器必须在散热器正确安装并固定到主板上才能运行。否则会导致永久性损坏。

## DECLARATION OF CONFORMITY

Per FCC Part 2 Section 2.1077(a)



**Responsible Party Name: G.B.T. INC. (U.S.A.)**

**Address: 17358 Railroad Street**

**City of Industry, CA 91748**

**Phone/Fax No: (818) 854-9338 / (818) 854-9339**

hereby declares that the product

**Product Name: Motherboard**

**Model Number: GA-8IDML**

Conforms to the following specifications:

FCC Part 15, Subpart B, Section 15.107(a) and Section 15.109(a),  
Class B Digital Device

### **Supplementary Information:**

This device complies with part 15 of the FCC Rules. Operation is subject to the following two conditions: (1) This device may not cause harmful and (2) this device must accept any interference received, including that may cause undesired operation.

Representative Person's Name: ERIC LU

Signature: Eric Lu

Date: July 28, 2001

# Declaration of Conformity

We, Manufacturer/Importer  
(full address)

**G.B.T. Technology Trading GmbH**  
**Ausschlagler Weg 41, 1F, 20537 Hamburg, Germany**

declare that the product  
( description of the apparatus, system, installation to which it refers)

## **Mother Board**

GA-8IDML

is in conformity with

(reference to the specification under which conformity is declared)  
in accordance with 89/336 EEC-EMC Directive

- |   |  |  |  |
|---|--|--|--|
| <input type="checkbox"/> EN 55011   | Limits and methods of measurement of radio disturbance characteristics of industrial, scientific and medical (ISM) high frequency equipment                | <input type="checkbox"/> EN 61000-3-2*<br><input checked="" type="checkbox"/> EN 60555-2         | Disturbances in supply systems cause by household appliances and similar electrical equipment "Harmonics"  |
| <input type="checkbox"/> EN 55013   | Limits and methods of measurement of radio disturbance characteristics of broadcast receivers and associated equipment                                     | <input type="checkbox"/> EN 61000-3-3*<br><input checked="" type="checkbox"/> EN 60555-3         | Disturbances in supply systems cause by household appliances and similar electrical equipment "Voltage fluctuations"                                 |
| <input type="checkbox"/> EN 55014   | Limits and methods of measurement of radio disturbance characteristics of household electrical appliances, portable tools and similar electrical apparatus | <input checked="" type="checkbox"/> EN 50081-1<br><input checked="" type="checkbox"/> EN 50082-1 | Generic emission standard Part 1: Residual commercial and light industry<br>Generic immunity standard Part 1: Residual commercial and light industry |
| <input type="checkbox"/> EN 55015   | Limits and methods of measurement of radio disturbance characteristics of fluorescent lamps and luminaries   | <input type="checkbox"/> EN 55081-2  | Generic emission standard Part 2: Industrial environment   |
| <input type="checkbox"/> EN 55020   | Immunity from radio interference of broadcast receivers and associated equipment   | <input type="checkbox"/> EN 55082-2  | Generic emission standard Part 2: Industrial environment   |
| <input checked="" type="checkbox"/> EN 55022  | Limits and methods of measurement of radio disturbance characteristics of information technology equipment   | <input type="checkbox"/> ENV 55104   | Immunity requirements for household appliances tools and similar apparatus   |
| <input type="checkbox"/> DIN VDE 0855<br><input type="checkbox"/> part 10<br><input type="checkbox"/> part 12 | Cabled distribution systems: Equipment for receiving and/or distribution from sound and television signals   | <input type="checkbox"/> EN50091-2   | EMC requirements for uninterruptible power systems (UPS)   |

CE marking



(EC conformity marking)

**The manufacturer also declares the conformity of above mentioned product with the actual required safety standards in accordance with LVD 73/23 EEC**

- |                                   |   |                                     |
|-----------------------------------|---|-------------------------------------|
| <input type="checkbox"/> EN 60065 | Safety requirements for mains operated electronic and related apparatus for household and similar general use | <input type="checkbox"/> EN 60950   |
| <input type="checkbox"/> EN 60335 | Safety of household and similar electrical appliances   | <input type="checkbox"/> EN 50091-1 |

**Manufacturer/Importer**

(Stamp)

Date : July 28, 2001

Signature: Rex Lin  
Name: Rex Lin

GA-8IDML Series  
P4 Titan-SDRAM Motherboard

# **USER'S MANUAL**

Pentium®4 Processor Motherboard  
Rev. 2.0 Sixth Edition  
12ME-8IDML-2006

## **Table of Content**

Revision History .....	4
Item Checklist .....	4
WARNING! .....	5
Chapter 1 Introduction .....	6
Summary of Features .....	6
GA-8IDML Series Motherboard Layout .....	8
GA-8IDML-LE Motherboard Layout .....	9
Chapter 2 Hardware Installation Process .....	10
Step 1: Install the Central Processing Unit (CPU) .....	11
Step 1-1: CPU Installation .....	11
Step 1-2: CPU Heat Sink Installation .....	12
Step 2: Install memory modules .....	13
Step 3: Install expansion cards .....	14
Step 4: Connect ribbon cables, cabinet wires, and power supply .....	15
Step 4-1: I/O Back Panel Introduction .....	15
Step 4-2: Connectors Introduction .....	17
Chapter 3 BIOS Setup .....	21
The Main Menu (For example: BIOS Ver. :F1) .....	22
Standard CMOS Features .....	24
Advanced BIOS Features .....	28
Advanced Chipset Features .....	30

---

Integrated Peripherals .....	33
Power Management Setup .....	40
PnP/PCI Configurations .....	44
PC Health Status .....	46
Frequency/Voltage Control .....	48
Load Fail-Safe Defaults .....	49
Load Optimized Defaults .....	50
Set Supervisor/User Password .....	51
Save & Exit Setup .....	52
Exit Without Saving .....	53
Chapter 4 Technical Reference .....	54
Performance List .....	54
Block Diagram .....	55
Four Speaker & SPDIF Introduction .....	56
@ BIOS Introduction .....	60
Easy Tunell™ Introduction .....	61
Chapter 5 Appendix .....	62

## Revision History

Revision	Revision Note	Date
2.0	Initial release of the GA-8IDML Series motherboard user's manual.	Jul.2001
2.0	Second release of the GA-8IDML Series motherboard user's manual.	Aug.2001
2.0	Third release of the GA-8IDML Series motherboard user's manual.	Sep.2001
2.0	Fourth release of the GA-8IDML Series motherboard user's manual.	Nov.2001
2.0	Fifth release of the GA-8IDML Series motherboard user's manual.	Dec.2001
2.0	Sixth release of the GA-8IDML Series motherboard user's manual.	Feb.2002

## Item Checklist

- ✍ The GA-8IDML Series motherboard
- ✍ IDE cable x 1/ Floppy cable x 1
- ✍ CD for motherboard driver & utility (IUCD)
- ✍ GA-8IDML Series user's manual
- ✍ I/O Back Panel



**WARNING!**

Computer motherboards and expansion cards contain very delicate Integrated Circuit (IC) chips. To protect them against damage from static electricity, you should follow some precautions whenever you work on your computer.

1. Unplug your computer when working on the inside.
2. Use a grounded wrist strap before handling computer components. If you do not have one, touch both of your hands to a safely grounded object or to a metal object, such as the power supply case.
3. Hold components by the edges and try not touch the IC chips, leads or connectors, or other components.
4. Place components on a grounded antistatic pad or on the bag that came with the components whenever the components are separated from the system.
5. Ensure that the ATX power supply is switched off before you plug in or remove the ATX power connector on the motherboard.

**Installing the motherboard to the chassis...**

If the motherboard has mounting holes, but they don't line up with the holes on the base and there are no slots to attach the spacers, do not become alarmed you can still attach the spacers to the mounting holes. Just cut the bottom portion of the spacers (the spacer may be a little hard to cut off, so be careful of your hands). In this way you can still attach the motherboard to the base without worrying about short circuits. Sometimes you may need to use the plastic springs to isolate the screw from the motherboard PCB surface, because the circuit wire may be near by the hole. Be careful, don't let the screw contact any printed circuit write or parts on the PCB that are near the fixing hole, otherwise it may damage the board or cause board malfunctioning.

## Chapter 1 Introduction

### Summary of Features

Form Factor	☞ 24.4cm x 22.4cm Micro ATX size form factor, 4 layers PCB.
Motherboard	☞ GA-8IDML Series Motherboard: GA-8IDML and GA-8IDML-C
CPU	☞ Socket 478 for Intel® Micro FC-PGA2 Pentium® 4 processor ☞ Support Intel® Pentium® 4 (Northwood, 0.13um) processor ☞ Intel Pentium®4 400MHz FSB ☞ 2nd cache depend on CPU
Chipset	☞ Chipset 82845 HOST/AGP/Controller ☞ 82801BA(ICH2) I/O Controller Hub
Memory	☞ 2 168-pin DIMM sockets ☞ Supports PC-100/PC-133 SDRAM (Auto) ☞ Supports only 3.3V SDRAM DIMM ☞ No Registered DIMM support
I/O Control	☞ Winbond 83627HF
Slots	☞ 1 CNR(Communication and Networking Riser) Slot ☞ 1 AGP slot 4X (1.5V) device support ☞ 3 PCI slot supports 33MHz & PCI 2.2 compliant
On-Board IDE	☞ An IDE controller on the Intel 82801BA PCI chipset provides IDE HDD/CD-ROM with PIO, Bus Master (Ultra DMA33/ATA66/ATA100) operation modes. ☞ Can connect up to four IDE devices
On-Board Peripherals	☞ 1 Floppy port supports 2 FDD with 360K, 720K, 1.2M, 1.44M and 2.88M bytes. ☞ 1 Parallel port supports Normal/EPP/ECP mode ☞ 2 Serial ports (COMA&COMB) ☞ 4 USB ports (Rear USB x 2, Front USB x 2) ☞ 1 IrDA connector for IR
Hardware Monitor	☞ CPU/Power/System Fan Revolution detect ☞ CPU Fan Control ☞ CPU Overheat Warning

to be continued.....

On-Board LAN	☞ Build in RTL8100(B)L Chipset *
On-Board Sound	☞ Creative CT5880 Sound Chipset * ☞ Line In/Line Out/Mic In/CD In/Game Port
PS/2 Connector	☞ PS/2 Keyboard interface and PS/2 Mouse interace
BIOS	☞ Licensed AWARD BIOS, 2M bit FWH
Additional Features	☞ PS/2 Keyboard power on by password ☞ PS/2 Mouse power on ☞ STR(Suspend-To-RAM) ☞ Wake on LAN ☞ AC Recovery ☞ USB KB/Mouse wake up from S3 ☞ Supports @BIOS ☞ Supports Easy Tunelll
Special Features	☞ Over Clock (CPU/PCI/AGP)

☞ Please set the CPU host frequency in accordance with your processor's specifications. We don't recommend you to set the system bus frequency over the CPU's specification because these specific bus frequencies are not the standard specifications for CPU, chipset and most of the peripherals. Whether your system can run under these specific bus frequencies properly will depend on your hardware configurations, including CPU, Chipsets, SDRAM, Cards....etc.

\*\*\* Only for GA-8IDML.

# GA-8IDML Series Motherboard Layout

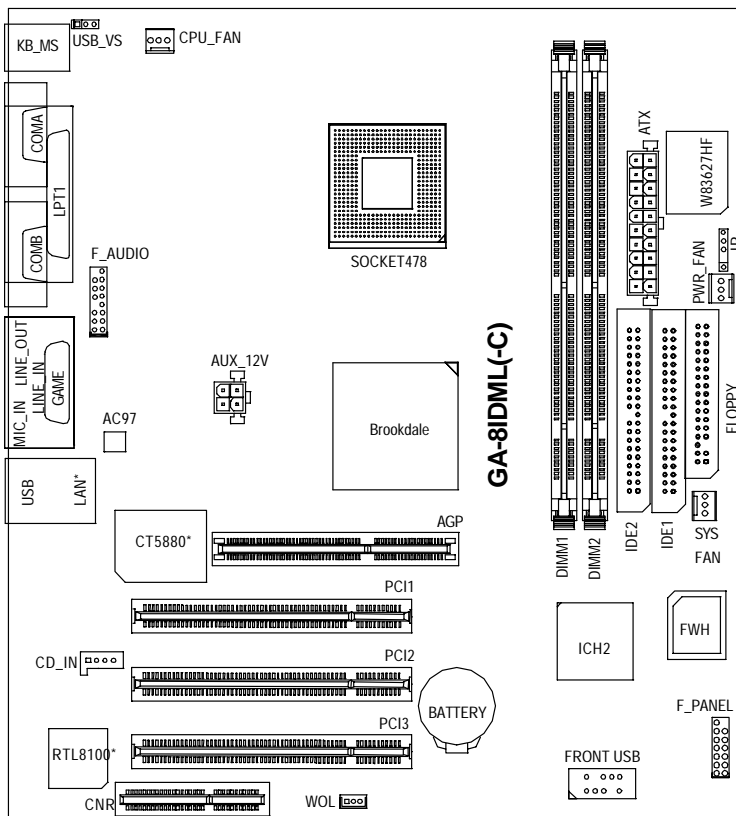

\*\*\* Only for GA-8IDML.

# GA-8IDML-LE Motherboard Layout

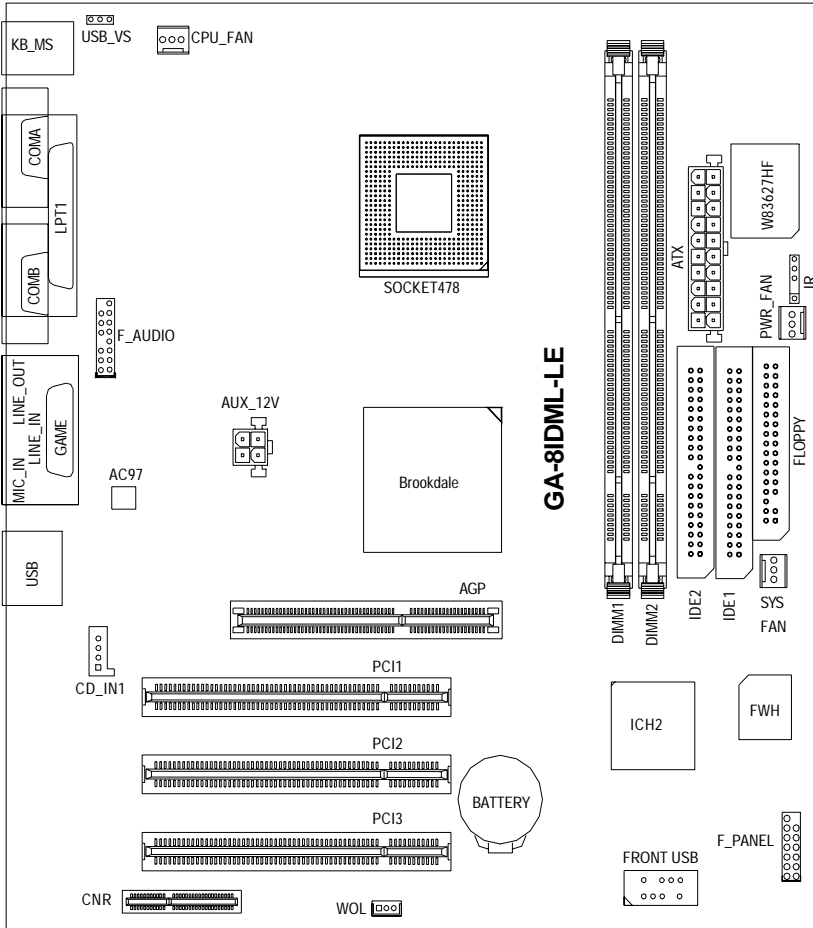

## Chapter 2 Hardware Installation Process

To setup your computer, you must complete the following steps:

- Step 1- Install the Central Processing Unit (CPU)
- Step 2- Install memory modules
- Step 3- Install expansion cards
- Step 4- Connect ribbon cables, cabinet wires, and power supply
- Step 5- Setup BIOS software
- Step 6- Install supporting software tools

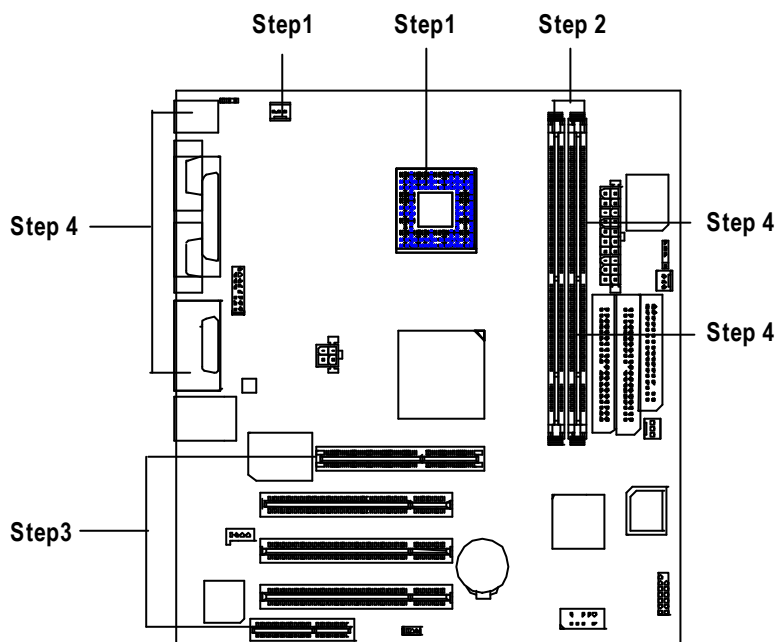

## Step 1: Install the Central Processing Unit (CPU)

### Step 1-1: CPU Installation



CPU Top View

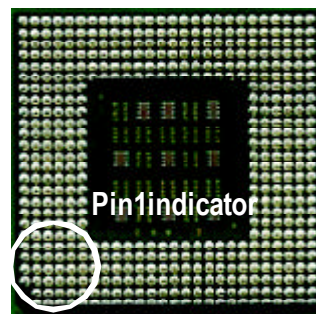

CPU Bottom View

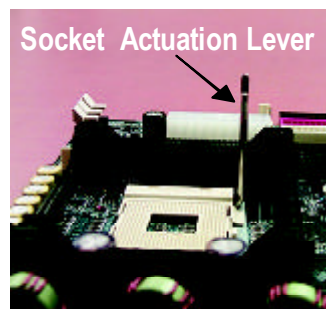

1. Pull up the CPU socket level and up to 90-degree angle.

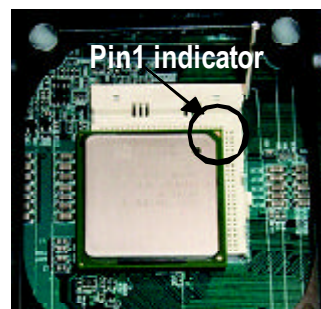

2. Locate Pin 1 in the socket and look for a (golden) cut edge on the CPU upper corner. Then insert the CPU into the socket.

3. Press down the CPU socket lever and finish CPU installation.

✍ **Please make sure the CPU type is supported by the motherboard.**

## Step 1-2: CPU Heat Sink Installation



1. Hook one end of the cooler bracket to the CPU socket first.

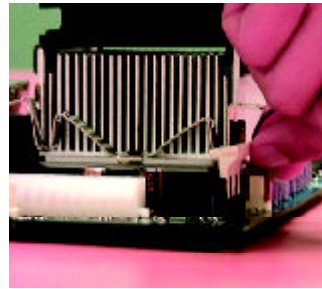

2. Hook the other end of the cooler bracket to the CPU socket.

- ✍ Please use Intel approved cooling fan.
- ✍ Make sure the CPU fan power cable is plugged in to the CPU fan connector, this completes the installation.
- ✍ Please refer to CPU heat sink user's manual for more detail installation procedure.



## Step 2: Install memory modules

The motherboard has 2 dual in-line memory module (DIMM) sockets support 4 banks. The BIOS will automatically detects memory type and size. To install the memory module, just push it vertically into the DIMM Slot. The DIMM module can only fit in one direction due to the two notch. Memory size can vary between sockets.

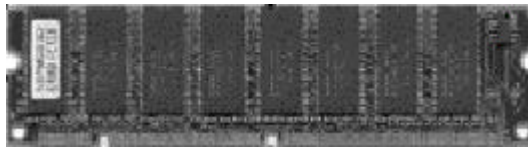

SDRAM

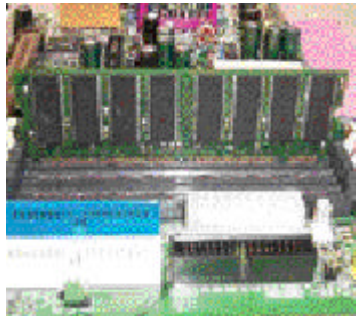

1. The DIMM slot has two notch, so the DIMM memory module can only fit in one direction.
2. Insert the DIMM memory module vertically into the DIMM slot. Then push it down.
3. Close the plastic clip at both edges of the DIMM slots to lock the DIMM module. Reverse the installation steps when you wish to remove the DIMM module.

⚠ **When STR/DIMM LED is ON, do not install/remove SDRAM from socket.**

### Step 3: Install expansion cards

1. Read the related expansion card's instruction document before install the expansion card into the computer.
2. Remove your computer's chassis cover, necessary screws and slot bracket from the computer.
3. Press the expansion card firmly into expansion slot in motherboard.
4. Be sure the metal contacts on the card are indeed seated in the slot.
5. Replace the screw to secure the slot bracket of the expansion card.
6. Replace your computer's chassis cover.
7. Power on the computer, if necessary, setup BIOS utility of expansion card from BIOS.
8. Install related driver from the operating system.

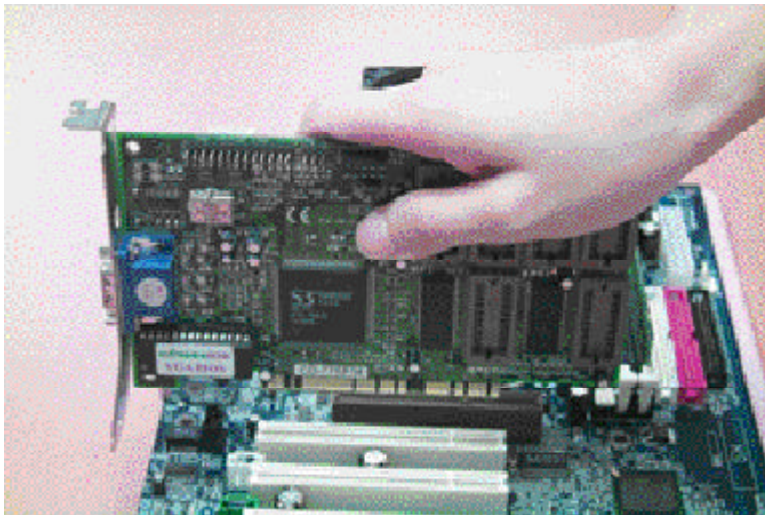

## Step 4: Connect ribbon cables, cabinet wires, and power supply

### Step 4-1: I/O Back Panel Introduction

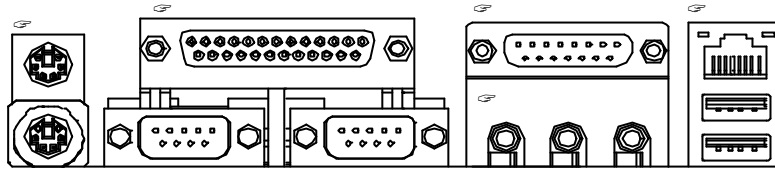

#### PS/2 Keyboard and PS/2 Mouse Connector



PS/2 Mouse Connector  
(6 pin Female)

PS/2 Key board Connector  
(6 pin Female)

This connector supports standard PS/2 keyboard and PS/2 mouse.

#### Parallel Port and Serial Ports (COMA/COMB)

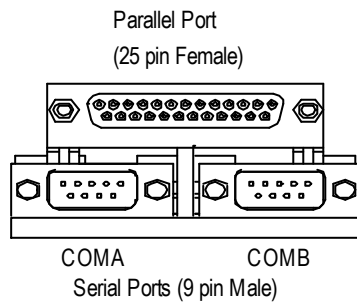

Parallel Port  
(25 pin Female)

COMA      COMB  
Serial Ports (9 pin Male)

This connector supports 2 standard COM ports and 1 Parallel port. Device like printer can be connected to Parallel port ; mouse and modem etc can be connected to Serial ports.

☞ **Game /MIDI Ports**

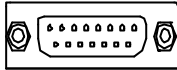

☞ This connector supports joystick, MIDI keyboard and other relate audio devices.

Joystick/ MIDI (15 pin Female)

☞ **Audio Connectors**

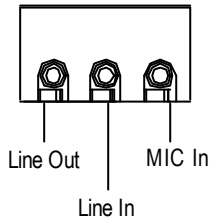

☞ After install onboard audio driver, you may connect speaker to Line Out jack, micro phone to MIC In jack. Device like CD-ROM , walkman etc can be connected to Line-In jack.

☞ **USB/LAN Connector**

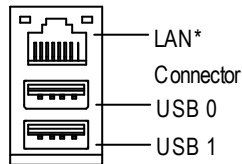

☞ Before you connect your device(s) into USB connector(s), please make sure your device(s) such as USB keyboard, mouse, scanner, zip, speaker...etc. Have a standard USB interface. Also make sure your OS (Win 95 with USB supplement, Win98, Windows 2000, Windows ME, Win NT with SP 6) supports USB controller. If your OS does not support USB controller, please contact OS vendor for possible patch or driver upgrade. For more information please contact your OS or device(s) vendors.

\*\*\* Only for GA-8IDML.

**Step 4-2: Connectors Introduction**

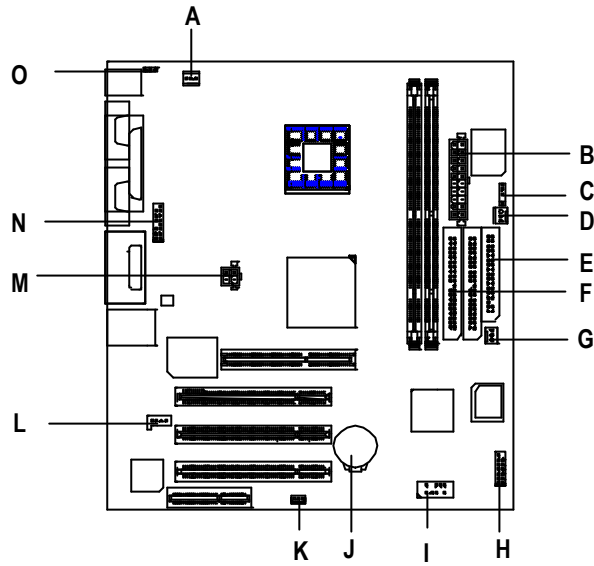

A	CPU_FAN	I	FRONT_USB
B	ATX	J	BATTERY
C	IR	K	WOL
D	PWR_FAN	L	CD_IN
E	FLOPPY	M	AUX_12V
F	IDE1/IDE2	N	F_AUDIO
G	SYS_FAN	O	USB_VS
H	F_PANEL		

**A / D / G : CPU\_FAN / PWR\_FAN / SYS\_FAN Connector**

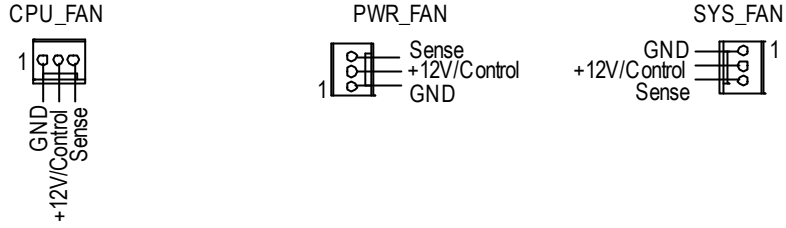

**B : ATX Power**

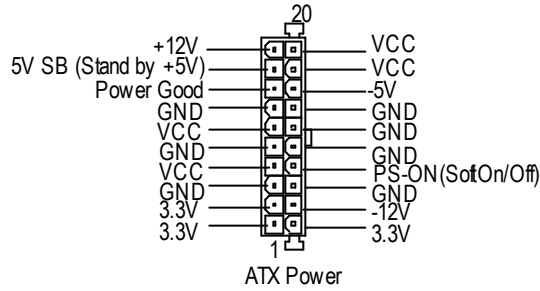

⚠ AC power cord should only be connected to your power supply unit after ATX power cable and other related devices are firmly connected to the mainboard.

**M : AUX\_12V Power Connector**

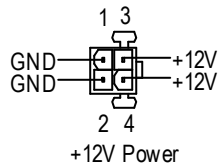

⚠ This connector (ATX +12V) is used only for CPU Core Voltage.

**E / F : Floppy / IDE1 / IDE2 Connector**

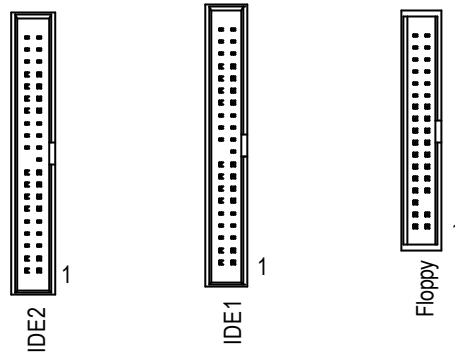

**L : CD\_IN**

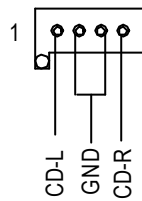

**K : WOL**

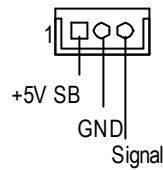

**N: F\_AUDIO Connector**

There are two types of Front Audio connector, please refer to the tables below before you install.

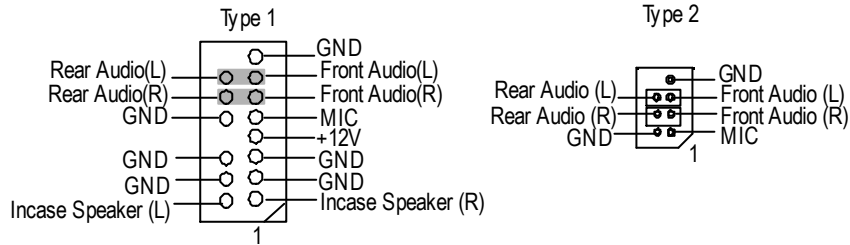

✍ If you want to use type-1 Front Audio connector, you must remove 11-12,13-14 Jumper.  
 If you want to use type-2 Front Audio connector, you must remove 3-4 ,5-6 Jumper. In order to utilize the front audio header, your chassis must have front audio connector. Also please make sure the pin assignment on the cable is the same as the pin assignment on the MB header. To find out if the chassis you are buying support front audio connector, please contact your dealer.

**C:IR**

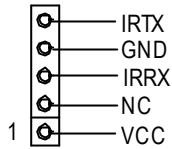

⚠ Be careful with the polarity of the IR connector while you connect the IR. Please contact your nearest dealer for optional IR device.

**H:F\_PANEL**

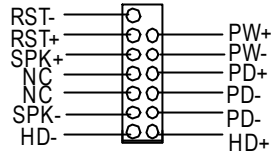

**I:Front USB**

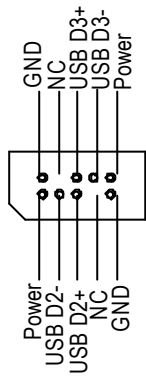

⚠ Be careful with the polarity of the front panel USB connector. Check the pin assignment while you connect the front panel USB cable. Please contact your nearest dealer for optional front panel USB cable.

**J:Battery**

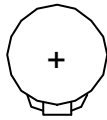

**WARNING**

- ⚠ Danger of explosion if battery is incorrectly replaced.
- ⚠ Replace only with the same or equivalent type recommended by the manufacturer.
- ⚠ Dispose of used batteries according to the manufacturer's instructions.

**O: USB\_VS : PS/2 USB Wake Up selection**

- 1  1-2 close: Enable
- 1  2-3 close: Disable (Default)



## Chapter 3 BIOS Setup

BIOS Setup is an overview of the BIOS Setup Program. The program that allows users to modify the basic system configuration. This type of information is stored in battery-backed CMOS RAM so that it retains the Setup information when the power is turned off.

### ENTERING SETUP

Power ON the computer and press <Del> immediately will allow you to enter Setup. If the message disappears before you respond and you still wish to enter Setup, restart the system to try again by turning it OFF then ON or pressing the "RESET" button on the system case. You may also restart by simultaneously press <Ctrl> - <Alt>- <Del> keys.

### CONTROL KEYS

<Left>	Move to previous item
<Right>	Move to next item
<Left>	Move to the item in the left hand
<Right>	Move to the item in the right hand
<Esc>	Main Menu - Quit and not save changes into CMOS Status Page Setup Menu and Option Page Setup Menu - Exit current page and return to Main Menu
<+/PgUp>	Increase the numeric value or make changes
<-/PgDn>	Decrease the numeric value or make changes
<F1>	General help, only for Status Page Setup Menu and Option Page Setup Menu
<F2>	Reserved
<F3>	Reserved
<F4>	Reserved
<F5>	Restore the previous CMOS value from CMOS, only for Option Page Setup Menu
<F6>	Load the default CMOS value from BIOS default table, only for Option Page Setup Menu
<F7>	Load the Setup Defaults
<F8>	Reserved
<F9>	Reserved
<F10>	Save all the CMOS changes, only for Main Menu

## GETTING HELP

### Main Menu

The on-line description of the highlighted setup function is displayed at the bottom of the screen.

### Status Page Setup Menu / Option Page Setup Menu

Press F1 to pop up a small help window that describes the appropriate keys to use and the possible selections for the highlighted item. To exit the Help Window press <Esc>.

## The Main Menu (For example: BIOS Ver. :F1)

Once you enter Award BIOS CMOS Setup Utility, the Main Menu (Figure 1) will appear on the screen. The Main Menu allows you to select from eight setup functions and two exit choices. Use arrow keys to select among the items and press <Enter> to accept or enter the sub-menu.

CMOS Setup Utility -Copy right (C) 1984-2001 Award Software

↵Standard CMOS Features	↵Frequency/Voltage Control
↵Advanced BIOS Features	Load Fail-Safe Defaults
↵Advanced Chipset Features	Load Optimized Defaults
↵Integrated Peripherals	Set Supervisor Password
↵Power Management Setup	Set User Password
↵PnP/PCI Configurations	Save & Exit Setup
↵PC Health Status	Exit Without Saving
ESC:Quit	
F10:Save & Exit Setup	
↵↵↵↵:Select Item	
Time, Date, Hard Disk Type...	

Figure 1: Main Menu

#### ☞ Standard CMOS Features

This setup page includes all the items in standard compatible BIOS.

#### ☞ Advanced BIOS Features

This setup page includes all the items of Award special enhanced features.

#### ☞ Advanced Chipset Features

This setup page includes all the items of chipset special features.

- ✍ **Integrated Peripherals**  
This setup page includes all onboard peripherals.
- ✍ **Power Management Setup**  
This setup page includes all the items of Green function features.
- ✍ **PnP/PCI Configurations**  
This setup page includes all the configurations of PCI & PnP ISA resources.
- ✍ **PC Health Status**  
This setup page is the System auto detect Temperature, voltage, fan, speed.
- ✍ **Frequency/Voltage Control**  
This setup page is control CPU's clock and frequency ratio.
- ✍ **Load Fail-Safe Defaults**  
Fail-Safe Defaults indicates the value of the system parameters which the system would be in safe configuration.
- ✍ **Load Optimized Defaults**  
Optimized Defaults indicates the value of the system parameters which the system would be in best performance configuration.
- ✍ **Set Supervisor password**  
Change, set, or disable password. It allows you to limit access to the system and Setup, or just to Setup.
- ✍ **Set User password**  
Change, set, or disable password. It allows you to limit access to the system.
- ✍ **Save & Exit Setup**  
Save CMOS value settings to CMOS and exit setup.
- ✍ **Exit Without Saving**  
Abandon all CMOS value changes and exit setup.

## Standard CMOS Features

CMOS Setup Utility - Copyright (C) 1984-2001 Award Software

### Standard CMOS Features

Date (mm:dd:yy)	Mon, Feb 21 2000	Item Help
Time (hh:mm:ss)	22:31:24	Menu Level
IDE Primary Master	Press Enter None	
IDE Primary Slave	Press Enter None	
IDE Secondary Master	Press Enter None	
IDE Secondary Slave	Press Enter None	
Drive A	1.44M, 3.5 in.	
Drive B	None	
Floppy 3 Mode Support	Disabled	
Video	EGA / VGA	
Halt On	All, But Keyboard	
Base Memory	640K	
Extended Memory	130048K	
Total Memory	131072K	
↓ ↓ ↓ ↓ : Move Enter:Select +/-/PU/PD:Value F10:Save ESC:Exit F1:General Help F5:Previous Values F6:Fail-Safe Defaults F7:Optimized Defaults		

Figure 2: Standard CMOS Features

### Date

The date format is <week>, <month>, <day>, <year>.

Week	The week, from Sun to Sat, determined by the BIOS and is display only
Month	The month, Jan. Through Dec.
Day	The day, from 1 to 31 (or the maximum allowed in the month)
Year	The year, from 1994 through 2079

**Time**

The times format in <hour> <minute> <second>. The time is calculated base on the 24-hour military-time clock. For example, 1 p.m. is 13:00:00.

**IDE Primary Master, Slave / Secondary Master, Slave**

The category identifies the types of hard disk from drive C to F that has been installed in the computer. There are two types: auto type, and manual type. Manual type is user-definable; Auto type which will automatically detect HDD type.

Note that the specifications of your drive must match with the drive table. The hard disk will not work properly if you enter improper information for this category.

If you select User Type, related information will be asked to enter to the following items. Enter the information directly from the keyboard and press <Enter>. Such information should be provided in the documentation form your hard disk vendor or the system manufacturer.

CYLS.	Number of cylinders
HEADS	Number of heads
PRECOMP	Write precomp
LANDZONE	Landing zone
SECTORS	Number of sectors

If a hard disk has not been installed select NONE and press <Enter>.

**Drive A / Drive B**

The category identifies the types of floppy disk drive A or drive B that has been installed in the computer.

None	No floppy drive installed
360K, 5.25 in.	5.25 inch PC-type standard drive; 360K byte capacity.
1.2M, 5.25 in.	5.25 inch AT-type high-density drive; 1.2M byte capacity (3.5 inch when 3 Mode is Enabled).
720K, 3.5 in.	3.5 inch double-sided drive; 720K byte capacity
1.44M, 3.5 in.	3.5 inch double-sided drive; 1.44M byte capacity.
2.88M, 3.5 in.	3.5 inch double-sided drive; 2.88M byte capacity.

**Floppy 3 Mode Support (for Japan Area)**

Disabled	Normal Floppy Drive. (Default value)
Drive A	Drive A is 3 mode Floppy Drive.
Drive B	Drive B is 3 mode Floppy Drive.
Both	Drive A & B are 3 mode Floppy Drives.

**Video**

The category detects the type of adapter used for the primary system monitor that must match your video display card and monitor. Although secondary monitors are supported, you do not have to select the type in setup.

EGA/VGA	Enhanced Graphics Adapter/Video Graphics Array. For EGA, VGA, SVGA, or PGA monitor adapters
CGA 40	Color Graphics Adapter, power up in 40 column mode
CGA 80	Color Graphics Adapter, power up in 80 column mode
MONO	Monochrome adapter, includes high resolution monochrome adapters

**Halt on**

The category determines whether the computer will stop if an error is detected during power up.

NO Errors	The system boot will not stop for any error that may be detected and you will be prompted.
All Errors	Whenever the BIOS detects a non-fatal error the system will be stopped.
All, But Keyboar	The system boot will not stop for a keyboard error; it will stop for all other errors. (Default value)
All, But Diskette	The system boot will not stop for a disk error; it will stop for all other errors.
All, But Disk/Key	The system boot will not stop for a keyboard or disk error; it will stop for all other errors.

## **Memory**

The category is display-only which is determined by POST (PowerOn Self Test) of the BIOS.

### **Base Memory**

The POST of the BIOS will determine the amount of base (or conventional) memory installed in the system.

The value of the base memory is typically 512 K for systems with 512 K memory installed on the motherboard, or 640 K for systems with 640 K or more memory installed on the motherboard.

### **Extended Memory**

The BIOS determines how much extended memory is present during the POST.

This is the amount of memory located above 1 MB in the CPU's memory address map.

## Advanced BIOS Features

CMOS Setup Utility-Copyright (C) 1984-2001 Award Software

### Advanced BIOS Features

First Boot Device	Floppy	Item Help
Second Boot Device	HDD-0	Menu Level
Third Boot Device	CDROM	
Boot Up Floppy Seek	Disabled	
Boot Up Num-Lock	On	
Password Check	Setup	
MPS Version Control For OS	1.4	
HDD S.M.A.R.T. Capability	Disabled	
↓↓↓↓: Move Enter:Select +/-/PU/PD:Value F10:Save ESC:Exit F1:General Help F5:Previous Values F6:Fail-Safe Defaults F7:Optimized Defaults		

Figure 3: Advanced BIOS Features

### First / Second / Third Boot device

Floppy	Select your boot device priority by Floppy.
LS120	Select your boot device priority by LS120.
HDD-0~3	Select your boot device priority by HDD-0~3.
SCSI	Select your boot device priority by SCSI.
CDROM	Select your boot device priority by CDROM.



**Boot Up Floppy Seek**

During POST, BIOS will determine the floppy disk drive installed is 40 or 80 tracks. 360 K type is 40 tracks 720 K, 1.2 M and 1.44 M are all 80 tracks.

Enabled	BIOS searches for floppy disk drive to determine it is 40 or 80 tracks. Note that BIOS can not tell from 720 K, 1.2 M or 1.44 M drive type as they are all 80tracks. (Default value)
Disabled	BIOS will not search for the type of floppy disk drive by track number. Note that there will not be any warning message if the drive installed is 360 K.

**Boot Up NumLock**

On	Keypad is number keys. (Default value)
Off	Keypad is arrow keys.

**Password Check**

This category allows you to limit access to the system and Setup, or just to Setup.

System	The system can not boot and can not access to Setup page will be denied if the correct password is not entered at the prompt.
Setup	The system will boot, but access to Setup will be denied if the correct password is not entered at the prompt. (Default value)

**MPS Version Control For OS**

(Support Multi Processor Specification revision 1.4)

1.4	Support MPS Version 1.4 . (Default Value)
1.1	Support MPS Version 1.1.

**HDD S.M.A.R.T. Capability**

Enabled	Enabled HDD S.M.A.R.T. Capability .
Disabled	Disabled HDD S.M.A.R.T. Capability . (Default value)

## Advanced Chipset Features

CMOS Setup Utility - Copyright (C) 1984-2001 Award Software

### Advanced Chipset Features

Configure DRAM Timing	SPD	Item Help
☞CAS Latency Time	2	Menu Level
☞Active to Precharge Delay	5	
☞DRAM RAS# to CAS# Delay	2	
☞DRAM RAS# Precharge	2	
☞Refresh Mode Select	15.6usec	
DRAM Data Integrity Mode	Non-ECC	
DRAM Read Thermal Mgmt	Disable	
Delay Transaction	Enable	
AGP Aperture Size(MB)	64	
Delay Prior to Thermal	16Min	
↓↓↓↓: Move Enter:Select +/-/PU/PD:Value F10:Save ESC:Exit F1:General Help F5:Previous Values F6:Fail-Safe Defaults F7:Optimized Defaults		

Figure 4: Advanced Chipset Features

### Configure DRAM Timing

SPD	Set Configure DRAM Timing Control by SPD. (Default value)
Manual	Set SConfigure DRAM Timing Control by Manual.

### CAS latency Time

3	For Slower SDRAM DIMM module.
2	For Fastest SDRAM DIMM module. (Default Value)

### Active to Precharge Delay

5	Set active to Precharge delay timing is 5 clk. (Default value)
6	Set active to Precharge delay timing is 6 clk.
7	Set active to Precharge delay timing is 7 clk.

**SDRAMRAS# to CAS# delay**

3	Set SDRAM RAS# to CAS# delay 3 SCLKs.
2	Set SDRAM RAS# to CAS# delay 2 SCLKs. (Default value)

**SDRAMRAS# Precharge**

3	Set SDRAM RAS# Precharge Time to 3. (Default value)
2	Set SDRAM RAS# Precharge Time to 2.

**Refresh Mode Select**

7.8 usec	Set active to Refresh mode timing is 7.8 usec.
15.6 usec	Set active to Refresh mode timing is 15.6 usec.
64 usec	Set active to Refresh mode timing is 64 usec.

**DRAMData Integrity Mode**

ECC	Set DRAM Data Integrity Mode by ECC.
Non-ECC	Set DRAM Data Integrity Mode by Non-ECC. (Default value)

**DRAM Read Thermal Mgmt**

Disabled	Disable DRAM Read Thermal Mgmt. (Default value)
Enabled	Enable DRAM Read Thermal Mgmt.

**Delay Transaction**

Disabled	Normal operation.
Enabled	For slow speed ISA device in system. (Default value)

**AGP Graphics Aperture Size**

4	AGP Graphics Aperture Size is 4MB.
8	AGP Graphics Aperture Size is 8MB.
16	AGP Graphics Aperture Size is 16MB
32	AGP Graphics Aperture Size is 32MB.
64	AGP Graphics Aperture Size is 64MB.(Default Value)
128	AGP Graphics Aperture Size is 128MB.
256	AGP Graphics Aperture Size is 256MB.

**Delay Prior to Thermal**

16Min	Set active CPU Thermal function after booting 16 Min.(Default Value)
64Min	Set active CPU Thermal function after booting 64 Min.

## Integrated Peripherals

CMOS Setup Utility - Copyright (C) 1984-2001 Award Software

### Integrated Peripherals

On-Chip Primary PCI IDE	Enabled	Item Help
On-Chip Secondary PCI IDE	Enabled	
IDE Primary Master PIO	Auto	Menu Level
IDE Primary Slave PIO	Auto	
IDE Secondary Master PIO	Auto	
IDE Secondary Slave PIO	Auto	
IDE Primary Master UDMA	Auto	
IDE Primary Slave UDMA	Auto	
IDE Secondary Master UDMA	Auto	
IDE Secondary Slave UDMA	Auto	
USB Controller	Enabled	
USB Keyboard Support	Disabled	
USB Mouse Support	Disabled	
Init Display First	AGP	
AC97 Audio	Auto	
AC97 Modem	Auto	
Onboard LAN*	Enabled	
Onboard Sound*	Enabled	
Mouse Power On	Disabled	
Keyboard Power On	Disabled	
⇐KB Power ON Password	Enter	
Onboard FDC Controller	Enabled	
Onboard Serial Port 1	3F8/IRQ4	
Onboard Serial Port 2	2F8/IRQ3	
UART Mode Select	Normal	
⇐Rx,D,TxD, Active	Hi,Lo	
⇐IR Transmission Delay	Enabled	
⇐UR2 Duplex Mode	Half	
Use IR Pins	IR-Rx2Tx2	
Onboard Parallel Port	378/IRQ7	

GA-8IDML Series Motherboard

Parallel Port Mode	SPP	
EPP Mode Select	EPP 1.7	
ECP Mode Use DMA	3	
AC BACK Function	Soft-Off	
↑↓←→: Move Enter:Select +/-/PU/PD:Value F10:Save ESC:Exit F1:General Help F5:Previous Values F6:Fail-Safe Defaults F7:Optimized Defaults		

Figure 5: Integrated Peripherals

**On-Chip Primary PCI IDE**

Enabled	Enable onboard 1st channel IDE port. (Default value)
Disabled	Disable onboard 1st channel IDE port.

**On-Chip Secondary PCI IDE**

Enabled	Enable onboard 2nd channel IDE port. (Default value)
Disabled	Disable onboard 2nd channel IDE port.

**IDE Primary Master PIO (for onboard IDE 1st channel)**

Auto	BIOS will automatically detect the IDE HDD Accessing mode. (Default value)
Mode0~4	Manually set the IDE Accessing mode.

**IDE Primary Slave PIO (for onboard IDE 1st channel)**

Auto	BIOS will automatically detect the IDE HDD Accessing mode. (Default value)
Mode0~4	Manually set the IDE Accessing mode.

**IDE Secondary Master PIO (for onboard IDE 2nd channel)**

Auto	BIOS will automatically detect the IDE HDD Accessing mode. (Default value)
Mode0~4	Manually set the IDE Accessing mode.

**IDE Secondary Slave PIO (for onboard IDE 2nd channel)**

Auto	BIOS will automatically detect the IDE HDD Accessing mode. (Default value)
Mode0~4	Manually set the IDE Accessing mode.

**IDE Primary Master UDMA**

Auto	BIOS will automatically detect the IDE HDD Accessing mode. (Default value)
Disabled	Disable UDMA function.

**IDE Primary Slave UDMA**

Auto	BIOS will automatically detect the IDE HDD Accessing mode. (Default value)
Disabled	Disable UDMA function.

**IDE Secondary Master UDMA**

Auto	BIOS will automatically detect the IDE HDD Accessing mode. (Default value)
Disabled	Disable UDMA function.

**IDE Secondary Slave UDMA**

Auto	BIOS will automatically detect the IDE HDD Accessing mode. (Default value)
Disabled	Disable UDMA function.

**USB Controller**

Enabled	Enabled USB Controller. (Default value)
Disabled	Disabled USB Controller.

### USB Keyboard Support

Enabled	Enabled USB Keyboard Support.
Disabled	Disabled USB Keyboard Support. (Default value)

### USB Mouse Support

Enabled	Enabled USB Mouse Support.
Disabled	Disabled USB Mouse Support. (Default value)

### Init Display First

PCI	Set Init Display First to PCI Slot.
AGP	Set Init Display First to AGP. (Default value)

### AC97 Audio

Auto	BIOS will automatically detect onboard AC97 Audio or Creative CT5880 audio. (Default value)
Disabled	Disabled AC97 Audio.

### AC97 Modem

Auto	Bios will automatically detect onboard AC97 Modem. (Default value)
Disabled	Disabled AC97 Modem.

### Onboard LAN\*

Enable	Enable onboard LAN function.(Default value)
Disable	Disable onboard LAN function.

### Onboard Sound\*

Enable	Enable onboard LAN function. (Default value)
Disabled	Disabled onboard LAN function.

\*\*\* Only for GA-8IDML.



**Mouse Power On**

Disabled	Disabled this function. (Default value)
Mouse Click	Power On by Mouse click.

**Keyboard Power On**

Password	Enter from 1 to 5 characters to set the Key board Power On Passw ord.
Disabled	Disabled this function. (Default value)
Key board 98	If y our key board have "POWER Key" button, you can press the key to power on your system.

**KB Power ON Password**

Enter	Input password (from 1 to 5 characters) and press Enter to set the Key board Power On Passw ord.
-------	--

**Onboard FDC Controller**

Enabled	Enable onboard FDC port. (Default value)
Disabled	Disable onboard FDC port.

**Onboard Serial Port 1**

Auto	BIOS will automatically setup the port 1 address.
3F8/IRQ4	Enable onboard Serial port 1 and address is 3F8. (Default value)
2F8/IRQ3	Enable onboard Serial port 1 and address is 2F8.
3E8/IRQ4	Enable onboard Serial port 1 and address is 3E8.
2E8/IRQ3	Enable onboard Serial port 1 and address is 2E8.
Disabled	Disable onboard Serial port 1.

**Onboard Serial Port 2**

Auto	BIOS will automatically setup the port 2 address.
3F8/IRQ4	Enable onboard Serial port 2 and address is 3F8.
2F8/IRQ3	Enable onboard Serial port 2 and address is 2F8. (Default Value)
3E8/IRQ4	Enable onboard Serial port 2 and address is 3E8.
2E8/IRQ3	Enable onboard Serial port 2 and address is 2E8.
Disabled	Disable onboard Serial port 2.

**UART Mode Select**

(This item allows you to determine which Infra Red(IR) function of Onboard I/O chip)

ASKIR	Set onboard I/O chip UART to ASKIR Mode.
IrDA	Set onboard I/O chip UART to IrDA Mode.
SCR	Set onboard I/O chip UART to SCR Mode.
Normal	Set onboard I/O chip UART to Normal Mode. (Default Value)

**RxD, Tx D Active**

Hi, Hi	Set RxD, Tx D Active to Hi, Hi.
Hi, Lo	Set RxD, Tx D Active to Hi, Lo. (Default Value)
Lo, Hi	Set RxD, Tx D Active to Lo, Hi.
Lo, Lo	Set RxD, Tx D Active to Lo, Lo.

**IR Transmission Delay**

Enabled	Enabled IR Transmission delay. (Default Value)
Disabled	Enabled IR Transmission delay.

**UR2 Duplex Mode**

Half	IR Function Duplex Half. (Default Value)
Full	IR Function Duplex Full.

**Use IR Pins**

IR-Rx2Tx2	Enable On Board LPT port and address is 378.(Default Value)
RxD2,TxD2	Enable On Board LPT port and address is 278.

**OnBoard Parallel port**

378/IRQ7	Enable On Board LPT port and address is 378.(Default Value)
278/IRQ5	Enable On Board LPT port and address is 278.
3BC/IRQ7	Enable On Board LPT port and address is 3BC.

**Parallel Port Mode**

SPP	Using Parallel port as Standard Parallel Port. (Default Value)
EPP	Using Parallel port as Enhanced Parallel Port.
ECP	Using Parallel port as Extended Capabilities Port.
ECP+EPP	Using Parallel port as ECP & EPP mode.

**Parallel Port EPP Type**

EPP 1.9	EPP Version is 1.9. (Default value)
EPP 1.7	EPP Version is 1.7.

**AC Back Function**

Memory	System power on depends on the status before AC lost.
Soft-Off	Always in Off state when AC back. (Default value)
Full-On	Always power on the system when AC back.

## Power Management Setup

CMOS Setup Utility-Copyright (C) 1984-2001 Award Software

### Power Management Setup

ACPI Suspend Type	S1(POS)	Item Help
☞USB Device Wake-Up From S3	Disabled	Menu Level
Power Management	User Define	
Video Off Method	DPMS	
Video Off In Suspend	Yes	
Suspend Type	Stop Grant	
MODEM Use IRQ	3	
Suspend Mode	Disabled	
HDD Power Down	Disabled	
Soft-Off by PWR-BTTN	Instant-off	
PME Event Wake Up	Enabled	
ModemRingOn/WakeOnLan	Enabled	
Resume by Alarm	Disabled	
☞Date(of Month) Alarm	Every day	
☞Time(hh:mm:ss) Alarm	0 0 0	
** Reload Global Timer Events **		
Primary IDE 0	Disabled	
Primary IDE 1	Disabled	
Secondary IDE 0	Disabled	
Secondary IDE 1	Disabled	
FDD,COM,LPT Port	Disabled	
PCI PIRQ[A-D]#	Disabled	
↑ ↓ ← → : Move Enter:Select +/-/PU/PD:Value F10:Save ESC:Exit F1:General Help F5:Previous Values F6:Fail-Safe Defaults F7:Optimized Defaults		

Figure 6: Power Management Setup

**ACPI Sleep Type**

S1/POS	Set ACPI Sleep Type to S1/POS (Power On Suspend). (Default value)
S3/STR	Set ACPI Sleep Type to S3/STR (Suspend To RAM).

**USB Dev Wakeup From S3**

Enabled	Enable USB Device Wakeup From S3.
Disabled	Disable USB Device Wakeup From S3. (Default value)

**Power Management**

User Define	For configuring our own power management features (Default Value)
Min Saving	Disabled Green & software APM function.
Max Saving	Enabled Green & software APM function.

**Video off Method**

V/H SYNC+Blank	BIOS will turn off V/H-SYNC when gets into Green mode for Green monitor power saving.
Blank Screen	BIOS will only black monitor when gets into Green mode.
DPMS	BIOS will use DPMS Standard to control VGA card. (The Green type VGA card will turn off V/H-SYNC automatically.)(Default value)

**Video Off In Suspend**

Yes	Set Suspend type is stop grant. (Default value)
No	SuspendSet Suspend type is Power on Suspend.

**Suspend Type**

Stop Grant	Set Suspend type is stop grant. (Default value)
PwrOn Suspend	Set Suspend type is Power on Suspend.

**MODEM Use IRQ**

N/A	Set MODEM Use IRQ to NA.
3	Set MODEM Use IRQ to 3.(Default value)
4	Set MODEM Use IRQ to 4.
5	Set MODEM Use IRQ to 5.
7	Set MODEM Use IRQ to 7.
9	Set MODEM Use IRQ to 9.
10	Set MODEM Use IRQ to 10.
11	Set MODEM Use IRQ to 11.

**Suspend Mode**

Disabled	Disabled Suspend Mode. (Default value)
1 min - 1 Hour	Setup the timer to enter Suspend Mode.

**HDD Power Down**

Disabled	Disabled HDD Power Down mode function. (Default value)
1-15 mins.	Enabled HDD Power Down mode between 1 to 15 mins.

**Soft-off by PWR-BTTN**

Instant-off	Press power button then Power off instantly . (Default value)
Delay 4 Sec.	Press power button 4 sec to Power off. Enter suspend if button is pressed less than 4 sec.

**PME Event Wake up**

Disabled	Disabled PME Event Wake up function.
Enabled	Enabled PME Event Wake up function. (Default Value)

**Modem Ring On/ WakeOnLAN**

Disabled	Disabled Modem Ring On / Wake On LAN function.
Enabled	Enabled Modem Ring On / Wake On LAN function. (Default Value)

**RTC Alarm Power On**

You can set "RTC Alarm Power On" item to enabled and key in Data/time to power on system.

Disabled	Disable this function. (Default Value)
Enabled	Enable alarm function to POWER ON system.

If RTC Alarm Lead To Power On is Enabled.

RTC Alarm Date :	Every Day, 1~31
RTC Alarm Hour:	0~23
RTC Alarm Minute :	0~59
RTC Alarm Second :	0~59

**Primary IDE 0/1**

Disabled	Disabled this function. (Default value)
Enabled	Enabled monitor Primary IDE 0/1 for Green event.

**Secondary IDE 0/1**

Disabled	Disabled this function. (Default value)
Enabled	Enabled monitor Secondary IDE 0/1 for Green event.

**FDD,COM,LPT Port**

Disabled	Disabled this function. (Default value)
Enabled	Enabled monitor FDC,COM,LPT for Green event.

**PCI PIRQ[A-D] #**

Enabled	Monitor PCI PIRQ[A-D]# IRQ Active.
Disabled	Ignore PCI PIRQ[A-D]# IRQ Active. (Default value)

## PnP/PCI Configurations

CMOS Setup Utility - Copyright (C) 1984-2001 Award Software

### PnP/PCI Configurations

Resources Controlled By	Auto	Item Help
IRQ Resources	Press Enter	Menu Level
PCI1 IRQ Assignment	Auto	
PCI2 IRQ Assignment	Auto	
PCI3 IRQ Assignment	Auto	
↑↓←→: Move Enter:Select +/-/PU/PD:Value F10:Save ESC:Exit F1:General Help F5:Previous Values F6:Fail-Safe Defaults F7:Optimized Defaults		

Figure 7: PnP/PCI Configurations

### Resources Controlled by

Manual	User can set the PnP resource (I/O Address, IRQ & DMA channels) used by legacy ISA DEVICE.
Auto(ESCD)	BIOS automatically use these PnP rescuers. (Default value)

### IRQ Resources ( 3,4,5,7,9,10,11,12,14,15 )

PCI Device	The resource is used by PCI device.
Reserved	Set the resource to reserved.

### PCI1 IRQ Assignment

Auto	Auto assign IRQ to PCI 1. (Default value)
3,4,5,7,9,10,11,12,14,15	Set 3,4,5,7,9,10,11,12,14,15 to PCI1.

### PCI2 IRQ Assignment

Auto	Auto assign IRQ to PCI 2. (Default value)
3,4,5,7,9,10,11,12,14,15	Set 3,4,5,7,9,10,11,12,14,15 to PCI2.



---

**PCI3 IRQ Assignment**

Auto	Auto assign IRQ to PCI 3. (Default value)
3,4,5,7,9,10,11,12,14,15	Set 3,4,5,7,9,10,11,12,14,15 to PCI3.

## PC Health Status

CMOS Setup Utility - Copyright (C) 1984-2001 Award Software

PC Health Status		
VCORE	1.792 V	Item Help
+3.3V	3.360V	Menu Level
+ 5V	5.053 V	
+12V	12.096V	
- 12V	-12.280 V	
Current System Temperature	31°C~89°F	
Current CPU Temperature	28°C~98°F	
Current CPU FAN Speed	5443 RPM	
Current POWER FAN Speed	0 RPM	
Current SYSTEM FAN speed	0 RPM	
CPU Warning Temperature	Disabled	
CPU FAN Fail Warning	Disabled	
POWER FAN Fail Warning	Disabled	
SYSTEM FAN Fail Warning	Disabled	
↑↓←→: Move Enter:Select +/-/PU/PD:Value F10:Save ESC:Exit F1:General Help F5:Previous Values F6:Fail-Safe Defaults F7:Optimized Defaults		

Figure8: PC Health Status

### Current Voltage (V) VCORE/ VCC18 / +5V / ±12V

Detect system's voltage status automatically.

### Current System / CPU Temperature (°C / °F)

Detect System / CPU Temp. automatically.

### Current CPU FAN / POWER FAN / SYSTEMFAN Speed (RPM)

Detect Fan speed status automatically.

---

**CPU Warning Temperature**

60°C / 140°F	Monitor CPU Temp. at 60°C / 140°F.
70°C / 158°F	Monitor CPU Temp. at 70°C / 158°F.
80°C / 176°F	Monitor CPU Temp. at 80°C / 176°F.
90°C / 194°F	Monitor CPU Temp. at 90°C / 194°F.
Disabled	Disabled this function.(Default value)

**Fan Fail Warning ( CPU/ POWER/ SYSTEM)**

Disabled	Fan Fail Alarm Function Disabled. (Default value)
Enabled	Fan Fail Alarm Function Enabled.

## Frequency/Voltage Control

CMOS Setup Utility-Copyright (C) 1984-2001 Award Software

### Frequency/Voltage Control

CPU Clock Ratio	x 15	Item Help
CPU Host Clock Control	Disable	Menu Level
CPU Host Frequency (MHz)	100	
Host/DRAM Clock ratio	Auto	
Memory Frequency (MHz)	133	
PCI/AGP Frequency (MHz)	33/66	
↓↓↓↓: Move Enter:Select +/-/PU/PD:Value F10:Save ESC:Exit F1:General Help F5:Previous Values F6:Fail-Safe Defaults F7:Optimized Defaults		

Figure 9: Frequency/Voltage Control

### CPU Clock Ratio

X 8~X 24 It's depends on CPU Clock Ratio.

### CPU Host Clock Control

Disable	Disable CPU Host Clock Control.(Default v alue)
Enable	Enable CPU Host Clock Control.

### CPU Host Frequency

100MHz ~ 200MHz Set CPU Host Clock from 100MHz to 200MHz.

### Host/DRAM Clock Ratio

1.0	Memory Frequency = Host clock X 1.0.
1.33	Memory Frequency = Host clock X 1.33.
Auto	Depend's On SPD Data. (Default v alue)





## Set Supervisor/User Password

CMOS Setup Utility-Copyright (C) 1984-2001 Award Software

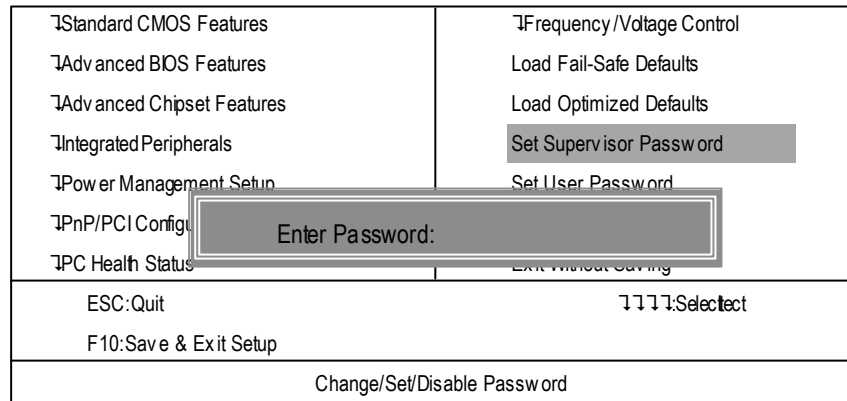

Figure 12: Password Setting

When you select this function, the following message will appear at the center of the screen to assist you in creating a password.

Type the password, up to eight characters, and press <Enter>. You will be asked to confirm the password. Type the password again and press <Enter>. You may also press <Esc> to abort the selection and not enter a password.

To disable password, just press <Enter> when you are prompted to enter password. A message "PASSWORD DISABLED" will appear to confirm the password being disabled. Once the password is disabled, the system will boot and you can enter Setup freely.

The BIOS Setup program allows you to specify two separate passwords: a SUPERVISOR PASSWORD and a USER PASSWORD. When disabled, anyone may access all BIOS Setup program function. When enabled, the Supervisor password is required for entering the BIOS Setup program and having full configuration fields, the User password is required to access only basic items.

If you select "System" at "Security Option" in Advance BIOS Features Menu, you will be prompted for the password every time the system is rebooted or any time you try to enter Setup Menu.

If you select "Setup" at "Security Option" in Advance BIOS Features Menu, you will be prompted only when you try to enter Setup.

## Save & Exit Setup

CMOS Setup Utility-Copyright (C) 1984-2001 Award Software

Standard CMOS Features	Frequency/Voltage Control
Advanced BIOS Features	Load Fail-Safe Defaults
Advanced Chipset Features	Load Optimized Defaults
Integrated Peripherals	Set Supervisor Password
Power Management Setup	Set User Password
PnP/PCI Configurations	Save to CMOS and EXIT (Y/N)? Y
PC Health Status	EXIT without Saving
ESC:Quit	↓↓↓↓:Select
F10:Save & Exit Setup	
Save Data to CMOS	

Figure 13: Save & Exit Setup

Type "Y" will quit the Setup Utility and save the user setup value to RTC CMOS.

Type "N" will return to Setup Utility.



## Exit Without Saving

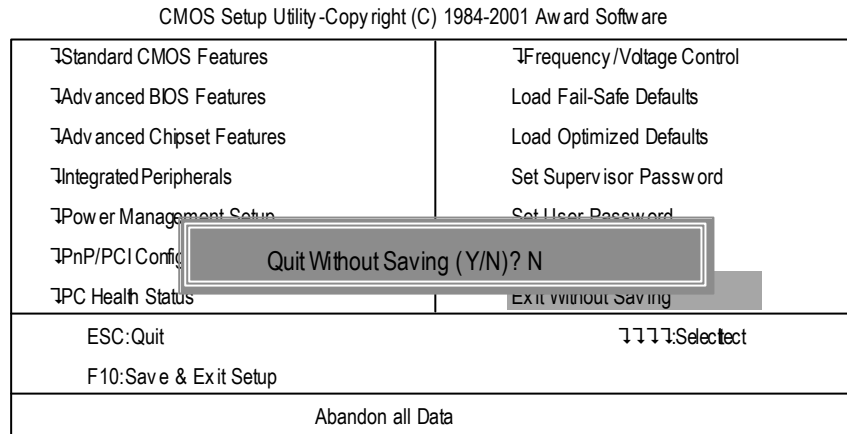

Figure 14: Exit Without Saving

Type "Y" will quit the Setup Utility without saving to RTC CMOS.

Type "N" will return to Setup Utility.

## Chapter 4 Technical Reference

### Performance List

The following performance data list is the testing results of some popular benchmark testing programs. These data are just referred by users, and there is no responsibility for different testing data values gotten by users. (The different Hardware & Software configuration will result in different benchmark testing results.)

CPU	Intel Pentium®4 1.7GHz processor
DRAM	(128 x 1) MB SDRAM (PQI PC166)
CACHE SIZE	256KB included in CPU
DISPLAY	Gigabyte GV-GF3000D
STORAGE	Onboard IDE (Quantum AS30000AT 30GB)
O.S	Windows 2000+ SP2
DRIVER	Display Driver at 1024 x 768 x 64K colors x 75Hz IUCD ver. 1.8 For Intel chipset M.B.

<b>Processor</b>	Intel Pentium® 4 1.7GHz (100x17)
<b>WCPUID 2.8 Clock Frequency</b>	
Internal MHz	1700.01
<b>SiSoft Sandra 2001</b>	
CPU/FPU Benchmark	3264/887/2095
CPU Multi-Media Benchmark	6799/8821
Drives Benchmark	22971
Memory Benchmark	662/669
<b>SPECviewperf 6.12</b>	
Pro CDRS-03	13.42
MedMCAD-01	17.90
Light-04	5.093
DX-06	14.05
DRV-07	14.83
Advads-04	39.38
<b>QUAKE III Arena (without sound)</b>	
640*480*16 Demo1	153.3
1024*768*32 Demo2	134.2

## Block Diagram

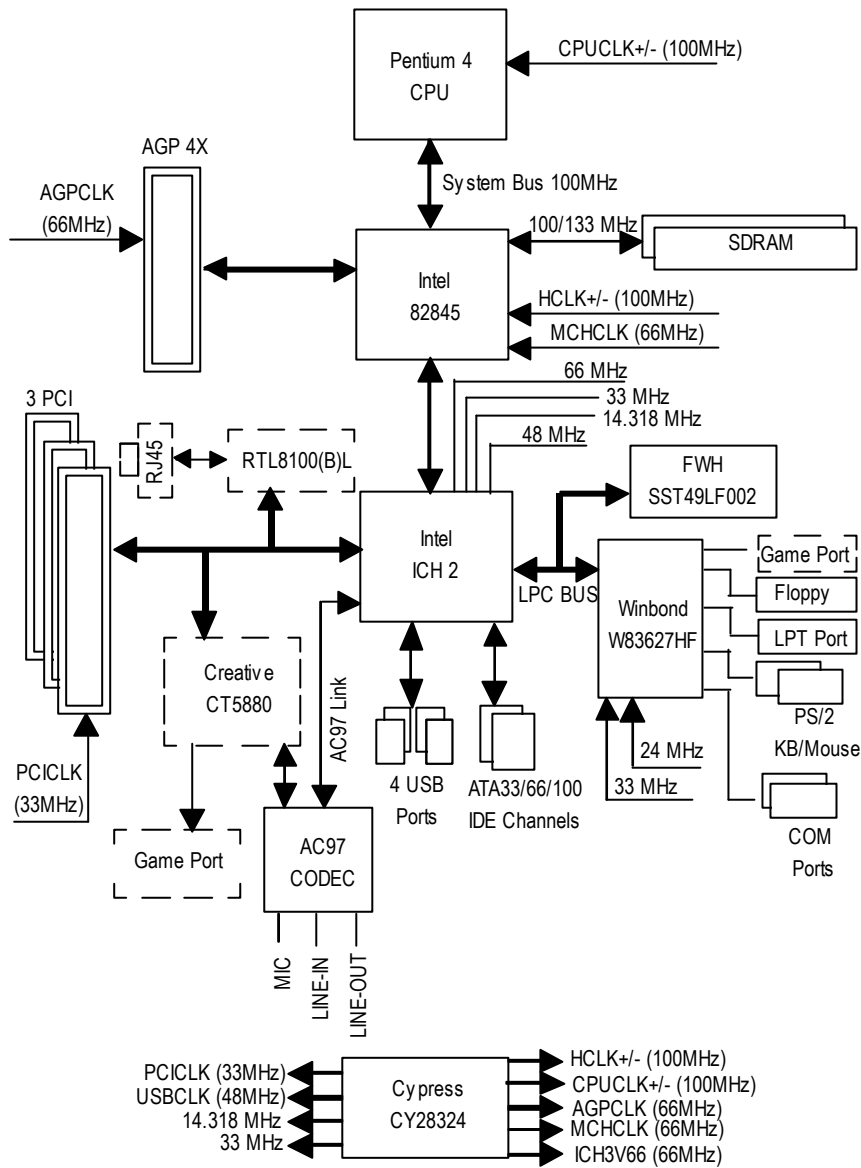

## Four Speaker & SPDIF Introduction

### Four Speaker Introduction

#### A. What is Four Speaker?

The Creative CT5880 audio chip can support up to 4 speaker output. If you select "Four speaker out", Line In will be reconfigured as another line out to support a second pair of speakers.

#### B. How to use Four Speaker?

**Microsoft Windows 98 Second Edition setup procedure:**

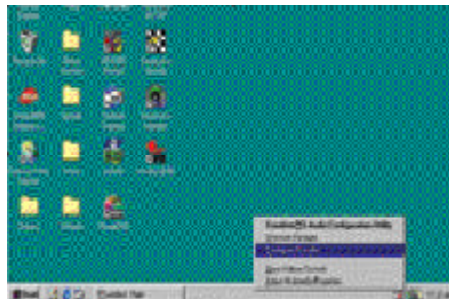

Click the audio icon along the task bar and select "Configure 3D Audio"



Select two speaker (Default)



Select "Four speaker" item.

**Microsoft Windows Me setup procedure:**

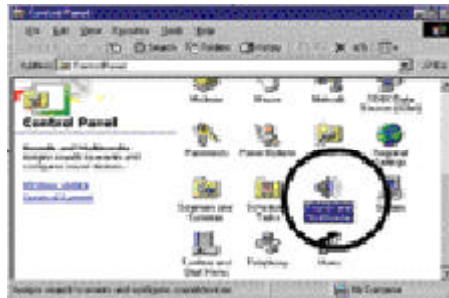

Go to "Control Panel" and double click "Sounds and Multimedia".

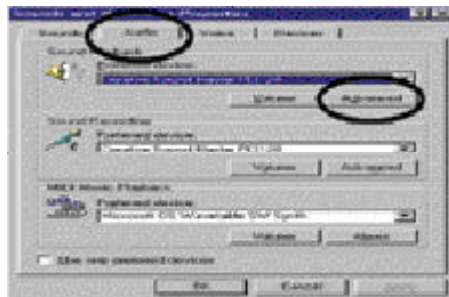

Select "Audio" Page, and click "Advanced" button.

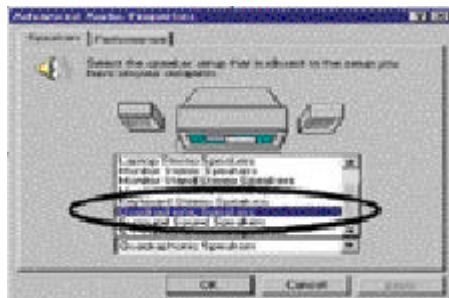

Select "Quadraphonic Speakers" and click ok.

**C. Four Speaker Application**

The four speaker function will only be supported in application softwares that use Microsoft DirectX and Creative EAX, for example, the game titles, software DVD player and MP3 player.

## SPDIF Introduction

### A. What is SPDIF?

The SPDIF output is capable of providing digital signal to AC3 decoder which can support upto 5.1 speakers.

### B. How to use SPDIF?

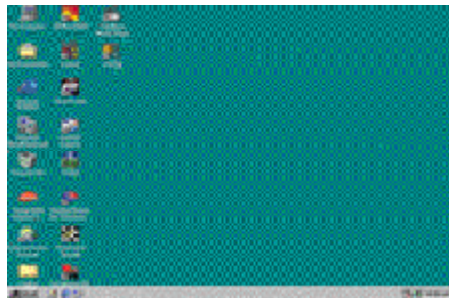

Click your mouse right button in "My Computer" and select the "Properties" item.

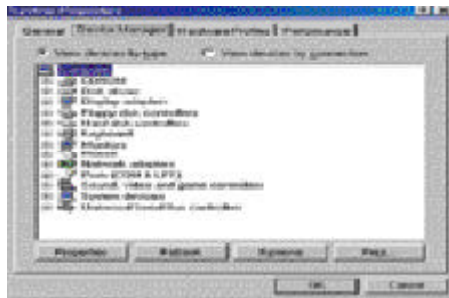

Click "Device Manager" item.

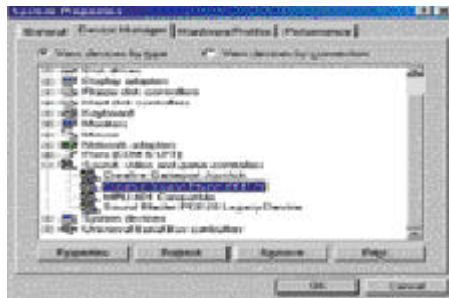

Click "Sound, video and game controllers" item and select the "Creative Sound Blaster PC1128" item.

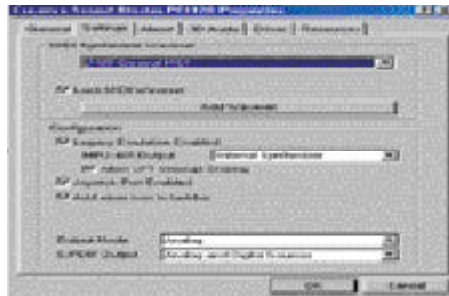

Click "Settings" item and select the "Output Mode" item.

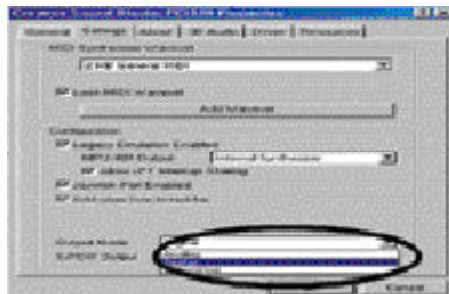

Click "Digital" item, Line Out will be reconfigure to SPDIF Out.

Recommend you to select "Autosense", It will automatically detect the type (mono or stereo) of the audio connector that you plug into Line Out audio jack, then configure Line Out to either SPDIF or Speaker accordingly.

## @ BIOS Introduction

### **Gigabyte announces @ BIOS Windows BIOS live update utility**



Have you ever updated BIOS by yourself? Or like many other people, you just know what BIOS is, but always hesitate to update it? Because you think updating newest BIOS is unnecessary and actually you don't know how to update it.

Maybe not like others, you are very experienced in BIOS updating and spend quite a lot of time to do it. But of course you don't like to do it too much. First, download different BIOS from website and then switch the operating system to DOS mode. Secondly, use different flash utility to update BIOS. The above process is not a interesting job. Besides, always be carefully to store the BIOS source code correctly in your disks as if you update the wrong BIOS, it will be a nightmare.

Certainly, you wonder why motherboard vendors could not just do something right to save your time and effort and save you from the lousy BIOS updating work? Here it comes! Now Gigabyte announces @BIOS—the first Windows BIOS live update utility. This is a smart BIOS update software. It could help you to download the BIOS from internet and update it. Not like the other BIOS update software, it's a Windows utility. With the help of "@BIOS", BIOS updating is no more than a click.

Besides, no matter which mainboard you are using, if it's a Gigabyte's product\*, @BIOS help you to maintain the BIOS. This utility could detect your correct mainboard model and help you to choose the BIOS accordingly. It then downloads the BIOS from the nearest Gigabyte ftp site automatically. There are several different choices; you could use "Internet Update" to download and update your BIOS directly. Or you may want to keep a backup for your current BIOS, just choose "Save Current BIOS" to save it first. You make a wise choice to use Gigabyte, and @BIOS update your BIOS smartly. You are now worry free from updating wrong BIOS, and capable to maintain and manage your BIOS easily. Again, Gigabyte's innovative product erects a milestone in mainboard industries.

For such a wonderful software, how much it costs? Impossible! It's free! Now, if you buy a Gigabyte's motherboard, you could find this amazing software in the attached driver CD. But please remember, connected to internet at first, then you could have a internet BIOS update from your Gigabyte @BIOS.



## Easy TuneIII™ Introduction

### Gigabyte announces *EasyTuneIII* Windows overdrive utility



“Overdrive” might be one of the most common issues in computer field. But have many users ever tried it? The answer is probably “no”. Because “overdrive” is thought to be very difficult and includes a lot of technical know-how, sometimes “overdrive” is even considered as special skills found only in some enthusiasts.

But as to the experts in “overdrive”, what's the truth? They may spend quite a lot of time and money to study, try and use many different hardware and software tools to do “overdrive”. And even with these technologies, they still learn that it's quite a risk because the safety and stability of an “overdrive” system is unknown.

Now everything is different because of a Windows overdrive utility Easy TuneIII—announced by Gigabyte. This utility has totally changed the gaming rule of “overdrive”. This is the first overdrive utility suitable for both normal and power users. Users can choose either “Easy Mode” or “Advanced Mode” to run “overdrive” at their convenience. For users who choose “Easy Mode”, they just need to click “Auto Optimize” to have auto and immediate CPU overclocking. This software will then overdrive CPU speed automatically with the result being shown in the control panel. If someone prefers to “overdrive” by oneself, there is also another choice. Click “Advanced Mode” to enjoy “sport drive” class overclocking. In “Advanced Mode”, one can change the system bus speed in small increments to get ultimate system performance. And no matter which motherboard is used, if it's a Gigabyte's product, Easy TuneIII helps to perform the best of system.

Besides, different from other traditional over-clocking methods, Easy TuneIII doesn't require users to change neither BIOS nor hardware switch/ jumper setting; on the other hand, they can do “overdrive” at only one click. Therefore, this is a safer way for “overdrive” as nothing is changed on software or hardware. If user runs Easy TuneIII over system's limitation, the biggest lost is only to restart the computer again and the side effect is then well controlled. Moreover, if one well-performed system speed been tested in Easy TuneIII, user can “Save” this bus speed and “Load” it in next time. Obviously, Gigabyte Easy TuneIII has already turned the “overdrive” technology toward to a newer generation.

This wonderful software is now free bundled in Gigabyte motherboard attached driver CD. Users may make a test drive of “Easy TuneIII” to find out more amazing features by themselves.

## Chapter 5 Appendix

Picture below are shown in Windows ME (VUCD driver version 1.8)

### Appendix A: Intel 845 Chipset Driver Installation

#### A. Windows 9x/ME/2000/XP INF Update Utility:

Insert the support CD that came with your motherboard into your CD-ROM driver or double-click the CD driver icon in My Computer to bring up the screen.

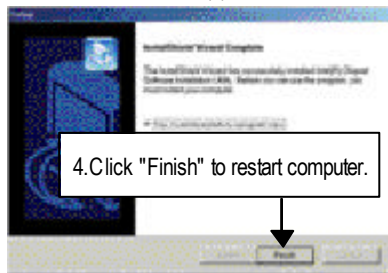
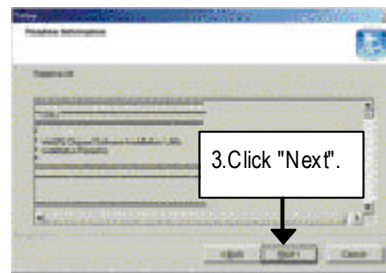
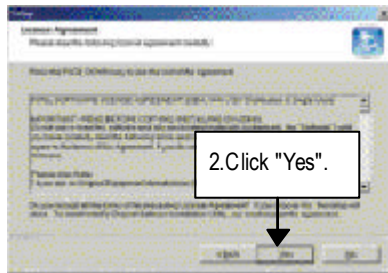
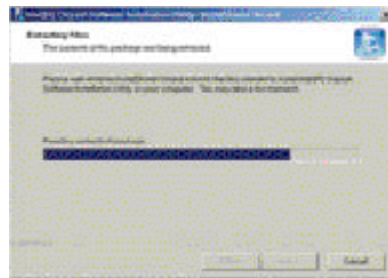
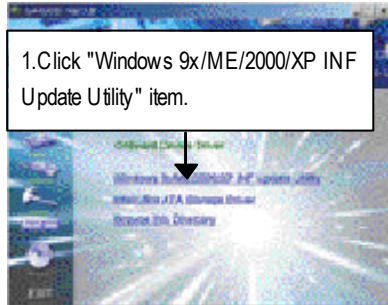

### Appendix B: Creative CT5880 Chipset Driver Installation

Insert the support CD that came with your motherboard into your CD-ROM driver or double click the CD driver icon in My Computer to bring up the screen.

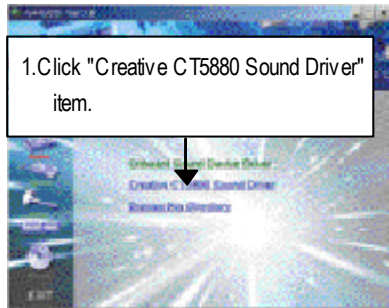

(1)

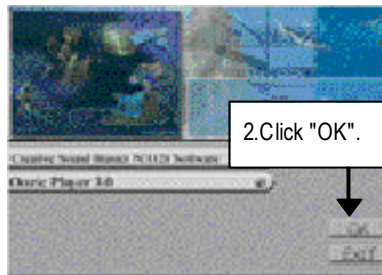

(2)

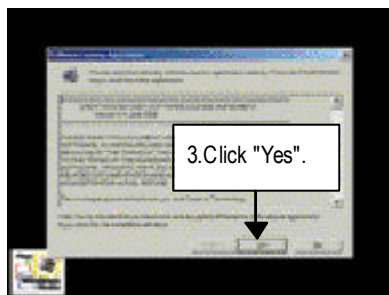

(3)



(4)

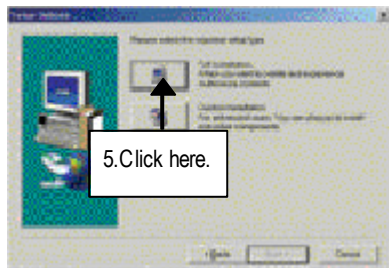

(5)

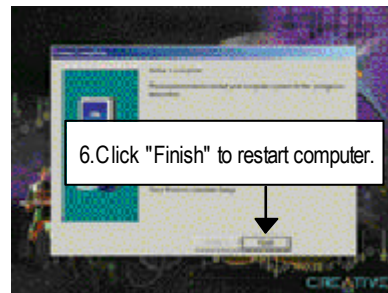

(6)

## Free Manuals Download Website

<http://myh66.com>

<http://usermanuals.us>

<http://www.somanuals.com>

<http://www.4manuals.cc>

<http://www.manual-lib.com>

<http://www.404manual.com>

<http://www.luxmanual.com>

<http://aubethermostatmanual.com>

Golf course search by state

<http://golfingnear.com>

Email search by domain

<http://emailbydomain.com>

Auto manuals search

<http://auto.somanuals.com>

TV manuals search

<http://tv.somanuals.com>