

200W
VARIABLE SPEED
SCROLL SAW
WITH REDEYE®

LS1620
INSTRUCTION MANUAL



GMC®

GLOBAL MACHINERY COMPANY

Black	Magenta	Code: LS1620		
Cyan	Yellow	Date: 060906	Edition: 05	Op: BR
用本处所有显示的颜色打印包装材料。Print artwork using ALL inks shown here.				

Contents

Introduction	3
Environmental protection	3
Description of symbols	3
Specifications	3
Safety rules for laser lights	4
General safety instructions	4
Additional safety rules for scroll saws	5
Accessories	6
Unpacking	6
Assembly	6
Know your product	7
Mounting the saw to a workbench	8
Blades	8
Selecting the correct blade	8
Removing blades	8
Installing blades	9
Setting the table for horizontal or bevel cutting	9
Aligning the degree scale pointer	9
Turning on and off	10
Sawdust blower	10
LED light	10
Adjusting the laser line	10
Adjusting the speed	11
Selecting the correct speed	11
Scroll saw operation	11
Using the REDEYE® laser line generator	12
Maintenance	12
Oiling the arm bearings	12
Cleaning	12
General inspection	13
Repairs	13

Warranty Powertools

Whilst every effort is made to ensure your complete satisfaction with this tool, occasionally, due to the mass manufacturing techniques, a tool may not live up to our required level of performance and you may need the assistance of our service department.

This product is warranted for a 2-year period for home domestic use from the date of the original purchase. If found to be defective in materials or workmanship, the tool or the offending faulty component will be repaired or replaced free of charge with another of the same item. A small freight charge may apply. Proof of purchase is essential. We reserve the right to reject any claim where the purchase cannot be verified.

This warranty does not include damage or defects to the tool caused by or resulting from abuse, accidents, alterations or commercial or business use. It also does not cover any bonus items or included accessories. Only the powertool is covered under this warranty.

With continuing product development, changes may have occurred which render the product received slightly different to that shown in this instruction manual.

Please ensure that you store your receipt in a safe place.

Conditions apply to the above warranty. For full details of the warranty terms and conditions please refer to our website – www.gmcompany.com

For prompt service we suggest you log your service request online - www.gmcservice.com.au, should you not have access to the internet, please contact our service department on 1300 880 001 (Australia) or 0800 445 721 (New Zealand).

Introduction

Your new GMC power tool will more than satisfy your expectations. It has been manufactured under stringent GMC Quality Standards to meet superior performance criteria.

You will find your new tool easy and safe to operate, and, with proper care, it will give you many years of dependable service.

CAUTION. Carefully read through this entire Instruction Manual before using your new GMC Power Tool. Take special care to heed the Cautions and Warnings.

Your GMC power tool has many features that will make your job faster and easier. Safety, performance, and dependability have been given top priority in the development of this tool, making it easy to maintain and operate.

Environmental protection



Recycle unwanted materials instead of disposing of them as waste. All tools, hoses and packaging should be sorted, taken to the local recycling centre and disposed of in an environmentally safe way.

WARNINGS

It may be more difficult to see the laser line in conditions of bright sunshine and on certain surfaces.

Description of symbols

The rating plate on your tool may show symbols. These represent important information about the product or instructions on its use.



Wear hearing protection.

Wear eye protection.

Wear breathing protection.



N380

Conforms to relevant standards for electromagnetic compatibility.

Specifications

Nominal voltage:	230–240Vac ~ 50Hz
Power:	200W
Speed:	400–1600 SPM
Depth of cut:	50mm
Stroke length:	20mm
Blade length:	127mm
Blade change:	Tool-free
Bevel angle:	0° to 45° left and right
Throat depth:	405mm
Laser class:	II
Laser wavelength:	650nm
Laser output power:	≤1mW

Safety rules for laser lights

The laser light/laser radiation used in the GMC REDEYE® system is Class 2 with maximum 1mW and 650nm wavelengths. These lasers do not normally present an optical hazard, although staring at the beam may cause flash blindness.

WARNING. Do not stare directly at the laser beam. A hazard may exist if you deliberately stare into the beam, please observe all safety rules as follows;

- The laser shall be used and maintained in accordance with the manufacturer's instructions.
- Never aim the beam at any person or an object other than the work piece.

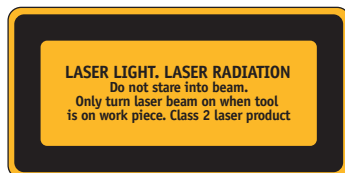

- The laser beam shall not be deliberately aimed at personnel and shall be prevented from being directed towards the eye of a person for longer than 0.25s.
- Always ensure the laser beam is aimed at a sturdy work piece without reflective surfaces. i.e. wood or rough coated surfaces are acceptable. Bright shiny reflective sheet steel or the like is not suitable for laser use as the reflective surface could direct the beam back at the operator.
- Do not change the laser light assembly with a different type. Repairs must only be carried out by the laser manufacturer or an authorised agent.

CAUTION. Use of controls or adjustments or performance of procedures other than those specified herein may result in hazardous radiation exposure.

Please refer to the relevant Australian standards, AS 2397 and AS/NZS2211 for more information on Lasers.

General safety instructions

To use this tool properly, you must observe the safety regulations, the assembly instructions and the operating instructions to be found in this Manual. All persons who use and service the machine have to be acquainted with this Manual and must be informed about its potential hazards. Children and infirm people must not use this tool. Children should be supervised at all times if they are in the area in which the tool is being used. It is also imperative that you observe the accident prevention regulations in force in your area. The same applies for general rules of occupational health and safety.

WARNING. When using power tools, basic safety precautions should always be taken to reduce the risk of fire, electric shock and personal injury. Also, please read and heed the advice given in the additional important safety instructions.

- 1. Keep the work area clean and tidy.** Cluttered work areas and benches invite accidents and injury.
- 2. Consider the environment in which you are working.** Do not use power tools in damp or wet locations. Keep the work area well lit. Do not expose power tools to rain. Do not use power tools in the presence of flammable liquids or gases.
- 3. Keep visitors away from the work area.** All visitors and onlookers, especially children and infirm persons, should be kept well away from where you are working. Do not let others in the vicinity make contact with the tool or extension cord.
- 4. Store tools safely.** When not in use, tools should be locked up out of reach.
- 5. Do not force the tool.** The tool will do the job better and safer working at the rate for which it was designed.
- 6. Use the correct tool for the job.** Do not force small tools or attachments to do the job best handled by a heavier duty tool. Never use a tool for a purpose for which it was not intended.

- 7. Dress correctly.** Do not wear loose clothing or jewellery. They can be caught in moving parts. Rubber gloves and non-slip footwear are recommended when working outdoors. If you have long hair, wear a protective hair covering.
 - 8. Use safety accessories.** Safety glasses and earmuffs should always be worn. A face or dust mask is also required if the sanding operation creates dust.
 - 9. Do not abuse the power cord.** Never pull the cord to disconnect the tool from the power point. Keep the cord away from heat, oil and sharp edges.
 - 10. Secure the work piece.** Use clamps or a vice to hold the work piece. It is safer than using your hand and frees both hands to operate the tool.
 - 11. Do not overreach.** Keep your footing secure and balanced at all times.
 - 12. Look after your tools.** Keep tools sharp and clean for better and safer performance. Follow the instructions regarding lubrication and accessory changes. Inspect tool cords periodically and, if damaged, have them repaired by an authorised service facility. Inspect extension cords periodically and replace them if damaged. Keep tool handles dry, clean and free from oil and grease.
 - 13. Disconnect idle tools.** Switch off the power and disconnect the plug from the power point before servicing, when changing accessories and when the tool is not in use.
 - 14. Remove adjusting keys and wrenches.** Check to see that keys and adjusting wrenches are removed from the tool before switching on.
 - 15. Avoid unintentional starting.** Always check that the switch is in the OFF position before plugging in the tool to the power supply. Do not carry a plugged in tool with your finger on the switch.
 - 16. Use outdoor rated extension cords.** When a tool is used outdoors, use only extension cords that are intended for outdoor use and are so marked.
 - 17. Stay alert.** Watch what you are doing. Use common sense. Do not operate a power tool when you are tired.
 - 18. Check for damaged parts.** Before using a tool, check that there are no damaged parts. If a part is slightly damaged, carefully determine if it will operate properly and perform its intended function. Check for alignment of moving parts, binding of moving parts, breakage of parts, proper mounting and any other conditions that may affect the operation of the tool. A part that is damaged should be properly repaired or replaced by an authorised service facility, unless otherwise indicated in this Instruction Manual. Defective switches must be replaced by an authorised service facility. Do not use a tool if the switch does not turn the tool on and off correctly.
 - 19. Guard against electric shock.** Prevent body contact with grounded objects such as water pipes, radiators, cookers and refrigerator enclosures.
 - 20. Use only approved parts.** When servicing, use only identical replacement parts. Use an authorised service facility to fit replacement parts.
- ### Additional safety rules for scroll saws
- Do not alter or misuse the tool. These tools are precision built. Any alteration or modification not specified is misuse and may result in dangerous conditions.
 - For your own safety, do not operate your scroll saw until it is completely assembled and installed according to the instructions and until you have read and understood all of the instructions.
 - Your scroll saw must be bolted securely to a stand or work bench. In addition, if there is any tendency for the scroll saw to tip over or move during certain operations, such as cutting long, heavy boards, bolt your scroll saw stand or workbench to the floor.
 - This scroll saw is intended for indoor use only.
 - To avoid being pulled into the blade, do not wear loose fitting gloves, loose clothing, neck ties or jewellery. Tie back long hair and roll long sleeves above elbows.

- Do not cut pieces too small to hold by hand. When making a small cutout always secure the workpiece to a scrap piece of plywood with double sided tape. This way the work is supported and your fingers are away from the blade.
- Never turn your scroll saw on before clearing the table of all objects (tools, scraps of wood, etc.) except for the workpiece.
- Avoid awkward hand positions where a sudden slip could cause a hand to move into the blade.
- Always adjust the drop foot to just clear the workpiece to protect the operator, keep blade breakage to a minimum and provide maximum support for the blade.
- Always adjust blade tension correctly.
- The scroll saw should cut on the down stroke. Always make sure blade teeth are oriented downward towards the table.
- When cutting a large piece of material make sure it is supported at table height.
- Hold the work firmly against the table.
- Do not feed the material too fast while cutting. Only feed the material fast enough so that the blade will cut.
- Use caution when cutting off material which is irregular in cross section as it could pinch the blade before the cut is completed. A piece of moulding, for example, must lay flat on the table and not be permitted to rock whilst being cut.
- Use caution when cutting off round material such as dowel rods or tubing. They have a tendency to roll while being cut causing the blade to bite.
- Never leave the scroll saw running unattended. Always turn the saw off, make sure that it has come to a complete stop, and then remove plug from the power supply before leaving the work area.
- Do not perform layout, assembly or setup work on the table while the cutting tool is operating.
- Turn saw off and remove plug from power supply outlet before installing or removing blades.

Wear safety goggles

Wear ear protection

Wear a breathing mask

Accessories

The GMC LS1620 Scroll Saw is supplied with the following accessories as standard:

- 15 TPI saw blade
- 18 TPI saw blade
- Allen key
- Instruction manual

Unpacking

Due to modern mass production techniques, it is unlikely that your GMC Power Tool is faulty or that a part is missing. If you find anything wrong, do not operate the tool until the parts have been replaced or the fault has been rectified. Failure to do so could result in serious personal injury.

The scroll saw you have purchased is ideal for numerous projects including making toys, puzzles, games, artwork and jewellery, and due to its cutting capacity is a handy do-it-yourself tool. It cuts wood up to 50mm thick as well as plastics.

Assembly

The GMC Scroll saw is packed fully assembled.

Know your product

Before using the tool, familiarise yourself with all the operating features and safety requirements.

Use the tool and accessories only for the applications intended. All other applications are expressly ruled out.

1. On/off switch / variable speed dial
2. Laser light on/off switch
3. LED light on/off switch
4. Laser aperture
5. Laser line alignment knob
6. Sawdust blower
7. LED light
8. Drop foot
9. Drop foot locking knob
10. Table
11. Table insert
12. Blade tension lever
13. Blade adapters
14. Blade adapter knobs
15. Blade
16. Bevel adjustment scale
17. Table lock knob
18. Table adjustment knob
19. Blade storage compartment

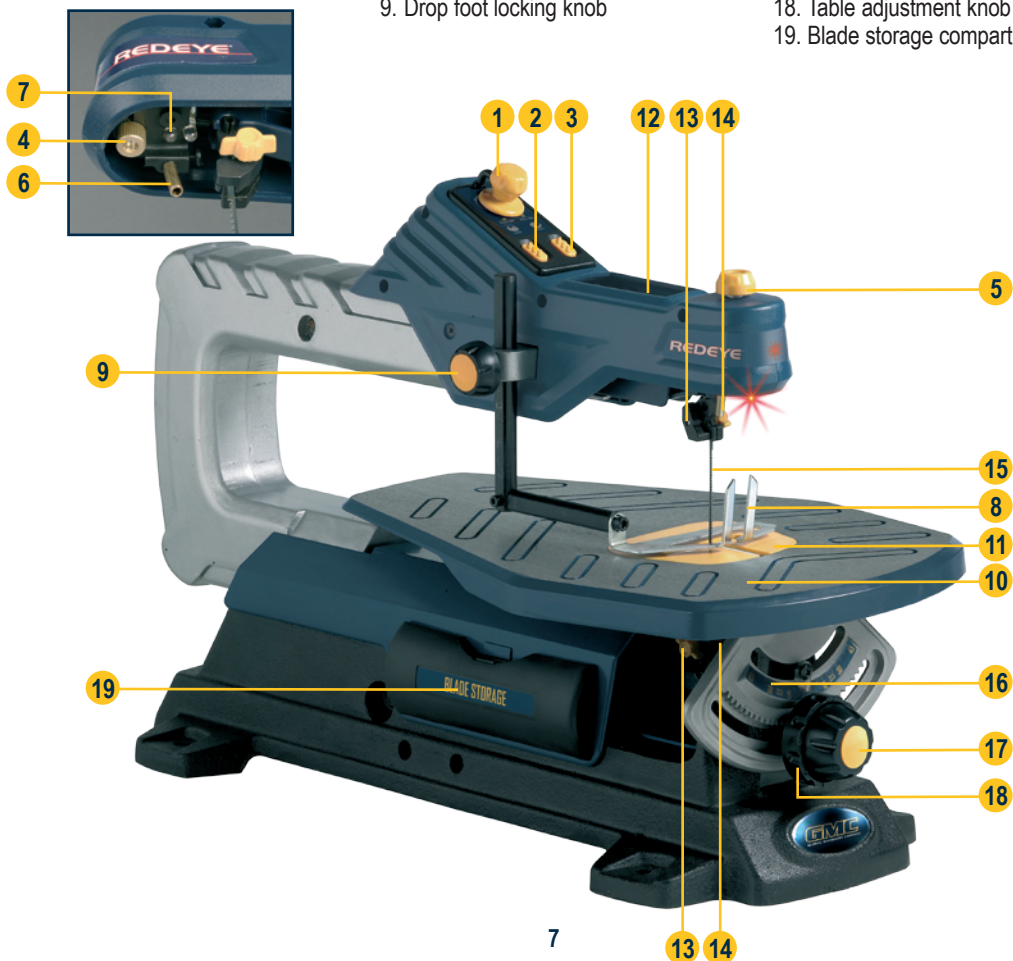

Mounting the saw to a workbench

It is recommended that the scroll saw is secured to a work bench to gain maximum stability and prevent noise and vibration.

1. Using the base of the scroll saw as a template mark the holes on the workbench through the holes in the casting.
2. Drill the holes through the workbench using an 8mm drill bit.
3. Bolt the saw to the workbench using bolts, washers and nuts.

Note. The fasteners are not supplied with the machine.

Note. A soft foam pad or carpet (not supplied) can be placed between the scroll saw and the work bench to further reduce noise and vibration.



Blades

The scroll saw accepts 127mm pin type and flat blades. A flat blade adapter is not required.

Selecting the correct blade

1. The scroll saw accepts a wide variety of blade widths and thicknesses for cutting wood and other wood based materials.
2. The blade width, thickness, and number of teeth per inch will be determined by the material and size of the radius being cut.
3. Select a blade that allows at least three (3) teeth to be in contact with the workpiece at all times.
4. Very fine, narrow blades should be used for curve cutting in thin wood (6mm or less).
5. To cut thicker wood, use wider blades with fewer teeth per inch.
6. When cutting wood thicker than 25mm, guide the workpiece into the blade slowly and take care not to bend or twist the blade whilst cutting.

7. Most blade packages state the size or thickness of wood which that blade is intended to cut, and the radius (size of curve) which can be cut with that blade.
8. Wider blades cannot cut curves as tight or small as thinner blades.
9. This saw uses 127mm long pin type and flat blades.
10. Blades wear faster when:
 - a. Cutting plywood which is very abrasive
 - b. Cutting wood that is thicker than 19mm
 - c. Cutting hardwood
 - d. Side pressure is placed on the blade

Removing blades

CAUTION. Always ensure that the saw is switched off and unplugged from the mains supply before removing or installing a blade.

1. Lift up the blade tension lever (12) to reduce the blade tension.
2. Remove the table insert (11) by raising it with a screwdriver.
3. Loosen the upper and lower blade adapter knobs (14).
4. Remove blade from the upper and lower blade adapters (13).

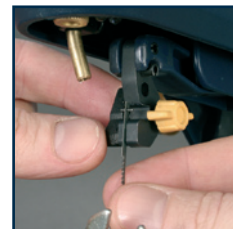

Installing blades

CAUTION. Always ensure that the saw is switched off and unplugged from the mains supply before removing or installing a blade.

1. Lift up the blade tension lever (12) to reduce the blade tension.
2. Remove the table insert (11) by raising it with a screwdriver.
3. Loosen the upper and lower blade adapter knobs (14). Ensure that the slots on the upper and lower blade adapters are wider than the thickness of the blade.
4. In order to cut effectively and avoid uncontrollable lifting of the workpiece, the teeth of the scroll saw blade must always point in a downward direction.
5. Insert the blade in the lower blade adapter and tighten the blade adapter knob.
6. Press the upper arm down and insert the top part into the upper blade adapter and tighten the blade adapter knob.
7. Lower the blade tension lever to secure the blade in position.
8. If the tension is too tight when lowered, lift the blade tension lever back up and turn it in an anti-clockwise direction to loosen the blade tension.
9. If the tension is too loose when lowered, lift the blade tension lever back up and turn it in a clockwise direction to tighten the blade tension.
10. Replace the table insert.

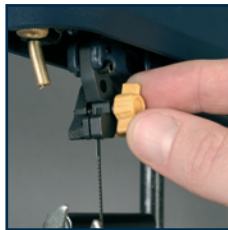

Setting the table for horizontal or bevel cutting

CAUTION. Always ensure that the saw is switched off and unplugged from the mains supply before making any adjustments.

1. Loosen the table lock knob (17) to allow the saw table to be tilted to the left and right. The table can be locked at any angle from a 0° horizontal cutting position up to a 45° angle both to the left and right for bevel cutting.
2. Rotate the table adjustment knob (18) to move the table from left to right. Rotate the knob in a clockwise direction to move the table to the left and an anti-clockwise direction to move the table to the right.
3. A bevel adjustment scale (16) is positioned under the work table to assist in setting the appropriate table angle for bevel cutting. When greater precision is required, make a practice cut first and then adjust the table as necessary for your requirements.



Note. When bevel cutting, the drop foot (8) can be tilted so it's parallel to the table and rests flat against the workpiece. To tilt the drop foot, loosen the Allen screw at the front of the drop foot assembly and then tilt the foot so that it's parallel to the table, re-tighten the Allen screw to secure the drop foot in place.

Aligning the degree scale pointer

1. Loosen the table lock knob (17) and rotate the table adjustment knob (18) to position the table at a right angle to the blade.
2. Place a small square on the table next to the blade to check if the table is at a 90° angle to the blade. If adjustment is needed, change the bevel angle until the

table is at approximately 90° to the blade and securely tighten the table lock knob (17).

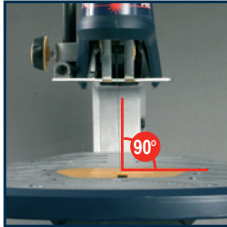

3. Loosen the Phillips head screw holding the degree scale pointer and move the pointer to the 0° position. Securely tighten the screw.

Note. The degree scale is a convenient guide but should not be relied upon for precision. Always make a practice cut in scrap wood to determine if your angle settings are correct.

Turning on and off

1. To turn on the scroll saw lift the on/off switch (1).
2. To turn off the scroll saw push the on/off switch (1) down.



Sawdust blower

Your scroll saw features a sawdust blower (6) to help keep the work area clean for more accurate scroll cuts. The blower tube is factory set to direct air flow at the blade and workpiece.



LED light

The LED light will illuminate the work area for greater visibility of the cutting line.

1. To turn on the LED light press the LED light button (3) on the control panel.



Note. The LED light will not function if the saw is not in the 'on' position.

Adjusting the laser line

1. To adjust the laser beam first turn on the scroll saw using the on/off switch (1)



2. To adjust the laser line turn the laser line alignment knob (5) in an anti-clockwise direction to loosen it and then move it to the left or right until the laser line is in line with the blade. Turn the laser line alignment knob (5) in a clockwise direction to tighten it.



3. Turn off the scroll saw.

Adjusting the speed

The speed can be adjusted to suit the workpiece being cut. The variable speed dial (1) is located at the top of the saw for convenient adjustment of the speed.

1. Turn the saw on by lifting the on/off switch (1).
2. Turn the dial in a clockwise direction for a faster speed and in an anti-clockwise direction to reduce the speed.
3. Determine the optimum speed by making a trial cut in a scrap piece of material.

Note. Using the correct speed for the job increases the life of the saw blade.



Selecting the correct speed

The below table shows the most appropriate blade and speed to be used for different materials and applications.

Scroll saw operation

1. Ensure that the table insert is in place and flush with the table.
2. To start the saw lift up the on/off switch (1).
3. Adjust the speed to suit the workpiece being cut.
4. To begin the cut guide the wood into the moving saw blade, the blade teeth cut only on the down stroke.

Blade Teeth per Inch	Width	Thickness	Strokes per Minute	Material and Application
6 - 10	2.8mm	0.5mm	1200–1600	Hard and soft woods from 5mm to 50mm thick plastics, paper, felt
10 - 15	2.8mm	0.5mm	600–1200	Wood, plastics, extremely thin cuts in materials 2.5mm to 13mm thick
15 - 18	2.4mm	0.3mm	400–600	Tight radius work in thin materials 2.5mm to 3mm thick. Wood, veneer, fiber, plastic.

5. The saw will not cut wood by itself, you allow the saw to cut wood by guiding the wood into the blade as it moves.
6. The drop foot (8) should always be lowered until it just rests on top of the workpiece to prevent your workpiece from lifting during operation but not so much that the workpiece drags. To lower or raise the drop foot loosen the drop foot locking knob (9) and position the drop foot so it rests on top of the work piece. Retighten the drop foot locking knob.
7. Ensure that you feed the wood into the blade slowly because the teeth of the blade are very small and they can only remove wood when they are on the down stroke.
8. The blade will flex backwards when applying feed pressure. Too much feed pressure will cause blade breakage.
9. Best results are achieved when cutting wood less than 25mm thick.
10. When cutting wood thicker than 25mm, the user must feed the wood into the blade very slowly, increase blade tension and take extra care not to bend or twist the blade while cutting in order to maximise blade life.
11. Teeth on scroll saw blades wear quickly and as a result must be replaced frequently for best cutting results. Scroll saw blades generally stay sharp for 30 minutes to 2 hours of cutting.
12. Once finished push the on/off switch down to turn off the saw and unplug the tool from the power point to prevent unauthorised use.

Using the REDEYE® laser line generator

WARNINGS. Do not stare directly at the laser beam.

Never aim the beam at any person or an object other than the work piece.

Do not deliberately aim the beam at personnel and ensure that it is not directed towards the eye of a person for longer than 0.25s.

Always ensure the laser beam is aimed at a sturdy work piece without reflective surfaces, i.e. wood or rough coated surfaces are acceptable. Bright shiny reflective sheet steel or the like is not suitable for laser use as the reflective surface could direct the beam back at the operator.

1. Mark the line of cut on the workpiece.
2. To start the saw lift up the on/off switch (1).
3. Adjust the speed to suit the workpiece being cut.
4. Switch on the laser beam using the laser light on/off switch (2).
5. Line up the laser line with the line on the workpiece
6. To begin the cut guide the wood into the moving saw blade.

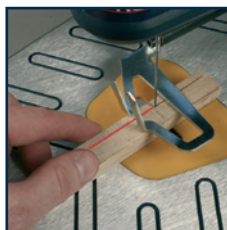
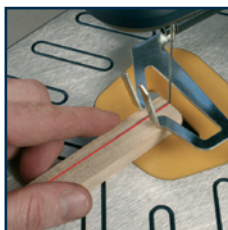
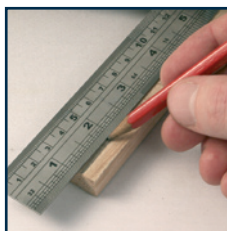

7. Switch off the laser beam on completion of the cut.
8. Once finished push the on/off switch down to turn off the saw and unplug the tool from the power point to prevent unauthorised use.

Maintenance

WARNING. Always ensure that the tool is switched off and the plug is removed from the power point before making and adjustments or maintenance procedures.

An occasional coat of paste wax on the work table will allow the wood being cut to glide smoothly across the work surface.

Oiling the arm bearings

The saws arm bearings should be lubricated after every 50 hours of use. Ensure plug is removed from the mains power supply.

1. Turn the saw on its side.
2. Squirt a generous amount of SAE 20 oil around the shaft end and bronze bearings.



3. Let the oil soak in overnight in this position.
4. Next day repeat the above procedure for the opposite side of the saw.

Cleaning

1. Keep the tool's air vents unclogged and clean at all times.
2. Remove dust and dirt regularly. Cleaning is best done with a brush or a rag.
3. Re-lubricate all moving parts at regular intervals.
4. Never use caustic agents to clean plastic parts.

CAUTION. Do not use cleaning agents to clean the plastic parts of the tool. A mild detergent on a damp cloth is recommended. Water must never come into contact with the saw.

General inspection

Regularly check that all the fixing screws are tight. They may vibrate loose over time.

Repairs

Only an authorised service centre should replace the cordset or effect other repairs. If the cordset is damaged or worn, have it repaired or replaced by an authorised service centre.

GMC customer assist

If your product needs repairing, replacing, technical service or you simply need help or advice, please contact us on our Customer Assist Line 1300 880 001 (Australia) or 0800 445 721 (New Zealand).

For prompt service we suggest you log your service request online at www.gmcservice.com.au. Should you not have access to the Internet, please contact our service department on 1300 880 001 (Australia) or 0800 445 721 (New Zealand). 7am – 7pm, 7days a week (AEST).

Please note that if repair or replacement is required, you must provide a valid original purchase receipt.

You will need the following details at hand to log your service request;

Personal details: First & Last name, address, pick up address, contact phone numbers, email address

Product details: Product number, date of purchase, retailer bought from, State & postcode, receipt number, reason for the request, copy of official purchase receipt

Attach your purchase receipt and save with this Manual for future reference.

Please refer to our website www.gmcompany.com for full GMC warranty Terms and Conditions.

Attach Your
Receipt Here

GMC[®]
GLOBAL MACHINERY COMPANY

Free Manuals Download Website

<http://myh66.com>

<http://usermanuals.us>

<http://www.somanuals.com>

<http://www.4manuals.cc>

<http://www.manual-lib.com>

<http://www.404manual.com>

<http://www.luxmanual.com>

<http://aubethermostatmanual.com>

Golf course search by state

<http://golfingnear.com>

Email search by domain

<http://emailbydomain.com>

Auto manuals search

<http://auto.somanuals.com>

TV manuals search

<http://tv.somanuals.com>