

DUAL-DECK VCR

# DDV2110

USER'S GUIDE



SSC.2110.042501

- 4-Head Hi-Fi x 4-Head Hi-Fi
- Jog/Shuttle Remote
- Auto Head Cleaner

COMMERCIAL ▶▶ **ADVANCE**®  
MOVIE ▶▶ **ADVANCE**®  
COMMERCIAL FREE COPY



## Congratulations...

...on your purchase of this Go-Video Dual-Deck VCR!

We know you will enjoy this product for many years to come. In case warranty service is required, please take a moment to attach your receipt to this manual and write down your **Serial Number** (located on the back panel of the VCR): \_\_\_\_\_ .

### About this Manual

This manual has been designed to acquaint you with all the features and functionality of the Dual-Deck VCR. The first two chapters cover basic setup and a quick tour of the components of the Dual-Deck system. Chapters 3-9 present in detail each major Dual-Deck function—from playing tapes to Commercial Free Copy—so you can jump in anywhere that interests you. The three Appendices cover advanced connections, manual setup, and help, respectively. For your reference, a "Menu Tree" is also included on the inside back cover. Enjoy the Dual-Deck experience!

### CAUTION:

To prevent fire, shock hazard, or annoying interference, use only the recommended accessories.

To prevent electric shock, do not use this (polarized) plug with an extension cord, receptacle, or other outlet unless the blades can be fully inserted to prevent blade exposure.

To reduce the risk of electric shock, do not remove the unit cover or back. There are no serviceable parts inside. Refer servicing to qualified personnel only.

### CUIDADO:

Para prevenir incendio, riesgo de choque, o interferencia enfadosa, use solamente los accesorios recomendados.

Para prevenir electrochoque, no use este enchufe (polarizado) con un cordón de extensión, toma de corriente, o cualquier otra toma a menos que los dientes puedan ser completamente insertados para prevenir exposición de los dientes.

Para reducir el riesgo de descarga eléctrica, no remueva la cubierta o la parte posterior del VCR. Dentro del VCR no hay partes que requieren servicio. Diríjase solamente a personal calificado cuando requiera servicio.

### ATTENTION:

Pour éviter les incendis, risque de chocs, ou interférences fâcheuses, employer seulement les accessoires recommandés.

Pour éviter les chocs électriques, ne pas employer cette prise (polarisée) avec une rallonge, une prise de courant ou une autre sortie de courant à moins que les lames peuvent être insérées à fond pour l'exposition des lames.

Pour réduire les risques de chocs électriques, ne pas retirer le couvercle ou l'arrière du module. Il n'y a pas de pièce utilisable à l'intérieur. Ne faire effectuer l'entretien que par un personnel qualifié.

### USER/INSTALLER CAUTION:



Your authority to operate this FCC certified equipment could be voided if you make changes or modifications not expressly approved by the manufacturer, who is responsible for compliance with Part 15 FCC rules.

### NOTE TO CATV SYSTEM INSTALLER:

This reminder is provided to call the CATV system installer's attention to Article 820-40 of the National Electronic Code that provides guidelines for proper grounding and, in particular, specifies that the cable ground shall be connected to the grounding system of the building, as close to the point of cable entry as practical.

### COPYRIGHT NOTICE

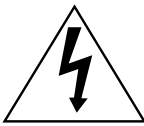
Federal law provides severe civil and criminal penalties for the unauthorized reproduction, distribution, or exhibition of copyrighted motion pictures and videotapes. (Title 17, United States Code, Sections 501 and 506).

 <p><b>CAUTION</b> RISK OF ELECTRIC SHOCK DO NOT OPEN</p> <p>CAUTION: TO REDUCE THE RISK OF ELECTRIC SHOCK DO NOT REMOVE COVER NO USER-SERVICEABLE PARTS INSIDE REFER SERVICING TO QUALIFIED SERVICE PERSONNEL</p>		<p>This symbol is intended to alert the user to the presence of uninsulated dangerous voltage within the product's enclosure that may be of sufficient magnitude to constitute risk of fire or electric shock.</p>
		<p>This symbol is intended to alert the user to the presence of important operating and maintenance instructions in the literature accompanying this product.</p>

SAFETY ..... iii

**1 - GETTING STARTED 1**

    Unpacking ..... 1

    Basic Connections ..... 2

    Auto Setup ..... 3

    Remote Control Setup ..... 4

**2 - QUICK TOUR 5**

    Remote Control ..... 5

    Front Panel ..... 7

    Front Panel Display ..... 8

    On-screen Display ..... 9

**3 - COPY 10**

    Basic Copying ..... 10

    Copy Settings ..... 11

**4 - PLAY 12**

    Basic Playback ..... 12

    Playback Settings ..... 13

**5 - RECORD 14**

    Basic Recording ..... 14

    Record Settings ..... 15

**6 - TIMER RECORD 16**

    Timer Recording ..... 16

    Timer Recording Errors ..... 18

**7 - EDIT 19**

    Automatic Editing ..... 19

    Manual Editing ..... 20

    Copy Audio Insert ..... 21

    On-screen Titler ..... 22

**8 - COMMERCIAL ADVANCE 23**

    Commercial Advance ..... 23

    Marking Commercials ..... 24

    Commercial Advance Playback ..... 25

    Commercial Free Copy ..... 26



**9 - SEARCH 27**

About Index Marks ..... 27  
Index Search/Scan ..... 28  
Special Search Options ..... 29  
Movie Advance ..... 30

**APPENDIX A - ADVANCED CONNECTIONS 31**

RF Output Channel ..... 31  
Stereo/Monitor Hookup ..... 32  
Other A/V Hookup ..... 33  
Alternative Cable Box Hookup ..... 34  
Line Input Labeling ..... 35

**APPENDIX B - CUSTOM SETTINGS 36**

Language Settings ..... 36  
Auto Clock Settings ..... 37  
Manual Clock Settings ..... 38  
Daylight Savings Time ..... 39  
Channel Settings ..... 40  
VCR Settings ..... 41  
Reset Factory Settings ..... 42

**APPENDIX C - HELP 43**

Troubleshooting ..... 43  
Technical Specifications ..... 45  
Warranty ..... 46

**INDEX 47**

## IMPORTANT SAFETY INSTRUCTIONS

**READ INSTRUCTIONS**

All the safety and operating instructions should be read before the unit is operated.

**RETAIN INSTRUCTIONS**

The safety and operating instructions should be retained for future reference.

**HEED WARNINGS**

All warnings on the unit and in the operating instructions should be adhered to.

**FOLLOW INSTRUCTIONS**

All operating and maintenance instructions should be followed.

**CLEANING**

Unplug this video unit from the wall outlet before cleaning. Do not use liquid or aerosol cleaners. Use a dry cloth for dusting cabinet.

**ATTACHMENTS**

Do not use attachments not recommended by the video product manufacturer, as they may be hazardous.

**WATER & MOISTURE**

Do not use this video unit near water—for example, near a bathtub, wash bowl, kitchen sink, laundry tub, in a wet basement, near a swimming pool or the like.

**ACCESSORIES**

Do not place this video unit on an unstable cart, stand, tripod, bracket or table. The video unit may fall, causing serious injury to a child or adult, and serious damage to the unit. Use only with a cart, stand, tripod, bracket or table recommended by the manufacturer or sold with the video unit. Any mounting of the unit should follow the manufacturer's instructions and should use a mounting accessory recommended by the manufacturer.



An appliance and cart combination should be moved with care. Quick stops, excessive force, and uneven surfaces may cause the appliance and cart combination to overturn.

**PORTABLE CART WARNING**  
(Symbol provided by RETAC)

**VENTILATION**

Slots and openings in the cabinet are provided for ventilation to ensure reliable operation of the video unit and to protect it from overheating. These openings must not be blocked or covered. Never place your VCR on a bed, sofa, rug or other similar surface, on or near a radiator or heat register. This video unit should not be placed in a built-in installation such as a bookcase or rack unless proper ventilation is provided or the manufacturer's instructions have been adhered to.

**POWER SOURCES**

This video unit should be operated only from the type of power source indicated on the marking label. If you are not sure of the type of power supply to your home consult your appliance dealer or local power company. For video units intended to be operated from battery power, or other sources, refer to the operating instructions.

**GROUNDING OR POLARIZATION**

This video unit may be equipped with either a polarized 2-wire AC line plug (a plug having one blade wider than the other) or a 3-wire grounding plug having a third (grounding) pin.

The 2-wire polarized plug will fit into the power outlet only one way. This is a safety feature. If you are unable to insert the plug fully into the outlet try reversing the plug. If the plug still fails to fit, contact your electrician to replace your obsolete outlet. Do not defeat the safety purpose of the polarized plug.

**POWER-CORD PROTECTION**

Power-supply cords should be routed so that they are not likely to be walked on or pinched by items placed upon or against them, paying particular attention to cords of plugs, convenience receptacles, and the point where they exit from the unit.

**OUTDOOR ANTENNA GROUNDING**

If an outside antenna or cable system is connected to the video unit, be sure the antenna or cable system is grounded to provide some protection against voltage surges and built-up static charges. Section 810 of the National

Electrical Code, ANSI/NFPA No. 70-1984, provides information with respect to proper grounding of the mast and supporting structure, grounding of the lead-in wire to an antenna discharge unit, size of grounding conductors, location of antenna-discharge unit, connection to grounding electrodes, and requirements for the grounding electrode. See figure below.

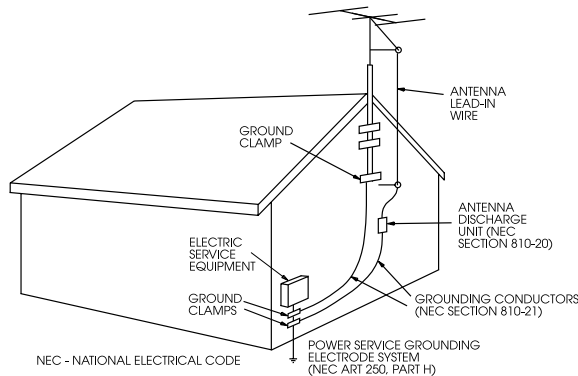

### LIGHTNING

For added protection of this video unit during a lightning storm, or when it is left unattended and unused for long periods of time, unplug it from the wall outlet and disconnect the antenna or cable system. This will prevent damage to the video unit due to lightning and power line surges.

### POWER LINES

An outside antenna system should not be located in the vicinity of overhead power lines or other electric light or power circuits, where it can fall into such power lines or circuits. When installing an outside antenna system extreme care should be taken to keep from touching such power lines or circuits as contact with them might be fatal.

### OVERLOADING

Do not overload wall outlets and extension cords as this can result in the risk of fire or electric shock.

### OBJECTS AND LIQUIDS

Never push objects of any kind into this video unit through openings as they may touch dangerous voltage points or short out parts that could result in a fire or electric shock. Never

spill liquids of any kind onto the unit. Should spillage occur, unplug unit and have it checked by a technician before use.

### SERVICING

Do not attempt to service this video unit yourself as opening or removing covers may expose you to a dangerous voltage or other hazards. Refer all servicing to qualified service personnel.

### DAMAGE REQUIRING SERVICE

Unplug this video unit from the wall outlet and refer servicing to qualified service personnel under the following conditions:

- When the power supply cord or plug is damaged.
- If any liquid has been spilled onto or objects have fallen into the video unit.
- If the video unit has been exposed to rain or water.
- If the video unit does not operate normally by following the operating instructions. Adjust only those controls that are covered by the operating instructions. Improper adjustment of other controls may result in damage and will often require extensive work by a qualified technician to restore the video unit to its normal operation.
- If the video unit has been dropped or the cabinet has been damaged.
- When the video unit exhibits a distinct change in performance—this indicates a need for service.

### REPLACEMENT PARTS

When replacement parts are required, be sure the service technician has used replacement parts specified by the manufacturer or those having the same characteristics as the original part. Unauthorized substitutions may result in fire, electric shock or other hazards.

### SAFETY CHECK

Upon completion of any service or repairs to this video unit ask the service technician to perform safety checks to determine that the video unit is in safe operating order.

### HEAT

This video unit should be situated away from heat sources such as radiators, stoves, or other products (including amplifiers) that produce heat.

# 1

# GETTING STARTED

This Chapter will guide you through initial setup of your Dual-Deck VCR, including basic connections, Auto Setup, and remote programming.

Before you begin, please check that all items are included in your Dual-Deck VCR box, then insert the enclosed batteries in the remote control.

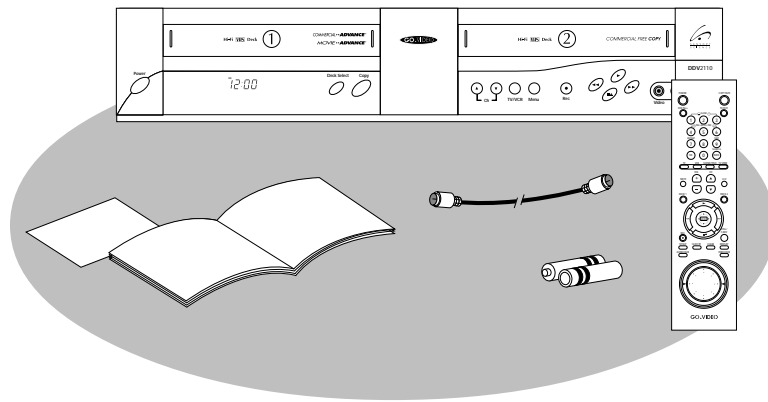

## 1 CHECK PACKING LIST

- Dual-Deck VCR
- Remote Control
- Two (2) "AA" Batteries
- Coaxial Cable
- User's Guide
- Warranty Registration Card

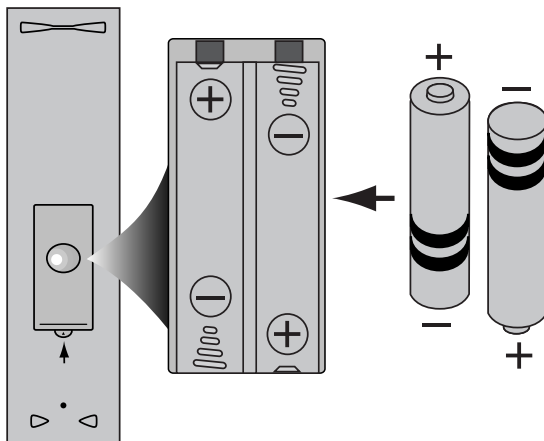

## 2 INSERT BATTERIES

- Remove the battery cover from the back of the remote control as shown.
- Insert two "AA" batteries, paying attention to observe the correct polarities (+/-).
- Replace the cover.



Follow these steps to connect the Dual-Deck VCR to your television and antenna/cable TV.

From Antenna or Cable TV

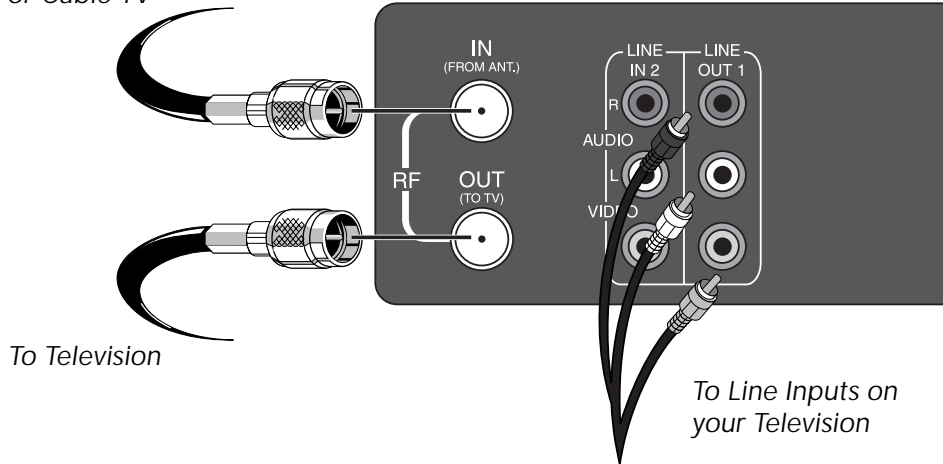

**1 CONNECT ANTENNA/CABLE TV**

Connect the coaxial cable from your indoor/outdoor antenna or cable TV outlet/cable box to the "IN (FROM ANT.)" jack on the VCR back panel.

**2 CONNECT VCR TO TV**

**Standard RF Option**

Connect the supplied cable (coaxial) from the "OUT (TO TV)" jack on the VCR back panel to your television's antenna in jack. Use this connection if your television is equipped with a basic antenna input.

OR

**Composite Video Option**

Connect a standard RCA cable from the "Line Out 1" jacks on the VCR back panel to your television's Line In jacks. Be sure to match yellow to video, red to right audio and white to left audio on your television and VCR. Use this connection for better sound and picture quality if your television is equipped with line inputs.

**3 PLUG IN VCR**

Connect the VCR power cord to a standard 120V/60Hz wall outlet.

**4 TURN ON TV, VCR, CABLE BOX**

Press POWER on your television, VCR and/or Cable Box.

**5 SET TELEVISION CHANNEL**

**Channel 3**

If you chose the Standard RF Option, set your television to channel 3. If you experience interference on channel 3, you may use channel 4 instead; however, you must first run Auto Setup with channel 3, then follow the instructions on page 31 to reset the RF Output to channel 4.

OR

**Video In**

If you chose the Composite Video Option, set your television to display its Video Input, often labeled "Video," "Line," or "Aux." See your television owner's manual for the correct setting.

**6 CONNECTION COMPLETE!**

The "Language/Langue" menu should appear on your television screen. Please proceed with Auto Setup on the following page.

**NOTES**

- For Advanced Connections, please refer to pages 31-35.



Follow these steps to run Auto Setup, which will set the clock and save local channels automatically.

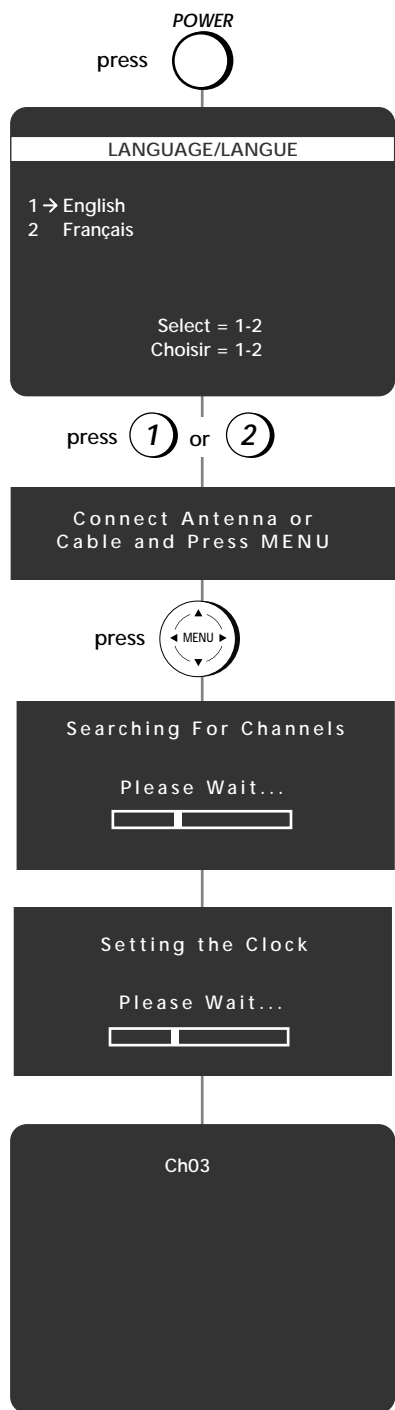

### 1 SET MENU LANGUAGE

The first time you turn on your Dual-Deck VCR, you will be prompted to set the menu language. Press 1 for English or 2 for French.

### 2 CONFIRM ANTENNA/CABLE CONNECTION

If you have not already done so, make sure you have connected an antenna or basic cable to the "IN (FROM ANT.);" jack on the VCR back panel. Press MENU to continue.

### 3 RUN AUTO SETUP

As soon as you press MENU, the Dual-Deck VCR will automatically perform the following steps:

**Auto Channel Search** – Automatically detects the source of incoming channels (antenna or cable) and then searches for all active channels in your area.

**Auto Clock Set** – Automatically sets the VCR's internal clock, which is necessary for accurate timer recording.

- This procedure may take a few minutes to complete. When finished, the VCR will display the lowest channel found.
- Please proceed with Chapter 2 for a Quick Tour of the Dual-Deck system.

### NOTES

- If no channels were found in your area, the VCR will alert you and then display the "Channel Settings" menu; see page 40.
- If Auto Setup was unable to detect the time, the VCR will alert you and then display the Manual Clock Set menu; see page 38.

Follow these steps to program the remote control to operate many brands of television.

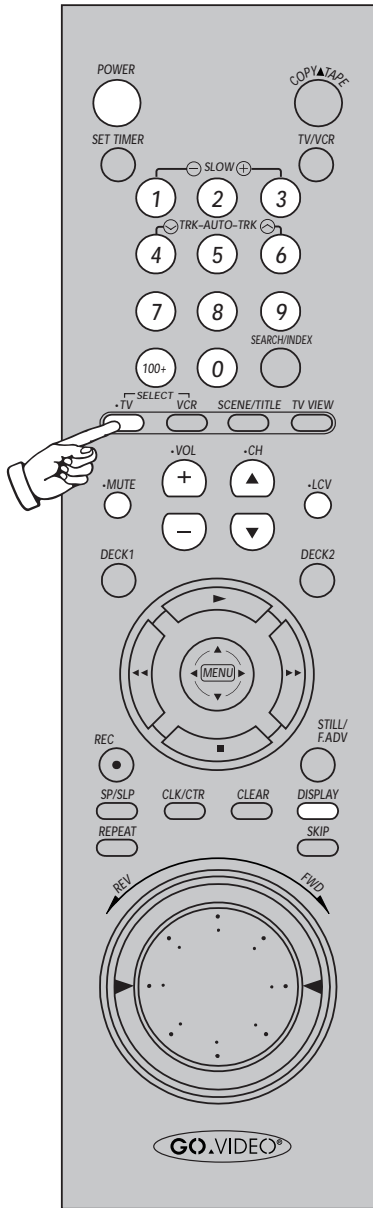

Pressing the TV key puts the remote control in TV mode. Some or all of the highlighted keys will be able to control your television.

## 1 TURN ON TELEVISION

Press POWER on your television.

## 2 ENTER CODE

Press and hold the TV key on the VCR remote control while entering the 2-digit code for your brand of television with the 0-9 keys (see table below). If there is more than one code for your brand of television, try them all until one works.

BRAND	CODE(S)
Daewoo .....	TV + 19
Emerson .....	TV + 21
Hitachi .....	TV + 10
JVC .....	TV + 11
LG .....	TV + 08, 18
LG (Goldstar) .....	TV + 06
Loewe .....	TV + 28
Magnavox .....	TV + 04
Mitsubishi .....	TV + 13
Newsan (S. America) .....	TV + 27
Noblex (S. America) .....	TV + 25
Panasonic .....	TV + 12, 24
RCA .....	TV + 07, 29
Samsung .....	TV + 01, 14, 15, 23
Sanyo .....	TV + 05, 20
Sharp .....	TV + 02, 16, 22
Sony .....	TV + 03
Telefunken .....	TV + 26
Toshiba .....	TV + 09
Zenith .....	TV + 17

## 3 CHECK YOUR RESULTS

If the television advances to the next active channel, programming is complete! If the television does not respond, try another 2-digit code. Some televisions are not listed but can be programmed.

## 4 OPERATE YOUR TELEVISION

When you want to control your television, press the TV key, then try any of the keys shown in the drawing at left.

- When the remote control is in TV mode, it WILL NOT operate your VCR.
- To restore VCR mode, press the VCR key.

### NOTE

- When the remote is in TV mode, it WILL NOT operate the VCR. Press VCR to restore normal VCR functionality.

# 2

## QUICK TOUR

This Chapter provides an overview of the Remote Control, Front Panel, Front Panel Display and On-Screen Display.

The following is an overview of the Dual-Deck VCR remote control. The keys are listed in alphabetical order.

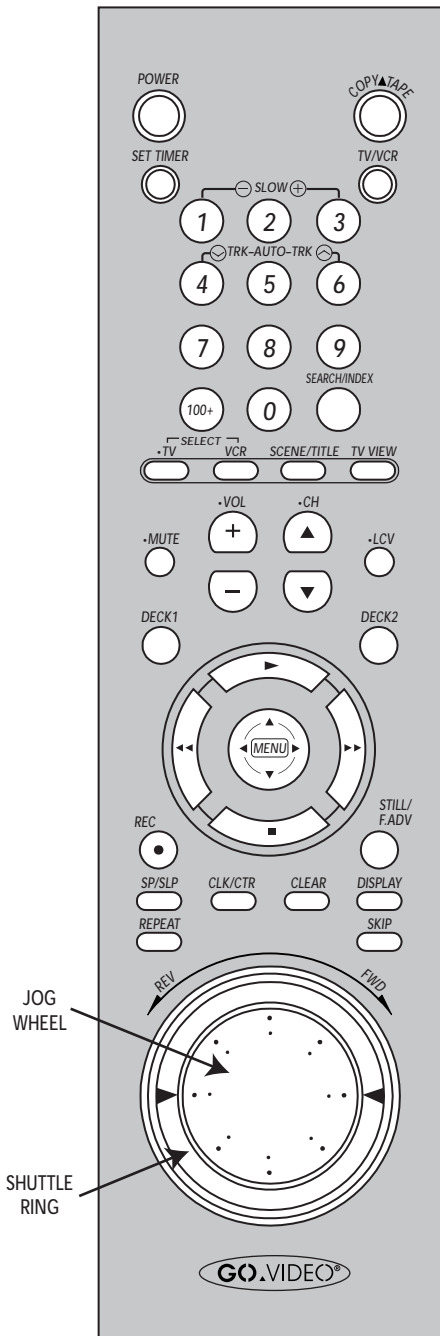

### 0-9

While watching TV, press to select channels. While in the menu system, press to select menu items.

### 100+

Press to select cable channels 100 and above.

### CH ▲▼

Press to select the next or previous channel.

### COPY TAPE

Press to copy the tape in Deck 1 to the tape in Deck 2 (see page 10).

### CLEAR

Press to reset the Tape Counter to zero (0:00:00). Also press to clear entries in the menu system.

### CLK/CTR

Press to change the Front Panel Display to the clock, tape counter, or time remaining on the tape.

### DECK 1

Press to make Deck 1 active. All deck control keys (PLAY ►, REWIND ◀◀, etc.) will only affect Deck 1.

### DECK 2

Press to make Deck 2 active. All deck control keys (PLAY ►, REWIND ◀◀, etc.) will only affect Deck 2.

### DISPLAY

Press to turn the On-Screen Display on and off.

### FAST-FORWARD ►►

While the VCR is stopped, press to fast-forward the tape in the active deck. While a tape is playing, press to visually search forward (Cue). In the menu system, press to make selections.

### JOG WHEEL

While a tape is paused, rotate the Jog Wheel forward or backward to advance or rewind the tape one frame at a time.

**LCV**

While watching TV, press to display the last channel viewed.

**MENU**

Press to display the VCR's Main Menu.

**MUTE**

Press to turn the sound on and off.

**PLAY ►**

Press to play the tape in the active deck. In the menu system, press to move the blinking selection arrow up.

**POWER**

Press to power the VCR on and off.

**REC**

Press to start recording in the active deck. Press repeatedly to add recording time in 30-minute increments (see One Touch Recording, page 14).

**REPEAT**

While a tape is playing, press to replay the last 30 seconds.

**REWIND ◀◀**

While the VCR is stopped, press to rewind the tape in the active deck. While a tape is playing, press to visually search backward (Review). In the menu system, press to return to the previous menu.

**SCENE/TITLE**

While in the 8-Scene Editor, press to mark the beginning and ending points of scenes (see page 19). While recording, press to superimpose On-Screen Titles (see page 22).

**SEARCH/INDEX**

While the VCR is in Stop, Play, Fast-Forward, or Rewind, press to display the Search/Index Menu (see page 28). While a tape is recording, places an Index mark on the tape (see page 27).

**SET TIMER**

Press to open the Timer Recording menu (see page 16).

**SHUTTLE RING**

While a tape is playing, rotate the Shuttle Ring forward or backward to gradually increase or decrease the playback speed.

**SKIP**

While a tape is playing, press 1-5 times to skip ahead 1 minute at a time (up to 5 minutes). While the VCR is copying, press 1-5 times to skip edit (remove) the next 1-5 minutes (see page 21).

**SLOW -/+**

While a tape is playing, press to play the tape in slow motion at variable speeds.

**SP/SLP**

Press to set the record speed to SP (Standard Play) or SLP (Super Long Play). SLP is three times longer than SP.

**STILL/F.ADV**

While a tape is playing or recording, press to pause the tape in the active deck. While a tape is paused, press repeatedly to advance the tape one frame at a time.

**STOP/EJECT ■**

Press to stop the tape in the active deck. Press twice to eject the tape. In the menu system, press to move the blinking selection arrow down.

**TRK ∨∧ - AUTO**

While a tape is playing, press to manually adjust tracking (white lines on the screen). Press AUTO to resume automatic tracking.

**TV**

Press to set the remote to operate your television. Note: When selected, the keys on the remote will not operate the VCR.

**TV/VCR**

Your TV and your VCR both have television tuners. This allows you to watch one show with the TV tuner while recording another show with the VCR tuner. Press the TV/VCR key to switch back and forth between the TV tuner and the VCR tuner.

**TV VIEW**

Press to change the view on your television among all the Dual-Deck VCR input sources: Tuner, Deck 1, Deck 2, Line 1, and Line 2. This allows you to record a show in Deck 1 and watch another tape in Deck 2.

**VCR**

Press to set the remote to operate your VCR.

**VOLUME +/-**

Press to adjust the volume.

The following is an overview of the Dual-Deck VCR front panel.

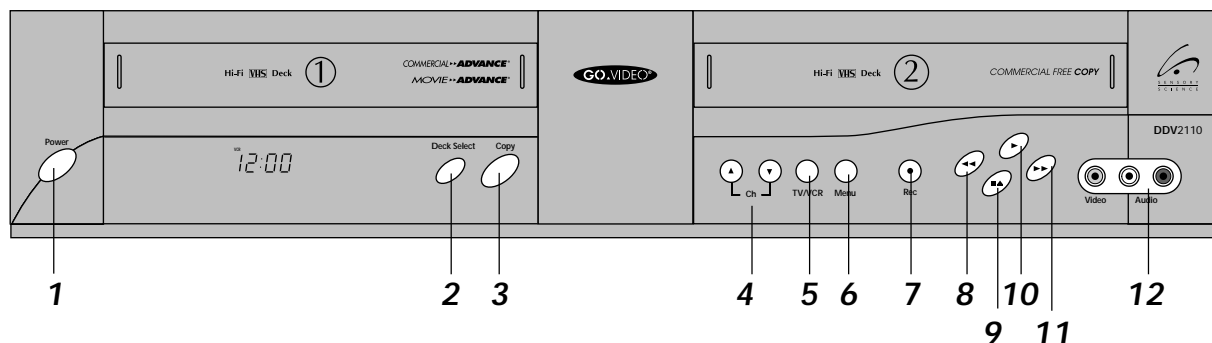

- |   |   |
|---|---|
| <p><b>1 POWER</b><br/>Press to power the VCR on and off.</p> <p><b>2 DECK SELECT</b><br/>Press to switch control between Deck 1 and Deck 2.</p> <p><b>3 COPY TAPE</b><br/>Press to copy the tape in Deck 1 to the tape in Deck 2 (see page 10).</p> <p><b>4 CH ▲▼</b><br/>Press to select the next or previous channel.</p> <p><b>5 TV/VCR</b><br/>Press to switch back and forth between the TV tuner and the VCR tuner.</p> <p><b>6 MENU</b><br/>Press to display the VCR's Main Menu.</p> <p><b>7 REC</b><br/>Press to start recording in the active deck. Press repeatedly to add recording time in 30-minute increments (see page 14).</p> <p><b>8 REWIND ◀◀</b><br/>While the VCR is stopped, press to rewind the tape in the active deck. While a tape is playing, press to visually search backward (Review). In the menu system, press to return to the previous menu.</p> | <p><b>9 STOP/EJECT ■</b><br/>Press once to stop the tape in the active deck, or press twice to eject the tape. In the menu system, press to move the blinking selection arrow down.</p> <p><b>10 PLAY ▶</b><br/>Press to play the tape in the active deck. While a tape is playing or recording, press to pause the tape in the active deck. In the menu system, press to move the blinking selection arrow up.</p> <p><b>11 FAST-FORWARD ▶▶</b><br/>While the VCR is stopped, press to fast-forward the tape in the active deck. While a tape is playing, press to visually search forward (Cue). In the menu system, press to make selections.</p> <p><b>12 FRONT AUDIO/VIDEO INPUT (LINE 1)</b><br/>Connect to the composite video (yellow) and stereo audio outputs (white and red) of an external component, such as a camcorder or videogame, using RCA cables. Use the white input for mono sources.</p> |
|---|---|

#### NOTE

- **Line Input Labels** - Throughout the menu system, the front audio/video input is referred to as "Line 1" (or "L1"), and the rear audio/video input is referred to as Line 2 (or "L2"). To change these labels to match the components you have connected, see page 35.

The following is an overview of the front panel display.

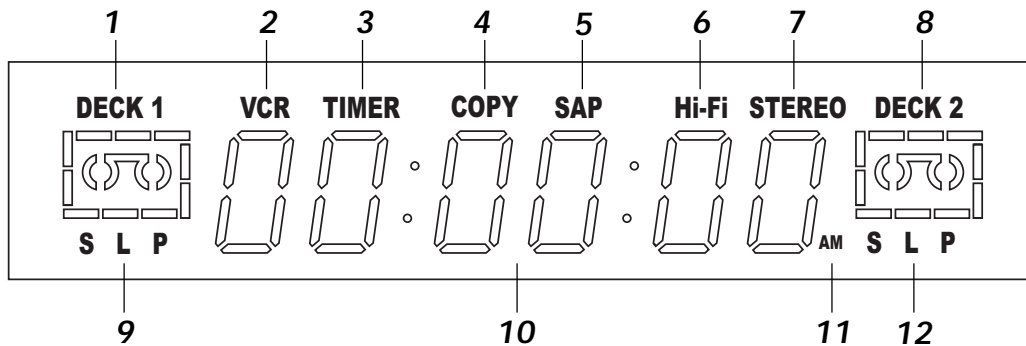

- |  |  |
|--|--|
| <p><b>1 DECK 1 STATUS INDICATOR</b><br/>Lights to show you that Deck 1 is active. Also, graphically displays the status of the tape in Deck 1; e.g., Stop, Play, Rewind, etc.</p> <p><b>2 TV/VCR INDICATOR</b><br/>Lights when the Dual-Deck is in VCR mode, turns off when the Dual-Deck is in TV mode, as set by the TV/VCR key.</p> <p><b>3 TIMER INDICATOR</b><br/>Lights to show you that a Timer Recording has been programmed and stored in memory. Blinks if there is a Timer Recording error.</p> <p><b>4 COPY INDICATOR</b><br/>Lights to show you that a tape is being copied.</p> <p><b>5 SAP INDICATOR</b><br/>Lights when a Second Audio Program, usually a second language, is available for the current TV channel.</p> <p><b>6 Hi-Fi INDICATOR</b><br/>Lights when a tape is playing a Hi-Fi stereo soundtrack.</p> <p><b>7 STEREO INDICATOR</b><br/>Lights when the channel you are watching is broadcast in stereo.</p> | <p><b>8 DECK 2 STATUS INDICATOR</b><br/>Lights to show you that Deck 2 is active. Also, graphically displays the status of the tape in Deck 2; e.g., Stop, Play, Rewind, etc.</p> <p><b>9 DECK 1 PLAY/RECORD SPEED</b><br/>Shows you the current playback (SP, LP, or SLP) or record speed (SP or SLP) for Deck 1.</p> <p><b>10 TAPE COUNTER</b><br/>Shows you the current time, the tape counter position, or the time remaining until the end of the tape in the active deck, as set by the CLK/CTR key. Also briefly displays the status of the active deck when you press a deck control key; e.g., STOP ■, PLAY ►, REWIND ◀◀, etc.</p> <p><b>11 AM/PM INDICATOR</b><br/>Lights when the time is A.M., turns off when the time is P.M.</p> <p><b>12 DECK 2 PLAY/RECORD SPEED</b><br/>Shows you the current playback (SP, LP, or SLP) or record speed (SP or SLP) for Deck 2.</p> |
|--|--|

The following is an overview of the On-Screen Display (OSD).

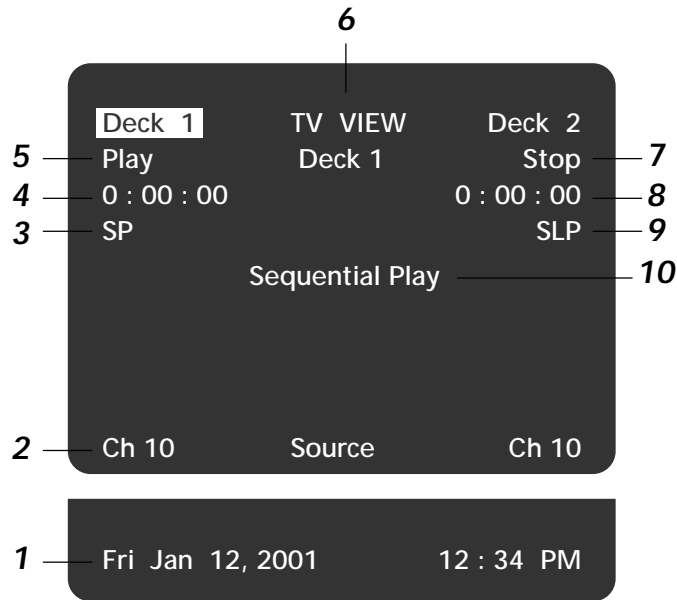

#### 1 DATE AND TIME

When the TV View is set to Channel, Line 1, or Line 2, the date and time are displayed at the bottom of the screen.

#### 2 RECORD SOURCE

When the TV View is set to Deck 1 or Deck 2, the Deck 1 and Deck 2 record source are displayed at the bottom of the screen.

#### 3 DECK 1 PLAY/RECORD SPEED

Shows you the current playback (SP, LP, or SLP) or record speed (SP or SLP) for Deck 1.

#### 4 DECK 1 COUNTER POSITION

Shows you the current tape counter position or time remaining on the tape in Deck 1, as set by the CLK/CTR key.

#### 5 DECK 1 STATUS

Shows you the status of the tape in Deck 1; e.g., Stop, Play, Rewind, Fast-Forward, etc.

#### 6 TV VIEW

Shows you the input source you are currently watching (Channel, Deck 1, Deck 2, Line 1, or Line 2).

#### 7 DECK 2 STATUS

Shows you the status of the tape in Deck 2; e.g., Stop, Play, Rewind, Fast-Forward, etc.

#### 8 DECK 2 COUNTER POSITION

Shows you the current tape counter position or time remaining on the tape in Deck 2, as set by the CLK/CTR key.

#### 9 DECK 2 PLAY/RECORD SPEED

Shows you the current playback (SP, LP, or SLP) or record speed (SP or SLP) for Deck 2.

#### 10 DISPLAY MESSAGES

The On-Screen Display often displays feedback on the status of your Dual-Deck, including Copy messages, Timer Recording error messages, etc.

#### NOTE

- Press DISPLAY to manually turn the OSD on and off.

## COPY

This Chapter will show you how to copy tapes with your Dual-Deck VCR.  
To set up the Commercial Free Copy feature, please see Chapter 8.

Follow these steps to copy a tape from Deck 1 to Deck 2.

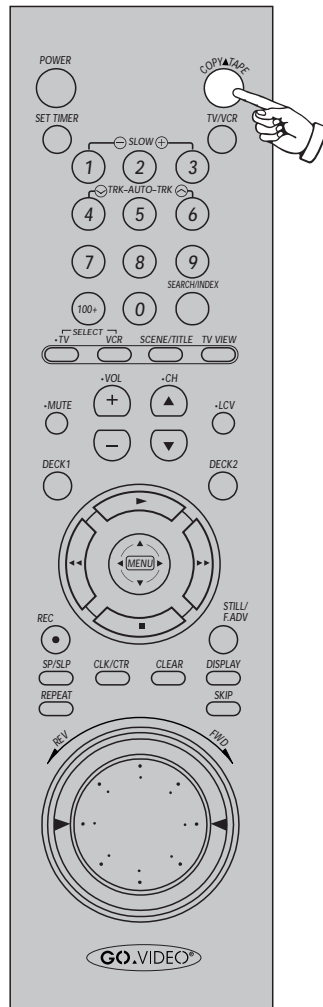

### 1 INSERT SOURCE TAPE

Insert the tape you want to copy in Deck 1.

### 2 INSERT TARGET TAPE

Insert the tape you want to copy to in Deck 2.

- Make sure the tape has a record safety tab or it will eject when you press COPY TAPE.

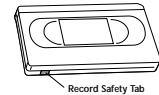

### 3 COPY YOUR TAPE

Press COPY TAPE.

- The "Copy" indicator will light on the front panel display and the VCR will begin copying from Deck 1 to Deck 2.

### 4 OPTIONS WHILE COPYING

- To pause, press COPY TAPE. The "Copy" indicator will blink on the front panel display.
- While paused you can reposition the source tape in Deck 1; e.g., to fast-forward over a commercial; see page 20.
- To stop copying, select Deck 2, then press STOP ■▲.

## NOTES

- The Dual-Deck VCR cannot duplicate copy-protected tapes. If you try to copy a protected tape, the message "Tape is Copy Protected" will appear on the on-screen display.
- If you want to copy an entire tape, try the EZ Copy feature. The VCR will automatically rewind both tapes before and after copying and eject both tapes when finished; see page 11.



Follow these steps to set the default Copy Settings for your Dual-Deck VCR.

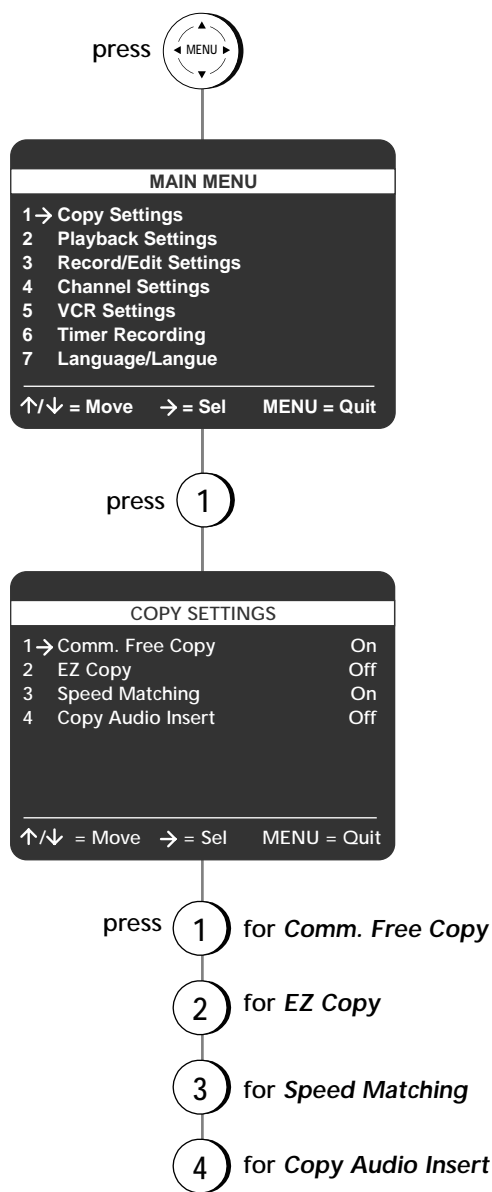

- 1 OPEN MAIN MENU**  
Press MENU.
- 2 SELECT "COPY SETTINGS"**  
Press 1.
- 3 ADJUST COPY SETTINGS**  
Press 1, 2, 3 or 4 to set each of the following:
  - 1 - Comm. Free Copy**  
Please refer to page 26.
  - 2 - EZ Copy**  
**On** – Turns EZ Copy on. When you press COPY TAPE, the VCR will automatically rewind both decks, copy the tape in Deck 1 to Deck 2, rewind both decks again, and eject the tapes. Plus, EZ Copy adjusts the record speed to avoid running out of tape before copying is complete; see note on "Complete Program Record" below.  
**Off** – Turns EZ Copy off.
  - 3 - Speed Matching**  
**On** – Automatically sets the Deck 2 record speed to match the Deck 1 playback speed (recommended for best copy quality).  
**Off** – Allows the Deck 2 record speed to be set independently of the Deck 1 playback speed. Turn Speed Matching off only if you want to record two or more SP tapes onto one SLP tape. You must set the Deck 2 record speed to SLP manually; see page 14.  
**Auto** – Automatically adjusts the Deck 2 record speed to avoid running out of tape before copying is complete; see note on "Complete Program Record" below.
  - 4 - Copy Audio Insert**  
Please refer to page 21.

## NOTES

- **Complete Program Record (CPR)** changes the copy speed from SP to SLP if necessary to reduce the risk of running out of tape before copying is complete.
- **EZ Copy:** If the tape runs out in Deck 2 before copying is complete, neither tape will rewind to alert you that a problem occurred.

# 4

# PLAY

This Chapter will show you how to play videotapes and set special playback preferences.

Follow these steps to play a standard VHS videotape.

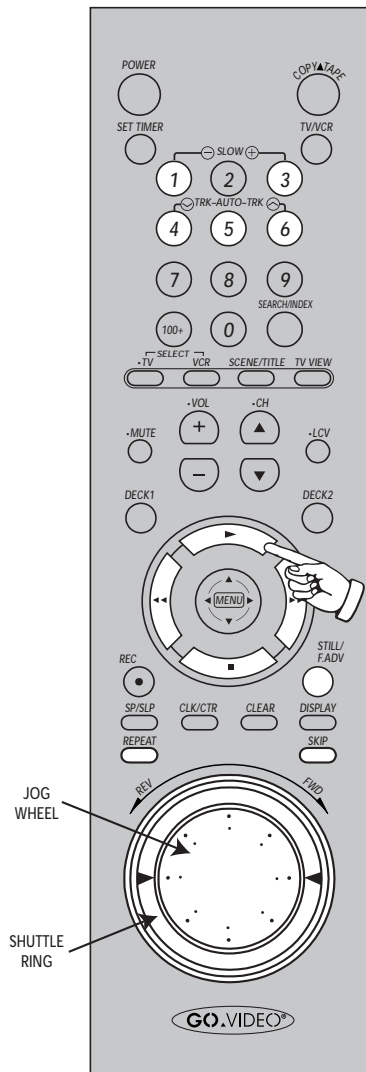

### 1 INSERT TAPE

Insert a standard VHS tape into Deck 1 or Deck 2.

### 2 PLAY TAPE

Press PLAY ►.

### 3 OPTIONS DURING PLAYBACK

**Freeze** - To freeze a single frame, press STILL/F.ADV.

**Frame Advance** - To advance one frame at a time, rotate the JOG WHEEL forward or backward; or press STILL/F.ADV again.

**Shuttle** - To gradually increase or decrease the playback speed, rotate the SHUTTLE RING forward or backward.

**Slow Motion** - To play in slow motion, press SLOW +/-.

**Picture Search** - To cue or review at 5 times normal speed, press and release FAST-FORWARD ►► or REWIND ◀◀.

**Jet Search** - To cue or review at 7 times normal speed, press and hold FAST-FORWARD ►► or REWIND ◀◀.

**Skip** - To skip ahead in 1-5 minute increments, press SKIP 1-5 times in sequence.

**Repeat** - To replay the last 30 seconds of the tape, press REPEAT.

**Manual Tracking** - To adjust tracking manually, press the TRK +/- keys.

**Auto Tracking** - To resume automatic tracking, press AUTO.

### NOTES

- Tapes without record safety tabs can be set to play automatically when inserted; see "Auto Play/Rewind" on page 13.
- To resume normal playback at any time, press PLAY ►.

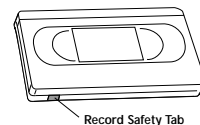

Follow these steps to set the default Playback Settings for your Dual-Deck VCR.

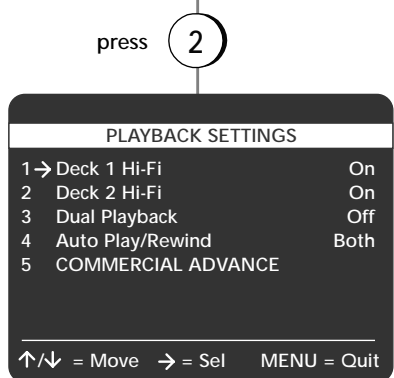
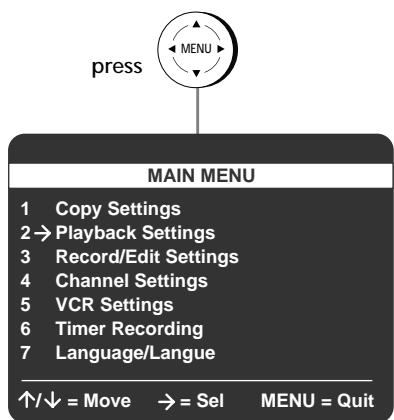

- press 1 for **Deck 1 Hi-Fi**
- 2 for **Deck 2 Hi-Fi**
- 3 for **Dual Playback**
- 4 for **Auto Play/Rewind**
- 5 for **COMMERCIAL ADVANCE**

**1 OPEN MAIN MENU**

Press MENU.

**2 SELECT "PLAYBACK SETTINGS"**

Press 2.

**3 ADJUST PLAYBACK SETTINGS**

Press 1, 2, 3, 4 or 5 to set each of the following:

**1 - Deck 1 Hi-Fi**

**On** – The VCR will play the Hi-Fi audio track on tapes in Deck 1.

**Off** – The VCR will play the linear mono audio track on tapes in Deck 1. This setting is necessary to hear sound tracks recorded using Copy Audio Insert; see page 21.

**2 - Deck 2 Hi-Fi**

**On** – The VCR will play the Hi-Fi audio track on tapes in Deck 2.

**Off** – The VCR will play the linear mono audio track on tapes in Deck 2. This setting is necessary to hear sound tracks recorded using Copy Audio Insert; see page 21.

**3 - Dual Playback**

**Seq** (Sequential) – Tapes will play in sequence; i.e., Deck 1 will play, then Deck 2 will play. This is useful when watching a movie that includes two tapes.

**Loop** – Tapes will play in a continuous loop until you press STOP ■ on the deck in Play. This is useful for continuous playback of training or sales tapes.

**Normal** – Each deck will play independently (default setting).

**4 - Auto Play/Rewind**

**Play** — Tapes without a record safety tab will play automatically when you insert them.

**Rew** — All tapes will rewind automatically when the end of the tape is reached.

**Both** — Tapes will both play and rewind automatically.

**Off** — Tapes will neither play nor rewind automatically.

**5 - COMMERCIAL ADVANCE**

Please refer to page 23.

# 5

# RECORD

This Chapter will show you how to record television programs and set recording preferences.

Follow these steps to record a television show currently in progress.

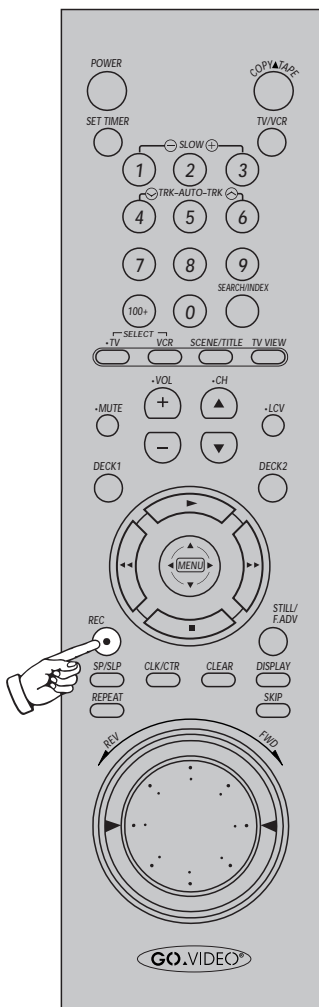

## 1 INSERT TAPE

Insert a VHS tape with a record safety tab into Deck 1 or Deck 2.



## 2 SET RECORD SPEED

Press the SP/SLP key to set the record speed to:

- **SP** – Standard Play, for best quality.
- **SLP** – Super Long Play, for maximum recording time (3 times longer than SP).

## 3 SELECT DESIRED CHANNEL/INPUT

Use the 0-9 keys or the CH +/- keys to select the channel you wish to record; or use the TV VIEW key to select Line 1 (front A/V inputs), Line 2 (rear A/V inputs), or the other deck.

## 4 START RECORDING

Press REC.

## 5 OPTIONS DURING RECORDING

- To pause, press STILL/F.ADV.
- To resume, press REC again.
- To stop, press STOP ■▲.
- To watch a different channel, press TV/VCR to switch to TV mode, then select a channel on your TV.
- To watch another videotape, insert a tape in the other deck and press PLAY ►.
- **One-Touch Recording** – To add recording time in 30 minute increments, press REC repeatedly. "OTR" will appear on the on-screen display, followed by the number of minutes the VCR will record. Continue pressing REC to add up to 9 hours and 30 minutes. When the recording time has elapsed, the VCR will stop recording automatically.
- **OTR Loop Record** – When you reach OTR 9:30, press REC again to enter OTR Loop mode. The selected Deck will record over and over again until you press STOP ■▲. This can be used for continuous recording of security cameras.

### NOTE

- If you press POWER during One-Touch Recording, the front panel display will flash and the VCR will turn off automatically when the recording time has elapsed.

Follow these steps to set the default Record Settings for your Dual-Deck VCR.

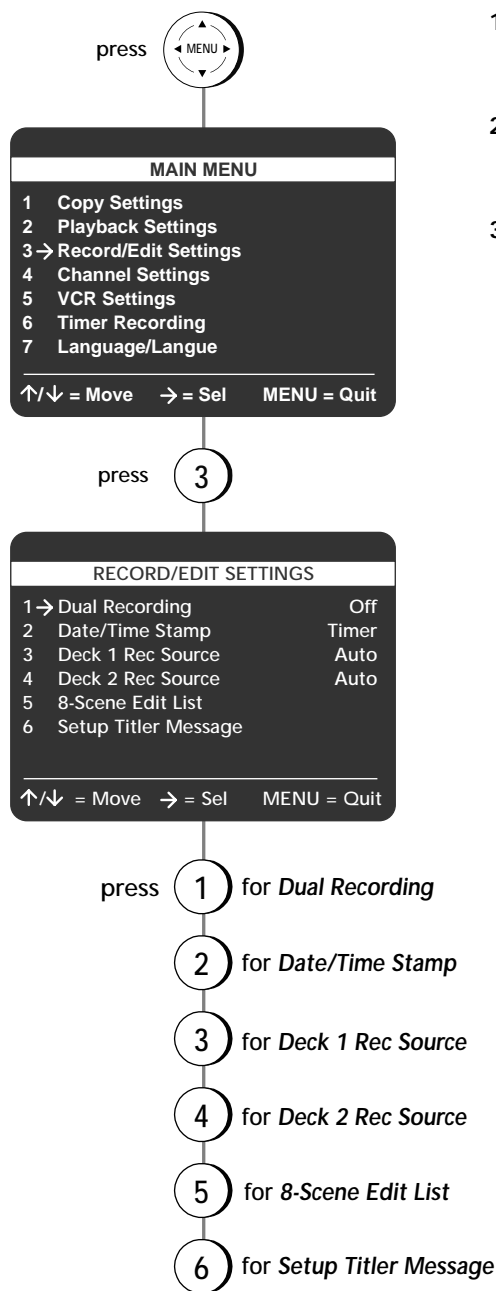

## NOTES

- If you set Dual Recording to "Sequential" and set the Record Speed to SLP, you can record for 12 hours with T-120 tapes.
- If Date/Time Stamp is set to "Cont.," the On-Screen Display and menu system will be disabled. Press STOP ■▲ on the recording deck to restore normal on-screen functions.

### 1 OPEN MAIN MENU

Press MENU.

### 2 SELECT "RECORD/EDIT SETTINGS"

Press 3.

### 3 ADJUST RECORD/EDIT SETTINGS

Press 1, 2, 3, 4, 5 or 6 to set the following:

#### 1 - Dual Recording

**Sequential** – Tapes will record in sequence; i.e., the VCR will record over the entire tape in Deck 1, then over the tape in Deck 2, and then stop.

**Loop** – Tapes will record in a continuous loop; i.e., the VCR will record over the entire tape in Deck 1, then over the tape in Deck 2, then Deck 1, etc. until you press STOP ■▲ on the recording deck.

**Normal** – Each deck will record independently (default setting).

#### 2 - Date/Time Stamp

**Timer** – The date, time, and record source will be "stamped" (superimposed) briefly at the start of all timer recordings.

**Cont.** – The date, time, and record source will be stamped continuously over all recordings.

**All** – The date, time, and record source will be stamped briefly at the start of all recordings.

**Off** – The Date/Time Stamp will be off.

#### 3 - Deck 1 Record Source

**Auto** is the recommended setting, because the VCR will automatically record whatever is visible on the TV screen when you press REC. You may also fix the Record Source to **Line 1** (the front A/V inputs), **Line 2** (the rear A/V inputs), **Deck 2**, or **Tuner** (the current television show).

#### 4 - Deck 2 Record Source

**Auto** is recommended for this setting as well. You can also fix the Deck 2 record source to **Line 1**, **Line 2**, **Deck 1**, or **Tuner**.

#### 5 - 8-Scene Edit List

Please refer to page 19.

#### 6 - Setup Titler Message

Please refer to page 22.

# 6

# TIMER RECORD

This Chapter provides step by step instructions for programming Timer Recordings.

## TIMER RECORDING

Follow these steps to program your VCR to record up to 16 events.

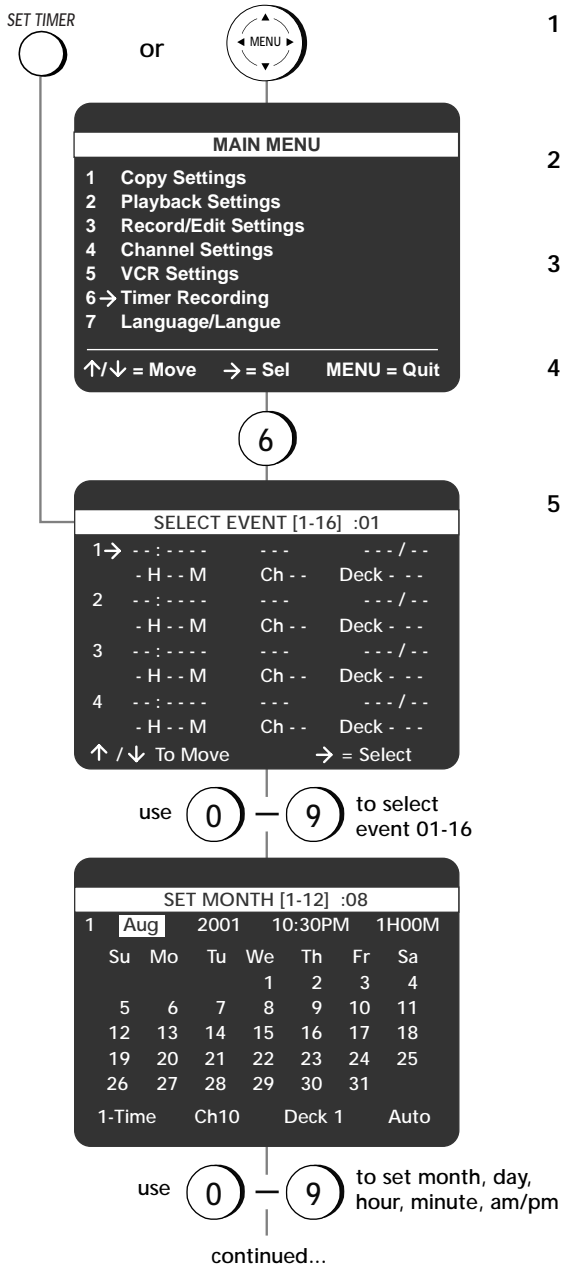

### 1 INSERT TAPE

Insert a blank tape with a record safety tab into Deck 1 or Deck 2.

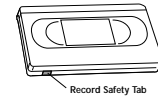

### 2 OPEN MAIN MENU

Press MENU.

### 3 SELECT "TIMER RECORDING"

Press 6 (see notes below).

### 4 SELECT EVENT NUMBER

Use the 0-9 keys to enter any available event number between "01" and "16."

### 5 SET DATE AND TIME

Use the 0-9 keys or UP/DOWN/RIGHT arrow keys to set the date and time of the event. To correct an entry, press the LEFT arrow key to go back and then enter the new numbers. To skip an entry without changing it press the RIGHT arrow key.

#### Set Month

Enter the month as a 2-digit number; e.g., for January, press "01."

#### Set Day

Enter the day as a 2-digit number; e.g., for the ninth, press "09."

#### Set Hour

Enter the hour as a 2-digit number; e.g., for 12:00, press "12."

#### Set Minute

Enter the minute as a 2-digit number; e.g., for 12:00, press "00."

#### Set AM/PM

Press "1" for AM or "2" for PM.

## NOTES

- You can also select the Timer Recording menu, by pressing SET TIMER on the remote control.
- If you select Timer Recording without having set the clock, the Clock Settings menu will appear. You must set the Clock before you can program a Timer Recording (see page 38).

...continued

SET LENGTH (H) [0-9] : 0						
1	Aug	2001	10:30PM	1H00M		
Su	Mo	Tu	We	Th	Fr	Sa
			1	2	3	4
5	6	7	8	9	10	11
12	13	14	15	16	17	18
19	20	21	22	23	24	25
26	27	28	29	30	31	
1-Time	Ch10	Deck 1	Auto			

use **0** — **9** to set hours and minutes

SET TYPE [1-4] : 1						
1	Aug	2001	10:30PM	1H00M		
Su	Mo	Tu	We	Th	Fr	Sa
			1	2	3	4
5	6	7	8	9	10	11
12	13	14	15	16	17	18
19	20	21	22	23	24	25
26	27	28	29	30	31	
1-Time	Ch10	Deck 1	Auto			

press **1** — **4** to set type

SET SOURCE [1-4] : 1						
1	Aug	2001	10:30PM	1H00M		
Su	Mo	Tu	We	Th	Fr	Sa
			1	2	3	4
5	6	7	8	9	10	11
12	13	14	15	16	17	18
19	20	21	22	23	24	25
26	27	28	29	30	31	
1-Time	Ch10	Deck 1	Auto			

press **1** — **4** to set source

SET DECK [1-2] : 1						
1	Aug	2001	10:30PM	1H00M		
Su	Mo	Tu	We	Th	Fr	Sa
			1	2	3	4
5	6	7	8	9	10	11
12	13	14	15	16	17	18
19	20	21	22	23	24	25
26	27	28	29	30	31	
1-Time	Ch10	Deck 1	Auto			

press **1** — **2** to set deck

continued...

#### NOTE

- If you are recording with a cable box, set Source to Channel 2, 3, or 4—whichever your cable box uses—then select the desired channel on the cable box.

#### 6 SET LENGTH

Use the 0-9 keys or UP/DOWN/RIGHT arrow keys to set the length of the event in hours and minutes.

##### **Set Length (H)**

Enter the hours as a 1-digit number; e.g., for one hour, press "1."

##### **Set Length (M)**

Enter the minutes as a 2-digit number; e.g., for 30 minutes, press "30."

#### 7 SET TYPE

Press 1, 2, 3 or 4 (or use the UP/DOWN arrow keys) to set how often the event will be recorded:

##### **1 - 1-Time**

The event will be recorded once.

##### **2 - Mo-Fr**

The event will be recorded Monday through Friday.

##### **3 - Weekly**

The event will be recorded once a week.

##### **4 - Always**

The event will be recorded every day.

#### 8 SET SOURCE

Press 1, 2, 3 or 4 (or use the UP/DOWN arrow keys) to set the record source. If you are using a cable box, see note below:

##### **1 - Ch##**

Records from TV. First press 1 to select this option. Then use the 0-9 keys to set the channel number you wish to record as a two -digit number.

##### **2 - Line 1**

Records from an external source connected to the front line inputs.

##### **3 - Line 2**

Records from an external source connected to the rear line inputs.

##### **4 - Ch##s (Channel Simulcast)**

Records video from TV and audio from Line 2 (usually connected to an FM stereo). Use the 0-9 keys to set the channel number.

#### 9 SET DECK

Press 1 or 2 (or use the UP/DOWN arrow keys) to set which deck will record the event, as chosen in Step 1.

##### **1 - Deck 1**

The event will be recorded in Deck 1.

##### **2 - Deck 2**

The event will be recorded in Deck 2.



...continued

SET SPEED [1-3] : 1

1	Aug	2001	10:30PM	1H00M	
	Su	Mo	Tu	We	Th
				1	2
	5	6	7	8	9
	12	13	14	15	16
	19	20	21	22	23
	26	27	28	29	30
	31				
	1-Time	Ch10	Deck 1	Auto	

press 1 — 3 to set speed

SELECT EVENT [1-16] :01

1	→10:30 PM	On	Wednesdays	1 H 30 M	Ch 10 Deck 1 Auto
2	---:---:---	---	--- / ---	- H - - M	Ch - - Deck - -
3	---:---:---	---	--- / ---	- H - - M	Ch - - Deck - -
4	---:---:---	---	--- / ---	- H - - M	Ch - - Deck - -
	↑ / ↓ To Move		→ = Select		

TIMER RECORDING ERRORS

**Tape Missing**  
Solution: Insert a tape in the recording deck.

**Tape Missing Tab**  
Solution: Insert a video cassette with a record safety tab.

**Not Ready**  
Solution: The recording deck is already in use. Press STOP ■▲ on this deck.

**Overlapping Events**  
Solution: If two programmed events overlap, you will be prompted to either delete one of the events, or allow them to overlap. If you allow them to overlap, the event with the earliest starting time will be completely recorded, then the remainder of the event with the next earliest starting time will be recorded.

**10 SET SPEED**

Press 1, 2, or 3 (or use the UP/DOWN arrow keys) to set the record speed.

**1 - Auto**

Activates Complete Program Record (see note below).

**2 - SP**

Standard Play. Use for best quality (a T-120 tape will record for 2 hours).

**3 - SLP**

Super Long Play. Use for maximum recording time (a T-120 tape will record for 6 hours).

**11 VIEW EVENT SUMMARY**

Press MENU to confirm the event and view a summary of all programmed events.

- The event is now stored in memory and will record at the scheduled time. It is not necessary to turn the VCR off or put it into a "Timer" mode; the event will record regardless of the state of the VCR.
- The "Timer" indicator will light on the front panel display. If there is a timer recording error, the "Timer" indicator will blink (see "Timer Recording Errors" below).
- To program another event, select an available event number.
- To edit an event, select its event number.
- To delete an event, use the up/down arrow keys to select it, then press CLEAR.
- To exit the Select Event screen, press MENU.

**NOTE**

- **Complete Program Record (CPR)** adjusts the recording speed to make sure you won't run out of tape before the Timer Recording is complete. With Record Speed set to "Auto," the VCR will begin recording in SP. It will then calculate how much time is remaining on the tape and adjusts the record speed to SLP if necessary. If there is not enough room to record the entire show, the VCR will record in SLP until the end of the tape is reached.



# 7

# EDIT

This Chapter will show you how to use the 8-Scene Editor and the On-Screen Titler to make your own home movies.

Follow these steps to use the 8-Scene Editor to assemble the best scenes from your home movies.

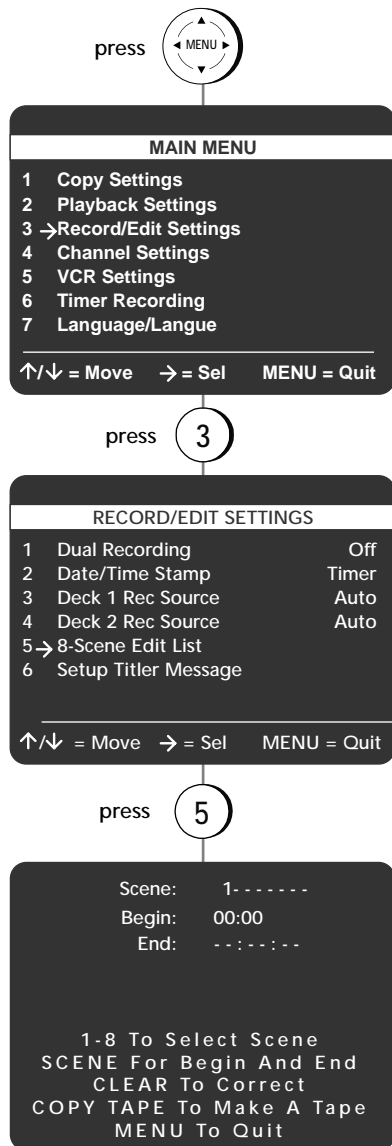

## 1 INSERT SOURCE TAPE

Insert your source tape (original footage) in Deck 1.

## 2 INSERT TARGET TAPE

Insert your target tape in Deck 2. Make sure the tape has a record safety tab. For best quality, use blank or pre-formatted tapes.

## 3 OPEN MAIN MENU

Press MENU.

## 4 SELECT "RECORD/EDIT SETTINGS"

Press 3.

## 5 SELECT "8-SCENE EDIT LIST"

Press 5.

## 6 SELECT SCENE NUMBER

Select a scene number from 1 to 8.

## 7 MARK BEGINNING OF SCENE

Play the tape in Deck 1 to the start of the desired scene and press SCENE/TITLE. The VCR will save the starting counter position of this scene.

## 8 MARK END OF SCENE

Play the tape in Deck 1 to the end of the same scene and press SCENE/TITLE. The VCR will save the ending counter position of this scene.

- To clear the end point, press CLEAR once.
- To clear the begin point, press CLEAR again.

## 9 ADD MORE SCENES (OPTIONAL)

Repeat Steps 6-8 to store up to 8 total scenes.

## 10 ASSEMBLE THE TAPE

Press COPY TAPE. The VCR will automatically copy all marked scenes in order from Deck 1 to Deck 2. When this processed is finished, repeat Steps 3-10 to add additional scenes.

### NOTE

- While there are scenes in the Edit List, you cannot eject the source tape in Deck 1 with the remote.



Follow these steps to edit your tapes manually using the COPY TAPE button.

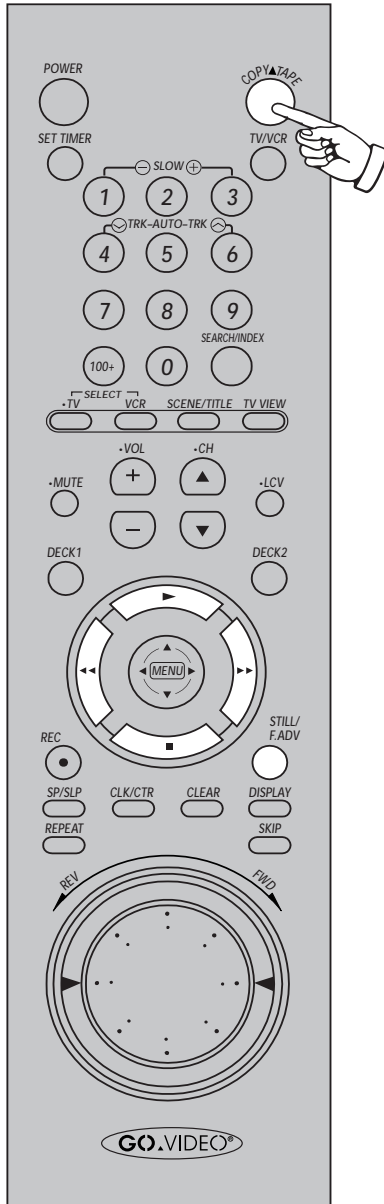

- 1 **BEFORE YOU BEGIN —**
  - Turn off EZ Copy; see page 11.
  - Turn off Auto Play; see page 13.

---

- 2 **INSERT SOURCE TAPE**  
 Insert your source tape (original footage) in Deck 1.

---

- 3 **INSERT TARGET TAPE**  
 Insert your target tape in Deck 2. Make sure the tape has a record safety tab.

---

- 4 **CUE SOURCE TAPE**  
 Press the DECK 1 key, then use the deck control keys (PLAY ►, STOP ■▲, FAST-FORWARD ►►, REWIND ◀◀) to position the source tape at the start of the desired segment. Stop or pause the tape at this position.

---

- 5 **CUE TARGET TAPE**  
 Press the DECK 2 key, then use the deck control keys to position the target tape where you wish copying to begin. Stop or pause the tape at this position.

---

- 6 **START EDITING**  
 Press COPY TAPE.
  - The “Copy” indicator will light on the front panel display and the VCR will begin copying from Deck 1 to Deck 2.

---

- 7 **PAUSE EDITING**  
 Press COPY TAPE again to pause.
  - The “Copy” indicator will blink on the front panel display.

---

- 8 **REPOSITION SOURCE TAPE**  
 Press the DECK 1 key, then use the deck control keys to reposition the source tape at the start of the next segment. Stop or pause the tape at this position.

---

- 9 **RESUME EDITING**  
 Repeat Steps 6-8 to add all desired scenes from Deck 1 to Deck 2.
  - When finished, select Deck 2, then press STOP ■▲.
  - To automatically edit out commercial segments in 1-5 minute blocks, see note on “Skip Edit” or see “Commercial Free Copy” on page 26.

**NOTE**

- **Skip Edit** - Skip Edit allows you to remove commercials in 1-5 minute blocks while copying a tape. When the commercials start, press SKIP once for every minute of commercials to be deleted. The Dual-Deck VCR will automatically pause the copy, fast-forward 1-5 minutes, and resume copying.
- Leave at least 15 seconds of blank tape at the beginning of a tape to ensure a crisp edit.

Follow these steps to insert a new audio track, such as recorded music or narration, onto your target tape. The new audio can be recorded from the front or rear line inputs.

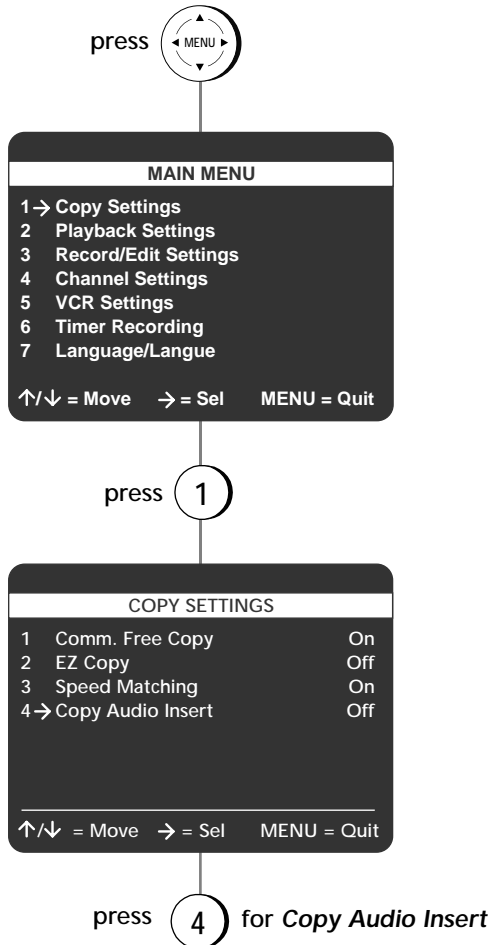

### 1 OPEN MAIN MENU

Press MENU.

### 2 SELECT "COPY SETTINGS"

Press 1.

### 3 SET COPY AUDIO INSERT

Press 4 to choose from the following:

#### L1 (Line 1)

While copying, a new linear audio track will be recorded from an external audio source connected to the front audio jacks.

#### L2 (Line 2)

While copying, a new linear audio track will be recorded from an external audio source connected to the rear audio jacks.

#### Off

Copy Audio Insert is disabled. The existing audio will be copied.

### 4 CONNECT AUDIO SOURCE

Connect your external audio source to the front (Line 1) or rear (Line 2) inputs using standard RCA audio cables; see notes below.

### 5 CUE TAPES

Cue up all devices:

- Source tape in Deck 1.
- Target tape in Deck 2.
- The external audio source (tape player, CD player, etc.) connected to Line 1 or Line 2.

### 6 COPY NEW AUDIO TRACK

Press COPY TAPE on the VCR and PLAY on your external audio source at the same time.

- The new audio signal will be copied on the linear audio track. To hear the new soundtrack, you must turn off Hi-Fi audio for the desired playback deck, see page 13.

## NOTES

- If you wish to use a microphone to insert the new audio track, it must be connected to a preamp.
- Do not connect speaker outputs to the VCR.
- If there is no audio signal, the audio track will be blank.
- Copy Audio Insert automatically reverts to "Off" when the VCR is turned off.



Follow these steps to add titles or credits to your home movies using the On-Screen Titler.

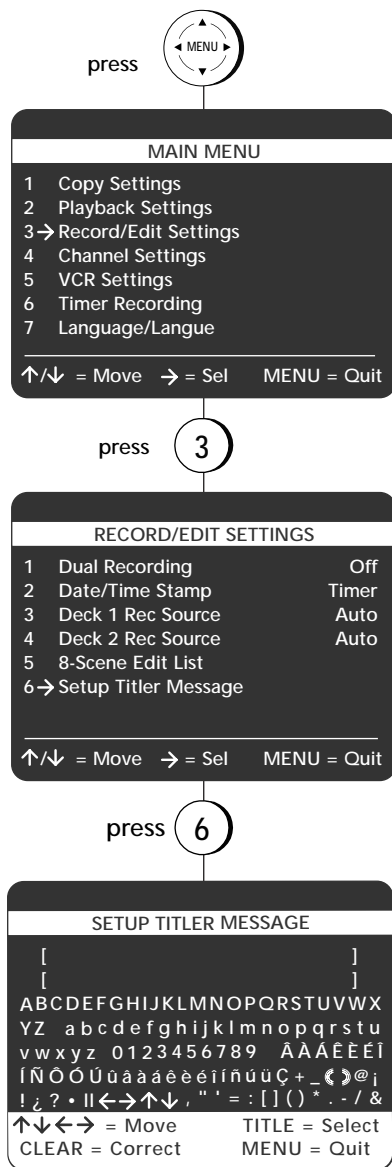

## 1 OPEN MAIN MENU

Press MENU.

## 2 SELECT "RECORD/EDIT SETTINGS"

Press 3.

## 3 SELECT "SETUP TITLER MESSAGE"

Press 6.

## 4 COMPOSE YOUR MESSAGE

Use the up/down/left/right arrow keys to select each character in your message:

- Press SCENE/TITLE after each character to insert it in your message.
- Press CLEAR to backspace and delete the previous character.
- Choose from over 100 letters, numbers and symbols.

## 5 SAVE YOUR MESSAGE

Press MENU to save your message and exit the menu system.

## 6 INSERT TAPE

Insert a tape with a record safety tab in Deck 2. You must use Deck 2 to record your Titler Message.

## 7 START RECORDING

Start any record function; e.g., Record, One-Touch Record, Copy, or Timer Record.

## 8 RECORD TITLER MESSAGE

You can overlay the title on your video for up to 20 seconds in 5-second increments. Press SCENE/TITLE 1 to 4 times to record your Titler Message for 5, 10, 15, or 20 seconds, respectively.

### NOTE

- You must be recording a video signal when you record the Titler Message; i.e. you cannot record a title without also recording a picture.

# 8

## COMMERCIAL ADVANCE

This Chapter will show you how to use *COMMERCIAL ADVANCE* to skip commercials during playback of recordings, and remove marked commercials from copied tapes.

If you have ever wanted to watch TV without commercials, *COMMERCIAL ADVANCE* is for you. The first step is to mark groups of commercials while recording a TV show.

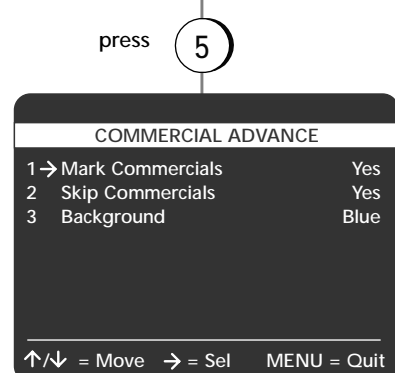
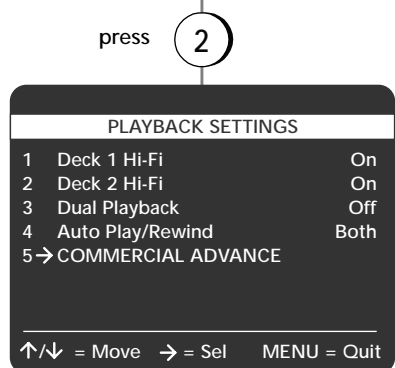
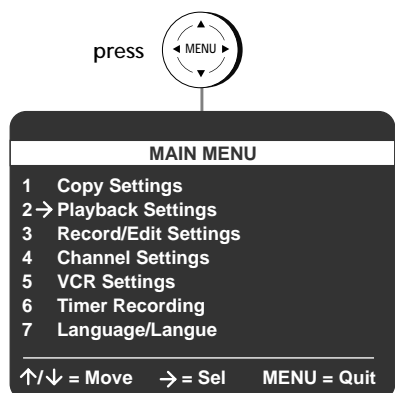

press **1** for *Mark Commercials*

### 1 OPEN MAIN MENU

Press MENU.

### 2 SELECT "PLAYBACK SETTINGS"

Press 2.

### 3 SELECT "COMMERCIAL ADVANCE"

Press 5.

### 4 SET "COMMERCIAL ADVANCE"

Press 1 to select from the following:

#### 1 - Mark Commercials

- **Yes** – The VCR will automatically mark commercials during recording.
- **No** – The VCR will not mark commercials during recording.

### 5 INSERT TAPE

Insert a videotape in Deck 1.

- *COMMERCIAL ADVANCE* only works in Deck 1.

### 6 RECORD FROM TV

Record a television show using one of the three basic methods:

- Basic Recording; see page 14.
- One Touch Recording; see page 14.
- Timer Recording; see page 16.

### 7 END RECORDING

Press STOP  on Deck 1 or allow the preset recording time to run out; e.g. One-Touch Recording and Timer Recording have preset recording times.

COMMERCIAL ADVANCE®

#### NOTE

- *COMMERCIAL ADVANCE*® is a trademark of SRT, Inc. A Jerry Iggulden invention licensed in association with Arthur D. Little Enterprises, Inc.

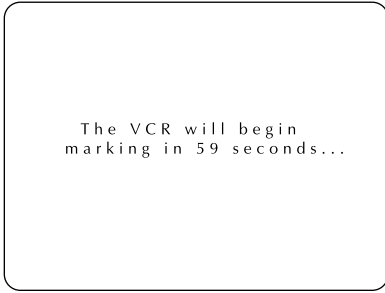

---

## 8 CONFIRM OR CANCEL

When recording is stopped, the VCR will alert you that, "The VCR will begin marking commercials in 59 seconds..."

- No action is required to mark the commercials on the recording; simply wait 59 seconds for the confirmation screen to count down.
- If you are not present for the 59 second countdown, the VCR will automatically mark the commercials anyway; e.g., if you set a Timer Recording or One Touch Recording and the TV is turned off, the commercials will still be marked.
- To cancel, press STOP ■▲ in Deck 1 and the commercials will not be marked.

---

## 9 MARK COMMERCIALS

When the 59 seconds have elapsed, the VCR will rewind to the start of the recording, and then search forward and mark groups of commercials.

- This process takes approximately 15 minutes for each hour of recorded tape.
- The VCR will stop when finished.
- Rewind the tape and proceed to "Skipping Commercials" on the following page.

## NOTES

- 
- When you use Timer Recording to record two consecutive shows on the same channel, program each show separately so that the prologues and epilogues are not automatically skipped.
  - COMMERCIAL ADVANCE will only mark recordings longer than 20 minutes.
-

Follow these steps to automatically skip marked commercials while watching a taped TV show.

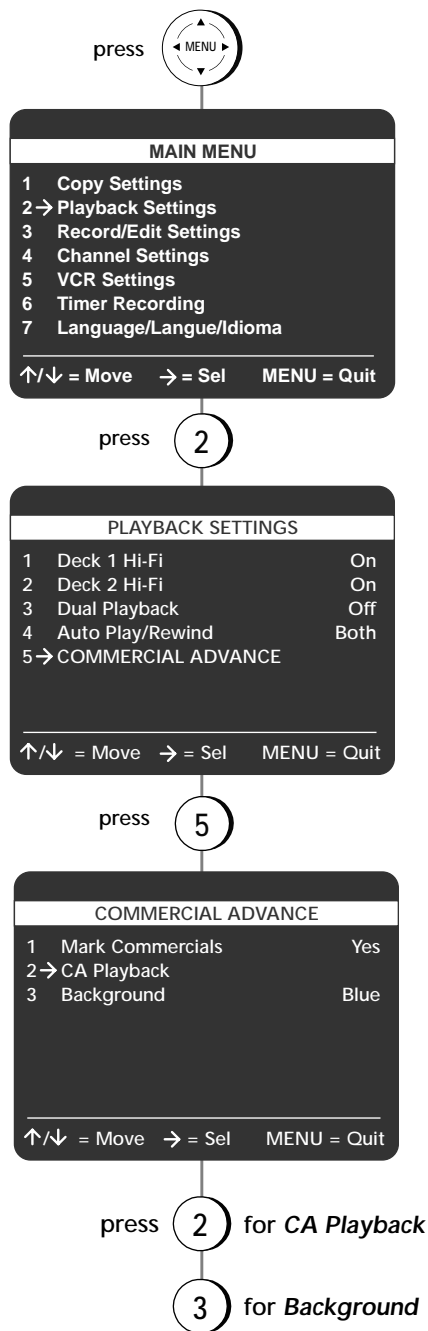

**1 OPEN MAIN MENU**

Press MENU.

**2 SELECT "PLAYBACK SETTINGS"**

Press 2.

**3 SELECT "COMMERCIAL ADVANCE"**

Press 5.

**4 ADJUST "COMMERCIAL ADVANCE" SETTINGS**

Press 2 or 3 to set each of the following:

**2 - CA Playback**

- **Auto** – During playback of a tape with marked commercials, the VCR will automatically fast-forward through commercial groups at approximately 7 times normal speed (SP).
- **Manual** – Commercials will be shown as usual. To manually bypass marked commercial groups, press SEARCH/INDEX.

**3 - Background**

- **Blue** – While fast-forwarding through commercials, the VCR will display a blue background.
- **Video** – While fast-forwarding through commercials, the VCR will display the video recording.

**5 SKIP COMMERCIALS**

Play a tape with marked commercials in Deck 1.

- A commercial group that starts in the first two minutes or last two minutes of a recording will not be skipped.
- A commercial will not be skipped if a recording starts in the middle of a commercial segment, if one isolated commercial is shown without others, or if a commercial is longer than one minute.
- Part of a recorded program may be skipped if the program segment is between commercials and less than one minute; or if there are frequent dark and quiet scenes.

**NOTE**

- **COMMERCIAL ADVANCE Override** - To temporarily override automatic skipping of commercials, press STOP ■▲ while the VCR is fast-forwarding through a group of commercials. Press REWIND ◀ to position the tape before the commercial group, then press PLAY ▶. This time when the commercial group begins, it will NOT be skipped. Automatic skipping will resume after the VCR reaches the end of a commercial group.

Follow these steps to remove all marked commercials while making a copy of a taped TV show.

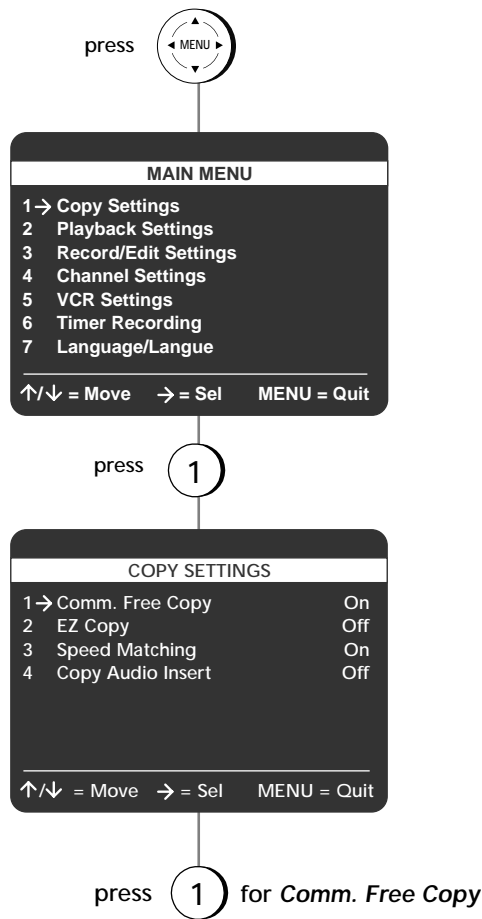

- 1 OPEN MAIN MENU**  
Press MENU.
- 2 SELECT "COPY SETTINGS"**  
Press 1.
- 3 SET "COMM. FREE COPY"**  
Press 1 to select from the following:
  - **On** – The VCR will exclude marked commercials while copying tapes.
  - **Off** – The VCR will include marked commercials while copying tapes.
  - **Auto** – The VCR will automatically make a copy of each TV program you record without the marked commercials; see note below.
- 4 INSERT SOURCE TAPE**  
Insert the tape with marked commercials in Deck 1.
- 5 INSERT THE TARGET TAPE**  
Insert the tape you are copying to in Deck 2.
- 6 COPY YOUR TAPE**  
Press COPY TAPE.
  - The tape in Deck 1 will begin copying to Deck 2. Deck 2 will suspend recording whenever Deck 1 locates a block of commercials.
  - When copying is complete, the tape in Deck 2 will be commercial free!

### AUTO COMMERCIAL FREE COPY

When "Comm. Free Copy" is set to "Auto," each time a TV program finishes recording and marking commercials in Deck 1, the VCR will automatically rewind Deck 1 to the start of the recording and copy the program to Deck 2 without the marked commercials!

#### How it Works

1. Load a videotape with a record safety tab into each Deck.
2. Record a TV program in Deck 1 (standard recording, One-Touch recording or timer recording).
3. When recording is stopped in Deck 1 (or when the recording time has elapsed), the VCR will automatically rewind the tape in Deck 1 to the start of the recording and mark all commercial groups.
4. Next Deck 1 will rewind again and copy the program to Deck 2 leaving out the marked commercials. When Auto Commercial Free Copy is complete, both decks will stop at the end of the recorded program—ready to record additional programs!

#### NOTE

- The Commercial Free Copy function will only recognize commercial groups that have been marked by COMMERCIAL ADVANCE.



# 9

# SEARCH

This Chapter will show you how to locate recordings on your videotapes, as well as scan through the previews at the start of rented movies.

Follow these steps to place Index Marks on your recordings.

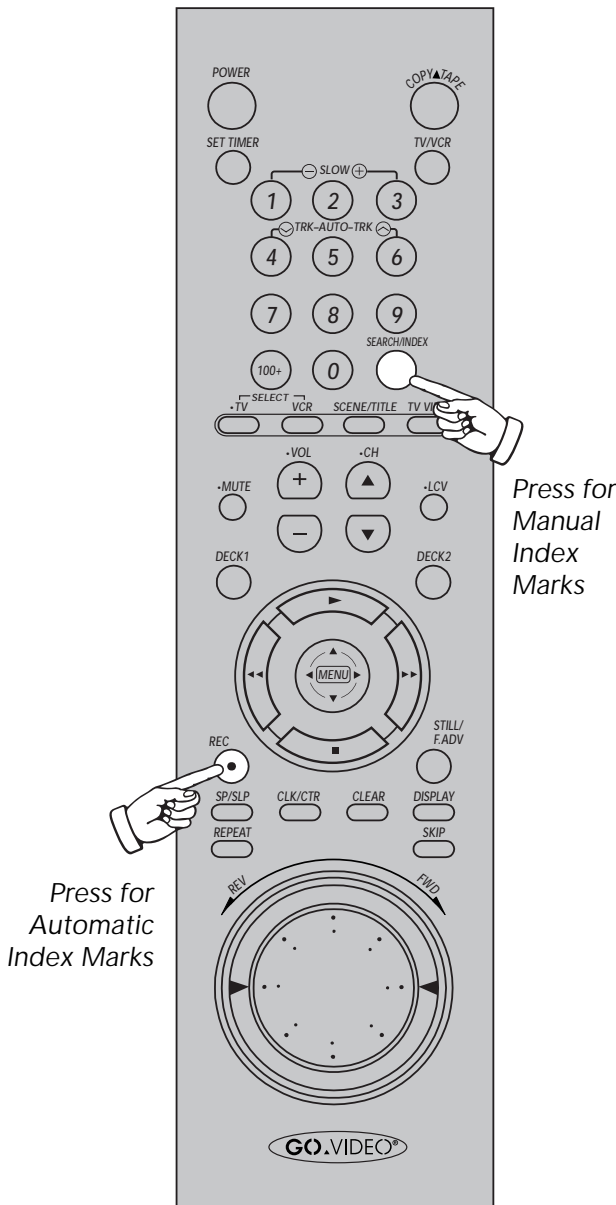

## WHAT ARE INDEX MARKS?

Index Marks are like bookmarks on your videotapes. They are inserted automatically at the start of every recording, or you can place them manually anywhere on a tape. Later you can locate these "bookmarks" using Index Search or Index Scan.

### Automatic Index Marks

The VCR places an Index Mark on your tape the moment you start recording. This includes standard recording, One Touch Recording, Timer Recording, copying, or recording with the 8-Scene Editor.

### Manual Index Marks

You can place an Index Mark manually any time a tape is recording by pressing SEARCH/INDEX. "Index" will flash briefly on the On-Screen Display while the mark is recorded.

## NOTE

- **VHS Index Search System (VISS)** - The Index system used on the Dual-Deck VCR is the VHS standard indexing system called VHS Index Search System, or VISS. This system is compatible with tapes made on other VCRs and camcorders using the VISS system.



Follow these steps to locate recordings by scanning or searching for Index Marks.

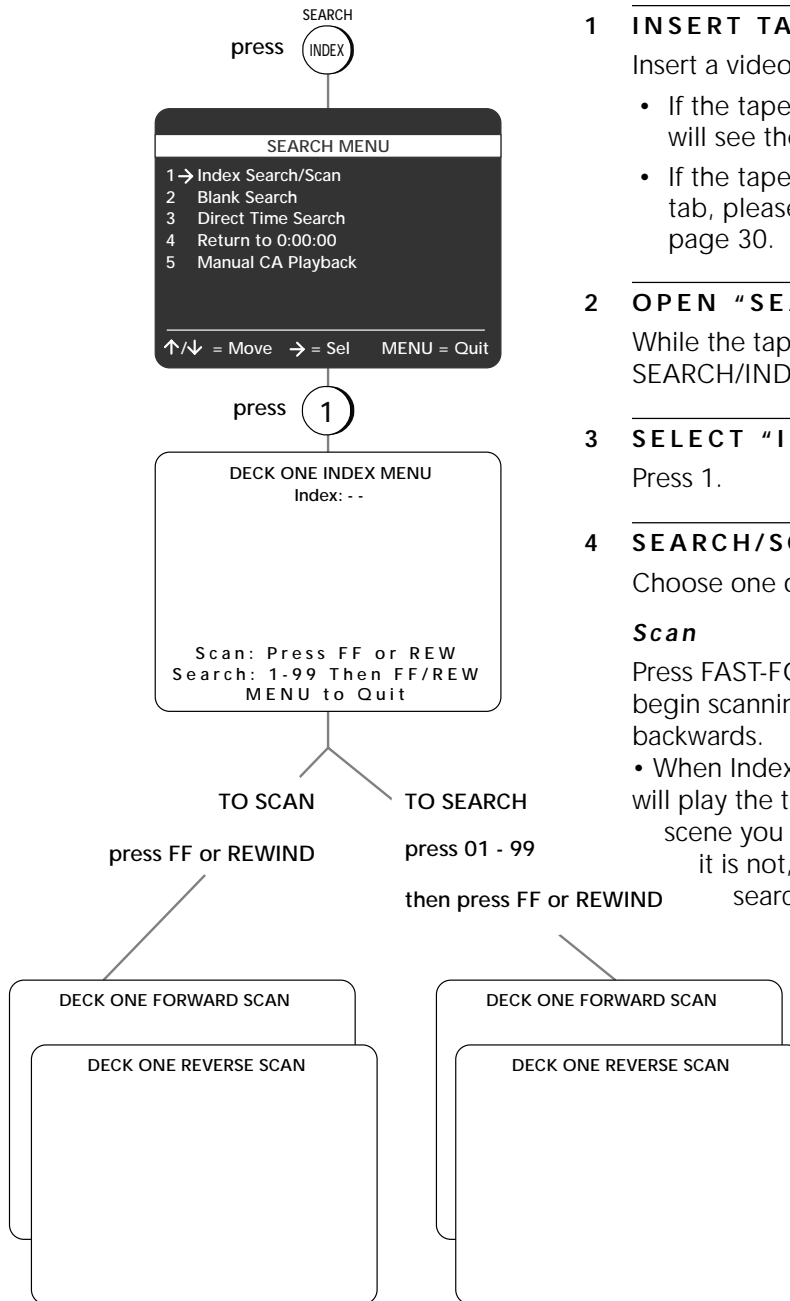

## 1 INSERT TAPE

Insert a videotape in Deck 1 or Deck 2.

- If the tape has a record safety tab, you will see the menu at left.
- If the tape is missing the record safety tab, please see MOVIE ADVANCE on page 30.

## 2 OPEN "SEARCH MENU"

While the tape is stopped or playing, press SEARCH/INDEX.

## 3 SELECT "INDEX SEARCH/SCAN"

Press 1.

## 4 SEARCH/SCAN FOR INDEX MARKS

Choose one of the following:

### Scan

Press FAST-FORWARD ►► or REWIND ◀◀ to begin scanning for Index Marks forwards or backwards.

- When Index Scan locates an Index Mark, it will play the tape for 5 seconds. If it is the scene you want to watch, press PLAY ►. If it is not, the VCR will automatically search for the next Index Mark.

### Search

Enter a number from 1 to 99; e.g. for "5" press "0-5." Then press FAST-FORWARD ►► or REWIND ◀◀ to begin searching forward or backward for the specified Index Mark.

- When the VCR locates the Index Mark, it will play the tape.

## NOTE

- **Auto Show Finder** - Use Index Scan with the Date/Time Stamp to quickly find Timer Recordings on your tapes. For example, when Index Scan stops at an Index Mark and plays a few seconds of tape, you will see the date and time the show was recorded.

Follow these steps to find the nearest blank segment of tape, find a specific tape counter position, or return to 0:00:00.

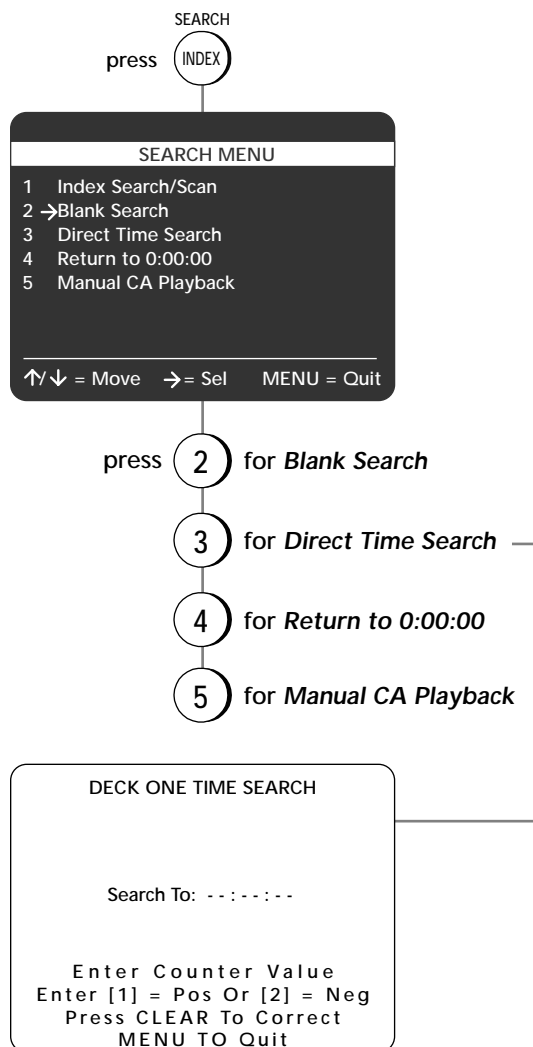

#### MANUAL CA PLAYBACK

If you set "CA Playback" to "Manual" (see page 25), you can still fast-forward through marked commercials with Manual CA Playback. While you are watching a tape with marked commercials, press SEARCH/INDEX and then press 5: The VCR will search forward to the end of the next marked commercial group, then resume playback.

- This feature works in Deck 1 only
- Tapes must be recorded in SP or SLP

#### 1 INSERT TAPE

Insert a videotape in Deck 1 or Deck 2.

- If the tape has a record safety tab, you will see the menu at left.
- If the tape is missing the record safety tab, please see MOVIE ADVANCE on page 30.

#### 2 OPEN "SEARCH MENU"

While the tape is stopped or playing, press SEARCH/INDEX.

#### 3 SELECT SPECIAL SEARCH FUNCTION

Press 2, 3, 4 or 5 to select one of the following:

##### 2 - Blank Search

Searches for the next available blank (unrecorded) segment on your tape. This makes it easy to find available space when recording TV shows or editing tapes.

- If the VCR finds blank tape, it will stop.
- If the VCR does not find blank tape, it will eject the tape.

##### 3 - Direct Time Search

Locates a specific tape counter position in hours, minutes, and seconds. This is useful for editing purposes; e.g., you can advance the tape directly to the beginning of the desired scene.

- Press 1 for positive or 2 for negative counter values.
- Use the 0-9 keys to enter the desired time in hours, minutes, and seconds.
- Press CLEAR if you need to back up and re-enter a number.
- Press SEARCH/INDEX to advance the tape to the specified time.

##### 4 - Return to 0:00:00

Advances your videotape to tape counter position 0:00:00. This is useful when editing from a baseline counter value of 0:00:00.

- When selected, the VCR will automatically rewind or fast-forward the tape to counter position 0:00:00.

##### 5 - Manual CA Playback

See sidebar at left.

Follow these steps to enjoy MOVIE ADVANCE, a handy feature that automatically finds the beginning of the movie on most rented and purchased video tapes. You can also use MOVIE ADVANCE to selectively watch or skip the previews.

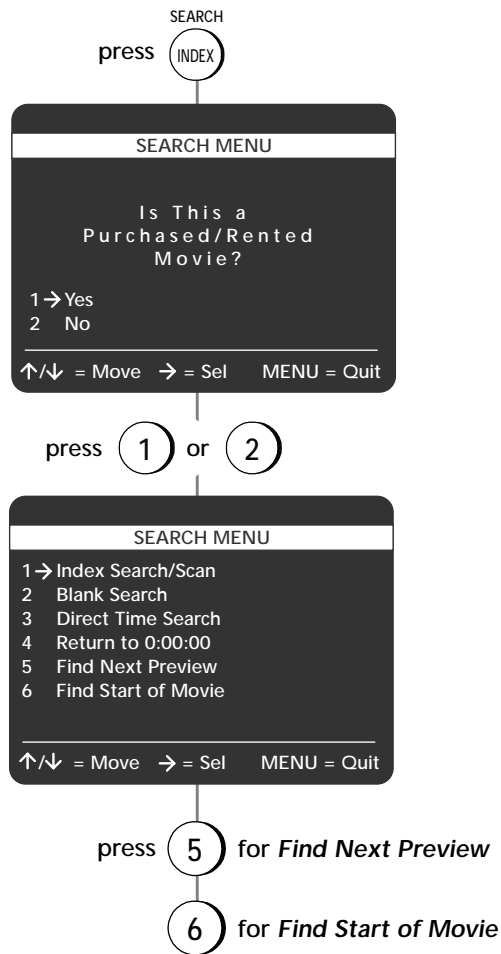

#### OVERRIDING PREVIEW SKIP

You can temporarily override the preview skip in two ways:

- While the VCR is rewinding to the beginning of a preview, press SEARCH/INDEX and the VCR will search for the next preview.
- While the VCR is searching for the next preview and you see the start of a preview you want to watch, press SEARCH/INDEX and MOVIE ADVANCE will reverse back to the start of that preview.

#### 1 INSERT TAPE

- Insert a purchased/rented video in Deck 1.
- MOVIE ADVANCE works in Deck 1 only.
  - Tapes must be recorded in SP with the record safety tab removed.

#### 2 OPEN "SEARCH MENU"

Press SEARCH/INDEX.

#### 3 "IS THIS A PURCHASED/RENTED MOVIE?"

The VCR will recognize that the tape is missing the record safety tab, but must verify that it is a purchased/rented movie and not a personal recording. Press 1 for "Yes" or 2 for "No."

- If you choose "Yes," continue with Step 4.
- If you choose "No," the tape is a personal recording and MOVIE ADVANCE will not be available. Try the other search features starting on page 28.

#### 4 FIND NEXT PREVIEW OR START OF MOVIE

Press 5 or 6 to select one of the following:

##### 5 - Find Next Preview

The VCR will cue forward and begin playing the first preview. You can either watch the preview, or press SEARCH/INDEX to cue to the next preview, and so on.

- The VCR actually cues slightly past the preview and then rewinds and plays the preview. While the VCR is rewinding, you can override preview skip; see sidebar.

##### 6 - Find Start of Movie

The VCR will cue past all previews and pause at the start of the movie. Press PLAY ► to start the movie.

#### NOTES

- In "Find Next Preview" mode, you can still advance to the start of a movie. Simply press STOP ■■, then press SEARCH/INDEX, then press 6 to select "Find Start of Movie."
- MOVIE ADVANCE® is a trademark of SRT, Inc. A Jerry Iggulden invention licensed in association with Arthur D. Little Enterprises, Inc.

## ADVANCED CONNECTIONS

This Chapter will show you how to connect additional components, such as a cable box, stereo, or satellite receiver, to your Dual-Deck VCR.

Follow these steps to change the RF Output Channel from 3 (the default) to 4 in the menu system. This feature takes the place of the standard Ch3-4 rear panel switch.

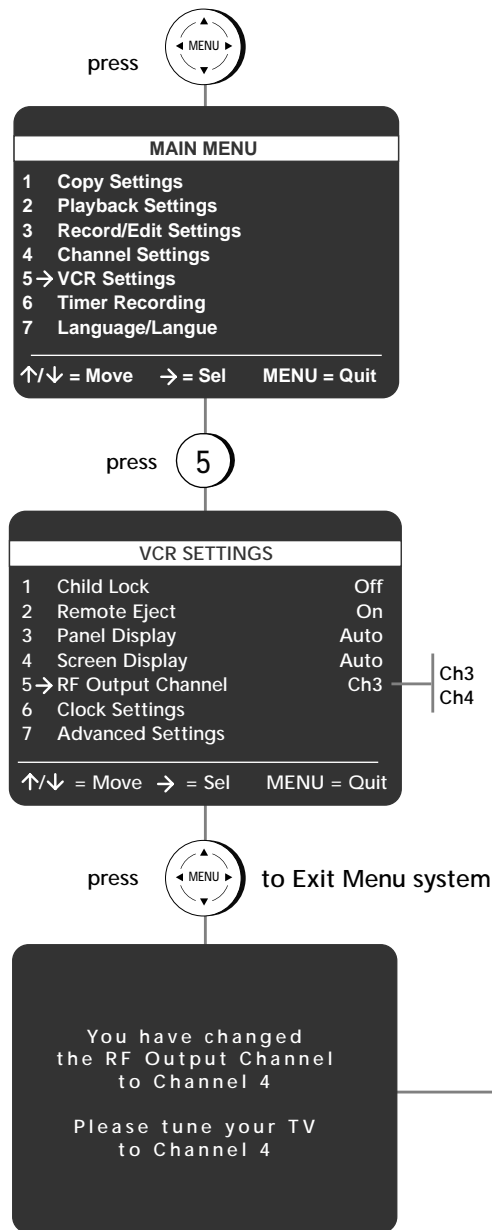

- 1 **OPEN "MAIN MENU"**  
Press MENU.
- 2 **SELECT "VCR SETTINGS"**  
Press 5.
- 3 **SET "RF OUTPUT CHANNEL"**  
Press 5 to set the RF Output Channel to 3 or 4, whichever is not currently in use.
- 4 **EXIT MENU SYSTEM**  
Press MENU.
  - At this point, an alert message will appear for a few seconds reminding you to change your TV to 3 or 4. Locate your TV remote, and proceed with Step 5.
- 5 **CHANGE TV CHANNEL**  
Set your TV to channel 3 or 4, whichever you selected in Step 3.
  - The VCR should function normally.
  - If the picture is not improved, repeat this process and return to the previous channel.

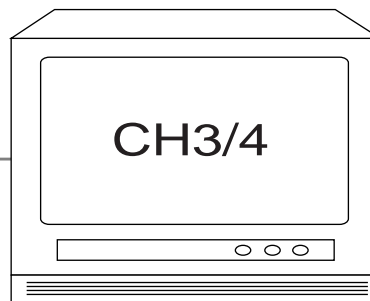

Set TV to channel 3 or 4.

Follow these steps to connect your Dual-Deck VCR to a stereo system, stereo television, or monitor TV.

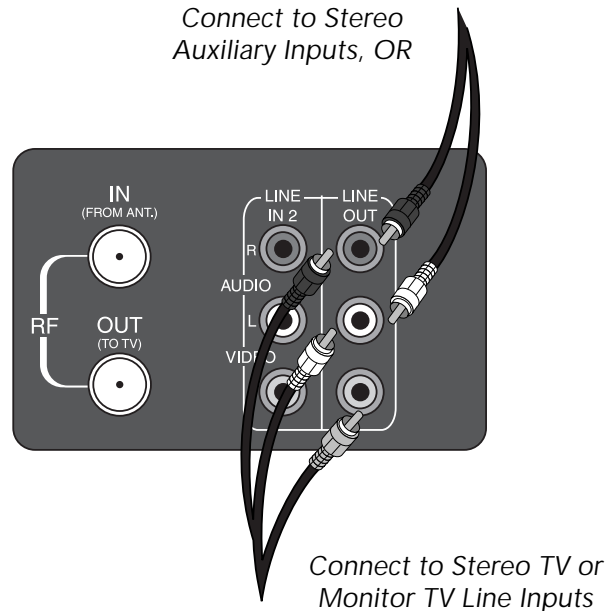

#### STEREO CONNECTION

- 1 **CONNECT VCR TO STEREO**  
Connect RCA cables from the "Line Out" audio jacks (R and L) on the back of the VCR to the line inputs on your stereo receiver.
- 2 **SET STEREO TO AUXILIARY MODE**  
Set your stereo receiver to "Aux" or "Line" (refer to your stereo owner's guide for the proper setting).

#### STEREO TV/MONITOR TV CONNECTION

- 1 **CONNECT VCR TO STEREO TV/MONITOR TV**  
Connect RCA cables from the "Line Out" audio jacks (R and L) and video jack on the back of the VCR to the line inputs on your stereo television or monitor TV.
- 2 **SET TV TO AUXILIARY MODE**  
Set your stereo TV/monitor TV to "Aux," "Video," or "Line" (refer to your owner's guide for the proper setting.)

#### NOTES

- A monitor TV is not the same as a computer monitor.
- Make sure that "Deck 1 Hi-Fi" and "Deck 2 Hi-Fi" are turned on in the menu system; see page 13.
- With this connection, the TV/VCR button on the front panel has no effect. It is as if the TV/VCR button were always set to VCR.

Follow these steps to connect your Dual-Deck VCR to an external audio/video component, such as an additional VCR, laser disc player, DVD player, camcorder, satellite receiver, video game, etc.

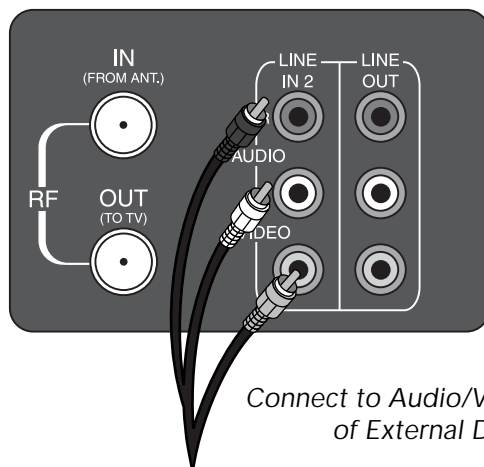

## 1 CONNECT DEVICE TO VCR

Connect RCA cables from the audio/video outputs of your external device to the audio /video inputs on the front or back of the VCR.

## 2 EXTERNAL DEVICE OPTIONS

Once you have connected an external device to your Dual-Deck VCR, you can perform the following functions:

### **Watch Device**

Press TV VIEW until playback from Line 1 (front panel inputs) or Line 2 (rear panel inputs) appears on your TV screen.

### **Record Device**

Press TV VIEW until playback from Line 1 (front panel inputs) or Line 2 (rear panel inputs) appears on your TV screen, then press REC on the active deck.

### **Timer Record From Device**

Select Line 1 or Line 2 as your Record Source in the Timer Record menu; see page 17. All other Timer Record settings should be set in the usual manner.

### **Label Device**

You can label the front and rear A/V inputs to match the device you have connected; see page 35.

Follow these steps if you have a cable box and want to be able to watch a second channel while recording a TV program.

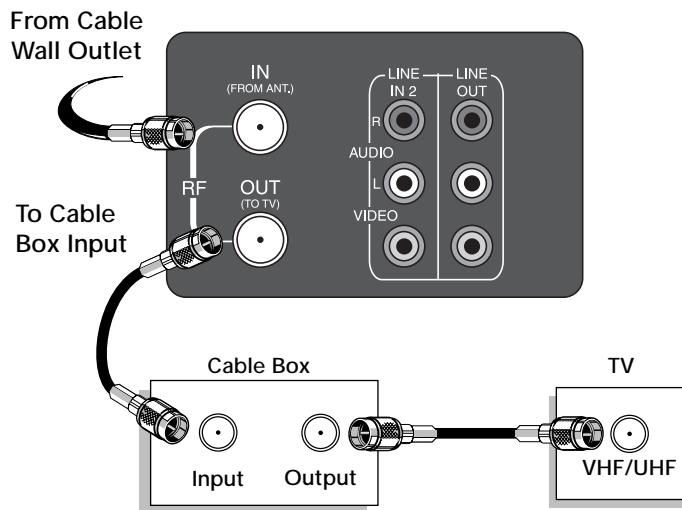

- 1 CONNECT CABLE TO TV**  
Connect an RF coaxial cable from the wall outlet to the "IN (FROM ANT.)" jack on the back panel of the DVD+VCR.
- 2 CONNECT DVD+VCR TO CABLE BOX**  
Connect the RF coaxial cable from the "OUT (TO TV)" jack on the back panel of the DVD+VCR to the Input jack on the Cable Box.
- 3 CONNECT CABLE BOX TO TV**  
Connect an RF coaxial cable from the Output jack on the Cable Box to the "Antenna In" connection on the back of the TV.

- 4 TUNE THE TV**  
Set the TV to channel 3 or 4, whichever is used by your cable box.
- 5 TUNE CABLE BOX**  
With all three devices turned on, set your Cable Box to channel 3 or 4 (whichever is set on the DVD+VCR), and then press SETUP/ENTER.
- 6 CONNECTION IS COMPLETE!**  
The "Language/Langue/Idioma" menu will appear on your television screen. Please proceed with Auto Setup on page 3.

## NOTES

- To view cable box channels, set the TV/VCR switch to TV. To watch the DVD+VCR through the RF output, set the TV/VCR switch to VCR and tune channel 3 or 4 on the cable box.
- With this hookup, you can watch scrambled channels, but you will not be able to record them.



Follow these steps to label the front and rear A/V inputs; e.g., if you have a DVD Player connected to the rear line inputs, you can change the label from "Line 2" to "DVD" throughout the menu system.

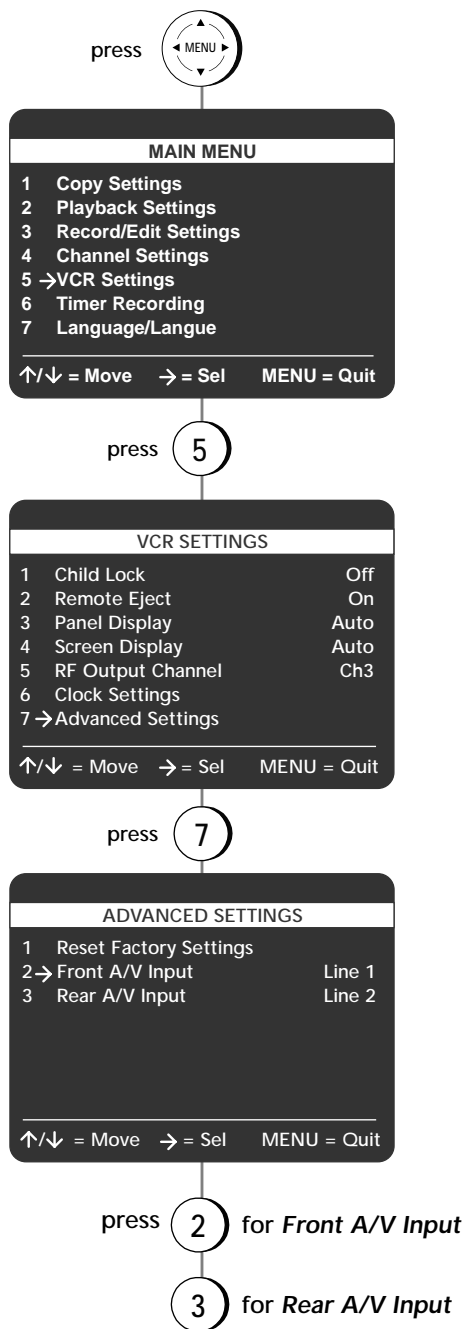

**1 OPEN "MAIN MENU"**

Press MENU.

**2 SELECT "VCR SETTINGS"**

Press 5.

**3 SELECT "ADVANCED SETTINGS"**

Press 7.

**4 SET "FRONT A/V INPUT"**

Press 2 to label the Front A/V Input to one of the following:

- **Line1** – Line 1 (default)
- **Vid1** – Video 1
- **SAT**– Satellite Receiver
- **LD** – Laserdisc Player
- **DVD** – Digital Video Disc Player
- **DSS** – Digital Satellite System
- **VCR3** – Third Video Cassette Recorder
- **CAM** – Camcorder or Videocamera
- **GAME** – Video Game
- **RCVR** – Stereo Receiver
- **TV** – Television

**5 SET "REAR A/V INPUT"**

Press 3 to label the Rear A/V Input to one of the following:

- **Line2** – Line 2 (default)
- **Vid2** – Video 2
- **SAT**– Satellite Receiver
- **LD** – Laserdisc Player
- **DVD** – Digital Video Disc Player
- **DSS** – Digital Satellite System
- **VCR3** – Third Video Cassette Recorder
- **GAME** – Video Game
- **RCVR** – Stereo Receiver
- **TV** – Television

## B

## CUSTOM SETTINGS

This Chapter will show you how to customize your Dual-Deck VCR experience, with settings that affect language, clock, channels, displays and more.

Follow these steps to set the on-screen menu language to English or French.

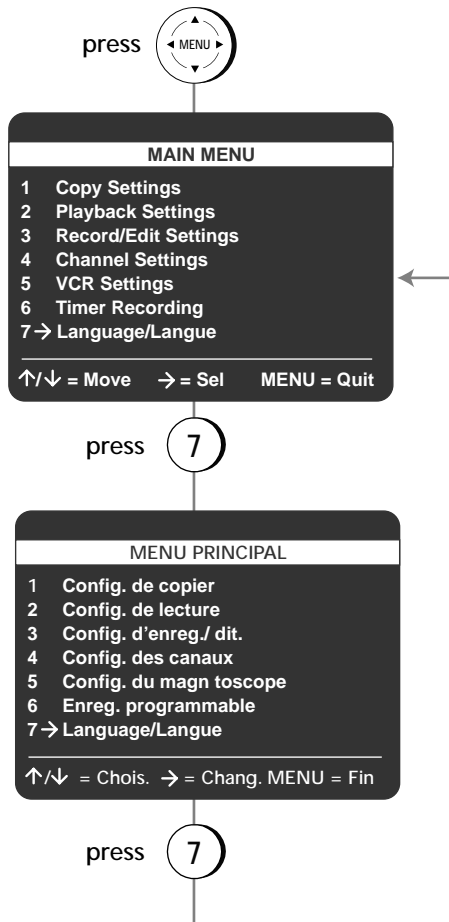

---

**1 OPEN "MAIN MENU"**

Press MENU.

---

**2 SELECT LANGUAGE**

Press 7 repeatedly to set the on-screen menu language to English or French.

**NOTE**

- Each time you press 7, the entire Main Menu will be translated into English or French.

Follow these steps to turn Auto Clock Set on or off. You can also specify the time zone and the channel that Auto Clock Set uses to determine your local time.

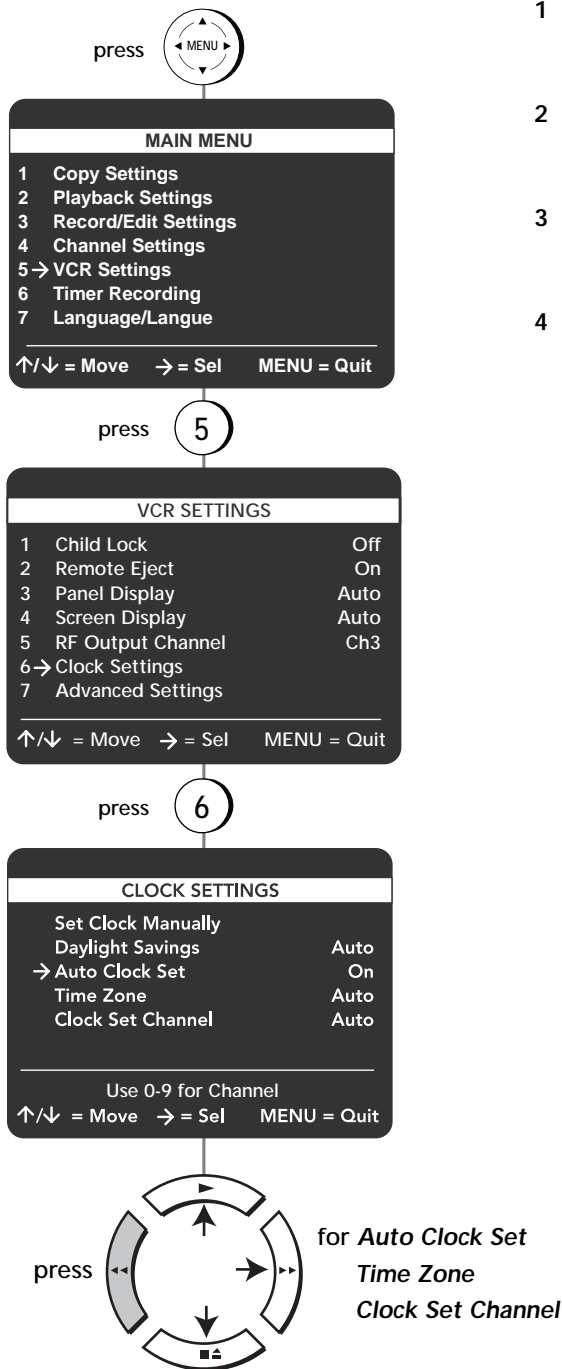

- 1 **OPEN "MAIN MENU"**  
Press MENU.
- 2 **SELECT "VCR SETTINGS"**  
Press 5.
- 3 **SELECT "CLOCK SETTINGS"**  
Press 6.
- 4 **ADJUST CLOCK SETTINGS**  
Use the arrow keys to select and set each of the following:

**Daylight Savings**

Please refer to page 39.

**Auto Clock Set**

**On** – Auto Clock Set will search for a local channel and detect the time automatically.

**Off** – Auto Clock Set will be disabled. You must set the clock manually.

**Time Zone**

**Auto** – Automatically detects your local time zone.

**Eastern** – Selects Eastern Standard Time.

**Central** – Selects Central Standard Time.

**Mountain** – Selects Mountain Standard Time.

**Pacific** – Selects Pacific Standard Time.

**Alaska** – Selects Alaska Standard Time.

**Hawaii** – Selects Hawaii Standard Time.

**Clock Set Channel**

**Auto** – Automatically searches for a local channel broadcasting the time via XDS (Extended Data Services).

**Ch##** –If you know of a station in your area that broadcasts time information, you can set the Auto Clock Set channel manually. Use the 0-9 keys to set the desired channel (usually PBS).

**Line 1** – Allows the clock to be set from an audio/video device attached to your VCR's front line input.

**Line 2** – Allows the clock to be set from an audio/video device attached to your VCR's rear line input.

**NOTE**

- If "Auto Clock Set" is off, then "Time Zone" and "Clock Set Channel" will not appear on the "Clock Settings" menu.



If Auto Clock Set is not available in your area, follow these steps to set the clock manually (see notes below before proceeding).

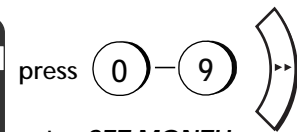
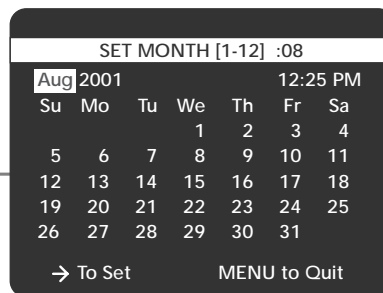
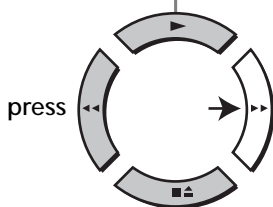
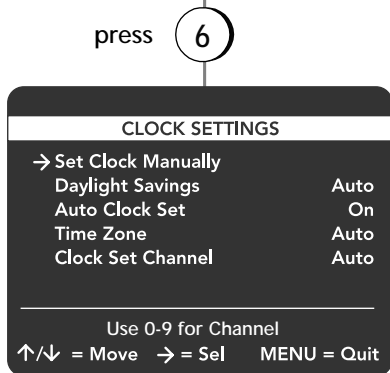
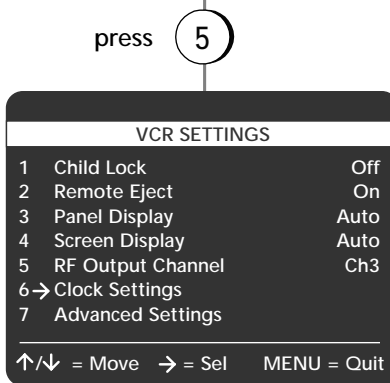

to **SET MONTH,**  
**SET YEAR,**  
**SET DAY,**  
**SET HOUR,**  
**SET MINUTE,**  
**SET AM/PM**

- 1 OPEN "MAIN MENU"**  
Press MENU.

---

- 2 SELECT "VCR SETTINGS"**  
Press 5.

---

- 3 SELECT "CLOCK SETTINGS"**  
Press 6.

---

- 4 CHOOSE "SET CLOCK MANUALLY"**  
Press the right arrow key.

---

- 5 SET THE TIME**  
Use the 0-9 keys or the up/down arrow keys to set each of the following items. To skip an item, press the right arrow key:  
**Set Month** – Enter the month as a 2-digit number; e.g. January = "01"  
**Set Year** – Enter the year as a 2-digit number; e.g. 2001 = "01"  
**Set Day** – Enter the day as a 2-digit number; e.g. the ninth = "09"  
**Set Hour** – Enter the hour as a 2-digit number; e.g. 12:xx = "12"  
**Set Minute** – Enter the minute as a 2-digit number; e.g. xx:25 = "25"  
**Set AM/PM** – Press "1" for AM, "2" for PM

---

- 6 SAVE SETTINGS**  
Press MENU to save and exit the menu system.

**NOTES**

- If Auto Clock Set is available but has set the time incorrectly, try adjusting Daylight Savings Time (page 39), Time Zone (page 37) and Clock Set Channel (page 37) before setting the clock manually.
- If you choose "Set Clock Manually," then "Auto Clock Set" will automatically turn off, and "Time Zone" and "Clock Set Channel" will be removed from the menu.

Follow these steps to set Daylight Savings Time manually. You should only set "Daylight Savings" if Auto Clock Set set the time incorrectly.

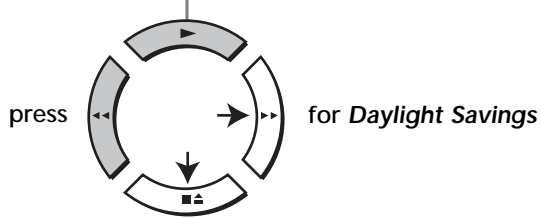
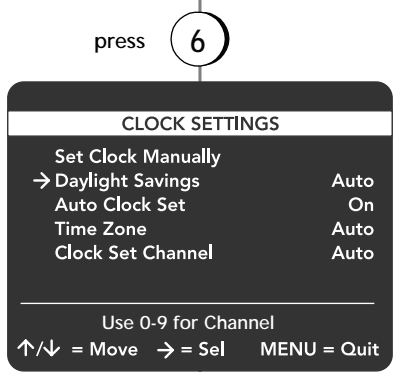
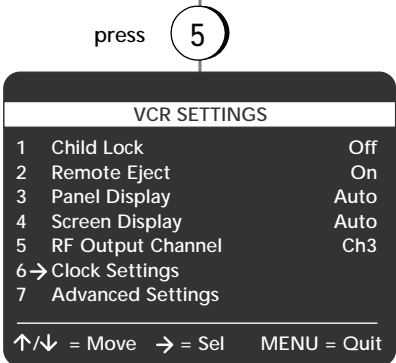

- 1 **OPEN "MAIN MENU"**  
Press MENU.
- 2 **SELECT "VCR SETTINGS"**  
Press 5.
- 3 **SELECT "CLOCK SETTINGS"**  
Press 6.
- 4 **SELECT "DAYLIGHT SAVINGS"**  
Press the down arrow key until "Daylight Savings" is selected.
- 5 **ADJUST "DAYLIGHT SAVINGS"**  
Press the right arrow key to select from the following:

**Auto** – The VCR will automatically use local channel information to determine the status of Daylight Savings Time in your area, and then set the clock accordingly.

**Off** – The VCR will not adjust the clock for Daylight Savings Time.

**On** – The VCR will adjust the clock for Daylight Savings Time as follows: One hour will be added to the time at 2:00 AM on the first Sunday of April and one hour will be subtracted from the time at 2:00 AM on the last Sunday in October.

**NOTES**

- If "Auto Clock Set" is off, then "Time Zone" and "Clock Set Channel" will not appear on the "Clock Settings" menu.
- If you are an Arizona resident, set "Daylight Savings" to "Off" and set "Time Zone" to "Mountain" (see page 37).



Follow these steps to set all Channel Settings for your Dual-Deck VCR, including Channel Source, Add/Remove Channel, Show Weak Channels and Channel Audio.



for Channel Source

- Auto Channel Search
- Add/Remove Channel
- Show Weak Channels
- Channel Audio

- 1 **OPEN "MAIN MENU"**  
Press MENU.
- 2 **SELECT "CHANNEL SETTINGS"**  
Press 4.
- 3 **ADJUST CHANNEL SETTINGS**  
Use the arrow keys to select and set each of the following:

**Channel Source**

**Auto** – Automatically detects whether you are receiving channels from antenna or cable.

**Antenna** – Specifies that you are receiving channels from antenna.

**Cable** – Specifies that you are receiving channels from cable.

**Auto Channel Search**

Automatically searches for all available channels and stores them in memory. When finished, the VCR will display the lowest channel found.

**Add/Remove Channel**

Use the 0-9 keys to enter the channel number you wish to add or remove, then press the right arrow key to add or remove the channel.

**Show Weak Channels**

**Yes** – Channels with weak signal strength will be displayed instead of being replaced with a blue screen.

**No** – A blue screen will appear when a weak channel is received.

**Channel Audio**

**Stereo** – Enables stereo sound when available; otherwise, reverts to mono.

**Mono** – Enables mono sound. Use when connecting the VCR to a mono output device, such as a monitor.

**SAP** – Second Audio Program, often used to transmit a second language. SAP appears on the front panel display if it is available.

**TV+SAP** – Outputs mono from the left channel and SAP from the right channel.

**Simulcast** – Plays the audio signal from the rear line inputs, usually connected to a stereo system.

**NOTES**

- Use TV+SAP to listen to a second language with headphones while the primary language is played through your TV speakers.
- Use Simulcast to enjoy programs broadcast simultaneously via television and FM radio.

Follow these steps to customize the functionality of the Dual Deck VCR, including Child Lock, Remote Eject, Front Panel Display, On-Screen Display, and RF Output Channel.

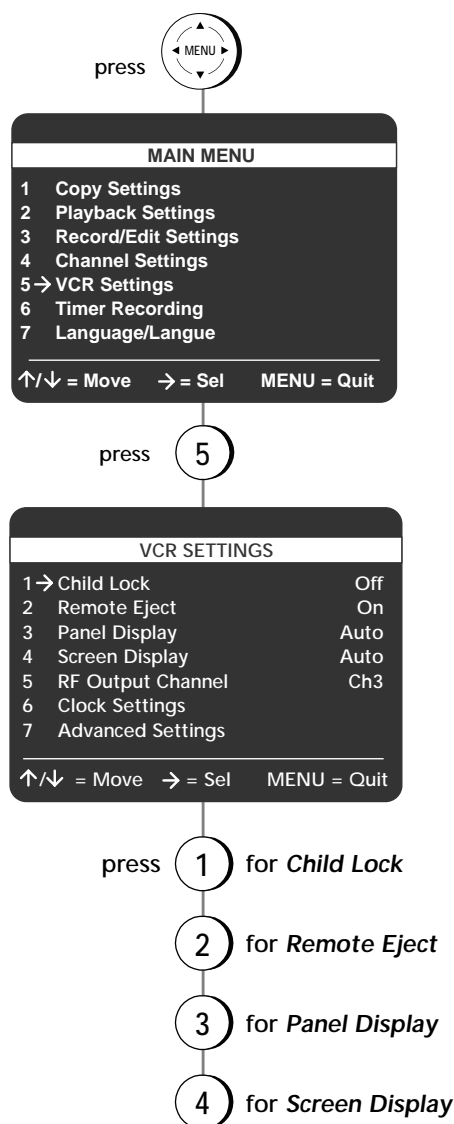

### 1 OPEN "MAIN MENU"

Press MENU.

### 2 SELECT "VCR SETTINGS"

Press 5.

### 3 ADJUST VCR SETTINGS

Press 1, 2, 3, or 4 to set each of the following:

#### 1 - Child Lock

**Off** – The VCR front panel keys will function normally.

**On** – The VCR front panel keys will be locked to prevent children from tampering with the VCR. Once this feature is enabled, you must use the remote control to operate the VCR.

#### 2 - Remote Eject

**On** – Allows you to eject tapes by pressing STOP ■▲ on the remote control.

**Off** – Prevents tapes from being ejected unless you press STOP ■▲ on the front panel.

#### 3 - Panel Display

**Auto** – The front panel display will be bright from 6:00 a.m. to 10:00 p.m. and dim from 10:00 p.m. to 6:00 a.m.

**Bright** – The panel display will be bright at all times.

**Dim** – The panel display will be dim at all times.

**Off** – The panel display will be off at all times.

#### 4 - Screen Display

**On** – The entire On-Screen Display (OSD) will be shown each time you press a deck or tuner control key (Play, Stop, Ch+/-, etc.).

**Off** – The OSD will remain off unless you press DISPLAY.

**Auto** – The OSD will only show information relevant to the key you pressed.

### NOTE

- Child Lock also disables automatic playback of tapes and automatic power on when you insert tapes.

Follow these steps to reset the Dual-Deck VCR to its factory settings. If you wish, you may preserve your clock settings and any saved timer recordings.

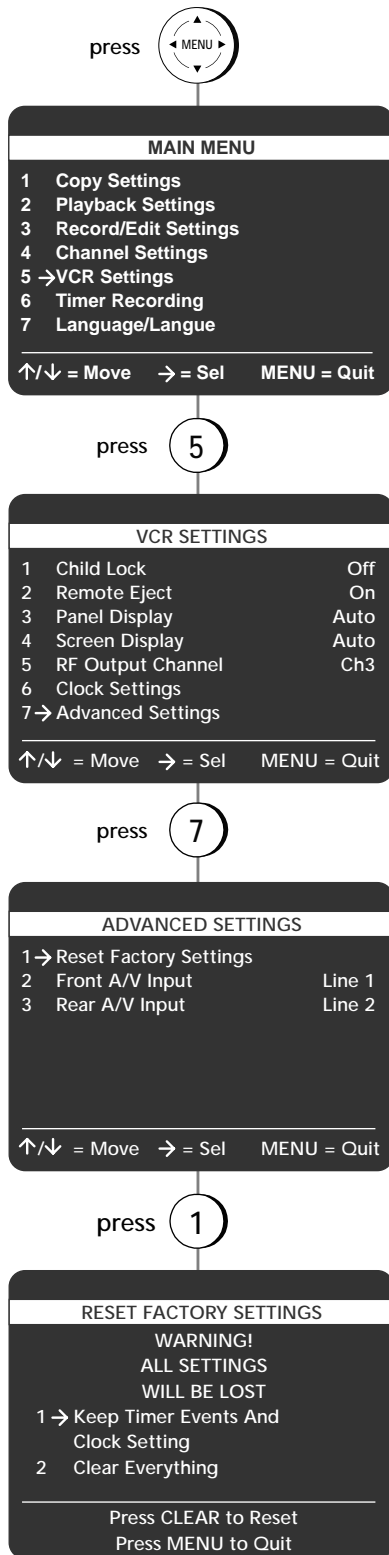

- 1 OPEN "MAIN MENU"**  
Press MENU.
- 2 SELECT "VCR SETTINGS"**  
Press 5.
- 3 SELECT "ADVANCED SETTINGS"**  
Press 7.
- 4 SELECT "RESET FACTORY SETTINGS"**  
Press 1.
- 5 DECIDE WHAT TO RESET**  
Press 1 or 2.
  - 1** – Resets everything except the clock and any saved Timer Recordings.
  - 2** – Clears all VCR settings including the clock and any saved Timer Recordings.
- 6 RESTORE SETTINGS**  
Press CLEAR to confirm your decision to reset factory settings; or, press MENU to cancel and exit the menu system.

press **1** to Keep Timer Events & Clock Setting

press **2** to Clear Everything, then press **CLEAR**



# C

# HELP

*This Chapter provides customer support information, as well as a list of frequently asked questions, technical specifications, and the product warranty.*



The chart below will help you solve common challenges with your Dual-Deck VCR. If you don't find the answers you need here, you can contact our Customer Service Department as follows:

<b>Phone:</b>	(480) 922-0896
<b>Office hours:</b>	Monday-Friday, 6:00 a.m. to 9:00 p.m. MST Saturday-Sunday, 8:00 a.m. to 4:00 p.m. MST
<b>E-Mail:</b>	"customerservice@sensoryscience.com"
<b>Web:</b>	"www.govideo.com" or "www.sensoryscience.com"

# TROUBLESHOOTING

SYMPTOM	SOLUTION(S)
No picture.	<ul style="list-style-type: none"> <li>• Press TV/VCR until VCR indicator lights on front panel display.</li> <li>• Set RF Output to channel 4; see page 31.</li> </ul>
Poor picture quality.	<ul style="list-style-type: none"> <li>• Set RF Output to channel 4; see page 31.</li> <li>• Adjust tracking with AUTO and TRK up/down keys.</li> <li>• Clean video heads with nonabrasive head cleaning tape.</li> </ul>
Remote not working.	<ul style="list-style-type: none"> <li>• Remove all obstacles and point directly at VCR.</li> <li>• Make sure batteries are fresh and properly installed.</li> <li>• Press VCR key. Note: If you press TV key by accident, remote will only operate TV.</li> </ul>
Remote won't operate TV.	<ul style="list-style-type: none"> <li>• Program the remote control for your brand of TV; see page 4.</li> <li>• Press the TV key.</li> <li>• Remote control doesn't operate every TV function. Some TV brands only respond to limited number of functions.</li> </ul>
On-screen display shows "Error" .	<ul style="list-style-type: none"> <li>• Turn power off, then turn power on again.</li> <li>• Inspect tape slots for foreign objects.</li> </ul>
VCR doesn't work.	<ul style="list-style-type: none"> <li>• Unplug VCR for 10 seconds, then plug it in again.</li> <li>• If still doesn't work, unplug VCR for at least 15 minutes, then plug it in again. Note: If the clock is still set, you haven't unplugged it long enough.</li> <li>• If still doesn't work, VCR must be serviced by an authorized service center.</li> </ul>

SYMPTOM	SOLUTION(S)
Cannot record from cable box.	<ul style="list-style-type: none"> <li>• Set VCR to cable box output channel 2, 3 or 4, then select desired channel on cable box.</li> </ul>
Cannot Timer Record.	<ul style="list-style-type: none"> <li>• Set clock to correct time; see page 38.</li> </ul>
Copy speeds do not match.	<ul style="list-style-type: none"> <li>• Turn Speed Matching on; see page 11.</li> </ul>
Tape ejects during copy or record.	<ul style="list-style-type: none"> <li>• Place piece of tape over record safety tab opening.</li> </ul>
VCR automatically plays and rewinds.	<ul style="list-style-type: none"> <li>• To turn Auto Play/Rewind off; see page 13.</li> <li>• Turn EZ-Copy off; see page 11.</li> </ul>
8-Scene Edit List not working.	<ul style="list-style-type: none"> <li>• Insert source tape in Deck 1.</li> <li>• 8-Scene Edit List is unavailable while copying a tape.</li> </ul>
Cannot eject tapes with remote.	<ul style="list-style-type: none"> <li>• Turn on Remote Eject in menu system; see page 41.</li> <li>• Remote eject is unavailable if scenes are programmed in 8-Scene Edit List. Clear scenes from Edit List or press STOP ■▲ on front panel to erase scenes automatically.</li> </ul>
Cannot reset Deck 1 tape counter.	<ul style="list-style-type: none"> <li>• Deck 1 counter reset is unavailable if scenes are programmed in 8-Scene Edit List. Clear scenes from Edit List or press STOP ■▲ on front panel to erase scenes automatically.</li> </ul>
Tape counters not moving.	<ul style="list-style-type: none"> <li>• To display tape counters, the VCR requires control track, which is only present on prerecorded tapes.</li> </ul>
No menu or On-Screen Displays.	<ul style="list-style-type: none"> <li>• Tape may be blank ("snow" appears on screen). If so, menus and On-Screen Display cannot be shown. Stop tape or record on tape to enable displays.</li> <li>• Remote may be set to control TV and not VCR. Press VCR key to reactivate it.</li> <li>• Date/Time Stamp may be set to "Cont" (Continuous) with recording in progress. Press STOP ■▲ on recording deck to restore normal on-screen functions; see page 15.</li> </ul>
TV shows blue screen.	<ul style="list-style-type: none"> <li>• If current channel is too weak to display clear picture, VCR will display blue screen. To show weak channels, see page 40.</li> <li>• Double-check antenna connections or tuner settings.</li> </ul>
Front panel display blinking.	<ul style="list-style-type: none"> <li>• VCR is in Auto Power Off mode. If you press POWER while rewinding, copying, Timer Recording, One-Touch Recording or EZ-Copying, VCR will automatically turn off when the given function is complete.</li> <li>• Press POWER to toggle Auto Power on and off.</li> </ul>
Copy blinking on front panel display.	<ul style="list-style-type: none"> <li>• Indicates deck is paused while copying tape.</li> </ul>
No stereo sound.	<ul style="list-style-type: none"> <li>• Connect TV and VCR with RCA line cables. If your TV and VCR are connected with an RF coaxial cable, you will only hear stereo sound if VCR is turned off.</li> </ul>
No sound on Timer Recording.	<ul style="list-style-type: none"> <li>• Record source was accidentally set to Ch##s, Simulcast. Select the tuner channel without simulcast; see page 17.</li> </ul>

The following are the technical specifications for your Dual-Deck VCR.

VIDEO SYSTEM	1/2-inch VHS system, 4 rotary head helical scanning; FM azimuth luminance; chrominance: converted sub system phase shift.
TELEVISION SYSTEM	NTSC-type color signal EIA standard (525 lines, 60 fields)
AUDIO TRACK	Normal: 1 track; Hi-Fi: 2 track
TAPE WIDTH	12.7 mm, 1/2 inch
TAPE SPEED	SP: 33.35 mm/s; SLP: 11.12 mm/s
PLAY/RECORD TIME	T-180 tape: SP 3 hours, SLP 9 hours
FF/REW TIME	T-120 tape: <2 minutes
HEADS	Video: DA 4 rotary heads Audio: 2 rotary heads (Hi-Fi); 1 stationary head (Linear) Control: 1 stationary head Erase: 1 full track, 1 audio track
VIDEO	Input: RCA Type, 75 ohms unbalanced, 1 V P-P (x2) Output: RCA Type, 75 ohms unbalanced, 1 V P-P Horiz Res: Monochrome, more than 230 lines S/N Ratio: Better than 43 dB
AUDIO	Input: AUDIO IN (RCA) -8 dbm, 47K ohms (x2) Output: AUDIO OUT (RCA) -8 dbm, 1.5K ohm TV Tuner: 181 channel frequency synthesized. VHF input Ch 2 - Ch 13. UHF input Ch 14 - Ch 69. VHF & UHF one input. Cable Ch 1-125. 75 ohm unbalanced F-type connector. S/N Ratio: Better than 68 dB (Hi-Fi)
WOW & FLUTTER	Less than 0.005% (Hi-Fi)
RF MODULATION	Channel 3 or 4
FREQUENCY RESPONSE	20-20,000 Hz (Hi-Fi)
POWER REQUIREMENT	120V AC, 60 Hz, 32 watts maximum
ENVIRONMENT	41-104 F (5-40 C); 10%-75% humidity
DIMENSIONS	534 x 324 x 102 mm (21" x 12 3/4" x 4")
WEIGHT	5.0 kg (11.1 lbs.)

**DUAL-DECK VCR LIMITED WARRANTY*****Who Provides the Limited Warranty***

During the warranty period, the Go-Video Warranty Administrator will honor Dual-Deck VCR service for 90 days labor, 1 year parts from the original date of consumer purchase. See below for Commercial, Industrial or Educational use coverage. Dual-Deck VCR remote controls are warranted for 90 days from the date of purchase.

**90** days labor  
**1** year parts

***Who is Protected***

This warranty protects the original consumer owner of this Go-Video product.

***What is Covered and How Long***

This warranty covers internal operating parts and service/labor to repair or replace covered parts in this Go-Video product for 90 days labor, 1 year parts, from the date of purchase, defined as follows: (1) Original Consumer Retail Purchase; (2) First Rental Purchase Agreement; or (3) First Lease Purchase Agreement (the "Warranty Period"). Labor and replacement parts supplied during the Warranty Period are covered only for the remaining portion of the original Warranty Period. The Go-Video Warranty Administrator shall have no liability for service under this warranty if non-OEM (Original Equipment Manufacturer) replacement parts are used in the repair of your Go-Video product.

***What the Owner Must Do If Service is Required***

If service under this warranty is required, contact the Go-Video Warranty Administrator at (480) 922-0896 to determine the nearest authorized Go-Video service center.

***Other Warranty Coverage***

Commercial, Industrial or Educational use has the same warranty coverage as stated in this warranty.

***What are the Exceptions***

This warranty does not cover: (1) Normal maintenance service, such as video head cleaning. (2) Damage from misuse, abuse neglect or accident, natural disasters or Acts of God. (3) Cabinetry, decorative parts, A/C adapters, knobs or buttons. (4) The foreign country use of this product. (5) Go-Video product which has been electronically or mechanically modified in any way or incorporated into other products. (6) Installation and setup service adjustments. (7) Owner instruction. Your Owner's Guide provides information regarding operating instructions and user controls. For additional information, contact your authorized Go-Video dealer. Go Video is not responsible for any shipping, handling or insurance charges.

This Exclusive Limited Warranty excludes all incidental and consequential damages. Some states do not allow the exclusion of incidental and consequential damages, so the above exclusion may not apply to you.

ALL IMPLIED WARRANTIES, INCLUDING IMPLIED WARRANTIES OF MERCHANTABILITY AND FITNESS FOR A PARTICULAR PURPOSE ARE LIMITED IN DURATION TO THE DURATION OF THIS WARRANTY PERIOD. Some states do not allow limitations on how long an implied warranty lasts, so the above limitation may not apply to you.

This Exclusive Limited Warranty gives you specific legal rights and you may also have other rights which vary from state to state.

**GO-VIDEO WARRANTY ADMINISTRATOR**

Sensory Science Corp.  
7835 East McClain Drive • Scottsdale, Arizona 85260-1732  
(480) 922-0896 • customerservice@sensoryscience.com

## Symbols

0-9 keys 5  
 1-Time 17  
 100+ key 5  
 8-Scene Edit List 15, 19

## A

Add Channel 40  
 AM/PM indicator 8  
 Audio  
   Outputs 32  
   Source 21  
 Auto Channel Search 3, 40  
 Auto Clock Set 3, 37  
 Auto Commercial Free Copy 26  
 Auto Play/Rewind 12, 13, 20  
 Auto Setup 3  
 Auto Show Finder 27, 28

## B

Background  
   Blue 25  
   Video 25  
 Batteries, Insert 1  
 Blank Search 29

## C

Cable 40  
 Cable Box Record Source 17  
 Camcorder 33, 35  
 Channel 3/4 2, 31  
 Channel Audio 40  
 Channel keys 5, 7  
 Channel Settings 40  
 Channel Source 40  
 Child Lock 41  
 CLEAR key 5, 19, 22  
 CLK/CTR key 5  
 Clock Set Channel 37  
 Clock Settings  
   Auto 37  
   Manual 38  
 Commercial Advance 13, 23  
   Override 25  
 Commercial Free Copy 11  
 Commercials  
   Marking 24  
 Complete Program Record 11, 18  
 Composite Video 2

Connections  
   Advanced 31  
   Alternative Cable Box 34  
   Antenna 2  
   Basic 2  
   Cable box 2  
   Cable TV 2

Copy Audio Insert 11, 21  
 Copy indicator 8  
 Copy Settings 11  
 Copy Tape key 5, 7, 10, 19  
 Copy-Protected Tapes 10  
 Copying, Basic 10  
 Counter Position 9  
 Customer Service 43

## D

Date and Time 9  
 Date/Time Stamp 15, 28  
 Daylight Savings Time 39  
 Deck 1 key 5  
 Deck 1 Status indicator 8  
 Deck 2 key 5  
 Deck 2 Status indicator 8  
 Deck Select key 7  
 Direct Time Search 29  
 Display key 5, 9  
 Dual Playback 13  
 Dual Recording 15  
 DVD Player 33

## E

Editing, Automatic 19  
 Editing, Manual 20  
 English 36  
 Event Frequency 17  
 Event Number 16  
 Event Summary 18  
 EZ Copy 11, 20

## F

Factory Settings, Reset 42  
 Fast-Forward key 5, 7  
 Find Next Preview 30  
 Find Start of Movie 30  
 Frame Advance 12  
 Freeze 12  
 French 36  
 Front Line Inputs 35  
   During Copy Audio Insert 21  
 Front Panel 7  
 Front Panel Display 8

## H

Help 43  
 Hi-Fi, Deck 1 13  
 Hi-Fi, Deck 2 13  
 Hi-Fi indicator 8

## I

Index Marks  
   Automatic 27  
   Defined 27  
   Manual 27  
 Initial Setup 1

## J

Jet Search 12  
 Jog wheel 5

## L

Language Settings 3, 36  
 Laser Disc Player 33  
 LCV key 6  
 Line 1 Input 7  
 Line 2 Input 33  
 Line Input Labeling 7, 35  
 Loop Playback 13  
 Loop Recording 15  
 LP 8

## M

Manual CA Playback 29  
 Menu key 6, 7  
 Monitor Hookup 32  
 Mono 40  
 Mute key 6

## O

On-Screen Display (OSD) 9  
 One-Touch Recording 14  
 OTR 14  
 OTR Loop Record 14  
 Overlapping Events 18  
 Overriding Preview Skip 29, 30

## P

Packing List 1  
 Panel Display 41  
 Picture Search 12  
 Play key 6, 7  
 Playback, Basic 12



Playback Settings 13  
Power key 6, 7

## R

Rear A/V Input 33, 35  
Record key 6, 7  
Record Safety Tab  
    10, 12, 16, 22  
Record Settings 15  
Record Source 9, 15  
Record Speed 8, 9, 11, 14  
Recording, Basic 14  
Remote Control  
    Overview 5  
    Remote Eject 41  
Remove Channel 40  
Repeat 12  
Repeat key 6  
Return to 0:00:00 29  
Rewind key 6, 7  
RF 2  
RF Output Channel 31

## S

Safety iii  
SAP 40  
SAP indicator 8  
Satellite Receiver 33  
Scan Index Marks 28  
Scene/Title key 6, 19, 22  
Screen Display 41  
Search Features 27, 29

Search Index Marks 28  
Search/Index key 6  
Sequential Playback 13  
Sequential Recording 15  
Set Timer key 6  
Show Weak Channels 40  
Shuttle 12  
Shuttle ring 6  
Simulcast 17, 40  
Skip 12  
Skip Edit 20  
Skip key 6  
Slow +/- keys 6  
Slow Motion 12  
SLP 8, 14, 18  
Source Tape 10, 19, 20, 21  
SP 8, 14, 18  
SP/SLP key 6  
Speed Matching 11  
Stereo 31, 35, 40  
Stereo Hookup 32  
Stereo indicator 8  
Still/F.Adv key 6  
Stop/Eject key 6, 7

## T

T-120 Tape 18  
Tape Counter 8  
Tape Missing 18  
Tape Missing Tab 18  
Target Tape 10, 19, 20, 21  
Technical Specifications 45  
Time Zone 37

Timer indicator 8  
Timer Recording 16, 33  
Timer Recording Errors 18  
Titler Message, Recording 22  
Titler, On-Screen 15, 22  
Tracking  
    Auto 12  
    Manual 12  
Tracking keys 6  
Troubleshooting 43  
TV key 6  
TV Mode 4  
TV View 9  
TV View key 6, 33  
TV+SAP 40  
TV/VCR indicator 8  
TV/VCR key 6, 7, 32

## U

Unpacking 1

## V

VCR key 6  
VCR mode 4  
VCR Settings 41  
Video Game 33  
Volume +/- key 6

## W

Warranty 46  
Weekly 17

# DDV2110 MENU SYSTEM

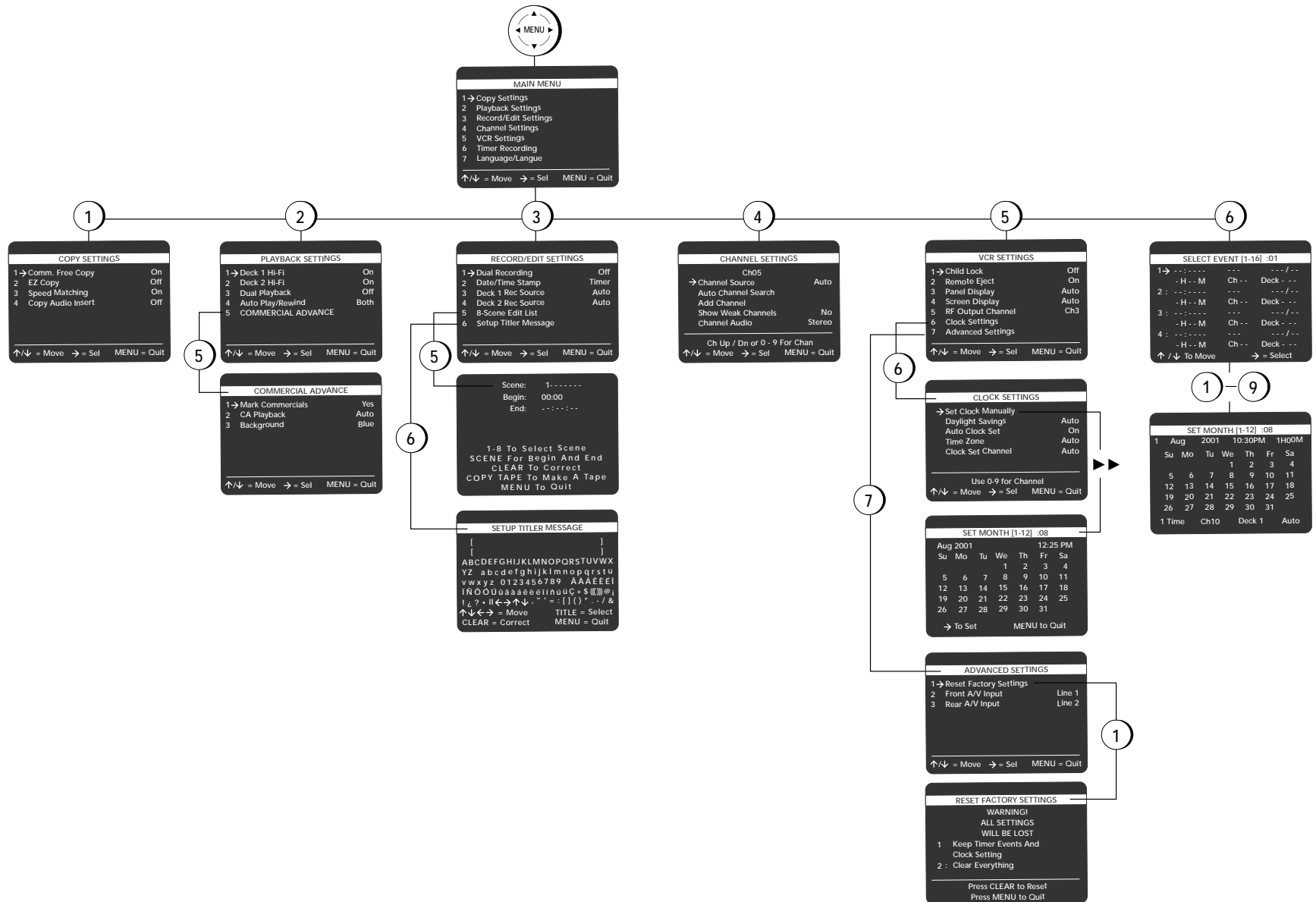

**Thank you for purchasing this Go-Video Dual-Deck VCR!**

Sensory Science specializes in developing and marketing innovative digital entertainment products, including digital televisions, Internet media players, DVD players, and high-end home theater components for the digital living room. We take pride in our ability to deliver unparalleled customer support, and are honored to have received the prestigious *Inside Track* award for Supplier Loyalty two years running. Should you have any questions, feel free to contact us using one of the methods listed below:

*Any  
Questions*

**WEB** [www.govideo.com](http://www.govideo.com)

**E-MAIL** [vcrhelp@sensoryscience.com](mailto:vcrhelp@sensoryscience.com)

**PHONE** 1-800-SENSORY



**S E N S O R Y  
S C I E N C E**

7835 East McClain Drive  
Scottsdale, AZ 85260 USA  
[www.sensoryscience.com](http://www.sensoryscience.com)



## Free Manuals Download Website

<http://myh66.com>

<http://usermanuals.us>

<http://www.somanuals.com>

<http://www.4manuals.cc>

<http://www.manual-lib.com>

<http://www.404manual.com>

<http://www.luxmanual.com>

<http://aubethermostatmanual.com>

Golf course search by state

<http://golfingnear.com>

Email search by domain

<http://emailbydomain.com>

Auto manuals search

<http://auto.somanuals.com>

TV manuals search

<http://tv.somanuals.com>