



Goodmans

G-SHOT 3029TFT

**Multi-Functional
Digital Still Camera**

(User Guide)

Goodmans Helpline Phone Number 0870 873 0080

Specifications

- Image Sensor: 3.2 mega pixel CMOS sensor
 - Digital Camera Resolution :
 - 2048x1536 [3 Mega Pixel]
 - 1600 x 1200 [2 Mega Pixel]
 - 640 x 480 [VGA - 0.3 Mega pixel]
- Image Quality Option (only for digital camera): Super Fine ; Fine ; Normal
- External Storage: SD Card (MMC compatible) up to 512MB
 - Shutter: Electrical
 - Still Image File Format: JPEG
 - Movie File Format: AVI (Motion JPEG), with sound
 - Voice File Format: WAV
 - Movie mode resolution: 640x480(VGA) ; 320 x 240 (QVGA)
 - White Balance: Auto / Manual (Sunny, cloudy, Fluorescent, Tungsten)
 - Flash Modes: Automatic, On, Anti-red eye, Off
 - Microphone: Built-in
 - Digital Zoom: 8X Digital Zoom
 - Lens Aperture: F 4.0
 - Shutter Speed: 1/4 sec to 1/1000sec
 - Range of focus: 1m to Infinity
 - Self-timer: 5second / 10 second
 - PC-CAM frame rate: QVGA (320 x 240) 15 to 25 fps, VGA (640 x 480) 10 to 18 fps
 - TV output : NTSC or PAL, selectable
 - Digital Printing Format : DPOF
 - USB connectivity: version Full Speed 2.0(compatible with USB 1.1)

- Internal Storage: 32MB Internal Flash Memory
- Number of images stored in 32MB (typical):

Mode	Condition	Approx. capacity	
Digital Camera	3Mega Pixel : 2048 x 1536	Super Fine	43
		Fine	63
		Normal	100
	2Mega Pixel : 1600 x 1200	Super Fine	71
		Fine	104
		Normal	164
	0.3Mega Pixel(VGA) : 640 x 480	Super Fine	210
		Fine	420
		Normal	654
Digital Video (DV)	VGA(640x480)	~ 1min40sec	
	QVGA(320x240)	~3min	

NOTE:

- The above figures are only estimates. The actual numbers will vary depending on scene (image) complexity.
- Part of internal memory is reserved for system buffer, available memory left for image storage is less than 32MB.
- Compatibility with all SD/MMC memory cards is NOT guaranteed.

- Power: 3 AAA Alkaline Batteries
- Dimensions: 95 x 50 x 33 mm
- Weight: About 95g (without batteries)

System Requirements

The minimum system requirements for the digital camera are as the following:

System Requirement

OS Windows 98SE/Me/2000/XP

CPU Pentium MMX ‘ Celeron or AMD Athlon® or higher

RAM 128 MB

CD-ROM 4X or above

HDD Hard drive with 500MB free disk space





Color display: 16-bit

Sound Blaster or compatible sound card

USB port

Note: Please note that only the camera driver is compatible with Apple Mac computers. Photo processing software provided on the disc is not compatible with Apple Mac.

TABLE OF CONTENTS

TABLE OF CONTENTS.....	5
1. PACKAGE CONTENTS	6
2. IDENTIFYING THE PARTS.....	7
3. CONTROL BUTTON FUNCTIONS.....	8
4. PREPARATION	10
Loading the Battery into the Camera.....	10
Inserting and Removing an SD Card (Not Supplied).....	11
Inserting card:.....	11
Removing card:.....	11
Protecting Data on an SD Card	12
5. GETTING STARTED.....	13
Turning the Camera On	13
Turning the Camera Off.....	13
Checking Battery Power	13
6. MONITOR SCREEN CONTENTS	14
DIGITAL CAMERA  MODE	14
DIGITAL VIDEO  MODE.....	15
7. SETTING THE DEFAULT(Setup Mode)	16
MENU.....	16
SETUP MODE	16
8. TAKING PHOTOS (Camera mode).....	19
Menu Settings (Camera Mode ).....	19
Photo Quality (Camera Mode).....	20
Using the Flash (Camera Mode).....	20
Changing Zoom Level	20
Other Camera Settings	21
9. TAKING A MOVIE (DV mode)	24
Menu Settings (DV Mode).....	24
Changing resolution (DV Mode).....	24
Changing Zoom Level (DV Mode).....	25
Other Video Recording Settings.....	25
10. PLAYBACK (Playback mode).....	27
Playing Photos 	27
Playing back a Movie 	28
Viewing Pictures and Movies on a TV	29
Other Settings (Play back mode).....	29
11. DELETING FILES (Play back mode).....	30
12. INSTALLING SOFTWARE DRIVER.....	31
13. TRANSFERRING FILES	32
Connecting to PC.....	32
Copying files to PC.....	33
14. REMOVING THE CAMERA	35
15. USING AS PC CAMERA.....	37
Set the Camera to PC CAMERA mode	37
Recording Video Clips Directly To Your Computer.....	38
16. FREQUENTLY ASKED QUESTION (FAQs)	39

1. PACKAGE CONTENTS

- G-Shot3029TFT Digital Camera
- Installation CD (User's Manual, camera drivers)
- USB cable
- TV cable
- Hand Strap
- 3 AAA Alkaline batteries
- Pouch
- User's Manual
- Quick Start Guide
- Important Information Sheet

2. IDENTIFYING THE PARTS

Front View

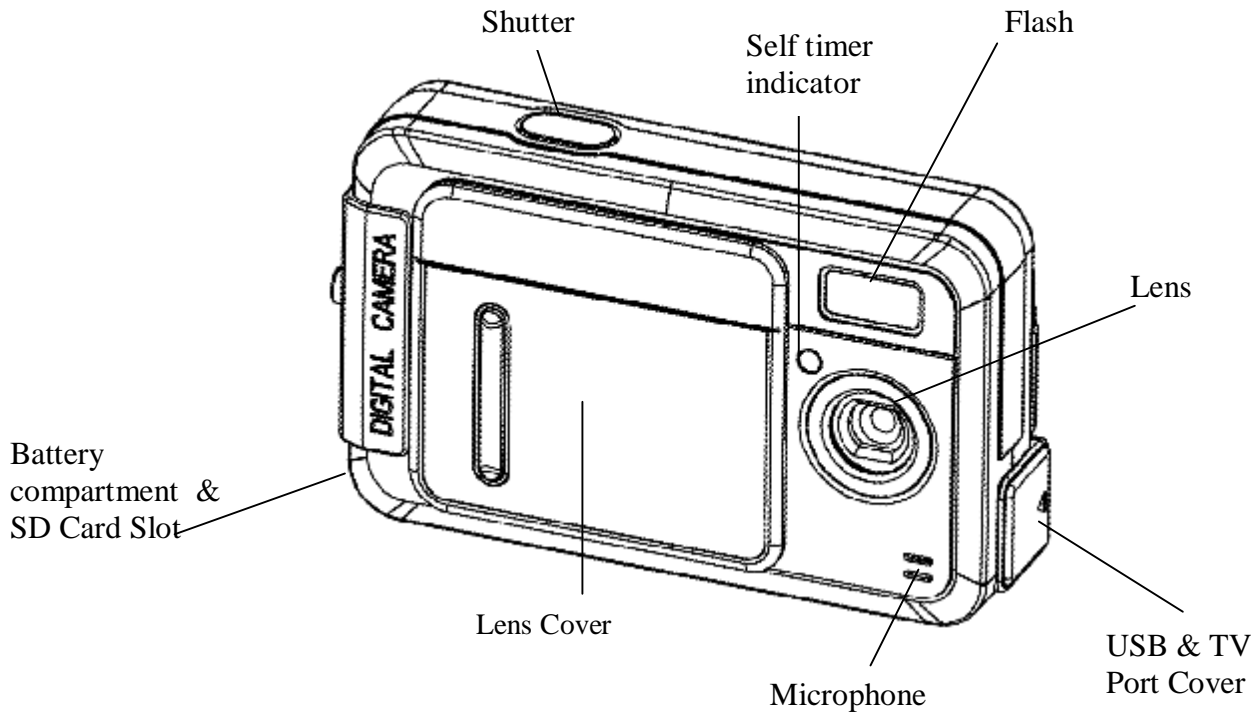



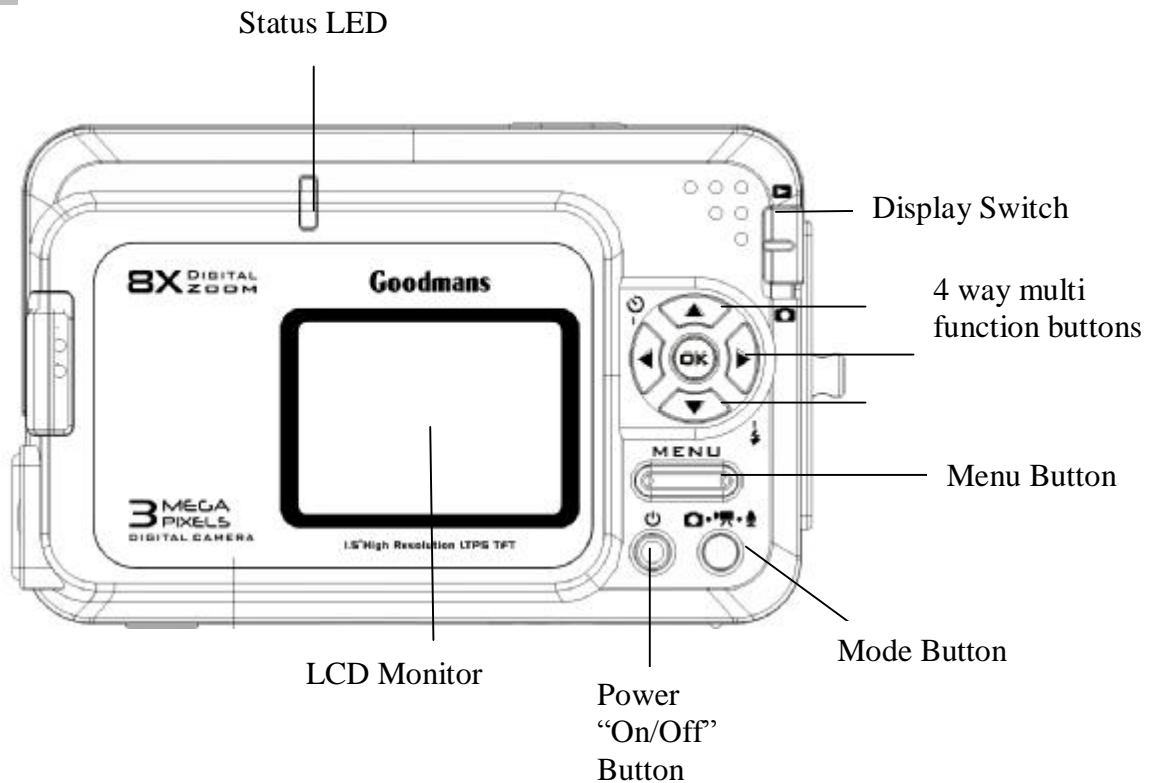





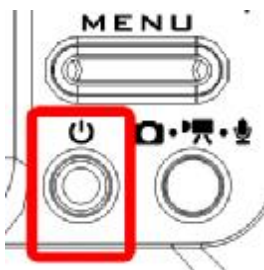
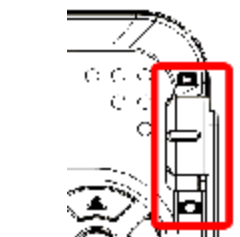

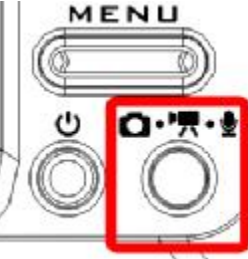

Rear View



3. CONTROL BUTTON FUNCTIONS

Functional Buttons

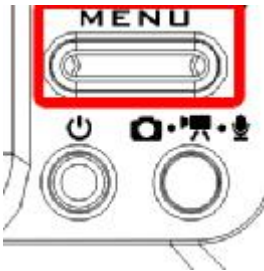
ITEM	FUNCTION								
 <p>[POWER ON/OFF]</p>	<ul style="list-style-type: none"> ▪ Power Button : Press the power button for one second to turn on / off the camera 								
 <p>[PREVIEW]</p>	<ul style="list-style-type: none"> ▪ PREVIEW Switch : Slide the Preview switch to get into  (Preview) Mode, then the last file, e.g. Photo / Movie, taken will be displayed 								
 <p>[MODE]</p>	<ul style="list-style-type: none"> ▪ Mode Button : While in Capture mode, press the MODE button to change 3 different operation modes: <table border="1" data-bbox="399 1176 1460 1366"> <thead> <tr> <th>MODE</th> <th>STATUS</th> </tr> </thead> <tbody> <tr> <td></td> <td>Photo Taking Mode</td> </tr> <tr> <td></td> <td>Movie Recording Mode</td> </tr> <tr> <td></td> <td>Playback Mode: [Movie/Photo]</td> </tr> </tbody> </table>	MODE	STATUS		Photo Taking Mode		Movie Recording Mode		Playback Mode: [Movie/Photo]
MODE	STATUS								
	Photo Taking Mode								
	Movie Recording Mode								
	Playback Mode: [Movie/Photo]								
 <p>[MENU]</p>	<ul style="list-style-type: none"> ▪ Menu button: Press MENU to display a menu for selected mode. 								

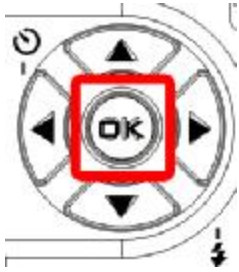

[OK / Flash]

BUTTON	[MOVIE MODE]	[PHOTO MODE]	[PLAYBACK MODE]
[OK]	<ul style="list-style-type: none"> ▪ Hide/Show screen icons or info 	<ul style="list-style-type: none"> ▪ Hide/Show screen icons or info ▪ Six-image display 	<ul style="list-style-type: none"> ▪ Hide/Show screen icons or info ▪ Enlarge the camera shots by pressing the up / down buttons on the large 4 way multifunction control

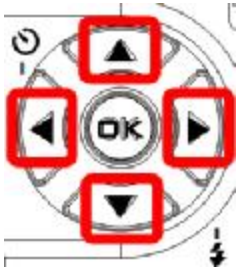

[DIRECTION KEY]

BUTTON	[MOVIE MODE]	[PHOTO MODE]	[PLAYBACK MODE]
▲	<ul style="list-style-type: none"> ▪ Zoom-In 	<ul style="list-style-type: none"> ▪ Zoom-In 	<ul style="list-style-type: none"> ▪ Zoom-In
▼	<ul style="list-style-type: none"> ▪ Zoom-Out 	<ul style="list-style-type: none"> ▪ Zoom-Out 	<ul style="list-style-type: none"> ▪ Zoom-Out
▶	- -	Toggle between Flash mode <ul style="list-style-type: none"> ▪ Off / Anti-Red Eye/ Auto / On 	<ul style="list-style-type: none"> ▪ Next
◀	- -	Self Timer Mode Press the ◀ button to (Timer-OFF)/ (5sec)/ (10sec)	<ul style="list-style-type: none"> ▪ Previous

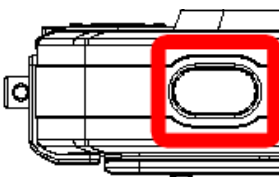

Function of [Shutter] in various modes:

MODE	FUNCTION OF [REC]
	Start taking photo
	Start taking movie /Stop taking movie
	Start playing movie/ Photo file Stop playing movie/ Photo file

4. PREPARATION

Loading the Battery into the Camera

Please load 3 AAA batteries into the battery compartment according to following steps:

- (1) Slide the battery cover in the direction indicated by the arrow:
- (2) Insert the batteries as indicated on the inner side of the cover.
- (3) Note correct polarity as shown below diagram.
- (4) Close and lock the battery cover.

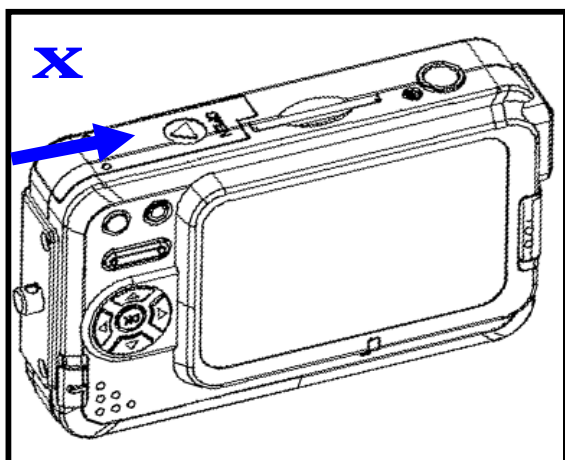
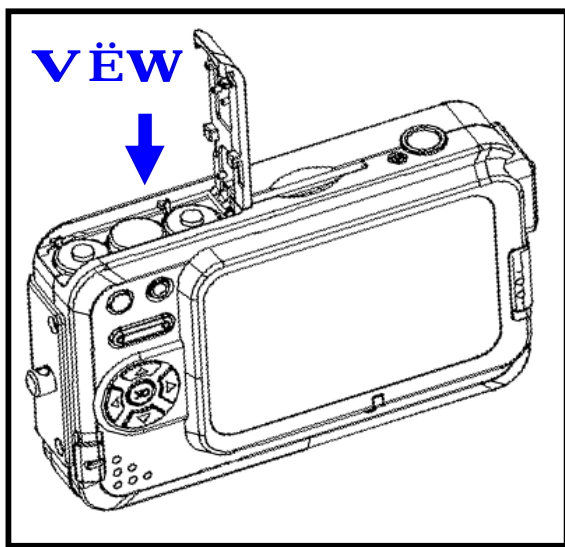
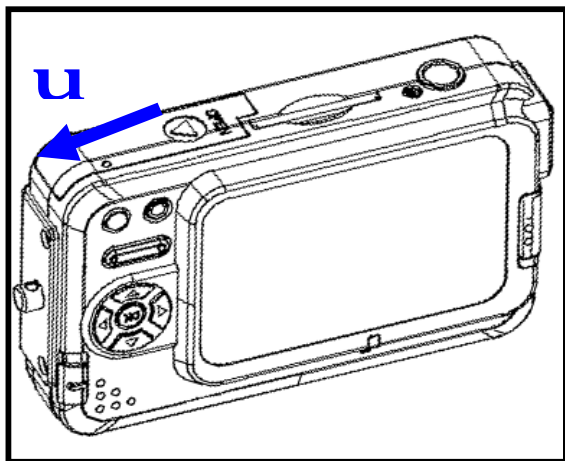

Note:

- u Exercise caution when opening the battery cover to avoid damaging the battery compartment cover and hinges.
- u If you remove the battery from the camera, you will need to set the date and time again the next time you reinsert the battery and use the camera.

Inserting and Removing an SD Card (Not Supplied)

The camera comes with 32 MB pre-build memory which allows you to store pictures & videos. You can expand the memory capacity by using an optional SD or MMC memory card up to 512MB.

To insert a memory card, refer to the figures shown below:

Inserting card:

- Make sure to turn off the camera.
- Insert the memory card correctly and push it into the card slot as far as it will go. It will click into place.

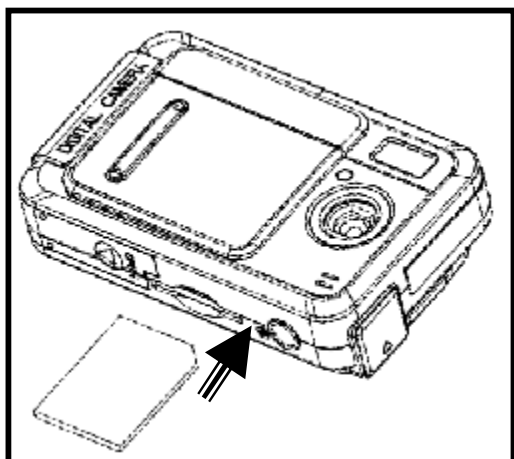

Note the orientation of the card. If it is inserted incorrectly, it may become jammed

Removing card:

- To remove the SD/MMC card, gently push the card. After the card pops up, pull the card out of the slot.
- Pull the memory card out with your fingers in the opposite direction.

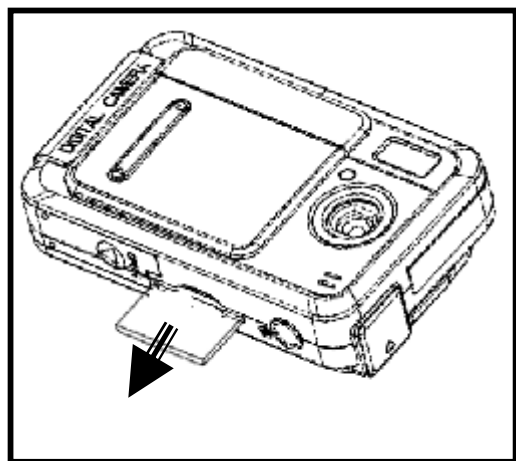



Note:

- 1 Do not remove the SD/MMC card while the camera is processing data (when the LED is flashing). When a memory card is fitted, movies and pictures are saved on card rather than on the built-in memory. And, the SD card icon  will be shown on LDC display.
- 1 It may be necessary to format the SD card the first time it is used; especially if the card has been used in devices other than your camera. To format, see **[Format]** in SETUP MODE (see page 17).
- 1 If the Built-in memory/ SD card is full, the LCD display will show "MEMORY FULL" flashing in red color. If the SD card is write-protected, the SD card icon will change in red color.

Protecting Data on an SD Card

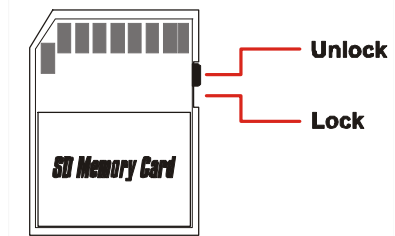
The SD card comes with a write-protect switch. When the write-protect switch is set to the Lock position, no further shots can be recorded. To ensure that the camera can operate normally, you should set the write-protect switch to the Unlock position before inserting the SD card.



If you insert a write-protected card, the media icon  on the LCD display will become red.

- Listed below is the approximate number of images that can be stored cards in 32MB built-in memory. Actual capacity may vary (up to + 5%) depending on the environment and color condition.

Mode	Condition	Approx. capacity	
Camera	3Mega Pixel : 2048 x 1536	Super Fine	43
		Fine	63
		Normal	100
	2Mega Pixel : 1600 x 1200	Super Fine	71
		Fine	104
		Normal	164
	0.3Mega Pixel(VGA) : 640 x 480	Super Fine	210
		Fine	420
		Normal	654
Digital Video (DV)	VGA(640x480)	~ 1min40sec	
	QVGA(320x240)	~3min	

5. GETTING STARTED

Turning the Camera On

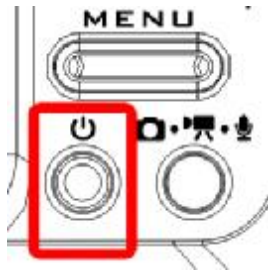

● Press and hold down the **[Power]** button for 1 ~ 2 seconds to turn on the camera. When you turn on the camera, you will hear a confirmation-BEEP, the Red LED will illuminate. When the Red LED stops blinking, the camera is ready.

Turning the Camera Off

● Press and hold down the **[Power]** button for another 1 ~ 2 seconds to turn off the camera.

Checking Battery Power

When the camera is on, you will see the battery power indicator on the bottom left corner of the LCD monitor screen. It shows you the battery power level.

Battery Power Indicators

- | | |
|--|--|
| | Full battery charge. |
| | Two-thirds of the battery power is left. |
| | One-third of the battery power is left. |
| | Battery power is almost out. |
| | This flashing indicator means that battery power is out and the battery needs to be recharged. |



6. MONITOR SCREEN CONTENTS

DIGITAL CAMERA MODE

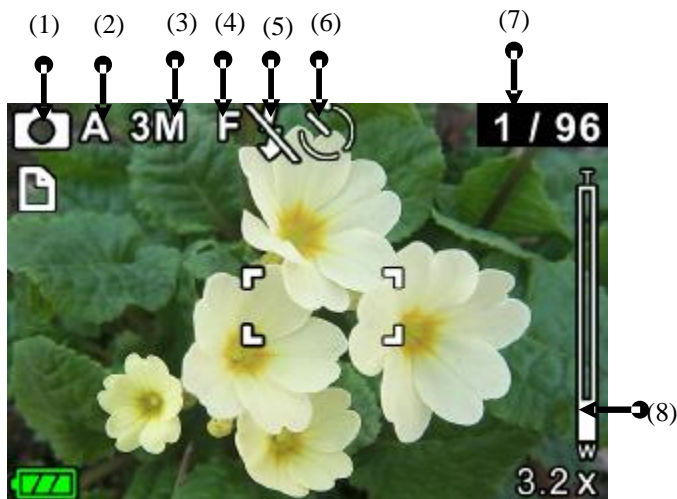



The monitor screen uses various indicators and icons to keep you informed of the status of under camera mode.



(1) MODE Status Indicator

-  Photo Taking Mode
-  Movie Recording Mode
-  Playback Mode → [Photo/Movie/Voice]

(2) White Balance Indicator

-  Auto /  Sunny /  Cloudy/
-  Fluorescent/  Light bulb

(3) Photo Resolution

- **3M**: 2048 x 1536 pixels
- **2M**: 1600 x 1200 pixels
- **VGA** : 640 x 480 pixels

(Hints: You can press [←] left arrow button on the 4 Way multi function switch to quickly change the resolution-modes for quick access!)

(4) Photo Quality

- **SF** : SUPER FINE
- **F** : FINE
- **N** : NORMAL



(Hints: You can press [→] Right arrow button on the 4 way multi function switch to quickly access the quality setting for quick access!.)

(5) Flash Mode

-  Auto/  Fill-in/  Off

(Hints: You can press [OK] button to toggle around flash modes for quick access!)

(6) Self Timer

-  Off (Timer-OFF) /  5s (5sec) /  10s (10sec)

(7) Photo Counter

- No. of Pictures / Remaining Shots

(8) Digital Zoom Level



- Digital zoom ratio meter: 1x to 8x

DIGITAL VIDEO MODE

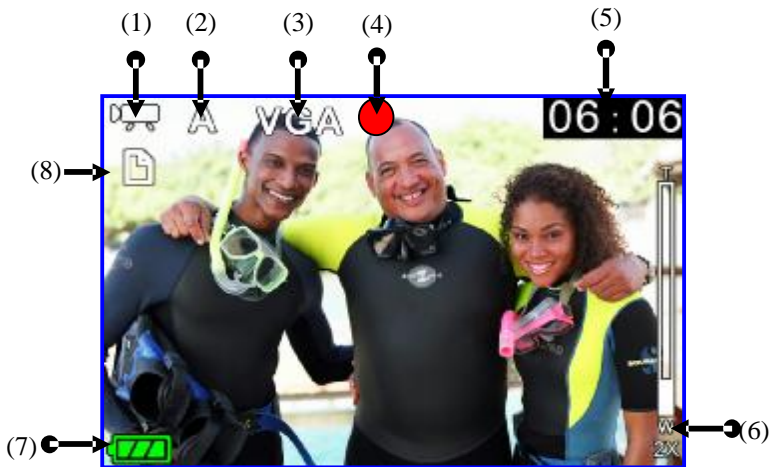

The monitor screen uses various indicators and icons to keep you informed of the status of under video mode.





(1) MODE Status Indicator

-  Movie Recording Mode
-  Photo Taking Mode
-  Playback Mode → [Movie/Photo/Voice]

(2) White Balance Indicator

-  Auto /  Sunny /  Cloudy/
-  Fluorescent/  Light bulb

(3) Movie Quality

-  640 x 480Pixels
 -  320 x 240Pixels
- (Hints: You can press [t] key to toggle around above quality setting for quick access!.)

(4) Recording Status Indicator

-  Movie Recording in progress
- (No icon) : Movie Recording Standby

(5) Recording time

- Elapsed time (hh:mm:ss) : While movie recording
-  in progress
- Remaining recording time (hh:mm:ss) : While in standby status

(6) Digital Zoom Level



- Digital zoom ratio meter: 1x to 8x

(8) Battery Level Indicator

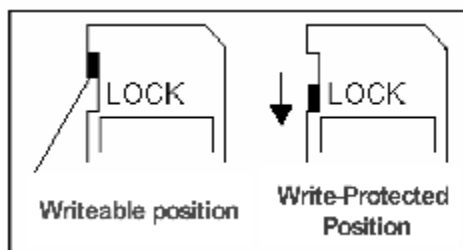
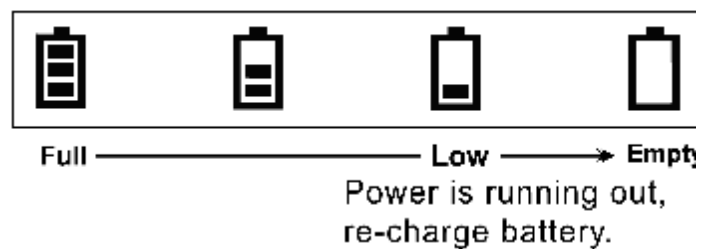
As the battery is depleted, the indication changes as follows.



(8) Storage Media Type

-  : memory card (SD/MMC) is using
-  (icon turns red): memory card is write protected.

7. SETTING THE DEFAULT(Setup Mode)

MENU

Different menus are available for Movie, Photo, Playback, and Voice recording mode.

To access the menu:

1. Press the MENU button to open the main menu under different mode.
The selected mode menu is displayed on the LCD screen.



MENU in Movie Mode



MENU in Playback Mode



MENU in Photo Mode

2. Use the **3 / 4** button on the 4 Way multi function switch to navigate through function items.
3. Use the [OK] button to enter to specific function item.
(The selected function/option is highlighted with color.)
4. Press [OK] to confirm the selection,
Or, press the MENU button twice to exit the mode menu.

SETUP MODE



















You can customize the camera settings for your own use, as well as for shooting-related functions. Press the [MENU] button to display a menu for the selected mode. (The Setup menu is displayed in all modes.)

1. Power on the camera.
2. Press [MENU] button, and use the **3 / 4** button to navigate to *Setup*  icon.

3. Use the [OK] button to enter to *Setup Mode*.
4. Use 4-way arrow button to navigate through the available function
(The selected function/option is highlighted with colour.)



In the below table, default setting is indication with an asterisk [**P**]

 <p>[Auto Off]</p>	 1min /  3min /  Never Sleep P <p><u>Functions:</u> - This item determines the auto-off time when the camera stay idle</p>
 <p>[Beep]</p>	 1min /  3min P <p><u>Functions:</u> - This item allows you to toggle the beep sound on or off</p>
 <p>[Brightness]</p>	<p>LCD Brightness Range : -2.0 (darker) to +2.0EV(brighter) PDefault setting : 0</p> <p><u>Functions:</u> - This item allows you to adjust the brightness level of LCD monitor</p>
 <p>[TV System]</p>	<p>You can view stored movies and pictures on a Television with 2 main TV systems</p>  TV (PAL) /  TV (NTSC) P <p><u>Note: Setting TV System</u> - TV(PAL) for PAL standard: UK, Europe, China, Australia, Singapore & Hong Kong etc. - TV(NTSC) for NTSC standard : USA, Canada, Japan, South Korea and Taiwan etc.</p>
 <p>[Format]</p>	<p>This item allows you to format the store media that is currently in use.</p> <p><u>Functions:</u> - You can use this function to prepare the SD card to record media, BUT all files stored in media will be gone after executing this function!</p>
 <p>[Date/Time Setting]</p>	<p>This item is for date & time setting.</p> <ul style="list-style-type: none"> 1 Move between Date, Time and Exit by using Left/Right buttons. 1 Adjust date and time by using Up/Down buttons, then select OK to validate each change. 1 Select MENU to leave Time Setting without any change. <p><u>Note:</u> - If you remove the battery from the camera, you will need to set the date and time again the next time you reinsert the battery and use the camera.</p>
 <p>[Beep]</p>	 1min /  3min P <p>In case the camera's frequency setting does not match electricity frequency under the fluorescent light, flickering may be seen. To avoid flickering, - Select 50Hz for European frequency , Or 60Hz for US / Taiwan frequency</p>
 <p>[Default Setup]</p>	<p>Use this function to return the camera settings to default values except for date & time</p>
 <p>[Version]</p>	<p>This function shows the camera's software version (this info is used by service centre)</p>





TAKING PHOTOS



8. TAKING PHOTOS (Camera mode)

TO TAKE PHOTO:

1. Slide the Preview switch to [] Camera mode.
2. Press [MODE] button repeatedly to get into “Camera” Mode [].
3. To start shooting photo, press [Shutter] once.

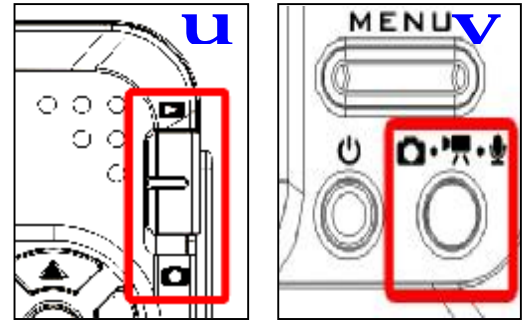

Note:

1. Before photo is taken, you can see number of [total no. of photos have been taken] / [remaining shots] on top right corner of LCD. The remaining shot is an approximation based on the unused memory

Menu Settings (Camera Mode

When in Camera [] mode, you can use the default settings that have already been chosen for photo taking. If you want to change the settings to suit your needs, press the Menu button. Then use the 4-way arrow keys to go through each setting and make adjustments.

Your camera offers 3 choices in resolution:

- **3M**: 2048 x 1536 pixels
- **2M**: 1600 x 1200 pixels
- **VGA** : 640 x 480 pixels

J TIPS - Choice of Resolution

- While in Camera mode, you can press [▲] key to toggle the resolution without entering the options menu.
- u [3M] allows a photo to be taken as sharp as possible, which is suitable for 7"x5" Photo printout; too large for email.
- u [2M] is suitable for 6"x4" Photo printout; acceptable for email.
- u [VGA] is good for sharing with email, but it's too small for photo printout

Photo Quality (Camera Mode)

- **SF**: SUPER FINE
- **F** : FINE
- **N** : NORMAL





J TIPS – Photo Resolution Vs Photo Quality:

u In general, photos taken at higher resolution and quality contain more details and look sharper, but they also take up more memory space as well as longer processing time for taking next photos. To maximize the number of photos to be stored, you can choose a lower quality setting. To maximize the photo quality, choose a higher setting

Using the Flash (Camera Mode)

In camera mode, press [**u**] button to toggle Flash mode.

In camera mode, press [**O.K**] button to toggle Flash mode.

-  Red-Eye
-  : Auto Flash
-  : Flash (FORCED)
-  : No Flash

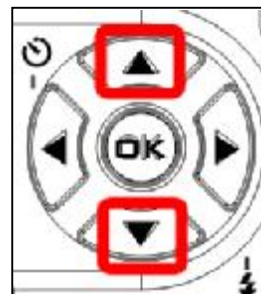
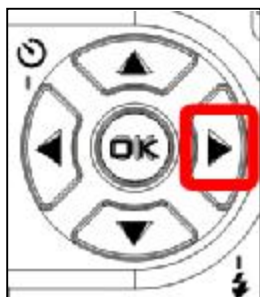

















Changing Zoom Level









While recording, you can press the [**p**] or [**q**] button to zoom in/out the screen.

The digital zoom can be set from 1x to 8x and the magnification ratio is shown on the LCD monitor.

Other Camera Settings

In the below table, default setting is indication with an asterisk [**P**]

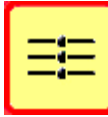
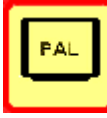
 [Flash Option]	<p>P  No Flash /  Anti-Red-Eye /  Auto /  Always ON</p> <p><u>Hints:</u> - You can press [U] key to toggle around above settings.</p>
 [Photo Quality]	<p>SF - Super Fine / P F - FINE / N - Normal</p>
 [Resolution]	<p>P 3M - 2048 x 1536pixels / 2M - 1600 x 1200pixels / VGA - 640 x 480pixels</p> <p><u>Hints:</u> - You can press [t] key to toggle around above resolution setting.</p>
 [White Balance]	<p>P A Auto /  Sunny /  Cloudy /  Fluorescent /  Light bulb</p> <p><u>Hints:</u> - Adjust the WB according to the light conditions for the recording</p>
 [EV Adjust]	<p>Exposure Compensation Range : -2.0EV(underexposure) to +2.0EV(overexposure)</p> <p>PDefault setting : 0</p> <p><u>Hints:</u> - Adjust the exposure compensation setting to obtain the optimum image brightness (Exposure) when the subject is much brighter or darker than the background</p>
 [Self Timer]	<p>P  - Timer OFF /  - Set the self-timer to be 5 Seconds</p> <p>/  - Set the self-timer to be 10 Seconds</p> <p><u>Hints:</u> - You can press [t] key as a quick access to activate self-timer.</p> <p><u>Note:</u> - Self-timer Mode is automatically off switched after a photo is captured, or if the camera is turned off.</p>



 <p>[Date Stamp]</p>	 - Date-Stamp Disabled /  - Date-Stamp Enabled <p><u>Note:</u> - Use this function to mark the date stamp on the captured photos. Once this function is enabled, the date-time setting will be activated and confirmation on current date & time will need to be inputted.</p>
 <p>[SETUP MODE]</p>	<p>To adjust basic setting, eg.</p> <p>Sleep mode  / Beep  / LCD brightness  /</p> <p>TV System  / Format  / Date-Time Setting  ...etc</p> <p><u>Hints:</u> For details on how to use Setup mode, see “SETUP MODE” on page 18</p>

TAKING A MOVIE

9. TAKING A MOVIE (DV mode)

This mode allows you to take motion video with sound in the Movie Mode. The length of recorded movie clip is unlimited (maximum length depends on memory size of SD/MMC card)

TO TAKE MOVIE:

1. Slide the Preview switch to [] Camera mode.
2. Press [MODE] button repeatedly to get into DV "Movie-Taking" Mode [].
3. To start recording, press [Shutter] once. Movie recording begins, with the elapsed recording time shown on the LCD.
4. To stop recording, press [Shutter] again. The movie is recorded. The camera is ready to shoot another movie

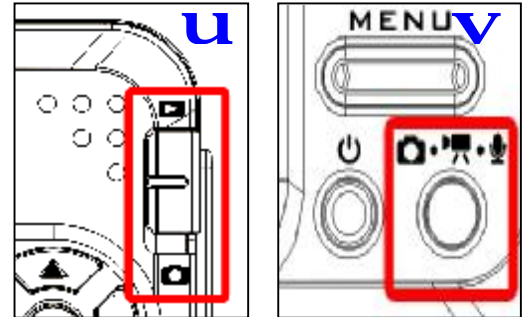

Note:

- ⌚ Before movie is taken, you can see the remaining time allowing you to take next movie on top right corner of LCD. The remaining time is an approximation based on the unused memory

Menu Settings (DV Mode)

When in DV [] mode, you can use the default settings that have already been chosen for video recording. If you want to change the recording settings to suit your needs, press the Menu button. Then use the 4-way arrow keys to go through each setting and make adjustments.

The following sections describe about the video recording settings.

Changing resolution (DV Mode)

Your camera offers 2 choices in resolution: "VGA" or "QVGA".

⌚ "VGA" (640 x 480 pixels) allows a movie to be taken as sharp as possible, which is best suitable for TV viewing, but requires more memory to store.

∅∅ *Select VGA if you want to produce the best result for viewing*

⌚ "QVGA" (320 x 240 pixels) allows for longer recording time to be stored on the camera, but the quality of image will deteriorate when shown on a TV.

∅∅ *Select QVGA if saving memory is top priority*

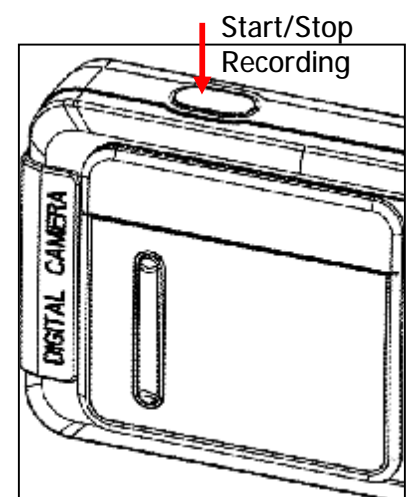





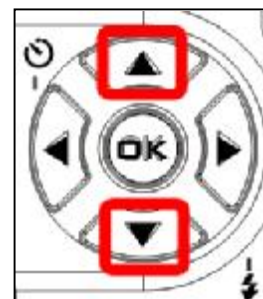











Changing Zoom Level (DV Mode)

While recording, you can press the [P] or [Q] button to zoom in/out the screen. The digital zoom can be set from 1x to 8x and the magnification ratio is shown on the LCD monitor.



Other Video Recording Settings

In the below table, default setting is indication with an asterisk [P]

 VGA [Movie Quality]	P  640 x 480Pixels /  320 x 240Pixels
 AWB [White Balance]	P  Auto /  Sunny /  Cloudy /  Fluorescent /  Light bulb <i>Hints:</i> - Adjust the WB according to the light conditions for the recording
 [EV Adjust]	Exposure Compensation Range : -2.0EV(underexposure) to +2.0EV(overexposure) P Default setting : 0 <i>Hints:</i> - Adjust the exposure compensation setting to obtain the optimum image brightness (Exposure) when the subject is much brighter or darker than the background
 [SETUP MODE]	To adjust basic setting, eg. Sleep mode  / Beep  / LCD brightness  / TV System  / Format  / Date-Time setting  ...etc <i>Hints:</i> For details on how to use Setup mode, see "SETUP MODE" on page 18



PLAY BACK MODE



10. PLAYBACK (Playback mode)

Playing Photos

1. Turn on the camera, and Slide the Preview switch to  (Preview) Mode, then the last file, e.g. Photo / Movie, taken will be displayed
2. Press **[OK]** display key twice to display 6-images [thumbnail display]
3. Use the 4-way keys select the photo you want to view. The selected file is border by a red frame
4. Press the **[OK]** button again to view [single display] on the selected photo file.

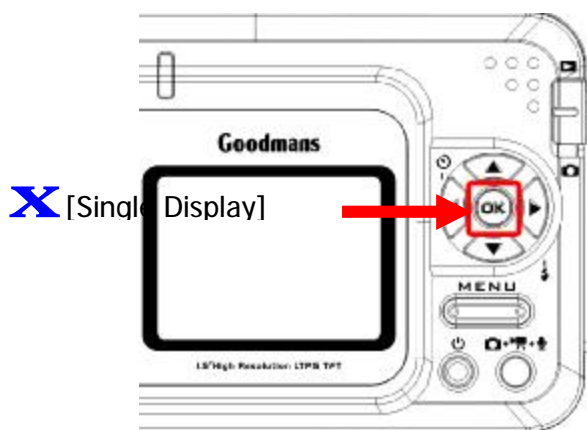
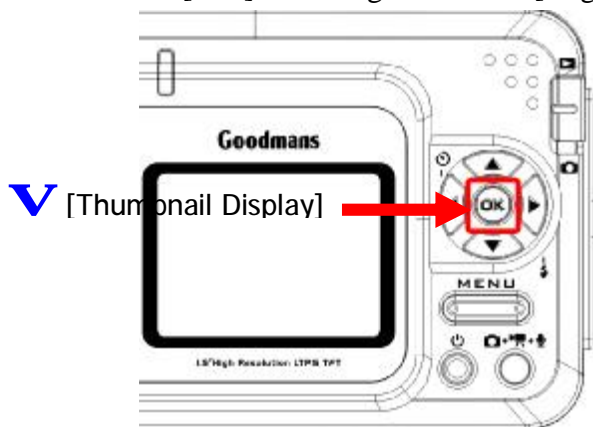
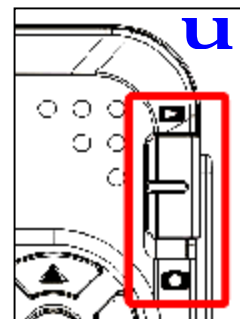

Playing back a Movie

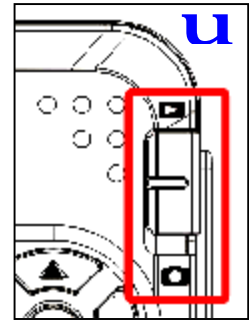

1. Turn on the camera, and Slide the Preview switch to  (Preview) Mode, then the last file, e.g. Photo / Movie, taken will be displayed
2. Press **[OK]** display key twice to display 6-images [thumbnail display]
3. Use the 4-way keys select the movie file you want to view. The selected file is border by a red frame
4. Press the **[OK]** button once to view [single display] on the selected movie file.
5. Press the **[Shutter]** once to play the movie, press shutter again to pause the movie playback

J TIPS – Hide On-Screen Info:

[O.K] button allows to hide / show on-screen info of the file.

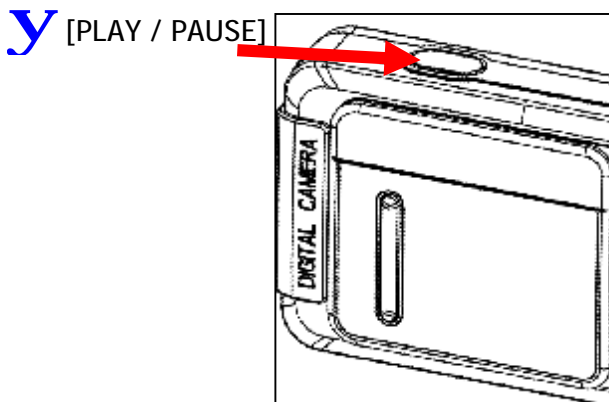
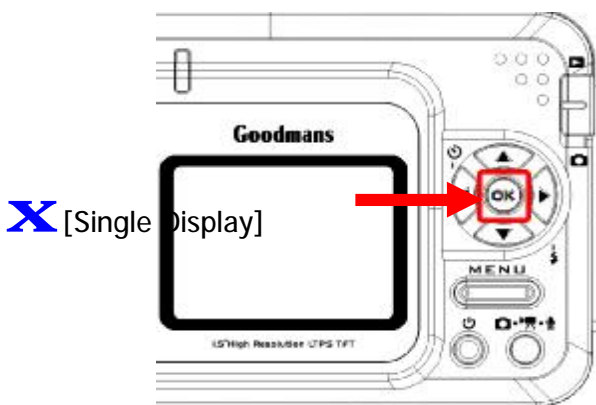
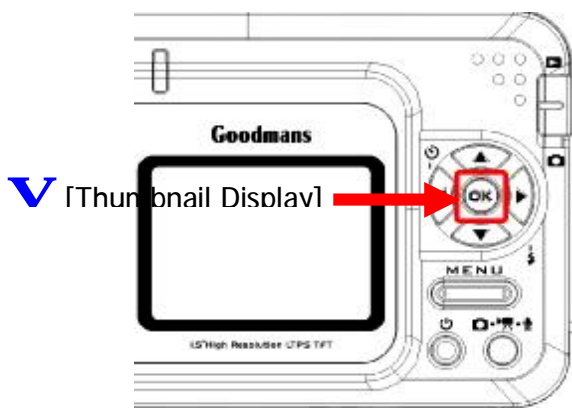

Viewing Pictures and Movies on a TV

Connect your camera and TV via an AV cable for real-time display. You can export your video clips, still pictures directly to your TV to share them with friends and family.

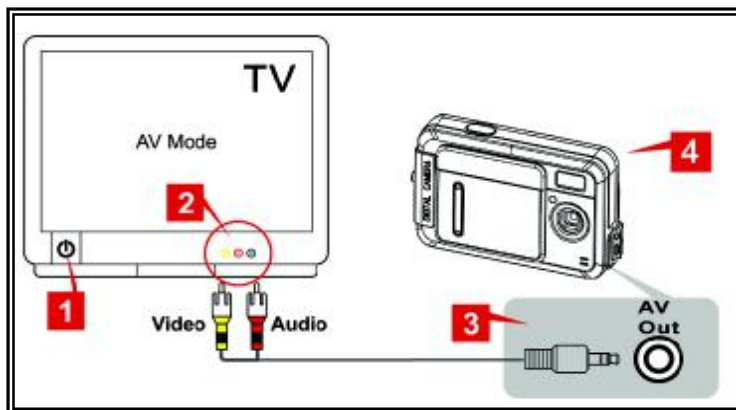

1. Turn on your TV and select the appropriate Video Input channel to which the camera is connected.
2. Connect the audio and video ends of the AV cable to your TV.
3. Connect the other end to your camera (AV Out port).
4. Turn on the camera, and Slide the Preview switch to [▶] (Preview) Mode, then the last file, e.g. Photo / Movie, taken will be displayed



Notes:

- 1 The camera LCD monitor will be turned off when TV mode is being activated
- 1 The default setting of TV system is in PAL mode for most European countries. If your TV is using NTSC instead of PAL, you need to change TV system setting to NTSC; otherwise the output images will not be displayed properly. (See "Setup Mode – TV System" page 18)

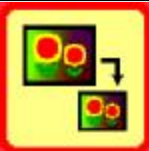
Other Settings (Play back mode)

 <p>[Resize]</p>	<p><u>Resizes:</u></p> <ul style="list-style-type: none"> - This function allows you to resize photo size (note: resize photo from low resolution to higher resolution will degrade the photo quality)
 <p>[PictBridge]</p>	<p><u>Pictbridge: Direct Print Using PictBridge</u></p> <ul style="list-style-type: none"> - This function allows your camera to control the printer to print a single picture or all pictures stored in the storage media. By connecting the camera to a PictBridge-Compatible printer, you can print images directly from the camera without using a PC. Connect the camera to the printer and select the images you want to print and the number of copies.
 <p>[DPOF]</p>	<p><u>DPOF: Direct Print Out Format</u></p> <ul style="list-style-type: none"> - This function allows you to print on a DPOF-compatible printer or at a professional print service from the memory card in accordance with the file name recorded on the card

Notes – DPOF :

- 1 DPOF print settings can be configured for images only, not for video clips.
- 1 DPOF print settings can be configured for images on memory card only (NOT for internal memory).

After DPOF settings have been configured, a folder titled "MISC", which holds DPOF settings information, will be created on the root level of the storage devices. In case you need to copy images between storage devices, **DO REMEMBER TO COPY THE "MISC" FOLDER AS WELL**, should you want to keep the DPOF settings information.

11. DELETING FILES (Play back mode)

TO DELETE FILES:

1. Turn on the camera, and Slide the Preview switch to [▶] (Preview) Mode, then the last file, e.g. Photo / Movie, taken will be displayed
2. Use the Left/Right arrow buttons select the movie file you want to view. The file is highlighted by a red frame
3. Press the [MENU] button followed by the OK button to enter the DELETE mode.
4. Use the left / right arrow buttons to select delete one or all shots.
5. Press [OK] button to delete the shot or all shots. The camera display will now show [No/Yes]. Highlight [Yes] (to delete the shot) and then press the [OK] button. Press the [MENU] button to return the camera to its normal operation.

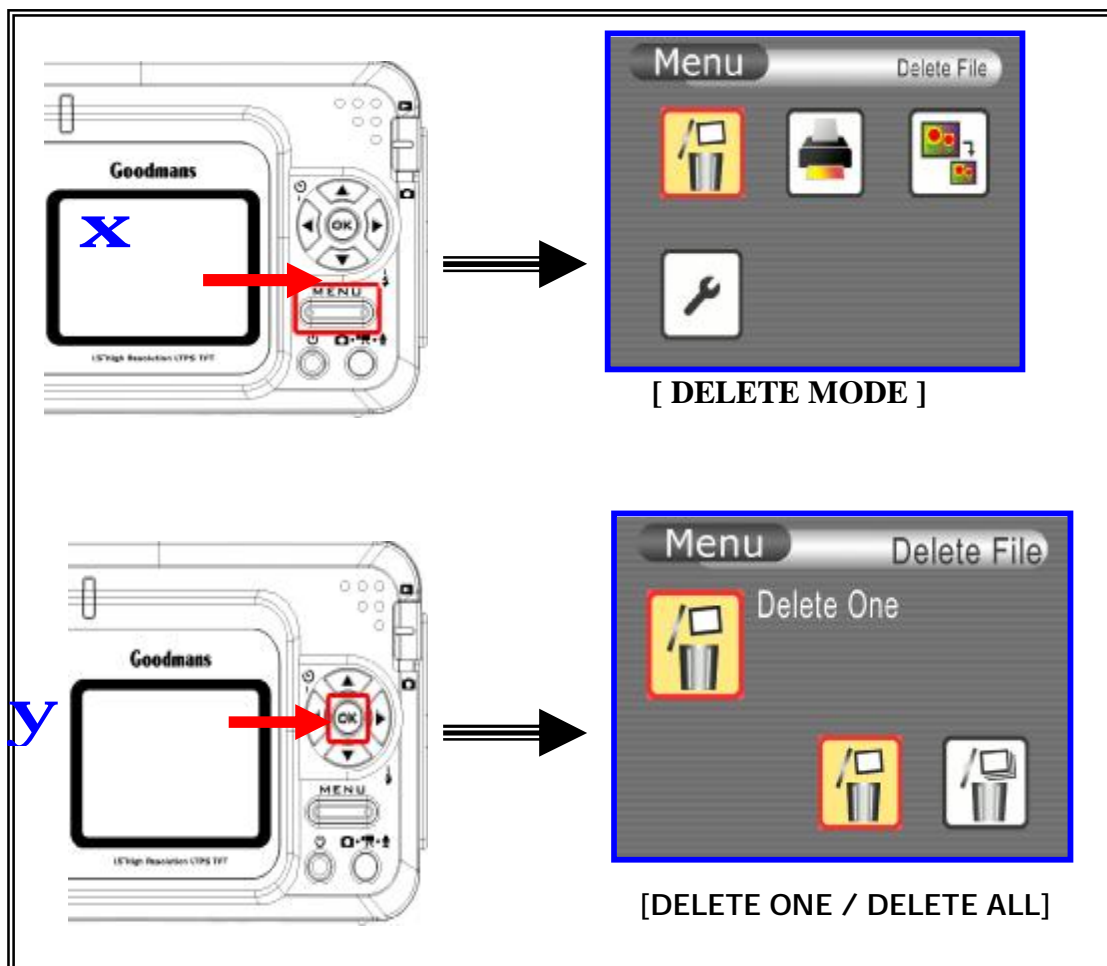
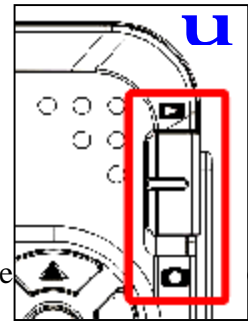

12. INSTALLING SOFTWARE DRIVER

Before connecting this camera to a computer for the first time, you should install a driver on the computer. The driver is on the CD-ROM disc provided in the package. To install the driver:

1. Insert installer CD into the CD-ROM drive
2. Close the CD-ROM drive. An installer wizard will automatically launch.

If the installer wizard does not appear, then

3. You can click **Start** in the Windows Taskbar. Then, select **Run** to continue
4. Click **Browse** to search the file path, and select “autorun.exe” in your CD-ROM drive
5. Click **Open**, and then click **OK**.

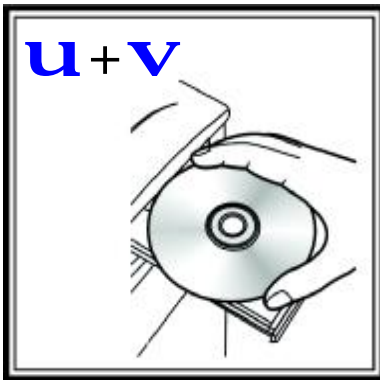

- u Click “**Install Camera Driver**” and follow the on-screen instructions to complete driver installation



Note:

Application software for playing AVI, e.g. Windows Media Player, Quick Time, is NOT included in this camera package. You have to make sure that application program, exists on your computer system.

13. TRANSFERRING FILES

Connecting to PC

1. *Firstly turn on the camera* [the red LED will illuminate], then slide the Preview switch to [▶] (Preview) Mode.
2. Connect the computer and camera with the supplied USB cable.
3. Connect the other end of the USB cable to your camera.

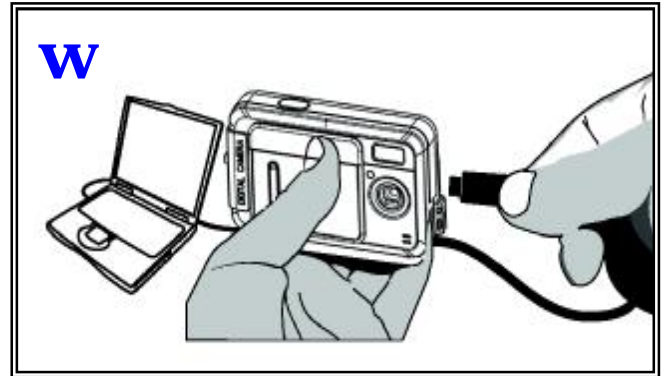
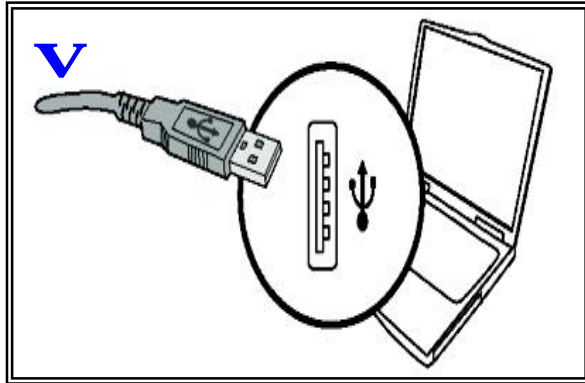
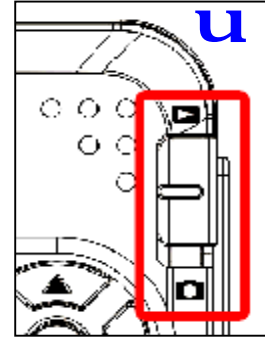

Note:

While the camera is being connected to the computer, the RED LED will illuminate and LCD monitor will be turned off.

Copying files to PC

By copying files from the camera to your computer, you can permanently save your creative works in the hard disk.

To do this:

(This step varies according to your operating system)

U For Windows XP users:

After the camera is connected to your computer, a dialogue window will appear automatically. Please select the item *Open folder to view files using Windows Explorer* and click **OK**.



U For Windows 2000/ME/98SE users:

- 1 Double-click on My Computer.
- 1 Then double-click on the icon of the removable disk that has just appeared

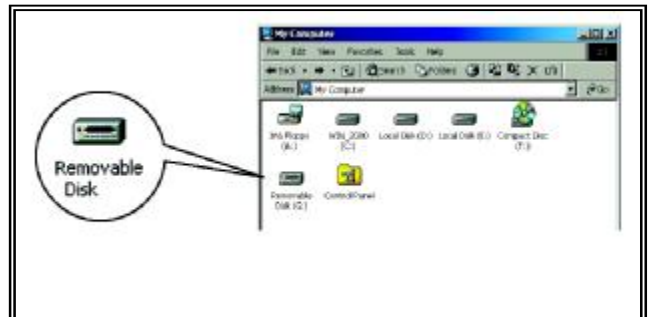
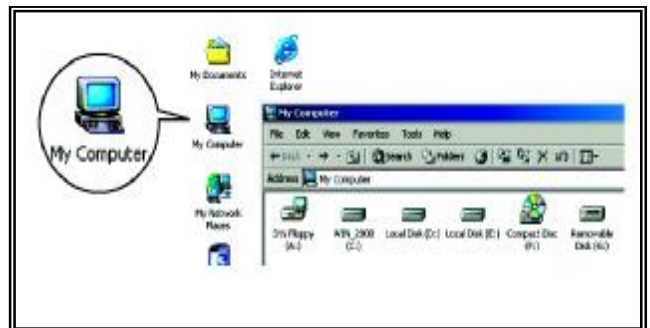

V Double-click on **DCIM** folder.

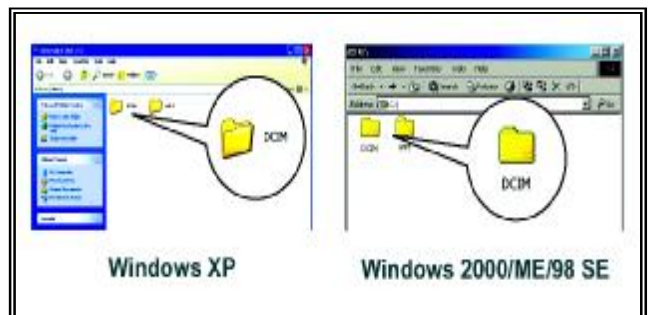

W Double-click on the **100COACH** folder.

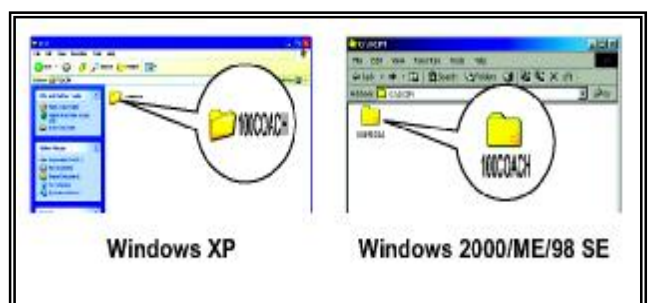

X Drag the pictures to your desired target folder.

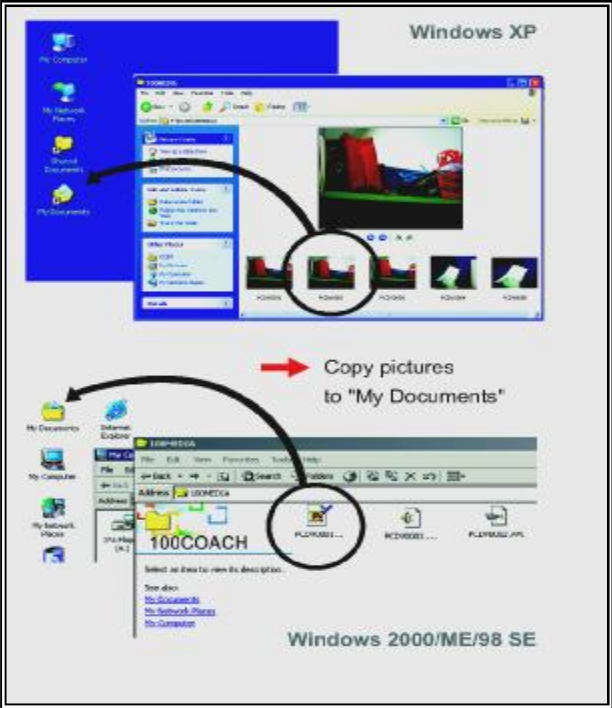

Note:
Ø Please do not copy any files into the "DCIM" folder or "100COACH" folder of your camera. Otherwise it may cause the camera unstable or crash.

14. REMOVING THE CAMERA

Use the procedure below when disconnecting the USB cable from a Windows PC

u Windows Me Users

1 Double-click the [Unplug or Eject Hardware] icon in the task bar in the lower-right corner of the desktop.



2 Select [USB Disk] and then click [Stop].



3 Select [USB Disk] and then click [OK].

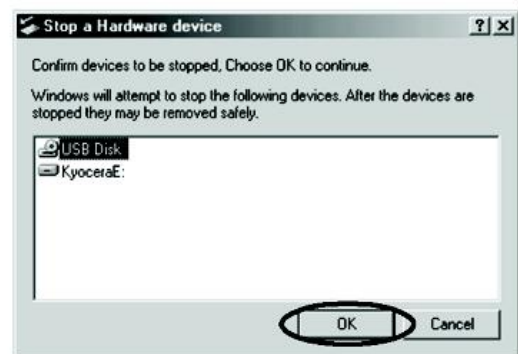

4 When the “The ‘USB Disk E:’ device can now be safely removed from the system” message appears, click [OK].



5 Disconnect the USB cable from PC and camera.

u Windows 2000 or Window XP Users

1 Double-click the [Unplug or Eject Hardware] icon in the task bar in the lower-right corner of the desktop.



2 Select [USB Mass Storage Device] and then click [Stop].

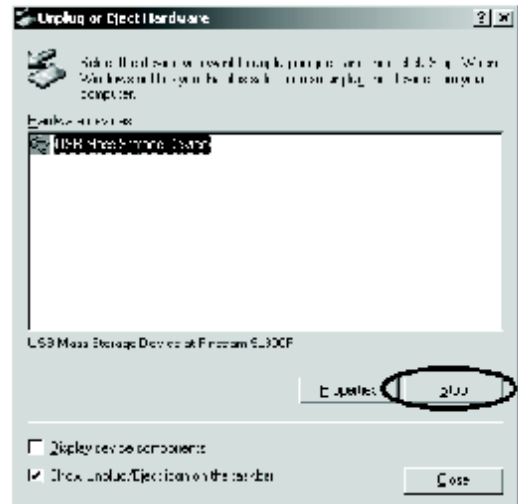

3 Select [ZORAN COACH6 (I62) USB Device] and then click [OK].

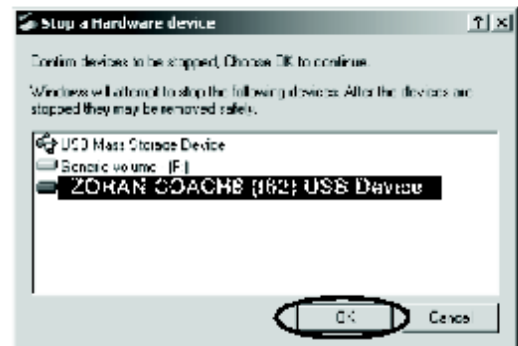

4 When the “The ‘USB Mass Storage Device’ can now be safely removed from the system” message appears, click [OK].



5 Disconnect the USB cable from PC and camera.

u Windows 98 or Windows 98SE Users

In My computer, Right click on the removable disk corresponding to the camera. Select Eject from the menu.



15. USING AS PC CAMERA

Set the Camera to PC CAMERA mode

1. Turn on your camera, and slide the Preview switch to [▶] (Preview) Mode.
2. Connect the camera to a computer with a USB cable.
3. Set up an account with Windows NetMeeting (or other similar programs)
4. Turn on the camera and computer. Start Windows Netmeeting (or other similar programs)
5. Click **Tools > Options** from the pull-down menu
6. Click **Video** tab, select **Coach Video Camera** from the **Video Camera Properties** drop-down box and click **OK** button
7. Click **Start Video** icon [▶/||] and you should see a live image.
8. Click **Stop Video** icon (same as the **Start Video** icon [▶/||]) to end.

NOTE: The graphics shown are based on the user interface in Windows 98SE

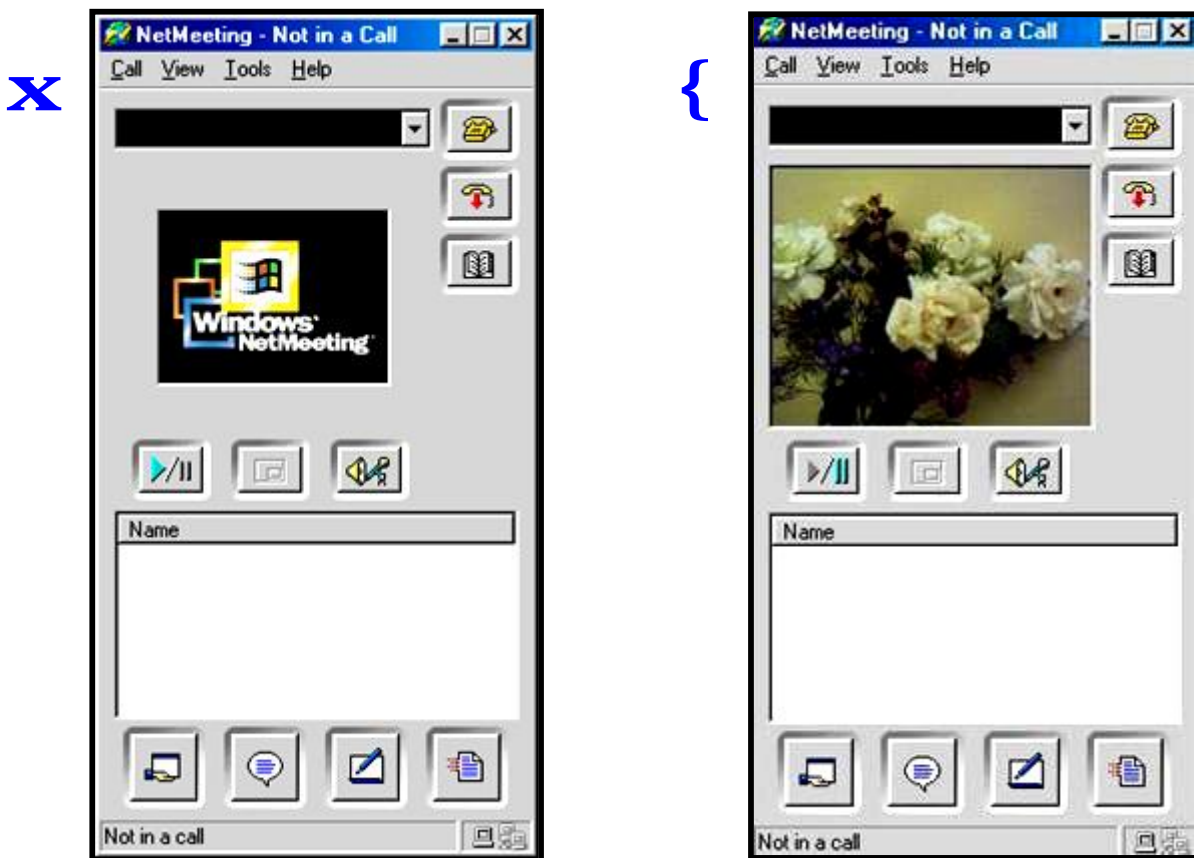

TIPS

- The video clips recorded are saved in **AVI** format (.AVI). in resolution of 320x240pixel at 11~15fps.
- If you want to know more about **Netmeeting**, please consult its on-line help by clicking the "**Help**" icon on the pull-down menu. Then click on the **Help Topics** icon.

Recording Video Clips Directly To Your Computer

Besides taking video clips on your digital camera, you can also record them directly to your computer with the **AMCAP** program. This program exists on the root directory of installation CD. Browse the installation CD, you will see **Amcap.exe** file. Drag this file to your desktop if necessary, you will see the **Amcap** icon on your desktop. To recording video clips with **AMCAP** program, please follow below steps:

1. Turn on your camera, and press the Mode Button to get into [] DV mode.
2. Connect your camera to computer with a USB cable
3. Click **Amcap** icon from desktop
4. Select **Devices > Coach Video Camera** from the pull-down menu. You should see a live image on screen. If you cannot see a live image, click **Options > Preview** from the menu.
5. Click **File > Set Capture File** from the pull-down menu
6. Enter the filename for the video clip to be captured and click **Open** button. Make sure to enter avi as the file extension

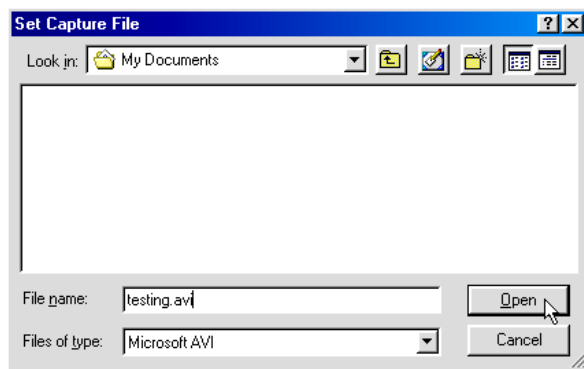

7. Keep the default value of 1 MBytes in the **Capture file size** field and click **OK** button.

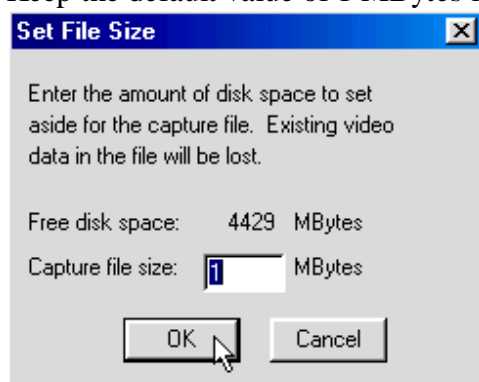

8. Click **Capture > Start Capture** from the pull-down menu
9. Select **OK** button to start capturing

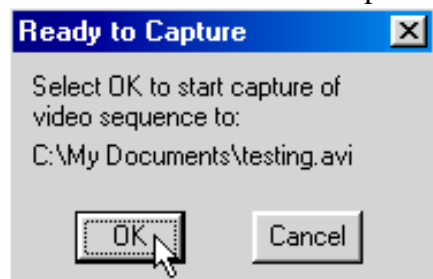

10. The time elapsed for video capturing is shown at the bottom of the screen
When video capture is finished, click **Capture > Stop Capture** from the pull-down menu or press **Esc** key on the keyboard

Tip:
The default value of frame rate is 11~15fps at 320x240pixel.. To change the video playback speed, change the AVI frame rate. Setting it to a larger value results in faster playback, while a small value results in slower playback

16. FREQUENTLY ASKED QUESTION (FAQs)

1. I always take poor quality images at home, why?

It may be due to insufficient light intensity at your home. Try to increase the illumination of your home when taking images. Or, use the flash in insufficient light environment.

2. Why would I get dark images even when the images are taken outdoors?

The objects may be in a shade, for example, under a tree, or the camera lens is pointing at a bright section such as the sky.

3. How can I avoid getting dark images?

Pay attention to the background light intensity as it will affect the exposure of the main object. The camera can calculate the total light intensity of the image and fine-adjust the exposure. If the background is too dark, the object will be too bright. If the background is too bright, the object will be too dark.

4. Why would I get fuzzy, unclear images?

There might be some movements of your body or hands when taking images. Hold the camera steadily with both hands. Use the first finger of your right hand to press the shutter. Stand on solid ground. Do not move or run when pressing the shutter. Even tiny movements will result in fuzzy images.

5. Why would I get some blurry areas in an image?

You may have covered part of the lens when taking the image. Or there may be some grease on the lens. Remove it with a dry and soft cloth.

6. Why would I get horizontal, black stripes in images taken abroad?

The camera is set to your country's AC mains frequency (e.g. 50Hz for Europe). If you take images under an electric light source in another country with a different frequency (e.g. 60Hz for US), you will get horizontal, black stripes in those images, due to incorrect mains frequency. There will be no problems when taking images under sunlight.

7. Can I take images in dark environment?

Use strobe flash in dark environment.

8. Can I take close-up shots of an object?

Yes, if it is more than 1.2m away. The object will be out of focus at a distance less than 1m away.

9. Can I use this camera as a PC camera (web cam)?

Yes, if there is a USB port on your computer and appropriate software, such as Microsoft NetMeeting, is used.

10. Why nothing can be seen from the display when I power on the camera?

Don't forget to open the slide door.

11. Why the camera suddenly has no response to any key functions?

The camera has suffered an unforeseen problem, eg electrostatic charge, impact..etc. à Briefly remove the battery from the camera, re-insert it, and then try again.

12. Why the camera is not recognized by the PC?

[A 1]: Camera driver is not installed properly. à Install the camera driver again. Refer to *chapter12*. Turn on the camera slide the Preview switch to [] (Preview) Mode. Then, reconnect the camera to the PC again.

[A 2]: There may be a problem in connecting the camera to the PC through the USB hub if the PC and the Hub are not compatible. à Wherever possible, connect the camera to the PC directly.

13. Does the camera support Win98?

No. Because Win98 didn't widely support multi-media devices until it launched Win98SE (Second Edition). Win98 user may try to download "Direct_X" from Microsoft website to update Win98 for USB devices.

<http://www.microsoft.com/downloads/details.aspx?FamilyID=63dafd1a-f9c9-4f35-89b0-261abc0e37a9&displaylang=en>

14. How can I view movie clip on a PC?

To Playback a movie on a PC, video player software is required. Macintosh users can download the latest version of QuickTime from <http://www.apple.com>

Windows users can download the latest version of Windows Media Player from <http://www.microsoft.com>

15. What is the default setting of the camera?

The table below shows the default setting for each item.

Item Description

Image size	:	2048x1536 pixels
Image quality	:	Fine
Flash	:	Off
White balance	:	Auto
TV Output	:	PAL
Light Frequency	:	50Hz
Exposure	:	0
Auto power off	:	1 minute
Beep	:	On
Self-Timer	:	Off
Date Stamp	:	Off

Free Manuals Download Website

<http://myh66.com>

<http://usermanuals.us>

<http://www.somanuals.com>

<http://www.4manuals.cc>

<http://www.manual-lib.com>

<http://www.404manual.com>

<http://www.luxmanual.com>

<http://aubethermostatmanual.com>

Golf course search by state

<http://golfingnear.com>

Email search by domain

<http://emailbydomain.com>

Auto manuals search

<http://auto.somanuals.com>

TV manuals search

<http://tv.somanuals.com>