

INSTALLATION INSTRUCTIONS FOR *(D, M)VC8 GAS FURNACE

(CATEGORY I)

Installer: Affix all manuals adjacent to the unit.

These furnaces comply with requirements embodied in the American National Standard / National Standard of Canada ANSI Z21.47·CSA-2.3 Gas Fired Central Furnaces.



RECOGNIZE THIS SYMBOL AS A SAFETY PRECAUTION.

ATTENTION INSTALLING PERSONNEL

As a professional installer, you have an obligation to know the product better than the customer. This includes all safety precautions and related items.

Prior to actual installation, thoroughly familiarize yourself with this Instruction Manual. Pay special attention to all safety warnings. Often during installation or repair, it is possible to place yourself in a position which is more hazardous than when the unit is in operation.

Remember, it is **your** responsibility to install the product safely and to know it well enough to be able to instruct a customer in its safe use.

Safety is a matter of common sense...a matter of thinking before acting.
Most dealers have a list of specific, good safety practices...follow them.

The precautions listed in this Installation Manual are intended as supplemental to existing practices. However, if there is a direct conflict between existing practices and the content of this manual, the precautions listed here take precedence.

NOTE: Please contact your distributor or our website for the applicable Specification Sheet referred to in this manual.

WARNING

GOODMAN WILL NOT BE RESPONSIBLE FOR ANY INJURY OR PROPERTY DAMAGE ARISING FROM IMPROPER SERVICE OR SERVICE PROCEDURES. IF YOU INSTALL OR PERFORM SERVICE ON THIS UNIT, YOU ASSUME RESPONSIBILITY FOR ANY PERSONAL INJURY OR PROPERTY DAMAGE WHICH MAY RESULT. MANY JURISDICTIONS REQUIRE A LICENSE TO INSTALL OR SERVICE HEATING AND AIR CONDITIONING EQUIPMENT.

5151 San Felipe Suite 500 • Houston, TX 77056
www.goodmanmfg.com • www.amana-hac.com

© 2009-2010 Goodman Manufacturing Company, L.P.



Table of Contents

SAFETY PRECAUTIONS	4
ADDITIONAL SAFETY CONSIDERATIONS	5
SHIPPING INSPECTION	5
ELECTROSTATIC DISCHARGE (ESD) PRECAUTIONS	5
TO THE INSTALLER	5
IMPORTANT NOTE TO THE OWNER REGARDING PRODUCT WARRANTY	5
PRODUCT DESCRIPTION	6
FEATURES	6
PRODUCT APPLICATION	6
LOCATION REQUIREMENTS AND CONSIDERATIONS	7
CLEARANCES AND ACCESSIBILITY	8
HORIZONTAL INSTALLATION (*MVC8 MODELS ONLY)	8
FURNACE SUSPENSION	8
EXISTING FURNACE REMOVAL	8
THERMOSTAT LOCATION	9
COMBUSTION AND VENTILATION AIR REQUIREMENTS	9
CATEGORY I VENTING (VERTICAL VENTING)	10
EXTERIOR MASONRY CHIMNEYS (CATEGORY I FURNACES ONLY)	11
CHECKLIST SUMMARY	11
CHECK 1 - PROPER CHIMNEY TERMINATION.	12
CHECK 2 - ANY SOLID OR LIQUID FUEL APPLIANCES VENTED INTO THIS CHIMNEY CHANNEL	12
CHECK 3 - CHIMNEY CROWN CONDITION.	13
CHECK 4 - DEBRIS IN CLEANOUT	13
CHECK 5 - LINER CONDITION.	13
CHECK 6 - DILUTION AIR.	13
CHECK 7 - COMPLETE THE INSTALLATION.	13
FIX 1 - LINER TERMINATION	14
FIX 2 -CHANGE VENTING ARRANGEMENTS	14
FIX 3 - REBUILD THE CROWN	14
FIX 4 - RELINING	14
ELECTRICAL CONNECTIONS	15
WIRING HARNESS	15
115 VOLT LINE CONNECTIONS	15
JUNCTION BOX RELOCATION	16
24 VOLT THERMOSTAT WIRING	16
SINGLE-STAGE HEATING THERMOSTAT APPLICATION	17
24 VOLT DEHUMIDISTAT WIRING	17
FOSSIL FUEL APPLICATIONS	17
115 VOLT LINE CONNECTION OF ACCESSORIES (HUMIDIFIER AND ELECTRONIC AIR CLEANER)	18
24 VOLT HUMIDIFIER	18
GAS SUPPLY AND PIPING	18
HIGH ALTITUDE DERATE	18
PROPANE GAS CONVERSION	18
GAS PIPING CONNECTIONS	18
UPFLOW INSTALLATIONS	20
COUNTERFLOW INSTALLATIONS	20
GAS PIPING CHECKS	20
PROPANE GAS TANKS AND PIPING	21
CIRCULATING AIR AND FILTERS	21
CHECKING DUCT STATIC	22
FILTERS - READ THIS SECTION BEFORE INSTALLING THE RETURN AIR DUCTWORK	22
UPRIGHT INSTALLATIONS	23

Table of Contents

CIRCULATION AIR FILTERS	23
HORIZONTAL INSTALLATIONS	23
START-UP PROCEDURE AND ADJUSTMENT	23
HEAT ANTICIPATOR SETTING	23
FURNACE OPERATION	23
GAS SUPPLY PRESSURE MEASUREMENT	23
GAS MANIFOLD PRESSURE MEASUREMENT AND ADJUSTMENT	25
GAS INPUT RATE MEASUREMENT (NATURAL GAS ONLY)	25
TEMPERATURE RISE	26
CIRCULATOR BLOWER SPEEDS	26
BLOWER HEAT OFF DELAY TIMINGS	28
COMFORTNET™ SYSTEM	29
OVERVIEW	29
AIRFLOW CONSIDERATIONS	29
FOSSIL FUEL APPLICATIONS	30
CTK01AA WIRING	30
COMFORTNET SYSTEM ADVANCED FEATURES	30
NETWORK TROUBLESHOOTING	33
SYSTEM TROUBLESHOOTING	33
NORMAL SEQUENCE OF OPERATION	34
POWER UP	34
HEATING MODE	34
COOLING MODE	35
FAN ONLY MODE	35
OPERATIONAL CHECKS	35
SAFETY CIRCUIT DESCRIPTION	36
INTEGRATED CONTROL MODULE	36
PRIMARY LIMIT	36
AUXILIARY LIMIT	36
ROLLOUT LIMIT	36
PRESSURE SWITCHES	36
FLAME SENSOR	36
TROUBLESHOOTING	36
ELECTROSTATIC DISCHARGE (ESD) PRECAUTIONS	36
DIAGNOSTIC CHART	36
FAULT RECALL	37
RESETTING FROM LOCKOUT	37
MAINTENANCE	37
ANNUAL INSPECTION	37
FILTERS	37
BURNERS	38
INDUCED DRAFT AND CIRCULATOR BLOWERS	38
FLAME SENSOR (QUALIFIED SERVICER ONLY)	38
FLUE PASSAGES (QUALIFIED SERVICER ONLY)	38
BEFORE LEAVING AN INSTALLATION	38
REPAIR AND REPLACEMENT PARTS	38
TROUBLESHOOTING CHART	39
STATUS CODES	44
AIR FLOW DATA	45
DIP SWITCHES	45
*MVC8__AA WIRING DIAGRAM	46
*MVC8__AB, *DVC8__AA WIRING DIAGRAM	47

SAFETY PRECAUTIONS

Adhere to the following warnings and cautions when installing, adjusting, altering, servicing, or operating the furnace. To ensure proper installation and operation, thoroughly read this manual for specifics pertaining to the installation and application of this product.

WARNING

TO PREVENT PERSONAL INJURY OR DEATH DUE TO IMPROPER INSTALLATION, ADJUSTMENT, ALTERATION, SERVICE OR MAINTENANCE, REFER TO THIS MANUAL. FOR ADDITIONAL ASSISTANCE OR INFORMATION, CONSULT A QUALIFIED INSTALLER, SERVICER AGENCY OR THE GAS SUPPLIER.

WARNING

IF THE INFORMATION IN THESE INSTRUCTIONS IS NOT FOLLOWED EXACTLY, A FIRE OR EXPLOSION MAY RESULT CAUSING PROPERTY DAMAGE, PERSONAL INJURY OR LOSS OF LIFE.

- DO NOT STORE OR USE GASOLINE OR OTHER FLAMMABLE VAPORS AND LIQUIDS IN THE VICINITY OF THIS OR ANY OTHER APPLIANCE.
- **WHAT TO DO IF YOU SMELL GAS:**
 - DO NOT TRY TO LIGHT ANY APPLIANCE.
 - DO NOT TOUCH ANY ELECTRICAL SWITCH; DO NOT USE ANY PHONE IN YOUR BUILDING.
 - IMMEDIATELY CALL YOUR GAS SUPPLIER FROM A NEIGHBOR'S PHONE. FOLLOW THE GAS SUPPLIER'S INSTRUCTIONS.
 - IF YOU CANNOT REACH YOUR GAS SUPPLIER, CALL THE FIRE DEPARTMENT.
- INSTALLATION AND SERVICE MUST BE PERFORMED BY A QUALIFIED INSTALLER, SERVICE AGENCY OR THE GAS SUPPLIER.

WARNING

THIS PRODUCT CONTAINS OR PRODUCES A CHEMICAL OR CHEMICALS WHICH MAY CAUSE SERIOUS ILLNESS OR DEATH AND WHICH ARE KNOWN TO THE STATE OF CALIFORNIA TO CAUSE CANCER, BIRTH DEFECTS OR OTHER REPRODUCTIVE HARM.

WARNING

HEATING UNIT SHOULD NOT BE UTILIZED WITHOUT REASONABLE, ROUTINE, INSPECTION, MAINTENANCE AND SUPERVISION. IF THE BUILDING IN WHICH ANY SUCH DEVICE IS LOCATED WILL BE VACANT, CARE SHOULD BE TAKEN THAT SUCH DEVICE IS ROUTINELY INSPECTED, MAINTAINED AND MONITORED. IN THE EVENT THAT THE BUILDING MAYBE EXPOSED TO FREEZING TEMPERATURES AND WILL BE VACANT, ALL WATER-BEARING PIPES SHOULD BE DRAINED, THE BUILDING SHOULD BE PROPERLY WINTERIZED, AND THE WATER SOURCE CLOSED. IN THE EVENT THAT THE BUILDING MAY BE EXPOSED TO FREEZING TEMPERATURES AND WILL BE VACANT, ANY HYDRONIC COIL UNITS SHOULD BE DRAINED AS WELL AND, IN SUCH CASE, ALTERNATIVE HEAT SOURCES SHOULD BE UTILIZED.

WARNING

TO PREVENT POSSIBLE PROPERTY DAMAGE, PERSONAL INJURY OR DEATH DUE TO ELECTRICAL SHOCK, THE FURNACE MUST BE LOCATED TO PROTECT THE ELECTRICAL COMPONENTS FROM WATER.

**DANGER**
PELIGRO

CARBON MONOXIDE POISONING HAZARD

Special Warning for Installation of Furnace or Air Handling Units in Enclosed Areas such as Garages, Utility Rooms or Parking Areas

Carbon monoxide producing devices (such as an automobile, space heater, gas water heater, etc.) should not be operated in enclosed areas such as unventilated garages, utility rooms or parking areas because of the danger of carbon monoxide (CO) poisoning resulting from the exhaust emissions. If a furnace or air handler is installed in an enclosed area such as a garage, utility room or parking area and a carbon monoxide producing device is operated therein, there must be adequate, direct outside ventilation.

This ventilation is necessary to avoid the danger of CO poisoning which can occur if a carbon monoxide producing device continues to operate in the enclosed area. Carbon monoxide emissions can be (re)circulated throughout the structure if the furnace or air handler is operating in any mode.

CO can cause serious illness including permanent brain damage or death.

B10259-216

WARNING

SHOULD OVERHEATING OCCUR OR THE GAS SUPPLY FAIL TO SHUT OFF, TURN OFF THE MANUAL GAS SHUTOFF VALVE EXTERNAL TO THE FURNACE BEFORE TURNING OFF THE ELECTRICAL SUPPLY.

WARNING

POSSIBLE PROPERTY DAMAGE, PERSONAL INJURY OR DEATH DUE TO FIRE, EXPLOSION, SMOKE, SOOT, CONDENSATION, ELECTRICAL SHOCK OR CARBON MONOXIDE MAY RESULT FROM IMPROPER INSTALLATION, REPAIR OPERATION, OR MAINTENANCE OF THIS PRODUCT.

WARNING

TO PREVENT PERSONAL INJURY OR DEATH DUE TO IMPROPER INSTALLATION, ADJUSTMENT, ALTERATION, SERVICE OR MAINTENANCE, REFER TO THIS MANUAL. FOR ADDITIONAL ASSISTANCE OR INFORMATION, CONSULT A QUALIFIED INSTALLER, SERVICER AGENCY OR THE GAS SUPPLIER.

WARNING

THIS UNIT MUST NOT BE USED AS A "CONSTRUCTION HEATER" DURING THE FINISHING PHASES OF CONSTRUCTION ON A NEW STRUCTURE. THIS TYPE OF USE MAY RESULT IN PREMATURE FAILURE OF THE UNIT DUE TO EXTREMELY LOW RETURN AIR TEMPERATURES AND EXPOSURE TO CORROSIVE OR VERY DIRTY ATMOSPHERES.



WARNING

TO PREVENT PERSONAL INJURY OR DEATH DUE TO ASPHYXIATION, THIS FURNACE MUST BE CATEGORY I VENTED. DO NOT VENT USING CATEGORY III VENTING.

PROVISIONS MUST BE MADE FOR VENTING COMBUSTION PRODUCTS OUTDOORS THROUGH A PROPER VENTING SYSTEM. THE LENGTH OF FLUE PIPE COULD BE A LIMITING FACTOR IN LOCATING THE FURNACE.

ADDITIONAL SAFETY CONSIDERATIONS

- This furnace is approved for Category I Venting only.
- Provisions must be made for venting combustion products outdoors through a proper venting system. The length of flue pipe could be a limiting factor in locating the furnace.

SHIPPING INSPECTION

All units are securely packed in shipping containers tested according to International Safe Transit Association specifications. The carton must be checked upon arrival for external damage. If damage is found, a request for inspection by carrier's agent must be made in writing immediately.

The furnace must be carefully inspected on arrival for damage and bolts or screws which may have come loose in transit. In the event of damage the consignee should:

1. Make a notation on delivery receipt of any visible damage to shipment or container.
2. Notify carrier promptly and request an inspection.
3. With concealed damage, carrier must be notified as soon as possible - preferably within five days.
4. File the claim with the following support documents within a nine month statute of limitations.
 - Original or certified copy of the Bill of Lading, or indemnity bond.
 - Original paid freight bill or indemnity in lieu thereof.
 - Original or certified copy of the invoice, showing trade and other discounts or reductions.
 - Copy of the inspection report issued by carrier's representative at the time damage is reported to carrier.

The carrier is responsible for making prompt inspection of damage and for a thorough investigation of each claim. The distributor or manufacturer will not accept claims from dealers for transportation damage.

Keep this literature in a safe place for future reference.

ELECTROSTATIC DISCHARGE (ESD) PRECAUTIONS

NOTE: Discharge body's static electricity before touching unit. An electrostatic discharge can adversely affect electrical components.

Use the following precautions during furnace installation and servicing to protect the integrated control module from damage. By putting the furnace, the control, and the person at the same electrostatic potential, these steps will help avoid exposing the integrated control module to electrostatic discharge.

This procedure is applicable to both installed and non-installed (ungrounded) furnaces.

1. Disconnect all power to the furnace. Do not touch the integrated control module or any wire connected to the control prior to discharging your body's electrostatic charge to ground.
2. Firmly touch a clean, unpainted, metal surface of the furnaces near the control. Any tools held in a person's hand during grounding will be discharged.
3. Service integrated control module or connecting wiring following the discharge process in step 2. Use caution not to recharge your body with static electricity; (i.e., do not move or shuffle your feet, do not touch ungrounded objects, etc.). If you come in contact with an ungrounded object, repeat step 2 before touching control or wires.
4. Discharge your body to ground before removing a new control from its container. Follow steps 1 through 3 if installing the control on a furnace. Return any old or new controls to their containers before touching any ungrounded object.

TO THE INSTALLER

Before installing this unit, please read this manual thoroughly to familiarize yourself with specific items which must be adhered to, including but not limited to: unit maximum external static pressure, gas pressures, BTU input rating, proper electrical connections, circulating air temperature rise, minimum or maximum CFM, and motor speed connections, and venting. These furnaces are designed for Category I venting only.

IMPORTANT NOTE TO THE OWNER REGARDING PRODUCT WARRANTY

Complete warranty details and instructions are available from your local dealer or at www.goodmanmfg.com and www.amana-hac.com. Your warranty certificate is supplied as a separate document with the unit installed by your contractor. Read the limited warranty certificate carefully to determine what is and is not covered and keep the warranty certificate in a safe place. If you are unable to locate the warranty certificate please contact your installing contractor or contact customer service (877-254-4729) to obtain a copy.

To receive the Lifetime Heat Exchanger Limited Warranty, good for as long as you own your home, and the 10-year Parts Limited Warranty, online registration must be completed within 60 days of installation. Online registration is not required in California or Quebec.

IMPORTANT: To register your Goodman brand unit, go to www.goodmanmfg.com. Click on the word "Warranty" located on the left side of the home page. Next, click on the word "Product Registration" located on the left side of the Warranty page and complete the forms in the manner indicated on the Product Registration page.

To register your Amana brand unit, go to www.amana-hac.com. Click on the word "Warranty" located on the top right of the

LOCATION REQUIREMENTS AND CONSIDERATIONS

home page. Next, click on the word “Product Registration” located on the left side of the Warranty page and complete the forms in the manner indicated on the Product Registration page.

Product limited warranty certificates for models currently in production can be viewed at www.goodmanmfg.com or www.amana-hac.com. If your model is not currently in production or does not appear on the website, please contact your installing contractor or contact customer service at (877-254-4729) to obtain a copy of your warranty certificate.

Each product overview page contains a Product Warranty link; by clicking on it you will be able to view the limited warranty coverage for that specific product. To view warranty registration information, click on the Product Warranty text on the left navigation panel on the home page of each website. The Online Product Registration pages are located in this same section.



WARNING

TO PREVENT PROPERTY DAMAGE, PERSONAL INJURY OR DEATH DUE TO FIRE, DO NOT INSTALL THIS FURNACE IN A MOBILE HOME, TRAILER, OR RECREATIONAL VEHICLE.

PRODUCT DESCRIPTION

FEATURES

This furnace is a part of the ComfortNet™ family of products. The CTK01 ComfortNet thermostat kit allows this furnace to be installed as part of a digitally communicating system. The ComfortNet system provides automatic airflow configuration, enhanced setup features, and enhanced diagnostics. It also reduces the number of thermostat wires to a maximum of four. It may be also installed as part of a “legacy” system using a standard 24 VAC thermostat.

This product may also be installed with the ComfortNet thermostat and a non-ComfortNet compatible single stage air conditioning unit. However, this reduces the benefits of the ComfortNet system as the enhancements will only apply to the furnace.

PRODUCT APPLICATION

This furnace is primarily designed for residential home-heating applications. It is NOT designed or certified for use in mobile homes, trailers or recreational vehicles. Neither is it designed or certified for outdoor applications. The furnace **must** be installed indoors (i.e., attic space, crawl space, or garage area provided the garage area is enclosed with an operating door).

This furnace can be used in the following non-industrial commercial applications:

**Schools, Office buildings, Churches, Retail stores,
Nursing homes, Hotels/motels, Common or office areas**

In such applications, the furnace must be installed with the following stipulations:

- It must be installed per the installation instructions provided and per local and national codes.
- It must be installed indoors in a building constructed on site.
- It must be part of a ducted system and not used in a free air delivery application.
- It must not be used as a “make-up” air unit.
- All other warranty exclusions and restrictions apply.

This furnace may be used as a construction site heater **ONLY** if the following conditions are met:

- The vent system is permanently installed per these installation instructions.
 - A room thermostat is used to control the furnace. Fixed jumpers that provide continuous heating CANNOT be used.
 - Return air ducts are provided and sealed to the furnace.
 - A return air temperature range between 60°F (16°C) and 80°F (27°C) is maintained.
 - Air filters are installed in the system and maintained during construction, replaced as appropriate during construction, and upon completion of construction are replaced.
 - The input rate and temperature rise are set per the furnace rating plate.
 - 100% outside air is provided for combustion air requirements during construction. Temporary ducting can be used.
- NOTE:** Do not connect the temporary duct directly to the furnace. The duct must be sized for adequate combustion and ventilation in accordance with the latest edition of the National Fuel Gas Code NFPA 54/ANSI Z223.1 or CAN/CSA B149.1 Installation Codes.
- The furnace heat exchanger, components, duct system, air filters and evaporator coils are thoroughly cleaned following final construction clean up.
 - All furnace operating conditions (including ignition, input rate, temperature rise and venting) are verified according to these installation instructions.

NOTE: The Commonwealth of Massachusetts requires that the following additional requirements must also be met:

- Gas furnaces must be installed by a licensed plumber or gas fitter.
- A T-handle gas cock must be used.
- If the unit is to be installed in an attic, the passageway to and the service area around the unit must have flooring.



WARNING

TO PREVENT PROPERTY DAMAGE, PERSONAL INJURY OR DEATH DUE TO FIRE, DO NOT INSTALL THIS FURNACE IN A MOBILE HOME, TRAILER, OR RECREATIONAL VEHICLE.

LOCATION REQUIREMENTS AND CONSIDERATIONS

To ensure proper furnace operation, install, operate and maintain the furnace in accordance with these installation and operation instructions, all local building codes and ordinances. In their absence, follow the latest edition of the National Fuel Gas Code (NFPA 54/ANSI Z223.1), and/or CAN/CSA B149 Installation Codes, local plumbing or waste water codes, and other applicable codes.

A copy of the National Fuel Gas Code (NFPA 54/ANSI Z223.1) can be obtained from any of the following:

American National Standards Institute

1430 Broadway
New York, NY 10018

National Fire Protection Association

1 Batterymarch Park
Quincy, MA 02269

CSA International

8501 East Pleasant Valley
Cleveland, OH 44131

A copy of the CAN/CSA B149 Installation Codes can also be obtained from:

CSA International

178 Rexdale Boulevard
Etobicoke, Ontario, Canada M9W 1R3

The rated heating capacity of the furnace should be greater than or equal to the total heat loss of the area to be heated. The total heat loss should be calculated by an approved method or in accordance with "ASHRAE Guide" or "Manual J-Load Calculations" published by the Air Conditioning Contractors of America.

In the USA, this furnace MUST be installed in accordance with the latest edition of the ANSI Z223.1 booklet entitled "National Fuel Gas Code" (NFPA 54), and the requirements or codes of the local utility or other authority having jurisdiction. In Canada, this furnace must be installed in accordance with the current CAN/CGA-B149.1 & 2 Gas Installation Codes, local plumbing or waste water codes and other applicable codes. Additional helpful publications available from the NFPA are, NFPA 90A - Installation of Air Conditioning and Ventilating System and NFPA 90B - Warm Air Heating and Air Conditioning System.

All venting shall be in accordance with PART 7, Venting of Equipment, of the National Fuel Gas Code, ANSI Z223.1, or applicable local building and/or air conditioning codes. These publications are available from:

National Fire Protection Association, Inc.

Batterymarch Park, Quincy, MA 02269

NOTE: Furnaces with NOx screens meet the California NOx emission standards and California seasonal efficiency standards. ANNUAL inspections of the furnace and its vent system is strongly recommended.

LOCATION REQUIREMENTS AND CONSIDERATIONS

Your unit model type determines which installation procedures must be used. For *MVC8 models, you must follow instructions for Horizontal Left, Horizontal Right or Upflow installations only. These furnaces are not approved for Downflow installations.

Downflow models *DVC8 ARE NOT APPROVED FOR HORIZONTAL OR UPFLOW INSTALLATIONS. For these models, use only the instructions for downflow installation only.



WARNING

TO PREVENT POSSIBLE EQUIPMENT DAMAGE, PROPERTY DAMAGE, PERSONAL INJURY OR DEATH, THE FOLLOWING BULLET POINTS MUST BE OBSERVED WHEN INSTALLING THIS UNIT.

Follow the instructions listed below when selecting a furnace location. Refer also to the guidelines provided in *Section V, Combustion and Ventilation Air Requirements*.

- Centrally locate the furnace with respect to the proposed or existing air distribution system.
- Ensure the temperature of the return air entering the furnace is between 55°F and 100°F when the furnace is heating.
- Provisions must be made for venting combustion products outdoors through a proper venting system. The length of flue pipe could be a limiting factor in locating the furnace.
- Ensure adequate combustion air is available for the furnace. Improper or insufficient combustion air can expose building occupants to gas combustion products that could include carbon monoxide. Refer to *Combustion and Ventilation Air Requirements* section.
- The furnace must be level. If the furnace is to be set on a floor that may become wet or damp at times, the furnace should be supported above the floor on a concrete base sized approximately 1-1/2" larger than the base of the furnace.
- Ensure upflow or horizontal furnaces are not installed directly on carpeting, or any other combustible material. The only combustible material allowed is wood.
- Exposure to contaminated combustion air will result in safety and performance-related problems. Do not install the furnace where the combustion air is exposed to the following substances:

- chlorinated waxes or cleaners
- chlorine-based swimming pool chemicals
- water softening chemicals
- deicing salts or chemicals
- carbon tetrachloride
- halogen type refrigerants
- cleaning solutions (such as perchloroethylene)
- printing inks
- paint removers
- varnishes

LOCATION REQUIREMENTS AND CONSIDERATIONS

hydrochloric acid
cements and glues

antistatic fabric softeners for clothes dryers
and masonry acid washing materials

- If the furnace is used in connection with a cooling unit, install the furnace upstream or in parallel with the cooling unit coil. Premature heat exchanger failure will result if the cooling unit coil is placed ahead of the furnace.
- If the furnace is installed in a residential garage, position the furnace so that the burners and ignition source are located not less than 18 inches (457 mm) above the floor. Protect the furnace from physical damage by vehicles.
- If the furnace is installed horizontally, the furnace access doors must be vertical so that the burners fire horizontally into the heat exchanger. Do not install the unit with the access doors on the "up/top" or "down/bottom" side of the furnace.
- Do not connect this furnace to a chimney flue that serves a separate appliance designed to burn solid fuel.
- For counterflow installations, the air conditioning coil must be downstream from the heat exchanger of the furnace.
- Counterflow installation over a noncombustible floor. Before setting the furnace over the plenum opening, ensure the surface around the opening is smooth and level. A tight seal should be made between the furnace base and floor by using a silicon rubber caulking compound or cement grout.
- Counterflow installation over a combustible floor. If installation over a combustible floor becomes necessary, use an accessory subbase (see Specification Sheet applicable to your model for details). A special accessory subbase must be used for upright counterflow unit installations over any combustible material including wood. Follow the instructions with the subbase for proper installations. Do not install the furnace directly on carpeting, tile, or other combustible material other than wood flooring. **(NOTE:** The subbase will not be required if an air conditioning coil is installed between the supply air opening on the furnace and the floor.

Vent Pipe Clearance to Combustibles-
6" using Single Wall Connector or 1"
using B-1 vent.

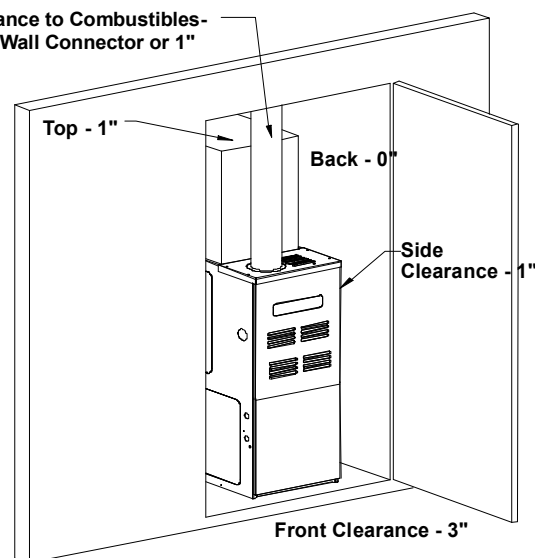

- Adequate combustion/ventilation air must be supplied to the closet.
- Furnace must be **completely** sealed to floor or base. Combustion/ventilation air supply pipes must terminate 12" from top of closet and 12" from floor of closet. DO NOT remove solid base plate for side return.
- Return air ducts must be **completely** sealed to the furnace and terminate outside the enclosure surfaces.

CLEARANCES AND ACCESSIBILITY

Unobstructed front clearance of 24" **for servicing** is recommended.

VENT		SIDES	FRONT	BACK	TOP (PLENUM)
B1-VENT	SINGLE				
1"	6"	1"	3"	0"	1"

Top clearance for horizontal configuration - 1"

HORIZONTAL INSTALLATION (*MVC8 MODELS ONLY)

Line contact to framing is permitted when installed in the horizontal configuration. Line contact is defined as the portion of the cabinet that is formed by the intersection of the top and side. ACCESSIBILITY CLEARANCE, WHERE GREATER, SHOULD TAKE PRECEDENCE OVER MINIMUM FIRE PROTECTION CLEARANCE. A gas-fired furnace for installation in a residential garage must be installed so that the ignition source and burners are located not less than eighteen inches (18") above the floor and is protected or located to prevent physical damage by vehicles. A gas furnace must not be installed directly on carpeting, tile, or other combustible materials other than wood flooring.

FURNACE SUSPENSION

If suspending the furnace from rafters or joist, use 3/8" threaded rod and 2"x2"x3/8" angle iron as shown below. The length of rod will depend on the application and the clearances necessary.

COMBUSTION & VENTILATION CATEGORY I VENTING AIR REQUIREMENTS

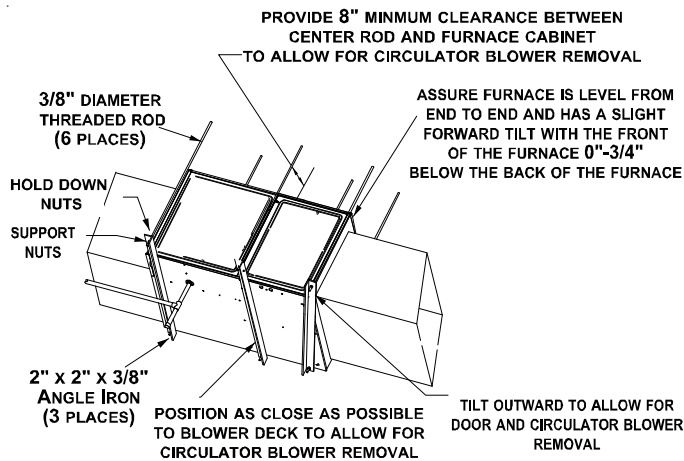

Suspended Furnace

EXISTING FURNACE REMOVAL

NOTE: When an existing furnace is removed from a venting system serving other appliances, the venting system may be too large to properly vent the remaining attached appliances.

The following vent testing procedure is reproduced from the **American National Standard/National Standard of Canada for Gas-Fired Central Furnaces ANSI Z21.47-Latest Edition, CSA-2.3-Latest Edition Section 1.23.1**. The following steps shall be followed with each appliance connected to the venting system placed in operation, while any other appliances connected to the venting system are not in operation:

- Seal any unused openings in the venting system;
- Inspect the venting system for proper size and horizontal pitch, as required by the National Fuel Gas Code, ANSI Z223.1 or the CAN/CSA B149 Installation Codes and these instructions. Determine that there is no blockage or restriction, leakage, corrosion and other deficiencies which could cause an unsafe condition;
- In so far as practical, close all building doors and windows and all doors between the space in which the appliance(s) connected to the venting system are located and other spaces of the building. Turn on clothes dryers and any appliance not connected to the venting system. Turn on any exhaust fans, such as range hoods and bathroom exhausts, so they shall operate at maximum speed. Do not operate a summer exhaust fan. Close fireplace dampers;
- Follow the lighting instructions. Place the appliance being inspected in operation. Adjust thermostat so appliance shall operate continuously;
- Test for draft hood equipped appliance spillage at the draft hood relief opening after 5 minutes of main burner operation. Use the flame of a match or candle;
- After it has been determined that each appliance connected to the venting system properly vents when tested as outlined above, return doors, windows, exhaust fans, fireplace dampers and any other gas burning appliance to their previous conditions of use;

- If improper venting is observed during any of the above tests, the common venting system must be corrected.

Corrections must be in accordance with the latest edition of the National Fuel Gas Code NFPA 54/ANSI Z223.1 and/or CAN/CSA B149 Installation Codes.

If resizing is required on any portion of the venting system, use the appropriate table in Appendix G in the latest edition of the National Fuel Gas Code ANSI Z223.1 and/or CAN/CSA B149 Installation Codes.

THERMOSTAT LOCATION

In an area having good air circulation, locate the thermostat about five feet high on a vibration-free inside wall. Do not install the thermostat where it may be influenced by any of the following:

- Drafts, or dead spots behind doors, in corners, or under cabinets.
- Hot or cold air from registers.
- Radiant heat from the sun.
- Light fixtures or other appliances.
- Radiant heat from a fireplace.
- Concealed hot or cold water pipes, or chimneys.
- Unconditioned areas behind the thermostat, such as an outside wall.

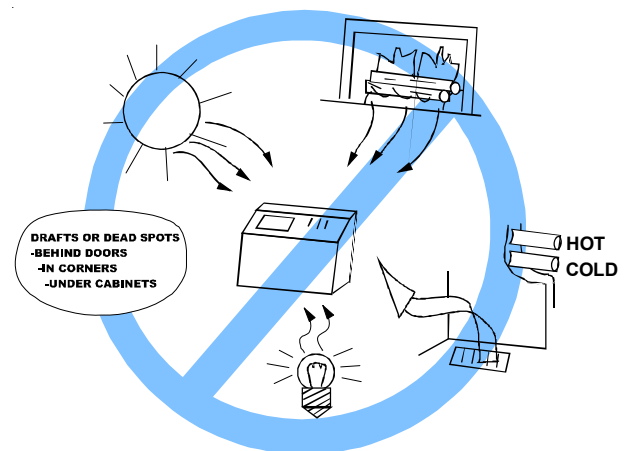

Thermostat Influences

Consult the instructions packaged with the thermostat for mounting instructions and further precautions.

COMBUSTION AND VENTILATION AIR REQUIREMENTS

WARNING

TO AVOID PROPERTY DAMAGE, PERSONAL INJURY OR DEATH, SUFFICIENT FRESH AIR FOR PROPER COMBUSTION AND VENTILATION OF FLUE GASES MUST BE SUPPLIED. MOST HOMES REQUIRE OUTSIDE AIR BE SUPPLIED INTO THE FURNACE AREA.

Improved construction and additional insulation in buildings have reduced heat loss by reducing air infiltration and escape around doors and windows. These changes have helped in reducing

EXTERIOR MASONRY CHIMNEYS - CATEGORY I FURNACES ONLY

heating/cooling costs but have created a problem supplying combustion and ventilation air for gas fired and other fuel burning appliances. Appliances that pull air out of the house (clothes dryers, exhaust fans, fireplaces, etc.) increase the problem by starving appliances for air.

House depressurization can cause back drafting or improper combustion of gas-fired appliances, thereby exposing building occupants to gas combustion products that could include carbon monoxide.

If this furnace is to be installed in the same space with other gas appliances, such as a water heater, ensure there is an adequate supply of combustion and ventilation air for the other appliances. Refer to the latest edition of the National Fuel Gas Code NFPA 54/ANSI Z223.1 or CAN/CSA B149 Installation Codes or applicable provisions of the local building codes for determining the combustion air requirements for the appliances.

This furnace must use indoor air for combustion. It cannot be installed as a direct vent (i.e., sealed combustion) furnace.

Most homes will require outside air be supplied to the furnace area by means of ventilation grilles or ducts connecting directly to the outdoors or spaces open to the outdoors such as attics or crawl spaces.

CATEGORY I VENTING (VERTICAL VENTING)



WARNING

TO PREVENT POSSIBLE PERSONAL INJURY OR DEATH DUE TO ASPHYXIATION, THIS FURNACE MUST BE CATEGORY I VENTED. DO NOT VENT USING CATEGORY III VENTING.

Category I Venting is venting at a non-positive pressure. A furnace vented as Category I is considered a fan-assisted appliance and the vent system does not have to be "gas tight."

NOTE: Single stage gas furnaces with induced draft blowers draw products of combustion through a heat exchanger allowing, in some instances, common venting with natural draft appliances (i.e. water heaters). All installations must be vented in accordance with National Fuel Gas Code NFPA 54/ANSI Z223.1 - latest edition. In Canada, the furnaces must be vented in accordance with the National Standard of Canada, CAN/CSA B149.1 and CAN/CSA B149.2 - latest editions and amendments.

NOTE: The vertical height of the Category I venting system must be at least as great as the horizontal length of the venting system.



WARNING

TO PREVENT POSSIBLE PERSONAL INJURY OR DEATH DUE TO ASPHYXIATION, COMMON VENTING WITH OTHER MANUFACTURER'S INDUCED DRAFT APPLIANCES IS NOT ALLOWED.

The minimum vent diameter for the Category I venting system is as shown:

MODEL	MINIMUM VENT	
	UPFLOW	COUNTERFLOW
70	4 inch	4 inch
90	4 inch	4 inch
115	5 inch	4 inch

Under some conditions, larger vents than those shown above may be required or allowed. *When an existing furnace is removed from a venting system serving other appliances, the venting system may be too large to properly vent the remaining attached appliances.*

Upflow or Horizontal units are shipped with the induced draft blower discharging from the top of the furnace. ("Top" is as viewed for an upflow installation.) The induced draft blower can be rotated 90 degrees for Category I venting. For horizontal installations, a four inch single wall pipe can be used to extend the induced draft blower outlet 1/2" beyond the furnace cabinet. **THIS PRODUCT IS NOT DESIGNED FOR COUNTERCLOCKWISE INDUCED DRAFT BLOWER ROTATION.**

Vent the furnace in accordance with the National Fuel Gas Code NFPA 54/ANSI Z223.1 - latest edition. In Canada, vent the furnace in accordance with the National Standard of Canada, CAN/CSA B149.1 and CAN/CSA B149.2 - latest editions and amendments.

Venting

THIS FURNACE IS NOT DESIGN CERTIFIED TO BE HORIZONTALLY VENTED.

To rotate the induced draft blower clockwise, you will need to purchase one (0270F01119) chimney transition bottom kit.

1. Disconnect electrical power from the furnace.
2. Disconnect the induced draft blower power leads, flue pipe, and pressure switch tubing.
3. Remove the round cutout from the right side of the wrapper.
4. Remove and save the four screws that fasten the induced draft blower to the flue collector box.
5. Remove and save the three screws that hold the chimney assembly to the induced draft blower.
6. Remove and save the four screws that fasten the chimney top to the chimney bottom.
7. Remove the chimney transition bottom from the transition bottom kit.
8. Install the chimney top with the four screws retained from step 6 onto the new chimney transition bottom from the transition bottom kit.
9. Install chimney assembly with the three screws retained from step 5 onto the induced draft blower.
10. Reinstall the induced draft blower rotating it 90 degrees clockwise from the original upflow configuration using the four screws retained in step 3. Ensure the gasket located between the induced draft blower and the collector box is rotated accordingly.

EXTERIOR MASONRY CHIMNEYS - CATEGORY I FURNACES ONLY

11. Reconnect the induced draft blower power leads. NOTE: If the wires are not long enough, pull extra wire from the wire bundle in the blower compartment.
12. Reconnect the flue pipe, and the pressure switch tubing. Ensure that all wires and the pressure switch tubing is at least one inch from the flue pipe, or any other hot surface.
13. Restore power to furnace.

Counterflow units are shipped with the induced draft blower discharging from the top of the furnace. ("Top" as viewed for a counterflow installation.)

Vent the furnace in accordance with the National Fuel Gas Code NFPA54/ANSI Z223.1-latest edition. In Canada, vent the furnace in accordance with the national standard of Canada, CAN/CSA B149.1 and CAN/CSA B149.2- latest editions and amendments.



WARNING

NEVER ALLOW THE PRODUCTS OF COMBUSTION, INCLUDING CARBON MONOXIDE, TO ENTER THE RETURN DUCTWORK OR CIRCULATION AIR SUPPLY.

EXTERIOR MASONRY CHIMNEYS (CATEGORY I FURNACES ONLY)

An exterior masonry chimney is defined as a "Masonry" chimney exposed to the outdoors on one or more sides below the roof line." The ability to use a clay lined masonry chimney depends on a parameter not associated with interior chimneys. This variable is the geographic location of the installation. Researchers have discovered that the winter design temperatures have a direct impact on the suitability of this type of venting. In most situations, the existing masonry chimneys will require a properly sized metallic liner.



WARNING

POSSIBILITY OF PROPERTY DAMAGE, PERSONAL INJURY OR DEATH
DAMAGING CONDENSATION CAN OCCUR INSIDE MASONRY CHIMNEYS WHEN A SINGLE FAN-ASSISTED CATEGORY I APPLIANCE (80% AFUE FURNACE) IS VENTED WITHOUT ADEQUATE DILUTION AIR. DO NOT CONNECT AN 80% FURNACE TO A MASONRY CHIMNEY UNLESS THE FURNACE IS COMMON VENTED WITH A DRAFT HOOD EQUIPPED APPLIANCE OR THE CHIMNEY IS LINED WITH A METAL LINER OR TYPE B METAL VENT. ALL INSTALLATIONS USING MASONRY CHIMNEYS MUST BE SIZED IN ACCORDANCE WITH THE APPROPRIATE VENTING TABLES. IF AN 80% FURNACE IS COMMON VENTED WITH A DRAFT HOOD EQUIPPED APPLIANCE, THE POTENTIAL FOR CONDENSATION DAMAGE MAY STILL EXIST WITH EXTREMELY COLD CONDITIONS, LONG VENT CONNECTORS, EXTERIOR CHIMNEYS, OR ANY COMBINATION OF THESE CONDITIONS. THE RISK OF CONDENSATION DAMAGE IS BEST AVOIDED BY USING MASONRY CHIMNEY AS A PATHWAY FOR PROPERLY SIZED METAL LINER OR TYPE B METAL VENT.

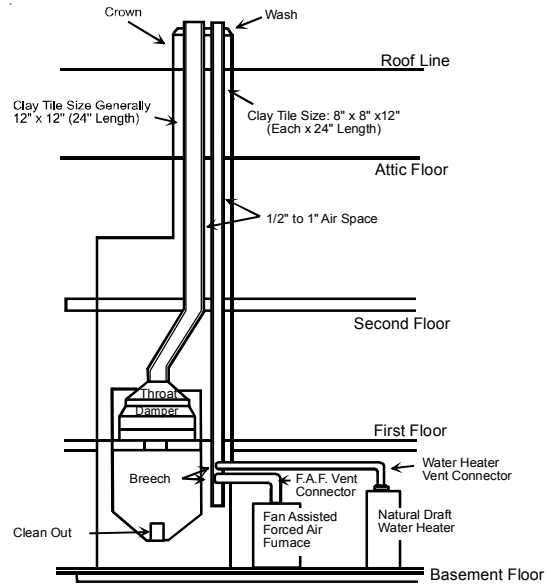

Typical Multiple Flue Clay Tile Chimney

CHECKLIST SUMMARY

This checklist serves as a summary of the items to be checked before venting an 80+ furnace into a masonry chimney. In addition, we recommend that a qualified serviceman use this checklist to perform a yearly inspection of the furnace venting system.

This checklist is only a summary. For detailed information on each of the procedures mentioned, see the paragraph referenced with each item.

This inspection is based upon a draft topical report, "Masonry Chimney Inspection and Relining", issued by the Gas Research Institute. While not yet finalized, we believe this report represents the best information on this subject which is currently available.

EXTERIOR MASONRY CHIMNEYS - CATEGORY I FURNACES ONLY

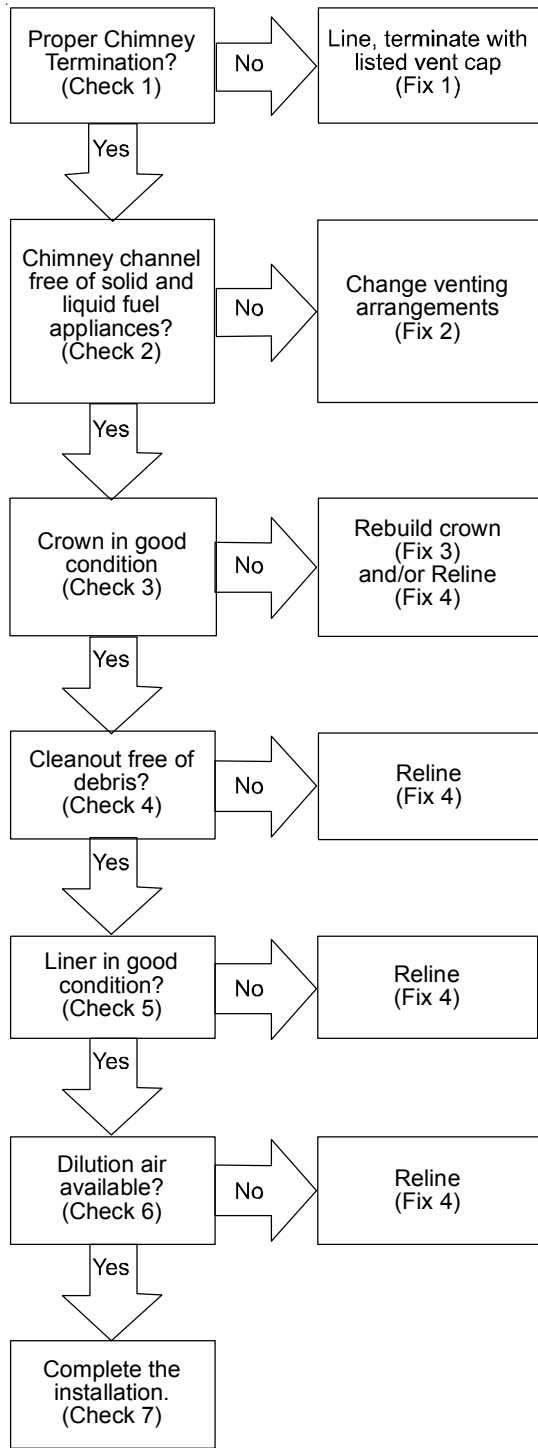

If the chimney does not meet these termination requirements, but all other requirements in the checklist can be met, it may be possible for a mason to extend the chimney. If this will not be practical, see Fix 1.

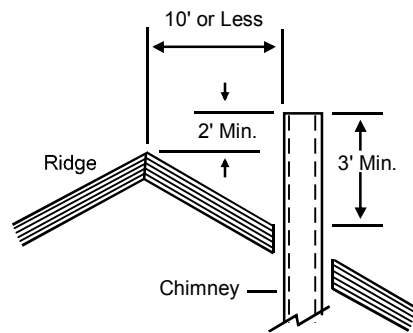
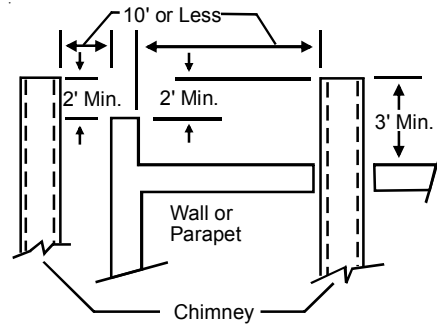

Termination 10 Feet Or Less From Ridge, Wall or Parapet

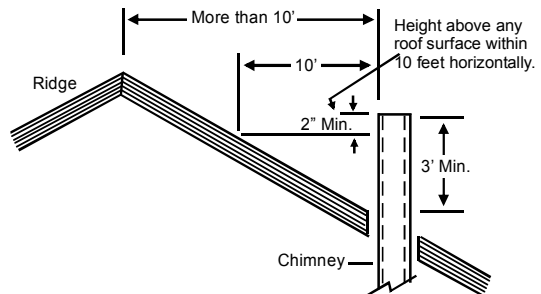
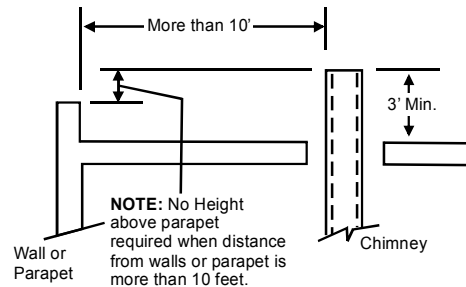

Termination More Than 10 Feet From Ridge, Wall or Parapet

CHECK 2 - ANY SOLID OR LIQUID FUEL APPLIANCES VENTED INTO THIS CHIMNEY CHANNEL

Solid fuel appliances include fireplaces, wood stoves, coal furnaces, and incinerators.

CHECK 1 - PROPER CHIMNEY TERMINATION.

A masonry chimney used as a vent for gas fired equipment must extend at least three feet above the highest point where it passes through the roof. It must extend at least two feet higher than any portion of a building within a horizontal distance of 10 feet. In addition, the chimney must terminate at least 3 feet above any forced air inlet located within 10 feet. The chimney must extend at least five feet above the highest connected equipment draft hood outlet or flue collar.

EXTERIOR MASONRY CHIMNEYS - CATEGORY I FURNACES ONLY

Liquid fuel appliances include oil furnaces, oil-fired boilers and oil-fired water heaters.

Appliances which burn propane (sometimes referred to as LP (liquefied petroleum)) gas are considered gas-fired appliances.

CHECK 3 - CHIMNEY CROWN CONDITION.

Damage from condensate usually shows up first in the crown. If any of the following trouble signs are present, the condition of the crown is not satisfactory:

- a) Crown leaning
- b) Bricks missing
- c) Mortar missing
- d) Tile liner cracked
- e) No tile liner
- f) Salt staining at mortar joints. (White stains, and mortar becomes sandy and/or erodes.)

For problems a, b, or c, see Fix 3. If problems d, e, or f are present, see Fix 4. **IMPORTANT:** It may be necessary to follow both Fix 3 and Fix 4.

CHECK 4 - DEBRIS IN CLEANOUT.

A cleanout (dropleg) must be present such that the upper edge of the cleanout cover is at least 12 inches below the lower edge of the lowest chimney inlet opening.

A chimney without a cleanout could become partially blocked by debris. If no cleanout is present, the chimney must be relined (Fix 4). Remove the cleanout cover, and examine the cleanout for debris. If significant amounts of any of the following are found:

- Fuel oil residue
- Bricks
- Mortar or sand
- Pieces of the tile liner
- Rusted pieces of the metallic liner - reline the chimney (Fix 4).

CHECK 5 - LINER CONDITION.

If a metal liner is present, it must be checked. It cannot be assumed that all existing metal liners are correctly installed and in good condition.

Remove the lowest existing vent connector, and examine the inside of the elbow or tee at the base of the liner. A small amount of soot may be considered acceptable, provided the installer vacuums it away. If rusted pieces of the liner have collected here, the metal liner must be removed and replaced (Fix 4).

Next, gently tap the inside of the liner with a Phillips screwdriver. If the screwdriver perforates the liner, or if the tapping does not sound like metal hitting metal, the liner must be removed and replaced (Fix 4).

Remember that all appliances must be vented inside the liner. Venting one appliance inside the liner and another appliance outside the liner is not acceptable.

Next, use a flashlight and small mirror to sight up the liner. B vent must be supported so as to not come into direct contact with the chimney walls or tile liner. If it is not, it can probably be rehung so as to be acceptable. A thimble or fire stop may be helpful here.

Flexible liners should be hung straight or nearly straight. If it is spiraled in the chimney and in good condition, it should be rehung. To do this, break the top seal; pull up and cut off the excess liner length, and refit the top seal. Use caution when doing this, as the cut edges of flexible liners may be sharp.

The surfaces of the liner must be physically sound. If gaps or holes are present, the metal liner must be removed and replaced (Fix 4). Finally, confirm that the metal liner is the correct size for the appliances to be installed. Use the GAMA tables and rules.

If a metal liner is not present, a clay tile liner must be present, or the chimney must be lined (Fix 4).

Use a flashlight and small mirror at the cleanout or vent connector to inspect the clay tile liner. If any of the following problems are present:

- Tile sections misaligned
- Tile sections missing
- Gaps between tile sections
- Signs of condensate drainage at the cleanout or vent connectors
- Mortar protruding from between tile sections
- Use of sewer pipe or drainage pipe rather than an approved fire clay tile reline the chimney (Fix 4).

Next, measure the size of the liner. It may be possible to do this from the cleanout. The liner must be at least as large as the minimum size established by the tables in National Fuel Gas Code NFPA 54/ANSI Z223.1 - latest edition and in the National Standard of Canada, CAN/CSA B149.1 and CAN/CSA B149.2 - latest editions and amendments. If the liner is too small or too large, then the chimney must be relined (Fix 4).

CHECK 6 - DILUTION AIR.

If gas-fired appliances are to be vented into a clay tile liner, a source of dilution air is required.

Dilution air cannot be obtained through:

- Induced draft appliances
- Natural draft appliances with vent dampers

Sufficient dilution air can ordinarily be obtained through the draft hood of a natural draft appliance only if the appliance's vent connector does not include a vent damper. If dilution air will not be available, the chimney must be relined (Fix 4).

CHECK 7 - COMPLETE THE INSTALLATION.

If Checks 1 through 6 have been satisfactory, and the liner is an acceptable size as determined by the tables in National Fuel

Gas Code NFPA 54/ANSI Z223.1 - latest edition and in the National Standard of Canada, CAN/CSA B149.1 and CAN/CSA B149.2 - latest editions and amendments, then the clay tile liner can probably be used as a vent for the gas appliances. However, the installer must keep in mind the following factors which may render the tile liner unsuitable for use as a vent:

- Extremely cold weather
- Long vent connectors
- Masonry chimneys with no air gap between the liner and the bricks. (In practice, this can be difficult to detect.)
- Exterior chimneys (The tables in National Fuel Gas Code NFPA 54/ANSI Z223.1 - latest edition and in the National Standard of Canada, CAN/CSA B149.1 and CAN/CSA B149.2 - latest editions and amendments assume interior chimneys.)

If, in the judgment of the local gas utility, installer, and/or local codes; one or more of the above factors is likely to present a problem, the chimney must be relined (Fix 4).

FIX 1 - LINER TERMINATION

Any cap or roof assembly used with a liner must be approved by the liner manufacturer for such use. The liner and cap/roof assembly must then terminate above the roof in accordance with the manufacturer's instructions.

In some cases, a shorter extension above the roof may be possible with a liner than would be required with a masonry chimney.

For further information on relining, see Fix 4.

FIX 2 - CHANGE VENTING ARRANGEMENTS

If the masonry chimney has more than one channel, it may be possible to vent the gas appliances into one channel and vent the solid or liquid fuel appliance(s) into another channel(s). Do not vent an 80+ Furnace inside of a metal liner with other appliances vented outside the liner.

Alternatively, the homeowner may agree to discontinue use of the fireplace (solid fuel appliance). If so, the tile liner must be cleaned to remove creosote buildup. The fireplace opening must then be permanently sealed.

If oil-fired appliance(s) are being replaced by gas-fired appliance(s), the tile liner must first be cleaned to remove the fuel oil residue.

If none of the above options is practical, the furnace may need to be vented vertically with a B Vent.

Under some conditions, a 90%+ furnace could be installed rather than an 80% furnace. The 90%+ furnace can be vented horizontally or vertically through PVC pipe.

FIX 3 - REBUILD THE CROWN

If the chimney crown is damaged, a qualified mason must repair it in accordance with nationally recognized building codes or standards. One such standard which may be referenced is the Standard for Chimneys, Fireplaces, Vents, and Solid Fuel Burning Appliances, ANSI/NFPA 211.

FIX 4 - RELINING

Relining options include B vent and flexible liners.

If the chimney has diagonal offsets, B vent probably cannot be used.

If B vent is to be used, it must be supported adequately. Supports (such as fire stops or thimbles) must be used to prevent the B vent from coming into direct contact with the tile liner or chimney walls. Direct contact would result in higher heat loss, with an increased possibility of poor venting system performance.

It is not acceptable to vent one appliance inside the B vent and other appliances outside. The excess space between the B vent and the chimney walls must be covered at the top of the chimney by a weatherproof, corrosion resistant flashing.

The B vent should then be topped with a listed vent cap. The listed vent cap will, when installed per the manufacturer's instructions, prevent problems due to rain, birds, or wind effects.

A B-vent installed as described in this section is considered to be an enclosed vent system, and the sizing tables in National Fuel Gas Code NFPA 54/ANSI Z223.1 - latest edition and in the National Standard of Canada, CAN/CSA B149.1 and CAN/CSA B149.2 - latest editions and amendments may be used.

If a flexible liner is to be used, it must be made of the proper materials:

- For most residential applications, an aluminum liner should be acceptable.
- If the combustion air supplied to the furnace will be contaminated with compounds containing chlorine or fluorine, a liner of AL 29-4C stainless steel should be used. Common sources of chlorine and fluorine compounds include indoor swimming pools and chlorine bleaches, paint strippers, adhesives, paints, varnishes, sealers, waxes (which are not yet dried) and solvents used during construction and remodeling. Various commercial and industrial processes may also be sources of chlorine/fluorine compounds.
- Heavier gauge 300 and 400 series stainless steel liners were developed for use with oil or solid fuel appliances. They are not suitable for use with gas-fired appliances. Flexible liners specifically intended and tested for gas applications are listed in the UL "Gas and Oil Equipment Directory". (UL Standard 1777).

For sizing of flexible liners, see Note 22 and the tables in the National Fuel Gas Code NFPA 54/ANSI Z223.1 - latest edition

and in the National Standard of Canada, CAN/CSA B149.1 and CAN/CSA B149.2 - latest editions and amendments.

To install the liner, read and follow the liner manufacturer's instructions and your local codes. Excess liner length should be pulled out of the chimney and cut off. Use caution when doing this, as the cut edges of flexible liners may be sharp. Do not spiral excess liner inside of the chimney. Support the liner as recommended by the liner manufacturer.

Some manufacturers of flexible liners offer an insulation sleeve designed to be added to the liner before it is installed in the chimney. (Poured insulation, either vermiculite or other materials, is no longer recommended.) Insulation will need to be added to the flexible liner if:

- It is required by the liner manufacturer's instructions.
- The previous liner was properly sized and installed, and suffered from condensation damage.
- It is required by your local building codes.

Even if none of those three conditions exist which require additional liner insulation, the installer may wish to consider it if:

- The local climate is very cold.
- The chimney is very tall.
- The vent connectors used are very long or have a large number of elbows.
- Local experience indicates that flexible liners installed without insulation are likely to have condensation problems.

Insulation must be selected and installed in accordance with the liner manufacturer's instructions.

Finally, cap the chimney and terminate the liner in accordance with the liner manufacturer's instructions.

ELECTRICAL CONNECTIONS

 **WARNING**

HIGH VOLTAGE !

TO AVOID THE RISK OF ELECTRICAL SHOCK, WIRING TO THE UNIT MUST BE POLARIZED AND GROUNDED.



 **WARNING**

HIGH VOLTAGE !

TO AVOID PERSONAL INJURY OR DEATH DUE TO ELECTRICAL SHOCK, DISCONNECT ELECTRICAL POWER BEFORE SERVICING OR CHANGING ANY ELECTRICAL WIRING.



 **CAUTION**

LABEL ALL WIRES PRIOR TO DISCONNECTION WHEN SERVICING CONTROLS. WIRING ERRORS CAN CAUSE IMPROPER AND DANGEROUS OPERATION. VERIFY PROPER OPERATION AFTER SERVICING.

 **WARNING**

HIGH VOLTAGE !

TO AVOID THE RISK OF INJURY, ELECTRICAL SHOCK OR DEATH, THE FURNACE MUST BE ELECTRICALLY GROUNDED IN ACCORDANCE WITH LOCAL CODES OR IN THEIR ABSENCE, WITH THE LATEST EDITION OF THE NATIONAL ELECTRIC CODE.



WIRING HARNESS

The wiring harness is an integral part of this furnace. Field alteration to comply with electrical codes should not be required. Wires are color coded for identification purposes. Refer to the wiring diagram for wire routings. If any of the original wire as supplied with the furnace must be replaced, it must be replaced with wiring material having a temperature rating of at least 105° C. Any replacement wiring must be a copper conductor.

115 VOLT LINE CONNECTIONS

Before proceeding with electrical connections, ensure that the supply voltage, frequency, and phase correspond to that specified on the unit rating plate. Power supply to the furnace must be NEC Class 1, and must comply with all applicable codes. The furnace must be electrically grounded in accordance with local codes or, in their absence, with the latest edition of The National Electric Code, ANSI NFPA 70 and/or The Canadian Electric Code CSA C22.1.

Use a separate fused branch electrical circuit containing properly sized wire, and fuse or circuit breaker. The fuse or circuit breaker must be sized in accordance with the maximum over-current protection specified on the unit rating plate. An electrical disconnect must be provided at the furnace location.

Connect hot, neutral, and ground wires as shown in the wiring diagram located on the unit's blower door.

Line polarity must be observed when making field connections. Line voltage connections can be made through either the right or left side panel. The furnace is shipped configured for a right side electrical connection with the junction box located inside the burner compartment (blower compartment for downflows). To make electrical connections through the opposite side of the furnace, the junction box must be relocated to the other side of the burner (or blower) compartment prior to making electrical connections. To relocate the junction box, follow the steps shown below.

NOTE: Wire routing must not to interfere with circulator blower operation, filter removal, or routine maintenance.

ELECTRICAL CONNECTIONS

JUNCTION BOX RELOCATION



WARNING

EDGES OF SHEET METAL HOLES MAY BE SHARP. USE GLOVES AS A PRECAUTION WHEN REMOVING HOLE PLUGS.

Line voltage connections can be made through either the right or left side panel. The furnace is shipped configured for a right side electrical connection. To make electrical connections through the opposite side of the furnace, the junction box must be relocated to the left side prior to making electrical connections. To relocate the junction box, perform the following steps.



WARNING

TO PREVENT PERSONAL INJURY OR DEATH DUE TO ELECTRIC SHOCK, DISCONNECT ELECTRICAL POWER BEFORE INSTALLING OR SERVICING THIS UNIT.

1. Remove both doors from the furnace.
2. Remove and save the screws holding the junction box to the right side of the furnace.
3. Models that have the junction box located in the burner or blower compartment will need to move the junction box directly over.
4. Attach the junction box to the left side of the furnace, using the screws removed in step 2.
5. Check the location of the wiring. Confirm that it will not be damaged by heat from the burners or by the rotation of the fan. Also confirm that wiring location will not interfere with filter removal or other maintenance.

After the junction box is in the desired location, use washers to connect field-supplied conduit to the junction box in accordance with NEC and local codes. Connect hot, neutral, and ground wires as shown in the furnace wiring diagram. The wires and ground screw are located in the furnace junction box.

NOTE: In downflow applications the power leads should be routed through the supplied wire tabs when locating junction box to the left side.

Low voltage wires may be connected to the terminal strip.

IMPORTANT NOTE: To avoid possible equipment malfunction, route the low voltage wires to avoid interference with filter removal or other maintenance.



WARNING

HIGH VOLTAGE !

TO AVOID THE RISK OF INJURY, ELECTRICAL SHOCK OR DEATH, THE FURNACE MUST BE ELECTRICALLY GROUNDED IN ACCORDANCE WITH LOCAL CODES OR IN THEIR ABSENCE, WITH THE LATEST EDITION OF THE NATIONAL ELECTRIC CODE.



To ensure proper unit grounding, the ground wire should run from the furnace ground screw located inside the furnace junction box all the way back to the electrical panel. **NOTE:** Do not use gas piping as an electrical ground. To confirm proper unit grounding, turn off the electrical power and perform the following check.

1. Measure resistance between the neutral (white) connection and one of the burners.
2. Resistance should measure 10 ohms or less.

This furnace is equipped with a blower door interlock switch which interrupts unit voltage when the blower door is opened for servicing. Do not defeat this switch.

24 VOLT THERMOSTAT WIRING

IMPORTANT NOTE

WIRE ROUTING MUST NOT INTERFERE WITH CIRCULATOR BLOWER OPERATION, FILTER REMOVAL OR ROUTINE MAINTENANCE.

A REMOVABLE PLUG CONNECTOR IS PROVIDED WITH THE CONTROL TO MAKE THERMOSTAT WIRE CONNECTIONS. THIS PLUG MAY BE REMOVED, WIRE CONNECTIONS MADE TO THE PLUG, AND REPLACED. IT IS **STRONGLY** RECOMMENDED THAT MULTIPLE WIRES INTO A SINGLE TERMINAL BE TWISTED TOGETHER PRIOR TO INSERTING INTO THE PLUG CONNECTOR. FAILURE TO DO SO MAY RESULT IN INTERMITTENT OPERATION.

As a two-stage non-communicating furnace, the furnace integrated control module provides terminals for both "W1" and "W2", and "Y1" and "Y2" thermostat connections. This allows the furnace to support the following system applications: 'Two-Stage Heating Only', 'Two-Stage Heating with Single Stage Cooling', and 'Two-Stage Heating with Two-Stage Cooling'. Refer to the following figures for proper connections to the integrated control module.

Low voltage connections can be made through either the right or left side panel. Thermostat wiring entrance holes are located in the blower compartment. The following figure shows connections for a "heat/cool system".

This furnace is equipped with a 40 VA transformer to facilitate use with most cooling equipment. Consult the wiring diagram, located on the blower compartment door, for further details of 115 Volt and 24 Volt wiring.

NOTE: For single stage cooling applications, a jumper must be located between Y1 and Y2 at the furnace control in order to achieve the desired single stage cooling airflow. Use of ramping profiles and dehumidification features require a jumper between Y1 and O and Y1 and DEHUM, respectively.

NOTE: Thermostat "R" required if outdoor unit is equipped with a Comfort Alert™ module or if the outdoor unit is a part of the ComfortNet™ family of equipment AND is wired as a legacy system.

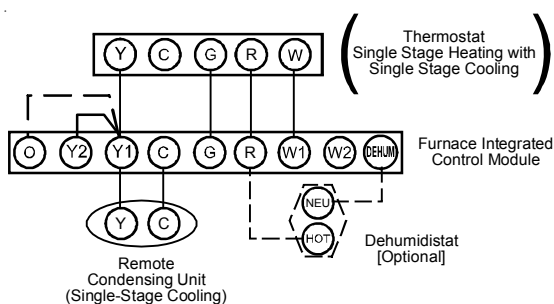

Single Stage Heating with Single Stage Cooling

NOTE: To apply a single-stage Heating Thermostat, the thermostat selector switch on the Integrated Control Module *must* be set on single-stage.

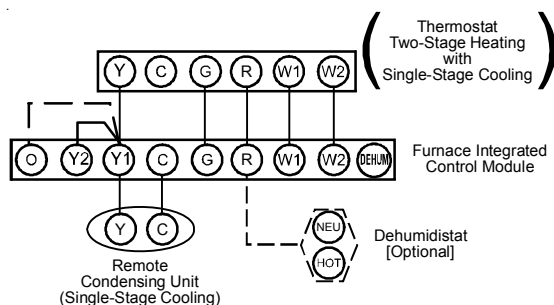

Two-Stage Heating with Single-Stage Cooling

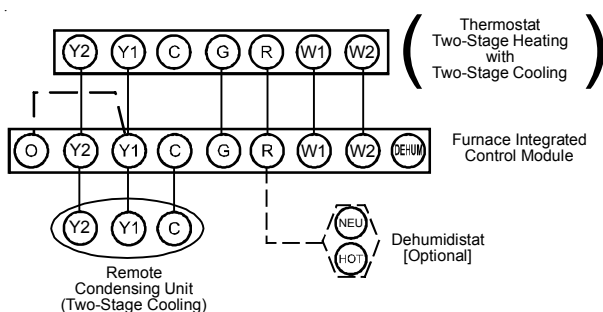

Two-Stage Heating with Two-Stage Cooling

Thermostat Wiring Diagrams

SINGLE-STAGE HEATING THERMOSTAT APPLICATION

A single-stage thermostat with only one heating stage may be used to control this furnace. The application of a single-stage thermostat offers a *timed* transition from low to high fire. The furnace will run on low stage for a fixed period of time before stepping up to high stage to satisfy the thermostat's call for heat. The delay period prior to stepping up can be set at either a fixed 5 minute time delay or a load based variable time between 1 and 12 minutes (AUTO mode). If the AUTO mode is selected, the control averages the cycle times of the previous three cycles and uses the average to determine the time to transition from low stage to high stage.

To use a single-stage thermostat, turn off power to the furnace, move the thermostat selection DIP switch to the OFF position. Set the desired transition time by setting the transition delay

DIP switch to the desired ON/OFF position. Turn power back on. Refer to the following figure.

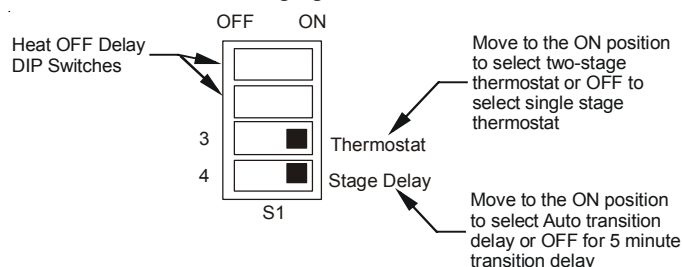

24 VOLT DEHUMIDISTAT WIRING

The optional usage of a dehumidistat allows the furnace's circulator blower to operate at a slightly lower speed (85% of desired speed) during a combined thermostat call for cooling and dehumidistat call for dehumidification. This can be done through an independent dehumidistat or through a thermostat's DEHUM terminal (if available). This lower blower speed enhances dehumidification of the conditioned air as it passes through the AC coil. For proper function, a dehumidistat applied to this furnace must operate on 24 VAC and utilize a switch which *opens on humidity rise*. Refer to the "Thermostat Wiring Diagrams" figure for additional wiring details.

To install/connect a dehumidistat:

1. Turn OFF power to furnace.
2. Secure the dehumidistat neutral wire (typically the white lead) to the terminal marked "DEHUM" on the furnace integrated control module.
3. Secure the dehumidistat hot wire (typically the black lead) to the terminal marked "R" on the furnace integrated control module.
4. Secure the dehumidistat ground wire (typically the green lead) to the ground screw on the furnace junction box. **NOTE:** Ground wire may not be present on all dehumidistats.
5. Turn ON power to furnace.

To enable the dehumidify function on the integrated control module, set the dehumidification ENABLE dipswitch from OFF to ON.

Once the switch is set, the dehumidify function is enabled during a *combination* call for cooling (T-Stat) and dehumidification (DEHUM-Stat).

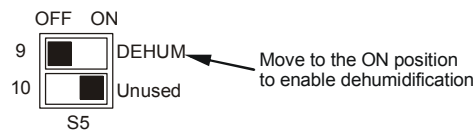

FOSSIL FUEL APPLICATIONS

This furnace can be used in conjunction with a heat pump in a fossil fuel application. A fossil fuel application refers to a combined gas furnace and heat pump installation which uses an outdoor temperature sensor to determine the most cost efficient means of heating (heat pump or gas furnace).

GAS SUPPLY AND PIPING

A heat pump thermostat with *three stages of heat* is required to properly use a two-stage furnace in conjunction with a heat pump. Refer to the fossil fuel kit installation instructions for additional thermostat requirements.

Strictly follow the wiring guidelines in the fossil fuel kit installation instructions. All furnace connections must be made to the furnace two-stage integrated control module and the "FURNACE" terminal strip on the fossil fuel control board.

115 VOLT LINE CONNECTION OF ACCESSORIES (HUMIDIFIER AND ELECTRONIC AIR CLEANER)



WARNING

HIGH VOLTAGE !

TO AVOID PERSONAL INJURY OR DEATH DUE TO ELECTRICAL SHOCK, DISCONNECT ELECTRICAL POWER BEFORE SERVICING OR CHANGING ANY ELECTRICAL WIRING.



The furnace integrated control module is equipped with line voltage accessory terminals for controlling power to an optional field-supplied humidifier and/or electronic air cleaner.

The accessory load specifications are as follows:

Humidifier	1.0 Amp maximum at 120 VAC
Electronic Air Cleaner	1.0 Amp maximum at 120 VAC

Turn OFF power to the furnace before installing any accessories. Follow the humidifier or air cleaner manufacturers' instructions for locating, mounting, grounding, and controlling these accessories. Accessory wiring connections are to be made through the 1/4" quick connect terminals provided on the furnace integrated control module. The humidifier and electronic air cleaner hot terminals are identified as HUM and EAC. The humidifier and electronic air cleaner neutral terminals are identified as NEUTRAL. All field wiring must conform to applicable codes. Connections should be made as shown.

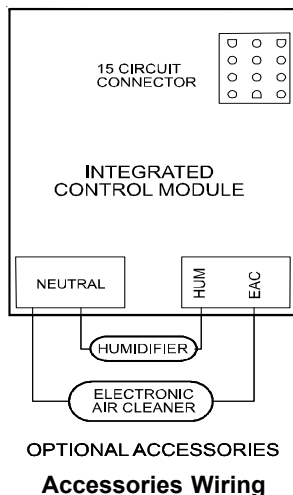

If it is necessary for the installer to supply additional line voltage wiring to the inside of the furnace, the wiring must conform

to all local codes, and have a minimum temperature rating of 105°C. All line voltage wire splices must be made inside the furnace junction box.

The integrated control module humidifier terminals (HUM) are energized with 115 volts whenever the induced draft blower is energized. The integrated control module electronic air cleaner terminals (EAC) are energized with 115 volts whenever the circulator blower is energized.

24 VOLT HUMIDIFIER

A 5" long brown wire in the wire harness at the low fire pressure switch provides 24 VAC humidifier control. This wire is powered any time the pressure switch is closed. To connect 24 VAC HUM, connect the 24 VAC line of the humidifier to the 5" brown wire. The connection can be made by either stripping the wire and using a wire nut or by using a field supplied quick connect terminal. The wiring must conform to all local and national codes. Connect the COM side of the humidifier to the C terminal on the furnace control board (or to the COM side of the 24 VAC transformer). Do not connect 115V humidifier to these terminals.

GAS SUPPLY AND PIPING

The furnace rating plate includes the approved furnace gas input rating and gas types. The furnace must be equipped to operate on the type of gas applied. This includes any conversion kits required for alternate fuels and/or high altitude.



CAUTION

TO PREVENT UNRELIABLE OPERATION OR EQUIPMENT DAMAGE, THE INLET GAS SUPPLY PRESSURE MUST BE AS SPECIFIED ON THE UNIT RATING PLATE WITH ALL OTHER HOUSEHOLD GAS FIRED APPLIANCES OPERATING.

Inlet gas supply pressures must be maintained within the ranges specified in the following table. The supply pressure must be constant and available with all other household gas fired appliances operating. The minimum gas supply pressure must be maintained to prevent unreliable ignition. The maximum must not be exceeded to prevent unit overfiring.

Inlet Gas Supply Pressure		
Natural Gas	Minimum: 5.0" w.c.	Maximum: 10.0" w.c.
Propane Gas	Minimum: 11.0" w.c.	Maximum: 13.0" w.c.

NOTE: Adjusting the minimum supply pressure below the limits in the above table could lead to unreliable ignition. Gas input to the burners must not exceed the rated input shown on the rating plate. Overfiring of the furnace can result in premature heat exchanger failure. Gas pressures in excess of 13 inches water column can also cause permanent damage to the gas valve.

At all altitudes, the manifold pressure must be within 0.3 inches w.c. of that listed in the Specification Sheet applicable to your model for the fuel used. At all altitudes and with either fuel, the

air temperature rise must be within the range listed on the furnace nameplate. Should this appliance be converted to LP, refer to the instructions included in the factory authorized LP conversion kit.

HIGH ALTITUDE DERATE

IMPORTANT NOTE: The furnace will naturally derate itself with altitude. Do not attempt to increase the firing rate by changing orifices or increasing the manifold pressure. This can cause poor combustion and equipment failure.

High altitude installations may require both a pressure switch and an orifice change. These changes are necessary to compensate for the natural reduction in the density of both the gas fuel and the combustion air at higher altitude.

For installations above 7000 feet, please refer to your distributor for required kit(s).

Gas	Altitude	Kit	Orifice	Manifold Pressure		Pressure Switch Change
				High Stage	Low Stage	
Natural	0-7000	None	#43	3.5" w.c.	1.9" w.c.	None
Propane		LPM-05* ¹ LPM-06* ²	#55	10.0" w.c.	6.0" w.c.	None

¹ LPM-05* supports White-Rodgers 2-stage valve only

² LPM-06* supports Honeywell and White-Rodgers 2-stage valves

NOTE: In Canada, gas furnaces are only certified to 4500 feet.

Contact the distributor for a tabular listing of appropriate manufacturer's kits for propane gas and/or high altitude installations. The indicated kits must be used to insure safe and proper furnace operation. All conversions must be performed by a qualified installer, or service agency.

PROPANE GAS CONVERSION

 **WARNING**

POSSIBLE PROPERTY DAMAGE, PERSONAL INJURY OR DEATH MAY OCCUR IF THE CORRECT CONVERSION KITS ARE NOT INSTALLED. THE APPROPRIATE KITS MUST BE APPLIED TO ENSURE SAFE AND PROPER FURNACE OPERATION. ALL CONVERSIONS MUST BE PERFORMED BY A QUALIFIED INSTALLER OR SERVICE AGENCY.

This unit is configured for natural gas. The appropriate manufacturer's propane gas conversion kit, must be applied for propane gas installations. Refer to the "Propane Gas and/or High Altitude Installations" section for details.

Contact your distributor for a tabular listing of appropriate manufacturer's kits for propane gas and/or high altitude installations. The indicated kits must be used to insure safe and proper furnace operation. All conversions must be performed by a qualified installer, or service agency.

GAS PIPING CONNECTIONS

 **WARNING**

TO AVOID POSSIBLE UNSATISFACTORY OPERATION OF EQUIPMENT DAMAGE DUE TO UNDERFIRING OR EQUIPMENT, USE THE PROPER SIZE OF NATURAL/PROPANE GAS PIPING NEEDED WHEN RUNNING PIPE FROM THE METER/TANK TO THE FURNACE.

When sizing a trunk line, be sure to include all appliances which will operate simultaneously.

The gas piping supplying the furnace must be properly sized based on the gas flow required, specific gravity of the gas, and length of the run. The gas line installation must comply with local codes, or in their absence, with the latest edition of the National Fuel Gas Code, NFPA 54/ANSI Z223.1.

**Natural Gas Capacity of Pipe
In Cubic Feet of Gas Per Hour (CFH)**

Length of Pipe in Feet	Nominal Black Pipe Size				
	1/2"	3/4"	1"	1 1/4"	1 1/2"
10	132	278	520	1050	1600
20	92	190	350	730	1100
30	73	152	285	590	980
40	63	130	245	500	760
50	56	115	215	440	670
60	50	105	195	400	610
70	46	96	180	370	560
80	43	90	170	350	530
90	40	84	160	320	490
100	38	79	150	305	460

(Pressure 0.5 psig or less and pressure drop of 0.3" W.C.; Based on 0.60 Specific Gravity Gas)

$$CFH = \frac{BTUH \text{ Furnace Input}}{\text{Heating Value of Gas (BTU/Cubic Foot)}}$$

To connect the furnace to the building's gas piping, the installer must supply a ground joint union, drip leg, manual shutoff valve, and line and fittings to connect to gas valve. In some cases, the installer may also need to supply a transition piece from 1/2" pipe to a larger pipe size.

The following stipulations apply when connecting gas piping.

- Use black iron or steel pipe and fittings for the building piping.
- Use pipe joint compound on male threads only. Pipe joint compound must be resistant to the action of the fuel used.
- Use ground joint unions.
- Install a drip leg to trap dirt and moisture before it can enter the gas valve. The drip leg must be a minimum of three inches long.
- Install a 1/8" NPT pipe plug fitting, accessible for test gage connection, immediately upstream of the gas supply connection to the furnace.
- Use two pipe wrenches when making connection to the gas valve to keep it from turning. The orientation of the gas valve on the manifold must be maintained as shipped from the factory.

GAS SUPPLY AND PIPING

- Install a manual shutoff valve between the gas meter and unit within six feet of the unit. If a union is installed, the union must be downstream of the manual shutoff valve, between the shutoff valve and the furnace.
- Tighten all joints securely.
- Connect the furnace to the building piping by one of the following methods:
 - Rigid metallic pipe and fittings.
 - Semi-rigid metallic tubing and metallic fittings. Aluminum alloy tubing must not be used in exterior locations.
 - Use listed gas appliance connectors in accordance with their instructions. Connectors must be fully in the same room as the furnace.
 - Protect connectors and semi-rigid tubing against physical and thermal damage when installed. Ensure aluminum-alloy tubing and connectors are coated to protect against external corrosion when in contact with masonry, plaster, or insulation, or subjected to repeated wetting by liquids such as water (except rain water), detergents, or sewage.

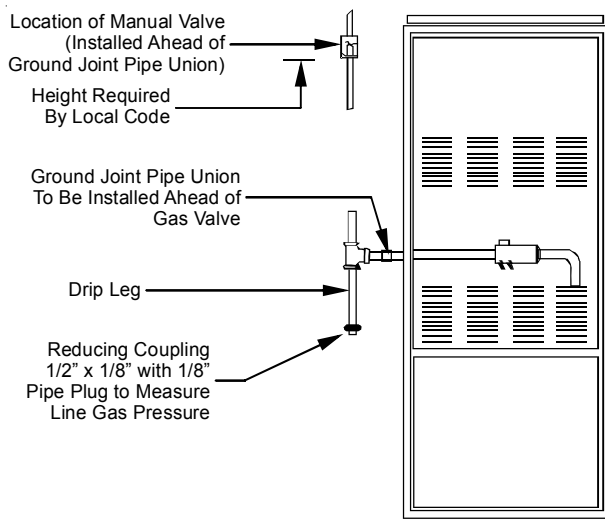

General Furnace Layout

UPFLOW INSTALLATIONS

When the gas piping enters through the right side of the furnace, the installer must supply the following fittings (starting from the gas valve):

- Close nipple.
- 90 degree elbows.
- Straight pipe to reach the exterior of the furnace.

A ground joint union, drip leg, and manual shutoff valve must also be supplied by the installer. In some cases, the installer may also need to supply a transition piece from 1/2" to another pipe size.

When the gas piping enters through the left side of the furnace, the installer must supply the following fittings (starting from the gas valve):

- 90 degree elbow.
- Straight pipe to reach the exterior of the furnace.
- A ground joint union, drip leg, and manual shutoff valve must also be supplied by the installer. In some cases, the installer may also need to supply a transition piece from 1/2 inch to another pipe size.

COUNTERFLOW INSTALLATIONS

When the gas piping enters through the left side of the furnace, the installer must supply a straight pipe and a 90 degree elbow to reach the exterior of the furnace.

A ground joint union, drip leg and manual shutoff valve must also be supplied by the installer. In most cases, the installer may also need to supply a transition piece from 1/2" to another pipe size. When the gas piping enters through the right side of the furnace, the installer must supply the following fittings (starting at the gas valve):

- Close Nipple
- 90 Degree Elbow
- Straight Pipe to Reach Exterior of Furnace.

GAS PIPING CHECKS

Before placing unit in operation, leak test the unit and gas connections.

WARNING

TO AVOID THE POSSIBILITY OF EXPLOSION OR FIRE, NEVER USE A MATCH OR OPEN FLAME TO TEST FOR LEAKS.

Check for leaks using an approved chloride-free soap and water solution, an electronic combustible gas detector, or other approved testing methods.

CAUTION

TO PREVENT PROPERTY DAMAGE OR PERSONAL INJURY DUE TO FIRE, THE FOLLOWING INSTRUCTIONS MUST BE PERFORMED REGARDING GAS CONNECTIONS, PRESSURE TESTING, LOCATION OF SHUTOFF VALVE AND INSTALLATION OF GAS PIPING.

NOTE: Never exceed specified pressures for testing. Higher pressure may damage the gas valve and cause subsequent overfiring, resulting in heat exchanger failure.

Disconnect this unit and shutoff valve from the gas supply piping system before pressure testing the supply piping system with pressures in excess of 1/2 psig (3.48 kPa).

This unit must be isolated from the gas supply system by closing its manual shutoff valve before pressure testing of gas supply piping system with test pressures equal to or less than 1/2 psig (3.48 kPa).

PROPANE GAS TANKS AND PIPING

⚠ WARNING

IF THE GAS FURNACE IS INSTALLED IN A BASEMENT, AN EXCAVATED AREA OR CONFINED SPACE, IT IS STRONGLY RECOMMENDED TO CONTACT A PROPANE SUPPLIER TO INSTALL A GAS DETECTING WARNING DEVICE IN CASE OF A GAS LEAK.

- SINCE PROPANE GAS IS HEAVIER THAN AIR, ANY LEAKING GAS CAN SETTLE IN ANY LOW AREAS OR CONFINED SPACES.
- PROPANE GAS ODORANT MAY FADE, MAKING THE GAS UNDETECTABLE EXCEPT WITH A WARNING DEVICE.

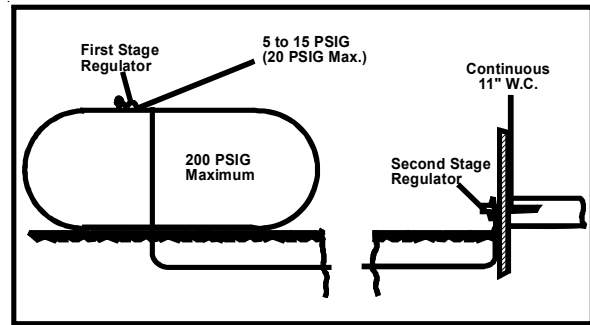

Propane Gas Installation (Typ.)

A gas detecting warning system is the only reliable way to detect a propane gas leak. Rust can reduce the level of odorant in propane gas. Do not rely on your sense of smell. Contact a local propane gas supplier about installing a gas detecting warning system. If the presence of gas is suspected, follow the instructions on Page 3 of this manual.

All propane gas equipment must conform to the safety standards of the National Board of Fire Underwriters, NBFU Manual 58.

For satisfactory operation, propane gas pressure must be 10 inch WC at the furnace manifold with all gas appliances in operation. Maintaining proper gas pressure depends on three main factors:

1. Vaporization rate, depending on temperature of the liquid, and "wetted surface" area of the container or containers.
2. Proper pressure regulation. (Two-stage regulation is recommended for both cost and efficiency).
3. Pressure drop in lines between regulators, and between second stage regulator and the appliance. Pipe size will depend on length of pipe run and total load of all appliances.

Complete information regarding tank sizing for vaporization, recommended regulator settings, and pipe sizing is available from most regulator manufacturers and propane gas suppliers.

Since propane gas will quickly dissolve white lead and most standard commercial compounds, special pipe dope must be used. Shellac-based compounds resistant to the actions of liquefied petroleum gases such as Gasolac®, Stalactic®, Clyde's® or John Crane® are satisfactory.

Refer to the following illustration for typical propane gas installations and piping.

PROPANE GAS PIPING CHARTS

Sizing Between First and Second Stage Regulator*
 Maximum Propane Capacities listed are based on 2 psig pressure drop at 10 psig setting.
 Capacities in 1,000 BTU/hour.

Pipe or Tubing Length, Feet	Tubing Size, O.D. Type L					Nominal Pipe Size Schedule 40	
	3/8"	1/2"	5/8"	3/4"	7/8"	1/2"	3/4"
10	730	1,700	3,200	5,300	8,300	3,200	7,500
20	500	1,100	2,200	3,700	5,800	2,200	4,200
30	400	920	2,000	2,900	4,700	1,800	4,000
40	370	850	1,700	2,700	4,100	1,600	3,700
50	330	770	1,500	2,400	3,700	1,500	3,400
60	300	700	1,300	2,200	3,300	1,300	310
80	260	610	1,200	1,900	2,900	1,200	2,600
100	220	540	1,000	1,700	2,600	1,000	2,300
125	200	490	900	1,400	2,300	900	2,100
150	190	430	830	1,300	2,100	830	1,900
175	170	400	780	1,200	1,900	770	1,700
200	160	380	730	1,100	1,800	720	1,500

Sizing Between Second Stage and Appliance Regulator*
 Maximum Propane Capacities listed are based on 2 psig pressure drop at 10 psig setting.
 Capacities in 1,000 BTU/hour.

Pipe or Tubing Length, Feet	Tubing Size, O.D. Type L						Nominal Pipe Size Schedule 40				
	3/8"	1/2"	5/8"	3/4"	7/8"	1-1/8"	1/2"	3/4"	1"	1-1/4"	1-1/2"
10	39	92	199	329	501	935	275	567	1,071	2,205	3,307
20	26	62	131	216	346	630	189	393	732	1,496	2,299
30	21	50	107	181	277	500	152	315	590	1,212	1,858
40	19	41	90	145	233	427	129	267	504	1,039	1,559
50	18	37	79	131	198	376	114	237	448	91	1,417
60	16	35	72	121	187	340	103	217	409	834	1,275
80	13	29	62	104	155	289	89	185	346	724	1,066
100	11	26	55	90	138	255	78	162	307	630	976
125	10	24	48	81	122	224	69	146	275	567	866
150	9	21	43	72	109	202	63	132	252	511	787
200	8	19	39	66	100	187	54	112	209	439	665
250	8	17	36	60	93	172	48	100	185	390	590

CIRCULATING AIR AND FILTERS

⚠ WARNING

NEVER ALLOW THE PRODUCTS OF COMBUSTION, INCLUDING CARBON MONOXIDE, TO ENTER THE RETURN DUCT WORK OR CIRCULATION AIR SUPPLY.

Duct systems and register sizes must be properly designed for the CFM and external static pressure rating of the furnace. Ductwork should be designed in accordance with the recommended methods of "Air Conditioning Contractors of America" Manual D.

A duct system must be installed in accordance with Standards of the National Board of Fire Underwriters for the Installation of Air Conditioning, Warm Air Heating and Ventilating Systems. Pamphlets No. 90A and 90B.

START-UP PROCEDURE AND ADJUSTMENT

A closed return duct system must be used, with the return duct connected to the furnace. **NOTE:** Ductwork must never be attached to the back of the furnace. For installations requiring more than 1800 CFM, use a bottom return or two sided return. Supply and return connections to the furnace may be made with flexible joints to reduce noise transmission. To prevent the blower from interfering with combustion air or draft when a central return is used, a connecting duct must be installed between the unit and the utility room wall. A room, closet, or alcove must not be used as a return air chamber.

When the furnace is used in connection with a cooling unit, the furnace should be installed in parallel with or on the upstream side of the cooling unit to avoid condensation in the heating element. With a parallel flow arrangement, the dampers or other means used to control the flow of air must be adequate to prevent chilled air from entering the furnace and, if manually operated, must be equipped with means to prevent operation of either unit unless the damper is in the full heat or cool position.

When the furnace is installed without a cooling coil, it is recommended that a removable access panel be provided in the outlet air duct. This opening shall be accessible when the furnace is installed and shall be of such a size that the heat exchanger can be viewed for visual light inspection or such that a sampling probe can be inserted into the airstream. The access panel must be made to prevent air leaks when the furnace is in operation.

When the furnace is heating, the temperature of the return air entering the furnace must be between 55°F and 100°F.

When a furnace is installed so that supply ducts carry air circulated by the furnace to areas outside the space containing the furnace, the return air shall also be handled by a duct sealed to the furnace casing and terminating outside the space containing the furnace.

CHECKING DUCT STATIC

Refer to your furnace rating plate for the maximum ESP (external duct static) rating.

Total external static refers to everything external to the furnace cabinet. Cooling coils, filters, ducts, grilles, registers must all be considered when reading your total external static pressure. The supply duct pressure must be read between the furnace and the cooling coil. This reading is usually taken by removing the "A" shaped block off plate from the end on the coil; drilling a test hole in it and reinstalling the block off plate. Take a duct static reading at the test hole. Tape up the test hole after your test is complete. The negative pressure must be read between the filter and the furnace blower.

Too much external static pressure will result in insufficient air that can cause excessive temperature rise. This can cause limit switch tripping and heat exchanger failure.

To determine total external duct static pressure, proceed as follows;

1. With clean filters in the furnace, use a draft gauge (inclined manometer) to measure the static pressure of the return duct at the inlet of the furnace. (Negative Pressure)
2. Measure the static pressure of the supply duct. (Positive Pressure)
3. The difference between the two numbers is .4" w.c.

Example:

static reading from return duct = - .1" w.c.

static reading from supply duct = .3" w.c.

total external static pressure on this system = .4" w.c.

NOTE: Both readings may be taken simultaneously and read directly on the manometer if so desired. If an air conditioner coil or Electronic Air Cleaner is used in conjunction with the furnace, the readings must also include these components, as shown in the following drawing.

4. Consult proper tables for the quantity of air.

If the total external static pressure exceeds the maximum listed on the furnace rating plate, check for closed dampers, registers, undersized and/or oversized poorly laid out duct work.

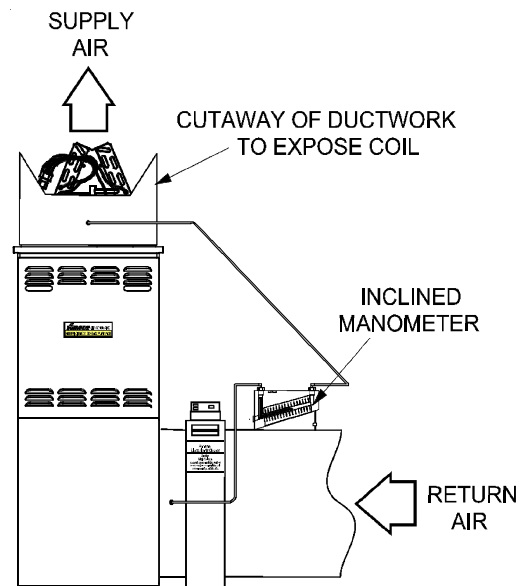

Checking Static Pressure
(80% Furnace Shown, 90% Similar)

FILTERS - READ THIS SECTION BEFORE INSTALLING THE RETURN AIR DUCTWORK

Filters must be used with this furnace. Discuss filter maintenance with the building owner. Filters do not ship with this furnace, but must be provided by the installer. Filters must com-

START-UP PROCEDURE AND ADJUSTMENT

ply with UL900 or CAN/ULCS111 standards. If the furnace is installed without filters, the warranty will be voided.

NOTE: An undersized opening will cause reduced airflow. The bottom return is set up as a knock out.

UPRIGHT INSTALLATIONS

Depending on the installation and/or customer preference, differing filter arrangements can be applied. Filters can be installed in the central return register or a side panel external filter rack kit (upflows), or the ductwork above a downflow furnace. As an alternative, a media air filter or electronic air cleaner can be used as the primary filter.

CIRCULATION AIR FILTERS

One of the most common causes of a problem in a forced air heating system is a blocked or dirty filter. Circulating air filters must be inspected monthly for dirt accumulation and replaced if necessary. Failure to maintain clean filters can cause premature heat exchanger failure.

A new home may require more frequent replacement until all construction dust and dirt is removed. Circulating air filters are to be installed in the return air duct external to the furnace cabinet.

MINIMUM FILTER SIZES for DISPOSABLE FILTERS

FURNACE INPUT	FILTER SIZE
70M	768 in ²
90M	960 in ²
115M	1022 in ²

DISPOSABLE NOMINAL 300 F.M. FACE VELOCITY

HORIZONTAL INSTALLATIONS

Filters must be installed in either the central return register or in the return air duct work.

START-UP PROCEDURE AND ADJUSTMENT

Furnace must have a 115 VAC power supply properly connected and grounded. Proper polarity must be maintained for correct operation. In addition to the following start-up and adjustment items, refer to further information in *Operational Checks* section.

HEAT ANTICIPATOR SETTING

The heat anticipator in the room thermostat must be correctly adjusted to obtain the proper number of cycles per hour and to prevent "overshooting" of the setting. Set the heat anticipator setting to 0.7 amps. Follow the thermostat manufacturer's instructions on how to adjust the heat anticipator setting.

FURNACE OPERATION

Purge gas lines of air prior to startup. Be sure not purge lines into an enclosed burner compartment.

Check for leaks using an approved chloride-free soap and water solution, an electronic combustible gas detector, or other

approved method. Verify that all required kits (propane gas, high altitude, etc.) have been appropriately installed.

FURNACE STARTUP

1. Close the manual gas shutoff valve external to the furnace.
2. Turn off the electrical power to the furnace.
3. Set the room thermostat to the lowest possible setting.
4. Remove the burner compartment door.

NOTE: This furnace is equipped with an ignition device which automatically lights the burner. Do not try to light the burner by hand.

5. Move the furnace gas valve manual control to the OFF position.
6. Wait five minutes then smell for gas. Be sure check near the floor as some types of gas are heavier than air.
7. If you smell gas after five minutes, immediately follow the *Safety Instructions* on page 2 of this manual. If you do not smell gas after five minutes, move the furnace gas valve manual control to the ON position.
8. Replace the burner compartment door.
9. Open the manual gas shutoff valve external to the furnace.
10. Turn on the electrical power to the furnace.
11. Adjust the thermostat to a setting above room temperature.
12. After the burners are lit, set the thermostat to desired temperature.

FURNACE SHUTDOWN

1. Set the thermostat to the lowest setting.
The integrated control will close the gas valve and extinguish flame. Following a 15 second delay, the induced draft blower will be de-energized. After a 120, 150, 180 or 210-second delay period (field selectable delay OFF [90, 120, 150, 180] plus 30-second ramp down), the circulator blower de-energizes.
2. Remove the burner compartment door and move the furnace gas valve manual control to the OFF position.
3. Close the manual gas shutoff valve external to the furnace.
4. Replace the burner compartment door.

GAS SUPPLY PRESSURE MEASUREMENT

CAUTION

TO PREVENT UNRELIABLE OPERATION OR EQUIPMENT DAMAGE, THE INLET GAS SUPPLY PRESSURE MUST BE AS SPECIFIED ON THE UNIT RATING PLATE WITH ALL OTHER HOUSEHOLD GAS FIRED APPLIANCES OPERATING.

The line pressure supplied to the gas valve must be within the range specified below. The supply pressure can be measured at the gas valve inlet pressure boss or at a hose fitting installed in the gas piping drip leg. The supply pressure must be measured with the burners operating. To measure the gas supply pressure, use the following procedure.

START-UP PROCEDURE AND ADJUSTMENT

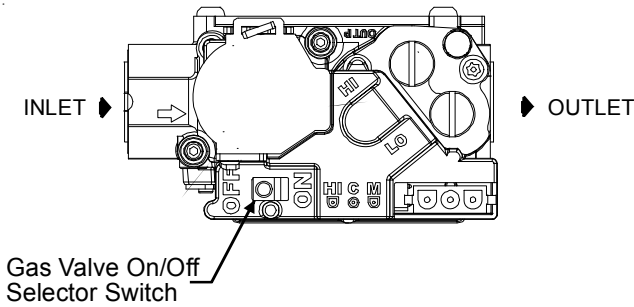

White-Rodgers Model 36G54 (Two-Stage)

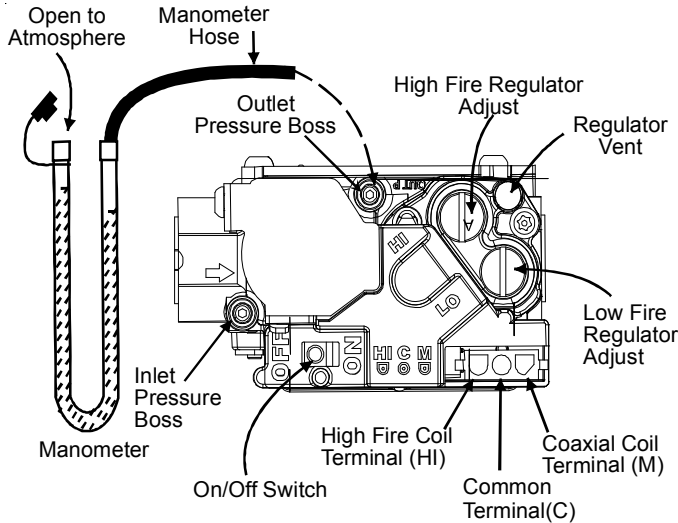
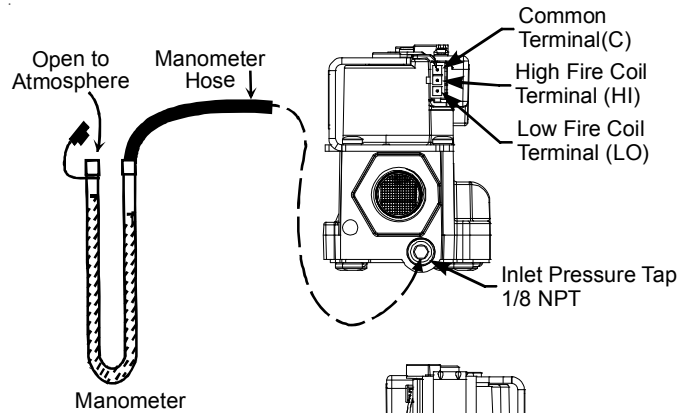

White-Rodgers Model 36G54 Connected to Manometer

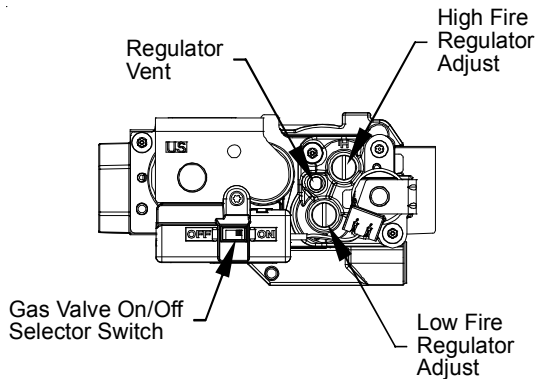

Honeywell Model VR9205 (Two-Stage)

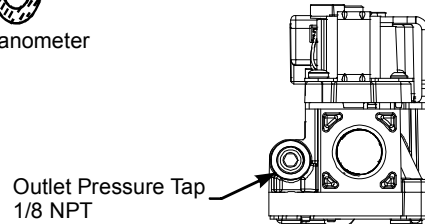

Honeywell Model VR9205 Connected to Manometer

1. Turn OFF gas to furnace at the manual gas shutoff valve external to the furnace.
2. Connect a calibrated water manometer (or appropriate gas pressure gauge) at either the gas valve inlet pressure boss or the gas piping drip leg. See Honeywell VR9205 gas valve figure or White-Rodgers 36G54 gas valve figure for location of inlet pressure boss.

NOTE: If measuring gas pressure at the drip leg or Honeywell VR9205 gas valve, a field-supplied hose barb fitting must be installed prior to making the hose connection. If using the inlet pressure boss on the White-Rodgers 36G54 gas valve, then use the 36G Valve Pressure Check Kit, Goodman Part No. 0151K00000S.

3. Turn ON the gas supply and operate the furnace and all other gas consuming appliances on the same gas supply line.
4. Measure furnace gas supply pressure with burners firing. Supply pressure must be within the range specified in the *Inlet Gas Supply Pressure* table.

Inlet Gas Supply Pressure		
Natural Gas	Minimum: 5.0" w.c.	Maximum: 10.0" w.c.
Propane Gas	Minimum: 11.0" w.c.	Maximum: 13.0" w.c.

If supply pressure differs from table, make the necessary adjustments to pressure regulator, gas piping size, etc., and/or consult with local gas utility.

5. Turn OFF gas to furnace at the manual shutoff valve and disconnect manometer. Reinstall plug before turning on gas to furnace.
6. Turn OFF any unnecessary gas appliances stated in step 3.

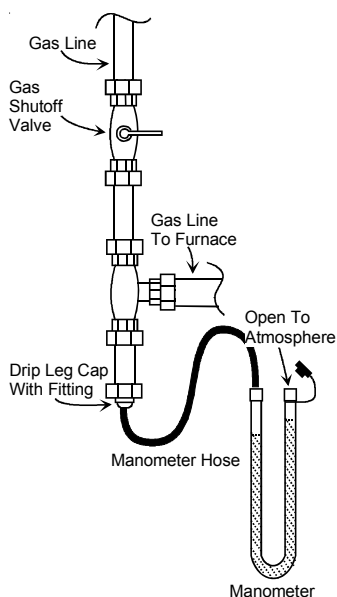

Measuring Inlet Gas Pressure (Alt. Method)

GAS MANIFOLD PRESSURE MEASUREMENT AND ADJUSTMENT



CAUTION

TO PREVENT UNRELIABLE OPERATION OR EQUIPMENT DAMAGE, THE GAS MANIFOLD PRESSURE MUST BE AS SPECIFIED ON THE UNIT RATING PLATE. ONLY MINOR ADJUSTMENTS SHOULD BE MADE BY ADJUSTING THE GAS VALVE PRESSURE REGULATOR.

Only small variations in gas pressure should be made by adjusting the gas valve pressure regulator. The manifold pressure must be measured with the burners operating. To measure and adjust the manifold pressure, use the following procedure.

1. Turn OFF gas to furnace at the manual gas shutoff valve external to the furnace.
2. Turn off all electrical power to the system.
3. Outlet pressure tap connections:
 - a. Honeywell VR9205 valve: Remove the outlet pressure boss plug. Install an 1/8" NPT hose barb fitting into the outlet pressure tap.
 - b. White-Rodgers 36G54 valve: Back outlet pressure test screw (inlet/outlet pressure boss) out one turn (counterclockwise, not more than one turn).
4. Attach a hose and manometer to the outlet pressure barb fitting (Honeywell valve) or outlet pressure boss (White-Rodgers valve).
5. Turn ON the gas supply.
6. Turn on power and close thermostat "R" and "W1" contacts to provide a call for low stage heat.
7. Measure the gas manifold pressure with burners firing. Adjust manifold pressure using the *Manifold Gas Pressure* table shown below.
8. Remove regulator cover screw from the low (LO) outlet pressure regulator adjust tower and turn screw clockwise to increase pressure or counterclockwise to decrease pressure. Replace regulator cover screw.

9. Close thermostat "R" and "W2" contacts to provide a call for high stage heat.
10. Remove regulator cover screw from the high (HI) outlet pressure regulator adjust tower and turn screw clockwise to increase pressure or counterclockwise to decrease pressure. Replace regulator cover screw.
11. Turn off all electrical power and gas supply to the system.
12. Remove the manometer hose from the hose barb fitting or outlet pressure boss.
13. Replace outlet pressure tap:
 - a. Honeywell VR9205 valve: Remove the 1/8" NPT hose barb fitting from the outlet pressure tap. Replace the outlet pressure boss plug and seal with a high quality thread sealer.
 - b. White-Rodgers 36G54 valve: Turn outlet pressure test screw in to seal pressure port (clockwise, 7 in-lb minimum).
14. Turn on electrical power and gas supply to the system.
15. Close thermostat contacts "R" and "W1/W2" to energize the valve.

Using a leak detection solution or soap suds, check for leaks at outlet pressure boss plug (Honeywell valve) or screw (White-Rodgers valve). Bubbles forming indicate a leak. SHUT OFF GAS AND REPAIR ALL LEAKS IMMEDIATELY!

NOTE: For gas to gas conversion, consult your dealer for appropriate conversion.

Manifold Gas Pressure			
Gas		Range	Nominal
Natural	Low Stage	1.6 - 2.2" w.c.	1.9" w.c.
	High Stage	3.2 - 3.8" w.c.	3.5" w.c.
Propane	Low Stage	5.7 - 6.3" w.c.	6.0" w.c.
	High Stage	9.7 - 10.3" w.c.	10.0" w.c.

GAS INPUT RATE MEASUREMENT (NATURAL GAS ONLY)

The gas input rate to the furnace must never be greater than that specified on the unit rating plate. To measure natural gas input using the gas meter, use the following procedure.

1. Turn OFF the gas supply to all other gas-burning appliances except the furnace.
2. While the furnace is operating, time and record one complete revolution of the smallest gas meter dial.
3. Calculate the number of seconds per cubic foot (sec/ft³) of gas being delivered to the furnace. If the dial is a one cubic foot dial, divide the number of seconds recorded in step 2 by one. If the dial is a two cubic foot dial, divide the number of seconds recorded in step 2 by two.

START-UP PROCEDURE AND ADJUSTMENT

- Calculate the furnace input in BTUs per hour (BTU/hr). Input equals the sum of the installation's gas heating value and a conversion factor (hours to seconds) divided by the number of seconds per cubic foot. The measured input must not be greater than the input indicated on the unit rating plate.

EXAMPLE:

Installation's gas heating (HTG) value: 1,000 BTU/ft³
(Obtained from gas supplier)

Installation's seconds per cubic foot: 34 sec/ ft³

Conversion Factor (hours to seconds): 3600 sec/hr

Input = (Htg. value x 3600) ÷ seconds per cubic foot

Input = (1,000 BTU/ft³ x 3600 sec/hr) ÷ 34 sec/ ft³

Input = 106,000 BTU/hr

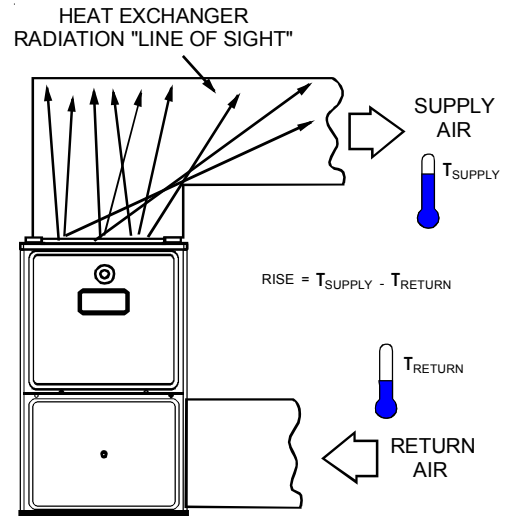

Temperature Rise Measurement

CIRCULATOR BLOWER SPEEDS



WARNING

TO AVOID PERSONAL INJURY OR DEATH DUE TO ELECTRICAL SHOCK, TURN OFF POWER TO THE FURNACE BEFORE CHANGING SPEED TAPS.

Minor changes to the input rate may be accomplished through manifold pressure adjustments at the gas valve. Refer to *Section XIV, Startup Procedure and Adjustment - Gas Manifold Pressure Measurement and Adjustment* for details. **NOTE:** The final manifold pressure cannot vary by more than ± 0.3 " w.c. from the specified setting. Consult your local gas supplier if additional input rate adjustment is required.

- Repeat steps 2 through 4 on high stage.
- Turn ON gas to and relight all other appliances turned off in step 1. Be certain that all appliances are functioning properly and that all pilot burners are operating.

TEMPERATURE RISE

Temperature rise must be within the range specified on the unit rating plate. An incorrect temperature rise may result in condensing in or overheating of the heat exchanger. An airflow and temperature rise table is provided in the Specification Sheet applicable to your model. Determine and adjust temperature rise as follows:

- Operate furnace with burners firing for approximately ten minutes. Ensure all registers are open and all duct dampers are in their final (fully or partially open) position.
- Place thermometers in the return and supply ducts as close to the furnace as possible. Thermometers must not be influenced by radiant heat by being able to "see" the heat exchanger.
- Subtract the return air temperature from the supply air temperature to determine the air temperature rise. Allow adequate time for thermometer readings to stabilize.
- Adjust temperature rise by adjusting the circulator blower speed. Increase blower speed to reduce temperature rise. Decrease blower speed to increase temperature rise. Refer to *Startup Procedure and Adjustment - Circulator Blower Speeds* for speed changing details.

This furnace is equipped with a multi-speed circulator blower. This blower provides ease in adjusting blower speeds. The Specification Sheet applicable to your model provides an airflow table, showing the relationship between airflow (CFM) and external static pressure (E.S.P.), for the proper selection of heating and cooling speeds. The heating blower speed is shipped set at "B", and the cooling blower speed is set at "D". These blower speeds should be adjusted by the installer to match the installation requirements so as to provide the correct heating temperature rise and correct cooling CFM.

Use the dual 7-segment LED display adjacent to the dipswitches to obtain the approximate airflow quantity. The airflow quantity is displayed as a number on the display, rounded to the nearest 100 CFM. The display alternates airflow delivery indication and the operating mode indication.

Example: The airflow being delivered is 1225 CFM. The display indicates 12. If the airflow being delivered is 1275, the display indicates 13.

- Determine the tonnage of the cooling system installed with the furnace. If the cooling capacity is in BTU/hr divide it by 12,000 to convert capacity to TONS.

Example: Cooling Capacity of 30,000 BTU/hr.
 $30,000/12,000 = 2.5$ Tons

- Determine the proper air flow for the cooling system. Most cooling systems are designed to work with air flows between 350 and 450 CFM per ton. Most manufacturers recommend an air flow of about 400 CFM per ton.

Example: 2.5 tons X 400 CFM per ton = 1000 CFM

START-UP PROCEDURE AND ADJUSTMENT

The cooling system manufacturer's instructions must be checked for required air flow. Any electronic air cleaners or other devices may require specific air flows, consult installation instructions of those devices for requirements.

- Knowing the furnace model, locate the high stage cooling air flow charts in the Specification Sheet applicable to your model. Look up the cooling air flow determined in step 2 and find the required cooling speed and adjustment setting.

Example: A *MVC80704BX furnace installed with a 2.5 ton air conditioning system. The air flow needed is 1000 CFM. Looking at the cooling speed chart for *MVC80704BX, find the air flow closest to 1000 CFM. A cooling airflow of 990 CFM can be attained by setting the cooling speed to "C" and the adjustment to "-" (minus).

- Continuous fan speed is 30% of the furnace's maximum airflow capability.
Example: If the furnace's maximum airflow capability is 2000 CFM, the continuous fan speed will be $0.30 \times 2000 \text{ CFM} = 600 \text{ CFM}$.
- Locate the blower speed selection DIP switches on the integrated control module. Select the desired "cooling" speed tap by positioning switches 1 and 2 appropriately. Select the desired "adjust" tap by positioning switches 3 and 4 appropriately. Refer to the following figure for switch positions and their corresponding taps. Verify CFM by noting the number displayed on the dual 7-segment LED display.
- The multi-speed circulator blower also offers several custom ON/OFF ramping profiles. These profiles may be used to enhance cooling performance and increase comfort level. The ramping profiles are selected using DIP switches 5 and 6. Refer to the following figure for switch positions and their corresponding taps. Refer to the bullet points below for a description of each ramping profile. Verify CFM by noting the number displayed on the dual 7-segment LED display.

Switch Bank: S4		
Ramping Profiles	DIP Switch No.	
	5	6
A*	OFF	OFF
B	ON	OFF
C	OFF	ON
D	ON	ON
(*Indicates factory setting)		

- Profile A** provides only an OFF delay of one (1) minute at 100% of the cooling demand airflow.

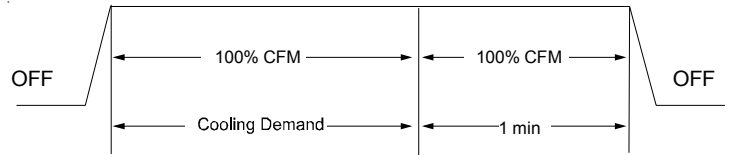

- Profile B** ramps up to full cooling demand airflow by first stepping up to 50% of the full demand for 30 seconds. The motor then ramps to 100% of the required airflow. A one (1) minute OFF delay at 100% of the cooling airflow is provided.

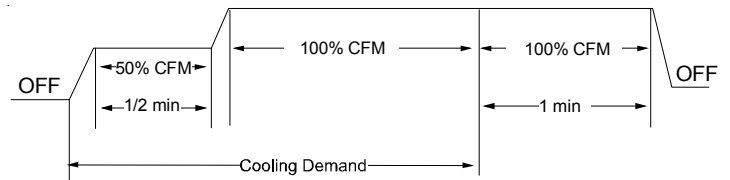

- Profile C** ramps up to 85% of the full cooling demand airflow and operates there for approximately 7 1/2 minutes. The motor then steps up to the full demand airflow. Profile C also has a one (1) minute 100% OFF delay.

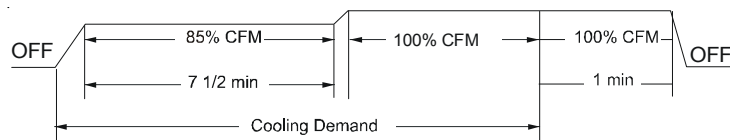

Switch Bank: S3		
Cooling Airflow	DIP Switch No.	
	1	2
A	OFF	OFF
B	ON	OFF
C	OFF	ON
D*	ON	ON
(*Indicates factory setting)		

Switch Bank: S3		
Adjust Taps	DIP Switch No.	
	3	4
Normal*	OFF	OFF
10%	ON	OFF
-10%	OFF	ON
Normal	ON	ON
(*Indicates factory setting)		

- Profile D** ramps up to 50% of the demand for 1/2 minute, then ramps to 85% of the full cooling demand airflow and operates there for approximately 7 1/2 minutes. The motor then steps up to the full demand airflow. Profile D has a 1/2 minute at 50% airflow OFF delay.

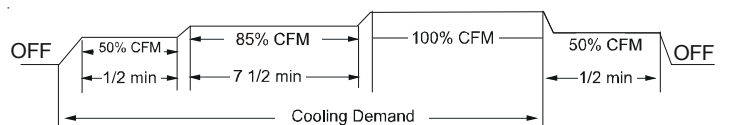

START-UP PROCEDURE AND ADJUSTMENT

- Select the heating speed for your model from the heating speed chart in the Specification Sheet. The adjust setting (already established by the cooling speed selection) determines which set of speeds are available. The selected speed must provide a temperature rise within the rise range listed with the particular model.

Example: The *MVC80704BX is set for 990 CFM on cooling, the “ADJUST” is set to “+” (plus). The four heating speeds available are “A Plus”, “B Plus”, “C Plus”, and “D Plus”. “A Plus” has a rise of 38°F for both stages which is within the 20-50°F rise range for the *MVC80704BX. This setting will keep electrical consumption to a minimum. Set the “Heat” speed DIP switches to “A”.

Switch Bank: S4		
Heating Airflow	DIP Switch No.	
	7	8
A	OFF	OFF
B*	ON	OFF
C	OFF	ON
D	ON	ON
(*Indicates factory setting)		

- Select the desired “heating” speed tap by positioning switches 7 and 8 appropriately. Refer to figure above. Verify CFM by noting the number displayed on the dual 7-segment LED display.

In general lower heating speeds will: reduce electrical consumption, lower operating sound levels of the blower, and increase the outlet air temperature delivered to the home. The speeds available allow the blower performance to be optimized for the particular homeowner’s needs.

BLOWER HEAT OFF DELAY TIMINGS

The integrated control module provides a selectable heat off delay function. The heat off delay period may be set to 90, 120, 150, 180 seconds using the DIP switches or jumper provided on the control module. The delay is factory shipped at 150 seconds but may be changed to suit the installation requirements and/or homeowner preference. Refer to the following figures for switch positions and corresponding delay times.

Switch Bank: S1		
Heat OFF Delay	DIP Switch No.	
	1	2
90 seconds	OFF	OFF
120 seconds	ON	OFF
150 seconds*	OFF	ON
180 seconds	ON	ON
(*Indicates factory setting)		

Heat Off Delay Dipswitches

Speed Selection Dip Switches								Model	Tap	Low Stage Cool	High Stage Cool	Low Stage Heat	High Stage Heat	
	Cool Selection Switches		Adjust Selection Switches		Profile Selection Switches		Heat Selection Switches		"DVC80703BX"	A	390	600	735	1050
TAP	1	2	3	4	5	6	7	8		B	520	800	805	1150
A	OFF	OFF	OFF	OFF	OFF	OFF	OFF	OFF		C	650	1000	875	1250
B	ON	OFF	ON	OFF	ON	OFF	ON	OFF		D	780	1200	935	1350
C	OFF	ON	OFF	ON	OFF	ON	OFF	ON						
D	ON	ON	ON	ON	ON	ON	ON	ON	"DVC80905CX"	A	520	800	945	1350
	Pre-Run		Short-Run		OFF Delay				B	715	1100	1015	1450	
A	-----		-----		60 sec/100%				C	910	1400	1085	1550	
B	-----		30 sec/50%		60 sec/100%				D	1170	1800	1155	1650	
C	-----		7.5 min/82%		60 sec/100%									
D	30 sec/50%		7.5 min/82%		30 sec/50%				"MVC81155CX"	A	553	850	1085	1550
To set airflow: (1) Select model and desired high stage cooling airflow. Determine the corresponding tap (A, B, C, or D). Set dip switches 1 and 2 to the appropriate ON / OFF positions. (2) Select model and desired high stage heating airflow. Determine the corresponding tap (A, B, C, or D). Set dip switches 7 and 8 to the appropriate ON / OFF positions. (3) Select the airflow adjustment factor taps A and D are 1, Tap B is +10%, Tap C -10%. Set dip switches 3 and 4 to the appropriate ON / OFF positions.								B	748	1150	1155	1650		
To set Comfort Mode: Select desired Comfort Mode profile (see profiles above). Set switches 5 and 6 to the appropriate ON / OFF positions.								C	943	1450	1225	1750		
								D	1203	1850	1260	1800		
								"MVC80704BX"	A	390	600	875	1250	
								B	520	800	945	1350		
								C	715	1100	1015	1450		
								D	910	1400	1085	1550		
								"MVC80905CX"	A	520	800	1050	1500	
								B	715	1100	1120	1600		
								C	910	1400	1190	1700		
								D	1170	1800	1260	1800		
								"MVC81155CX"	A	520	800	1210	1725	
								B	715	1100	1225	1750		
								C	910	1400	1245	1775		
								D	1175	1800	1260	1800		

NOTE: Airflow data shown applies to legacy mode operation only. For a fully communicating system, please see the outdoor unit’s installation instructions for cooling and pump heating airflow data. See *ComfortNet™ System - Airflow Consideration* section for details.

COMFORTNET™ SYSTEM

OVERVIEW

The ComfortNet system (or CT system) is a system that includes a ComfortNet compatible furnace and air conditioner or heat pump with a CTK01AA thermostat. A valid ComfortNet system could also be a compatible furnace, CTK01AA thermostat and non-compatible, single stage air conditioner. Any other system configurations are considered invalid ComfortNet systems and must be connected as a traditional (or legacy) system (see *Electrical Connections* for wiring connections). The table below compares the valid CT systems.

<i>CT compatible Furnace</i>	<i>CT compatible Air Conditioner</i>	<i>Full CT system benefits and features</i>
<i>CT compatible Furnace</i>	<i>CT compatible Heat Pump</i>	<i>Full CT system benefits and features</i>
<i>CT compatible Furnace</i>	<i>Non-CT compatible Single Stage Air Conditioner</i>	<i>CT system benefits and features for furnace only</i>

A ComfortNet heating/air conditioning system differs from a legacy/traditional system in the manner in which the indoor unit, outdoor unit and thermostat interact with one another. In a traditional system, the thermostat sends commands to the indoor and outdoor units via analog 24 VAC signals. It is a one-way communication path in that the indoor and outdoor units typically do not return information to the thermostat.

On the other hand, the indoor unit, outdoor unit, and thermostat comprising a ComfortNet system “communicate” digitally with one another. It is now a two-way communications path. The thermostat still sends commands to the indoor and outdoor units. However, the thermostat may also request and receive information from both the indoor and outdoor units. This information may be displayed on the CT thermostat. The indoor and outdoor units also interact with one another. The outdoor unit may send commands to or request information from the indoor unit. This two-way digital communications between the thermostat and subsystems (indoor/outdoor unit) and between subsystems is the key to unlocking the benefits and features of the ComfortNet system.

Two-way digital communications is accomplished using only two wires. The thermostat and subsystem controls are power with 24 VAC. Thus, a maximum of 4 wires between the equipment and thermostat is all that is required to operate the system.

AIRFLOW CONSIDERATIONS

Airflow demands are managed differently in a fully communicating system than they are in a legacy wired system. The system operating mode (as determined by the thermostat) determines which unit calculates the system airflow demand. If the indoor unit is responsible for determining the airflow demand, it calculates the demand and sends it to the

ECM motor. If the outdoor unit or thermostat is responsible for determining the demand, it calculates the demand and transmits the demand along with a fan request to the indoor unit. The indoor unit then sends the demand to the ECM motor. The table below lists the various ComfortNet systems, the operating mode, and airflow demand source.

System	System Operating Mode	Airflow Demand Source
Air Conditioner + Furnace	Cooling	Air Conditioner
	Heating	Furnace
	Continuous Fan	Thermostat
Heat Pump + Furnace	Cooling	Heat Pump
	Heat Pump Heating Only	Heat Pump
	Auxiliary Heating	Furnace
	Continuous Fan	Thermostat
Furnace + Non-Comm 1stg Air Conditioner	Cooling	Furnace
	Heating	Furnace
	Continuous Fan	Thermostat

For example, assume the system is an air conditioner matched with a furnace. With a call for low stage cooling, the air conditioner will calculate the system’s low stage cooling airflow demand. The air conditioner will then send a fan request along with the low stage cooling airflow demand to the furnace. Once received, the furnace will send the low stage cooling airflow demand to the ECM motor. The ECM motor then delivers the low stage cooling airflow. See the applicable ComfortNet™ air conditioner or heat pump installation manual for the airflow delivered during cooling or heat pump heating.

In continuous fan mode, the CTK01AA thermostat provides the airflow demand. The thermostat may be configured for a low, medium, or high continuous fan speed. The low, medium, and high fan speeds correspond to 25%, 50%, and 75%, respectively, of the furnaces’ maximum airflow capability. During continuous fan operation, the thermostat sends a fan request along with the continuous fan demand to the furnace. The furnace, in turn, sends the demand to the ECM motor. The ECM motor delivers the requested continuous fan airflow.

COMFORTNET™ SYSTEM

FOSSIL FUEL APPLICATIONS

This furnace can be used in conjunction with a ComfortNet™ compatible heat pump in a fossil fuel application. A fossil fuel application refers to a combined gas furnace and heat pump installation which uses an outdoor temperature sensor to determine the most cost efficient means of heating (heat pump or gas furnace). When used with the CTK01AA thermostat, the furnace/heat pump system is automatically configured as a fossil fuel system. The balance point temperature may be adjusted via the CTK01AA thermostat advanced user menus (see CTK01AA instructions for additional information).

CTK01AA WIRING

NOTE: Refer to *Electrical Connections* for 115 volt line connections to the furnace.

NOTE: A removable plug connector is provided with the control to make thermostat wire connections. This plug may be removed, wire connections made to the plug, and replaced. It is **strongly** recommended that multiple wires into a single terminal be twisted together prior to inserting into the plug connector. Failure to do so may result in intermittent operation.

Typical 18 AWG thermostat wire may be used to wire the system components. One hundred (100) feet is the maximum length of wire between indoor unit and outdoor unit, or between indoor unit and thermostat. Wire runs over (100) feet require larger gauge wire.

FOUR-WIRE INDOOR AND OUTDOOR WIRING

Typical ComfortNet™ wiring will consist of four wires between the indoor unit and outdoor unit and between the indoor unit and thermostat. The required wires are: (a) data lines, 1 and 2; (b) thermostat “R” (24 VAC hot) and “C” (24 VAC common).

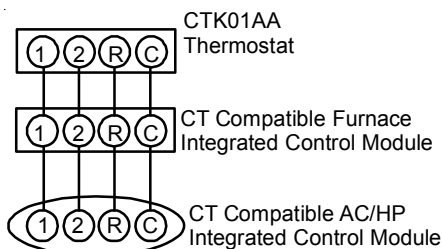

System Wiring using Four-Wires

TWO-WIRE OUTDOOR, FOUR-WIRE INDOOR WIRING

Two wires can be utilized between the indoor and outdoor units. For this wiring scheme, only the data lines, 1 and 2, are needed between the indoor and outdoor units. A 40VA, 208/230 VAC to 24VAC transformer must be installed in the outdoor unit to provide 24VAC power to the outdoor unit's electronic control. The transformer is included with the CTK01AA kit. See kit instructions for mounting and wiring instructions.

Four wires are required between the indoor unit and thermostat.

NOTE: Use of the CTK01AA transformer is recommended if installing a dual fuel/fossil fuel system. Failure to use the transformer in the outdoor unit could result in over loading of the furnace transformer.

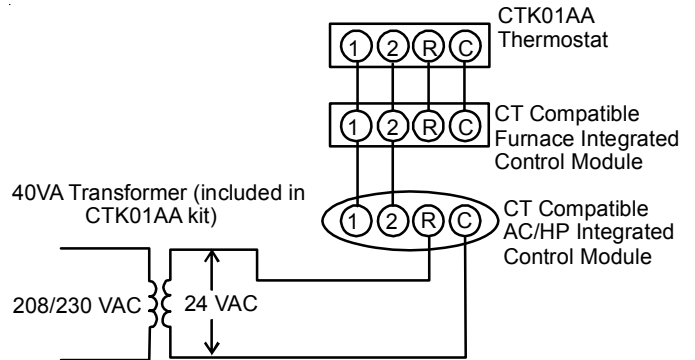

System Wiring using Two-Wires between Furnace and AC/HP and Four-Wires between Furnace and Thermostat

CT COMPATIBLE FURNACE WITH NON-CT COMPATIBLE SINGLE-STAGE AIR CONDITIONER

Four wires are required between the furnace and thermostat. Two wires are required between the furnace control and single stage air conditioner. For this system configuration, the “Y1” terminal on the integrated furnace control becomes an output rather than an input. The “Y1” connection to the outdoor unit is made using both 4-position thermostat connectors in the CTK01AA kit. Remove the red keying tabs from the on-board connector and position both 4-position connectors such that “1”, “2”, “R”, “C”, and “Y1” positions are filled.

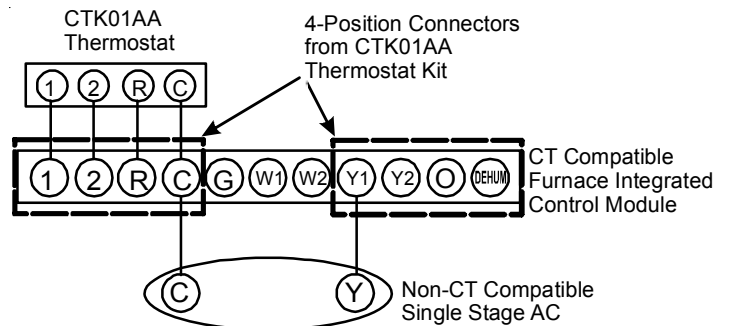

System Wiring between Furnace and Non-CT Compatible Single Stage Air Conditioner

COMFORTNET SYSTEM ADVANCED FEATURES

The ComfortNet system permits access to additional system information, advanced setup features, and advanced diagnostic/troubleshooting features. These advanced features are organized into a menu structure. The menus are accessed and navigated as described in the following section.

ACCESSING AND NAVIGATING THE ADVANCED FEATURES MENUS

The advanced system features are accessed using the ComfortNet thermostat. These advanced features are accessed as follows:

- On the CT thermostat Home Screen Display, touch the **Menu** key to display additional key choices.
- Touch and hold the **Installer Config** key for approximately 3 seconds to enter the Thermostat Options Configuration menu.
- Touch and hold the **Installer Config** key again for approximately 3 seconds to enter the Advanced Installer Configuration menu.

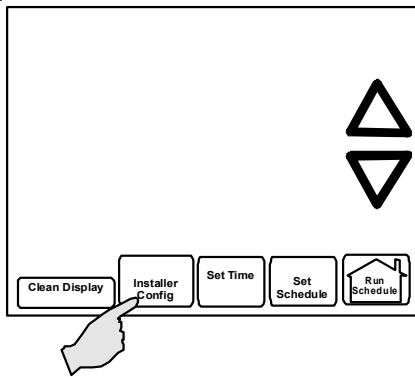

Upon entering the advanced menus, the Advanced Fault Menu is displayed. The display will change to the Fault Screen and indicate any faults that may be present in the indoor or outdoor equipment. If a fault is present, the Fault Screen will show the equipment and an error code with a description of the fault.

Touch \triangleleft or \triangleright keys to view the fault status of any remaining equipment. The text “NO FAULTS” will be scrolled if no errors are present.

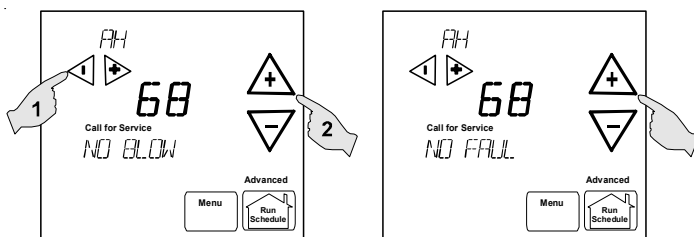

Touch the \triangleleft or \triangleright to step through the list of installed equipment, including the thermostat. Touch the **Installer Config** key to enter the submenus for the equipment displayed. The text “WORKING” will be displayed in the scrolling display area while the data is being retrieved. The first sub-menu is then displayed. See tables below for listing of furnace submenus.

Touch the \triangleleft or \triangleright to step through the list of submenus and view settings. If a setting can be adjusted, \triangleleft and \triangleright keys will appear. Use the \triangleleft or \triangleright keys to adjust the setting to the desired value. Touch the \triangleleft or \triangleright to step to the next item. “WORKING” will appear as the settings are being updated. “DONE” will appear to indicate the change was accepted. If

the change is not accepted, the display will show “FAIL” then revert to the Fault Screen.

Some parameters being displayed switch between the item name and the item value. Touch the **Hold** key to momentarily stop the display from switching.

To exit an equipment submenu and revert back to the equipment menus, touch the **Menu** key. Touch Menu again to revert back to the Thermostat Options Menu. Touch the **Run Schedule** key to step out of all menus and back to the CT thermostat Home Screen Display.

THERMOSTAT MENU

If this furnace is installed with a CT compatible heat pump, the system is recognized as a dual fuel system. The balance point temperature should be set via the thermostat advanced menu. Navigate to the **THERMOSTAT** menu. Press the **INSTALLER CONFIG** key. Navigate to the **SETUP** menu and press the **INSTALLER CONFIG** button. Navigate to **df BAL PNT**. Adjust the dual fuel system balance point using the back/forward arrows.

DIAGNOSTICS

Accessing the furnace’s diagnostics menu provides ready access to the last six faults detected by the furnace. Faults are stored most recent to least recent. Any consecutively repeated fault is stored a maximum of three times. Example: A clogged return air filter causes the furnace limit to trip repeatedly. The control will only store this fault the first three *consecutive* times the fault occurs. Navigate to the diagnostics menu as described above in *Accessing and Navigating the Advanced Features Menus*.

NOTE: It is highly recommended that the fault history be cleared when performing maintenance or servicing the furnace.

COMFORTNET™ SYSTEM

FURNACE ADVANCED FEATURES MENUS

CONFIGURATION	
Submenu Item	Indication (for Display Only; not User Modifiable)
Number of Heat Stages (HT STG)	Displays the number of furnace heating stages
Input Rate (BTU/HR)	Displays the furnace input rate in kBtu/hr
Motor HP (1/2, 3/4, or 1 MTR HP)	Displays the furnace indoor blower motor horsepower

DIAGNOSTICS		
Submenu Item	Indication/User Modifiable Options	Comments
Fault 1 (FAULT #1)	Most recent furnace fault	For display only
Fault 2 (FAULT #2)	Next most recent furnace fault	For display only
Fault 3 (FAULT #3)	Next most recent furnace fault	For display only
Fault 4 (FAULT #4)	Next most recent furnace fault	For display only
Fault 5 (FAULT #5)	Next most recent furnace fault	For display only
Fault 6 (FAULT #6)	Least recent furnace fault	For display only
Clear Fault History (CLEAR)	NO or YES	Selecting "YES" clears the fault history

NOTE: Consecutively repeated faults are shown a maximum of 3 times

IDENTIFICATION	
Submenu Item	Indication (for Display Only; not User Modifiable)
Model Number (MOD NUM)	Displays the furnace model number
Serial Number (SER NUM)	Displays the furnace serial number (Optional)
Software (SOFTWARE)	Displays the application software revision

SET-UP		
Submenu Item	User Modifiable Options	Comments
Heat Airflow Trim (HT TRM)	-10% to +10% in 2% increments, default is 0%	Trims the heating airflow by the selected amount.
Heat ON Delay (HT ON)	5, 10, 15, 20, 25, or 30 seconds, default is 30 seconds	Selects the indoor blower heat ON delay
Heat OFF Delay (HT OFF)	30, 60, 90, 120, 150, or 180 seconds, default is 150 seconds	Selects the indoor blower heat OFF delay
Heat Airflow (HT ADJ)	1, 2, 3, or 4	Selects the nominal heating airflow (see <i>Startup Procedure and Adjustment – Circulator Blower Speeds</i> for addition information)

STATUS	
Submenu Item	Indication (for Display Only; not User Modifiable)
Mode (MODE)	Displays the current furnace operating mode
CFM (CFM)	Displays the airflow for the current operating mode

NON-COMM (APPLIES ONLY TO A CT COMPATIBLE FURNACE MATCHED WITH A NON-CT COMPATIBLE SINGLE STAGE AIR CONDITIONER)		
Submenu Item	User Modifiable Options	Comments
Cool Airflow (CL CFM)	18, 24, 30, 36, 42, 48, or 60, default is 18	Selects the airflow for the non-CT compatible single stage AC unit
Cool Airflow Trim (CL TRM)	-10% to +10% in 2% increments, default is 0%	Selects the airflow trim amount for the non-CT compatible single stage AC unit
Cool Airflow Profile (CL PRFL)	A, B, C, or D, default is A	Selects the airflow profile for the non-CT compatible single stage AC unit
Cool ON Delay (CL ON)	5, 10, 20, or 30 seconds, default is 5 seconds	Selects the indoor blower ON delay for the non-CT compatible single stage AC unit
Cool OFF Delay (CL OFF)	30, 60, 90, or 120 seconds, default is 30 seconds	Selects the indoor blower OFF delay for the non-CT compatible single stage AC unit

NETWORK TROUBLESHOOTING

Communications is achieved by taking the difference between two dc signals. The signals and transmission lines are referred to as “data 1” and “data 2”. Each transmission line is biased to approximately 2.5Vdc. During data reception/transmission, the data lines vary between +5V and ground. (When data 1 is increasing towards +5V, data 2 is decreasing towards ground and when data 1 is decreasing towards ground, data 2 is increasing towards +5V. Typically, the data 1 line is approximately 2.6Vdc and the data 2 transmission line is approximately 2.3Vdc. The voltage difference between data 1 and data 2 is typically 0.2 to 0.6 Vdc.

The indoor control is equipped with a bank of three dipswitches that provide biasing and termination functions for the communications transmission lines. The outdoor control in the CT compatible unit is equipped with a bank of two dipswitches that provide termination functions for the communications transmission lines. Communications errors will result if these switches are not correctly set. The table below indicates the switch position for the bias and termination dipswitches along with the expected voltages. Note that the ON position is the correct position for all bias and termination dipswitches.

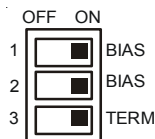

Indoor Unit BIAS and TERMINATION Dipswitches

The ComfortNet system is a fully communicating system, and thus, constitutes a network. Occasionally the need to trouble-

shoot the network may arise. The integrated furnace control has some on-board tools that may be used to troubleshoot the network. These tools are: red communications LED, green receive (Rx) LED, and learn button.

- Red communications LED – Indicates the status of the network. The table below indicates the LED status and the corresponding potential problem.
- Green receive LED – Indicates network traffic. The table below indicates the LED status and the corresponding potential problem.
- Learn button – Used to reset the network. Depress the button for approximately 2 seconds to reset the network.

SYSTEM TROUBLESHOOTING

NOTE: Refer to the instructions accompanying the CT compatible outdoor AC/HP unit for troubleshooting information.

Refer to the Troubleshooting Chart in the Appendix for a listing of possible furnace error codes, possible causes and corrective actions.

OPERATIONAL CHECKS & SAFETY CIRCUIT DESCRIPTION

LED	LED Status	Indication	Possible Causes	Corrective Action(s)	Notes & Cautions
Red Communications LED	Off	<ul style="list-style-type: none"> • Normal condition 	<ul style="list-style-type: none"> • None 	<ul style="list-style-type: none"> • None 	<ul style="list-style-type: none"> • None
	1 Flash	<ul style="list-style-type: none"> • Communications Failure 	<ul style="list-style-type: none"> • Communications Failure 	<ul style="list-style-type: none"> • Depress Learn Button • Verify that bus BIAS and TERM dipswitches are in the ON position. 	<ul style="list-style-type: none"> • Depress once quickly for a power-up reset • Depress and hold for 2 seconds for an out-of-box reset
	2 Flashes	<ul style="list-style-type: none"> • Out-of-box reset 	<ul style="list-style-type: none"> • Control power up • Learn button depressed 	<ul style="list-style-type: none"> • None 	<ul style="list-style-type: none"> • None
Green Receive LED	Off	<ul style="list-style-type: none"> • No power • Communications error 	<ul style="list-style-type: none"> • No power to furnace • Open fuse • Communications error 	<ul style="list-style-type: none"> • Check fuses and circuit breakers; replace/reset • Replace blown fuse • Check for shorts in low voltage wiring in furnace/system • Reset network by depressing learn button • Check data 1/ data 2 voltages 	<ul style="list-style-type: none"> • Turn power OFF prior to repair
	1 Steady Flash	<ul style="list-style-type: none"> • No network found 	<ul style="list-style-type: none"> • Broken/ disconnected data wire(s) • Furnace is installed as a legacy/ traditional system 	<ul style="list-style-type: none"> • Check communications wiring (data 1/ data 2 wires) • Check wire connections at terminal block • Verify furnace installation type (legacy/ traditional or communicating) • Check data 1/ data 2 voltages 	<ul style="list-style-type: none"> • Turn power OFF prior to repair • Verify wires at terminal blocks are securely twisted together prior to inserting into terminal block • Verify data1 and data voltages as described above
	Rapid Flashing	<ul style="list-style-type: none"> • Normal network traffic 	<ul style="list-style-type: none"> • Control is "talking" on network as expected 	<ul style="list-style-type: none"> • None 	<ul style="list-style-type: none"> • None
	On Solid	<ul style="list-style-type: none"> • Data 1/ Data 2 miss-wire 	<ul style="list-style-type: none"> • Data 1 and data 2 wires reversed at furnace, thermostat, or CT™ compatible outdoor AC/HP • Short between data 1 and data 2 wires • Short between data 1 or data 2 wires and R (24VAC) or C (24VAC common) 	<ul style="list-style-type: none"> • Check communications wiring (data 1/ data 2 wires) • Check wire connections at terminal block • Check data 1/ data 2 voltages 	<ul style="list-style-type: none"> • Turn power OFF prior to repair • Verify wires at terminal blocks are securely twisted together prior to inserting into terminal block • Verify data1 and data voltages as described above

NORMAL SEQUENCE OF OPERATION

POWER UP

The normal power up sequence is as follows:

- 115 VAC power applied to furnace.
- Integrated control module performs internal checks.
- Integrated control module displays **EE** on dual 7-segment display LED's.
- Integrated control module monitors safety circuits continuously.
- Furnace awaits call from thermostat. Dual 7-segment LED's display **EP** while awaiting call from thermostat.

HEATING MODE

The normal operational sequence in heating mode is as follows:

- R and W1 (or R and W1/W2) thermostat contacts close, initiating a call for heat.
- Integrated control module performs safety circuit checks.
- Induced draft blower is energized on high speed for a 15-second prepurge. Humidifier terminal is energized with induced draft blower.
- Induced draft blower steps to low speed following prepurge. Low stage pressure switch contacts are closed.
- Igniter warm up begins upon step to low speed and presence of closed low stage pressure switch contacts.

OPERATIONAL CHECKS & SAFETY CIRCUIT DESCRIPTION

- Gas valve opens at end of igniter warm up period, delivering gas to burners and establishing flame.
- Integrated control module monitors flame presence. Gas valve will remain open only if flame is detected.
- If the thermostat call is for low heat, gas valve and induced draft blower will continue on low stage. If the call is for high heat, the gas valve and induced draft blower will change to high stage.
- Circulator blower is energized on heat speed following a thirty (30) second blower on delay. The circulator blower requires thirty seconds to ramp up to full speed. Electronic air cleaner terminal is energized with circulator blower.
- Furnace is now operating on the specified stage called for by the two-stage thermostat.
- Furnace runs, integrated control module monitors safety circuits continuously.
- If the two-stage thermostat changes the call from low heat to high heat, the integrated control module will immediately switch the induced draft blower, gas valve, and circulator blower to their high stage settings.
- If the two-stage thermostat changes the call from high heat to low heat, the control will immediately switch the induced draft blower and gas valve to their low stage settings. The circulator blower will remain on high heating speed for thirty (30) seconds before switching to the low heat circulating speed.
- R and W1 (or R and W1/W2) thermostat contacts open, completing the call for heat.
- Gas valve closes, extinguishing flame.
- Induced draft blower is de-energized following a fifteen second post purge. Humidifier terminals are de-energized.
- Circulator blower continues running for the selected heat off delay period (90, 120, 150 or 180 seconds). The speed run during this period depends on the last heat call provided by the thermostat.
If the last call for heat was a call for low heat, the air circulator motor will run on low heat speed for the duration of the heat off delay period (90, 120, 150 or 180 seconds).
If the last call for heat was a call for high heat, the air circulating motor will run on the high heating speed for thirty (30) seconds and then switch to the low heating speed for the **balance** of the heat off delay period (60, 90, 120 or 150 seconds).
- Circulator blower and electronic air cleaner terminal is de-energized.
- Circulator blower ramps down to OFF during the 30 seconds following the heat off delay period.
- Furnace awaits next call from thermostat.

COOLING MODE

The normal operational sequence in cooling mode is as follows:

- R and Y1/G or Y2/G thermostat contacts close, initiating a call for cool.
- Integrated control module performs safety circuit checks.
- Outdoor fan and compressor are energized to their appropriate speed.
- Circulator blower is energized on the appropriate cool speed at the level and time determined by the selected ramping profile. Electronic air cleaner terminal is energized with circulator blower.
- Furnace circulator blower and outdoor cooling unit run their appropriate speeds, integrated control module monitors safety circuits continuously.
- R and Y1/G or Y2/G thermostat contacts open, completing the call for cool.
- Outdoor fan and compressor are de-energized.
- Circulator blower continues running during a cool off delay period. The OFF delay time and airflow level are determined by the selected ramping profile.
- Electronic air cleaner terminal and circulator blower are de-energized.
- Furnace awaits next call from thermostat.

FAN ONLY MODE

The normal operational sequence in fan only mode is as follows:

- R and G thermostat contacts close, initiating a call for fan.
- Integrated control module performs safety circuit checks.
- Circulator blower is energized on continuous fan speed (30% of the furnace's maximum airflow capability) following a five (5) second delay. Electronic air cleaner terminal is energized.
- Circulator blower runs, integrated control module monitors safety circuits continuously.
- R and G thermostat contacts open, completing the call for fan.
- Circulator blower is de-energized. Electronic air cleaner terminal is de-energized.
- Furnace awaits next call from thermostat.

OPERATIONAL CHECKS

The burner flames should be inspected with the burner compartment door installed. Flames should be stable, quiet, soft, and blue (dust may cause orange tips but they must not be yellow). Flames should extend directly outward from the burners without curling, floating, or lifting off. Flames must not impinge on the sides of the heat exchanger firing tubes.

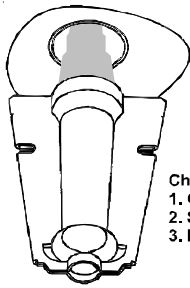

Check the burner flames for:
1. Good adjustment
2. Stable, soft and blue
3. Not curling, floating, or lifting off.

Burner Flame

SAFETY CIRCUIT DESCRIPTION

A number of safety circuits are employed to ensure safe and proper furnace operation. These circuits serve to control any potential safety hazards and serve as inputs in the monitoring and diagnosis of abnormal function. These circuits are continuously monitored during furnace operation by the integrated control module.

INTEGRATED CONTROL MODULE

The integrated control module is an electronic device which, if a potential safety concern is detected, will take the necessary precautions and provide diagnostic information through an LED.

PRIMARY LIMIT

The primary limit control is located on the partition panel and monitors heat exchanger compartment temperatures. It is a normally-closed (electrically), automatic reset, temperature-activated sensor. The limit guards against overheating as a result of insufficient conditioned air passing over the heat exchanger.

AUXILIARY LIMIT

The auxiliary limit controls are located on or near the circulator blower and monitors blower compartment temperatures. They are a normally-closed (electrically), auto-reset sensors. These limits guard against overheating as a result of insufficient conditioned air passing over the heat exchanger.

ROLLOUT LIMIT

The rollout limit controls are mounted on the burner/manifold assembly and monitor the burner flame. They are normally-closed (electrically), manual-reset sensors. These limits guard against burner flames not being properly drawn into the heat exchanger.

PRESSURE SWITCHES

The pressure switches are normally-open (closed during operation) negative air pressure-activated switches. They monitor the airflow (combustion air and flue products) through the heat exchanger via pressure taps located on the induced draft blower and the coil front cover. These switches guard against insufficient airflow (combustion air and flue products) through the heat exchanger and/or blocked condensate drain conditions.

FLAME SENSOR

The flame sensor is a probe mounted to the burner/manifold assembly which uses the principle of flame rectification to determine the presence or absence of flame.

TROUBLESHOOTING

ELECTROSTATIC DISCHARGE (ESD) PRECAUTIONS

NOTE: Discharge body's static electricity before touching unit. An electrostatic discharge can adversely affect electrical components.

Use the following precautions during furnace installation and servicing to protect the integrated control module from damage. By putting the furnace, the control, and the person at the same electrostatic potential, these steps will help avoid exposing the integrated control module to electrostatic discharge. This procedure is applicable to both installed and uninstalled (ungrounded) furnaces.

1. Disconnect all power to the furnace. Do not touch the integrated control module or any wire connected to the control prior to discharging your body's electrostatic charge to ground.
2. Firmly touch a clean, unpainted, metal surface of the furnace away from the control. Any tools held in a person's hand during grounding will be discharged.
3. Service integrated control module or connecting wiring following the discharge process in step 2. Use caution not to recharge your body with static electricity; (i.e., do not move or shuffle your feet, do not touch ungrounded objects, etc.). If you come in contact with an ungrounded object, repeat step 2 before touching control or wires.
4. Discharge your body to ground before removing a new control from its container. Follow steps 1 through 3 if installing the control on a furnace. Return any old or new controls to their containers before touching any ungrounded object.

DIAGNOSTIC CHART

 **WARNING**

HIGH VOLTAGE !

TO AVOID PERSONAL INJURY OR DEATH DUE TO ELECTRICAL SHOCK, DISCONNECT ELECTRICAL POWER BEFORE PERFORMING ANY SERVICE OR MAINTENANCE.



Refer to the *Troubleshooting Chart* at the end of this manual for assistance in determining the source of unit operational problems. The dual 7-segment LED display will display an error code that may contain a letter and number. The error code may be used to assist in troubleshooting the unit.

FAULT RECALL

The ignition control is equipped with a momentary push-button switch that can be used to display the last six faults on the dual 7-segment LED's. The control must be in Standby Mode (no thermostat inputs) to use the feature. Depress the switch for approximately 2 seconds. Release the switch when the LED's are turned off. The last six faults will be displayed most recent to least recent on the dual 7-segment LED's.

NOTE: Consecutively repeated faults are stored a maximum of three times. Example: A clogged return air filter causes the furnace limit to trip repeatedly. The control will only store this fault the first three *consecutive* times the fault occurs.

RESETTING FROM LOCKOUT

Furnace lockout results when a furnace is unable to achieve ignition after three attempts during a single call for heat. It is characterized by a non-functioning furnace and a E0 code displayed on the dual 7-segment display. If the furnace is in "lock-out", it will (or can be) reset in any of the following ways.

1. Automatic reset. The integrated control module will automatically reset itself and attempt to resume normal operations following a one hour lockout period.
2. Manual power interruption. Interrupt 115 volt power to the furnace.
3. Manual thermostat cycle. Lower the thermostat so that there is no longer a call for heat for 1 -20 seconds then reset to previous setting.

NOTE: If the condition which originally caused the lockout still exists, the control will return to lockout. Refer to the *Diagnostic Chart* for aid in determining the cause.

MAINTENANCE

 **WARNING**

TO AVOID ELECTRICAL SHOCK, INJURY OR DEATH, DISCONNECT ELECTRICAL POWER BEFORE PERFORMING ANY MAINTENANCE. IF YOU MUST HANDLE THE IGNITER, HANDLE WITH CARE. TOUCHING THE IGNITER ELEMENT WITH BARE FINGERS, ROUGH HANDLING OR VIBRATION COULD DAMAGE THE IGNITER RESULTING IN PREMATURE FAILURE. ONLY A QUALIFIED SERVICER SHOULD EVER HANDLE THE IGNITER.



ANNUAL INSPECTION

The furnace should be inspected by a qualified installer, or service agency at least once per year. This check should be performed at the beginning of the heating season. This will ensure that all furnace components are in proper working order and that the heating system functions appropriately. Pay particular attention to the following items. Repair or service as necessary.

- Flue pipe system. Check for blockage and/or leakage. Check the outside termination and the connections at and internal to the furnace.
- Heat exchanger. Check for corrosion and/or buildup within the heat exchanger passageways.
- Burners. Check for proper ignition, burner flame, and flame sense.
- Drainage system. Check for blockage and/or leakage. Check hose connections at and internal to furnace.
- Wiring. Check electrical connections for tightness and/or corrosion. Check wires for damage.
- Filters.

FILTERS

 **CAUTION**

TO ENSURE PROPER UNIT PERFORMANCE, ADHERE TO THE FILTER SIZES GIVEN IN THE RECOMMENDED **MINIMUM FILTER SIZE TABLE** OR **SPECIFICATION SHEET** APPLICABLE TO YOUR MODEL.

FILTER MAINTENANCE

Improper filter maintenance is the most common cause of inadequate heating or cooling performance. Filters should be cleaned (permanent) or replaced (disposable) every two months or as required. When replacing a filter, it must be replaced with a filter of the same type and size.

FILTER REMOVAL

Depending on the installation, differing filter arrangements can be applied. Filters can be installed in either the central return register or a side panel external filter rack (upflow only). A media air filter or electronic air cleaner can be used as an alternate filter. Follow the filter sizes given in the Recommended Minimum Filter size table to ensure proper unit performance.

To remove filters from an external filter rack in an upright upflow installation, follow the directions provided with external filter rack kit.

HORIZONTAL UNIT FILTER REMOVAL

Filters in horizontal installations are located in the central return register or the ductwork near the furnace.

To remove:

1. Turn OFF electrical power to furnace.
2. Remove filter(s) from the central return register or ductwork.
3. Replace filter(s) by reversing the procedure for removal.
4. Turn ON electrical power to furnace.

MEDIA AIR FILTER OR ELECTRONIC AIR CLEANER REMOVAL

Follow the manufacturer's directions for service.

BURNERS

Visually inspect the burner flames periodically during the heating season. Turn on the furnace at the thermostat and allow several minutes for flames to stabilize, since any dislodged dust will alter the flames normal appearance. Flames should be stable, quiet, soft, and blue (dust may cause orange tips but they must not be yellow). They should extend directly outward from the burners without curling, floating, or lifting off. Flames must not impinge on the sides of the heat exchanger firing tubes.

INDUCED DRAFT AND CIRCULATOR BLOWERS

The bearings in the induced draft blower and circulator blower motors are permanently lubricated by the manufacturer. No further lubrication is required. Check motor windings for accumulation of dust which may cause overheating. Clean as necessary.

FLAME SENSOR (QUALIFIED SERVICER ONLY)

Under some conditions, the fuel or air supply can create a nearly invisible coating on the flame sensor. This coating acts as an insulator causing a drop in the flame sense signal. If the flame sense signal drops too low the furnace will not sense flame and will lock out. The flame sensor should be carefully cleaned by a qualified servicer using emery cloth or steel wool. Following cleaning, the flame sense signal should be as indicated in the Specifications Sheet.

FLUE PASSAGES (QUALIFIED SERVICER ONLY)

The heat exchanger flue passageways should be inspected at the beginning of each heating season. If necessary, clean the passageways as outlined below.

1. Turn OFF the electrical power and gas supply to the furnace.
2. Disconnect the gas line and remove the burner/ manifold assembly by removing the screws securing the assembly to the partition panel.
3. Disconnect the flue pipe system from the induced draft blower.
4. Remove the induced draft blower and collector box cover.
5. Clean the primary heat exchanger tubes using a wire brush attached to a length of high grade stainless steel cable, such as drain cleanout cable. Attach a variable speed reversible drill to the other end of the cable. Slowly rotate the cable with the drill and insert it into one of the heat exchanger tubes. While reversing the drill, work the cable in and out several times to obtain sufficient cleaning. Repeat for each tube.
6. Clean residue from furnace using a vacuum cleaner.
7. Replace the parts removed in the previous steps in reverse order.
8. Turn on electrical power and gas to furnace. Check for leaks and proper unit operation.

9. Severe heat exchanger fouling is an indication of an operational problem. Perform the checks listed in *Startup Procedure and Adjustments* to reduce the chances of repeated fouling.

BEFORE LEAVING AN INSTALLATION

- Cycle the furnace with the thermostat at least three times. Verify cooling and fan only operation.
- Review the Owner's Manual with the homeowner and discuss proper furnace operation and maintenance.
- Leave literature packet near furnace.

REPAIR AND REPLACEMENT PARTS

- When ordering any of the listed functional parts, be sure to provide the furnace model, manufacturing, and serial numbers with the order.
- Although only functional parts are shown in the parts list, all sheet metal parts, doors, etc. may be ordered by description.
- Parts are available from your distributor.

Functional Parts List-

Gas Valve	Blower Motor
Gas Manifold	Blower Wheel
Natural Gas Orifice	Blower Mounting Bracket
Propane Gas Orifice	Blower Cutoff
Igniter	Blower Housing
Flame Sensor	Inductor
Rollout Limit Switch	Heat Exchanger
Primary Limit Switch	Auxiliary Limit Switch
Pressure Switch	Integrated Control Module
Induced Draft Blower	Transformer
Door Switch	

Symptoms of Abnormal Operation (Legacy & ComfortNet™ Thermostat)	Diagnostic/Status LED Codes	Fault Description	ComfortNet™ Thermostat Only Message Code	Possible Causes	Corrective Actions	Notes & Cautions
<ul style="list-style-type: none"> Furnace fails to operate Integrated control module LED display provides no signal. ComfortNet™ thermostat "Call for Service" icon illuminated ComfortNet™ thermostat scrolls "Check Furnace" message 	None	<ul style="list-style-type: none"> No 115 power to furnace or no 24 volt power to integrated control module Blown fuse or circuit breaker Integrated control module has an internal fault 	<i>INTERNAL FAULT</i> <i>EE</i>	<ul style="list-style-type: none"> Manual disconnect switch OFF, door switch open or 24 volt wire improperly connected or loose Blown fuse or circuit breaker Integrated control module has an internal fault 	<ul style="list-style-type: none"> Assure 115 and 24 volt power to furnace and integrated control module. Check integrated control module fuse (3A). Replace if necessary. Check for possible shorts in 115 and 24 volt circuits. Repair as necessary. Replace bad integrated control module. 	<ul style="list-style-type: none"> Turn power OFF prior to repair. Replace integrated control module fuse with 3A automotive fuse. Read precautions in "Electrostatic Discharge" section of manual. Replace integrated control module with current replacement parts.
<ul style="list-style-type: none"> LED display indicates PF 		<ul style="list-style-type: none"> Normal operation 	None	<ul style="list-style-type: none"> Normal operation 	<ul style="list-style-type: none"> None 	<ul style="list-style-type: none"> Normal operation
<ul style="list-style-type: none"> Furnace fails to operate Integrated control module LED display provides E0 error code. ComfortNet™ thermostat "Call for Service" icon illuminated. ComfortNet™ thermostat scrolls "Check Furnace" message. 		<ul style="list-style-type: none"> Furnace lockout due to an excessive number of ignition "retries" (3 total) 	<i>LOCKOUT</i> <i>E0</i>	<ul style="list-style-type: none"> Failure to establish flame. Cause may be no gas to burners, front cover pressure switch stuck open, bad igniter or igniter alignment, improper orifices, or coated/oxidized or improperly connected flame sensor. Loss of flame after establishment. Cause may be interrupted gas supply, lazy burner flames (improper gas pressure or restriction in flue and/or combustion air piping), front cover pressure switch opening, or improper induced draft blower performance. 	<ul style="list-style-type: none"> Locate and correct gas interruption. Check front cover pressure switch operation (hose, wiring, contact operation). Correct if necessary. Replace or realign igniter. Check flame sense signal. Sand sensor if coated and/or oxidized. Check flue piping for blockage, proper length, elbows, and termination. Verify proper induced draft blower performance. 	<ul style="list-style-type: none"> Turn power OFF prior to repair. Igniter is fragile, handle with care. Sand flame sensor with emery cloth. See "Vent/Flue Pipe" section for piping details.
<ul style="list-style-type: none"> Furnace fails to operate. Integrated control module LED display provides E1 error code. ComfortNet™ thermostat "Call for Service" icon illuminated. ComfortNet™ thermostat scrolls "Check Furnace" message. 		<ul style="list-style-type: none"> Low stage pressure switch circuit is closed at start of heating cycle. 	<i>PSI CLOSED</i> <i>E1</i>	<ul style="list-style-type: none"> Low stage pressure switch contacts sticking. Shorts in pressure switch circuit wiring. 	<ul style="list-style-type: none"> Replace low stage pressure switch. Repair short in wiring. 	<ul style="list-style-type: none"> Turn power OFF prior to repair. Replace pressure switch with correct replacement part.
<ul style="list-style-type: none"> Induced draft blower runs continuously with no further furnace operation. Integrated control module LED display provides E2 error code. ComfortNet™ thermostat "Call for Service" icon illuminated. ComfortNet™ thermostat scrolls "Check Furnace" message. 		<ul style="list-style-type: none"> Low stage pressure switch circuit is not closed. 	<i>PSI OPEN</i> <i>E2</i>	<ul style="list-style-type: none"> Pressure switch hose blocked, pinched, or connected improperly. Blocked flue and/or inlet air pipe, blocked drain system or weak induced draft blower. Incorrect pressure switch set point or malfunctioning switch contacts. Loose or improperly connected wiring. 	<ul style="list-style-type: none"> Inspect pressure switch hose. Repair/replace if necessary. Inspect flue and/or inlet air piping for blockage, proper length, elbows, and termination. Check drain system. Correct as necessary. Check induced draft blower performance. Correct as necessary. Correct pressure switch set point or contact motion. Tighten or correct wiring connection. 	<ul style="list-style-type: none"> Turn power OFF prior to repair. Replace pressure switch with correct replacement part. Replace induced draft blower with correct replacement part.

TROUBLESHOOTING CHART

Symptoms of Abnormal Operation (Legacy & ComfortNet™ Thermostat)	Diagnostic/Status LED Codes	Fault Description	ComfortNet™ Thermostat Only Message	Possible Causes	Corrective Actions	Notes & Cautions
<ul style="list-style-type: none"> Circulator blower runs continuously. No furnace operation. Integrated control module LED display provides E3 error code. ComfortNet™ thermostat "Call for Service" icon illuminated. ComfortNet™ thermostat scrolls "Check Furnace" message. 		<ul style="list-style-type: none"> Primary limit or auxiliary limit circuit is open. Rollout limit circuit is open. 	<i>HIGH LIMIT OPEN</i>	<ul style="list-style-type: none"> Insufficient conditioned air over the heat exchanger. Blocked filters, restrictive ductwork, improper circulator blower speed, or failed circulator blower motor. Flame rollout. Misaligned burners, blocked flue and/or air inlet pipe, or failed induced draft blower. Loose or improperly connected wiring. 	<ul style="list-style-type: none"> Check filters and ductwork for blockage. Clean filters or remove obstruction. Check circulator blower speed and performance. Correct speed or replace blower motor if necessary. Check burners for proper alignment. Check flue and air inlet piping for blockage, proper length, elbows, and termination. Correct as necessary. Check induced draft blower for proper performance. Replace if necessary. Tighten or correct wiring connection. 	<ul style="list-style-type: none"> Turn power OFF prior to repair. See Specification Sheet applicable to your model for allowable rise range and proper circulator speed. See "Vent/Flue Pipe" section for piping details.
<ul style="list-style-type: none"> Induced draft blower and circulator blower runs continuously. No furnace operation. Integrated control module LED display provides E4 error code. ComfortNet™ thermostat "Call for Service" icon illuminated. ComfortNet™ thermostat scrolls "Check Furnace" message. 		<ul style="list-style-type: none"> Flame sensed with no call for heat. 	<i>IMPROPER FLAME</i>	<ul style="list-style-type: none"> Short to ground in flame sense circuit. Lingering burner flame. Slow closing gas valve. 	<ul style="list-style-type: none"> Correct short at flame sensor or in flame sensor wiring. Check for lingering flame. Verify proper operation of gas valve. 	<ul style="list-style-type: none"> Turn power OFF prior to repair.
<ul style="list-style-type: none"> No furnace operation. Integrated control module LED display provides E5 error code. ComfortNet™ thermostat displays "Battery Power". 		<ul style="list-style-type: none"> Open Fuse 	Not Displayed	<ul style="list-style-type: none"> Short in low voltage wiring 	<ul style="list-style-type: none"> Locate and correct short in low voltage wiring 	<ul style="list-style-type: none"> Turn power OFF prior to repair. Replace fuse with 3-amp automotive type
<ul style="list-style-type: none"> Normal furnace operation. Integrated control module LED display provides E6 error code. 		<ul style="list-style-type: none"> Flame sense micro amp signal is low 	<i>WEAK FLAME</i>	<ul style="list-style-type: none"> Flame sensor is coated/oxidized. Flame sensor incorrectly positioned in burner flame. Lazy burner flame due to improper gas pressure or combustion air. 	<ul style="list-style-type: none"> Sand flame sensor if coated/oxidized. Inspect for proper sensor alignment. Check inlet air piping for blockage, proper length, elbows, and termination. Compare current gas pressure to rating plate. Adjust as needed. 	<ul style="list-style-type: none"> Turn power OFF prior to repair. Sand flame sensor with emery cloth. See "Vent/Flue Pipe" section for piping details. See rating plate for proper gas pressure.
<ul style="list-style-type: none"> Furnace fails to operate. Integrated control module LED display provides E7 error code. ComfortNet™ thermostat "Call for Service" icon illuminated. ComfortNet™ thermostat scrolls "Check Furnace" message. 		<ul style="list-style-type: none"> Problem with igniter circuit. 	<i>IGNITER FAULT</i>	<ul style="list-style-type: none"> Improperly connected igniter. Shorted igniter. Poor unit ground. Igniter relay fault on integrated control module. 	<ul style="list-style-type: none"> Check and correct wiring from integrated control module to igniter. Replace shorted igniter. Check and correct unit ground wiring. Check igniter output from control. Replace if necessary. 	<ul style="list-style-type: none"> Turn power OFF prior to repair. Replace igniter with correct replacement part. Replace control with correct replacement part.

Symptoms of Abnormal Operation (Legacy & ComfortNet™ Thermostat)	Diagnostic/Status LED Codes	Fault Description	ComfortNet™ Thermostat Only Message Code	Possible Causes	Corrective Actions	Notes & Cautions
<ul style="list-style-type: none"> Furnace fails to operate on high stage; furnace operates normally on low stage. Integrated control module LED display provides EE error code. 	EE	<ul style="list-style-type: none"> High stage pressure switch circuit is closed at start of heating cycle. Induced draft blower is operating. Furnace is operating on low stage only 	PS2 CLOSED	<ul style="list-style-type: none"> High stage pressure switch contacts sticking. Shorts in pressure switch circuit wiring. 	<ul style="list-style-type: none"> Replace high stage pressure switch. Repair short in wiring 	<ul style="list-style-type: none"> Turn power OFF prior to repair. Replace pressure switch with correct replacement part.
<ul style="list-style-type: none"> Furnace fails to operate on high stage; furnace operates normally on low stage. Integrated control module LED display provides E9 error code. 	E9	<ul style="list-style-type: none"> High stage pressure switch circuit is not closed. Induced draft blower is operating. Furnace is operating on low stage only 	PS2 OPEN	<ul style="list-style-type: none"> Pressure switch hose blocked pinched, or connected improperly. Blocked flue and/or inlet air pipe, blocked drain system or weak induced draft blower. Incorrect pressure switch set point or malfunctioning switch contacts. Loose or improperly connected wiring. 	<ul style="list-style-type: none"> Inspect pressure switch hose. Repair/replace if necessary. Inspect flue and/or inlet air piping for blockage, proper length, elbows, and termination. Check drain system. Correct as necessary. Check induced draft blower performance. Correct as necessary. Correct pressure switch set point or contact motion. Tighten or correct wiring connection. 	<ul style="list-style-type: none"> Turn power OFF prior to repair. Replace pressure switch with correct replacement part. Replace induced draft blower with correct replacement part.
<ul style="list-style-type: none"> Furnace fails to operate. Integrated control module LED display provides E1 error code. ComfortNet™ thermostat "Call for Service" icon illuminated. ComfortNet™ thermostat scrolls "Check Furnace" message. 	E1	<ul style="list-style-type: none"> Polarity of 115 volt AC is reversed 	REVERSED PLTY	<ul style="list-style-type: none"> Polarity of 115 volt AC power to furnace or integrated module is reversed. Poor unit ground 	<ul style="list-style-type: none"> Review wiring diagram to correct polarity. Verify proper ground. Correct if necessary. Check and correct wiring. 	<ul style="list-style-type: none"> Turn power OFF prior to repair.
<ul style="list-style-type: none"> Furnace fails to operate. Integrated control module LED display provides d0 error code. ComfortNet™ thermostat "Call for Service" icon illuminated. ComfortNet™ thermostat scrolls "Check Furnace" message. 	d0	<ul style="list-style-type: none"> Data not yet on network. 	NO NET DATA	<ul style="list-style-type: none"> Furnace does not contain any shared data. 	<ul style="list-style-type: none"> Populate shared data set using memory card. 	<ul style="list-style-type: none"> Turn power OFF prior to repair Use memory card for the specific model. Insert memory card BEFORE turning power ON. Memory card may be removed after data is loaded. Turn power OFF before removing memory card. Error code will be cleared once data is loaded.

TROUBLESHOOTING CHART

Symptoms of Abnormal Operation (Legacy & ComfortNet™ Thermostat)	Diagnostic/Status LED Codes	Fault Description	ComfortNet™ Thermostat Only Message Code	Possible Causes	Corrective Actions	Notes & Cautions
<ul style="list-style-type: none"> Operation different than expected or no operation. Integrated control module LED display provides dH error code. ComfortNet™ thermostat "Call for Service" icon illuminated. ComfortNet™ thermostat scrolls "Check Furnace" message. 	dH	<ul style="list-style-type: none"> Invalid memory card data. 	<i>INVALID MC DATA</i>	<ul style="list-style-type: none"> Shared data set on memory card has been rejected by integrated control module 	<ul style="list-style-type: none"> Verify shared data set is correct for the specific model. Repopulate data using correct memory card if required. 	<ul style="list-style-type: none"> Turn power OFF prior to repair Use memory card for the specific model. Insert memory card BEFORE turning power ON. Memory card may be removed after data is loaded. Turn power OFF before removing memory card. Error code will be cleared once data is loaded.
<ul style="list-style-type: none"> Furnace fails to operate. Integrated control module LED display provides b0 error code. ComfortNet™ thermostat "Call for Service" icon illuminated. ComfortNet™ thermostat scrolls "Check Furnace" message. 	b0	<ul style="list-style-type: none"> Circulator blower motor is not running when it should be running. 	<i>MOTOR NOT RUN</i>	<ul style="list-style-type: none"> Loose wiring connection at circulator motor power leads or disconnected. Open circuit in inductor or loose wiring connection at inductor (3/4 Hp and 1 Hp models only). Failed circulator blower motor. 	<ul style="list-style-type: none"> Tighten or correct wiring connection. Verify continuous circuit through inductor. Replace if open or short circuit. Check circulator blower motor. Replace if necessary. 	<ul style="list-style-type: none"> Turn power OFF prior to repair Replace inductor with correct replacement part. Replace circulator motor with correct replacement part.
<ul style="list-style-type: none"> Furnace fails to operate. Integrated control module LED display provides b1 error code. ComfortNet™ thermostat "Call for Service" icon illuminated. ComfortNet™ thermostat scrolls "Check Furnace" message. 	b1	<ul style="list-style-type: none"> Integrated control module has lost communications with circulator blower motor. 	<i>MOTOR COMM</i>	<ul style="list-style-type: none"> Loose wiring connection at circulator motor control leads. Failed circulator blower motor. Failed integrated control module. 	<ul style="list-style-type: none"> Tighten or correct wiring connection. Check circulator blower motor. Replace if necessary. Check integrated control module. Replace if necessary. 	<ul style="list-style-type: none"> Turn power OFF prior to repair Replace circulator motor with correct replacement part. Replace integrated control module with correct replacement part.
<ul style="list-style-type: none"> Furnace fails to operate. Integrated control module LED display provides b2 error code. ComfortNet™ thermostat "Call for Service" icon illuminated. ComfortNet™ thermostat scrolls "Check Furnace" message. 	b2	<ul style="list-style-type: none"> Circulator blower motor horse power in shared data set does not match circulator blower motor horse power. 	<i>MOTOR MISMATCH</i>	<ul style="list-style-type: none"> Incorrect circulator blower motor in furnace. Incorrect shared data set in integrated control module. 	<ul style="list-style-type: none"> Verify circulator blower motor horse power is the same specified for the specific furnace model. Replace if necessary. Verify shared data set is correct for the specific model. Repopulate data using correct memory card if required. 	<ul style="list-style-type: none"> Turn power OFF prior to repair Replace motor with correct replacement part. Use memory card for the specific model Insert memory card BEFORE turning power ON. Memory card may be removed after data is loaded. Turn power OFF before removing memory card. Error code will be cleared once shared data and motor horse power match.
<ul style="list-style-type: none"> Furnace operates at reduced performance. Airflow delivered is less than expected. Integrated control module LED display provides b3 error code. 	b3	<ul style="list-style-type: none"> Circulator blower motor is operating in a power, temperature, or speed limiting condition. 	<i>MOTOR LIMITS</i>	<ul style="list-style-type: none"> Blocked filters. Restrictive ductwork. Undersized ductwork. High ambient temperatures. 	<ul style="list-style-type: none"> Check filters for blockage. Clean filters or remove obstruction. Check ductwork for blockage. Remove obstruction. Verify all registers are fully open. Verify ductwork is appropriately sized for system. Resize/replace ductwork if necessary. See "Product Description" and "Location Requirements & Considerations" for furnace installation requirements. 	<ul style="list-style-type: none"> Turn power OFF prior to repair.

Symptoms of Abnormal Operation (Legacy & ComfortNet™ Thermostat)	Diagnostic/Status LED Codes	Fault Description	ComfortNet™ Thermostat Only Message Code	Possible Causes	Corrective Actions	Notes & Cautions
<ul style="list-style-type: none"> Furnace fails to operate. Integrated control module LED display provides b4 error code. ComfortNet™ thermostat "Call for Service" icon illuminated. ComfortNet™ thermostat scrolls "Check Furnace" message. 	b4	<ul style="list-style-type: none"> Circulator blower motor senses a loss of rotor control. Circulator blower motor senses high current. 	<i>MOTOR TRIPS</i>	<ul style="list-style-type: none"> Abnormal motor loading, sudden change in speed or torque, sudden blockage of furnace air inlet or outlet. High loading conditions, blocked filters, very restrictive ductwork, blockage of furnace air inlet or outlet. 	<ul style="list-style-type: none"> Check filters, filter grills/registers, duct system, and furnace air inlet/outlet for blockages. 	<ul style="list-style-type: none"> Turn power OFF prior to repair.
<ul style="list-style-type: none"> Furnace fails to operate. Integrated control module LED display provides b5 error code. ComfortNet™ thermostat "Call for Service" icon illuminated. ComfortNet™ thermostat scrolls "Check Furnace" message. 	b5	<ul style="list-style-type: none"> Circulator blower motor fails to start 10 consecutive times. 	<i>MTR LOCK ROTOR</i>	<ul style="list-style-type: none"> Obstruction in circulator blower housing. Seized circulator blower motor bearings. Failed circulator blower motor. 	<ul style="list-style-type: none"> Check circulator blower for obstructions. Remove and repair/replace wheel/motor if necessary. Check circulator blower motor shaft rotation and motor. Replace motor if necessary. 	<ul style="list-style-type: none"> Turn power OFF prior to repair. Replace motor with correct replacement part. Replace wheel with correct replacement part.
<ul style="list-style-type: none"> Furnace fails to operate. Integrated control module LED display provides b5 error code. ComfortNet™ thermostat "Call for Service" icon illuminated. ComfortNet™ thermostat scrolls "Check Furnace" message. 	b5	<ul style="list-style-type: none"> Circulator blower motor shuts down for over or under voltage condition. Circulator blower motor shuts down due to over temperature condition on power module. 	<i>MOTOR VOLTS</i>	<ul style="list-style-type: none"> High AC line voltage to furnace. Low AC line voltage to furnace. High ambient temperatures. 	<ul style="list-style-type: none"> Check power to furnace. Verify line voltage to furnace is within the range specified on the furnace rating plate. See "Product Description" and "Location Requirements & Considerations" for furnace installation requirements. 	<ul style="list-style-type: none"> Turn power OFF prior to repair.
<ul style="list-style-type: none"> Furnace fails to operate. Integrated control module LED display provides b7 error code. ComfortNet™ thermostat "Call for Service" icon illuminated. ComfortNet™ thermostat scrolls "Check Furnace" message. 	b7	<ul style="list-style-type: none"> Circulator blower motor does not have enough information to operate properly. Motor fails to start 40 consecutive times. 	<i>MOTOR PARAMS</i>	<ul style="list-style-type: none"> Error with integrated control module. Motor has a locked rotor condition. 	<ul style="list-style-type: none"> Check integrated control module. Verify control is populated with correct shared data set. See data errors above for details. Check for locked rotor condition (see error code above for details). 	<ul style="list-style-type: none"> Turn power OFF prior to repair. Replace with correct replacement part(s). Use memory card for the specific model.
<ul style="list-style-type: none"> Furnace operates at reduced performance or operates on low stage when high stage is expected. Integrated control module LED display provides b9 error code. 	b9	<ul style="list-style-type: none"> Airflow is lower than demanded. 	<i>LOW ID AIRFLOW</i>	<ul style="list-style-type: none"> Blocked filters. Restrictive ductwork. Undersized ductwork. 	<ul style="list-style-type: none"> Check filters for blockage. Clean filters or remove obstruction. Check ductwork for blockage. Remove obstruction. Verify all registers are fully open. Verify ductwork is appropriately sized for system. Resize/replace ductwork if necessary. 	<ul style="list-style-type: none"> Turn power OFF prior to repair.

STATUS CODES

I	I	INTERNAL CONTROL FAULT/NO POWER
O	P	NORMAL OPERATION
E	0	LOCKOUT DUE TO EXCESSIVE RETRIES
E	1	LOW STAGE PRESSURE SWITCH STUCK CLOSED AT START OF HEATING CYCLE
E	2	LOW STAGE PRESSURE SWITCH STUCK OPEN
E	3	OPEN HIGH LIMIT SWITCH
E	4	FLAME DETECTED WHEN NO FLAME SHOULD BE PRESENT
E	5	OPEN FUSE
E	6	LOW FLAME SIGNAL
E	7	IGNITER FAULT OR IMPROPER GROUNDING
E	8	HIGH STAGE PRESSURE SWITCH STUCK CLOSED AT START OF HEATING CYCLE
E	9	HIGH STAGE PRESSURE SWITCH STUCK OPEN
E	A	REVERSED 115 VAC POLARITY
d	0	DATA NOT YET ON NETWORK
d	4	INVALID MEMORY CARD DATA
b	0	BLOWER MOTOR NOT RUNNING
b	1	BLOWER COMMUNICATION ERROR
b	2	BLOWER HP MIS-MATCH
b	3	BLOWER MOTOR OPERATING IN POWER, TEMPERATURE, OR SPEED LIMIT
b	4	BLOWER MOTOR CURRENT TRIP OR LOST ROTOR
b	5	BLOWER MOTOR LOCKED ROTOR
b	6	OVER/UNDER VOLTAGE TRIP OR OVER TEMPERATURE TRIP
b	7	INCOMPLETE PARAMETERS SENT TO MOTOR
b	9	LOW INDOOR AIRFLOW
C	1	LOW STAGE COOL
C	2	HIGH STAGE COOL
L	0	LOW STAGE HEAT
H	1	HIGH STAGE HEAT
I	F	CONTINUOUS FAN
1	2	CFM/100; ALTERNATES WITH C 1 , C 2 , L 0 , H 1 , I F

AIR FLOW DATA

Speed Selection Dip Switches									Model	Tap	Low Stage Cool	High Stage Cool	Low Stage Heat	High Stage Heat
	Cool Selection Switches		Adjust Selection Switches		Profile Selection Switches		Heat Selection Switches		*DVC80703BX*	A	390	600	735	1050
TAP	1	2	3	4	5	6	7	8		B	520	800	805	1150
A	OFF	OFF	OFF	OFF	OFF	OFF	OFF	OFF	C	650	1000	875	1250	
B	ON	OFF	ON	OFF	ON	OFF	ON	OFF	D	780	1200	935	1350	
C	OFF	ON	OFF	ON	OFF	ON	OFF	ON	*DVC80905CX*					
D	ON	ON	ON	ON	ON	ON	ON	ON	A	520	800	945	1350	
	Pre-Run		Short-Run		OFF Delay				*DVC81155CX*					
A	-----		-----		60 sec/100%				B	748	1150	1155	1650	
B	-----		30 sec/50%		60 sec/100%				C	943	1450	1225	1750	
C	-----		7.5 min/82%		60 sec/100%				D	1203	1850	1260	1800	
D	30 sec/50%		7.5 min/82%		30 sec/50%				*MVC80704BX*					
To set airflow: (1) Select model and desired high stage cooling airflow. Determine the corresponding tap (A, B, C, or D). Set dip switches 1 and 2 to the appropriate ON / OFF positions. (2) Select model and desired high stage heating airflow. Determine the corresponding tap (A, B, C, or D). Set dip switches 7 and 8 to the appropriate ON / OFF positions. (3) Select the airflow adjustment factor taps A and D are 1; Tap B is +10%, Tap C -10%. Set dip switches 3 and 4 to the appropriate ON / OFF positions. To set Comfort Mode: Select desired Comfort Mode profile (see profiles above). Set switches 5 and 6 to the appropriate ON / OFF positions.									A	390	600	875	1250	
									B	520	800	945	1350	
									C	715	1100	1015	1450	
									D	910	1400	1085	1550	
To set airflow: (1) Select model and desired high stage cooling airflow. Determine the corresponding tap (A, B, C, or D). Set dip switches 1 and 2 to the appropriate ON / OFF positions. (2) Select model and desired high stage heating airflow. Determine the corresponding tap (A, B, C, or D). Set dip switches 7 and 8 to the appropriate ON / OFF positions. (3) Select the airflow adjustment factor taps A and D are 1; Tap B is +10%, Tap C -10%. Set dip switches 3 and 4 to the appropriate ON / OFF positions. To set Comfort Mode: Select desired Comfort Mode profile (see profiles above). Set switches 5 and 6 to the appropriate ON / OFF positions.									A	520	800	1050	1500	
									B	715	1100	1120	1600	
									C	910	1400	1190	1700	
									D	1170	1800	1260	1800	
To set airflow: (1) Select model and desired high stage cooling airflow. Determine the corresponding tap (A, B, C, or D). Set dip switches 1 and 2 to the appropriate ON / OFF positions. (2) Select model and desired high stage heating airflow. Determine the corresponding tap (A, B, C, or D). Set dip switches 7 and 8 to the appropriate ON / OFF positions. (3) Select the airflow adjustment factor taps A and D are 1; Tap B is +10%, Tap C -10%. Set dip switches 3 and 4 to the appropriate ON / OFF positions. To set Comfort Mode: Select desired Comfort Mode profile (see profiles above). Set switches 5 and 6 to the appropriate ON / OFF positions.									A	520	800	1210	1725	
									B	715	1100	1225	1750	
									C	910	1400	1245	1775	
									D	1175	1800	1260	1800	

NOTE: Airflow data shown applies to legacy mode operation only. For a fully communicating system, please see the outdoor unit's installation instructions for cooling and pump heating airflow data. See *ComfortNet™ System - Airflow Consideration* section for details.

DIP SWITCHES

Switch Bank	Purpose	Function	DIP Switch No.										
			1	2	3	4	5	6	7	8	9	10	
S1	Heat OFF Delay	90 seconds	OFF	OFF	---	---	---	---	---	---	---	---	---
		120 seconds	ON	OFF	---	---	---	---	---	---	---	---	---
		150 seconds*	OFF	ON	---	---	---	---	---	---	---	---	---
		180 seconds	ON	ON	---	---	---	---	---	---	---	---	---
	Thermostat Setup	1-Stage T-stat	---	---	OFF	---	---	---	---	---	---	---	---
		2-Stage T-Stat	---	---	ON	---	---	---	---	---	---	---	---
5-Min Delay		---	---	---	OFF	---	---	---	---	---	---	---	
	Auto Delay	---	---	---	ON	---	---	---	---	---	---	---	
S2	Bus BIAS	BIAS	ON*	ON*	---	---	---	---	---	---	---	---	
	TERM	Bus Termination	---	---	ON*	---	---	---	---	---	---	---	
S3	Cooling Speed Tap	A	OFF	OFF	---	---	---	---	---	---	---	---	
		B	ON	OFF	---	---	---	---	---	---	---	---	
		C	OFF	ON	---	---	---	---	---	---	---	---	
		D*	ON	ON	---	---	---	---	---	---	---	---	
	Adjust Taps	Normal*	---	---	OFF	OFF	---	---	---	---	---	---	
		10%	---	---	ON	OFF	---	---	---	---	---	---	
-10%		---	---	OFF	ON	---	---	---	---	---	---		
	Normal	---	---	ON	ON	---	---	---	---	---	---		
S4	Ramping Profiles	A*	---	---	---	---	OFF	OFF	---	---	---	---	
		B	---	---	---	---	ON	OFF	---	---	---	---	
		C	---	---	---	---	OFF	ON	---	---	---	---	
		D	---	---	---	---	ON	ON	---	---	---	---	
	Heating Speed Tap	A	---	---	---	---	---	---	OFF	OFF	---	---	
		B*	---	---	---	---	---	---	ON	OFF	---	---	
		C	---	---	---	---	---	---	OFF	ON	---	---	
		D	---	---	---	---	---	---	ON	ON	---	---	
S5	DEHUM	Disabled*	---	---	---	---	---	---	---	---	OFF	Unused	
		Enabled	---	---	---	---	---	---	---	---	---	ON	Unused
(*Indicates factory setting)													
---	Not applicable												

*MVC8_AA WIRING DIAGRAM

HIGH VOLTAGE!
DISCONNECT ALL POWER BEFORE SERVICING OR INSTALLING THIS UNIT.
MULTIPLE POWER SOURCES MAY BE PRESENT. FAILURE TO DO SO MAY
CAUSE PROPERTY DAMAGE, PERSONAL INJURY OR DEATH.

WARNING

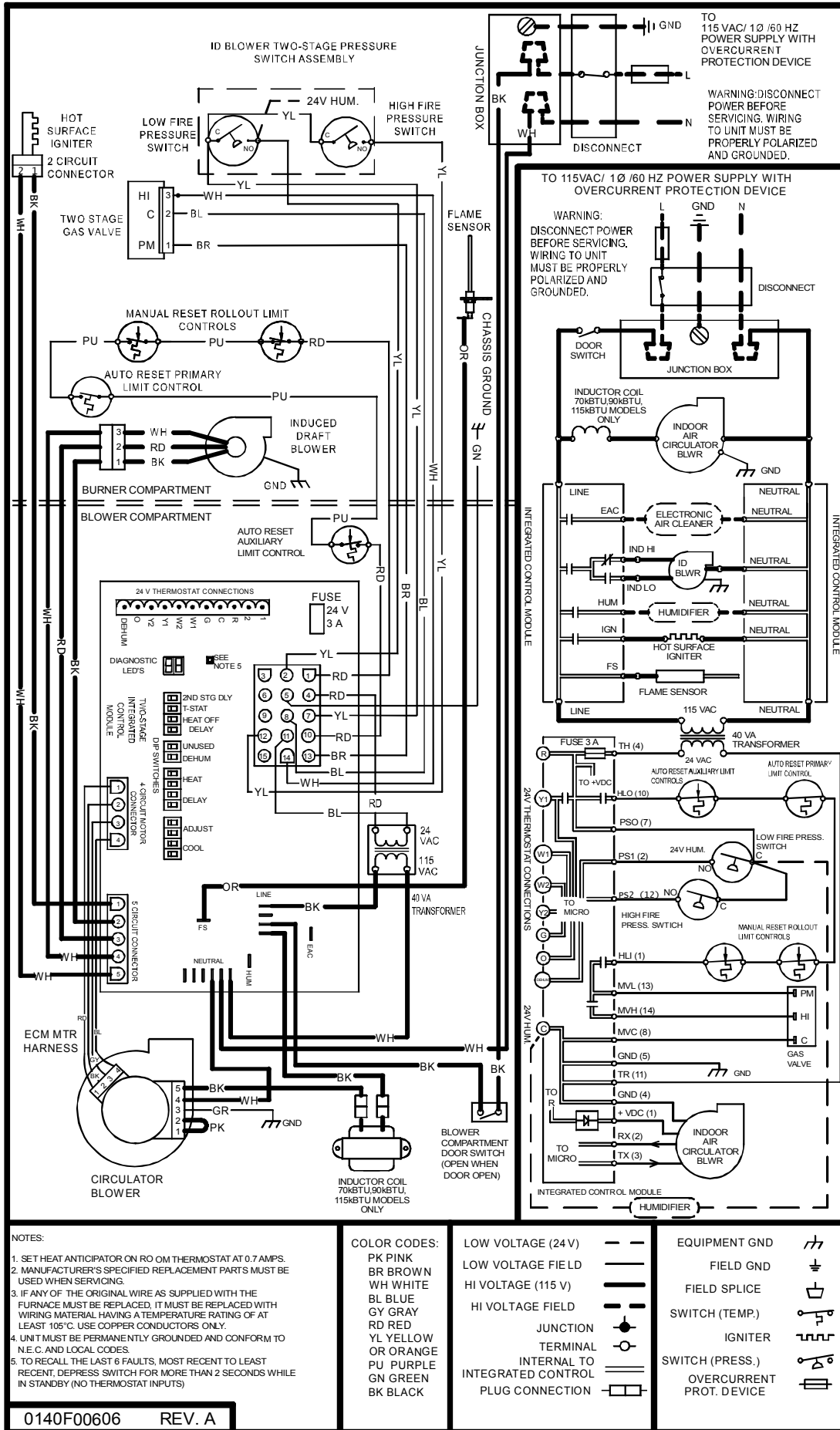

- NOTES:
1. SET HEAT ANTICIPATOR ON RO OM THERMOSTAT AT 0.7 AMPS.
 2. MANUFACTURER'S SPECIFIED REPLACEMENT PARTS MUST BE USED WHEN SERVICING.
 3. IF ANY OF THE ORIGINAL WIRE AS SUPPLIED WITH THE FURNACE MUST BE REPLACED, IT MUST BE REPLACED WITH WIRING MATERIAL HAVING A TEMPERATURE RATING OF AT LEAST 105°C. USE COPPER CONDUCTORS ONLY.
 4. UNIT MUST BE PERMANENTLY GROUNDED AND CONFORM TO N.E.C. AND LOCAL CODES.
 5. TO RECALL THE LAST 6 FAULTS, MOST RECENT TO LEAST RECENT, DEPRESS SWITCH FOR MORE THAN 2 SECONDS WHILE IN STANDBY (NO THERMOSTAT INPUTS)

COLOR CODES:

PK PINK
BR BROWN
WH WHITE
BL BLUE
GY GRAY
RD RED
YL YELLOW
OR ORANGE
PU PURPLE
GN GREEN
BK BLACK

LOW VOLTAGE (24 V)	---
LOW VOLTAGE FIELD	— — —
HI VOLTAGE (115 V)	— — —
HI VOLTAGE FIELD	— — —
JUNCTION	⊙
TERMINAL	○
INTERNAL TO INTEGRATED CONTROL	—
PLUG CONNECTION	⊞

EQUIPMENT GND	⏏
FIELD GND	⏏
FIELD SPLICE	⏏
SWITCH (TEMP.)	⏏
IGNITER	⏏
SWITCH (PRESS.)	⏏
OVERCURRENT PROT. DEVICE	⏏

0140F00606 REV. A

Wiring is subject to change. Always refer to the wiring diagram on the unit for the most up-to-date wiring.

*MVC8_AB, *DVC8_AA WIRING DIAGRAM

HIGH VOLTAGE!
 DISCONNECT ALL POWER BEFORE SERVICING OR INSTALLING THIS UNIT.
 MULTIPLE POWER SOURCES MAY BE PRESENT. FAILURE TO DO SO MAY
 CAUSE PROPERTY DAMAGE, PERSONAL INJURY OR DEATH.

WARNING

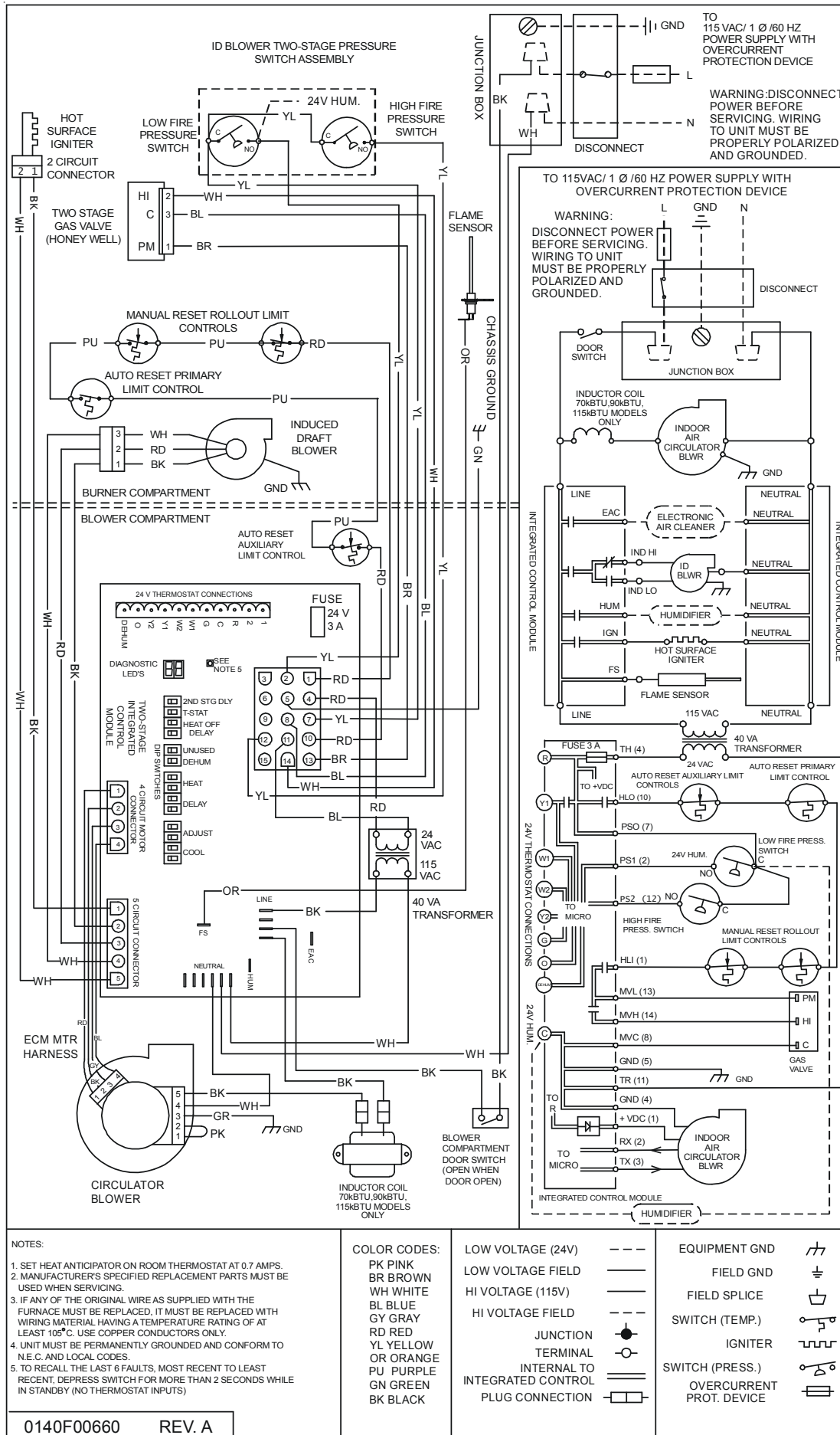

Wiring is subject to change. Always refer to the wiring diagram on the unit for the most up-to-date wiring.

Goodman Manufacturing Company, L.P.
5151 San Felipe, Suite 500, Houston, TX 77056
www.goodmanmfg.com
© 2009-2010 Goodman Manufacturing Company, L.P.

Free Manuals Download Website

<http://myh66.com>

<http://usermanuals.us>

<http://www.somanuals.com>

<http://www.4manuals.cc>

<http://www.manual-lib.com>

<http://www.404manual.com>

<http://www.luxmanual.com>

<http://aubethermostatmanual.com>

Golf course search by state

<http://golfingnear.com>

Email search by domain

<http://emailbydomain.com>

Auto manuals search

<http://auto.somanuals.com>

TV manuals search

<http://tv.somanuals.com>