

**USE THIS INSTRUCTION SHEET AS A TEMPLATE.**

Width of cutout (13-1/8") is equal to the width of this sheet.

Length of cutout (16-1/2") is equal to the length of this sheet.

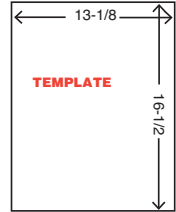

No. 000-0752-077 • Rev 5/05 HBP



## Installation Instructions and Mounting Template for Model HUM-FP High-Capacity Fan-Powered Flow-Thru Humidifier



**WARNING:** This product must be installed by a qualified heating and air conditioning contractor. Failure to comply could result in serious injury from electrical shock, or damage to humidifier or heating appliance, or void all warranties.

**ADDITIONAL WARNINGS:**

1. Disconnect electrical power to the furnace before starting installation to avoid serious injury or electrocution.
2. Use care when cutting plenum openings and handling ductwork. Sharp edges may cause serious injury.
3. Do not cut or drill any air conditioning or electrical accessories during installation. Electrocution is possible if you come in contact with a live electrical wire. Blindness can occur if refrigerant contacts your eyes.

**CAUTIONS:**

1. Do not install the unit where freezing temperatures could occur, or where temperatures could exceed 180°F.
2. Do not install the unit on a furnace jacket.
3. Do not install the unit on a plenum face where the blanked-off ends of the cooling coil restrict air movement through the humidifier.
4. Do not set humidity higher than recommended. Condensation damages may result.
5. Do not set humidity up to recommended levels if there is condensation on the inside windows of any living space. Condensation damage may result.
6. Do not install the unit on any plenum where static pressure exceeds 0.4" W.C.
7. Do not install the unit where water pressure exceeds 125 psi. Leakage may result.
8. Be sure that the installation, wiring and plumbing on the humidifier comply with local codes, ordinances and regulations.

**IMPORTANT:**  
 Humidifier  
 Placement  
 Information

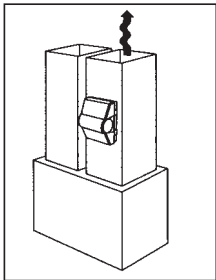

Mount the Model HUM-FP Fan-Powered Flow-Thru Humidifier on the **WARM AIR PLENUM ONLY**.

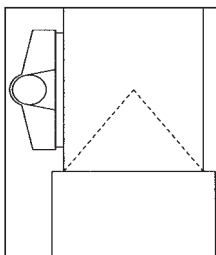

Position the humidifier as shown in relation to the AC cooling coils.

## STEP-BY-STEP INSTALLATION INSTRUCTIONS



1. Tape the template (this entire sheet) onto the warm air furnace plenum, making sure it is level.



2. Trace around the template. (Cutout size is 13-1/8" wide by 16-1/2" long.) Remove the template. Accurately cut the plenum opening.



3. Disconnect the humidifier control wires by grasping the nylon connector firmly and pulling straight out.



4. Remove the cover by turning the thumb screw (circled) counter clockwise. Tilt and lift the cover off the frame.



5. Pull out the drip tray and evaporator pad assembly by grasping the top lip and tipping out.



6. Place the mounting frame into the plenum opening so that the frame hooks over the bottom of the opening. Screw the frame to the plenum.



7. Stand the evaporator pad upright with the black index mark on top. Make sure the wick is seated securely in the drip tray.



8. Place the drip tray on top of the pad. Reinstall the evaporator pad and drip tray.



9. Reattach the cover assembly by hooking it at the top of the mounting frame. Secure the cover by turning the thumb screw at the bottom clockwise.



10. Position the humidistat on either an interior wall of the home or the return air plenum of the furnace. Install by following the instructions in the parts bag.



Toll-free Contractor Helpline: 888-SKUTTLE (758-8853)  
 Contractor E-line: techservice@skuttle.com

**See Additional Instructions on Back** ▶▶▶

# Model HUM-FP INSTALLATION INSTRUCTIONS (cont'd.)



## WARNINGS:

Shut off power before wiring.

**DO NOT** wire the Model HUM-FP humidifier to a circuit board **UNLESS** the board connections are 120 VAC. If, and only if, they are 120 VAC, install a receptacle and wire it to the board connections. Plug the humidifier into the receptacle.

**DO NOT**, under any circumstances, wire the yellow solenoid wires to the curcuit board, or any other power source!

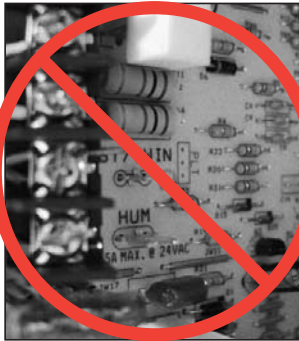

**Wiring Diagram A**

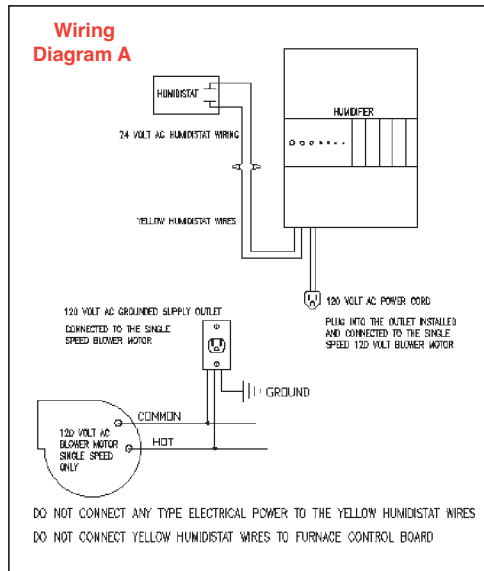

**11a. Wiring Diagram A: Single-Speed Blower.** For wiring with a 120 VAC single-speed blower, locate the blower motor junction box. Wire in a receptacle for the 120 VAC humidifier plug. This will coordinate the humidifier and furnace system operations.

**Wiring Diagram B**

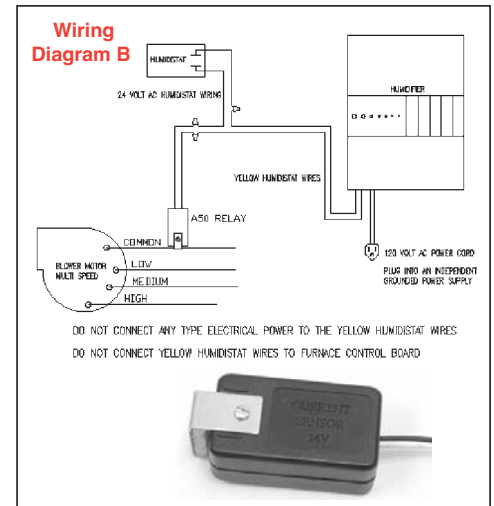

**11b. Wiring Diagram B: Multi-Speed Blower.** For wiring with a multi-speed blower, use an HUM-A50 Current Sensing Relay with an existing or independently wired, field-installed 120 VAC outlet. Plug the humidifier into the outlet.



**12.** Tap into the water supply line using the saddle valve provided. Follow the directions on the saddle valve bag.

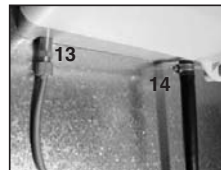

**13.** Connect **copper tubing** from the saddle valve to the solenoid valve. (**Do not use plastic tubing.**) Check for leaks.

The saddle valve must be fully opened or closed. Do not use the valve to regulate water flow.

**14.** Attach a 1/2" I.D. vinyl hose and clamp to carry the flushing water from the unit to the drain. Be sure the drain hose has a constant pitch to the floor drain. **To avoid damage to the drain fitting, do not use solvent type adhesives when connecting the plastic hose to the humidifier.**



**15.** Test operation. Check for water leaks. Be sure the humidistat is operating properly.

## Free Manuals Download Website

<http://myh66.com>

<http://usermanuals.us>

<http://www.somanuals.com>

<http://www.4manuals.cc>

<http://www.manual-lib.com>

<http://www.404manual.com>

<http://www.luxmanual.com>

<http://aubethermostatmanual.com>

Golf course search by state

<http://golfingnear.com>

Email search by domain

<http://emailbydomain.com>

Auto manuals search

<http://auto.somanuals.com>

TV manuals search

<http://tv.somanuals.com>