

Owner's Manual

Model
TSTATG2111

Use with most
systems:
2-Heat, 1-Cool

1-Day Programmable Digital Thermostat up to 2-Heat & 1-Cool



- Control up to 2 Heat & 1 Cool Stages
- Backlit Display
- Aux Heat Indicator
- Outdoor Sensor Ready
- Accepts Optional EZ Programmer,[™] IR Remote Control, or Comfort Call[™] Phone Accessories

Configurable in Setup:

- Auto or Manual changeover
- Programmable or Non-Programmable

Goodman
Air Conditioning & Heating

 **CAUTION**

Follow the Installation Instructions before proceeding.
Set the thermostat mode to "OFF" prior to changing
settings in setup or restoring Factory Defaults.

This device complies with Part 15 of the FCC Rules. Operation is subject to the following two conditions: (1) this device may not cause harmful interference, and (2) this device must accept any interference received, including interference that may cause undesired operation.

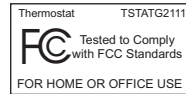

How to Use This Manual



The Table of Contents divides the thermostat features into sections making it easier to quickly find information.

The first page of each section contains a more detailed Table of Contents for each section, such as the example page shown below.

The screenshot shows the first page of Section 14, titled "Timers and Deadbands". At the top left, a header box contains "SECTION 14" and "Timers and Deadbands". To the right of this header is the Goodman logo. Below the header, the text "Section 14 Contents:" is followed by a bulleted list of sub-sections with page numbers: "Adjusting the Heat/Cool Differential.....14.2", "Adjusting the Cycles Per Hour.....14.3", "Adjusting the Deadband.....14.4", "Adjusting the Minutes of Run-Time Before the Next Stage.....14.6", and "Selecting 2nd Stage Turn Off Temperature.....14.7". A small black box with the number "14" is positioned to the right of the "Adjusting the Minutes of Run-Time..." entry. At the bottom left of the page, it says "Page 14.1".

Header shows section # and title of section

Section contents

Visible section tab on the side of the page

Section and page #

In addition, this manual also has an Index to help you find any information regarding this thermostat quickly.

Glossary of Terms



Auto-Changeover: A mode in which the thermostat will turn on the heating or cooling based on room temperature demand.

Cool Setpoint: The warmest temperature that the space should rise to before cooling is turned on (without regards to deadband).

Deadband: The number of degrees the thermostat will wait, once setpoint has been reached, before energizing heating or cooling.

Differential: The forced temperature difference between the *heat setpoint* and the *cool setpoint*.

Heat Setpoint: The coolest temperature that the space should drop to before heating is turned on (without regards to deadband).

Icon: The word or symbol that appears on the thermostat display.

Mode: The current operating condition of the thermostat (i.e. Off, Heat, Cool, *Auto*, Program On).

Non-Programmable Thermostat: A thermostat that does not have the capability of running the *Time Period Programming*.

Programmable Thermostat: A thermostat that has the capability of running the *Time Period Programming*.

Temperature Swing: *Same as Deadband*.

Time Period Programming: A program that allows the thermostat to automatically adjust the *heat setpoint* and/or the *cool setpoint* based on the time of day.

Table of Contents



<i>Getting to Know Your Thermostat</i>	1
<i>Quick Start</i>	2
<i>Setting Clock</i>	3
<i>Basic Operation</i>	4
<i>Viewing the Outdoor Temperature</i>	5
<i>Programming the Daily Schedule</i>	6
<i>Programming the Fan Operation</i>	7
<i>Thermostat Display Options</i>	8
<i>Programming Run-Time Alerts</i>	9
<i>Electric Heat and Heat Pump Operation</i>	10
<i>Timers and Deadbands</i>	11
<i>Factory Defaults and Calibration</i>	12
<i>Accessories</i>	13
<i>Advanced Setup Table</i>	14

SECTION 1

Getting to Know Your Thermostat



1

Section 1 Contents:

- *Front Panel Buttons*.....1.2
- *Display Features*.....1.3

Front Panel

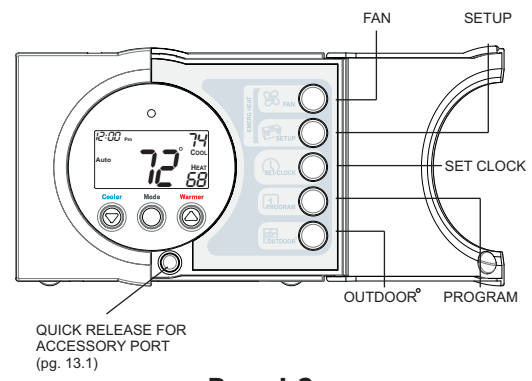
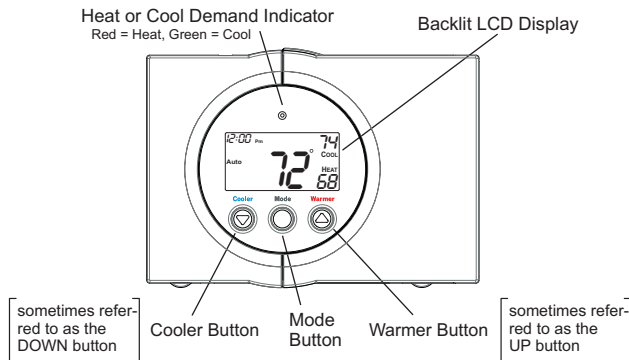

1 Display Features

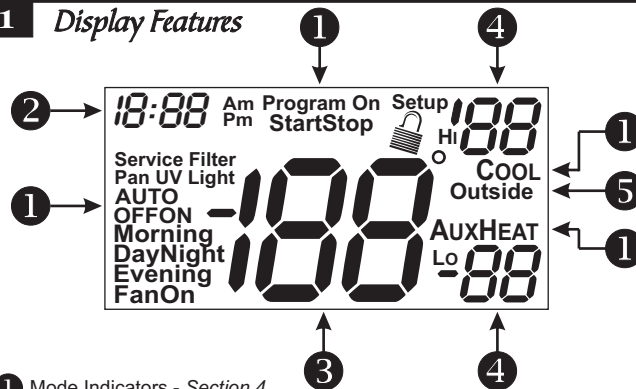

- 1** Mode Indicators - *Section 4*
 Selects the operational mode of the equipment.
HEAT - Indicates the heating mode.
COOL - Indicates the air conditioning mode.
AUTO - Indicates the system will automatically changeover between heat and cool modes as the temperature varies.
OFF - Indicates heating and cooling is turned off.
PROGRAM ON - Indicates the time period program is enabled to run.
- 2** Clock - *Section 3*
 Indicates the current time. This clock is also used to program the time period schedule.
- 3** Room Temperature Display - *Section 5*
 Indicates the current room temperature and displays the outdoor temperature when selected.
- 4** Desired Set Temperature - *Section 4/5*
 Indicates desired room temperature(s).
- 5** Outside icon - *Section 5*
 Indicates the temperature displayed is from the optional outdoor sensor.
- 6** Morning, Day, Evening & Night icons - *Section 6*
 Indicates the day part of the time period program.

Display Features

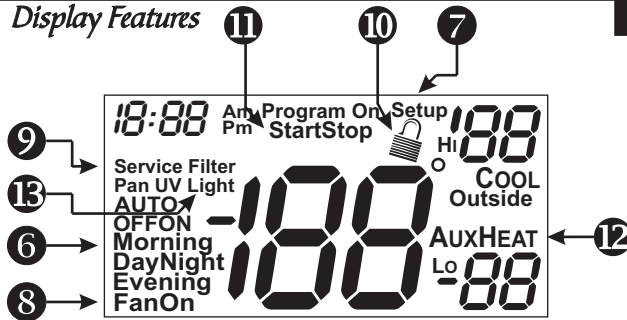

- 7** **Setup icon** - Sections 6-11
Indicates the thermostat is in the setup mode.
- 8** **Fan On icon** - Section 7
Indicates constant, continuous fan operation.
When **Fan On** is not lit - indicates the fan will only operate when necessary to heat or to cool.
- 9** **Service Filter icon** - Section 9
Appears when the filter should be serviced under normal conditions.
Adjustable from 0 - 1950 hours of blower operation.
- 10** **Padlock icon** - Section 8
Indicates the keypad has been locked.
- 11** **Start/Stop icon** - Section 6
Appears when programming timer functions.
- 12** **AuxHeat icon** - Page 11.4
Indicates the Heat Pump is currently using 2nd stage electric strip heat.
- 13** **UV Light icon** - Section 9
Appears when the UV bulb should be serviced under normal conditions. Adjustable from 0 - 1990 days of operation.

SECTION 2 *Quick Start*



2

Section 2 Contents:

- **Setting the Clock2.2**
- **Selecting the Heat or Cool
Mode.....2.3**
- **Selecting Your Desired
Temperature.....2.4**
- **Using the Fan Button.....2.4**

***Note:** Following the instructions in this section will allow you to operate your thermostat using the factory default settings. These settings are depicted in the illustrations throughout this manual.*

Page 2.1

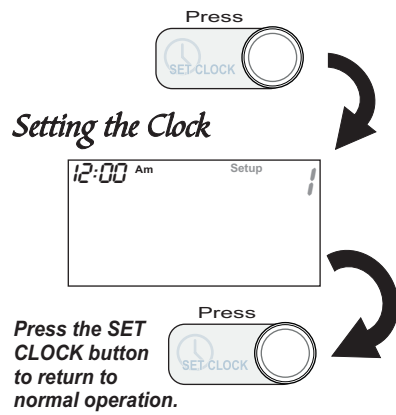

*During Setup & Programming:
Pressing the UP or DOWN
buttons will modify the flashing
selection.*

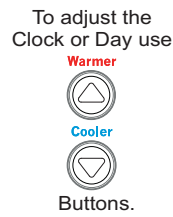

*To adjust the time by
hours press and hold
the FAN button while
pressing the UP or
DOWN buttons.*

Selecting the Heat or Cool Mode

2

Select Mode by Pressing the MODE Button

Heating Only

The **HEAT** setting indicates the temperature the room has to reach before the furnace will turn on to heat the room.

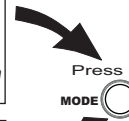

Cooling Only

The **COOL** setting indicates the temperature the room has to reach before the air conditioner will turn on to cool the room.



Heating or Cooling

AUTO will automatically select heat or cool based on room temperature demand.



Time Schedule for Heating or Cooling

The **Program On** setting will activate the time period programming for the cooling or heating setpoint ONLY (Morning, Day, Evening & Night Periods).



Off

OFF indicates both heating and air conditioning systems are turned off.



Selecting Your Desired Temperature (adjusting the setpoints)

2

AUTO OR PROGRAM MODE

Pressing the UP or DOWN buttons in Auto or Program mode will adjust **both** the heat and cool set temperatures simultaneously.

Adjust the desired set temperature with the



Warmer



Cooler



buttons.

HEAT OR COOL MODE

Pressing the UP or DOWN buttons in Heat or Cool mode will adjust only the heat or cool set temperature.

Adjust the desired set temperature with the



Warmer



Cooler



buttons.

Using the Fan Button



Press



Fan On indicates constant fan operation. You may turn the fan on even if the thermostat is in the **Off** mode. Pressing the FAN button toggles this feature on or off.

SECTION 3 *Setting the Clock*



3

Section 3 Contents:

- **Setting the Clock.....3.2**

Note: During setup & programming pressing the UP or DOWN buttons will modify the flashing selection.

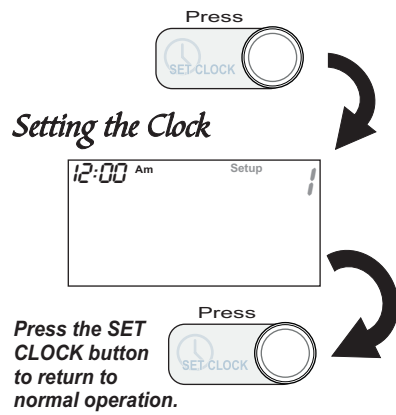

During Setup & Programming:
Pressing the UP or DOWN
buttons will modify the flashing
selection.

3

To adjust the
Clock or Day use

Warmer



Cooler



Buttons.

To adjust the time by
hours press and hold
the FAN button while
pressing the UP or
DOWN buttons.

SECTION 4
Basic Operation



4

Section 4 Contents:

- *Programmable or Non-Programmable Thermostat.....4.2*
- *Manual or Auto-Changeover Thermostat.....4.3*
- *Selecting the Operating Mode.....4.4*
- *Selecting Your Desired Temperature.....4.8*

Note: During setup & programming pressing the UP or DOWN buttons will modify the flashing selection.

Programmable or Non-Programmable Thermostat

When the very simplest operation is desired, this thermostat may be configured to be non-programmable, with or without Auto-Changeover. Follow the step below.

4

If 'NO' is selected, the thermostat will lockout the Program On screen; only the Off, Heat, Cool, and Auto screens may be accessed by pressing the MODE button.

Select 'YES' if you would like your thermostat to be **programmable**, then the Program mode will be accessible through the use of the MODE button.

 Press **SETUP** button to enter Setup screens.

Note: Press the MODE button momentarily to move through the setup screens. Press and hold the MODE button to move backwards through the setup screens.



Select Yes if you would like the thermostat to be programmable or No for non-programmable.

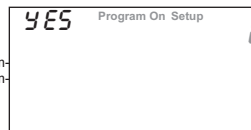

Press the SETUP button to leave the Setup screens. If no buttons are pressed, the display will leave the setup screens after 30 seconds.

Manual or Auto-Changeover Thermostat

4 When the very simplest operation is desired, this thermostat may be configured to be a manual heat and cool thermostat, with or without time period programmability. Follow the step below.

The thermostat may be programmed to function as a Heat Only or Cool Only thermostat by selecting 'NO' in the setup screen below. This will lockout the Auto-Changeover screen and only allow the Off, Heat, Cool, and Program On screens to be accessed.



Press **SETUP** button to enter Setup screens.



Press the **MODE** button repeatedly until this setup screen appears.

*Note: Press the **MODE** button momentarily to move through the setup screens. Press and hold the **MODE** button to move backwards through the setup screens.*



YES
Select Yes if you would like the thermostat to be Auto-Changeover or No for a Heat Only and Cool Only Thermostat.

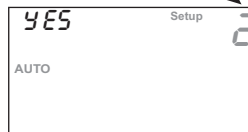

Press the **SETUP** button to leave the Setup screens. If no buttons are pressed, the display will leave the setup screens after 30 seconds.

Operating Mode when the Thermostat is Configured to be:

NON-PROGRAMMABLE WITH MANUAL CHANGEOVER - If the thermostat is configured to be a non-programmable thermostat with Manual Changeover, the following screens will be available by pressing the MODE button.

4

Select the Mode by Pressing the MODE Button

Heating Only
The **HEAT** setting indicates the temperature the room has to reach before the furnace will turn on to heat the room.



Cooling Only
The **COOL** setting indicates the temperature the room has to reach before the air conditioner will turn on to cool the room.





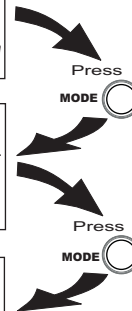





Off
OFF indicates both heating and air conditioning systems are turned off.



Operating Mode when the Thermostat is Configured to be:

4 NON-PROGRAMMABLE WITH AUTO-CHANGEOVER - If the thermostat is configured to be a non-programmable thermostat with Auto-Changeover, the following screens will be available by pressing the MODE button

Select the Mode by Pressing the MODE Button

<p>Heating Only The HEAT setting indicates the temperature the room has to reach before the furnace will turn on to heat the room.</p>		<p>Press MODE</p> 
<p>Cooling Only The COOL setting indicates the temperature the room has to reach before the air conditioner will turn on to cool the room.</p>		<p>Press MODE</p> 
<p>Heating or Cooling AUTO will automatically select heat or cool based on room temperature demand.</p>		<p>Press MODE</p> 
<p>Off OFF indicates both heating and air conditioning systems are turned off.</p>		<p>Press MODE</p> 

Operating Mode when the Thermostat is Configured to be:

PROGRAMMABLE WITH MANUAL CHANGEOVER - If the thermostat is configured to be a programmable thermostat with Manual Changeover, the following screens will be available by pressing the MODE button.

4

Select the Mode by Pressing the MODE Button

Heating Only

The **HEAT** setting indicates the temperature the room has to reach before the furnace will turn on to heat the room.

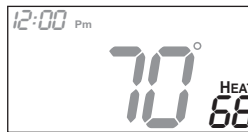

Press
MODE

Cooling Only

The **COOL** setting indicates the temperature the room has to reach before the air conditioner will turn on to cool the room.



Press
MODE

Time Schedule for Heating Only

The **HEAT Program On** setting will activate the time period program for the heating setpoint ONLY (Morning, Day, Evening & Night Periods).



Press
MODE

Time Schedule for Cooling Only

The **COOL Program On** setting will activate the time period program for the cooling setpoint ONLY (Morning, Day, Evening & Night Periods).



Press
MODE

Off

OFF indicates both heating and air conditioning systems are turned off.



Press
MODE

Page 4.6

Operating Mode when the Thermostat is Configured to be:

PROGRAMMABLE WITH Auto-Changeover - If the thermostat is configured to be a programmable thermostat with Auto-Changeover, the following screens will be available by pressing the MODE button.

4

Select the Mode by Pressing the MODE Button

Heating Only

The **HEAT** setting indicates the temperature the room has to reach before the furnace will turn on to heat the room.



Press

MODE

Cooling Only

The **COOL** setting indicates the temperature the room has to reach before the air conditioner will turn on to cool the room.



Press

MODE

Heating or Cooling

AUTO will automatically select heat or cool based on room temperature demand.



Press

MODE

Time Schedule for Heating or Cooling

The **Program On** setting will activate the time period programming for the cooling or heating setpoint ONLY (Morning, Day, Evening & Night Periods).



Press

MODE

Off

OFF indicates both heating and air conditioning systems are turned off.



Press

MODE

Page 4.7

Selecting Your Desired Temperature (adjusting setpoints)

AUTO OR PROGRAM MODE

Pressing the UP or DOWN buttons in Auto **or** Program modes will adjust **both** the heat and cool set temperatures simultaneously. For more information on this see page 11.2.

4

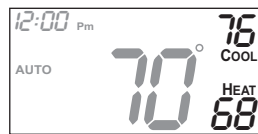

Adjust the desired set temperature with the

Warmer



Cooler



buttons.

HEAT OR COOL MODE

Pressing the UP or DOWN buttons in Heat **or** Cool modes will adjust only the heat **or** cool set temperature.



Adjust the desired set temperature with the

Warmer



Cooler



buttons.

SECTION 5
Viewing the Outdoor Temperature



5

Section 5 Contents:

- *Viewing the Outdoor Temperature.....5.2*

Viewing the Outdoor Temperature

This requires an outdoor sensor (optional accessory) to be installed (see page 4.6 of the *Installation Instructions*). To read the temperature from the Outdoor Sensor, press the OUTDOOR button. The display will then show the current outdoor temperature.

5

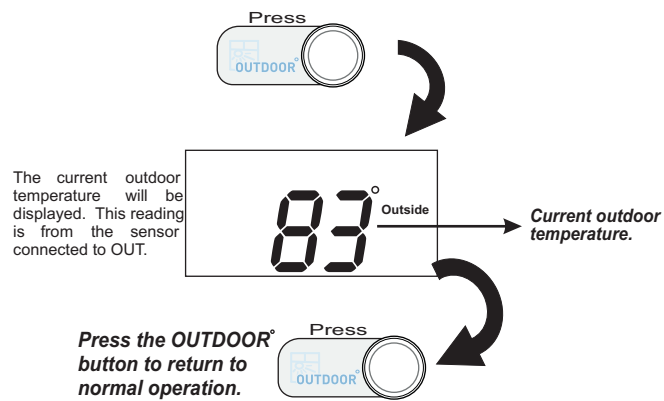

Note: If no sensors are connected 2 dashes [- -] will appear on the display.

Page 5.2

SECTION 6
Programming the Daily Schedule



Section 6 Contents:

6 ■ *Programming a Daily
Schedule.....6.2*

Programming a Daily Schedule

Press



Press the PROGRAM button to enter time period programming.

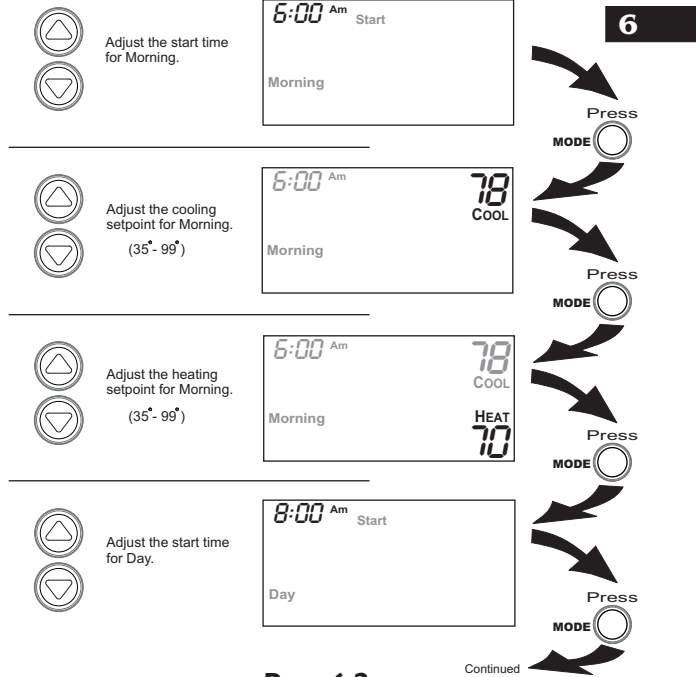

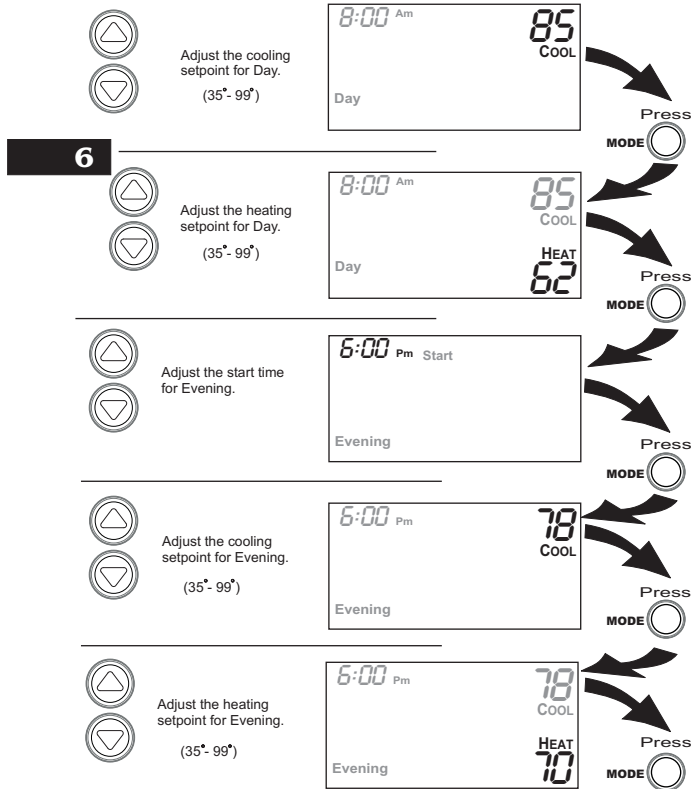

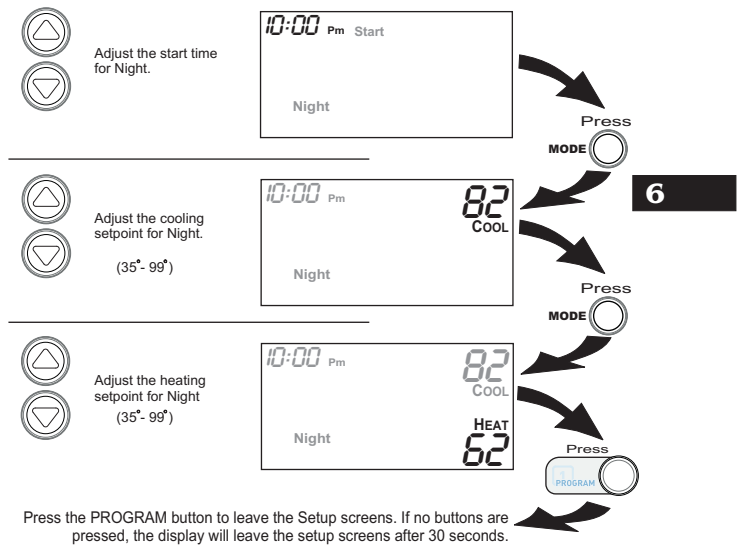

SECTION 7
Programming the Fan Operation



Section 7 Contents:

7	■ <i>Using the Fan Button.....</i>	7.2
	■ <i>Setting the Fan-Off Time</i>	
	■ <i>Delay.....</i>	7.3

Using the Fan Button

When the fan is set for automatic operation it will energize any time there is a call for heating or cooling, otherwise the fan will remain off. Pressing the FAN button will energize the fan and display the **FanOn** icon on the thermostat display. To operate the fan in the automatic mode, press the FAN button again and the FanOn icon will disappear.



7

Fan On indicates constant fan operation. You may turn the fan on even if the thermostat is in the **Off** mode. Pressing the FAN button toggles this feature on or off.

Setting the Fan-Off Time Delay

To increase the cooling efficiency of your unit, the thermostat may be programmed to continue running the fan after a call for cooling has been satisfied. This delay may be set for 30, 60, or 90 seconds. If the Fan Off Delay is set for zero seconds, the fan will not energize after a call for cooling has been satisfied.

7



Press **SETUP** button to enter Setup screens.



Press the **MODE** button repeatedly until this setup screen appears.

*Note: Press the **MODE** button momentarily to move through the setup screens. Press and hold the **MODE** button to move backwards through the setup screens.*



Set the Fan Off Delay to 0, 30, 60, or 90 seconds.

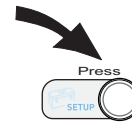

Press the **PROGRAM** button to leave the Setup screens. If no buttons are pressed, the display will leave the setup screens after 30 seconds.

SECTION 8
Thermostat Display Options





Section 8 Contents:

- *Turning On/Off the Backlight.....8.2*
- *Programming the Thermostat to Display Temperature in Fahrenheit or Celsius.....8.2*
- *Locking/Unlocking the Keypad.....8.3*

Turning On/Off the Backlight

8

 Press **SETUP** button to enter Setup screens.

 Press the **MODE** button repeatedly until this setup screen appears.

Note: Press the **MODE** button momentarily to move through the setup screens. Press and hold the **MODE** button to move backwards through the setup screens.

Select backlight operation:
AUTO - Light from 6pm to 6am nightly.
ON - Light continuously.
OFF - Light for 8 seconds after a button press.





Press 

Programming the Thermostat to Display Temperature in Fahrenheit or Celsius

 **C**
Select thermostat operation in degrees Fahrenheit or Celsius.

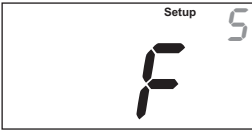
 **F**





Press 

Press the **PROGRAM** button to leave the Setup screens. If no buttons are pressed, the display will leave the setup screens after 30 seconds.

Locking/Unlocking the Keypad

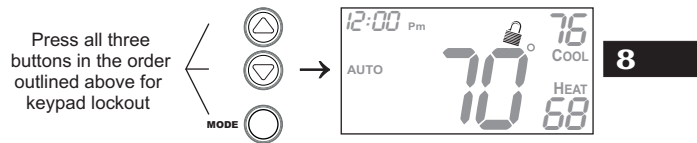
To prevent unauthorized use of the thermostat, the front panel buttons may be disabled. To disable, or 'lock' the keypad, press and hold the MODE button. While holding the MODE button, press the UP and DOWN buttons together. The  icon will appear on the display, then release the buttons.



To **unlock** the keypad, press and hold the MODE button. While holding the MODE button, press the UP and DOWN buttons together. The  icon will disappear from the display, then release the buttons.

SECTION 9
Programming Run-Time Alerts



Section 9 Contents:

- *Setting and Resetting the Service Filter (Fan Run-Time) Alert.....9.2*
- *Setting and Resetting the UV Light Run-Time Alert.....9.3*

9

How to Set and Reset the Service Filter (Fan Run-Time) Alert

This counter keeps track of the number of hours of fan run-time whether the fan is energized in the Heating or Cooling modes, or in stand alone fan operation. The Service Filter icon will appear after the preset number of hours of fan run-time in step #7 (below) has been achieved. Setting this counter to zero in step #7 will prevent the Service Filter icon from ever appearing.

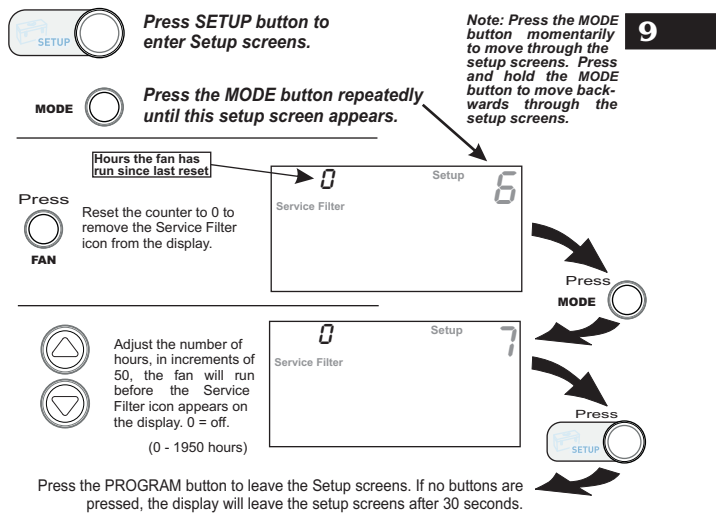

How to Set and Reset the UV Light Run-Time Alert

This counter keeps track of the number of days since the UV Light counter has been reset. The UV Light icon will appear after the number of days has been achieved, as shown in step #9 (below). Setting the counter to zero in Step #9 will prevent the Service UV Light icon from ever appearing.

9  Press **SETUP** button to enter Setup screens.

 Press the **MODE** button repeatedly until this setup screen appears.

Note: Press the MODE button momentarily to move through the setup screens. Press and hold the MODE button to move backwards through the setup screens.

Days since the UV Light icon has been reset

Press  Reset the counter to 0 to remove the Service UV Light icon from the display.



 Press the **MODE** button repeatedly until this setup screen appears.

 Adjust the number of days in increments of 10 before the UV Light icon appears on the display. 0 = off.
(0 - 1990 days)

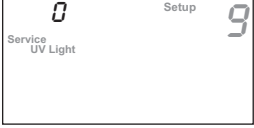

Press 

Press the **PROGRAM** button to leave the Setup screens. If no buttons are pressed, the display will leave the setup screens after 30 seconds.

SECTION 10
Electric Heat and Heat Pump Operation



Section 10 Contents:

- *Viewing the Heat Pump and Reversing Valve Jumper Setting.....10.2*
- *Viewing the Electric Heat Jumper Setting.....10.3*
- *Using Emergency Heat.....10.4*

Viewing the Heat Pump and Reversing Valve Jumper Settings

Steps 10 and 11 are 'Read Only' and may only be set with the jumpers on the circuit board of the thermostat (see page 4.4 of the Installation Instructions).

10

 Press **SETUP** button to enter Setup screens.

 Press the **MODE** button repeatedly until this setup screen appears.

Note: Press the MODE button momentarily to move through the setup screens. Press and hold the MODE button to move backwards through the setup screens.

 ON = Heat Pump operation
OFF = Gas Electric operation

 Indicates that the thermostat jumper is set for an **O** reversing valve (energize in cooling) or a **b** reversing valve (energize in heating).





Press 

Press 

Press 

Press the PROGRAM button to leave the Setup screens. If no buttons are pressed, the display will leave the setup screens after 30 seconds.

Viewing the Electric Heat Jumper Setting

Placing the jumper on ELEC will cause the thermostat to turn on the fan immediately any time there is a heat demand. Since most gas furnaces control the fan, this feature should be off unless it is necessary for the thermostat to energize the fan with first stage heat.

Step 12 is 'Read Only' and may only be set with the jumpers on the circuit board of the thermostat (see page 4.3 of the *Installation Instructions*).

 Press **SETUP** button to enter Setup screens.

 Press the **MODE** button repeatedly until this setup screen appears.

Note: Press the **MODE** button momentarily to move through the setup screens. Press and hold the **MODE** button to move backwards through the setup screens.

10

 **ON** indicates that the thermostat jumper is set for Electric Heat operation, or **OFF** for Gas/Electric or Heat Pump operation.



 Press

Press the **PROGRAM** button to leave the Setup screens. If no buttons are pressed, the display will leave the setup screens after 30 seconds.

Using Emergency Heat

ENTER EMERGENCY HEAT: Only available if you have a Heat Pump installed. To initiate the Emergency Heat feature, press the FAN button. While holding the FAN button press the SETUP button. The Cool setpoint display will read 'EH' (emergency heat).

Press for
Emergency Heat

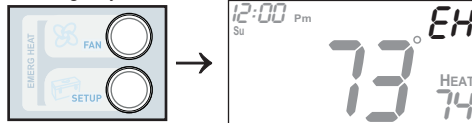

10

OPERATION: During Emergency Heat operation the thermostat will turn on the fan and the 2nd stage of heat when there is a demand for heat. Also during Emergency Heat the 1st stage of heating or cooling will be unavailable.

EXIT EMERGENCY HEAT: Follow the same steps as entering Emergency Heat by pressing the FAN and SETUP buttons. During Emergency Heat, only OFF and HEAT modes are available by pressing the MODE button.

SECTION 11
Timers and Deadbands



Section 11 Contents:

- *Adjusting the Heat/Cool
Differential.....11.2*
- *Adjusting the Cycles
Per Hour.....11.3*
- *Adjusting the Deadband.....11.4*

11



Adjusting the Heat/Cool Differential

The Heat and Cool setpoints will not be allowed to come any closer to each other than the value in this step. This minimum difference is enforced during Auto-Changeover operation.

 Press **SETUP** button to enter Setup screens.

 Press the **MODE** button repeatedly until this setup screen appears.

Note: Press the **MODE** button momentarily to move through the setup screens. Press and hold the **MODE** button to move backwards through the setup screens.

11   Adjust the minimum **difference** between cooling & heating setpoints. (0° - 6°)





Press the **PROGRAM** button to leave the Setup screens. If no buttons are pressed, the display will leave the setup screens after 30 seconds.

Note: To increase the spread between the heating and cooling setpoints, press the **MODE** button until only the heat setpoint is displayed. Adjust the desired setpoint. Wait two seconds after adjusting the set point so the thermostat can accept the change. Press the **MODE** button until only the cool setpoint is displayed. Adjust the desired setpoint. Wait two seconds after adjusting the set point so the thermostat can accept the change. Press the **MODE** button again to enter the Auto-Changeover mode where both the heat and cool setpoints are displayed.



Adjusting the Cycles Per Hour

The Cycles Per Hour setting may limit the number of times per hour your HVAC unit may energize. For example, at a setting of 6 cycles per hour the HVAC unit will only be allowed to energize once every 10 minutes. The Cycles Per Hour limit may be overridden and reset by pressing the UP or DOWN buttons on the thermostat.

 **Press SETUP button to enter Setup screens.**

MODE  **Press the MODE button repeatedly until this setup screen appears.**

Note: Press the MODE button momentarily to move through the setup screens. Press and hold the MODE button to move backwards through the setup screens.

 Select the cycles per hour limit.
 d=cycles per hour limit defeated.
 d1=d + defeat 5 min. compressor lockout.
 (d1, d, 2 - 6)

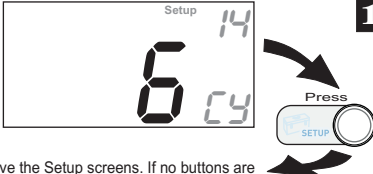

11

Press the SETUP button to leave the Setup screens. If no buttons are pressed, the display will leave the setup screens after 30 seconds.

Adjusting the Deadband

MULTI-STAGE OPERATION - Controls up to two Heat and one Cool stages.

The **2nd Stage** of heat is turned on when:

(A) The 1st Stage has been on for a minimum of two minutes.

And

(B) The temperature spread from the setpoint is equal to or greater than: *the setpoint plus the 1st stage deadband (step #15, next page), plus two degrees.*

11

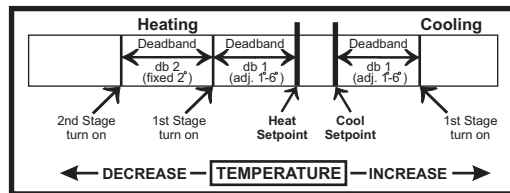



Adjusting the Deadband

For more detailed information, please see the explanation on the previous page.

 Press **SETUP** button to enter Setup screens.

 Press the **MODE** button repeatedly until this setup screen appears.

 Adjust the deadband for the 1st stage.
 (1° - 6°)

Note: Press the MODE button momentarily to move through the setup screens. Press and hold the MODE button to move backwards through the setup screens.



 **11**

Press the **PROGRAM** button to leave the Setup screens. If no buttons are pressed, the display will leave the setup screens after 30 seconds.

SECTION 12
Factory Defaults and Calibration



Section 12 Contents:

- *Resetting the Thermostat to the
Factory Default Settings.....12.2*
- *Calibrating the Temperature
Sensor.....12.3*

12

Calibrating the Temperature and Humidity Sensors

Under normal circumstances it will not be necessary to adjust the calibration of the temperature and humidity sensors. If calibration is required, please contact a trained HVAC technician to correctly perform the following procedure.

1

MODE  Place the thermostat in the OFF mode.

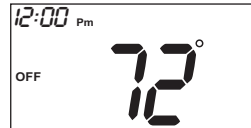

2

12

MODE  Press and hold the MODE button. While holding the MODE button, press and hold the FAN button for 5 seconds. All icons will appear on the display.



3

PRESS



TWICE

THERMOSTAT SENSOR

Press the UP and DOWN buttons at the same time twice. The thermostat temperature will be displayed and may be calibrated using the UP or DOWN buttons.



CALIBRATE



After calibration is complete, press the MODE button **once** to return to normal operation.

SECTION 13

Accessories

Goodman
Air Conditioning & Heating

ACCESSORY PORT - The RJ11 Jack is used to connect the TSTATG2111 to the IR Receiver (TSTATGAC0431) for wireless communication or the EZ Programmer (TSTATGAC0432) for easy downloading or uploading of thermostat information.

The Accessory Port is located on the bottom of the thermostat.

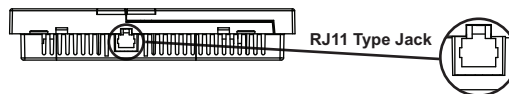

IR RECEIVER / REMOTE CONTROL (optional accessory) - When the IR Receiver is connected, the thermostat can be controlled using an IR Remote Control. The thermostat may also interface with other wireless systems in your home. For more information see the manual for the IR Receiver (TSTATGAC0431).

EZ PROGRAMMER (optional accessory) - When the EZ Programmer is connected, the thermostat Time Period Programming and Advanced Setup Programming can be stored into the EZ Programmer's memory. This information can then be uploaded to other TSTATG2111 thermostats. For more information see the manual for the (TSTATGAC0432).

COMFORT CALL (optional accessory) - When Comfort call is connected, the thermostat's Heating and cooling functionality may be accessed and controlled through the phone. For more information see the manual for Comfort Call (TSTATGAC0433).

SECTION 14 Advanced Setup Table



Step#	Description	Pg#	Range	Df *	Step#	Description	Pg#	Range	Df *
1	Programmable Thermostat	4.2	Yes/No	Yes	8	Reset UV Light Icon	9.3	read only	--
2	Auto-Changeover Thermostat	4.3	Yes/No	Yes	9	UV Light Run-Time Set	9.3	0 - 1990	0
3	Fan Off Delay	7.3	0, 30, 60, 90	0	10	Heatpump Jumper Setting	10.2	read only	--
4	Thermoglow Backlight	8.2	Auto/On/Off	Auto	11	Reversing Valve Jumper Setting	10.2	read only	--
5	F or C	8.2	F/C	F	12	Electric Heat	10.3	read only	--
6	Reset Service Filter Icon	9.2	read only	--	13	Minimum Heat/Cool Differential	11.2	0 - 6	2
7	Service Filter Run Time Set	9.2	0 - 1950	0	14	Cycles Per Hour	11.3	d1, d, 2-6	6
					15	Deadband/Temp. Swing	11.5	1° - 6°	2

14

*Df = Factory Default Setting

Page 14.1



Accessory Port, 13.1

Alerts

see *Run-Time*

Auto

adjust temperature, 2.4, 4.8
changeover, 1.3, 11.2, 4.3, 4.5, 4.7, 14.1
differential, see *Differential*
fan, 7.2
icon, 1.3
lockout, 4.3
mode, 2.3

AuxHeat icon, 1.4



b reversing valve, 10.2

Buttons

down, 1.2, 2.2, 2.4, 8.3, 12.3
emer ht., 1.2, 10.4
fan, 1.2, 2.4, 7.2, 12.2
front panel, 1.2
mode, 1.2, 2.3, 4.2, 8.3, 12.2
outdoor, 1.2, 5.2
program, 1.2, 4.2, 6.2

set clock, 1.2, 2.2
up, 1.2, 2.2, 8.3,



C, 8.2, 14.1

Calibration, 12.3

Celsius, 8.2

Clock

display, 1.3
setting, 2.2, 3.2

Compressor Lockout, 11.3

Cool

deadband, see *Deadband*
droop, see *Deadband*
electric/heat pump, 10.2
icon, 1.3
indicator, 1.2
mode, 2.3
program, see *Program*
setpoint, 2.3-2.4, 6.2-6.4

Cycles Per Hour, 11.3 14.1



Day

icon, 1.3
programming, 6.3
setting, 1.2, 2.2, 3.2

Deadband

1st stage, 11.4-11.5, 14.1

Delay

fan-off, see *Fan*

Differential

heat and cool, 11.2, 14.1

Disabled Keypad

see *Keypad Lockout*



EH, 10.4

Electric Heating

AuxHeat icon, 1.4
jumper setting, 10.3 14.1

Emergency Heat, 10.4

EZ Programmer, 13.1



F 8.2, 14.1
Factory Defaults
 caution, ii
 resetting, 12.2
 settings, 12.2
Fahrenheit, 8.2
Fan
 button function, see *Buttons*
 off time delay, 7.3, 14.1
 on during heat, see *Electric Heat*
 on icon, 1.4, 2.4, 7.2
 run-time, 9.2
 2nd stage heat, see *Emergency Heat*
Fd, 12.2
Flashing Selection, 2.2



Gas Furnace
 control the fan, 10.3
 jumper, 10.2
Green Indicator, 1.2



Heat
 1st stage
 deadband, see *Deadband*
 emergency heat, 10.4
 2nd stage
 emergency heat, 10.4
 electric strip heat, 1.4
 AuxHeat icon, 1.4
 deadband, see *Deadband*
 droop, see *Deadband*
 electric/heat pump, 10.2
 icon, 1.3-1.4
 indicator, 1.2
 mode, 2.3
 program, see *Program*
 setpoint, 2.3-2.4, 6.2-6.4
Heat Pump
 AuxHeat, 1.4
 emergency heat, 10.4
 jumper setting, 10.2



IR Receiver, 13.1



Jumpers
 electric heat, 10.3
 gas electric, 10.2
 heat pump, 10.2, 14.1
 reversing valve, 10.2, 14.1



Keypad Lockout, 1.4, 8.3



LCD, 1.2
Locked Indication
 see *Keypad Lockout*



Manual

changeover, 4.3-4.4,
4.6
cool, 4.3
heat, 4.3

Multi-stage

Operation, 11.4



**Non-Programmable
Thermostat, 4.2,
4.4-4.5**



**O Reversing Valve,
10.2**

Off Mode, 1.3, 2.3

Outdoor

button, see *Buttons*
icon, 1.3
sensor, 1.3, 5.2,
viewing temperature,
1.3, 5.2



Program

daily schedule, 6.2-
6.4
mode, 1.4, 4.6-4.7
On icon, 2.3

**Programmable
Thermostat,
4.2, 4.6-4.7**



Red Indicator, 1.2

Reset

thermostat settings,
see *Factory Defaults*
run-time
fan/filter, 9.2,
14.1
UV light, 9.3,
14.1

**OUT, see *Outdoor*
Sensor**

Run-Time

resetting, see *Reset*
setting,
service filter, 9.2
14.1

UV light, 9.3,
14.1



Schedule

daily, see *Program*

Sensor

outdoor, see *Outdoor*
thermostat, see
Thermostat Sensor

Service

filter icon, see *Reset*
UV light, see *Reset*

Set Clock, see *Clock*

Setpoint

cool, see *Cool*
heat, see *Heat*

Setup Icon, 1.4

**Simplest Operation,
4.2-4.3**



Thermostat Sensor

calibrate, 12.3

Time, see *Clock*

Time Delay,

compressor lockout,
11.3

cycles per hour,
11.3, 14.1

Time Schedule,
see Program



UV Light
icon, 1.4
resetting, *see Reset*
run-time, *see Run-Time*
setting, *see Run-Time*



Warranty, 16.1

SECTION 16

LIMITED WARRANTY

Models: TSTAT*1100, 2100, 1152, and 2152

*2200C, *3271C, *3272C, *2111, *3272, *3273

This thermostat is warranted by Goodman Manufacturing Company, L.P. ("Goodman") to be free from defects in materials and workmanship under normal use and maintenance, as described below:

• The thermostat is warranted for a period of **ONE YEAR**, except as provided below.

No warranty continues after the thermostat is removed from the location where it was originally installed.

No warranty applies to, and no warranty is offered by Goodman on, any thermostat ordered over the Internet.

The warranty period begins on the date of the original installation. If that date cannot be verified, the warranty period begins twelve weeks from the date of manufacture (as indicated by the first four digits of the serial number (yyww) where "yy" indicates the year and "ww" indicates the week of manufacture).

As its only responsibility, and your only remedy, Goodman will, without charge, replace any thermostat or thermostat part found to be defective due to workmanship or materials under normal use and maintenance. For warranty credit, the defective thermostat or thermostat part must be returned to a Goodman heating and air conditioning products distributor by a state certified or licensed contractor.

This warranty does not apply to labor, freight, or any other cost associated with the service, repair or operation of the unit.

This warranty is in lieu of all other express warranties. **ALL IMPLIED WARRANTIES, INCLUDING BUT NOT LIMITED TO WARRANTIES OF MERCHANTABILITY AND FITNESS FOR PARTICULAR PURPOSE, ARE LIMITED TO THE DURATION OF THIS WARRANTY.**

Some states and provinces do not allow limitations on how long an implied warranty lasts, so the above limitation may not apply to you.

GOODMAN SHALL IN NO EVENT BE LIABLE FOR INCIDENTAL OR CONSEQUENTIAL DAMAGES, INCLUDING BUT NOT LIMITED TO EXTRA UTILITY EXPENSES OR DAMAGES TO PROPERTY. Some states and provinces do not allow the exclusion or limitation of incidental or consequential damages, so the above exclusion may not apply to you.

Goodman is not responsible for:

1. Damage or repairs required as a consequence of faulty installation or application.
2. Damage as a result of floods, fires, winds, lightning, accidents, corrosive atmosphere or other conditions beyond the control of Goodman.
3. Use of components or accessories not compatible with this thermostat.
4. Products installed outside the United States or Canada.
5. Damage or repairs required as a result of any improper use, maintenance, operation or servicing.
6. Failure to start due to interruption and/or inadequate electrical service.
7. Changes in the appearance of the unit that do not affect its performance.

This warranty gives you specific legal rights, and you may also have other rights that may vary from state to state or province to province.

Installer Name _____
Installation Date _____
Model # _____
Serial # _____

*Amana® & Goodman® brand products

For further information about this warranty, contact Goodman Consumer Affairs at (877) 254-4729 or by mail to 7401 Security Way, Houston, Texas 77040.

© 2009 Goodman Manufacturing Company, L.P.

Resetting the Thermostat to the Factory Default Settings (for default values see page 14.1)

If, for any reason, you desire to return all the stored settings back to the factory default settings, follow the instructions below.

WARNING: This will reset all Time Period and Advanced Programming to the default settings. Any information entered prior to this reset may be permanently lost.

1



Place the thermostat in the OFF mode.

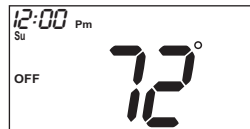

2



Press and hold the MODE button. While holding the MODE button, press and hold the FAN button for 5 seconds. All icons will appear on the display.



12

3



After all of the icons appear, release the MODE and FAN buttons. Then press and hold the FAN button for 5 seconds.



4



After the letters Fd appear on the display (Factory Default), release the FAN button. Press the MODE button once to return to normal operation.

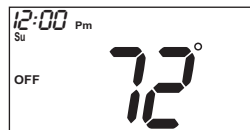

Free Manuals Download Website

<http://myh66.com>

<http://usermanuals.us>

<http://www.somanuals.com>

<http://www.4manuals.cc>

<http://www.manual-lib.com>

<http://www.404manual.com>

<http://www.luxmanual.com>

<http://aubethermostatmanual.com>

Golf course search by state

<http://golfingnear.com>

Email search by domain

<http://emailbydomain.com>

Auto manuals search

<http://auto.somanuals.com>

TV manuals search

<http://tv.somanuals.com>