

# Goodmans

MICRO1468I CD Micro System for iPhone/iPod

Instruction Manual



**IMPORTANT!** Please read all instructions carefully before use and keep for future reference.

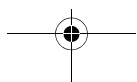



## Introduction

Thank you for choosing this Goodmans Micro System.  
Not only does it play CD's and receive radio stations, but you can also listen to your favourite tracks on your iPhone/iPod whilst charging it.

It's really easy to use; you can save your favourite radio stations to memory and program your CD tracks in an order to suit you. You can also fully operate your iPhone/iPod from the remote control.

**IMPORTANT!** Use of any electrical equipment should be undertaken with care. Please read the safety section on page 17 before using your Micro System. This appliance is for household use only.

Made for  
 iPod  iPhone

An audio system that allows docking of an iPhone / iPod and which fully supports the iPhone / iPod menu system.

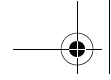

## What's in the box



- 1 x Goodmans MICRO1468I unit
  - 2 x External speakers
  - 1 x Remote control (not shown)
  - 6 x iPod dock adaptors (not shown)
  - 1 x Mains adaptor - 10V DC (not shown)
- (CD and iPod not included)

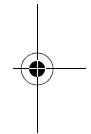
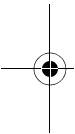

## Contents

- |                              |                             |
|------------------------------|-----------------------------|
| 1 Getting started            | 5 Using the clock and timer |
| 2 Using the radio            | 6 Other functions           |
| 3 Using the iPhone/iPod dock | 7 Troubleshooting           |
| 4 Using the CD               | 8 Specifications            |

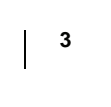
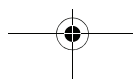
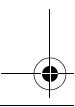



## Your Micro System

Front view

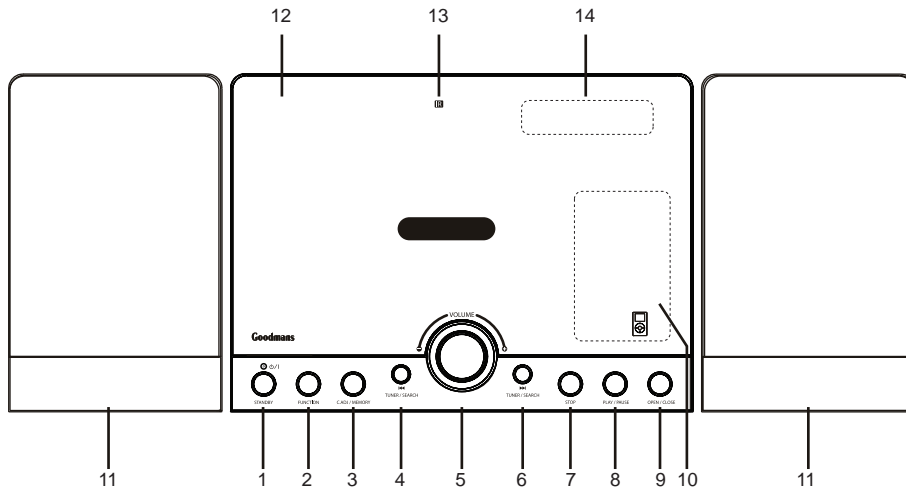

1	STANDBY button	8	PLAY / PAUSE button
2	FUNCTION button	9	OPEN / CLOSE button
3	C.ADJ / MEMORY button	10	iPhone/iPod compartment
4	TUNER / SEARCH - Button	11	Speaker unit
5	Volume Control	12	CD door
6	TUNER / SEARCH + Button	13	IR sensor
7	STOP Button	14	LCD display

## Your Micro System

### Top Panel

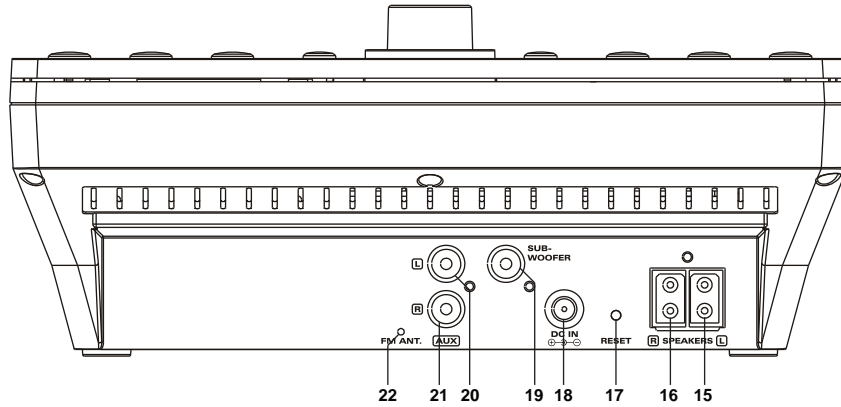

15	Speaker output left	19	Subwoofer output
16	Speaker output right	20	AUX input left
17	Reset button	21	AUX input right
18	DC input 10V	22	FM antenna

## Your Micro System

### Remote Control

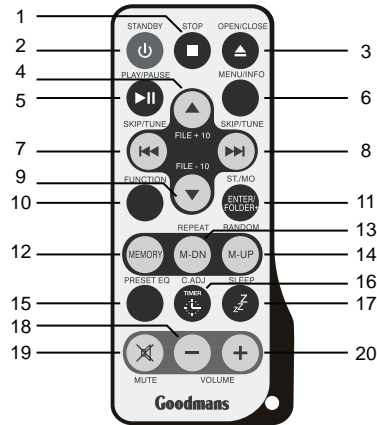

1	STOP button	11	ENTER / FOLDER + button
2	STANDBY button	12	MEMORY button
3	OPEN / CLOSE button	13	M-DOWN / REPEAT button
4	FILE +10 / IPOD UP button	14	M-UP / RANDOM button
5	PLAY / PAUSE button	15	PRESET EQ button
6	MENU / INFO button	16	TIMER / C.ADJ button
7	SKIP / TUNE - Button	17	SLEEP button
8	SKIP / TUNE + Button	18	VOLUME - button
9	FILE -10 / IPOD DOWN button	19	MUTE button
10	FUNCTION button	20	VOLUME + button

## Getting started

01

### Using the support stand

If the unit is to be operated on a desk or table, extend the support stand (located on the underside of the unit). If the unit is to be wall mounted, return the support stand to the closed position.

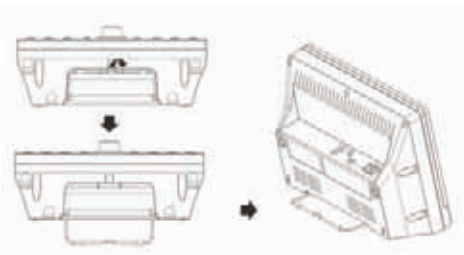

### The remote control battery

To preserve the battery life prior to first use, there is a small plastic tab inserted between the battery and the terminal inside the remote control. Please remove this tab before using the remote control. To remove the tab, pull it in the direction of the arrow in the illustration below.



If the operation of the remote control becomes intermittent or unsatisfactory, replace the original battery with a new 3-volt lithium battery.

**DON'T FORGET!** When replacing the battery, always ensure the same size and type is used. Make sure that the battery polarity is observed. Inserting the battery incorrectly could result in battery leakage or damage to the unit.

### Connecting to power

Before switching on make sure that the voltage of your electricity supply is the same as that indicated on the rating plate. For your own safety read the following instructions carefully before attempting to connect this unit to the mains.

### Mains (AC) operation

This unit is designed to operate on AC 100-240V 50/60Hz mains supply using the mains adaptor supplied.

Connect the mains adaptor to the DC input socket (18) on the rear of the unit

**DON'T FORGET!** Use only the mains adaptor supplied with this Micro System. Using adaptors not designed for this unit, or that have a different specification to the one supplied, may cause damage to the unit.

## 02

## Using the radio

## Basic operation

- 1 Press the STANDBY button on the main unit or remote control to power on the unit.
  - 2 Press the FUNCTION button on the unit or on the remote control to select Tuner mode.
  - 3 Tune to the station you want by pressing either of the SKIP / TUNE buttons.
  - 4 To turn off the unit, press the STANDBY button.
- 2 Press the MEMORY button on the remote control, "MEMORY" will flash in the display and a preset number "1" will also show on the display.
  - 3 Press the M-UP or M-DOWN buttons on the remote control to select the preset station number where you want to save the station.
  - 4 Press the MEMORY button again to store the station into the chosen preset number.

**DON'T FORGET!** Repeat the above steps to save all of your other stations.

## Manual and automatic tuning

- 1 To manually tune in a station, briefly press either of the SKIP / TUNE buttons.
- 2 To start automatic tuning, press and hold either of the SKIP / TUNE buttons for more than 2 seconds.

**DON'T FORGET!** The unit will automatically search for the first available station with a strong signal.

## Selecting a saved station

Press the M-UP or M-DOWN buttons on the remote control to choose the saved station that you want to listen to.

## Antenna

**DON'T FORGET!** For optimum FM reception there is a built-in FM antenna wire on the back of the unit. Move the wire around to get the best reception.

## Saving radio stations to memory

**DON'T FORGET!** You need to use the remote control to save radio stations to memory.

You can save up to 20 FM radio stations to the memory.

- 1 Tune in to the station you want by pressing either of the SKIP / TUNE buttons on the remote control.

## FM and FM Stereo reception

When the unit is tuned in to a stereo broadcast with a good signal, "STEREO" will be shown in the display.

If an FM station is received, but has interference, it is recommended to switch to Mono mode using the ST/MO button on the remote control.



## Using the iPhone/iPod Dock

03

### Inserting and removing your iPhone/iPod

- 1 Press the Power / Standby Button.
- 2 Press the FUNCTION Button to select iPhone/iPod mode.
- 3 Press the OPEN / CLOSE Button to open the CD door.
- 4 Carefully push the iPod dock lever to the right then forward. The dock connector will tilt upwards to enable the iPod/iPhone to be easily connected.
- 5 Insert your iPod/iPhone securely into the dock. You can also use the correct dock adaptor supplied with your iPod
- 6 Carefully push the lever to the right and then back to the original position.
- 7 Press the OPEN/CLOSE button to close the CD door.

**DON'T FORGET!** The CD door will NOT close if the lever is not returned to the original position.

### Using the iPhone/iPod menu system

- 1 Select iPod mode using the FUNCTION button.
- 2 Carefully insert your iPhone/iPod unit into the dock.
- 3 Press the MENU button once on the remote control to enter the iPod menu system.
- 4 Press “▲”, and “▼” on the remote control to navigate the various features of the iPod menu system as you would when using the iPod control buttons.
- 5 Press the ENTER button on the remote control to confirm your selection.

**DON'T FORGET!** Menu navigation will not work on iPhone or iPod Touch when they are in LOCK mode.

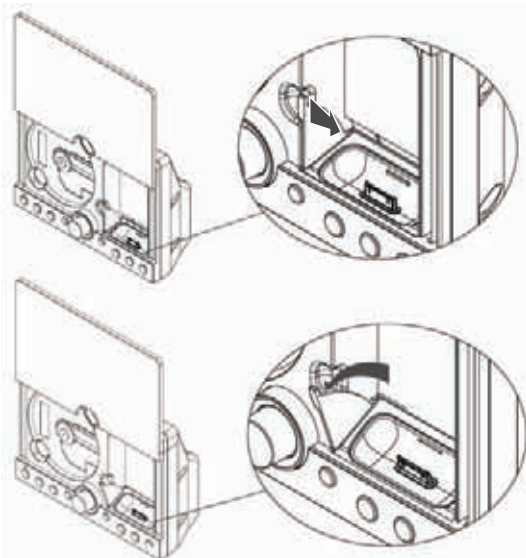

### Playback and charging your iPod

- 1 Select iPod mode using the FUNCTION button.
- 2 Insert your iPod into the dock and press the PLAY/PAUSE button to start playback.
- 3 Press the PLAY/PAUSE button to pause playback. Press this button again to resume playback.
- 4 When your iPod is docked in the unit, the internal battery will be charged.

## 04

## Using the CD

## Handling CDs

To remove a disc from its storage case, press down on the centre of the case and lift the disc out, holding it carefully by the edges.



Fingerprints and dust should be carefully wiped off the disc's recorded surface with a soft cloth before use.

**DON'T FORGET!** Never use chemicals such as record sprays, antistatic sprays, benzene, or thinners to clean compact discs. These chemicals can damage the disc's surface.

## Loading and unloading CD's

- 1 Press the STANDBY Button to turn on the unit.
- 2 Select CD mode.
- 3 Open the disc compartment by pressing the OPEN / CLOSE button.
- 4 When the disc compartment has opened, remove a disc from its case and place it carefully onto the spindle with the label side facing outwards.

**DON'T FORGET!** Do not put anything except a compact disc into the compartment. Other objects may damage the unit.

- 5 Press the OPEN / CLOSE button to close the disc compartment.
- 6 When the compartment is fully closed, the disc will be read automatically.

**DON'T FORGET!** Keep the disc compartment closed when not in use to prevent dirt and dust from entering the mechanism. Never place more than one disc into the disc compartment at any time.

## Playing CD's

- 1 Select CD mode with the Function button.
- 2 Press the PLAY / PAUSE button once to begin playback of the CD from the first track.
- 3 Press the PLAY / PAUSE button once to pause playback of the CD; the elapsed time will flash in the display.
- 4 To resume playback, press the PLAY / PAUSE button again.
- 5 To stop playback, press the STOP button.

## Selecting a different CD track

- 1 Press the SKIP / TUNE buttons to skip forwards or backwards through the tracks on the CD.
- 2 Press and hold the SKIP/TUNE buttons to fast forwards or backwards through the current track.
- 3 When the desired part of the track is reached, release the button and playback will resume.

## Using the CD

04

### Repeating CD's

**DON'T FORGET!** You need to use the remote control to use this function.

- 1 To repeat the current track, press the REPEAT button once. "REPEAT" will show in the display.
- 2 To repeat the entire disc, press the REPEAT button twice. "REPEAT ALL" will show in the display.
- 3 To cancel repeat play, press the STOP button or press the REPEAT button until the repeat indicator disappears.

- 4 To resume playback, press the PLAY / PAUSE button again.
- 5 To stop playback, press the STOP button.

### Selecting a different MP3 track

**DON'T FORGET!** You need to use the remote control to use this function.

- 1 Press the ▲/FILE +10 button to skip forward through the files in multiples of 10.
- 2 Press the ▼/FILE -10 button to skip backwards through the files in multiples of 10.
- 3 To skip forwards through folders contained on the CD, press the ENTER/FOLDER + button.
- 4 Press the SKIP / TUNE buttons to select tracks within a folder.

### Random CD playback

**DON'T FORGET!** You need to use the remote control to use this function.

- 1 In play mode press the RANDOM button on the remote control once, "RANDOM" will show in the display, and the tracks will be played in a random order.
- 2 To cancel random play, press the STOP button or press the RANDOM button until the random indicator disappears

### Repeating MP3 CD's

**DON'T FORGET!** You need to use the remote control to use this function.

### Playing MP3 CD's

- 1 Select CD mode with the FUNCTION button, the total number of files and track numbers of the disc will show in the display.
- 2 Press the PLAY / PAUSE button once to begin playback of the MP3 CD from the first track.
- 3 Press the PLAY / PAUSE button once to pause playback of the MP3 CD. The elapsed time will flash in the display.

- 1 To repeat the current file, press the REPEAT button once. "REPEAT" will show in the display.
- 2 To repeat the current album, press the REPEAT button twice. "REPEAT ALBUM" will show in the display.
- 3 To repeat the entire disc, press the REPEAT button three times. "REPEAT ALL" will show in the display.
- 4 To cancel repeat play, press the STOP button or press the REPEAT button until the repeat indicator disappears.

## 04

## Using the CD

## Random MP3 playback

**DON'T FORGET!** You need to use the remote control to use this function.

- 1 In play mode press the RANDOM button on the remote control once, "RANDOM" will show in the display, and the tracks will be played in a random order.
- 2 To cancel random play, press the STOP button or press the RANDOM button until the random indicator disappears

## ID3 Tag function for MP3 CD's

- 1 To view ID3 Tag information on an MP3 disc, press the MENU/INFO button during playback.
- 2 Press the MENU/INFO button again to disable this function and return to normal track information display.

## Programmed CD playback

**DON'T FORGET!** The CD disc must be in stop mode.

- 1 Press the C-ADJ/ MEMORY or MEMORY button. The following information will show in the display:

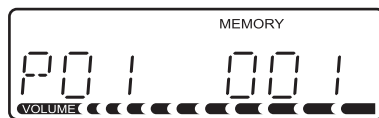

- 2 Press the SKIP / TUNE buttons to select the track to be stored in location "01" (i.e. track 03).

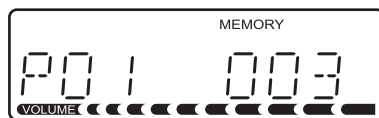

- 3 Press the C-ADJ/ MEMORY or MEMORY button. The first track selection is now stored in program memory.

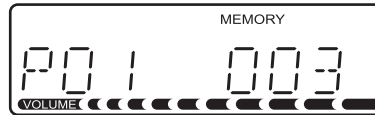

- 4 Select the next track to be programmed using the SKIP / TUNE buttons (i.e. track 05).

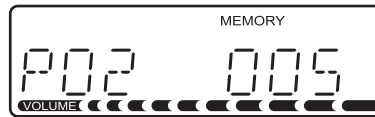

- 5 Press the C-ADJ/ MEMORY or MEMORY button to store this track.
- 6 Continue entering tracks in this way until all the desired tracks are stored (up to a limit of 20).  
When the C-ADJ/ MEMORY or MEMORY button is pressed to store the 20th track, the display will show "FUL".

**DON'T FORGET!** If the PLAY/PAUSE button is pressed before the C-ADJ/ MEMORY button is pressed, that track will not be programmed, and the disc will start playing from the first programmed track. Any track can be programmed to play more than once.

## Listening to programmed tracks

- 1 Press the PLAY/PAUSE button.
- 2 Disc play will start at the beginning of the first programmed track.

## To Clear the Program Memory

If the disc is playing, press the STOP button twice, or Select IPOD, AUX or TUNER to clear the program.

## Using the CD

04

### Programmed MP3 playback

**DON'T FORGET!** The MP3 disc must be in stop mode.

- 1 Press the C-ADJ/MEMORY or MEMORY button. The following information will show in the display.

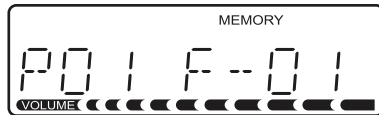

- 2 Press the SKIP/TUNE buttons to select the folder. Press the C-ADJ/MEMORY or MEMORY button to confirm the folder.
- 3 To select the track, press the SKIP/TUNE buttons.
- 4 Press the C-ADJ/MEMORY or MEMORY button to confirm the track.
- 5 Repeat the steps 2 to 4 to select the next folder and track to be programmed.
- 6 Continue entering the tracks in this way until all the desired track are stored (up to a limit of 99).

When the C-ADJ/MEMORY or MEMORY button is pressed to store the 99th track, it will show "FUL" on the display.

**DON'T FORGET!** If the PLAY/PAUSE button is pressed before the C-ADJ/MEMORY button is pressed, that track will not be programmed, and the disc will start playing from the first programmed track. Any track can be programmed to play more than once.

### Listening to programmed MP3 tracks

- 1 Press the PLAY/PAUSE button.
- 2 Disc play will start at the beginning of the first programmed track.

### To Clear the Program Memory

If the disc is playing, press the STOP button twice, or Select IPOD, AUX or TUNER to clear the program.

## 05

## Using the Clock and Timer

## Adjusting the clock

**DON'T FORGET!** This unit has its own digital clock when in standby mode.

To adjust the clock and set the timer, follow the instructions below:

- 1 Press the C-ADJ/ MEMORY button and select either "24 hour" or "12 hour" mode using the SKIP / TUNE buttons.
- 2 Press the C-ADJ/ MEMORY button to confirm.
- 3 The Hour digits will begin to flash. Adjust the hours by pressing the SKIP / TUNE buttons.
- 4 Press the C-ADJ/ MEMORY button again, and the minute digits will begin to flash.
- 5 Adjust the minutes by pressing the SKIP / TUNE buttons.

## Setting the timer

- 1 Press the C-ADJ/ MEMORY button again, "TIMER ON" will show in display.
- 2 Repeat the above procedure to set the "TIMER ON" hours and minutes digits.
- 3 Press the C-ADJ/ MEMORY button again, "TIMER OFF" will show in the display.
- 4 Repeat the above procedure to set the "TIMER OFF" hours and minutes digits.
- 5 Press the C-ADJ/ MEMORY button again, "TIMER OFF" will flash in the display.
- 6 Press the SKIP / TUNE buttons to select "TIMER ON"
- 7 Press the C-ADJ/ MEMORY button to confirm the Timer settings. The display will then return to the current time.

**DON'T FORGET!** The clock setting will be lost if the power is disconnected.

14

## Switching off the timer function

- 1 Press the C-ADJ/ MEMORY button until "TIMER ON" flashes in the display.
- 2 Select "TIMER OFF" by pressing SKIP / TUNE buttons.
- 3 Press the C-ADJ/ MEMORY button to cancel the timer.

## Setting the sleep timer

**DON'T FORGET!** You need to use the remote control to use this function.

The Sleep Timer is a countdown timer for switching the system to standby mode after a specified time. It enables you to listen to the radio, a CD or iPod. The Sleep Timer can be set from 90 to 10 minutes in 10 minute steps.

- 1 Switch on the system by pressing the STANDBY button.
- 2 Select the desired source by pressing the FUNCTION button.
- 3 Press the SLEEP button to set the sleep time. - "SLEEP" and "90" are shown in the display. The system will now play for 90 minutes.
- 4 To decrease the sleep time in steps of 10 minutes, continually press the SLEEP button until the desired sleep time is shown.
- 5 To cancel the sleep timer, press the SLEEP button until the display returns to the previous mode.
- 6 To switch off the system before the sleep time has elapsed, press the STANDBY button.

## Other Functions

06

### Mute

**DON'T FORGET!** You need to use the remote control to use this function.

- 1 Press the MUTE button on the remote control to turn off the sound. The volume indicator will flash.
- 2 Press the MUTE button again to restore the sound to the previous level.

### Preset Equaliser

The Quality of the sound can be adjusted to suit the type of music playing by using the Preset Equaliser function.

There are 6 settings to choose from: CLASSIC, ROCK, POP, JAZZ, X BASS and FLAT.

Press the Preset EQ button to cycle through the various equaliser settings until the desired sound setting is found.

### AUXILIARY IN

Connect the audio output sockets of your auxiliary sound source (TV, VCR, DVD Player, Cassette Deck, Mini Disc player, etc.) to the AUX IN sockets on the back of the unit.

**DON'T FORGET!** The auxiliary function can only be used when there is a connection made to the AUX IN sockets from another source.

**DON'T FORGET!** The connection cables are not included.

- 1 Press the STANDBY button to power On the unit.
- 2 Press the FUNCTION button to select the AUX function.

- 3 Turn your auxiliary source 'On' and operate it as usual. The sound from the auxiliary source can then be heard through the speakers.

- 4 Adjust the volume level to the desired listening level.

### Subwoofer out

**DON'T FORGET!** The subwoofer and connecting cables are not supplied with this product.

It is possible to use a powered "active" subwoofer speaker with this unit. Connect an external subwoofer into the SUBWOOFER OUT socket on the rear panel of this unit.

### Resetting

If this unit shows any abnormal operation, or becomes unresponsive to button presses, it can be reset.

Press the Reset button on the rear panel of the unit with a thin non-metallic object.

**DON'T FORGET!** Any preset settings such as the clock will be lost if the unit is reset or if the power supply is disconnected.

## 07

## Troubleshooting

Problem	Possible cause	What to do
<b>Radio</b>		
Noise or sound distorted on FM	Station not tuned properly the antenna wire is not extended	Fine tune broadcast station Extend FM wire antenna Reposition the unit until the best reception is obtained.
FM Stereo indicator doesn't light up	Mono mode is selected You have tuned in to a mono station The signal is too weak	Press ST/MO button Retune to another FM station Retune to another FM station
No sound in FM mode	Unit not in tuner mode Volume is at the minimum position	Press TUNER button to select Tuner mode. Adjust volume level
<b>CD/MP3 Player</b>		
CD Player will not play	Unit not in CD mode CD is not installed or installed correctly	Press CD button Load a CD and check it is the correct way round.
CD skips while playing	Disc is dirty or scratched	Wipe the disc with a cloth or use another disc

**Need extra help?**

Don't worry we are just the other end of the phone. If you're experiencing problems using your new product, before returning it to the retailer just call 0871 230 1777 or visit [www.thesupportsite.co.uk](http://www.thesupportsite.co.uk)

**Need a spare part?**

In the unlikely event of requiring spare parts, please contact our spare parts department on: 0871 230 0790





## Specifications

08

Model number	MICRO1468I
Power supply	AC: 100 - 240V ~ 50/60Hz 1.1A DC adaptor output: 10V 2.7A
Power consumption	27W
Radio frequency coverage	FM: 87.5 - 108MHz
Speaker system	4 Ohm
Power output Watts	4W x 2
Dimensions	Unit: 260(L) x 110 (W) x 190 (H) Speaker: 120 (L) x 92 (W) x 190 (H)

IMPORTANT! Due to continual revision and improvements to our products design, specifications are subject to change without notice.





## Safety

### Sound Levels

Your hearing is important to you and to us so please take care when operating this equipment. It is strongly recommended that you follow the guidelines in order to prevent possible damage to, or loss of hearing. Over time your hearing will adapt to continuous loud sounds and will give the impression that the volume has in fact been reduced. What seems normal to you may in fact be harmful. To guard against this, set the initial volume of the equipment to a low level.

Follow the steps below to ensure that the product can be enjoyed at a comfortable listening level:

- 1 Slowly increase the level until you can hear comfortably and clearly and without distortion.
- 2 Damage to your hearing is accumulative and irreversible. Any "ringing" or discomfort in the ears indicates that the volume is too loud.
- 3 Once you have established a comfortable listening level, do not increase the volume level.

### General Safety

This equipment has been designed and manufactured to meet European safety standards, but like any electrical equipment, care must be taken if you are to obtain the best results and safety is to be assured.

Do read these operating instructions before you attempt to use the equipment.

Do ensure that all electrical connections (including the mains plug, extension leads and interconnections between pieces of equipment)

are properly made in accordance with the manufacturer's instructions.

Switch off and remove the mains plug when making or changing any connections.

Do consult your dealer if you are ever in doubt about the installation, operation or safety of your equipment.

Don't continue to operate the equipment if you are ever in doubt about it working normally, or if it is damaged in any way. Switch it off withdraw the mains plug and consult your dealer.

Don't remove any fixed covers as this may expose you to dangerous voltages.

Don't leave the equipment switched On when it is unattended, unless it is specifically stated that it is designed for unattended operation or has a standby mode.

Switch off using the switch on the equipment and make sure that other people in your household are conversant with the equipment.

Special arrangements may need to be made for infirm or handicapped people.

Don't obstruct the ventilation vents on the equipment, for example with curtains or soft furnishings.

Overheating will cause damage and shorten the life of the product.

Don't allow electrical equipment to be exposed to rain or moisture.

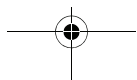
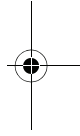
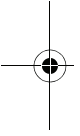
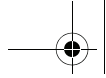

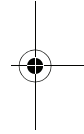
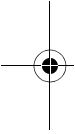
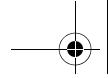

**Goodmans**

[www.thesupportsite.co.uk](http://www.thesupportsite.co.uk)

0871 230 1777

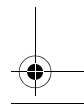
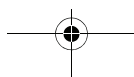
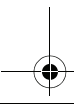

## Free Manuals Download Website

<http://myh66.com>

<http://usermanuals.us>

<http://www.somanuals.com>

<http://www.4manuals.cc>

<http://www.manual-lib.com>

<http://www.404manual.com>

<http://www.luxmanual.com>

<http://aubethermostatmanual.com>

Golf course search by state

<http://golfingnear.com>

Email search by domain

<http://emailbydomain.com>

Auto manuals search

<http://auto.somanuals.com>

TV manuals search

<http://tv.somanuals.com>